

Laser Marking & Laser Processing Systems

IN Your Future





With a focus on: Added value for the customer

Our philosophy extends to all areas and industries. Whether for the home, office, department store, car, plane, or production facility: Panasonic Industry powers the things that move people. We develop and design solutions of an impressive variety, keeping the customer's requirements as a whole always in view.

Panasonic Industry's decades of experience in the area of consumer products and industrial automation lay the perfect foundation for the success of our laser systems. We closely monitor our customers' needs and what type of added value is in demand in which specialty area. Our blend of outstanding technology, outstanding quality and outstanding service yields a complete solution that leaves nothing to be desired.



Outstanding technology

Everything we do is based on the deployment of the latest laser technologies. The application laboratories at the Panasonic Industry European head office and the worldwide dialog that our highly qualified engineers engage in enable continuous product improvements. Strong arguments speak for our laser systems and their outstanding technology. Their enormous precision and high level of reliability have gained worldwide renown.

Outstanding service

Panasonic Industry's service network has a broad reach. We respond quickly and are known for our flexibility. Our outstanding service begins long before a laser system is installed. Customer advice, feasibility studies and project management are the pillars on which our success concept is based. The Panasonic Industry service team comes to the aid of all customers with reliable service experts – at any time, regardless of the service life of your system.

Outstanding quality

The satisfaction of our customers and the trust they have in Panasonic Industry are paramount to us. At our company, every single employee is involved and sensitized, resulting in high-quality products and impressive services. In all areas, our team takes the most varied customer requests into account, and learns from them continuously. Technological know-how and a keen sense for what is important form the basis for our innovative, high-quality products.

Fiber Laser Marking Systems (FAYb):

LP-ZV series.....04
 LP-RV series.....08
 LP-RF series.....12

CO₂ Laser Marking Systems:

LP-RH series16

Laser Welding Systems:

VL-W1 series.....20
 Standard functions of laser systems24
 Global network28
 Accessory30
 Global Sustainability.....31

Product history

1996	1999	2001	2003	2004
LP-100 CO ₂ Laser Marker 	LP-200 CO ₂ Laser Marker  LP-F FAYb Laser Marker 	LP-D Diode Laser Marker 	LP-300 CO ₂ Laser Marker 	LP-400 CO ₂ Laser Marker  LP-V FAYb Laser Marker 
2007	2008	2011	2013	2014
LP-G FAYb Laser Marker 	LP-Z FAYb Laser Marker 	LP-S FAYb Laser Marker 	LP-M FAYb Laser Marker 	LP-GS CO ₂ Laser Marker 
2015	2020	2020	2023	2023
VL-W1 FAYb Laser Welding System 	LP-RF FAYb Laser Marker 	LP-RV FAYb Laser Marker 	LP-ZV FAYb Laser Marker 	LP-RH CO ₂ Laser Marker 

Panasonic Industry's long-lasting, energy-efficient fiber laser markers have further evolved to a laser system with 1ns short pulses and 3D control. Thanks to the high output power (50W), the new fiber laser markers offer excellent metal marking quality

combined with high contrast marking and extra small character marking on resin. With a built-in camera, our 3D fiber laser markers contribute to higher productivity.

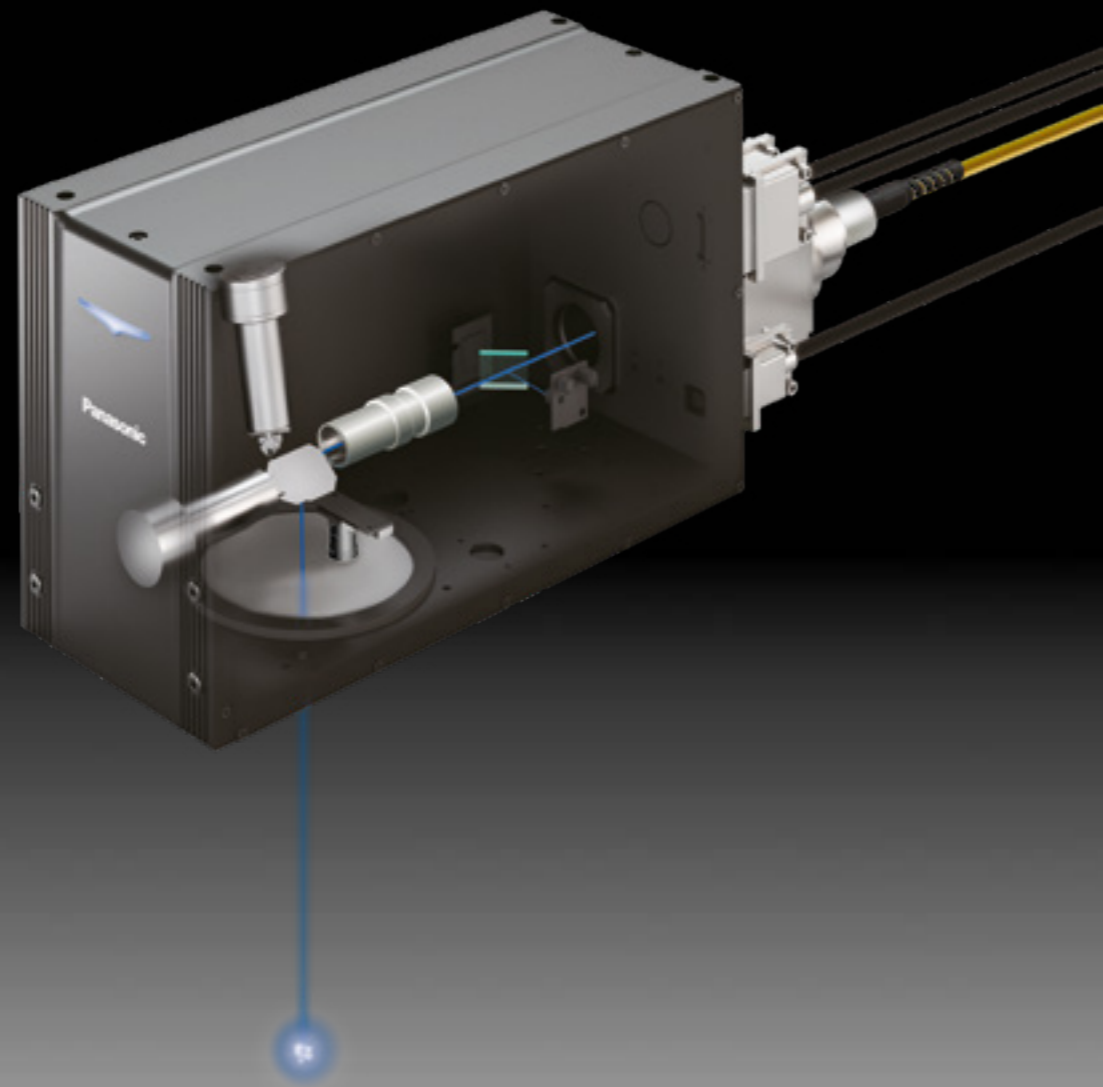

FDA
Conforming to
FDA regulations

CE
Conforming to
Low Voltage
and EMC Directive



LP-ZV

3D short-pulse fiber laser marker boasting high marking definition on metal and plastic. Simple marking setting with a built-in camera for sharp and clear color image for accurate positioning.

Automotive secondary battery

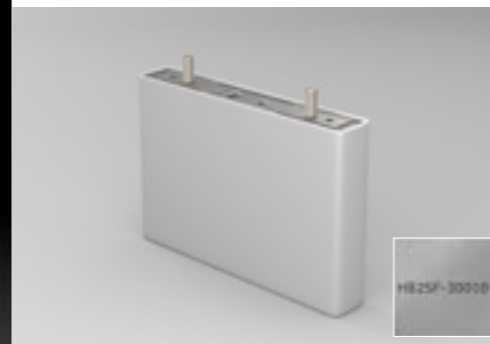

Automotive sensor



E-Axle



Coating removal

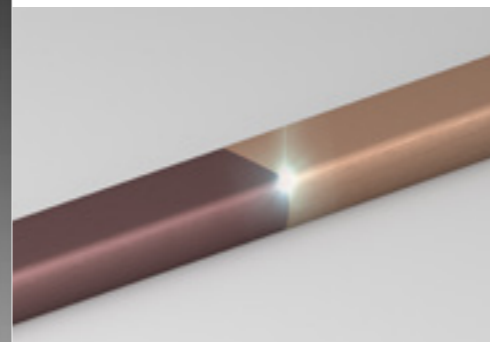

Surface processing

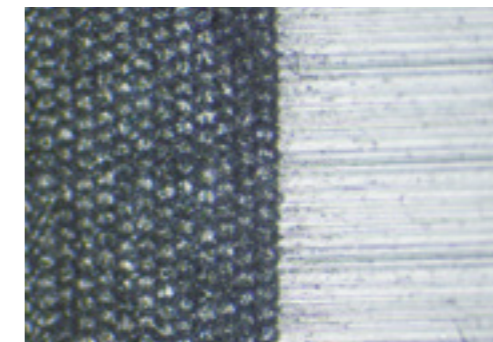

Molded resin parts



Metal plate (oblique)



Casting



Fuel nozzle





Built-in camera for easy positioning

Productivity improvement

Positioning can be performed by viewing the marking data and the workpiece image captured by the built-in camera on the same display. Compared to the conventional red guide, the color image makes it easier to check the positioning. In addition, the internal light in the head enables positioning even in dark places such as inside a machine.

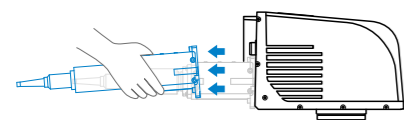
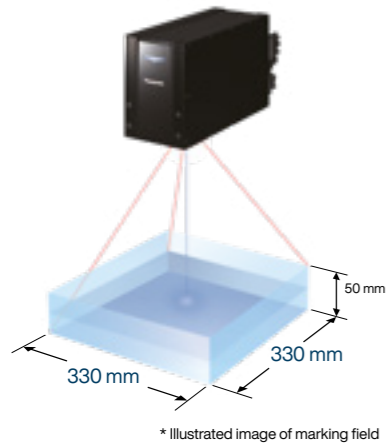

Wide marking field of 330mm × 330mm

Precise marking and improved productivity

Conventionally, markings on large workpieces or on workpieces made with multi-cavity molds required multiple marking operations. The wide marking field enables large size marking in a single marking operation. This not only improves productivity, but also reduces the number of required units or simplifies the facility construction to contribute to cost reduction.

The z-axis control allows for the marking of oblique, convex and concave surfaces in an area of 50mm (±25mm). Even workpieces with different heights can be marked easily with this new technology. Inside the marking field the spot size remains stable, ensuring consistent, high-quality marking. The wide range also eliminates the need for a setup change when workpieces with different heights are sent on the same line. This feature can dramatically reduce setup, installation and design costs.

Detachable optical fiber cable

Enhanced flexibility of equipment design and integration

The fiber unit attachment/detachment mechanism allows to disconnect the fiber unit from the laser head. Because the fiber unit is removable, designing and mounting the laser marker into existing equipment is more flexible and work-hours required for installation and maintenance are reduced.

High contrast marking

Clear marking with sharp edges

The 1ns short pulse minimizes thermal effect while the high-frequency oscillation achieves clear marking of extremely small and fine characters. Shallow engraving results in easy-to-see white markings and code sections with sharp and clear edges. This contributes to the excellent visibility of small characters and stable scanning of two-dimensional codes.

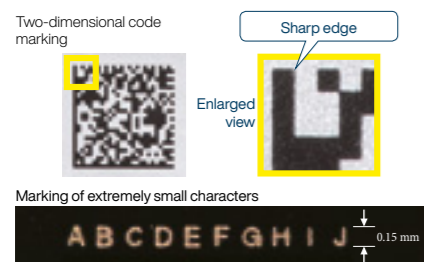

Item	Model	Standard		Large marking field			
		LP-ZV200P	LP-ZV500P	LP-ZV205P	LP-ZV505P	LP-ZV206P	LP-ZV506P
Marking laser		Fiber laser $\lambda = 1060\text{nm}$, laser class 4					
Guide laser		Semiconductor $\lambda = 655\text{nm}$, laser class 2, output class 1mW					
Output class		20W	50W	20W	50W	20W	50W
Marking field		125mmx125mm		220mmx220mm		330mmx330mm	
Work distance		190mm		220mm		330mm	
3D marking area (Z axis)		50mm (±25mm)					
System startup time		10s					
Laser excitation time		1s					
Scan method		Galvano scanner					
Scan speed (max.)		12000mm/s				8000mm/s	
Line speed (max.)		170m/min				120m/min	
Workpiece positioning		Stationary and on-the-fly marking					
Fiber cable length		2m	5m	2m	5m	2m	5m
Net weight	Laser head	11kg					
	Controller	12kg					
	Oscillator unit	12kg					
Degree of protection (laser head)		IP64					
Cooling method		Laser head: air cooling, controller: forced air cooling, oscillator: forced air cooling					
Ambient humidity		35% to 85% RH					
Operating voltage		90V AC to 132V AC or 180V AC to 264V AC (including power supply voltage fluctuation ±10%, 50/60Hz (auto switching))					
Power consumption (max.)	100V AC	320VA (3.6A)	510VA (5.7A)	320VA (3.6A)	510VA (5.7A)	320VA (3.6A)	510VA (5.7A)
	200V AC	360VA (2.0A)	520VA (2.9A)	360VA (2.0A)	520VA (2.9A)	360VA (2.0A)	520VA (2.9A)
Communication interfaces		Digital I/O, EIA-RS-232C, Ethernet, EtherNet/IP (optional part), PROFINET (optional part)					
Software		Laser Marker NAVI smart, Logo Data Editing, ExportVec, Font Maker					
Software languages		German, English, Japanese, Korean, simplified Chinese, traditional Chinese					
Character types		Upper and lower case letters, numerals, symbols, user-defined characters (up to 50), Japanese characters katakana, hiragana, kanji (JIS level 1 and level 2)					
Functional characters		Current date, counter, lot function, expiry date, laser parameter, registered characters					
TrueType		TrueType font from PC					
Bar codes		CODE39, CODE93, CODE128 (GS1-128), ITF, NW-7, EAN/UPC/JAN GS1 DataBar Limited, GS1 DataBar Stacked, GS1 DataBar Limited CC-A, GS1 DataBar Stacked CC-A					
2D codes		QR Code, Micro QR Code, Data Matrix, GS1 Data Matrix, PDF417					
Logos/graphics		VEC, DXF, BMP, HPGL, JPEG, AI*, EPS* (*Adobe Illustrator® required)					
Number of marking files (max.)		10000 files					

Dimensions

LP-ZV laser head

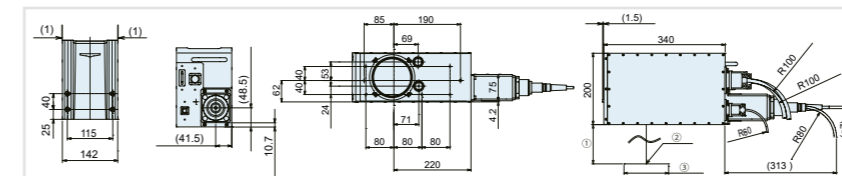

LP-ZV fiber unit

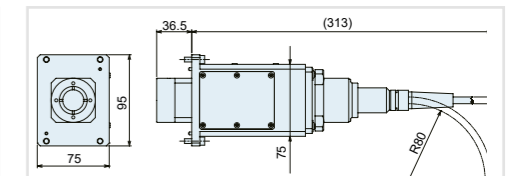

LP-ZV controller

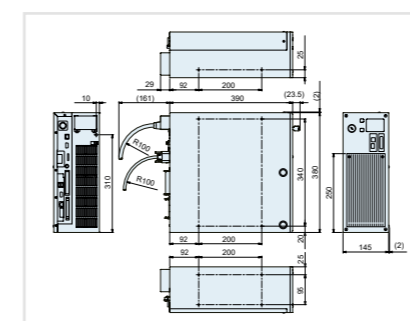

LP-ZV oscillator unit

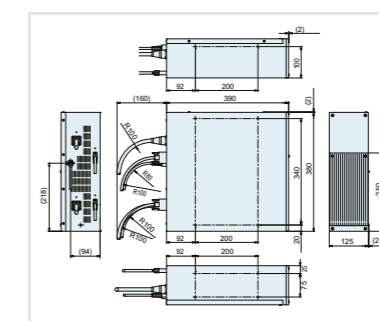

* All measurements in mm

The fiber laser oscillation system is recognized as an ecological system because its consumption power is low and the laser diode service life is long. However, there was a problem that made it difficult to generate a short pulse laser. Through adopting a new three-unit configuration, the LP-RV

series with fiber oscillation system has realized a short pulse with a pulse duration of 1ns. This will contribute to providing an overwhelming improvement on expressive power and application needs.



FDA
Conforming to
FDA regulations

CE
Conforming to
Low Voltage
and EMC Directive



LP-RV

20W short pulse fiber laser system for applications with extra small characters and high contrast.

Small electronic part



Nameplate



Molded resin part



Gold plating peeling

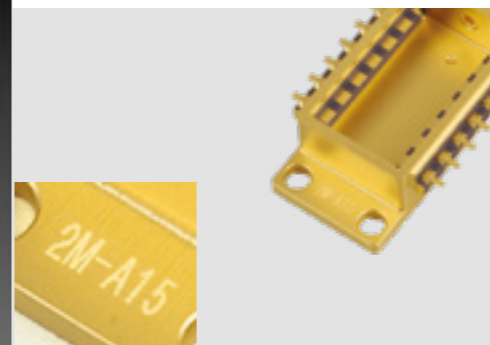

IC package

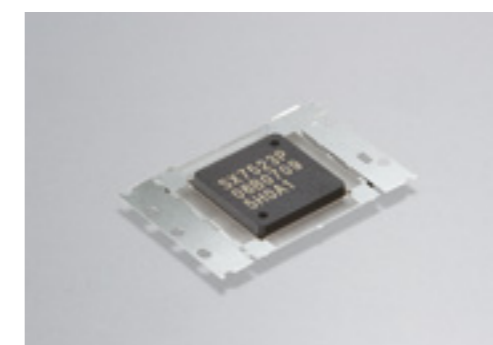

Illuminated switch



Metal part



Dowel



Pressure switch tool plastic



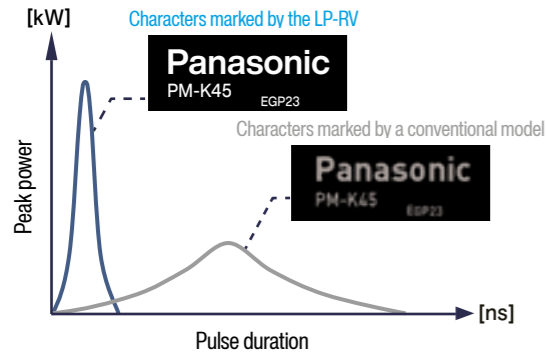

Small thermal effect

The thermal effect caused by the short pulse laser on the workpiece is small. The risk of burning, discoloration, or deformation due to heat is minimized. Therefore, the short pulse laser can be used as an optimal laser marker for workpieces where it is essential to suppress the thermal effect, such as ICs and thin metals or for high-contrast marking on resin surfaces.

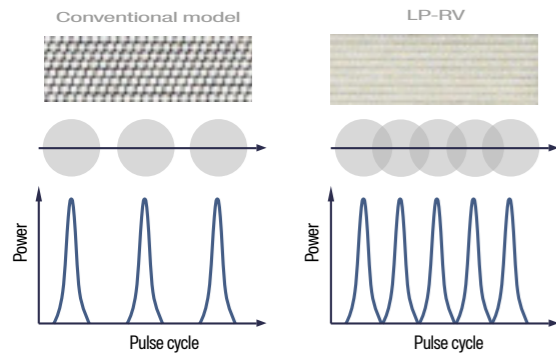

High pulse repetition rate

The LP-RV can generate a short pulse laser beam with a high repetition rate even if the scanning is performed at a higher speed. As a result, the laser marking is possible without spaces between the pulses generated by the laser system, as shown in the left figure. This also shortens the laser marking or processing cycle time and improves the quality.

Exact marking of extra small characters

A short pulse laser prevents the heat from spreading during the laser radiation on a workpiece. Thus, it allows the marking of characters with much finer line segments. It is possible to mark characters as small as 0.15mm x 0.15mm. The marked characters are clearly visible and easy to read.

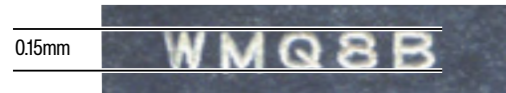

Three-unit configuration

The laser marker features a three-unit configuration. This allows to separately install, remove or replace each of the three individual units in the case of mounting or maintenance.

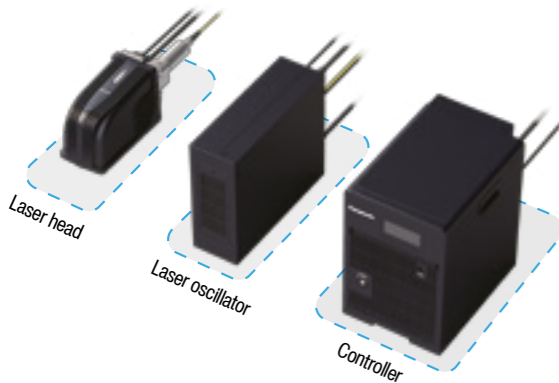

Item	Model	Standard LP-RV200P
Marking laser		Fiber laser $\lambda = 1060\text{nm}$, laser class 4
Guide laser		Semiconductor $\lambda = 655\text{nm}$, laser class 2, output class 1mW
Output class		20W
Pulse duration		1ns, 4ns, 8ns, 16ns, 30ns, 120ns, 200ns (user-defined settings)
Pulse cycle		0.5 μs to 500 μs
Marking field		90mm x 90mm
Work distance		190mm
System startup time		10s
Laser excitation time		1s
Scan method		Galvano scanner
Scan speed (max.)		12000mm/s
Line speed (max.)		240m/min
Workpiece positioning		Stationary and on-the-fly marking
Fiber cable length		2m
Power supply length		2m
Net weight	Laser head	8kg
	Oscillator unit	13kg
	Controller	28kg
Degree of protection (laser head)		IP64
Cooling method		Laser head: natural air cooling, controller: forced air cooling
Ambient temperature		0°C to +40°C, storage: -10°C to +60°C
Ambient humidity		35% to 85%
Operating voltage		180V AC to 264V AC ($\pm 10\%$), 50/60Hz
Power consumption (max.)		310VA (2.1A)
Communication interfaces		Digital I/O, Ethernet, EtherNet/IP (optional part), PROFINET (optional part), RS-232C
Software		Laser Marker NAVI smart, Logo Data Editing, ExportVec, Font Maker
Software languages		German, English, Japanese, Korean, simplified Chinese, traditional Chinese
Character types		Upper and lower case letters, numerals, symbols, user-defined characters (up to 50), Japanese characters katakana, hiragana, kanji (JIS level 1 and level 2)
Functional characters		Current date, counter, lot function, expiry date, laser parameter, registered characters
TrueType		TrueType font from PC
Bar codes		CODE39, CODE128, CODE93, ITF, NW-7, EAN/UPC/JAN, GS1 DataBar
2D codes		QR Code, Micro QR Code, iQR Code, Data Matrix, GS1 Data Matrix, PDF417
Logos/graphics		VEC, DXF, BMP, HPGL, JPEG, AI*, EPS* (*Adobe Illustrator® required)
Number of marking files (max.)		10000 files

Dimensions

LP-RV200P laser head

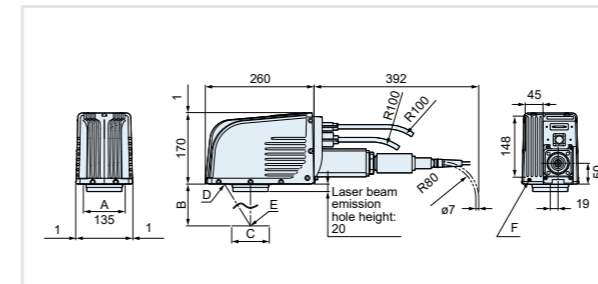

LP-RV200P fiber unit

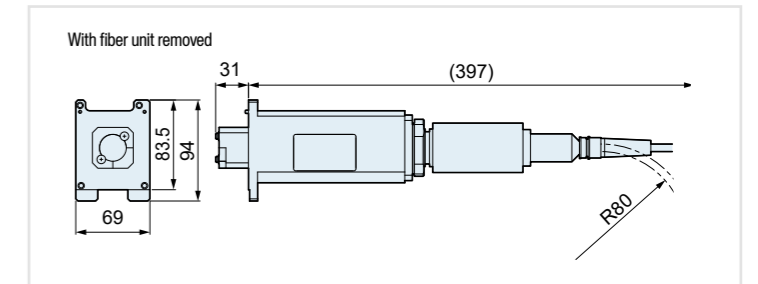

LP-RV200P controller

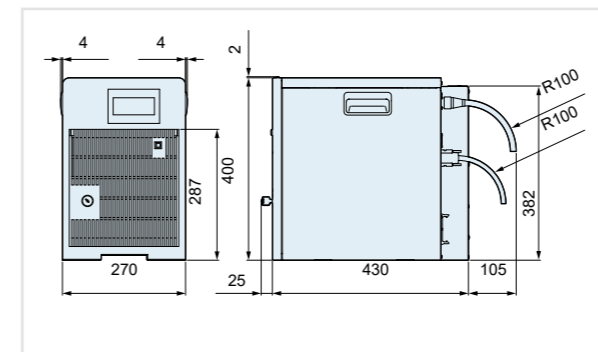

LP-RV200P oscillator

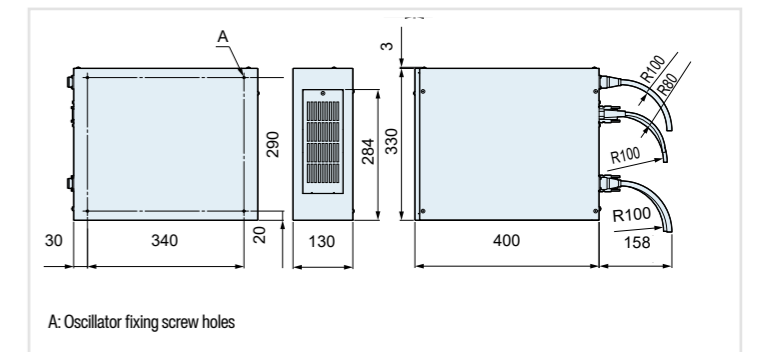

* All measurements in mm

In 1999, Panasonic Industry introduced the world's first laser marker equipped with a fiber laser oscillator. Since then, the company has advanced the product function to respond to customers' needs and released four unique premium fiber laser markers.

Panasonic Industry recently reexamined the essential key functions of a laser marker, and added an easy-to-handle model to the lineup – the new LP-RF series.



FDA
Conforming to
FDA regulations

CE
Conforming to
Low Voltage
and EMC Directive



LP-RF

The best choice for uncomplicated 2D plastic and metal applications is the easy-to-use 20W fiber laser system.

Molded resin part



Battery pack



Slider bar



Gear



Ball bearing



Cleaning process

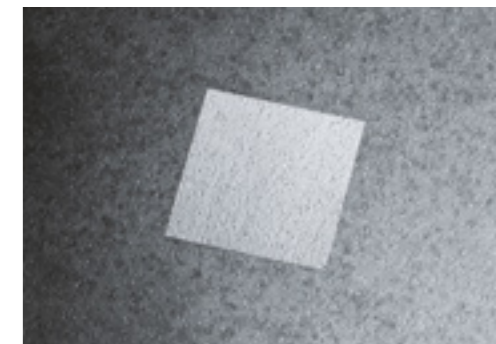

Tool



Camshaft



Fuel nozzle





Highlights for operation

New interfaces for remote control

In addition to the connector for I/O control and the RS-232C connector, new EtherNet/IP and PROFINET network units are provided to support the PLC connection via these industrial networks. The installation of the additional network units is easy and can be performed at any time.

PROFINET unit and EtherNet/IP unit

- > Support industrial networks
- > Optional accessory
- > Retrofittable
- > Easy installation

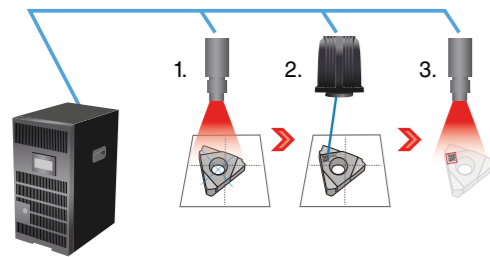

Direct connection to image processing device

Automatic marking position correction and scan check

The LP-RF series can be connected directly to a machine vision system. This enables the execution of a series of operations, such as detection of the workpiece position, correction of the marking position and cross-checking with scanned information of marked Data Matrix code (DMC), etc., without using a PLC.

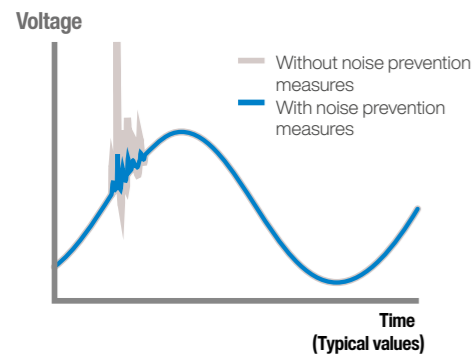
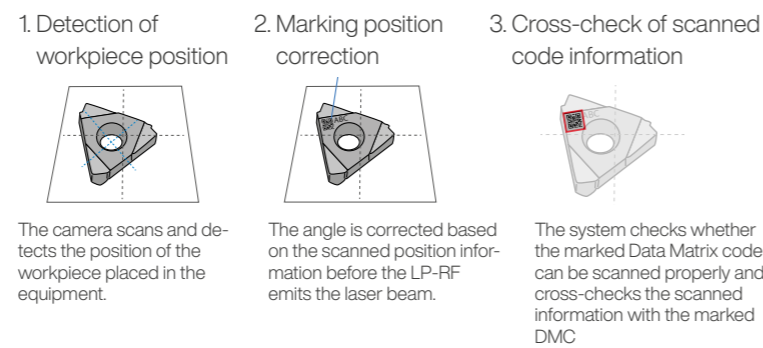

FT noise Reduced by 90%
Surge noise Reduced by 70%

Controller with high noise resistance

Electrical noise produced by equipment using a large amount of electrical current or generated in the surrounding area can affect the operation of the internal parts of the equipment and cause problems. The controller of the LP-RF series is equipped with anti-noise parts such as a power transformer and varistor to ensure safe and reliable use of the Laser Marker during the production process.

Item	Model	Standard
		LP-RF200P
Marking laser		Fiber laser $\lambda = 1060\text{nm}$, laser class 4
Guide laser		Semiconductor $\lambda = 655\text{nm}$, laser class 2, output class 1mW
Output class		20W
Marking field		90mm x 90mm
Work distance		190mm
System startup time		10s
Laser excitation time		7s
Scan method		Galvano scanner
Scan speed (max.)		12000mm/s
Line speed (max.)		240m/min
Workpiece positioning		Stationary and on-the-fly marking
Fiber cable length		3m
Net weight	Laser head	8kg
	Controller	37kg
Degree of protection (laser head)		IP64
Cooling method		Laser head: natural air cooling, controller: forced air cooling
Ambient temperature		0°C to +40°C, storage: -10°C to +60°C
Ambient humidity		35% to 85%
Operating voltage		180V AC to 264V AC ($\pm 10\%$), 50/60Hz
Power consumption (max.)		370VA (2.1A)
Communication interfaces		Digital I/O, Ethernet, EtherNet/IP (optional part), PROFINET (optional part), RS-232C
Software		Laser Marker NAVI smart, Logo Data Editing, ExportVec, Font Maker
Software languages		German, English, Japanese, Korean, simplified Chinese, traditional Chinese
Character types		Upper and lower case letters, numerals, symbols, user-defined characters (up to 50), Japanese characters katakana, hiragana, kanji (JIS level 1 and level 2)
Functional characters		Current date, counter, lot function, expiry date, laser parameter, registered characters
TrueType		TrueType font from PC
Bar codes		CODE39, CODE128, CODE93, ITF, NW-7, EAN/UPC/JAN, GS1 DataBar
2D codes		QR Code, Micro QR Code, iQR Code, Data Matrix, GS1 Data Matrix, PDF417
Logos/graphics		VEC, DXF, BMP, HPGL, JPEG, AI*, EPS* (*Adobe Illustrator® required)
Number of marking files (max.)		10000 files

Dimensions

LP-RF200P laser head

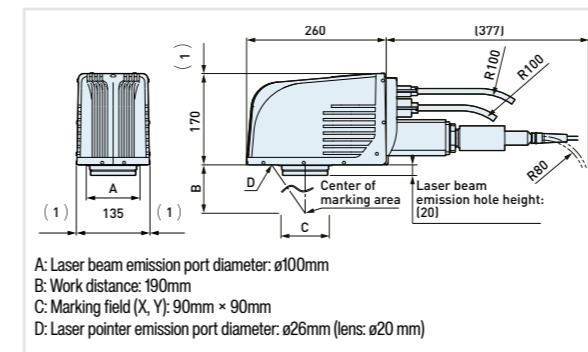

LP-RF200P controller

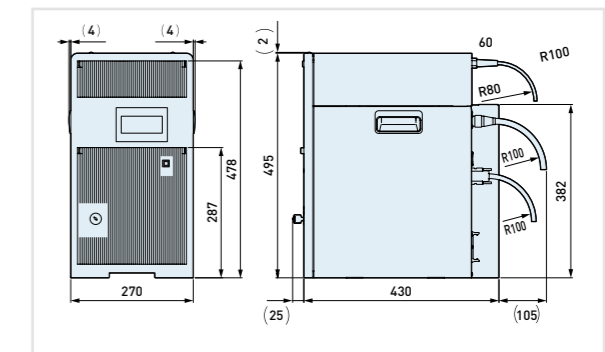

* All measurements in mm

Panasonic Industry has had CO₂ lasers in its portfolio since 1996 and is constantly working on optimizing the laser marking systems. In 2023, the popular LP-400 series was replaced by the new LP-RH series.

Thanks to their small laser beam diameter, certain models are especially well suited to apply very small markings on small components. Due to their shorter wavelength of 9.3μm, some models are ideal for marking clear plastics such as PET or PC.



FDA
Conforming to
FDA regulations

CE
Conforming to
Low Voltage
and EMC Directive



LP-RH

The next-generation CO₂ laser marking system offers a remarkable improvement in the marking and processing quality.

Marking

Molded resin parts

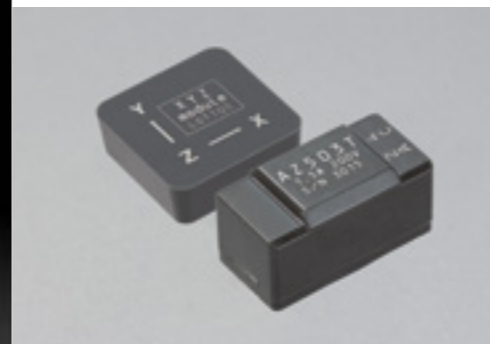

Electronic parts



Processing

Laser labels (marking + half-cutting)



Connectors

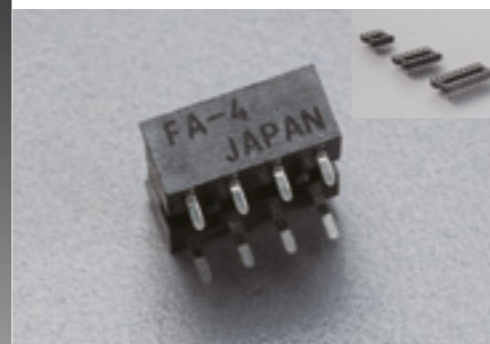

Ceramic substrates



Cable sheath stripping

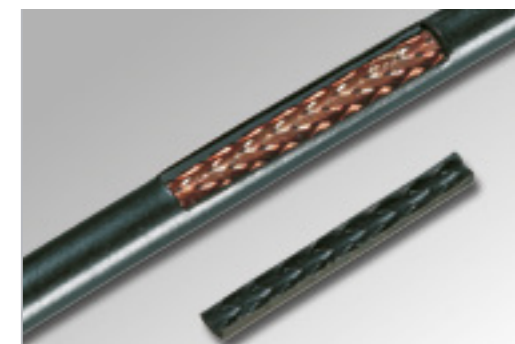

Circuit boards

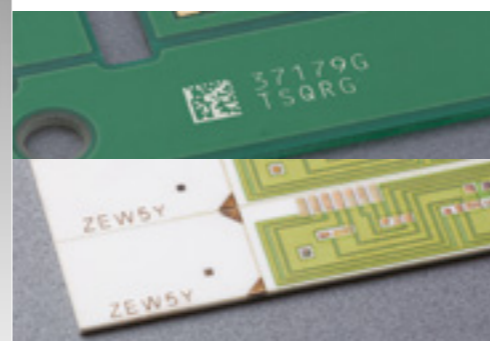

Aluminum packaging materials



Films

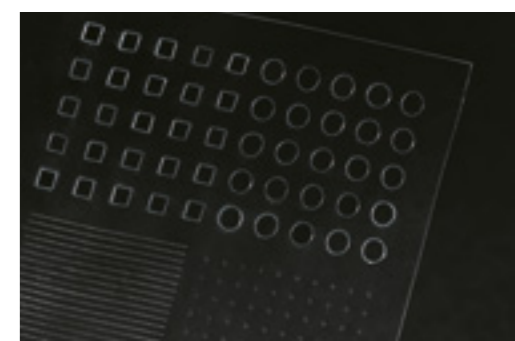



Improved productivity

High-speed marking

The LP-RH series features a high-performance galvano scanner whose acceleration, deceleration, and response speeds have been reduced significantly. The communication time to the galvanometer scanner has been reduced by a factor of four, while the positioning accuracy has been increased fourfold. Thus, the LP-RH series achieves dramatically shorter marking times. Panasonic Industry's proprietary galvano scanner keeps marking accurate and aligned, even at high speeds.

In addition, the time until the laser marking system is ready for operation has been shortened significantly – from 90 seconds to 15 seconds. This means a greatly reduced standstill time for your production line.

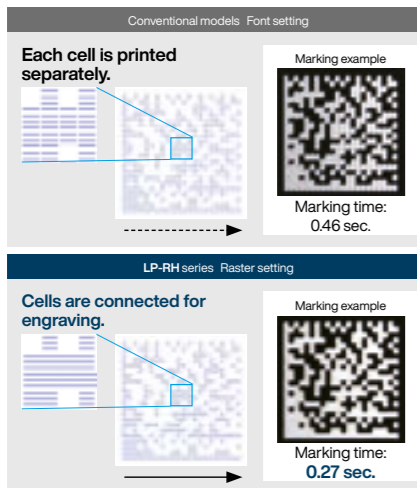

Unique marking quality

Technologies behind high-quality marking

The LP-RH series takes advantage of a number of new technologies compared to conventional models to produce high-definition marking. The LP-RH series automatically optimizes the laser power at the start points to achieve the optimum marking result. This ensures homogeneous marking on the material and prevents deep engravings at the start points.

For 2D codes, a raster setting has been implemented to generate markings faster and in an even better quality. This means that takt times are reduced by up to 40% without any loss in quality.

Simplified installation

Extensive lineup

The LP-RH series consists of numerous models with different output classes (10W, 20W, 30W), marking field sizes up to 160x160mm as well as standard and tower models. Thus, you can realize many different applications.

The proprietary rotating laser head found on standard models offers additional freedom both for the installation and the operation. This helps to meet a variety of needs.

The function for fine adjustment of the laser focus simplifies the calibration after the installation. For this adjustment you do not need to move the laser head or the controller. If there are components with different heights or the line width of the marking needs to be increased, the work distance can be adjusted within ±3mm without moving the laser head or the seating.



* Varies depending on models.

Item	Model	Small marking field		Standard			Large marking field
		Standard	LP-RH101S	LP-RH301S	LP-RH100S	LP-RH200S	LP-RH300S
	Tower	LP-RH101T	LP-RH301T	LP-RH100T	LP-RH200T	LP-RH300T	LP-RH305T
Marking laser	CO ₂ laser λ = 10.6μm (9.3μm LP-RH200x), laser class 4						
Guide laser	Semiconductor λ = 650nm, laser class 2, output class 1mW						
Output class		10W	30W	10W	20W	30W	30W
Marking field		55mm x 55mm		110mm x 110mm			160mm x 160mm
Work distance		111mm		185mm			262mm
Focus adjustment (manually)		±2mm		±3mm			±4mm
System startup time		10s					
Laser excitation time		5-10s					
Scan method		Galvano scanner					
Scan speed (max.)		6000mm/s		12000mm/s			12000mm/s
Line speed (max.)		120m/min		240m/min			240m/min
Workpiece positioning		Stationary and on-the-fly marking					
Net weight	Laser head	17kg	19kg	17kg		19kg	19kg
	Controller	12kg					
Cooling method		Laser head, controller: forced air cooling					
Ambient temperature		0°C to +40°C, storage: -10°C to +60°C					
Ambient humidity		35% to 85%					
Operating voltage		90V AC to 132V AC or 180V AC to 264V AC (including ±10% voltage fluctuations), 50/60Hz (auto switching)					
Power consumption (max.)	100V AC	370VA (4.1A)	760VA (8.5A)	370VA (4.1A)	760VA (8.5A)		760VA (8.5A)
	200V AC	430VA (2.4A)	720VA (4.0A)	430VA (2.4A)	720VA (4.0A)		720VA (4.0A)
Communication interfaces		EIA-RS-232C, Ethernet, EtherNet/IP (optional part), PROFINET (optional part)					
Software		Laser Marker NAVI smart, Logo Data Editing Software, ExportVEC, Font Maker					
Software languages		German, English, Japanese, Korean, simplified Chinese, traditional Chinese					
Character types		Upper and lower case letters, numerals, symbols, user-defined characters (up to 50), Japanese characters katakana, hiragana, kanji (JIS level 1 and level 2)					
Functional characters		Current date, counter, lot function, expiry date, laser parameter, registered characters					
Bar codes		CODE39, CODE128, ITF, NW-7, EAN/UPC, GS1 DataBar					
2D codes		QR Code, Micro QR Code, Data Matrix, GS1 Data Matrix					
Logos/graphics		VEC, DXF, BMP, HPGL, JPEG, AI*, EPS* (*Adobe Illustrator® required)					
Number of marking files (max.)		10000 files					

Dimensions

LP-RH laser head

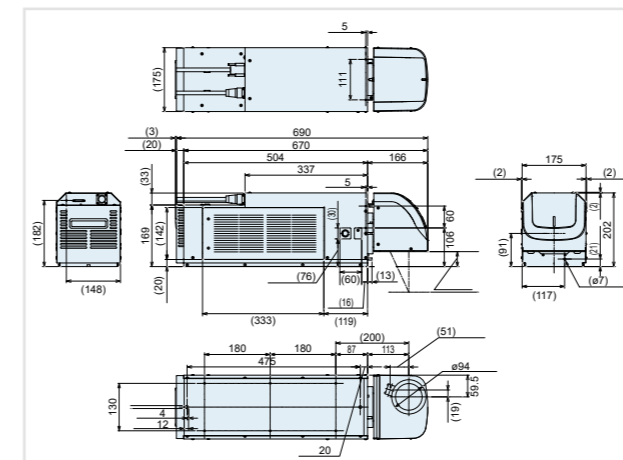

LP-RH controller

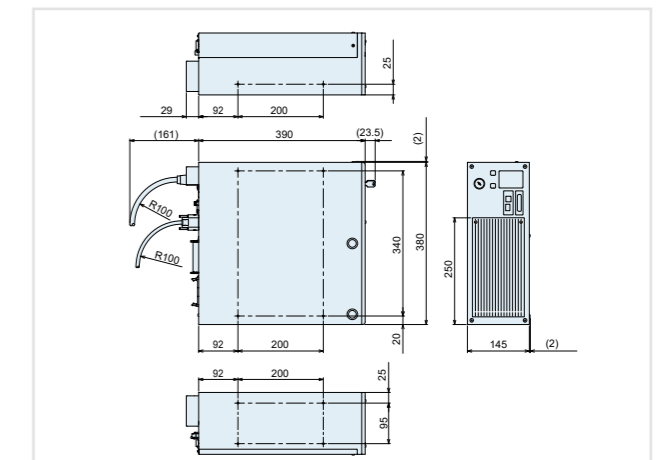

* All measurements in mm

Panasonic Industry offers a new plastic welding system with a galvano scanner which neither requires a robot or X-Y stage for moving the laser source, the optical part, and the laser emitting unit nor a control system to coordinate the three parts. The VL-W1 series incorporates all necessary components.

Our all-in-one system reduces the resources for installing and operating a complex system. The VL-W1 series proves that using a laser plastic welding system can be smart and effortlessly.

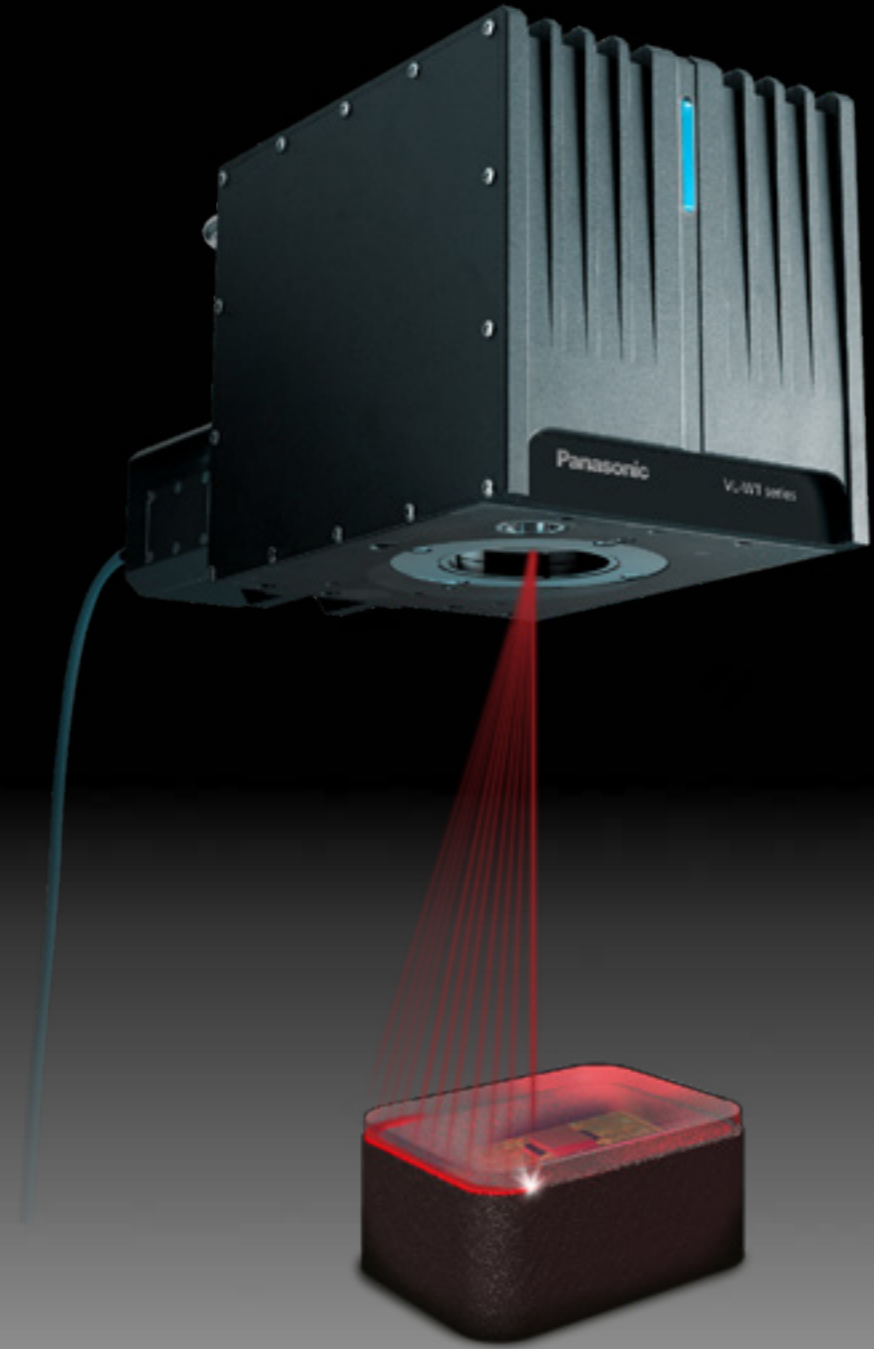

FDA
Conforming to
FDA regulations

CE
Conforming to
Low Voltage
and EMC Directive



VL-W1

The VL-W1 series is equipped with our original, high-performance fiber laser developed based on the technologies we have accumulated through the manufacture of laser marking systems. This fiber laser achieves high-quality welding results.

Ultra-slim light curtain



Car-mounted sensors



Hearing aid



Waterproofed display device



Digital fiber sensor



Respiratory mask



Electronic connector



Electronic control unit

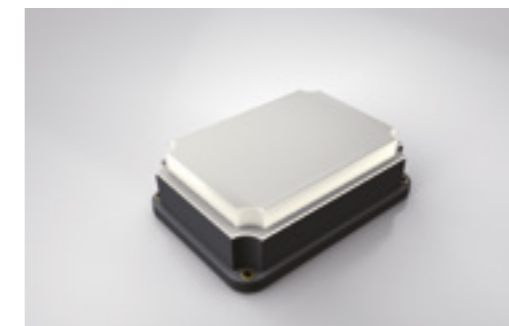

Blood sugar measurement device



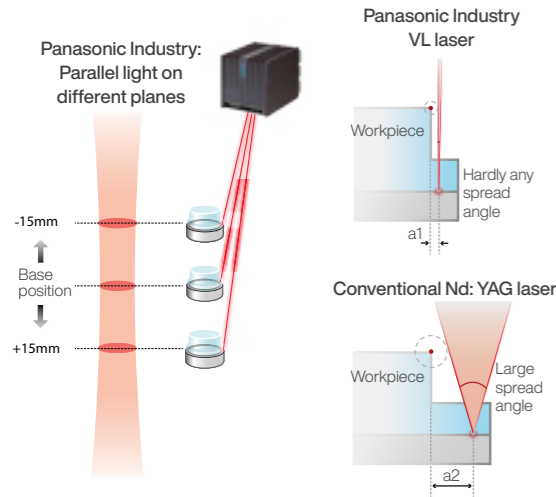

3D welding per parallel laser beam

The combination of the high-quality M2 < 1.1 beam and our proven optical design has realized a parallel light beam with minimal beam widening. This allows working on different planes and 3D surfaces. It also enables a precise laser beam emission even very close to the edge of parts.

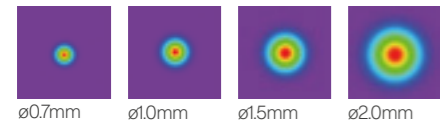

Variable beam diameter

The variable beam diameter mechanism enables the adjustment of the beam diameter between 0.7 and 2.0mm (depending on model type). Therefore, the desired welding width can be set without replacing the optical parts.

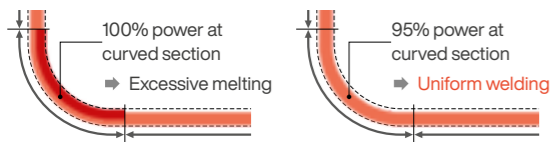
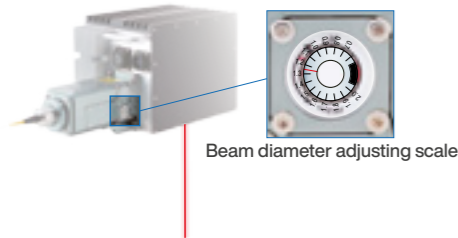

Power correction for curved sections

With normal laser output, the heat tends to accumulate more at curved sections than at straight sections. This may lead to uneven welding results. The VL-W1 series optimizes the laser output at curved sections to achieve a uniform welding result even for complex welding patterns.

Process description

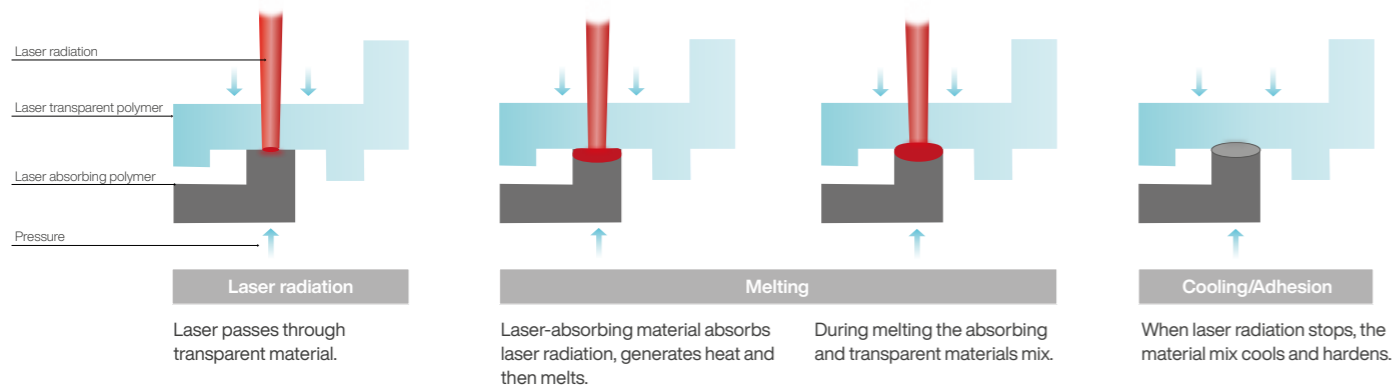

Item	Model	Standard		Large setting range	
		VL-W1500-N	VL-W1A00-N	VL-W1506-N	VL-W1A06-N
Laser output power		50W	100W	50W	100W
Output power at workpiece		45W ±5%	90W ±5%	45W ±5%	90W ±5%
Guide laser, pointer		Red semiconductor laser; λ = 655nm; class 2 laser: Maximum output 1mW or less			
Scanner		Digital galvano scanner			
Setting range (X, Y)		200 × 200mm		400 × 400mm	
Working distance (base position ± preset range)		315 ±15mm		685 ±15mm	
Scan speed		Maximum 3000mm/s			
Registration files		2048 files			
Importable graphic data (file format)		VEC, DXF, HPGL, BMP, JPEG			
Welding geometry		Straight line, circle, arc, quadrilateral, fixed point			
External memory device		USB media			
I/O ports		I/O terminal block, I/O connector, interlock connector, shutter closing output terminal			
Serial communication interface		EIA-RS-232C (for system control, for power data)			
Cooling method		Head: natural air cooling, controller: forced air cooling			
Power supply		90-132V AC or 180-264V AC, 50/60Hz			
Power consumption		max. 580VA (at 100V AC), max. 720VA (at 200V AC)	max. 740VA (at 100V AC), max. 830VA (at 200V AC)	max. 580VA (at 100V AC), max. 720VA (at 200V AC)	max. 740VA (at 100V AC), max. 830VA (at 200V AC)
Ambient temperature		0 to +40°C (head, controller)			
Storage temperature		-10 to +60°C (head, controller)			
Ambient humidity		35 to 85% RH (head, controller)			
Degree of protection		IP54 (IEC) (only for head section)			
Supplied cable		<ul style="list-style-type: none"> Head power supply cable: 5.5 ±0.1m, ø11mm Head control cable: 5.5 ±0.1m, ø12mm 			
Fiber cable		5 ±0.2m, ø7mm, minimum bend radius: 50mm			
Net weight					
	Head		≈ 12kg		
	Controller	≈ 28kg	≈ 35kg	≈ 28kg	≈ 35kg
Main unit display language		Japanese/English/Simplified Chinese characters			
Supplied software		Laser Processing Utility_VL-W1 (logo data conversion software, logo data editing software)			
Supported OS		Windows® 10 Pro (32 bit / 64 bit) / 8.1 Pro (32 bit / 64 bit) (Language selected for installation must be the same as the language of OS.)			

Dimensions VL-W1 laser head

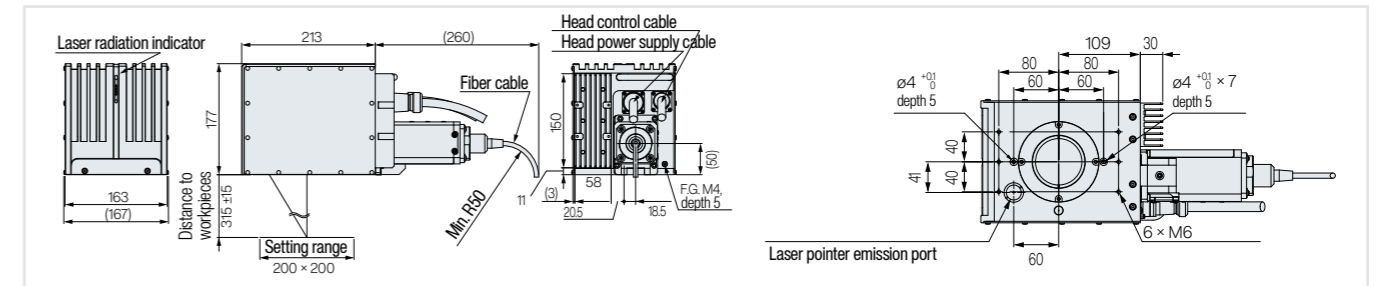

VL-W1500-N / VL-W1506-N controller

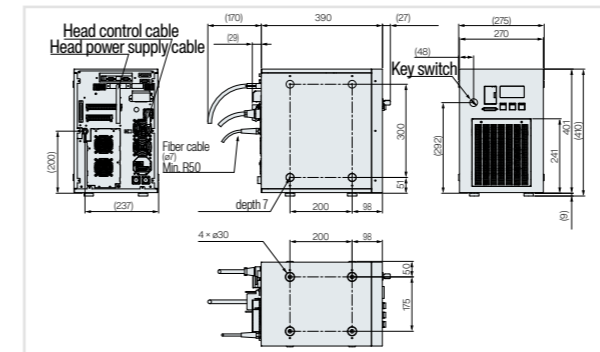

VL-W1A00-N / VL-W1A06-N controller

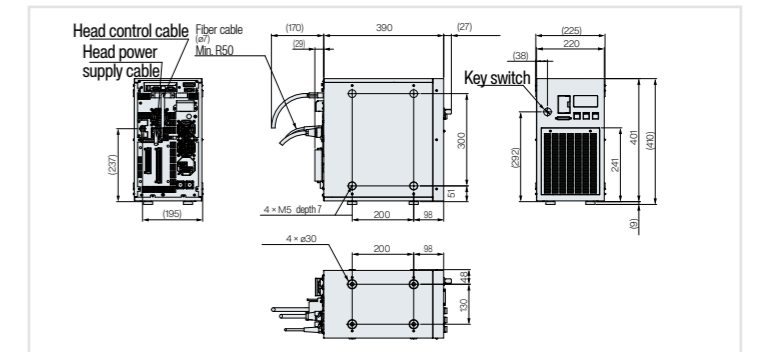

* All measurements in mm

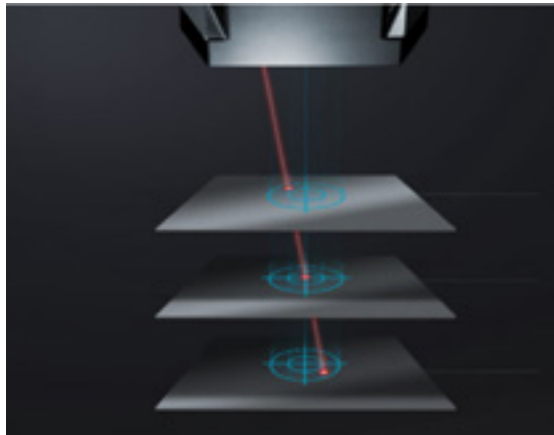

Focus guide laser

Panasonic Industry laser systems incorporate a guide laser to easily check and adjust the work distance.

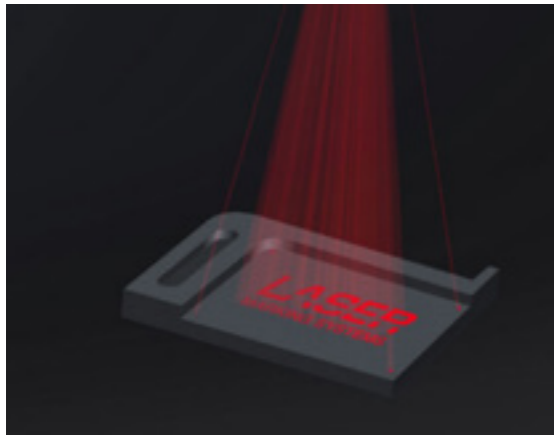

Simulation before triggering

The well visible, red guide laser indicates the marking and welding position in advance. This simulation offers the possibility to check and adjust the position prior to executing the actual process.



Installation directions

Because of their robust design, Panasonic Industry fiber and CO₂ laser systems can be installed at almost any orientation, enabling an easy integration in existing machines, even with limited access or space.



On-the-fly marking

Panasonic Industry laser marking systems are equipped with an encoder interface, allowing objects to be marked "on the fly" with line speeds of up to 240m/min.

Offline configuration

Now you can create and save data at a remote location such as an office and later transfer it to the laser marking system on-site for marking.

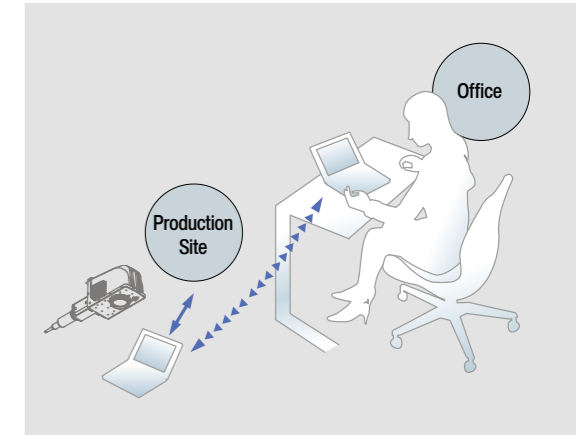

Batch management

You can control multiple laser marking systems with a single computer for centralized management. So it is possible to transfer the configuration data to all with your PC connected marking systems. Easy, straightforward monitoring of settings and operational status rounds off the application's management capabilities.

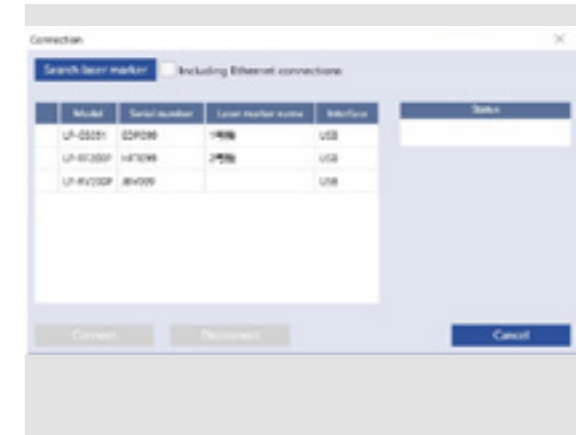

Software and hardware features

- > Marking/Welding order optimizing
- > Automatic correction of intersection
- > Counter function
- > Current date/time
- > Expiry date
- > Lot function
- > Logos/graphics
- > Bold marking
- > I/O monitor
- > Font selection
- > Marking/Welding field indication
- > Control of user access
- > Error code display
- > Marking/Welding image monitor
- > Individual output and speed settings per object
- > Step & repeat
- > Serial data processing & marking
- > Multilayered marking
- > Backup
- > Work distance indication
- > Marking/Welding time measurement
- > Font/logo creation and editing
- > Power check/correction
- > I/O interface

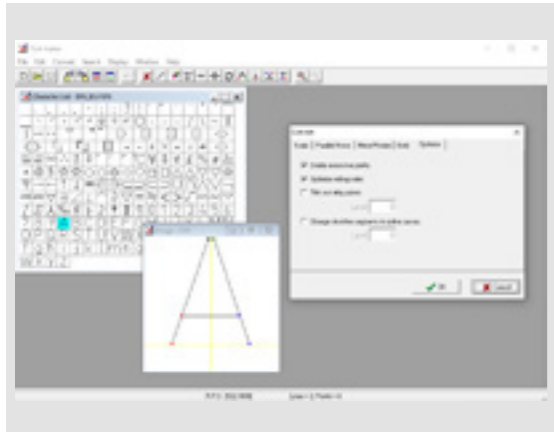

Font creation software

This useful software utility allows you to modify or create your own fonts to be marked with the laser marking system. It is very useful if registered "®" fonts for company and product names need to be used.

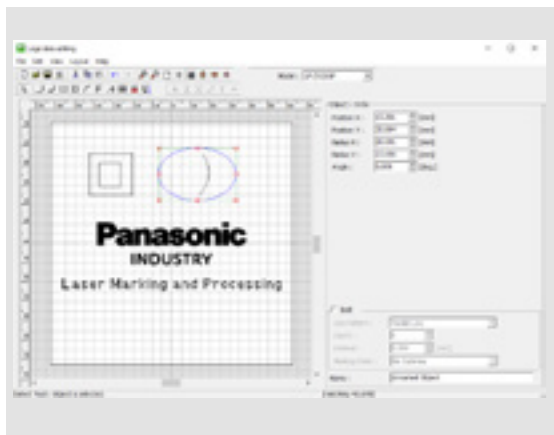

Logo data editing software

Logo data editing software provides a simple and intuitive configuration interface allowing you to create and edit your logo files without using commercial CAD software.



Edit graphics

Graphic files in VEC, DXF, BMP, JPEG, or HPGL format can be directly opened and edited in the standard configuration software (LaserMarker NAVI smart). Data created by Adobe Illustrator® such as AI and EPS can be converted by the included software "ExportVec".

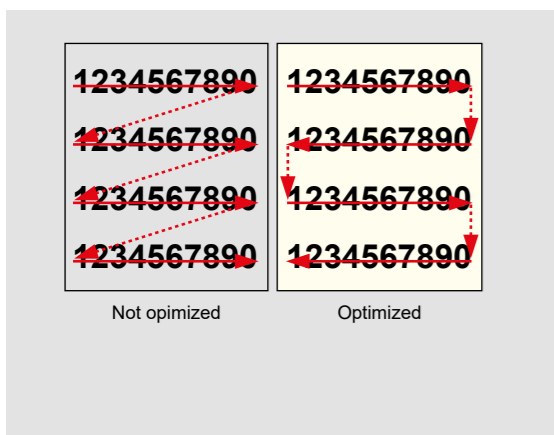

Marking order optimization

Panasonic Industry laser marking systems automatically determine the most efficient marking order, optimizing high-speed marking.

Step & repeat

Step & repeat provides high-speed batch marking for printed circuit boards and plastic packaging such as trays and lead frames, helping increase speeds on semiconductor and electronic component production lines.

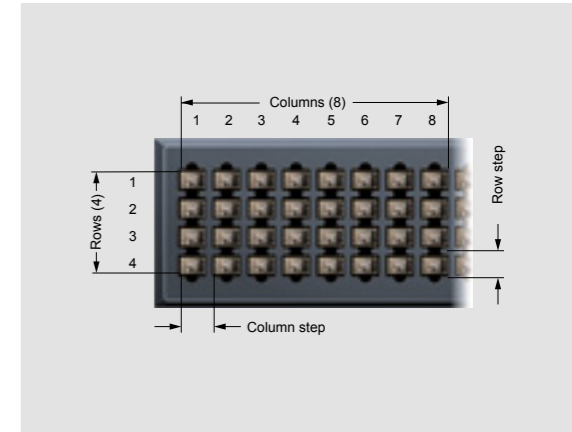

Marking 1D and 2D codes

1D and 2D codes enable product information such as serial and lot numbers to be output in a space-efficient manner. These codes are machine readable and are common for track-and-trace applications.

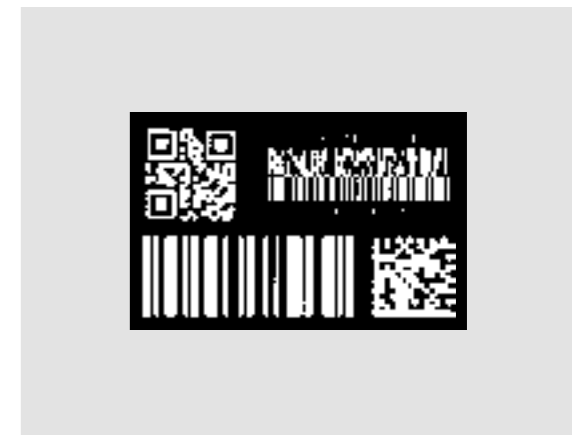

Password

A password feature improves safety and security by restricting the users' access to certain information and system settings. Thus, you can avoid to accidentally overwrite your predefined settings. The whole process of parameterization and maintenance becomes stable.



Help function

Panasonic Industry laser systems include a help feature so that even first-time users are able to operate the system smoothly. Detailed messages inform users of potential configuration errors, reflecting our company's belief that a responsive and intuitive interface is an important aspect of system performance.

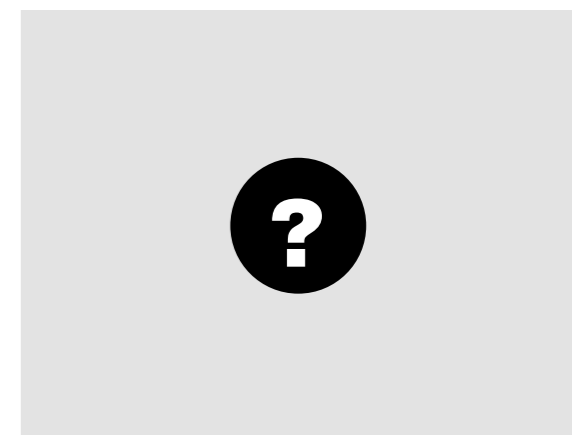

Maintenance & Services for Panasonic Industry lasers systems

To ensure reliable operation with consistent high-quality results Panasonic Industry focused on the robustness of the laser systems. Even in environments with a high exposure of dust or oil mist it is only necessary to clean the lens protection glass with a dry and soft cloth. In order to optimize the running costs and reduce downtime of the laser system the customer can easily change limited-life parts of the controller like fan filters, the fans itself, the internal battery or the contactor kit. Even changing the lens protection glass on the head unit does not require Panasonic Industry personnel.

However, our customers can expect to receive comprehensive support provided by trained experts. Besides a comprehensive maintenance support Panasonic Industry offers a wide-ranging portfolio of customer support to ensure an optimal and cost-effective usability. Our services start with consultation and feasibility studies, assistance in the set-up phase up to maintenance and troubleshooting. We establish a close relationship with our customers from the pre- to the aftersales stage and beyond the product life cycle itself.

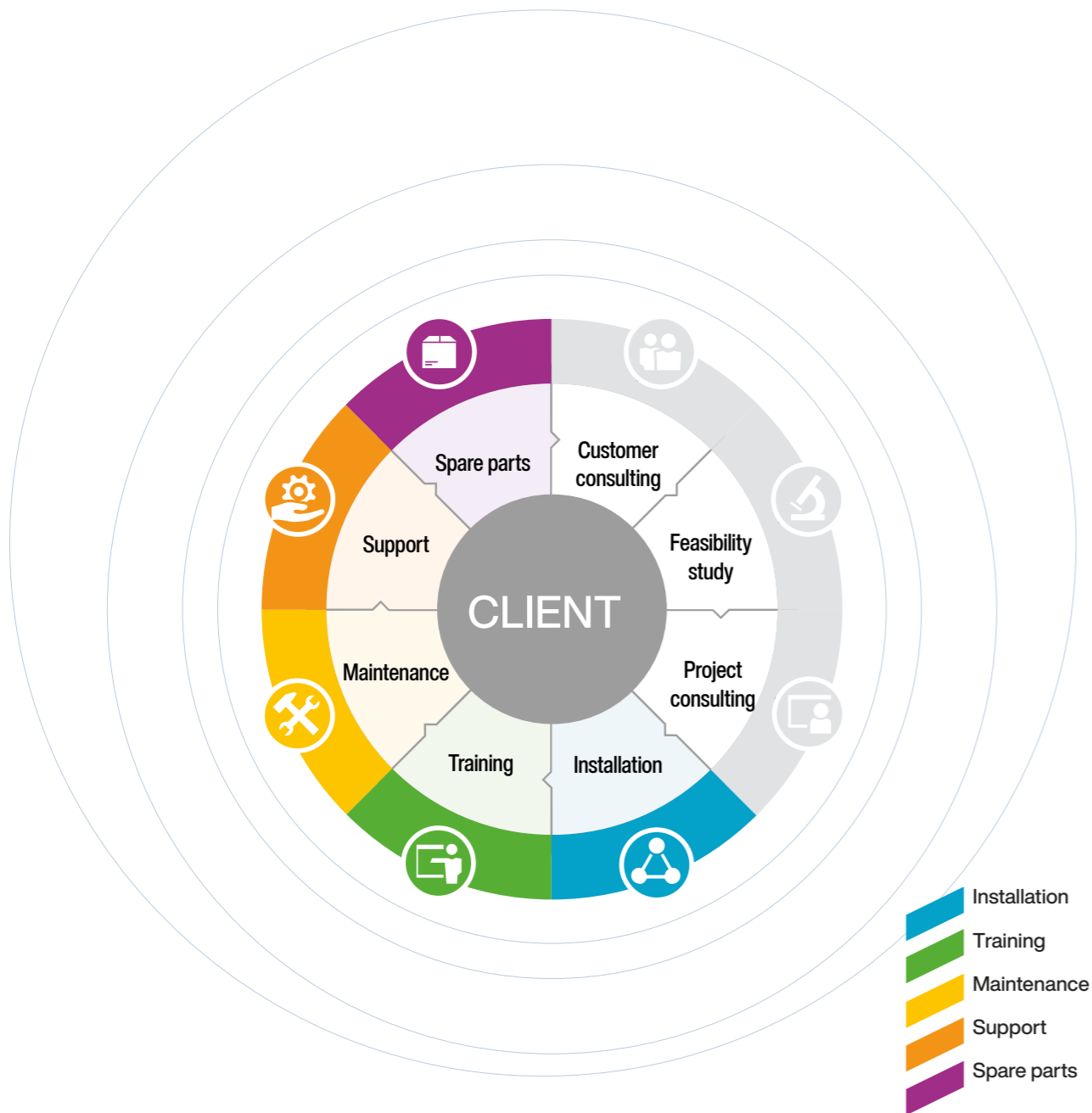

Our service packages

Outstanding service is a matter of course for us. Therefore, we offer different services in three different services packages according to your needs.

- › Guaranteed availability of all series-specific spare parts during the entire contract period
- › Individual spare parts bundles
- › 24/48h spare part and replacement system delivery
- › Emergency hotline
- › Firmware update
- › Training for the operators
- › If required: short-term support by Panasonic Industry service technicians

Included service features	Maintenance Service	Replacement Service*	Premium Service*
Inspection: Visual inspection and a functional test	✓		✓
Preventive maintenance	✓		✓
Firmware update	✓		✓
Recommended actions for operators	✓		✓
Prioritized repair	✓		✓
Replacement system for the duration of the repair period		✓	✓
Prioritized troubleshooting services	✓	✓	✓
Guaranteed availability of all series-specific spare parts during the entire contract period			✓
24/48h spare part and replacement system delivery		✓	✓
Series-specific spare part packages			✓
Emergency hotline: advanced technical support until 22:00 CET			✓
10% discount on spare parts for inhouse repairs			✓

*Replacement and premium service cannot be provided for discontinued products



Workstations

Panasonic Industry offers a stand-alone laser protective enclosure as a manual manufacturing workplace for the production of prototypes and small individual series. The workstation LC-3000 is able to tackle numerous tasks and offers a wide range of possible applications. Panasonic Industry currently offers three different models with the required flexibility of movement: with a rotary indexing table of ø 650mm, with 360° rotation axis or with X, Y, Z axis movement.



Extraction and filtration systems

Panasonic Industry recommends employing an extraction unit when using a laser marking system. This extends the service life of the laser and protects the operator from health hazards. Depending on the application, different extraction units are available, i. e. to mark PVC.

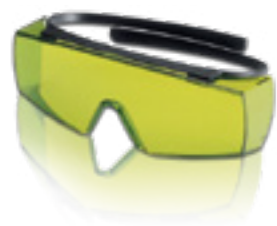

Laser protective goggles

We offer different protective goggles, especially designed for Panasonic Industry laser marking systems. These goggles are exceptionally light, have a very good and comfortable fit and enable a safe all-round visibility. They comply with European laser safety standards EN 207/EN 208.

Find out more:



Sustainable Development Goals

CO₂ emissions and electricity costs have been reduced to about half as compared to other systems.

Companies are striving to contribute to SDGs (Sustainable Development Goals) and achieve sustainability. In many cases, a CO₂ emission reduction target is set for each business division.

Panasonic Industry has developed a fiber laser oscillation system by utilizing its proprietary technologies. Its CO₂ emission is about half of that from a product using a different system (such as Nd:YAG system, Nd:YVO₄ system, etc.). Furthermore, the running cost (cost of electricity) can also be reduced to half. Sustainability and low cost are great advantages, especially for facilities that will be used for many years to come.

Our commitment to global sustainability

We are committed to the highest standards of global environmental sustainability. In 2017, the Panasonic Corporation formulated the Panasonic Environmental Vision 2050, to determine our own initiatives in responding to the expectations and requests from our stakeholders. According to the Environmental Vision 2050, Panasonic Industry Europe is working towards the creation and more efficient utilization of energy, which exceeds the amount of energy used, aiming for a society with a more sustainable lifestyle. We develop technologies to improve the energy-saving performance of products and innovative manufacturing processes to reduce energy consumption. Moreover, we are expanding energy-creation and storage businesses in order to contribute to new social systems such as a hydrogen society, to increase the use of clean energy.

To promote the effective utilization of resources, Panasonic Industry Europe aims for the sustainable use of resources through product recycling. Our factories in Japan and Belgium are the first two Panasonic factories that have successfully become CO₂ emission-free. This was achieved by installing renewable energy power generation systems, such as the photovoltaic power generation system and wind power generation system, procuring 100% renewable electricity, and utilizing carbon credits to offset CO₂ emissions from fossil fuels.

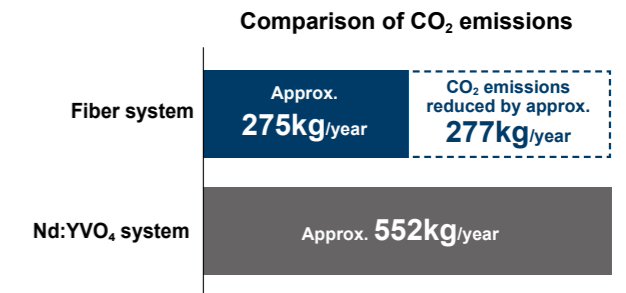

[Estimation conditions]
Emission factor: CO₂: 0.457kg/kWh, laser marker operation: 8 hours/day, 20 days/month, continuous laser irradiation at 100% laser power



Panasonic

INDUSTRY

Sales region	Telephone number
Austria	+43 223626846
Benelux and Scandinavia	+31 499 372727
Czech and Slovakia	+420 541 217 001
France	+33 1 60 13 57 57
Germany	+49 89 45 354 1000
Italy	+39 0456752711
Poland and CEE countries	+48 42 230 96 33
Spain and Portugal	+34 913293875
Switzerland	+41 417997050
United Kingdom and Ireland	+44 1908 231555

Customers from other countries may contact our European headquarters

Panasonic Industry Europe GmbH

Caroline-Herschel-Strasse 100
85521 Ottobrunn
Tel. +49 89 45354-1000
info.pieu@eu.panasonic.com
industry.panasonic.eu