



5054
DISPLAY UNIT
V 3.5.0

Fire alarm solutions
technical description

Table of Contents

1.	INTRODUCTION	5
2.	ABBREVIATIONS	6
3.	GENERAL DESCRIPTION	7
3.1.	RS485	8
3.2.	POWER SUPPLY	8
3.3.	USB	8
3.4.	TOUCH SCREEN	9
3.5.	INFORMATION PAGE	9
3.6.	ALARM PRESENTATION	10
3.7.	COMPATIBILITY	11
3.7.1.	UNIT TYPE	11
4.	EXTERNAL PRESENTATION UNIT	12
4.1.	FIRE ALARM	12
4.2.	BUZZER	12
4.3.	QUIET ALARM	12
4.4.	BUTTONS	13
4.5.	HOW TO LOG IN	13
4.5.1.	PASSWORD	14
4.5.2.	CHANGE OF PASSWORD	14
4.6.	EVENT TAB PAGE	14
4.7.	FIRE ALARM PAGE	15
4.8.	NAVIGATION / GENERAL PROCEDURES	15
4.9.	MENUS	16
4.9.1.	FAULT	17
4.9.2.	DISABLE	18
4.9.3.	ZONE	19
4.9.4.	ADDRESS	20
4.9.5.	PERFORM ZONE TEST	21
5.	ALERT ANNUNCIATION UNIT	22
5.1.	FIRE ALARM	22
5.2.	ALERT ANNUNCIATION FUNCTION	24
5.3.	BUZZER	25
5.4.	QUIET ALARM	25
5.5.	OPERATION	25
5.6.	BUTTONS	25
6.	FIRE BRIGADE PANEL	26
6.1.	FIRE ALARM	26
6.2.	BUZZER	26
6.3.	BUTTONS	27
6.4.	HOW TO LOG IN	27
6.4.1.	PASSWORD	28

6.4.2.	CHANGE OF PASSWORD	28
6.5.	EVENT TAB PAGE	28
6.6.	FIRE ALARM PAGE	29
6.7.	NAVIGATION / GENERAL PROCEDURES	29
6.8.	MENUS	30
6.8.1.	FAULT	31
6.8.2.	DISABLE	32
6.8.3.	ZONE	33
6.8.4.	ADDRESS	34
6.8.5.	PERFORM ZONE TEST	35
7.	GENERAL CONTROL PANEL	36
7.1.	INPUT	37
7.2.	FAN/DAMPER CONTROL	38
7.2.1.	FAULT	39
7.2.2.	PHASE FAULT	39
7.2.3.	FAN CONTROL VIA 4461	40
7.3.	APPLICATIONS	42
7.3.1.	SUPPLY AIR FAN	42
7.3.2.	SMOKE EXHAUST, SMOKE SPILL, AND STAIRS PRESSURISATION FANS	43
7.3.3.	CONFIGURATION IN EBLWIN	44
7.4.	EVACUATE INPUT	46
7.5.	OUTPUT CONTROL	47
7.5.1.	CONFIGURATION IN EBLWIN	49
8.	SERVICE MENU	50
8.1.	UNIT SETTINGS	50
8.2.	LANGUAGE	51
8.3.	DISPLAY UNIT SETTINGS	51
8.4.	VOLUME	51
8.5.	PASSWORD	51
8.6.	TEST DISPLAY	51
8.7.	NETWORK	51
9.	SELECTIVE ALARM PRESENTATION	52
10.	USER DEFINABLE TEXT MESSAGES	53
11.	FAULT MESSAGES IN THE DISPLAY UNIT	54
12.	IP CAMERA AND DRAWING	55
12.1.	EBL GRAPHICS	55
12.2.	EBL SERVICE	56
13.	FIRMWARE	58
13.1.	VERSION	58
13.2.	FIRMWARE DOWNLOAD	58
13.2.1.	DOWNLOAD FIRMWARE WITH MANUAL BOOT MODE	59
14.	MOUNTING	60
14.1.	MOUNTING IN DISPLAY UNIT METAL CABINET	62

14.2. DRILL MEASURE	64
15. INSTALLATION AND WIRING	65
16. RESTART	67
17. COMMISSIONING	68
18. TECHNICAL DATA	69
19. APPROVALS	70

1. INTRODUCTION

This document describes the display unit, type number 5054.

The document contains information about the product and instructions on how to mount and connect it.

2. ABBREVIATIONS

CIE	Control and indicating equipment
CU	Control unit number (CIE no 00-29)
CU1	The first control unit number in the sequence
CU2	The last control unit number in the sequence
dB	Decibel
DU	Display unit
FW	Firmware
LED	Light Emitting Diode
SSD	Site Specific Data
zone	Zone number (001-999) In EBL128 (01-99)
zone1	The first zone number in the sequence
zone2	The last zone number in the sequence
zone, addr	Zone number and address within the zone (001, 01-999, 99)
zone1, addr1	The first zone number and address in the sequence
zone2, addr2	The last zone number and address in the sequence

3. GENERAL DESCRIPTION

The display unit consists of a colour touch display and has multi language support. It is intended to be used for fire alarms and information in the fire alarm system.

When a fire alarm is activated in the CIE, the fire alarm information will be sent to the display unit. An alarm text can be presented together with each alarm, if programmed in the CIE or in EBLWin.

It is possible to choose the unit type of the display unit:

External presentation unit: The external presentation unit is intended to be used as a display unit for fire alarms and information in the fire alarm system.

Fire Brigade Panel: The fire brigade panel is used to present and reset the fire alarms.

Alert annunciation unit: Alert annunciation unit is required when the alert annunciation function is used in EBLWin to present, acknowledge, and reset the alert annunciation alarms.

General control panel: The general control panel is a panel used to control up to eight inputs. Each input is programmed via EBLWin.

The display unit complies with IP30, in respect of dust and moisture. It is intended for indoor use and in dry premises.

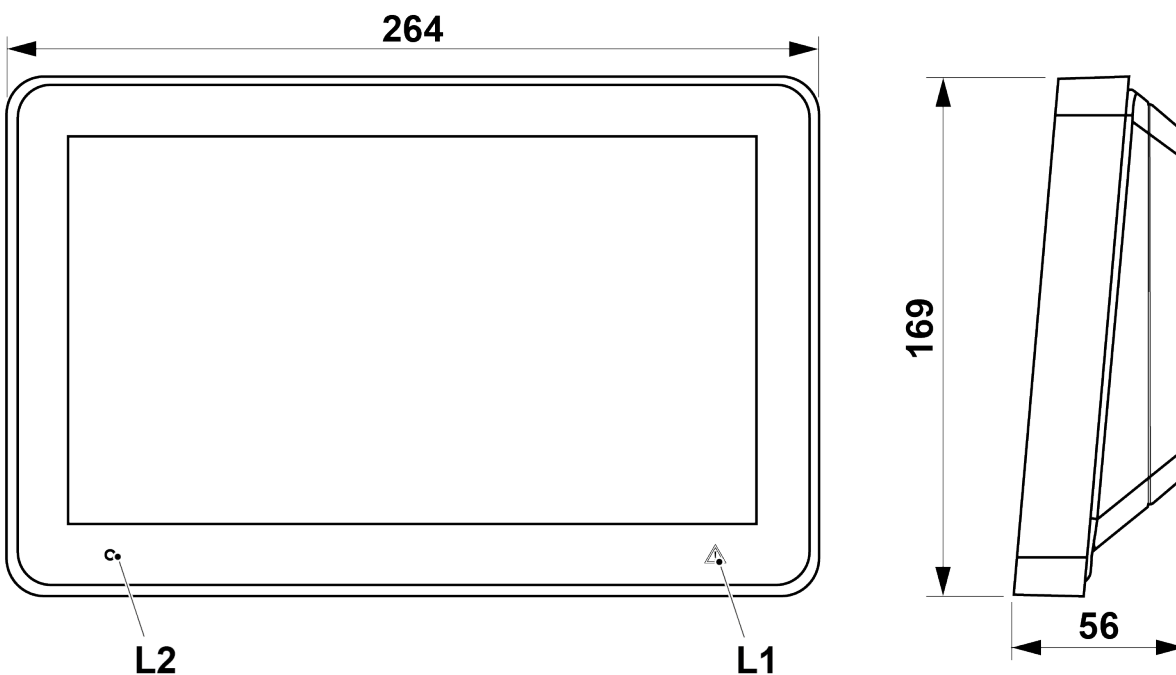

(Measure in mm)

LED		Colour	Indicating
L1	Watchdog fault / communication fault	Yellow	<p>Fault LED steady: Force the display unit into boot mode and download firmware, see 13.2.1. DOWNLOAD FIRMWARE WITH MANUAL BOOT MODE on page 59.</p> <p>Fault LED blinking: Display unit is starting up, but fails. Force the display unit into boot mode and download firmware, see 13.2.1. DOWNLOAD FIRMWARE WITH MANUAL BOOT MODE on page 59.</p>
L2	Power	Green	Power LED steady

3.1. RS485

The display unit communicate with the CIE via RS485.

In system EBL512 G3 the required components are mounted on the main board by delivery.

In the last unit on the line, a termination resistor (120R) has to be connected. In the display unit this is done via jumper "J3" for primary or "J7" for secondary. ("J7" shunted = the termination resistor is connected.)

If redundancy is used, a termination resistor (120R) has to be connected in the last unit on both primary and secondary line.

3.2. POWER SUPPLY

The tables below are example of cables for installation of **one** display unit. The total distance is halved for each unit added, for example:

One display unit = 150 m

Two display units = 75 m

Joint communication and power supply in twisted pairs, shielded, RS485-cable:

Cable data	Type	Distance to unit	Example
24 AWG = Ø 0,51mm = 0,25 mm ²	1 pair of Communication & 1 pair of power supply	150 m	Belden 1419A, 24#- 2pr
24 AWG = Ø 0,51mm = 0,25 mm ²	1 pair of Communication & 2 pair of power supply	300 m	Belden 1420A, 24#- 3pr
24 AWG = Ø 0,51mm = 0,25 mm ²	1 pair of Communication & 3 pair of power supply	450 m	Belden 1421A, 24#- 4pr

Separate communication and power supply

Communication cable data	Type	Distance to unit	Example
24 AWG = Ø 0,51mm = 0,25 mm ²	1 pair of Communication (RS485)	1200 m	Belden 1419A, 24#- 2pr
22 AWG = Ø 0,64mm = 0,33 mm ²	1 pair of Communication	1200 m	Belden 7703NH, 24# - 1pr

Power supply cable data	Type	Distance to unit	Example
14 AWG = Ø 1,63mm = 2,09 mm ²	1 pair of power supply (Fire Alarm 14#)	1600 m ¹⁾	Belden 5120UL, 14#
16 AWG = Ø 1,29mm = 1,31 mm ²	1 pair power supply (Fire Alarm 16#)	1000 m	Belden 5220UL, 16#
18 AWG = Ø 1,02mm = 0,80 mm ²	1 pair of power supply (COM-loop)	500 m	Draka ELQYB, 2x1

1) Up to 1200 m communication cable can be used.

The display unit has two screw terminal blocks for cable connections.

Since the CIE power supply output current is limited to 1.6A, up to four display units can be power supplied via the CIE. The External power supply 4466, can supply up to five display units per output.

3.3. USB

The display unit is equipped with an USB interface (X2), used to update the Firmware.

3.4. TOUCH SCREEN

The display is a colour touch screen. The screen brightness can be adjusted, see [8.3. DISPLAY UNIT SETTINGS](#) on page 51. The touch screen will go into sleep mode after 2 minutes.

Data:

- Display size: 10.1"
- TFT Screen LCD type
- Capacitive display
- Resolution: 1024x600 RGB

3.5. INFORMATION PAGE

On the information page (non-alarm mode) it is possible to change the default image to a customer specific image. The image is downloaded via EBLWin, see Planning instruction.

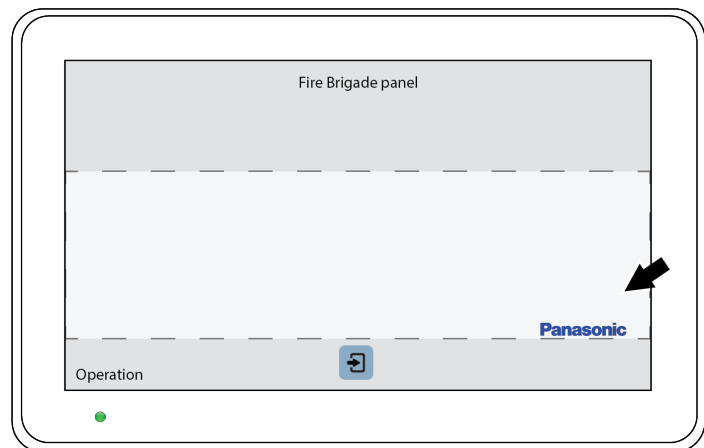
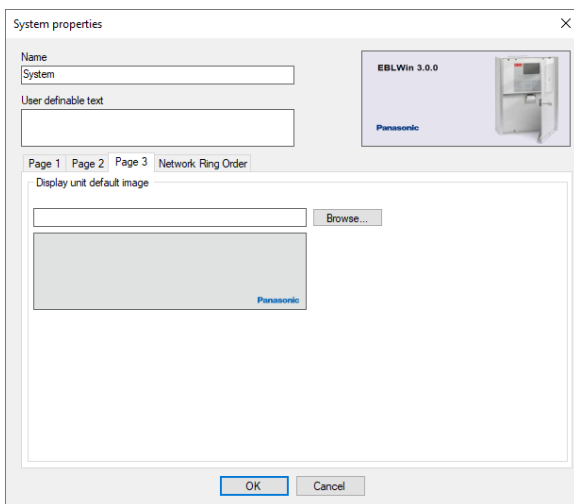

The image will be aligned to the bottom-right corner of the image area, see arrow above.

IMAGE FORMAT

Display unit supports the most common image file formats. Upload images of up to 1000 x 290 pixels and with a recommended file size of up to 20 kilobytes. Images bigger than 20 kilobytes will automatically be resized.

Resized images can become blurry.

The default image can be created in for example Paint or Illustrator. Illustrator template and background images can be downloaded from www.panasonic-fire-security.com.

Use background images in Paint

- Open the background image.
- Add your logo. Make sure to scale the logo into correct size before adding it to the background, otherwise the file size may be too big.
- Add your text.
- Save the image.

Make sure that the background format has not changed. If necessary, crop the image to valid image format.

3.6. ALARM PRESENTATION

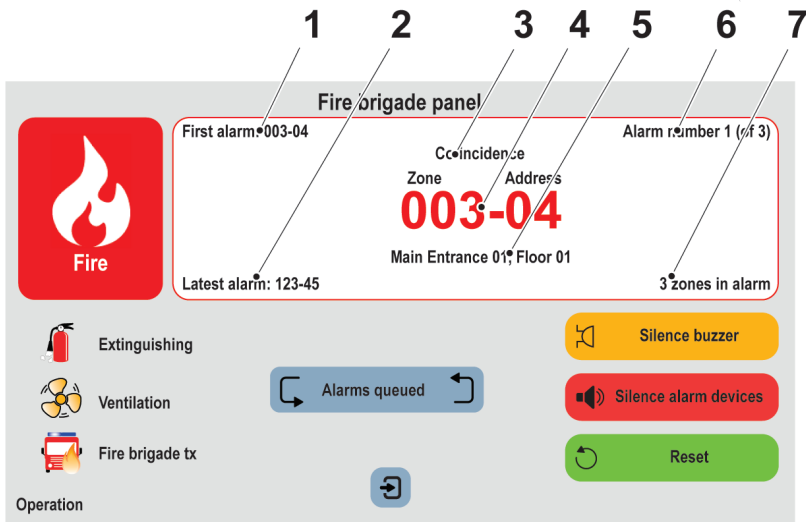

1. First zone or alarm point in alarm
2. Latest zone or alarm point in alarm
3. Alarm type
4. Displayed alarm
5. User definable text
6. Position of displayed alarm in the list
7. Number of zones in alarm

Symbol explanation



Extinguishing – Outputs for extinguishing equipment are activated



Ventilation – Outputs for (fire / smoke) ventilation are activated



Fire brigade tx – Output(s) for fire brigade tx (routing equipment) is/are activated

The symbols are greyed out when not active.

3.7. COMPATIBILITY

Display unit V3.5 is only compatible with EBL512 G3 v.3.5.x.

For Display unit firmware version compatibility with EBL512 G3 versions, see the EBL512 G3 tab in our "Compatibility matrix EBL512 G3, EBLOne, and software". The compatibility excel can be downloaded from www.panasonic-fire-security.com.

Display unit V3.4 require hardware (HW) version 3 or higher. The display units HW version can be found in the service menu.

From EBL512 G3 v.3.0 when main board 5012 was introduced, it was possible to increase the communication speed in the display unit.

Display unit with firmware version 2.x.x (V2) uses a slower communication speed than Display unit with firmware version 3.x.x (V3), and need to be converted to be able to use with EBL512 G3 versions 3.X.

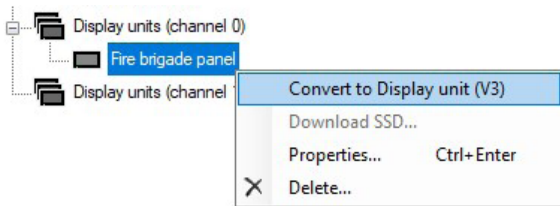

Firmware version	HW version		
	Cfg 1 (HW version 2)	Cfg 2 (HW version 3)	Cfg 3 (HW version 4)
1.0.0 - 1.0.3	OK	OK	OK
2.0.0 - 2.0.7	OK	OK	OK
3.0.0 - 3.1.0	OK	OK	OK
3.4.0	Not OK	OK	OK
3.5.0	Not OK	OK	OK

3.7.1. UNIT TYPE

Set the unit type according to the table below:

Unit type	EBL512 G3	EBL 128	EBL 512 (1587)	EBL 512 (1582)
Fire brigade panel	All versions	All versions	V ≥ 2.2.X	Not used
Alert annunciation unit	All versions	All versions	V ≥ 2.2.X	Not used
External presentation unit	All versions	All versions	V ≥ 2.2.X	Not used
General control panel	V ≥ 3.0.X	Not used	Not used	Not used

**For EBL512 G3 version ≥ 2.5, program as Display unit 5054 – and select unit type in EBLWin.
For older version than EBL512 G3 version 2.5, program 5054 (version 1.0.x) as an older display units 1728, 1735, 1826, & 1828.**

4. EXTERNAL PRESENTATION UNIT

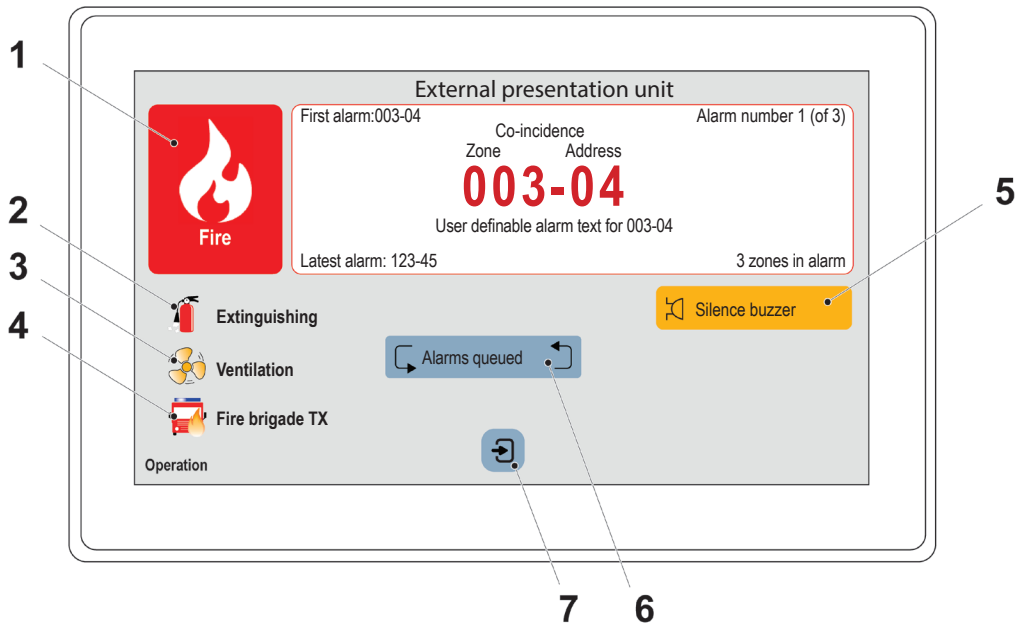

1. Fire alarm indicator
2. Extinguishing symbol
3. Ventilation symbol
4. Fire brigade tx symbol
5. Silence buzzer
6. Alarms queued
7. Log in

4.1. FIRE ALARM

When a fire alarm is activated Pre-warnings, co-incidence, fire alarms, and heavy smoke / heat alarms will be presented on the display.

The fire alarm indicator will start to flash (0.4/0.4 s) if it is a real fire alarm (it will not flash for pre-warning or co-incidence).

The button silence buzzer is possible to use.

If there are two or more alarms in the system, the button alarms queued will be shown, and you can scroll amongst the alarms but the fire alarms cannot be reset via the display unit.

When all fire alarms are reset, the display unit will return to normal operation.

4.2. BUZZER

The unit has a built-in buzzer that will sound (0.4/0.4 s) when a real fire alarm is activated (0.8/5s for pre-warning or co-incidence). The buzzer can be silenced but the alarm devices in the installation cannot be silenced via the display unit.

If the buzzer is programmed as "disabled" via EBLWin, it will never sound.

4.3. QUIET ALARM

Quiet alarm can be shown in the display unit. This is valid for Australian and New Zealand conventions only.

4.4. BUTTONS

SILENCE BUZZER – Visible when buzzer sounds. The button Silence buzzer can be used to silence the internal buzzer. The buzzer will re-sound for a new fire alarm / fault.

ALARMS QUEUED – Visible when there are two or more fire alarms in the system. The button Alarms queued is visible, and you can scroll amongst the fire alarms. The first alarm will automatically be shown again after 20 seconds, if no button is pressed during that time.

4.5. HOW TO LOG IN

To get access to the menus, it is necessary to log in with a user name and a password.

- Press  to log in.
- Select a user in the drop-down list.
- Type the password for that user. (Six digits. * * * * *).

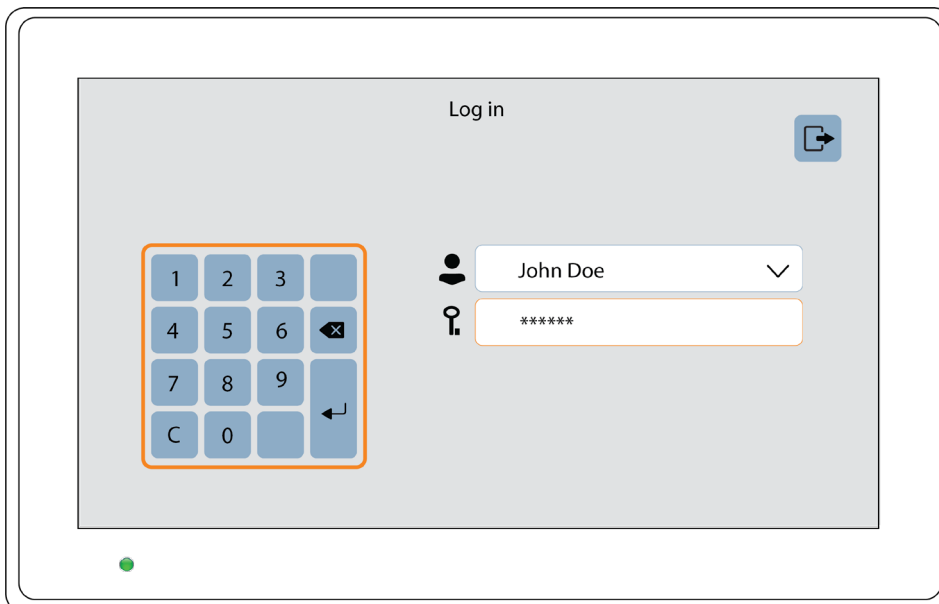

After typing a correct password, a main menu list with the available menus will be displayed.

The cross  will be shown if the password was not correct. Try again.

After three wrong passwords the log in function will be blocked for one hour for the user name respectively.

4.5.1. PASSWORD



Each user has a password for an access level, for example "Building officer" or "Service personnel".

4.5.2. CHANGE OF PASSWORD

The user names and passwords are downloaded / changed via EBLWin and SSD download to the control unit.

If the valid password(s) are unknown, EBLWin must be used to change the password(s).

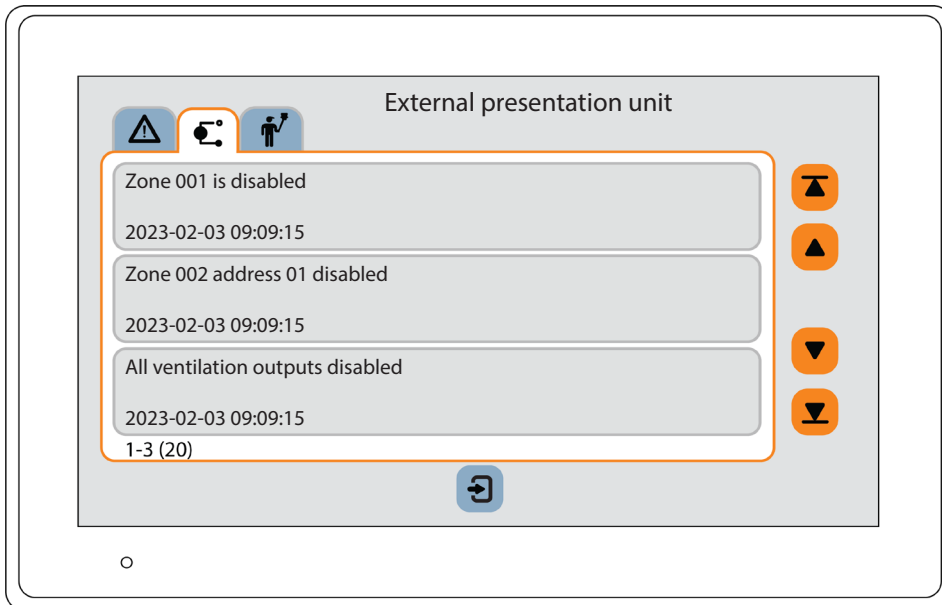

4.6. EVENT TAB PAGE

- The event tab page is only shown when logged out and there are no alarms. In logged in mode, press log out  to access the event tab page.
- In logged out mode, the event tab page will be shown if there are any events in the system.
- A tab will be shown on the event tab page if there are any faults, disablements, or zones in test mode in the system.
- To switch between the tabs, press the tab icon.
- To access the menu system when the event tab page is shown, press  to log in.









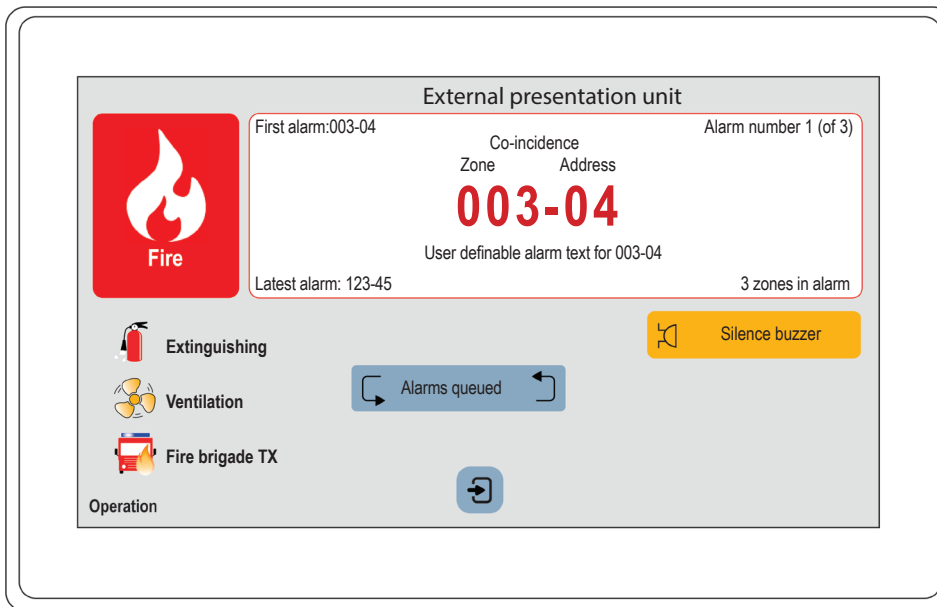





When the event tab page is shown, the screen backlight will go down to 10% after 5 minutes. It will never turn off.



4.7. FIRE ALARM PAGE

- If the system is in alarm state, the screen will be turned on and the alarm page is shown.
- The fire alarm page is only shown when logged out. In logged in mode, press the fire button  or log out  to go to the alarm page. You will be automatically logged out.
- To access the menu system during alarm state, press  to log in. The normal alarm page will be automatically displayed again after the menu system is escaped or 20 seconds after the latest maneuver in the menu system.
- The alarm page has priority over the event tab page.



4.8. NAVIGATION / GENERAL PROCEDURES

- Scroll in the lists with  and , or go directly to the top or bottom of the list with  and .
- Tap on the input field, a numpad will pop up to enter data.
- Press the button  to re-enable a function on one unit or press  to re-enable the function on all units.
- To acknowledge, press .
- A successful operation is indicated by a . It will also be shown in the list.
- A not successful operation is indicated by a .
- To return to the main menu press .
- If the system also is in fire alarm state, the fire button  will be shown. Press the fire button  to go to the fire alarm page.
- To leave the menu system and log out, press log out .

Quick jump can be used within each menu, press the icons in the top left corner    for a quick jump to previous menu.

You will be automatically logged out 15 minutes after the last action, and after 5 seconds when you press log out . A new login is then required.

4.9. MENUS

The following chapters describe the menus in the Fire Brigade Panel and the procedures to use them.







For general information on navigation in the menu system, see section [4.8. NAVIGATION / GENERAL PROCEDURES on page 15](#).

4.9.1. FAULT

Up to 300 faults can be listed:

- Not corrected (not serviced) and not acknowledged faults (no status information)
- Not corrected (not serviced) but acknowledged faults (/Acknowledged)
- Corrected (serviced) but not acknowledged faults (/Serviced)

- Log in to the display unit.
- Navigate to menu  > .
- Press  or  to scroll in the list. The most recent fault is on top of the list.
- To acknowledge a fault, press . A serviced fault that is acknowledged will disappear from this list.

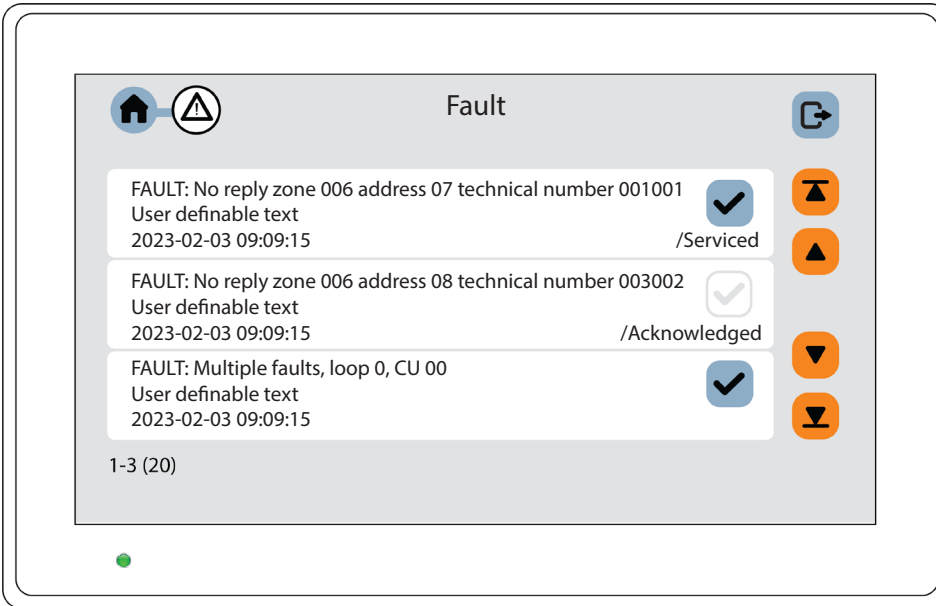

- To exit the menu press .

If there are no events, the list will be empty.

4.9.2. DISABLE

- a) Log in to the display unit.
- b) Navigate to menu . A sub menu list will be displayed.

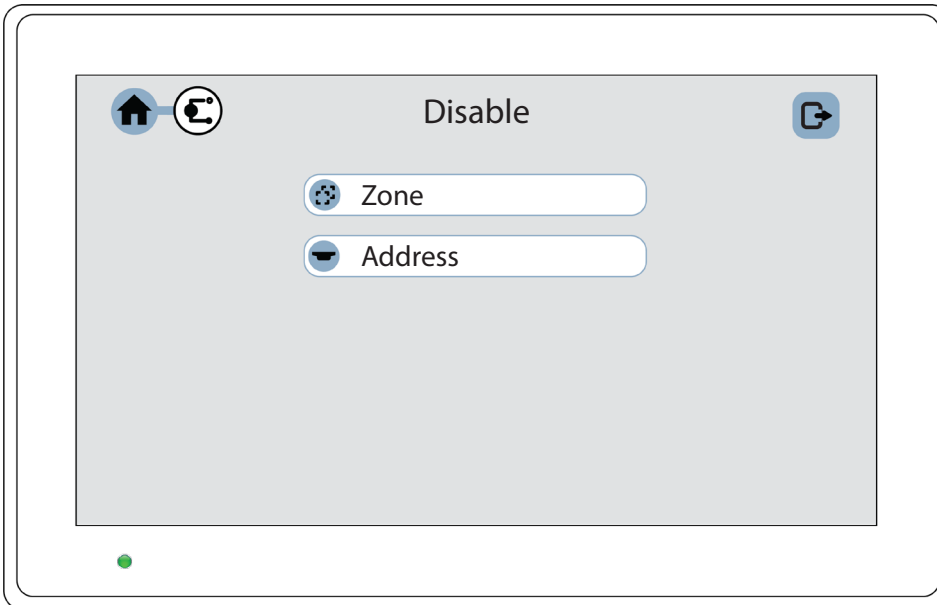

A whole zone, one or more alarm points within a zone and/or control outputs can be disabled. This function can be used for temporary disablement (e.g. craftsmen working in the premises, etc.).

If the function Enhanced disablement is enabled (default), disabled alarm points cannot activate Pre warning, fire alarm and fault. If this function is not enabled (via EBLWin), disabled alarm points cannot activate Pre-warning and fire alarm but fault can be generated. (This is a violation to the EN54-2 standard).

An Addressable manual call point can be disabled (but shall normally not be disabled). When a whole zone is disabled, the addressable manual call points will also be disabled. (This function complies with EN54-2 but can be changed in EBLWin).

All zones can be disabled.

Up to 200 alarm points (zones / address) can be individually disabled. (Alarm points disabled via time channels are not limited and must not be counted!)

Don't forget to re-enable, or use automatic re-enablement for zones and alarm points.

4.9.3. ZONE

When a whole zone is disabled, all alarm points within the zone will be disabled.

DISABLE:

- a) Log in to the display unit.
- b) Navigate to menu > > .
- c) Enter the zone number, one by one or in range.
- d) If "Automatically re-enablement" shall be used, enter time (hh:mm). Default time is 00:00. Automatic re-enablement is indicated with the time.
- e) Press to disable the zone. The zone will appear in the list.

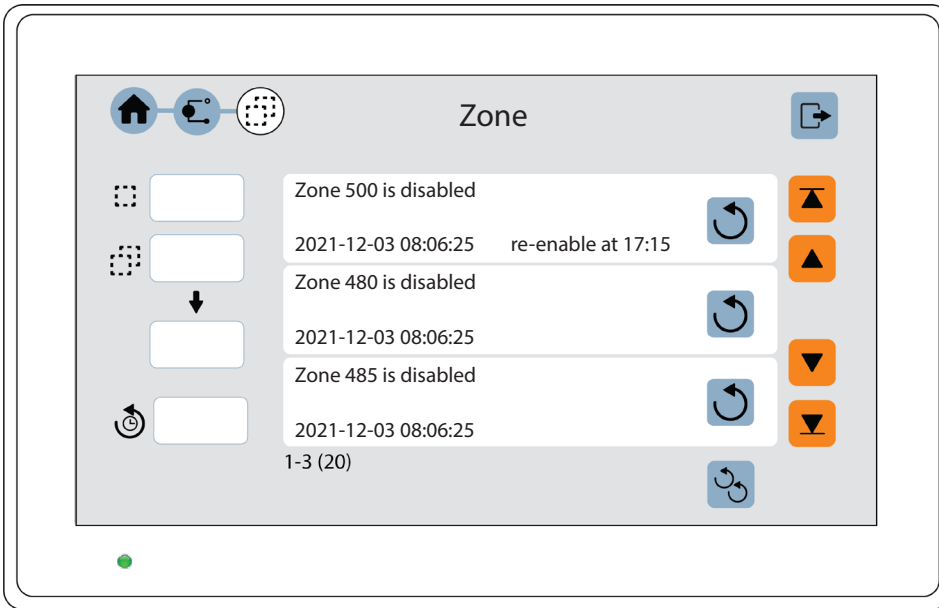

RE-ENABLE:

Press the button to re-enable a zone or to re-enable all zones. Re-enabled zone will disappear from the list.

4.9.4. ADDRESS

All alarm points connected to the COM loop can be individually disabled.

DISABLE:

- Log in to the display unit.
- Navigate to menu > > .
- Enter the zone number and address .
- If "Automatically re-enablement" shall be used, enter time (hh:mm). Default time is 00:00. Automatic re-enablement is indicated with the time.
- If the smoke part of the multidetector shall be disabled, check the check box "Smoke only".
- Press to disable the zone address. The zone address will appear in the list.

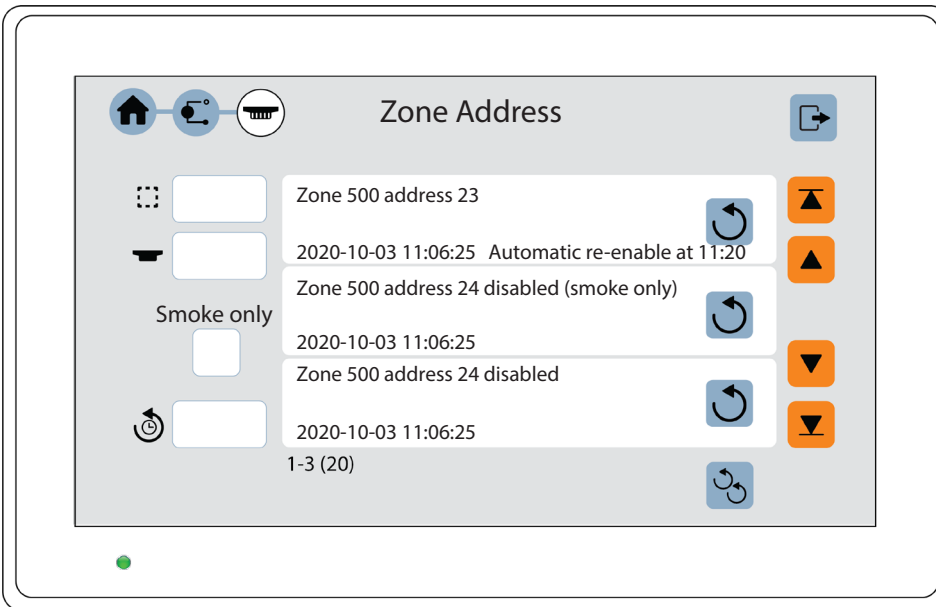

RE-ENABLE:





Press the button to re-enable a zone address or to re-enable all zone addresses. Re-enabled zone address will disappear from the list.

4.9.5. PERFORM ZONE TEST

Normally, zones are tested during the monthly test. Via this menu it is also possible to perform the zone test. Up to 100 zones can be set in test mode. In test mode, only the alarm points are tested.

No outputs (sounders) will be activated during the test.

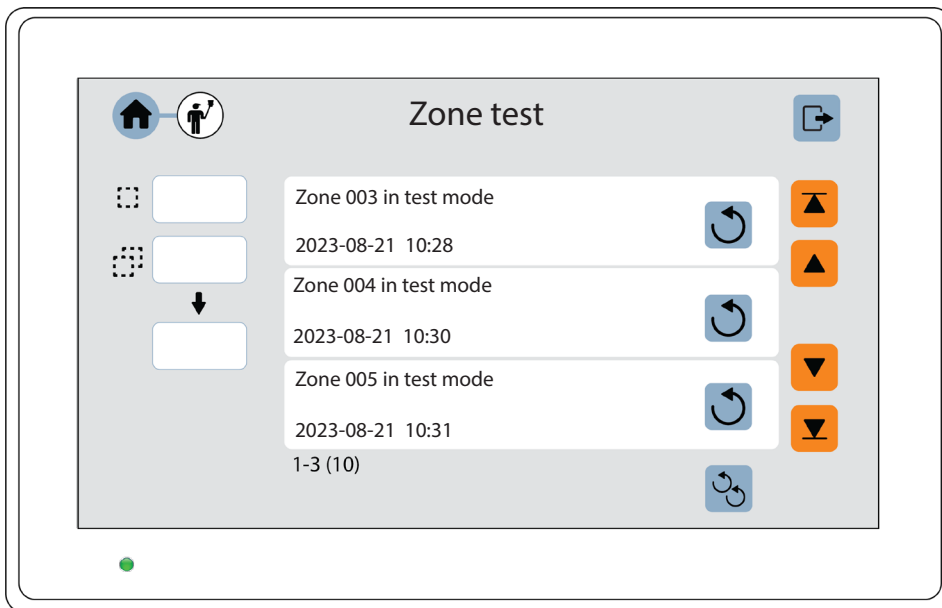

If a real fire alarm is activated by an alarm point not in test mode, the normal fire alarm functions will be activated, which means fire alarm presentation, outputs activated, routing equipment activated, and so on.

- a) Log in to the CIE.
- b) Navigate to menu  > .
- c) Enter the zone number,  one by one or  in range, and press  to start the test. The zone will appear in the list.



The green polling LED in the 440x / 440xl detectors will be turned off in test mode.

END TEST MODE

- d) Press the button  to end the test mode of a zone or  to end test mode of all zones. Zones with ended test mode will disappear from the list. The test mode must be ended for all zones.

5. ALERT ANNUNCIATION UNIT

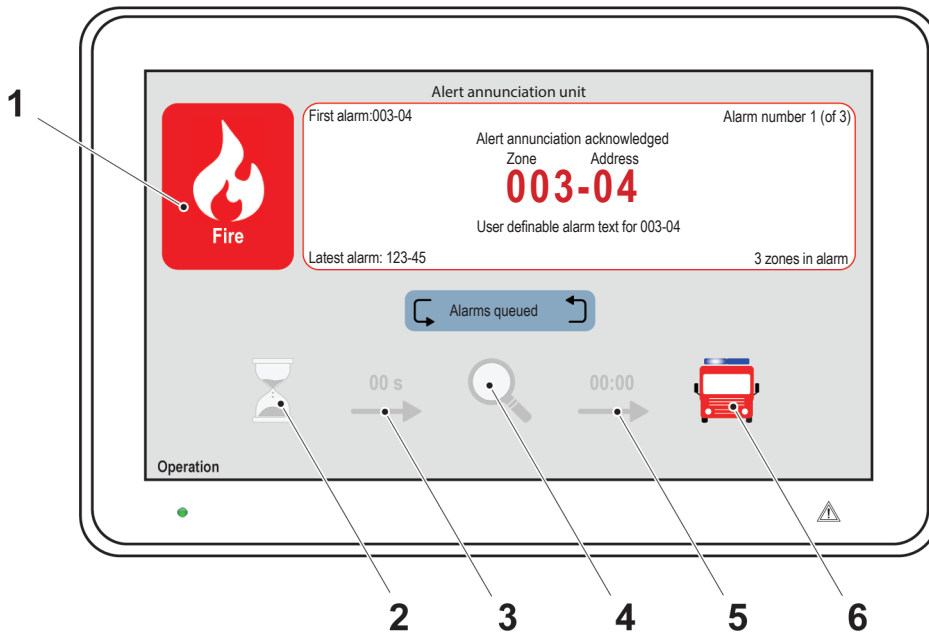

1. Fire alarm indicator
2. Acknowledge symbol
3. Acknowledge time
4. Investigation symbol
5. Investigation time
6. Fire brigade alerted symbol

5.1. FIRE ALARM

FIRE ALARM WITHOUT ALERT ANNUNCIATION

When a fire alarm is activated, fire alarms and heavy smoke / heat alarms will be presented on the display. The fire alarm indicator will start to flash (0.4/0.4 s) and the Fire brigade alerted symbol is activated.

If there are two or more alarms in the system, the button alarms queued will be shown, and you can scroll amongst the alarms but the fire alarms cannot be reset via the display unit.

When all fire alarms are reset, the display unit will return to normal operation.

FIRE ALARM WITH ALERT ANNUNCIATION

When an alert annunciation alarm is activated the acknowledge time starts. The fire alarm indicator will start to flash (0.4/0.4 s) and the button Acknowledge is possible to use.

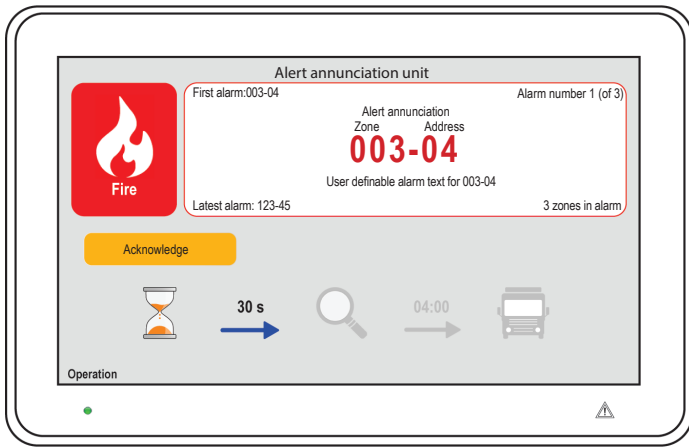

When the alarms have been acknowledged, the investigation time starts. The fire alarm indicator will stop flashing and the button Reset is possible to use.

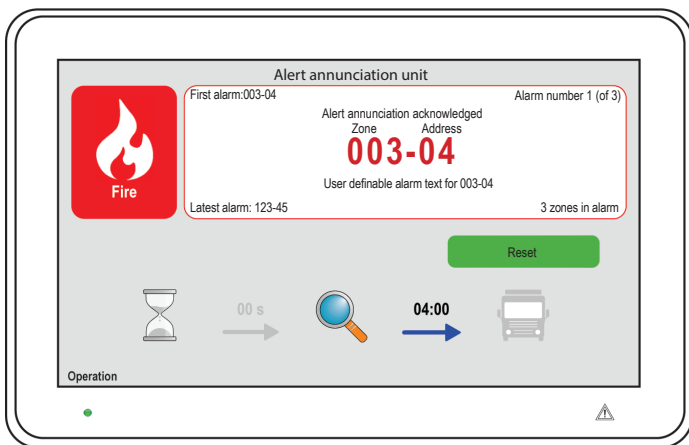

If the alarms are not reset within the investigation time, the Fire brigade alerted symbol is activated. If there are two or more alarms in the system, the button alarms queued will be shown, and you can scroll amongst the alarms.

When all fire alarms are reset, the display unit will return to normal operation.

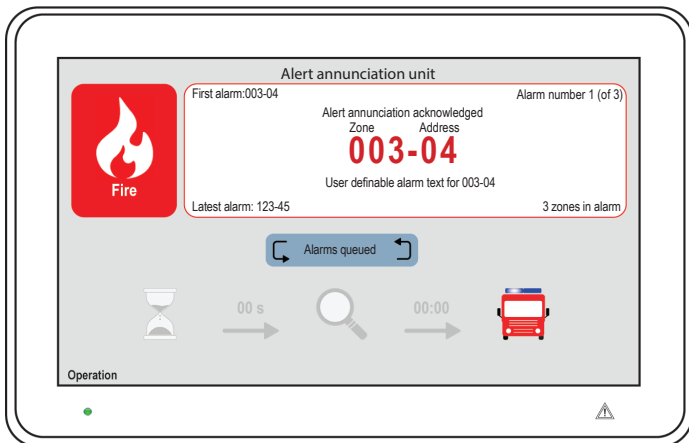

5.2. ALERT ANNUNCIATION FUNCTION

The alert annunciation function can be used to avoid nuisance alarms to the fire brigade. The alert annunciation function is programmed via EBLWin, and normally analog smoke detectors and zones with smoke detectors only are programmed. Heat detectors and manual call point should normally not be programmed for alert annunciation. A manual call point can only activate the alert annunciation function if there are no other fire alarms activated in the system.

The alert annunciation alarms have to be acknowledged within an acknowledged time. The acknowledged alarms has to be reset within an investigation time, else the output(s) for fire brigade tx will be activated.

During acknowledge and investigation time:

- the output(s) for fire brigade tx will be activated, if a fire alarm is activated by a detector/zone not programmed for alert annunciation or if the alarm is activated by a manual call point
- more than one alert annunciation alarm is allowed within the same zone, if “multiple alarms allowed within same zone” is set via EBLWin
- “Number of zones” can be set via EBLWin. Normally only one zone with alert annunciation alarm is allowed but up to four zones can be allowed.

Acknowledge and reset is done on the display unit. A programmable output for indication and programmable inputs can also be used. In some conventions can this also be done in the CIE.

Acknowledge time and investigation time is set in System properties in EBLWin. The acknowledge time can be set to 0-120 seconds and the investigation time can be set to 0-9 minutes.

The total delay time (acknowledge time + investigation time) of a fire alarm must not exceed 10 minutes.

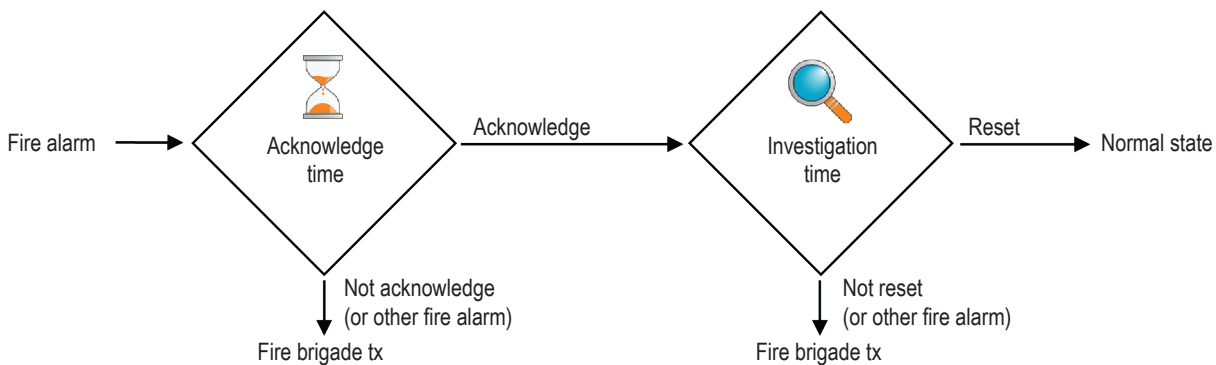

The alert annunciation function is normally turned on during daytime, working hours only. A time channel can turn on/off this function. When the alert annunciation function is turned on, it is indicated by the time glass on the CIE front. Normally only one time channel is used for this function but two or more channels can be used. The alert annunciation function can, as an alternative, be continuously on.

The alert annunciation function can be turned off via menu in CIE and will stay off until turned on again via the menu.

5.3. BUZZER

The unit has a built-in buzzer that will sound (0.4/5 s) when an alert annunciation alarm is activated. The buzzer will be silent when the acknowledge button is pressed or when the alert annunciation alarm turns into a real fire alarm.

If the buzzer is programmed as "disabled" via EBLWin, it will never sound.

5.4. QUIET ALARM

Quiet alarm can be shown in the display unit. This is valid for Australian and New Zealand conventions only.

5.5. OPERATION

The time glass symbol is activated when the alert annunciation function is active in the system.

5.6. BUTTONS

ACKNOWLEDGE – Visible when there are un-acknowledged alert annunciation alarms in the system. The button Acknowledge can be used to acknowledge the alert annunciation alarms.

RESET – Visible when a fire alarm is activated. The button Reset can be used to reset the fire alarms in the system. This button is password protected, see [8.5. PASSWORD](#) on page 51.

ALARMS QUEUED – Visible when there are two or more fire alarms in the system. The button Alarms queued is visible, and you can scroll amongst the fire alarms. The first alarm will automatically be shown again after 20 seconds, if no button is pressed during that time.

6. FIRE BRIGADE PANEL

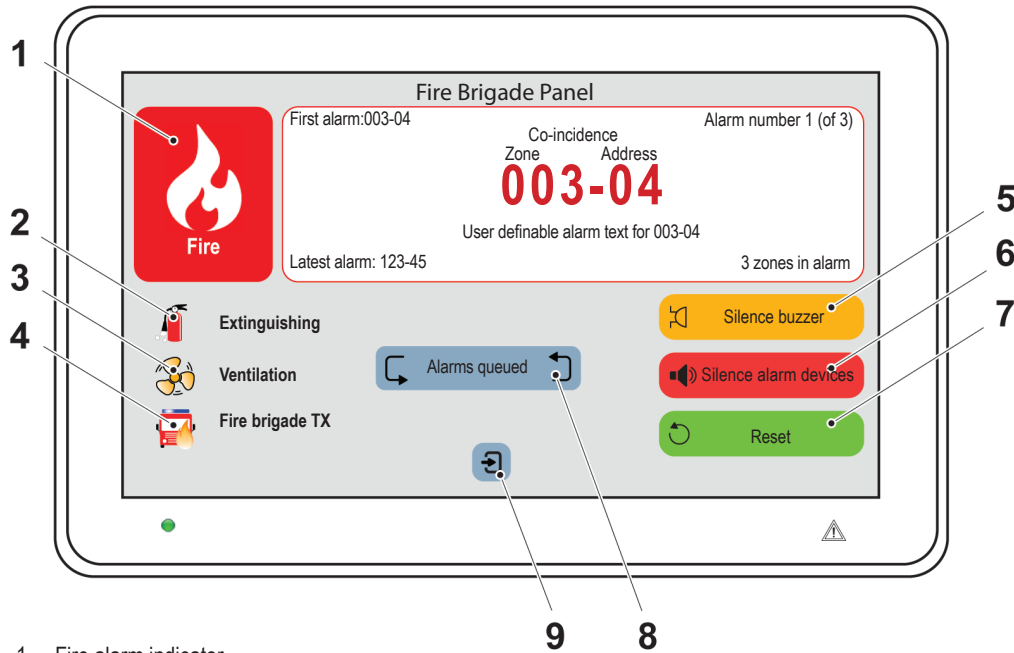

1. Fire alarm indicator
2. Extinguishing symbol
3. Ventilation symbol
4. Fire brigade tx symbol
5. Silence buzzer
6. Silence alarm devices
7. Reset
8. Alarms queued
9. Log in

6.1. FIRE ALARM

When a "Fire alarm" is activated, Pre-warnings, co-incidence, fire alarms, and heavy smoke / heat alarms will be presented on the fire alarm page. The fire alarm indicator will start to flash (0.4/0.4 s).

The buttons Silence buzzer, Silence alarm devices, and Reset are possible to use.

If there are two or more alarms in the system, the button alarms queued will be shown, and you can scroll amongst the alarms. The fire alarms can be reset via the display unit. When all fire alarms are reset, the display unit will return to normal operation.

6.2. BUZZER

The unit has a built-in buzzer that will sound (0.4/0.4 s) when an alarm is activated (0.8/5s for pre-warning or co-incidence). The buzzer can be silenced.

If the buzzer is programmed as "disabled" via EBLWin, it will never sound.

6.3. BUTTONS

SILENCE BUZZER – Always visible. The button Silence buzzer can be used to silence the internal buzzer. The buzzer will re-sound for a new fire alarm / fault.

SILENCE ALARM DEVICES – Visible when a fire alarm is activated. The button Silence alarm devices can be used to silence the alarm devices in the system. This button is password protected, see [8.5. PASSWORD](#) on page 51. The alarm devices will re-sound for a new alarm.

RESET – Visible when a fire alarm is activated. The button Reset can be used to reset the fire alarms in the system. This button is password protected, see [8.5. PASSWORD](#) on page 51.

ALARMS QUEUED – Visible when there are two or more fire alarms in the system. The button Alarms queued is visible, and you can scroll amongst the fire alarms. The first alarm will automatically be shown again after 20 seconds, if no button is pressed during that time.

6.4. HOW TO LOG IN

To get access to the menus, it is necessary to log in with a user name and a password.

- Press  to log in.
- Select a user in the drop-down list.
- Type the password for that user. (Six digits. * * * * *).

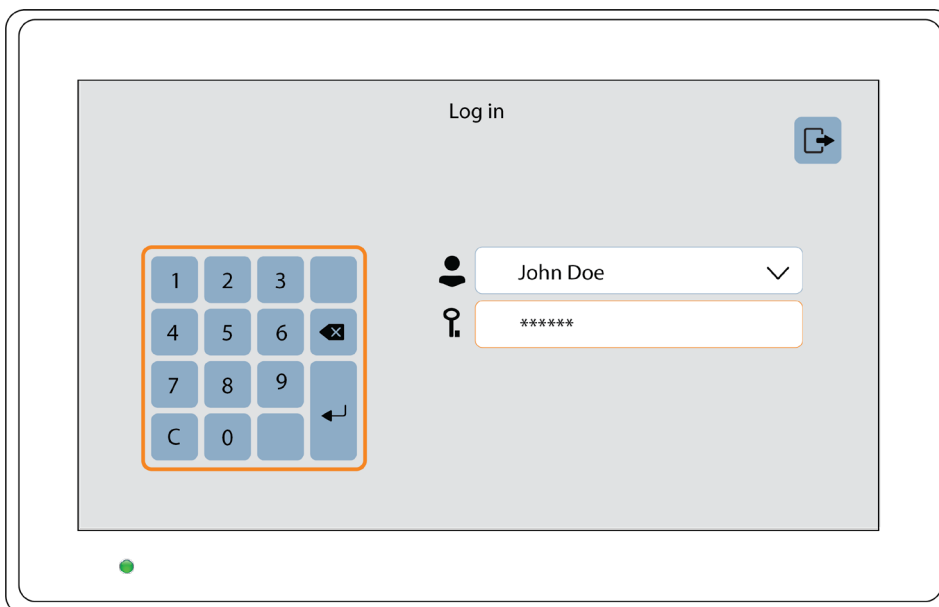

After typing a correct password, a main menu list with the available menus will be displayed.

The cross  will be shown if the password was not correct. Try again.

After three wrong passwords the log in function will be blocked for one hour for the user name respectively.

6.4.1. PASSWORD



Each user has a password for an access level, for example "Building officer" or "Service personnel".

6.4.2. CHANGE OF PASSWORD

The user names and passwords are downloaded / changed via EBLWin and SSD download to the control unit.

If the valid password(s) are unknown, EBLWin must be used to change the password(s).

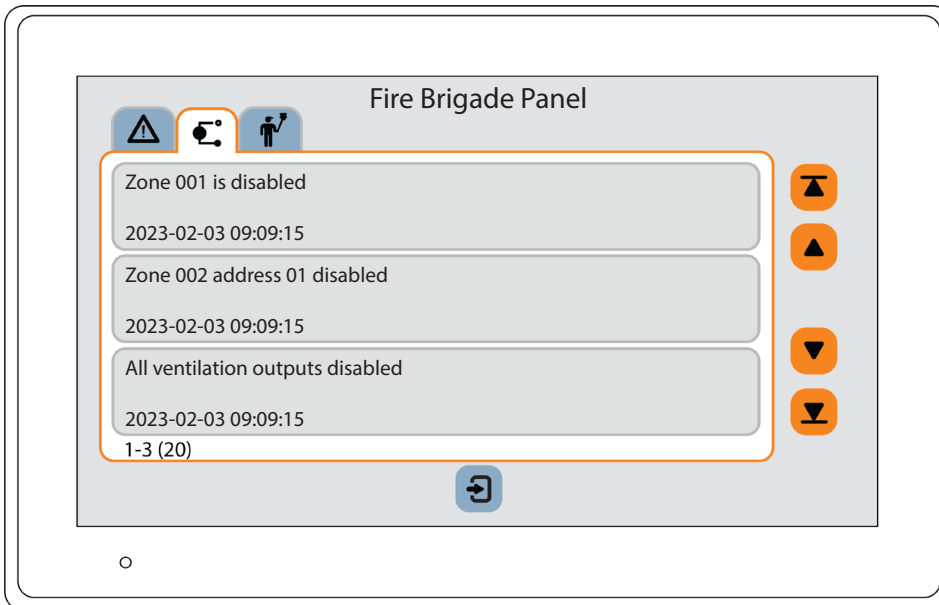

6.5. EVENT TAB PAGE

- The event tab page is only shown when logged out and there are no alarms. In logged in mode, press log out  to access the event tab page.
- In logged out mode, the event tab page will be shown if there are any events in the system.
- A tab will be shown on the event tab page if there are any faults, disablements, or zones in test mode in the system.
- To switch between the tabs, press the tab icon.
- To access the menu system when the event tab page is shown, press  to log in.









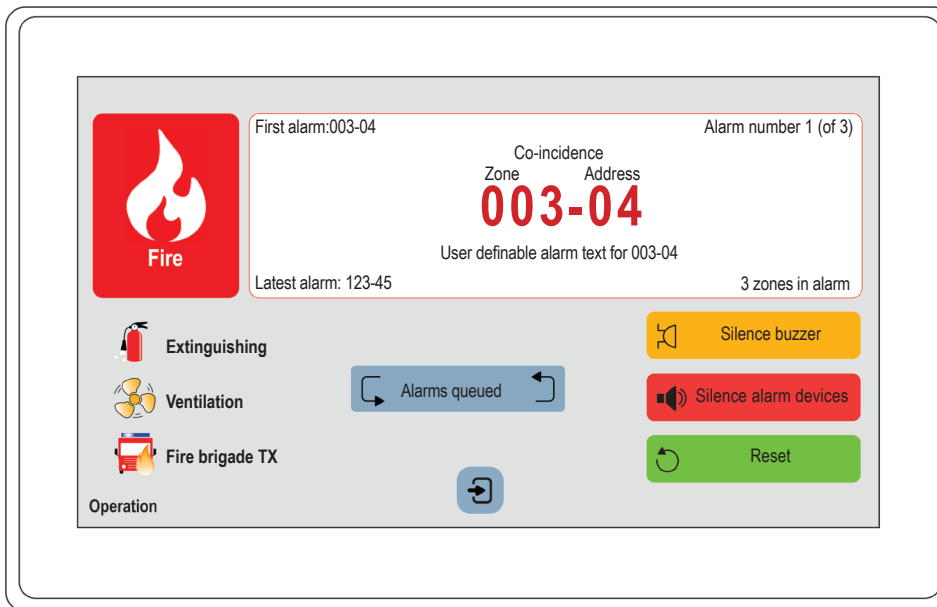





When the event tab page is shown, the screen backlight will go down to 10% after 5 minutes. It will never turn off.



6.6. FIRE ALARM PAGE

- If the system is in alarm state, the screen will be turned on and the alarm page is shown.
- The fire alarm page is only shown when logged out. In logged in mode, press the fire button  or log out  to go to the alarm page. You will be automatically logged out.
- To access the menu system during alarm state, press  to log in. The normal alarm page will be automatically displayed again after the menu system is escaped or 20 seconds after the latest maneuver in the menu system.
- The alarm page has priority over the event tab page.



6.7. NAVIGATION / GENERAL PROCEDURES

- Scroll in the lists with  and , or go directly to the top or bottom of the list with  and .
- Tap on the input field, a numpad will pop up to enter data.
- Press the button  to re-enable a function on one unit or press  to re-enable the function on all units..
- To acknowledge, press .
- A successful operation is indicated by a . It will also be shown in the list.
- A not successful operation is indicated by a .
- To return to the main menu press .
- If the system also is in fire alarm state, the fire button  will be shown. Press the fire button  to go to the fire alarm page.
- To leave the menu system and log out, press log out .

Quick jump can be used within each menu, press the icons in the top left corner    for a quick jump to previous menu.

You will be automatically logged out 15 minutes after the last action, and after 5 seconds when you press log out . A new login is then required.

6.8. MENUS

The following chapters describe the menus in the Fire Brigade Panel and the procedures to use them.







For general information on navigation in the menu system, see section [6.7. NAVIGATION / GENERAL PROCEDURES](#) on page 29.

6.8.1. FAULT

Up to 300 faults can be listed:

- Not corrected (not serviced) and not acknowledged faults (no status information)
- Not corrected (not serviced) but acknowledged faults (/Acknowledged)
- Corrected (serviced) but not acknowledged faults (/Serviced)

- Log in to the display unit.
- Navigate to menu  > .
- Press  or  to scroll in the list. The most recent fault is on top of the list.
- To acknowledge a fault, press . A serviced fault that is acknowledged will disappear from this list.

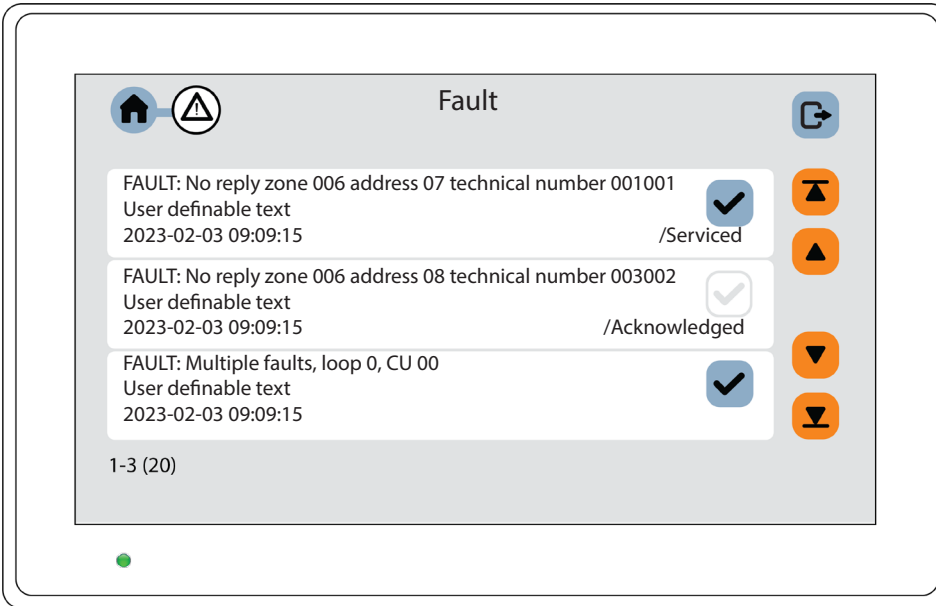

- To exit the menu press .

If there are no events, the list will be empty.

6.8.2. DISABLE

- a) Log in to the display unit.
- b) Navigate to menu . A sub menu list will be displayed.

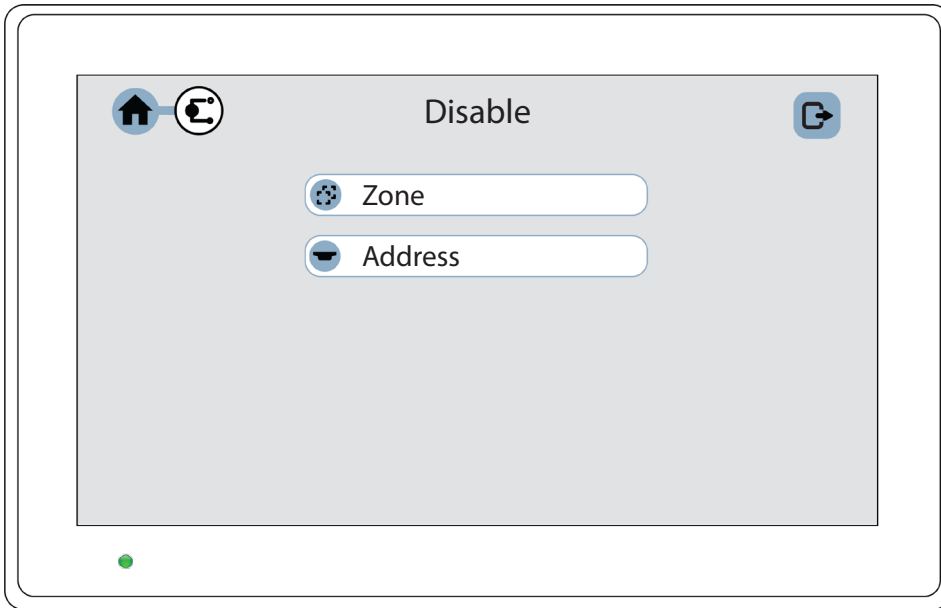

A whole zone, one or more alarm points within a zone and/or control outputs can be disabled. This function can be used for temporary disablement (e.g. craftsmen working in the premises, etc.).

If the function Enhanced disablement is enabled (default), disabled alarm points cannot activate Pre warning, fire alarm and fault. If this function is not enabled (via EBLWin), disabled alarm points cannot activate Pre-warning and fire alarm but fault can be generated. (This is a violation to the EN54-2 standard).

An Addressable manual call point can be disabled (but shall normally not be disabled). When a whole zone is disabled, the addressable manual call points will also be disabled. (This function complies with EN54-2 but can be changed in EBLWin).

All zones can be disabled.

Up to 200 alarm points (zones / address) can be individually disabled. (Alarm points disabled via time channels are not limited and must not be counted!)

Don't forget to re-enable, or use automatic re-enablement for zones and alarm points.

6.8.3. ZONE

When a whole zone is disabled, all alarm points within the zone will be disabled.

DISABLE:

- a) Log in to the display unit.
- b) Navigate to menu > > .
- c) Enter the zone number, one by one or in range.
- d) If "Automatically re-enablement" shall be used, enter time (hh:mm). Default time is 00:00. Automatic re-enablement is indicated with the time.
- e) Press to disable the zone. The zone will appear in the list.

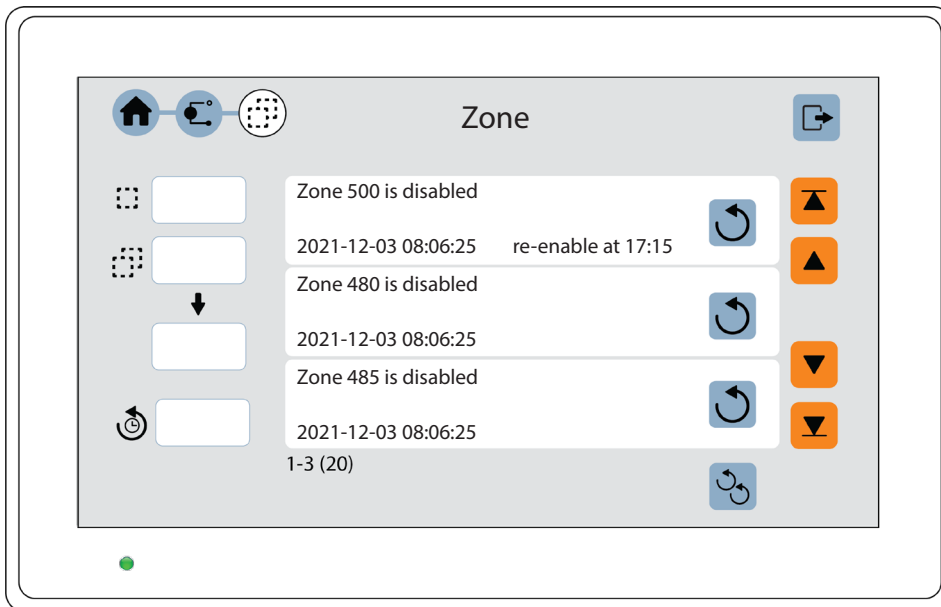

RE-ENABLE:

Press the button to re-enable a zone or to re-enable all zones. Re-enabled zone will disappear from the list.

6.8.4. ADDRESS

All alarm points connected to the COM loop can be individually disabled.

DISABLE:

- Log in to the display unit.
- Navigate to menu > > .
- Enter the zone number and address .
- If "Automatically re-enablement" shall be used, enter time (hh:mm). Default time is 00:00. Automatic re-enablement is indicated with the time.
- If the smoke part of the multidetector shall be disabled, check the check box "Smoke only".
- Press to disable the zone address. The zone address will appear in the list.

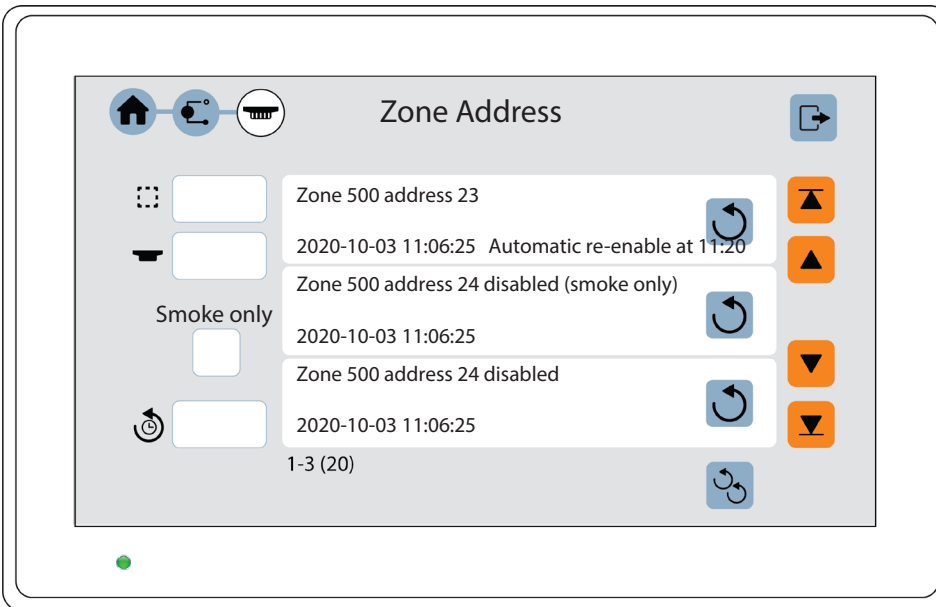

RE-ENABLE:





Press the button to re-enable a zone address or to re-enable all zone addresses. Re-enabled zone address will disappear from the list.

6.8.5. PERFORM ZONE TEST

Normally, zones are tested during the monthly test. Via this menu it is also possible to perform the zone test. Up to 100 zones can be set in test mode. In test mode, only the alarm points are tested.

No outputs (sounders) will be activated during the test.

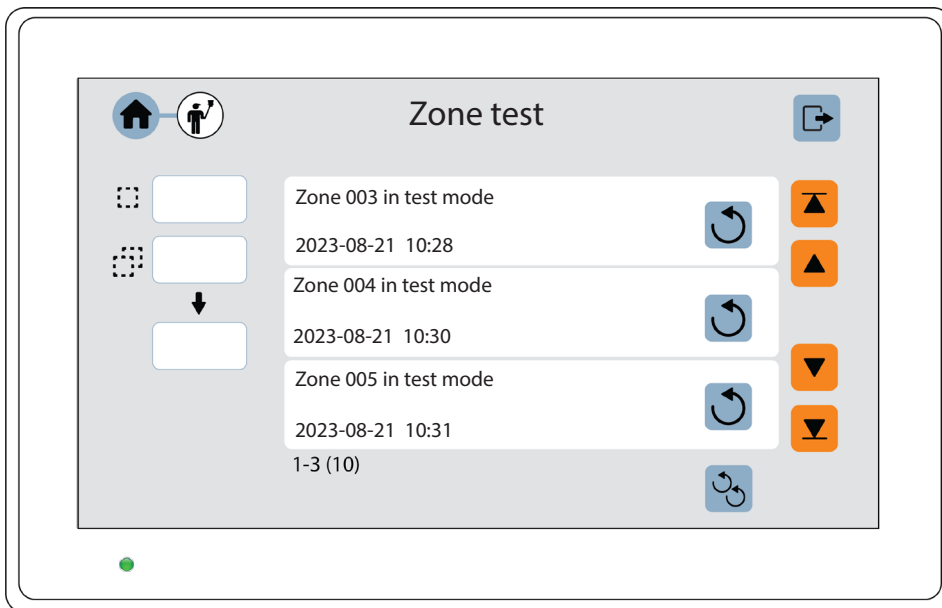

If a real fire alarm is activated by an alarm point not in test mode, the normal fire alarm functions will be activated, which means fire alarm presentation, outputs activated, routing equipment activated, and so on.

- a) Log in to the CIE.
- b) Navigate to menu  > .
- c) Enter the zone number,  one by one or  in range, and press  to start the test. The zone will appear in the list.



The green polling LED in the 440x / 440xl detectors will be turned off in test mode.

END TEST MODE

- d) Press the button  to end the test mode of a zone or  to end test mode of all zones. Zones with ended test mode will disappear from the list. The test mode must be ended for all zones.

7. GENERAL CONTROL PANEL

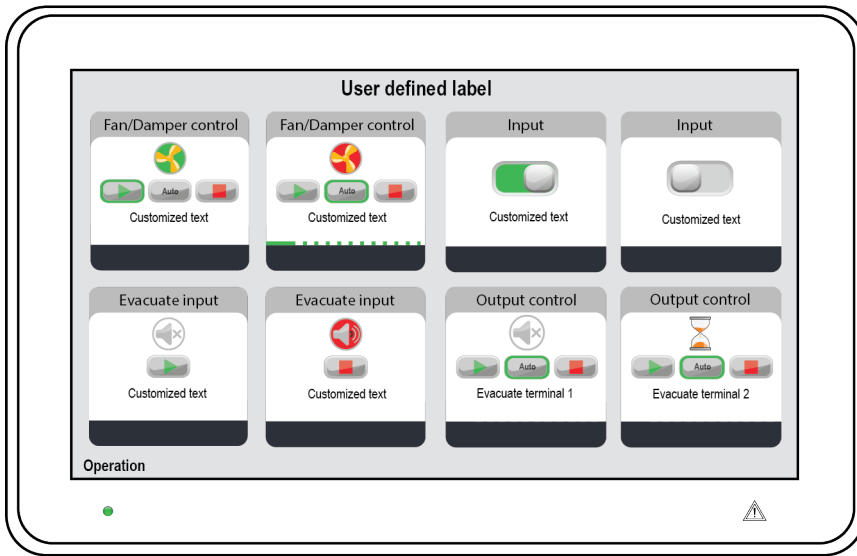

The general control panel has 8 inputs that can be programmed via EBLWin, as one of the following types:

- Input
- Fan/Damper Control
- Evacuate input
- Output Control

Each module can be given a Header text and a custom text.

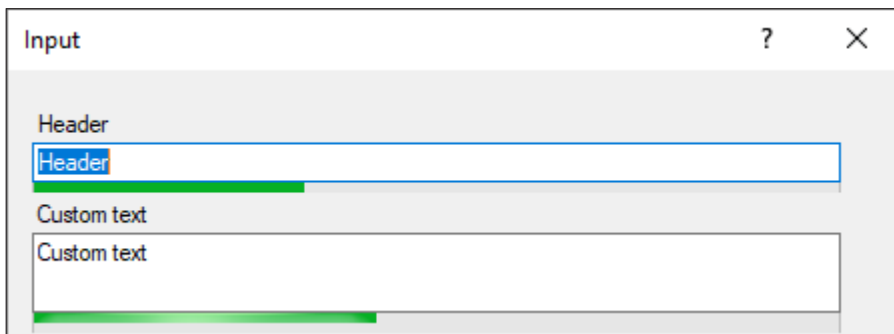

The green bar is indicating the length of the entered text, and a warning will be shown when the text is too wide.

7.1. INPUT

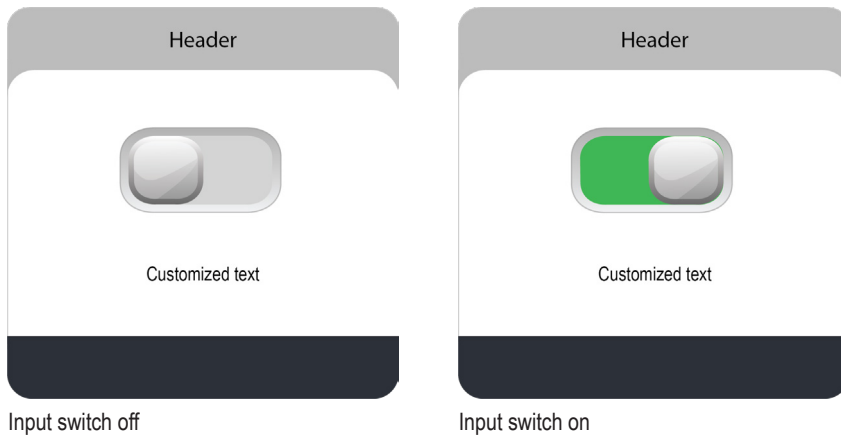

The following programmable input trigger conditions can be used:

- Activate output
- Evacuate
- External time channel
- Technical warning

7.2. FAN/DAMPER CONTROL

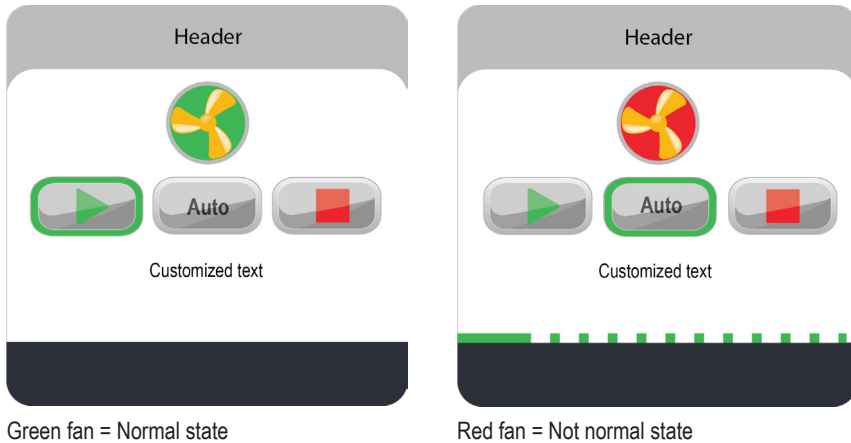

The Fan/Damper Control module has a normal function for a "Supply air fan" or a "Standard fan". There is also an enhanced function for a "Smoke exhaust", "Smoke spill", "Stair pressurization" or a "Supply air" fan. For each module, symbols and buttons are indicating; On / Auto / Off / Running / Stopped / Fault.



When the fan is on it is indicated by a spinning fan symbol. In normal state the fan symbols is green otherwise the fan symbol will change to red, for example:

Smoke exhaust (normally stopped) - The fan symbol will be green and not spinning until the fan is activated, then the fan symbol will change to a red spinning fan.

Supply air fan (normally running) - the fan symbol will be green and spinning until the fan is stopped, then the fan symbol will change to a red not spinning fan.

The fans can be operated in 3 different modes (On, Auto, and Off). On and Off are manually controlled and operates the fan independently of the CIE status. In the Auto mode the fan is operated by the CIE.

Button explanation:

- 
ON This mode means that the fan is on (i.e. the 4461 relay output activated) independent on the CIE status.
- 
AUTO This mode means that the fan status (i.e. the 4461 relay output state) is dependent on the CIE status described in chapter [7.3. APPLICATIONS](#) on page 42.
- 
OFF This mode means that the fan is off (i.e. the 4461 relay output is de-activated) independent on the CIE status.

The symbols are greyed out when not active.

Each Fan/Damper control module controls one fan. The fans are connected to the COM loop via a multipurpose I/O unit 4461 for fan/damper control, one for each fan. 4461 is used for fan activation and feedback signals.

7.2.1. FAULT

Fault  for the fan will be displayed in the lower part of the module.

The fault symbol is displayed when:

- The fan has been activated either via the button On or by the CIE in Auto mode, but the 4461 input has not been activated within 30 seconds after the activation of the 4461 output.
- The fan has been stopped either via the button Off or by the CIE in Auto mode, but the 4461 input has not been de-activated within 30 seconds after the activation of the 4461 output.
- If the monitored 4461 input is used and there is an open circuit fault on the input wires.

7.2.2. PHASE FAULT

Phase fault  for the input will be displayed in the lower part of the module.

The phase fault symbol will be displayed when:

- If only Re0 is used, there will only be "Fault" for not starting.
- If only Re1 is used, there will only be "Fault" for not stopping.
- If both Re0 and Re1 are used, "Fault" for not stopping, Re1, will be prioritized.
- If neither of Re0 and Re1 are used, there will be no "Fault" shown.

An open circuit fault on the input "In0" wires will in all cases display the "Fault" symbol on the Display unit.

The symbol Fault can be displayed in combination with the symbol Running or the symbol Stopped.

7.2.3. FAN CONTROL VIA 4461

The fan is activated via the relay output Re0 on the I/O unit, and the feedback signal is connected to input In0. Input In0 can be programmed as supervised or not supervised in EBLWin. The fault detection time can via EBLWin be set to 30-255 seconds.

The fan control can be **enhanced** or **normal**. Activating enhanced fan control in EBLWin will make it possible to program Re1.

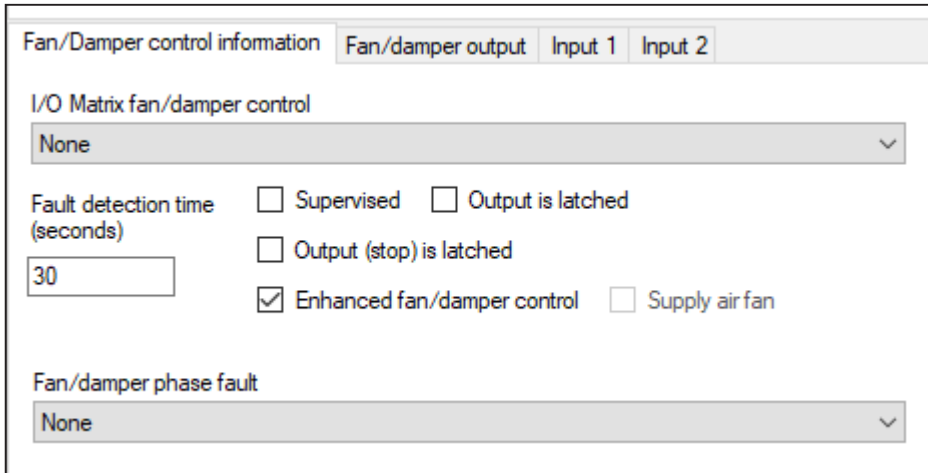

Re0 or Re0 (start) and Re1 (stop) can be programmed in EBLWin to be latched, meaning it will not be reset until the Reset button on the fan control panel front is pressed.

Re0 and Re1 can be programmed as Normally Open (NO) or Normally Closed (NC) via EBLWin.

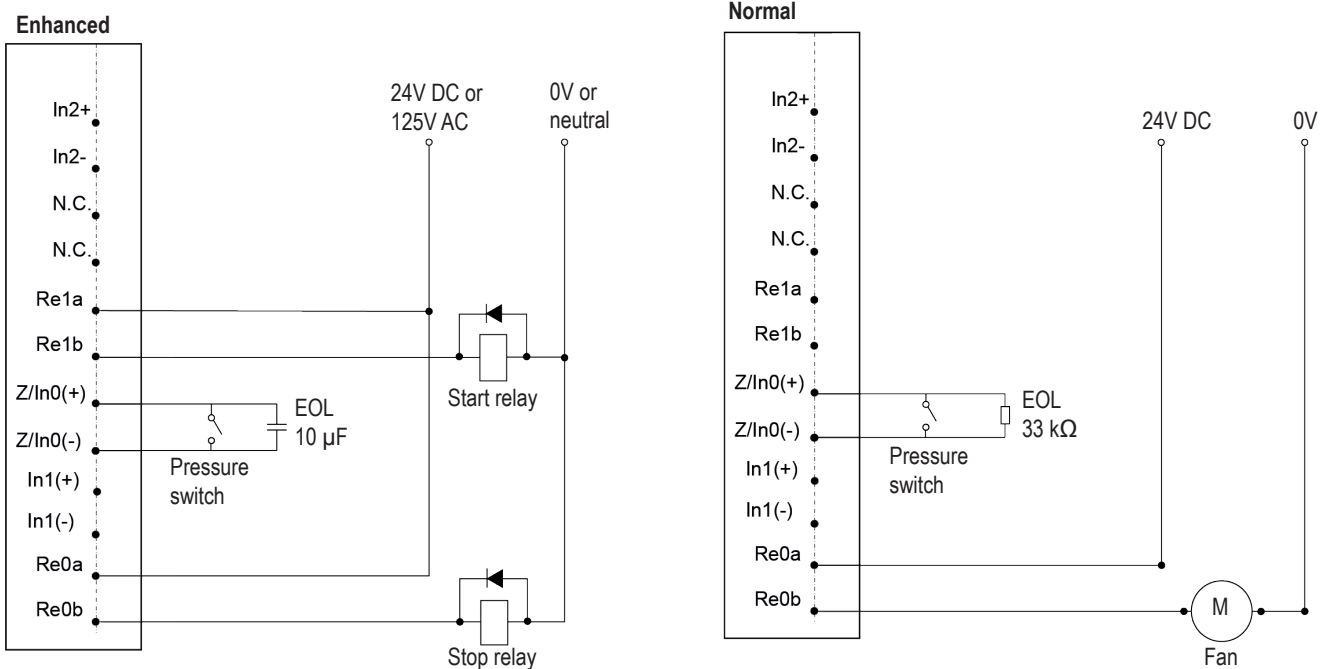

TEST APPLICATION FOR ENHANCED FAN CONTROL

The following figure is an example of how the Mechanical service switch board (MSSB) contacts might be used for testing of the fan control function. (Enhanced fan control).

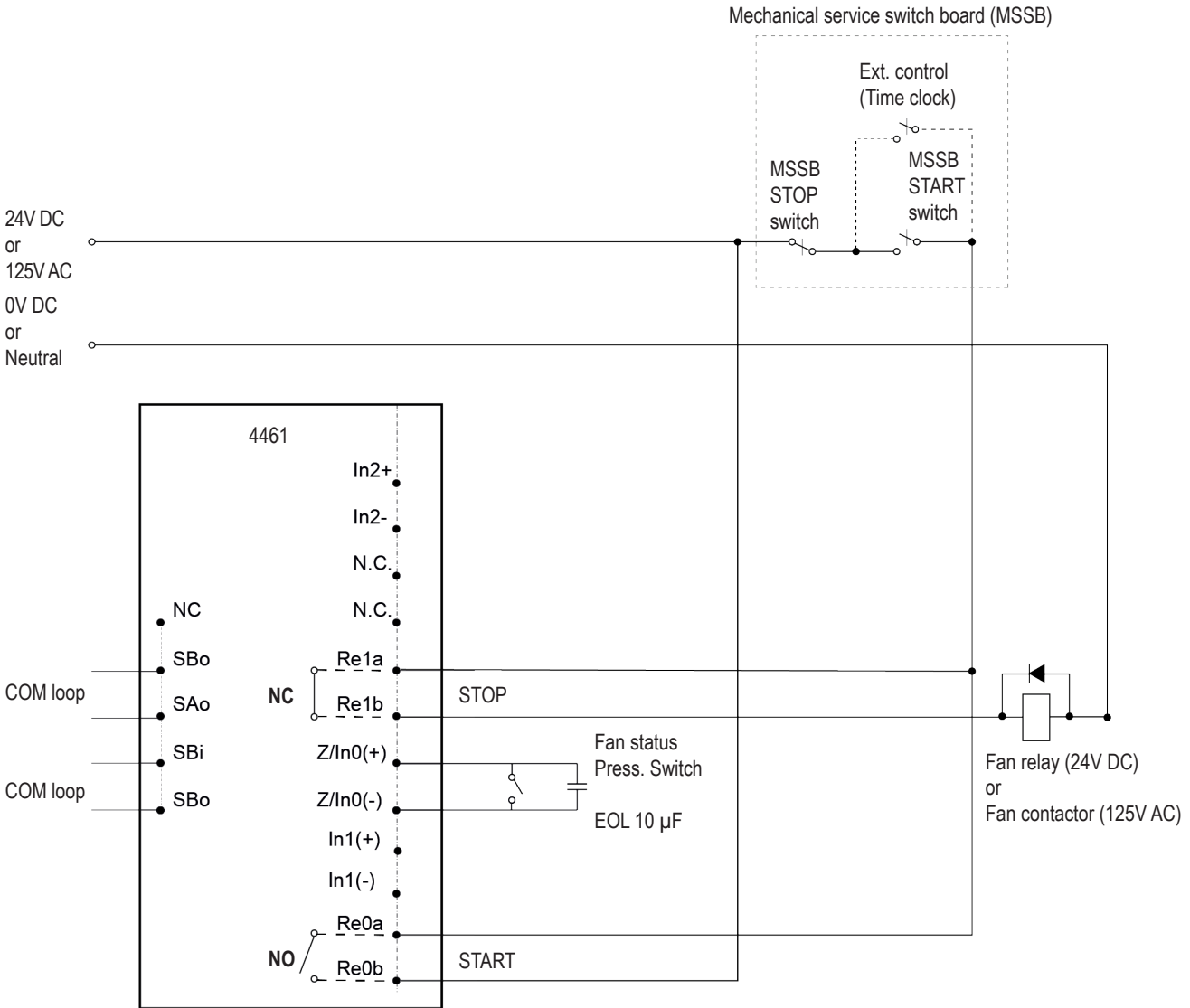

*The monitored input "In0" is only in use when START and STOP is operated by the CIE and not when START and STOP is operated by the MSSB.
 The LED "Fault" on the control panel will be turned on 30-255 seconds (programmable) after STOP or START, if the fans status at that time is not correct.
 An open circuit fault on the input "In0" wires will always show the symbol "Fault" on the Display unit.*

7.3. APPLICATIONS

The fan control panel can be used for Supply air fans (normally ON) and/or Smoke exhaust, smoke spill and Stairs pressurization fans (normally OFF).

7.3.1. SUPPLY AIR FAN

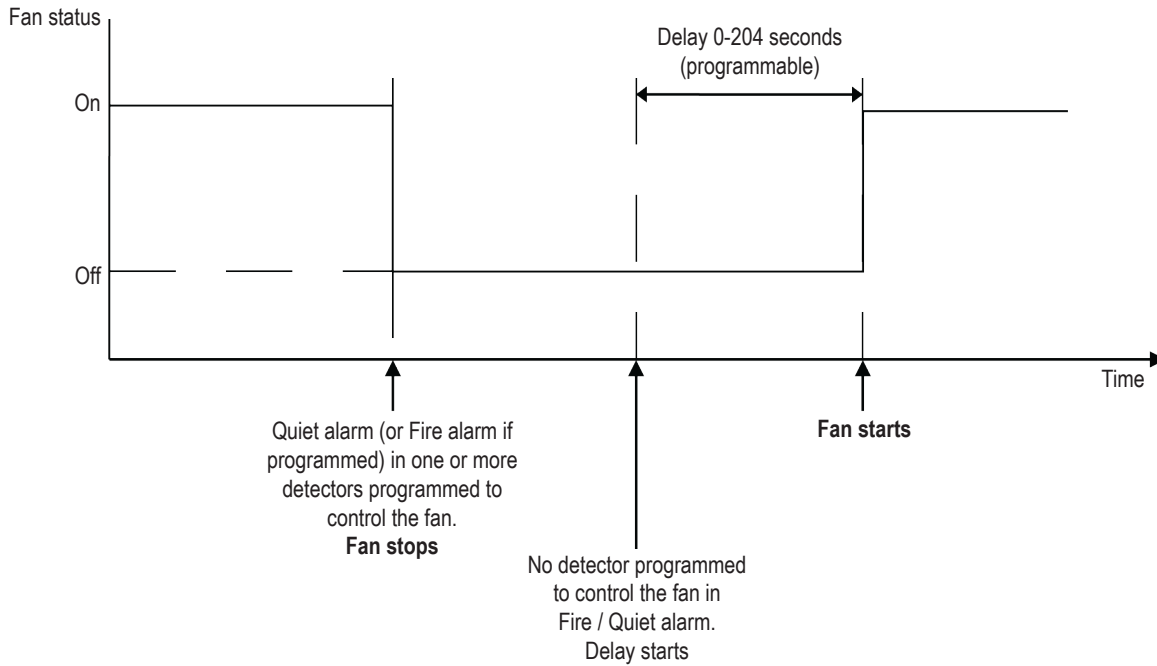

Relay output with delayed de-activation after reset of Fire/ Quiet alarm can be used. If any detector, programmed to control the fan, during the delay returns to Fire / Quiet alarm, the fan continues to be off until no detector is in Fire / Quiet alarm and a new delay starts.

QUIET ALARM

Quiet alarm is presented in the CIE as Quiet alarm, the buzzer sounds (0.8 / 5s) and outputs programmed for quiet alarm are activated. No other outputs will be activated. Quiet alarms are non-latching (but the relay output can be latched).

DETECTOR TYPE

Only analog addressable smoke detectors can be used for this function. One or several detectors can be programmed to control the fan.

7.3.2. SMOKE EXHAUST, SMOKE SPILL, AND STAIRS PRESSURISATION FANS

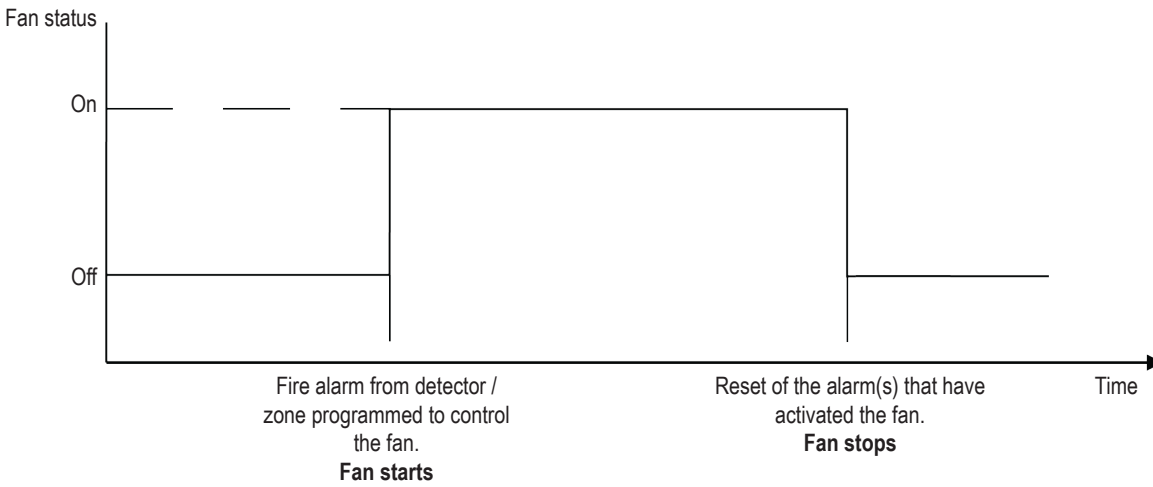

DETECTOR TYPE

Both analog addressable smoke detectors and conventional zones can be programmed to control the fan.

7.3.3. CONFIGURATION IN EBLWIN

a) Add a Fan/Damper input

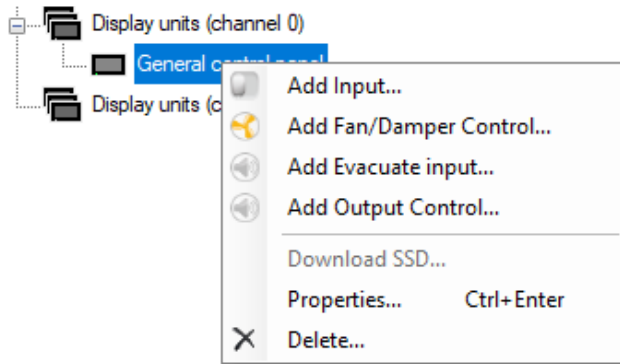

b) Add one 4461 for each Fan/Damper Control input.

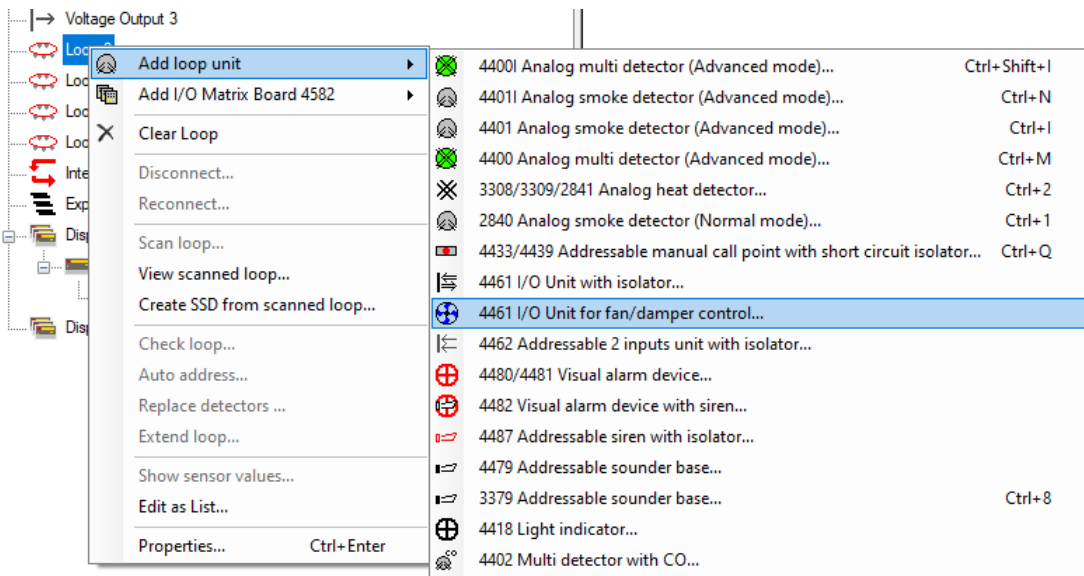

c) In the “4461 I/O unit for fan/damper control”. dialog box, connect the 4461 to the Fan/Damper Control input.

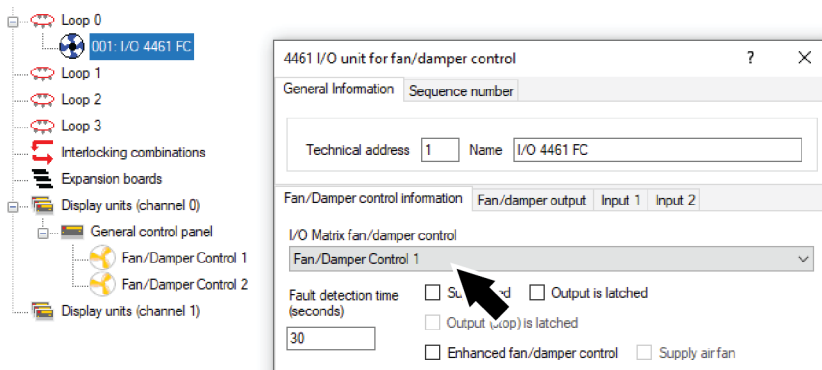

- d) In the “4461 I/O unit for fan/damper control”. dialog box, configure:
- Technical address (COM loop address 1-253)
 - Name (Fan control I/O unit - normally not changed)
 - Fan control information
 - I/O Matrix fan control. Select by its customized name.
 - Supervised or not supervised (Input In0)
 - Output latched or not latched
 - Enhanced fan/damper control function or not.
 - Fault detection time (Input In0; 30-255 seconds)
 - Properties for Re0, like any programmable output.
 - If Enhanced fan control is selected, properties for Re1.
 - Normally open or Normally closed

4461 I/O unit for fan/damper control

General Information Sequence number

Technical address 1 Name I/O 4461 FC

Fan/Damper control information Fan/damper output Input 1 Input 2

I/O Matrix fan/damper control
Fan/Damper Control 1

Fault detection time (seconds) 30

Supervised Output is latched
 Output (stop) is latched
 Enhanced fan/damper control Supply air fan

Fan/damper phase fault
None

OK Cancel Apply Add...

7.4. EVACUATE INPUT

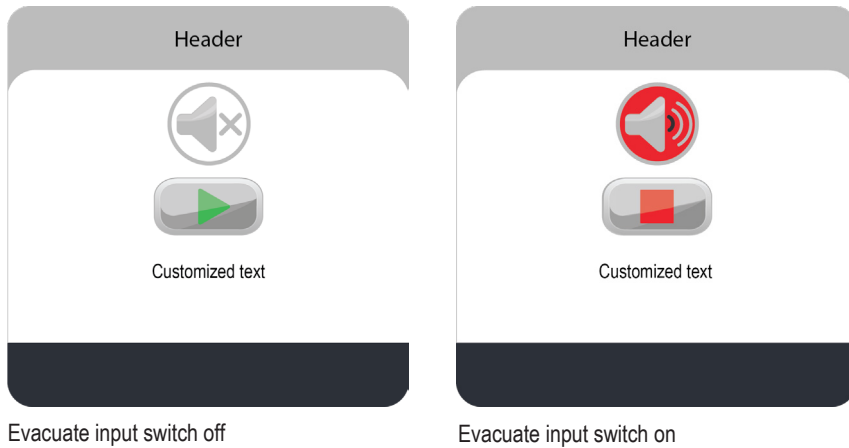

The evacuate input can be used to manually activate the siren to start evacuate zones or the whole building.

The following programmable input trigger conditions can be used:

- Evacuate
- External time channel
- Technical warning

7.5. OUTPUT CONTROL

For more information about control groups, see Planning Instruction.



The output control can be used to avoid unnecessary activation of a control group and/or to manually activate and de-activate a control group. The output control can be programmed with an investigation time, to allow time to investigate the triggered control group before it escalates to activation of the control group.

The output control function is programmed in EBLWin, and the actual outputs must be programmed with control groups.

Acknowledge time and investigation time is set for each output control in EBLWin. The acknowledge time can be set to 0-120 seconds and the investigation time can be set to 0-9 minutes.

The output control has to be acknowledged within an acknowledge time. If the output control is not acknowledged within the acknowledge time, the control group will be activated.

When the output control is acknowledged the investigation time starts. If no action is done before the investigation time expires, the control group will be activated.

At any time it is possible to manually activate the control group by pressing the ON button, or if the OFF button is pressed the control group will be deactivated and be prevented from further activation.

The output control can be operated in 3 different modes (On, Auto, and Off). On and Off are manually controlled and operates the control group independently of the CIE status. In the Auto mode the control group is operated by the CIE.

Button explanation:



ON

Manually turn on the control group

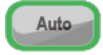

AUTO

This mode means that the control group is controlled by its control expression.



OFF

Manually turn off the control group



ACKNOWLEDGE

Visible when there are un-acknowledged control groups. The Acknowledge button can be used to start the investigation time.



CONTROL GROUPS OFF

Normal mode - No control groups activated



CONTROL GROUPS ON

Activated mode - Control groups are activated

The buttons outline border is green when the button is activated / pressed.

Default operating mode after restart of the CIE is auto. Apart from that the operating mode never changes automatically.

7.5.1. CONFIGURATION IN EBLWIN

- a) Create the control groups needed for the Output control function, via menu **System / Control groups**. Add a combination of control expressions to the control group. Check the combination before saving.

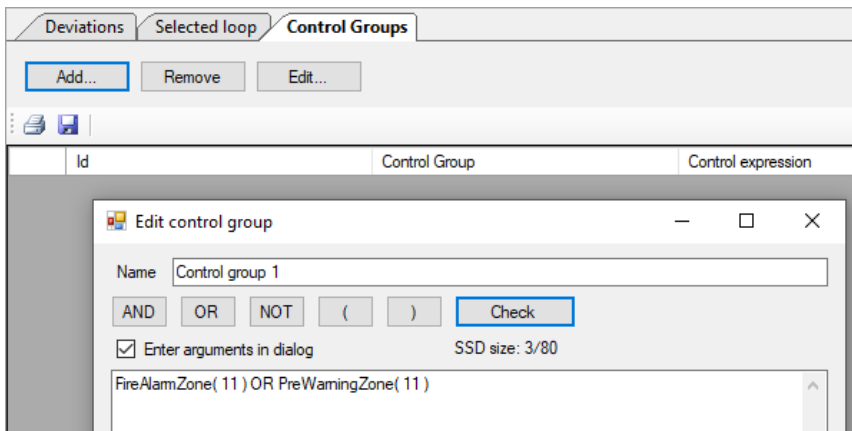

- b) Add an Output control to the General control panel.

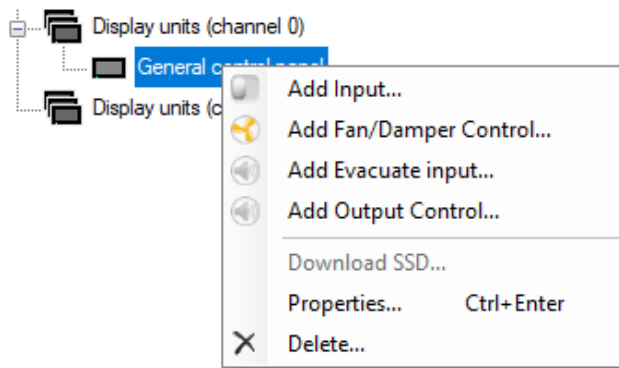

- c) In the "Output Control". dialog box, connect the output control to the created control group.

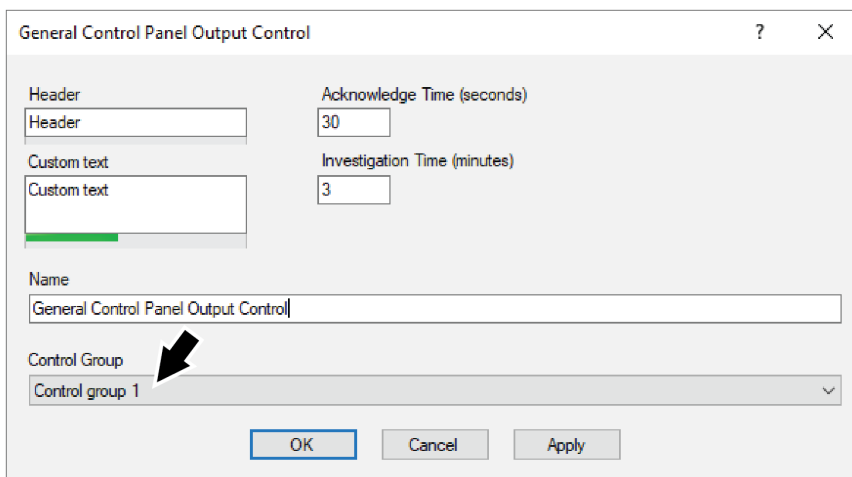

- d) In the "Output Control" dialog box, also configure:
- Header
 - Custom text
 - Acknowledge time (0-120 seconds)
 - Investigation time (0-9 minutes)
 - Name (shown in EBLWin tree view)

8. SERVICE MENU

A new display unit has no unit type, address, or language selected, it is factory set to "Not selected". When the display unit is powered for the first time it will automatically show the service menu.

To save the settings made in the service menu, press the Save & restart button .

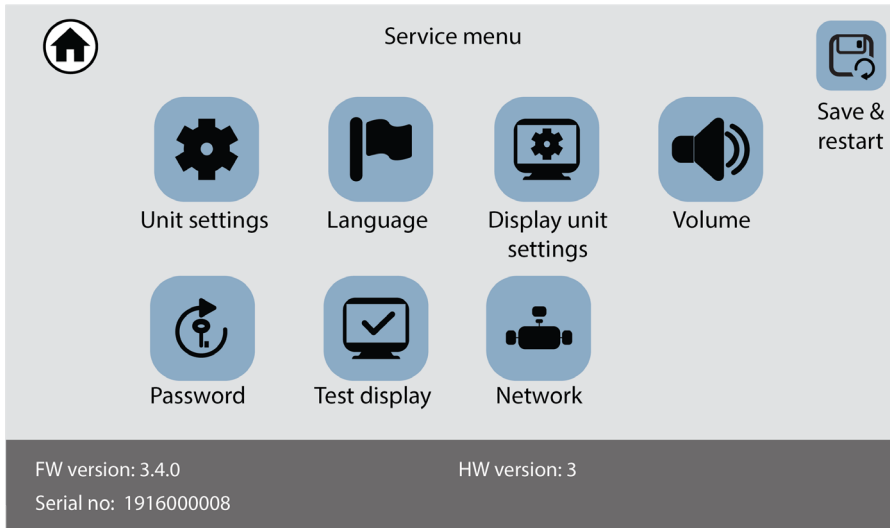

For a display unit in operation, the service menu can be opened via the jumper "J4" in the unit. Remove the two screws (Torx T10) at the bottom of the display unit to open the unit.

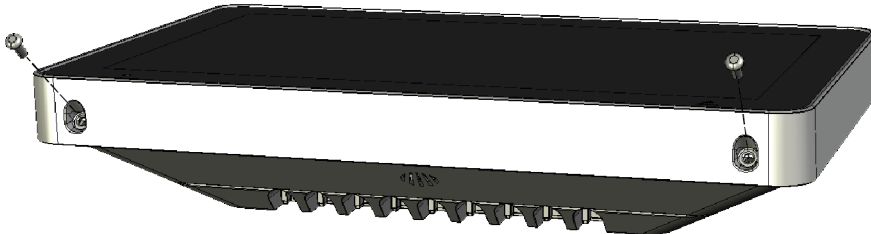



The screws are mounted at a 45 degree angle.

The service menu can also be opened via menu "Active address setting mode for DU" in the CIE, see Operating instructions for the CIE.

8.1. UNIT SETTINGS

The unit shall have a unique address on the RS485 line. The address can be set to **00-29** (Default is "00".)

- a) Set the address with the numpad, and press .
- b) Select unit type in the drop-down list. The unit type can be changed to one of the following:
 - Fire brigade panel
 - Alert annunciation unit
 - External presentation unit
 - General control panel
- c) Press home  to return to the service menu.

8.2. LANGUAGE

You can set the language used on the LCD.

- a) Select the wanted language.
- b) Press home  to return to the service menu.

If a language in the list is not available, English will be chosen as default.

8.3. DISPLAY UNIT SETTINGS

The screen brightness is default set to 50%. The brightness may need to be changed due to the lighting conditions.

- a) Drag the thumb on the slider to change the brightness level.
- b) Press home  to return to the service menu.



8.4. VOLUME

You can set the volume for the buzzer and the sound for when a button is pressed.

- a) Drag the thumb on the slider to change the volume.
- b) Press home  to return to the service menu.

8.5. PASSWORD

An authorization code can be set which gives access to silence alarm devices and to reset fire alarms. The code is default set to **0000** = no code is required. The current code is shown in the top field.

- a) Enter the authorization code and press . The digits are replaced with * in the display.
- b) Press home  to return to the service menu.

8.6. TEST DISPLAY

You can check your LCD for defective pixels, that are not working as expected.

Pick a colour from the list to test. The screen is filled with the test colour, and makes it possible for you to find pixels that fail to show the selected colour.

Pixels are very small so you have to look carefully.

8.7. NETWORK

Network menu will show basic system information like device name, IP address, etc.

9. SELECTIVE ALARM PRESENTATION

Normally all fire alarms will be presented in the CIE and the display unit. It is possible to select which alarms that shall be presented in the display unit. For example if there are many buildings in an installation, the units in one specific building shall only present alarms activated within this building.

The following operands are available:

- Control unit (**CU**)
- Consecutive control units (**CU1, CU2**)
- Zone (zone)
- Consecutive zone (**zone1, zone2**)
- Zone – address (**zone, addr**)
- Consecutive zone – address (**zone1, addr1, zone2, addr2**)

Up to 50 operands can be used to make a selector for an display unit.

Example: Control unit (00), Consecutive zones (100, 500), Zone – address (900, 01).

In this unit will only be presented alarms that origin from the CIE no. 00, from the zone 100-500, or from the alarm point 900-01.

Default programming in system EBL512 G3 is: **Control units (00, 29)**. All alarms from all CIE:s will be presented in all display units.

The programming is done via EBLWin.

10. USER DEFINABLE TEXT MESSAGES

The user definable text messages (alarm texts) are depending on which unit type the display unit is running in. Each alarm text (up to 40 alphanumeric characters) will be shown on the second row. The texts are created and downloaded via EBLWin.

In the CIE, each alarm point (zone – address) and each zone can have an individual user definable text message (alarm text) presented in the display unit by fire alarm; see the Planning and Operating Instructions for the system respectively.

The alarm texts shown in the CIE will also be sent to each display unit and shown in its display.

Text messages for all or selected alarm points / zones can also be stored in each display unit. These alarm texts will be shown instead of the alarm texts sent out from the CIE. 617 unique user definable texts can be programmed in the memory for each unit. If a word or a whole sentence is reused in another “alarm text”, more than 617 user definable texts can be added to the memory.

The priority order of the alarm texts is as follows:

1. Point alarm text stored in the display unit.
2. Text sent out from the CIE.

When alarm texts shall be stored in all or in some display units, the unique alarm texts are created in EBLWin and downloaded when the CIE. SSD is downloaded.

It is also possible to select which fire alarms that shall be presented in the display unit respectively, see [chapter 9. SELECTIVE ALARM PRESENTATION](#) on page 52.

11. FAULT MESSAGES IN THE DISPLAY UNIT

"No contact with control unit"

The contact with the CIE is interrupted for > 45 sec. This fault is also indicated by LED.

- Check the cable, all connections.
- Is a correct / complete SSD download (via EBLWin) performed?
- Check the address and SW mode settings in the display unit.

"SSD Download in progress. Unit will restart when done."

SSD download is in progress.

"SSD download Memory OK."

Download is completed.

"SSD Download Memory OK, but checksum in FLASH is corrupt."

Download is completed, but there is a checksum fault in FLASH . Try to download again, see [13.2. FIRMWARE DOWNLOAD](#) on page 58.

"SSD Download Memory Fault."

Something went wrong during the download, or the wrong file was downloaded.

The first time you download an SSD to 5054, or if an updated default image is to be downloaded to the display unit, the check box 'Download display unit image' must be selected.

Try to download again, see [13.2. FIRMWARE DOWNLOAD](#) on page 58.

"Restarting unit..."

Download is completed and the unit will restart.

12. IP CAMERA AND DRAWING

In EBL Graphics it is possible to connect an IP camera and / or overview drawing to one or several alarm points. The camera picture and the drawing is sent to the display unit over TCP/IP, by using EBL Service.

For information on configuration data, contact the site system administrator.

INFORMATION  – Visible when the selected alarm point, in fire alarm state, is connected to a system overview drawing.

IP CAMERA  – Visible when the selected alarm point, in fire alarm state, is connected to an IP camera.

When a fire alarm occur, the alarms are presented in a list on the display unit. The buttons will be shown if there is an IP camera or overview drawing connected to the selected alarm point.

- Select an alarm in the alarm list.
- Press the camera button or the information button to open a pop-up window.
- Press anywhere on the window to close.

A new fire alarm has higher priority and will be displayed instead of the camera window or the information window.

When all fire alarms in the system are reset, the pop-up window will be closed.

12.1. EBL GRAPHICS

An EBL Graphics project need to be created to connect the IP cameras to the alarm points.

- Create a new project in EBL Graphics.
- Add the IP cameras.
- Connect the IP camera to the alarm points.
- Save and close the project.
- Copy the entire root folder to the C drive on the PC where EBL Service will be installed.

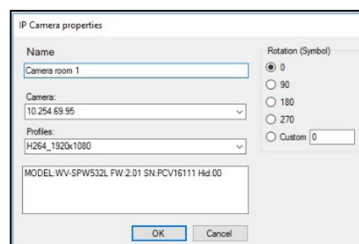
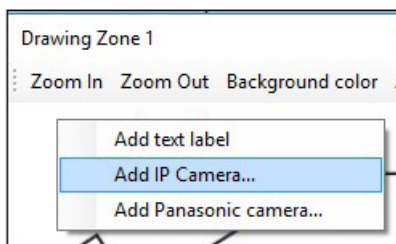

12.2. EBL SERVICE

EBL Service can be downloaded from www.panasonic-fire-security.com.

EBL Service is dependent on Visual Studio 2015 run-time components (both x64 and x86 versions). These can be downloaded from <https://www.microsoft.com/en-us/download/details.aspx?id=48145>.

The settings are saved in the 'Panasonic Fire And Security' folder. The user account that the EBL Service is running under must have at least read access to the folder where the EBL Graphics configuration is located".

- a) Install EBL Service.
- b) Make sure you are logged on as System Administrator on the computer.
- c) Go to Start menu / Configure EBL Service.
- d) Browse for the EBL Graphics XML-file folder.
- e) Enter the IP address of the PC.
- f) Enter the port number.
- g) Enter the Master key created in EBL Graphics.

- h) Click Save and close.
- i) Open the Windows Control Panel / Administrator Tool / Service.
- j) Select EBL Service and click Start.

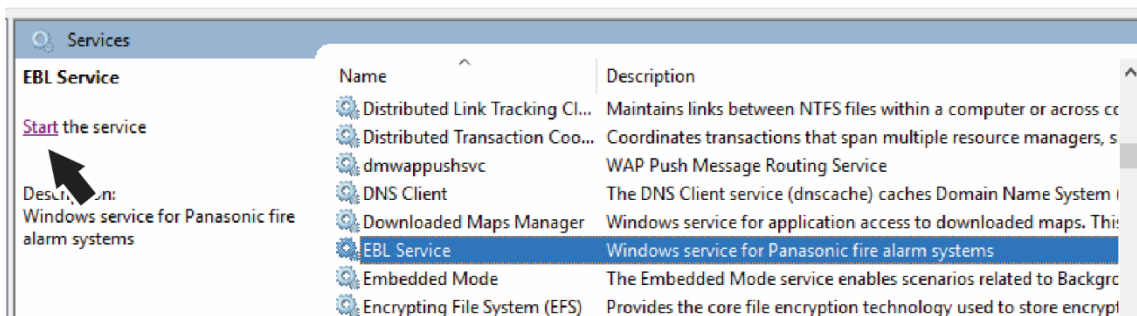

The IP address of the PC with EBL Service installed also need to be set in EBLWin.

- k) Open the Display unit 5054 properties window in EBLWin
- l) Enter the Server IP address and Server port.
- m) If a static IP number (not DHCP) shall be used the following data have to be specified:
 - IP address (for display unit)
 - Netmask
 - Gateway

Display unit 5054 properties

General Information

Technical address Name

Fire brigade panel
 Buzzer disabled
 FBP Printer
 External power supply

Selective alarm presentation

Control Unit
 Zone
 Zone-address
 Consecutive control units
 Consecutive zones
 Consecutive zone-addresses
 Key cabinet

Control units 00 - 29

IP address settings

Use DHCP

Device name Server IP address

IP address Netmask Server port

Gateway

13. FIRMWARE

The firmware is stored in a flash memory in each display unit. The firmware can be downloaded from EBL Firmware Manager, which is opened through the menu in EBLWin.

EBL Firmware Manager program is installed separately, and is available in different versions, see Technical description MEW02584. The procedures below describes the EBL Firmware manager version 1.3.3.

The "USB driver for 5054 and EBLOne" must be installed on your computer before using the EBL Firmware manager. The driver can be downloaded from www.panasonic-fire-security.com.

13.1. VERSION

The firmware version is shown in the service menu in the display unit.

All units connected to the same RS485 line must have the same firmware version, for example. 3.0.x and 3.0.x respectively.

It is highly recommended to have the same versions in all the display units in the system.

13.2. FIRMWARE DOWNLOAD

The display unit is equipped with an USB, which makes it possible to connect a PC and carry out the downloading directly to the unit.

- a) Prepare the PC and start EBLWin.
- b) Connect the PC to the display unit via USB.
- c) In EBLWin, click **Tool / Download software** to open the EBL Firmware Manager.
- d) Select the EBLOne / Display unit (5054) v. ≥ 3.4 tab.

- e) Browse to the firmware file to be downloaded, DU5054_x.x.x.bin.
- f) Select COM port.
- g) Click **Download** to start the download. When the download is ready the display unit will restart.

If something unforeseen happens and the display unit cannot be restarted, it can be forced into boot mode, see [13.2.1. DOWNLOAD FIRMWARE WITH MANUAL BOOT MODE on page 59](#).

13.2.1. DOWNLOAD FIRMWARE WITH MANUAL BOOT MODE

If the display unit cannot be restarted, it can be forced into boot mode to be able to download new firmware. The "USB driver for 5054 and EBLOne" is needed for downloading when the unit is in boot mode. Make sure you have the driver installed on your computer before you open EBL Firmware Manager. If the driver is missing when downloading firmware, the following fault message will be shown:

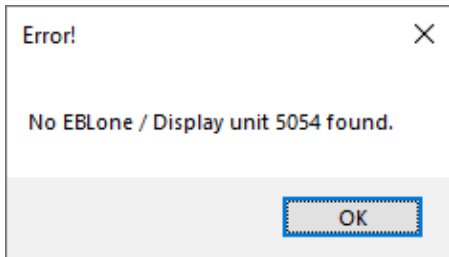

- a) Short the BOOT jumper.
- b) Make a restart, by momentarily shunting RESET jumper.
- c) Remove BOOT jumper.
- d) Check the checkbox 'Boot mode (Manual)' and click Refresh.
- e) Select the unit in the USB device dropdown.
- f) Click **Download** to start the download.

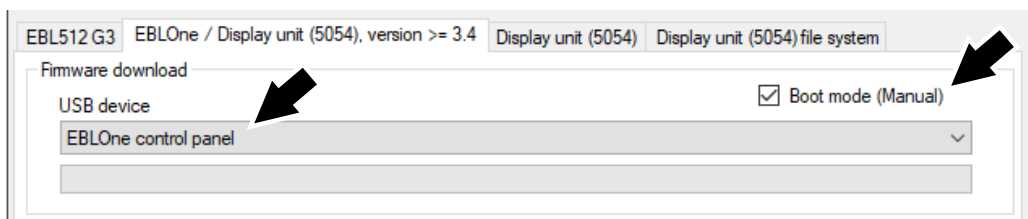

- g) When the download of the internal memory is finished and the unit has started up the following dialog is shown:

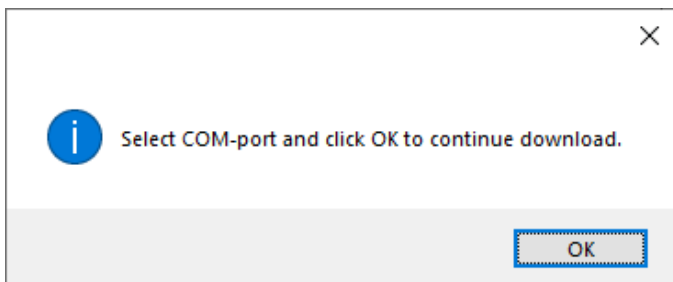

- h) Select the COM-port and click **OK**. The download will now continue.

Check in Control Panel / Device Manager / Ports (COM & LPT) | USB Serial Device (COMx).

14. MOUNTING

The display unit must be mounted on the wall. Screws for wall mounting are not supplied.

- a) Remove the two screws (Torx T10) at the bottom of the display unit and open it.

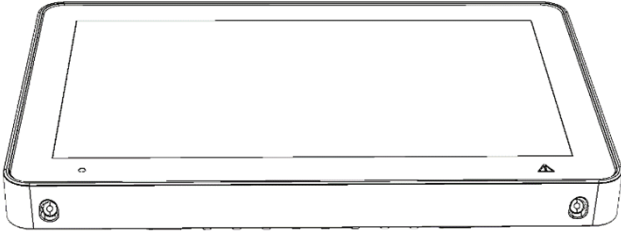

- b) Disconnect the loudspeaker cable, and remove the terminal J5 and J6 from the P.C.B., see arrows below.

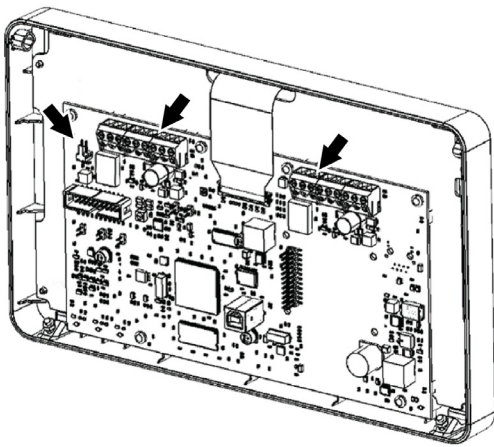

- c) Cut out the required number of knockouts, into the top, bottom, or from behind.

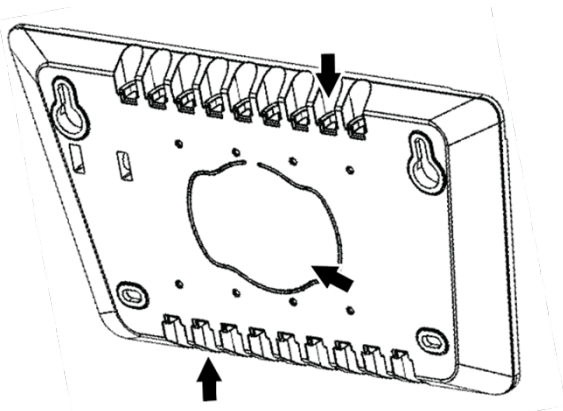

- d) Enter the cables into the box.

As long cable as possible is desirable when entering from above. Move the ground bar plate to the lower position when entering from above.

- e) Mount the box on the wall, see [14.2. DRILL MEASURE](#) on page 64.

Use the internal level vial to make sure the display unit is levelled.

- f) Remove the insulating cover on the cables. The remaining strip of the shield shall be about 15 mm.
- g) Bend the shield backwards over the insulating cover.

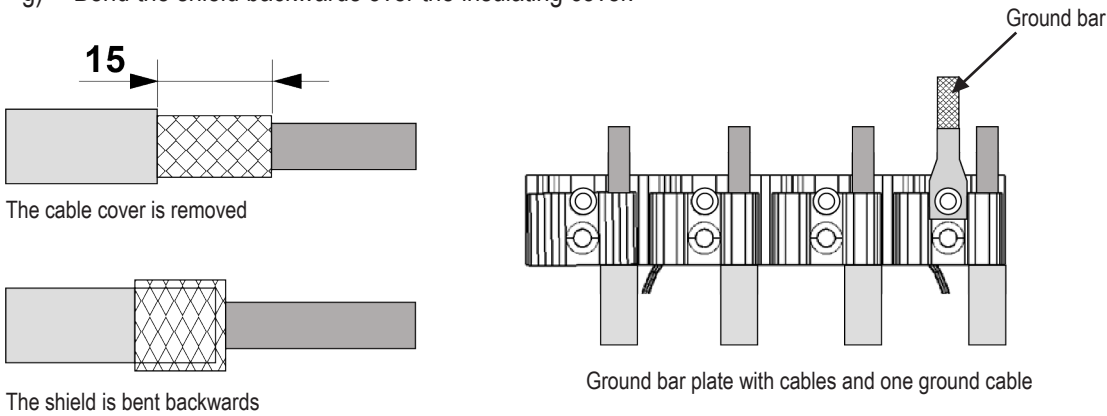

(Measure in mm)

- h) Clamp the cables on the ground bar plate. In order not to cause a short circuit, do not let the sprawl outside the cable fixing clamp.

The ground bar plate is reversible to fit all cable thicknesses.

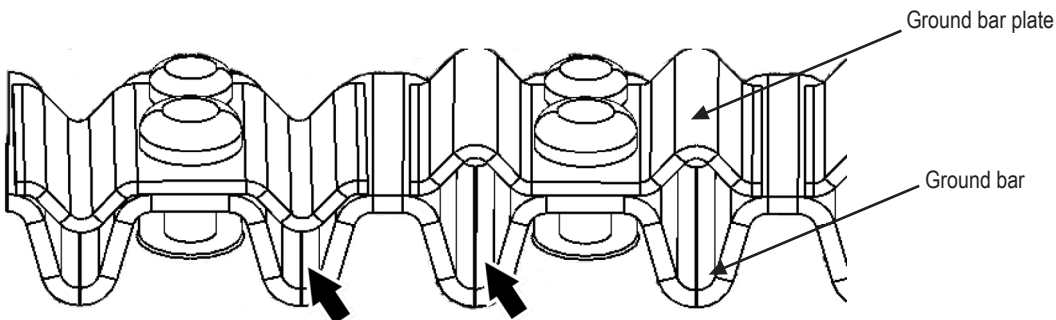

- i) Connect the two ground cables to the ground bar plate.
- j) Reconnect the terminal J5 and J6 to the P.C.B.
- k) Reconnect the loudspeaker cable.
- l) Assemble the front of the display unit with the two screws. Be careful not to pinch any cables.

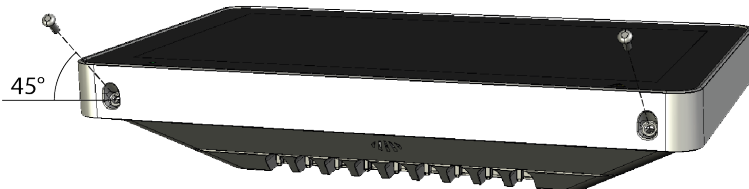

The screws are mounted at a 45 degree angle.

- m) Connect the cables to the terminal block J1 in the CIE.

14.1. MOUNTING IN DISPLAY UNIT METAL CABINET

The display unit can be mounted in the display unit metal cabinet 5055.

- a) Remove the two screws (Torx T10) at the bottom of the display unit and open it.

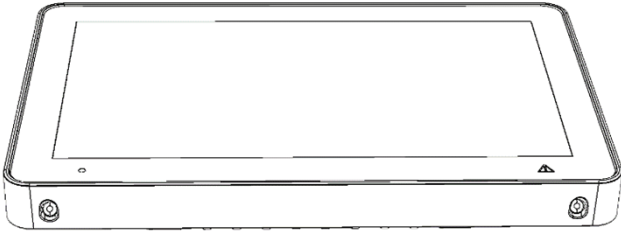

- b) Remove the four screws (Torx T10) and remove the back cover.

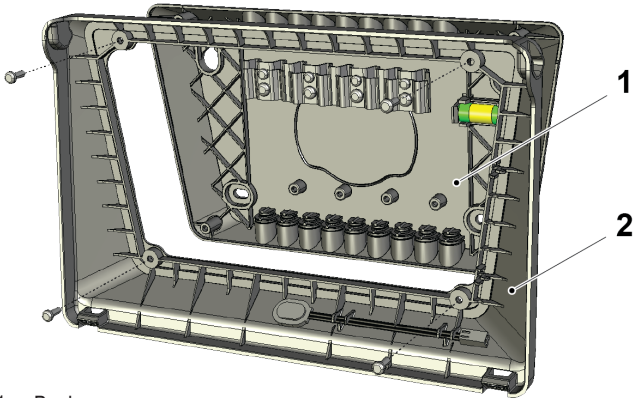

1. Back cover
2. Frame back

- c) Mount the frame back inside the cabinet.
d) Remove the ground bar plate from the back cover and mount it inside the cabinet. Use the screws enclosed with the cabinet.
e) Remove the ground cable and replace it with the longer ground cable supplied with the cabinet.

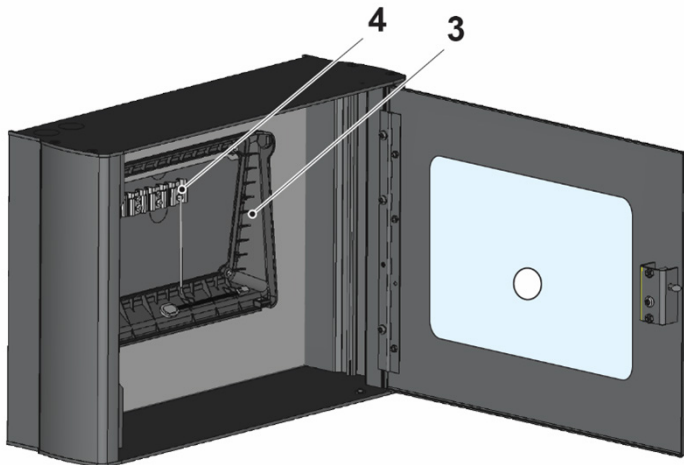

3. Frame back
4. Ground bar plate

- f) The cabinet has several knock-outs for cable inlets, four knock-outs on the top, bottom, and back. Four compression glands are supplied with the cabinet.
- g) Pull the cables through the inlets, and clamp the cables on the ground bar plate.
- h) Assemble the front of the display unit with the two screws.

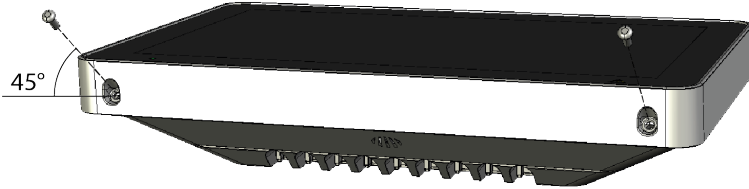

The screws are mounted at a 45 degree angle.

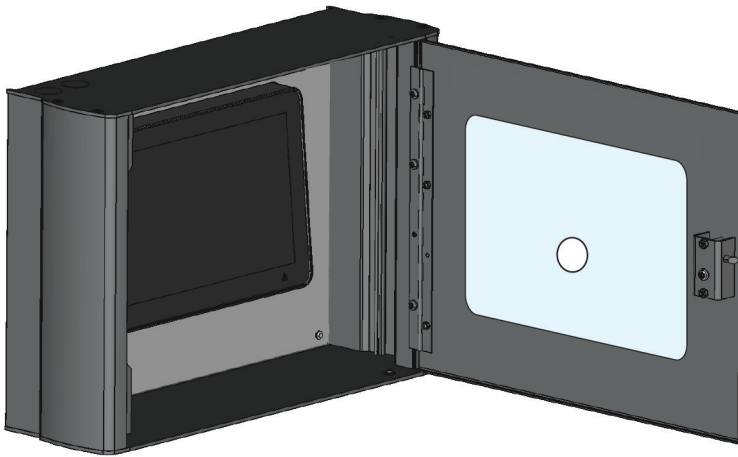

14.2. DRILL MEASURE

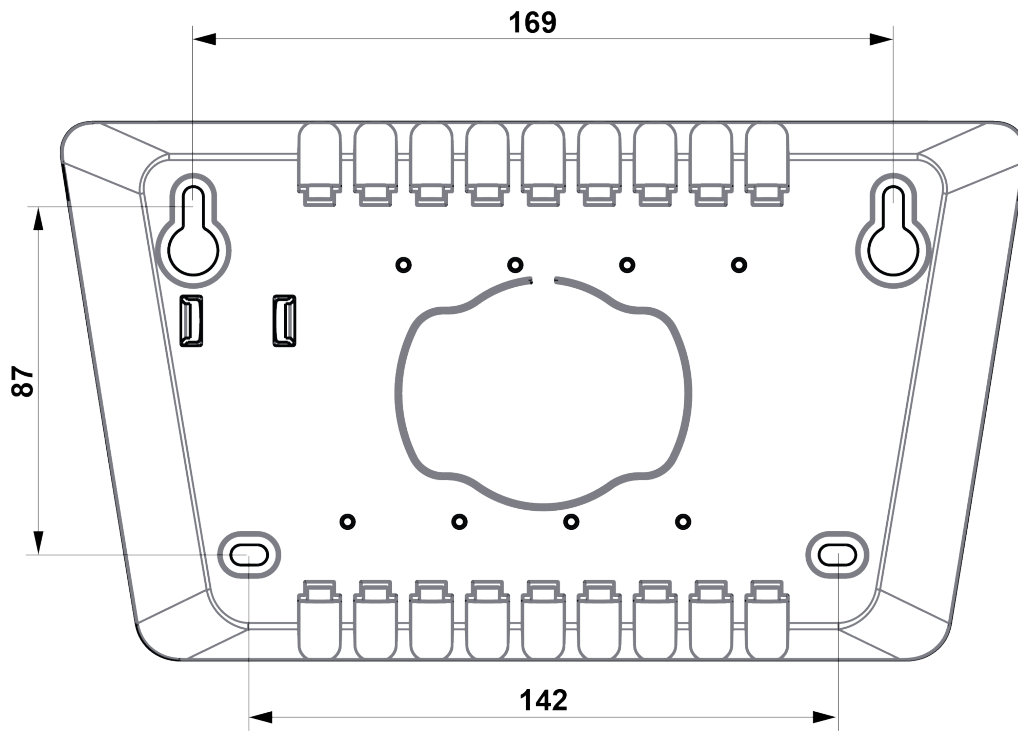

(Measure in mm)

15. INSTALLATION AND WIRING

Up to 1200 m communication cable can be used.

J4

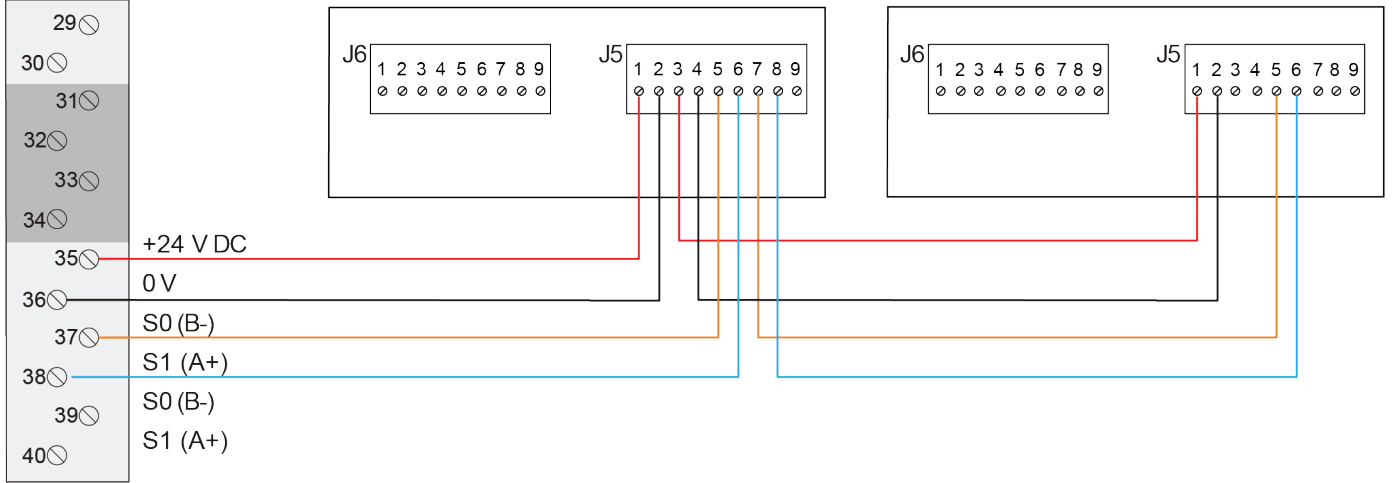

	Ø (mm)	Area (mm ²)	AWG
Wire size (Min)	0.64	0.33	22
Wire size (Max)	1.63	2.08	14

RS485 REDUNDANCY

J4

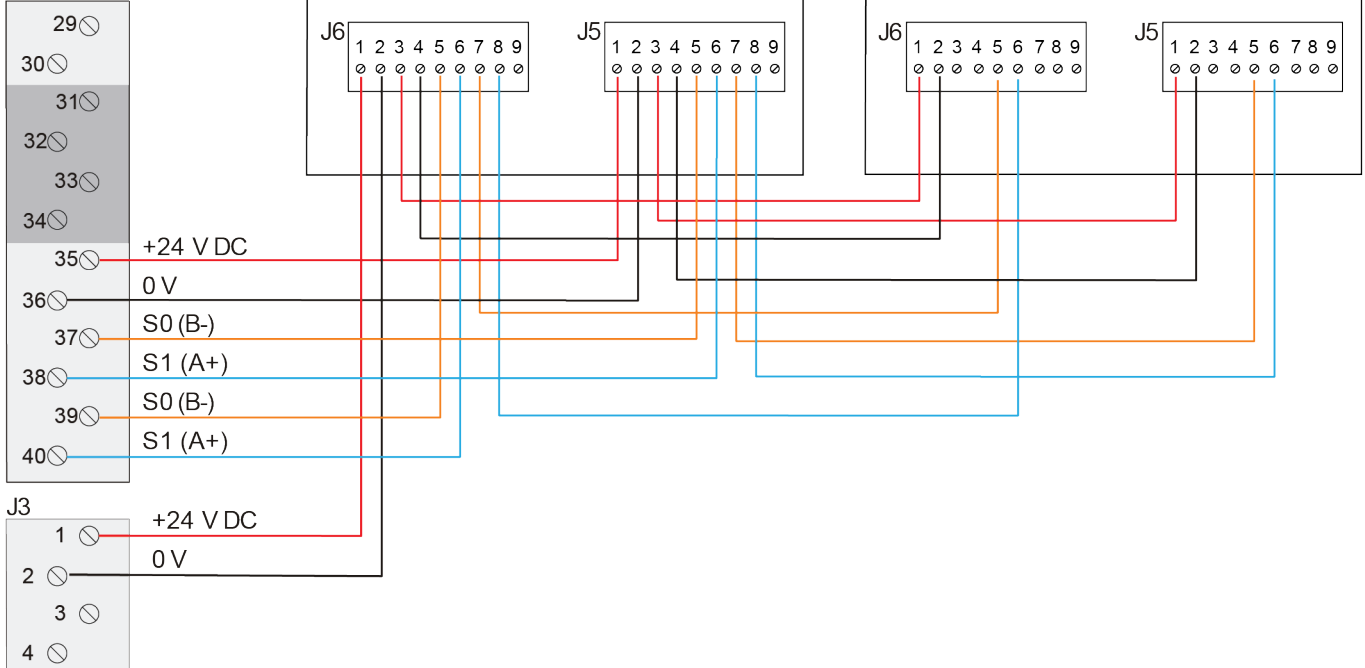

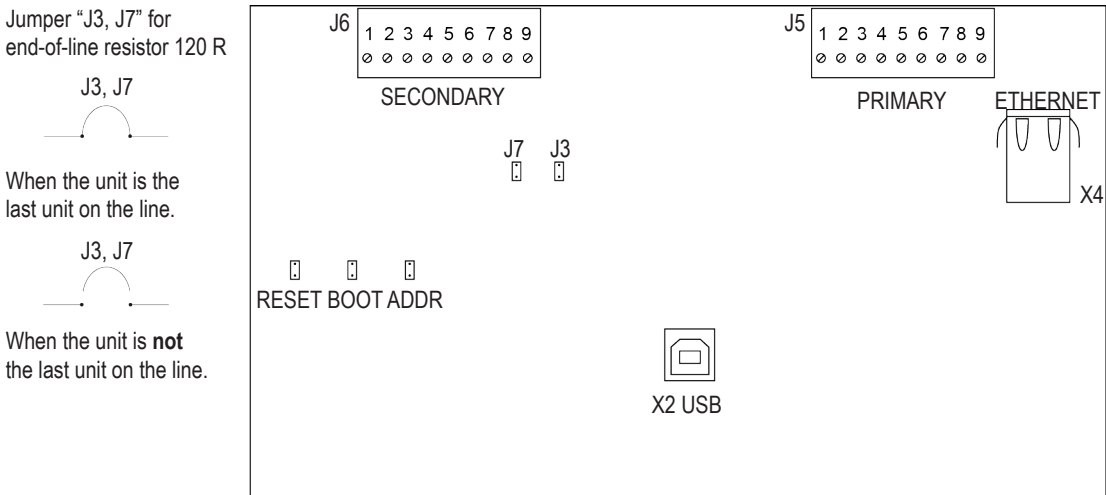

- J1 Reset
- J2 Boot
- J4 Used when setting unit type and address
- J3 Used to connect the built-in end-of-line resistor (primary terminal)
- J7 Used to connect the built-in end-of-line resistor (secondary terminal, for redundant connection)

"J7" and "J3" must only be shunted if the unit is the last unit on the line.

- J5 Primary terminal block
- J6 Secondary terminal block, can be used for redundant connection of communication and power supply.

16. RESTART

The display unit will restart:

- When it is powered up
- After address setting
- If the contact with the control unit is OK again after the message:
“No contact with Control unit”

If there is a program memory fault, there will be a fault message in the display unit:

“Memory fault in program area (n)” (n=1 or 2)

The display unit will not work, and a fault message will be shown in the CIE:

“FAULT: No reply, display unit xx, control unit xx”

If there is an SSD memory fault or no SSD downloaded, the display unit will still work since the alarm texts will be sent out from the CIE.

A fault message will be shown in the CIE:

“FAULT: Site specific data, display unit xx, control unit xx”



17. COMMISSIONING

This chapter describes the correct sequence to install, set, and check the display unit.

PREPARATIONS

- a) Prepare the CIE and remove the fuse "F19" on the main board.
- b) Make sure that the cable (RS485 line) to the display unit is connected.
- c) Connect the cable from the CIE to the display unit terminal block "J5".
- d) Put back the fuse.

SET UNIT TYPE, ADDRESS, AND LANGUAGE

- e) Go to the **Service** menu
- f) Select the **Unit settings** menu.
- g) Enter the **Unit Address**. Press .
- h) Select a **Unit type** in the drop-down list.
- i) Press home  to return to the service menu.
- j) Select the **Language** menu, and press a flag to set the language in the display unit.
- k) Return to the Service menu and press the '**Save and & Restart Device**' button . The unit will restart.

PROGRAMMING IN EBLWIN AND DOWNLOADING SSD

- l) Connect a PC to the CIE.
- m) Download the SSD to the CIE.
When the download of SSD to the CIE is finished, it will restart. Then the download of SSD to the display unit(s) will take place. During the download, the following will be shown on the display:
"SSD download in progress....."
- n) After the download of the SSD, the unit will restart and then start working in normal operation mode.

18. TECHNICAL DATA

All current consumptions are valid by nominal voltage and by 25 °C.

Voltage: Allowed Normal	12 – 30V DC 24V DC	
Current: Quiescent Active	12V DC 80 mA 350 mA	24V DC 45 mA 180 mA
Address range	00-29	
Address setting	See chapter 8.1. UNIT SETTINGS on page 50	
Short circuit isolator	No	
Internal battery	No	
Display size	10.1 inch	
Material	PC/ABS Polyblend 65FS	
Ambient temperature: Operating Storage	-5 to +40 °C -30 to +80 °C	
Ambient humidity	Maximum 93 % RH (Non condensing)	
Ingress protection rating	IP30	
Size: H x W x D	169 x 264 x 56 mm	
Weight:	1400 g	
Colour	Light grey (NCS S 1500-N)	

19. APPROVALS

Applicable directive/ Approval	Applicable standards	Notified body
EMC	EN 55032 Class B (Emission) EN 55032 Class A when mounted in 5055 (Emission) 1) EN50130-4 (Immunity)	Self declaration
RoHS	EN IEC 63000	Self declaration

1) Operation of this class A equipment in a residential environment could cause radio interference.

DOCUMENT NAME: TECHNICAL DESCRIPTION 5054
DOCUMENT NUMBER: MEW02983 EN
DATE OF ISSUE: 2024-02-07
REV: -
DATE OF REVISION: -

Panasonic Fire & Security Europe AB

Jungmansgatan 12
SE-211 11 Malmö
SE
Tel: +46 (0)40 697 70 00