

Products Catalog

Thermal Management Solutions

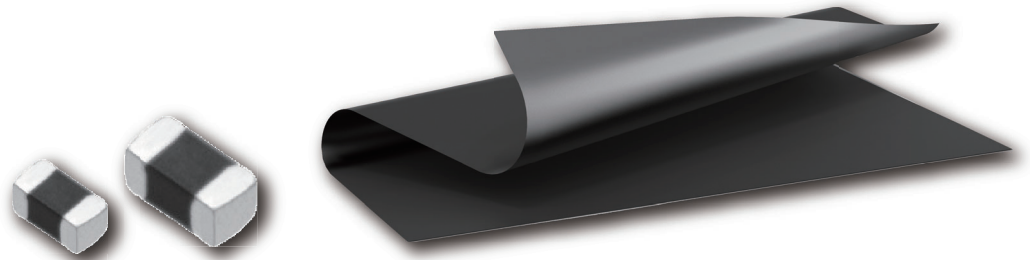

**IN Your
Future**



Thermal Management Solutions CONTENTS

Product item	Part number	Page
Safety and Legal Matters to Be Observed		1
The NTC Thermistors		2
Matters to Be Observed When Using This Product (NTC thermistor / Chip-type)		3
Multilayer NTC Thermistors	ERT JZ	10
	ERT J0	
	ERT J1	
Matters to Be Observed When Using This Product (NTC thermistor / Chip-type : For automotive)		19
Multilayer NTC Thermistors (Automotive Grade)	ERT J0 M	26
	ERT J1 M	
Matters to Be Observed When Using This Product (PGS graphite sheet)		32
“PGS” Graphite Sheets	EYG	33
“GraphiteTIM (Compressible Type)” PGS with low thermal resistance	EYG S	36

Safety and Legal Matters to Be Observed

Product specifications and applications

- Please be advised that this product and product specifications are subject to change without notice for improvement purposes. Therefore, please request and confirm the latest delivery specifications that explain the specifications in detail before the final design, or purchase or use of the product, regardless of the application. In addition, do not use this product in any way that deviates from the contents of the company's delivery specifications.
- Unless otherwise specified in this catalog or the product specifications, this product is intended for use in general electronic equipment (AV products, home appliances, commercial equipment, office equipment, information and communication equipment, etc.).
When this product is used for the following special cases, the specification document suited to each application shall be signed/sealed (with Panasonic Industry and the user) in advance..These include applications requiring special quality and reliability, wherein their failures or malfunctions may directly threaten human life or cause harm to the human body (e.g.: space/aircraft equipment, transportation/traffic equipment, combustion equipment, medical equipment, disaster prevention/crime prevention equipment, safety equipment, etc.).

Safety design and product evaluation

- Please ensure safety through protection circuits, redundant circuits, etc., in the customer's system design so that a defect in our company's product will not endanger human life or cause other serious damage.
- This catalog shows the quality and performance of individual parts. The durability of parts varies depending on the usage environment and conditions. Therefore, please ensure to evaluate and confirm the state of each part after it has been mounted in your product in the actual operating environment before use.
If you have any doubts about the safety of this product, then please notify us immediately, and be sure to conduct a technical review including the above protection circuits and redundant circuits at your company.

Laws / Regulations / Intellectual property

- The transportation of dangerous goods as designated by UN numbers, UN classifications, etc., does not apply to this product. In addition, when exporting products, product specifications, and technical information described in this catalog, please comply with the laws and regulations of the countries to which the products are exported, especially those concerning security export control.
- Each model of this product complies with the RoHS Directive (Restriction of the use of hazardous substances in electrical and electronic equipment) (2011/65/EU and (EU) 2015/863). The date of compliance with the RoHS Directive and REACH Regulation varies depending on the product model.
Further, if you are using product models in stock and are not sure whether or not they comply with the RoHS Directive or REACH Regulation, please contact us by selecting "Sales Inquiry" from the inquiry form.
- During the manufacturing process of this product and any of its components and materials to be used, Panasonic Industry does not intentionally use ozone-depleting substances stipulated in the Montreal Protocol and specific bromine-based flame retardants such as PBBs (Poly-Brominated Biphenyls) / PBDEs (Poly-Brominated Diphenyl Ethers). In addition, the materials used in this product are all listed as existing chemical substances based on the Act on the Regulation of Manufacture and Evaluation of Chemical Substances.
- With regard to the disposal of this product, please confirm the disposal method in each country and region where it is incorporated into your company's product and used.
- The technical information contained in this catalog is intended to show only typical operation and application circuit examples of this product. This catalog does not guarantee that such information does not infringe upon the intellectual property rights of Panasonic Industry or any third party, nor imply that the license of such rights has been granted.
- Design, materials, or process related to technical owned by Panasonic Industry are subject to change without notice.

Panasonic Industry will assume no liability whatsoever if the use of our company's products deviates from the contents of this catalog or does not comply with the precautions. Please be advised of these restrictions.

NTC Thermistors

The NTC Thermistors

NTC Thermistors is a negative temperature coefficient resistor that significantly reduces its resistance value as the heat/ ambient temperature rises. Thermistors are sintered in high-temperature (1200 °C to 1500 °C), and manufactured in various shapes. It's comprised of 2 to 4 kinds of metal oxides: iron, nickel, cobalt, manganese and copper.

Features

- Temperature Coefficient of Resistance is negative, and it's extremely large (-2.8 to -5.1 [%/°C]).
- Various shapes, especially compact size components are available.
- Selection of resistance value is comparatively free, it's available from several 10 Ω to 100 kΩ.

Recommended applications

- For temperature measurement or temperature detection : Thermometer, temperature controller
- For temperature compensation : Transistor, transistor circuit, quartz oscillation circuit, and measuring instruments

Physical characteristics of NTC Thermistors

Thermistor is a resistor sensitive to temperature that is utilizing the characteristic of metal oxide semiconductor having large temperature coefficient. And its temperature dependency of resistance value is indicated by the following equation :

$$R=R_0 \exp \left[B \left(\frac{1}{T} - \frac{1}{T_0} \right) \right] \text{----- (1)}$$

T₀ : Standard Temperature 298.15 K (25 °C)

R₀ : Resistance at T₀ [K], B : Thermistor Constant [K]

Temperature coefficient (α) in general meaning is indicated as follows :

$$\alpha = - \frac{B}{T^2} \text{----- (2)}$$

Since the change by temperature is considerably large, α is not appropriate as a constant. Therefore, B value (constant) is generally used as a coefficient of thermistors.

Fig. 1

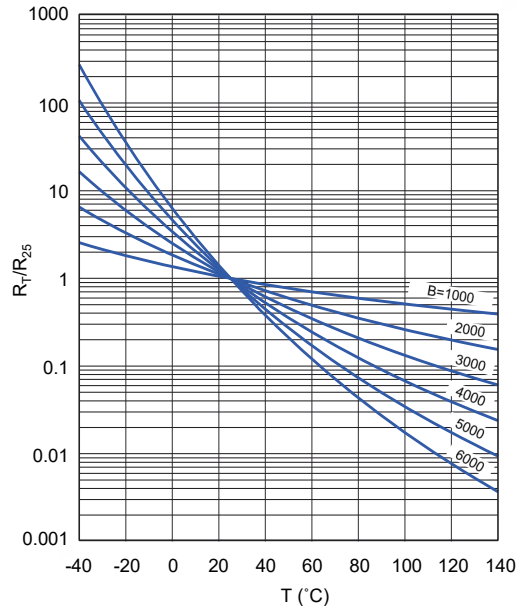

Major characteristics of NTC Thermistors

The relation between resistance and temperature of a thermistor is linear as shown in Fig. 2. The resistance value is shown in vertical direction in a logarithmic scale and reciprocal of absolute temperature (adding 273.15 to centigrade) is shown in horizontal direction. The B value (constant) determines the gradient of these straight lines. The B value (constant) is calculated by using following equation.

$$B = \frac{\ln R_1 - \ln R_2}{\frac{1}{T_1} - \frac{1}{T_2}} \text{----- (3)}$$

R₁ : Resistance at T₁ K, R₂ : Resistance at T₂ K

When you calculate this equation, you'll find that B value is not exactly constant. The resistance is expressed by the following equation :

$$R = AT^{-C} \exp D/T \text{----- (4)}$$

In (4), C is a small positive or negative constant and quite negligible except for use in precision temperature-measuring device, therefore, the B value can be considered as constant number.

In Fig. 1, the relation between the resistance ratio R_T/R₂₅ (R₂₅ : Resistance at 25 °C, R_T : Resistance at T °C) and B Value is shown with T °C, in the horizontal direction.

Fig. 2

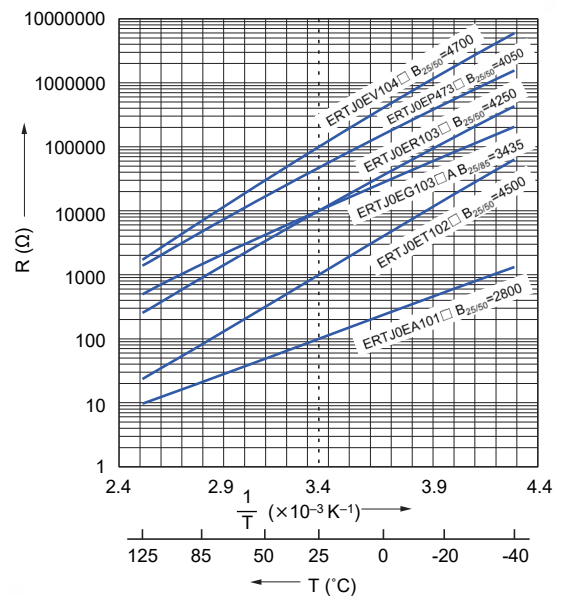

Matters to Be Observed When Using This Product (NTC thermistor / Chip-type)

Safety measures

- An NTC thermistor (chip-type) (hereinafter "the product" or "the thermistor") is intended for use in general-purpose and standard applications, such as temperature detection and temperature compensation in general electronic equipment. The thermistor may deteriorate in performance or fail (short or open modes) when used improperly.
- If the thermistor in short mode is used, applied voltage may cause a large current to flow through the thermistor. Consequently, the thermistor heats up and may burn the circuit board. An abnormal state of the thermistor that results from a problem with its service conditions (use environment, design conditions, mounting conditions, etc.) may lead to, in a worst case scenario, burnout of the circuit board, serious accident, etc. Sufficiently check for what is described below before using the thermistor.

Use environments and cleaning conditions

- This product (thermistor) is not designed for use in the specific environments described below. Using the product in such specific environments or service conditions, therefore, may affect the performance of the product. Please check the performance and reliability of the product first and then use the product.
 - (1) Used in liquid, such as water, oil, chemicals, and organic solvents.
 - (2) Used in a place exposed to direct sunlight, an outdoor place with no shielding, or a dusty place.
 - (3) Used in a place where the product is heavily exposed to sea breeze or a corrosive gas, such as Cl₂, H₂S, NH₃, SO₂, or NO_x.
 - (4) Used in an environment where electromagnetic waves and radiation are strong.
 - (5) Located close to a heating component or a flammable material, such as a vinyl cable.
 - (6) Sealed or coated with a resin, etc.
 - (7) Solder flux of the soldered product is cleansed with a solvent, water, and a water-soluble cleaner (be careful with solder flux soluble to water).
 - (8) Used in a place where dew concentrates on the product.
 - (9) Used in a contaminated state. (Example) Touching a thermistor (with uncovered skin) mounted on a printed board leaves sebum on the thermistor. Do not handle the thermistor in this manner.
 - (10) Used in a place where excessive vibration or impact is applied to the product.
- Use the thermistor within the range of its specified ratings/capabilities. Using the thermistor under severe service conditions that are beyond the specified ratings/capabilities causes degraded performance or destruction of the thermistor, which may lead to scattering of thermistor fragments, smoke generation, ignition, etc. Do not use the thermistor at a working temperature or maximum allowable circuit voltage that exceeds the specified working temperature or maximum allowable circuit voltage. Do not locate the thermistor close to combustible materials.
- In an improper cleaning solution, with which the thermistor is cleaned, flux residues or other foreign matter may stick to the surface of the thermistor, which degrades the performance (insulation resistance, etc.) of the thermistor. In a polluted cleaning solution, the concentration of free halogen, etc., is high, and may result in poor/insufficient cleaning.
- Improper cleaning conditions (insufficient cleaning or excessive cleaning) may impair the performance of the thermistor.
 - (1) Insufficient cleaning
 - (a) A halogenous substance in flux residues may corrode a metal element, such as a terminal electrode.
 - (b) A halogenous substance in flux residues may stick to the surface of the thermistor and lower its insulation resistance.
 - (c) Tendencies described in (a) and (b) may be more notable with water-soluble flux than with rosin-based flux.

Be careful about insufficient cleaning.
 - (2) Excessive cleaning

Ultrasonic waves that are too powerful from an ultrasonic cleaner cause the board to resonate, in which case the vibration of the board may cause the thermistor or a soldered part to crack or reduce the strength of the terminal electrode. Keep power output from the ultrasonic cleaner at 20 W/L or lower, its ultrasonic frequency at 40 kHz or lower, and an ultrasonic cleaning time at 5 minutes or less.

Response to anomalies and handling conditions

- Do not apply excessive mechanical impact to the thermistor. Because the thermistor body is made of ceramic, drop impact to the thermistor readily damages or cracks the thermistor. Once dropped on the floor, etc., the thermistor may have lost its sound quality and become failure-prone. Do not use said thermistor.
- When handling the board carrying the thermistor, be careful not to let the thermistor hit against another board. Take extra caution when handling or storing a stack of boards carrying thermistors. There are cases where a corner of a board will hit against a thermistor and damage or crack it, which may result in a failure of the thermistor, such as a drop in its insulation resistance. Do not reuse a thermistor that has been used on and removed from a board.

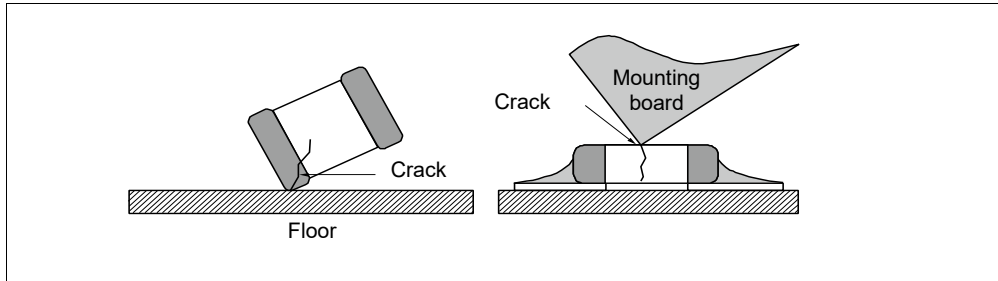

Circuit design and circuit board design

- A working temperature at which a thermistor works in the circuit must be within the working temperature range specified in the specification sheet. A temperature at which a thermistor incorporated in the circuit is kept in storage without operating must be within the storage temperature range specified in the specification sheet. Do not use the thermistor at a higher temperature than the maximum working temperature.
- Ensure that a voltage applied across the terminals of the thermistor in use is equal to or lower than the maximum voltage (maximum power). When the thermistor is used in a condition where the thermistor is supplied with power exceeding the maximum power, self-heating by the thermistor becomes so intensive that the thermistor with high temperature may fail or burn out. Discuss safety measures, such as a protective circuit against an abnormal voltage, etc. The thermistor in use generates heat by itself even when supplied with power equal to or lower than the maximum power. This self-heating may make the thermistor incapable of exactly detecting the ambient temperature. When using the thermistor, ensure that a voltage applied across the terminals of the thermistor is equal to or lower than the maximum voltage (maximum power) and take the heat dissipation constant of the thermistor into consideration.

• Maximum power

It refers to the maximum of power that can be supplied consecutively to the thermistor in still air with a certain ambient temperature. Note that the maximum power when the ambient temperature is 25 °C or lower is equal to the rated power, and that the maximum power when the ambient temperature is higher than 25 °C follows a derating curve shown in a graph on the right.

• Heat dissipation constant

A heat dissipation constant represents power that the thermistor needs to raise its temperature by 1 °C by self-heating in a temperature steady state. Dividing power consumption by the thermistor by a temperature increment of the thermistor yields the heat dissipation constant.

The heat dissipation constant is expressed in units of (mW/ °C).

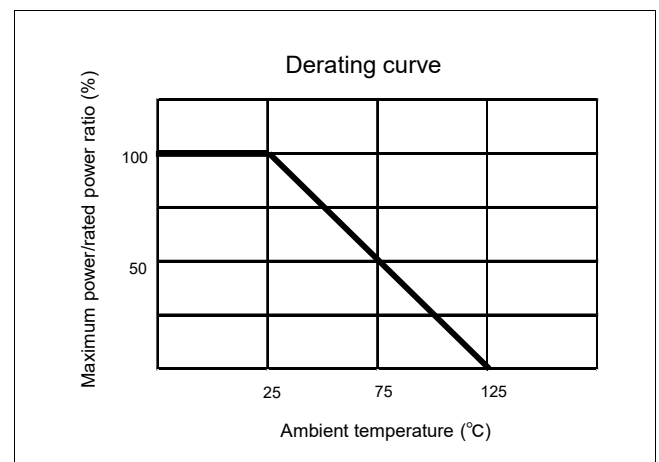

- The resistance of the thermistor changes with changes of the ambient temperature or by its self-heating. When measuring the resistance value of the thermistor in a circuit examination, acceptance inspection, etc., heed the following items.
 - ① Measurement temperature : Measurement temperature shall be 25 ±0.1 °C. We recommend measurement of the thermistor in a liquid (silicone oil, etc.) in which a measurement temperature is kept stable.
 - ② Power : Power supplied to the thermistor shall be 0.10 mW or less. We recommend resistance value measurement by a four-terminal measurement method, using a constant-current power supply.
- Using the thermistor on an alumina board has an expectation of performance degradation due to thermal impact (temperature cycle). Before using the thermistor, sufficiently confirm that the board does not affect the quality of the thermistor.

Mounting conditions

- The more solder deposited on the thermistor, the greater the stress to the thermistor, which leads to cracking of the thermistor. When designing a land on the board, determine the shape and dimensions of the land so that a proper volume of solder is applied in the land. Design the land such that its left and right sides are equal in size. In a case where solder volumes are different between the left and right sides of the land, a greater volume of solder takes more time to cool and solidify. As a result, stress acts on one side which may crack the thermistor.

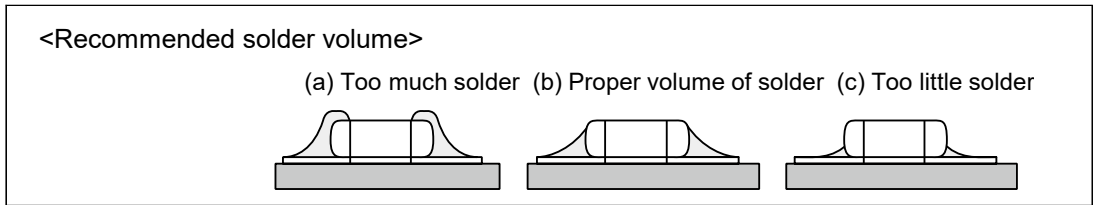

<Recommended land dimensions (example)>

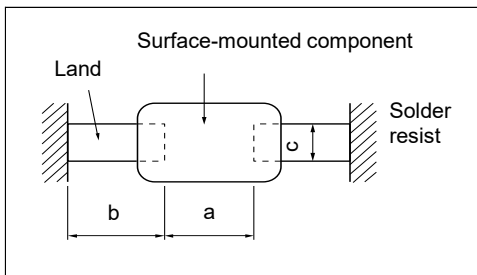

Shape symbol (JIS size)	Component dimensions			a	b	c
	L	W	T			
Z (0603)	0.6	0.3	0.3	0.2 to 0.3	0.25 to 0.30	0.2 to 0.3
0 (1005)	1.0	0.5	0.5	0.4 to 0.5	0.4 to 0.5	0.4 to 0.5
1 (1608)	1.6	0.8	0.8	0.8 to 1.0	0.6 to 0.8	0.6 to 0.8

Unit: mm

<Using solder resist>

- Use solder resist to evenly distribute solder volumes on the left and right sides.
- When a component is located close to the thermistor, the thermistor is mounted together with a lead-attached component, or a chassis is located close to the thermistor, separate solder patterns from each other using the solder resist.

* Refer to cases to avoid and recommended examples shown on the right table.

Items	Case to avoid	Case recommended
		(Example of improving soldering by separating solder patterns)
Mounting the thermistor together with a lead-attached component	Lead of a lead-attached component	Solder resist
Soldering in the vicinity of the chassis	Chassis Solder (earth solder) Electrode pattern	Solder resist
Soldering a lead-attached component later	Lead of a component mounted later Solder iron	Solder resist
Placing the products side by side	Part where too much solder is applied Land	Solder resist

<Thermistor placement that avoids stress caused by warp in the board>

- When the board warps during or after soldering of the thermistor to the board, the warping of the board may cause the thermistor to crack. Place the thermistor so that stress caused by the warp is negligible to the thermistor.

* Refer to the case to avoid and a case recommended example shown on the right table.

Case to avoid	Case recommended
	 Set the thermistor sideways relative to the direction in which

<Mechanical stress near a breaking line of the board>

- Mechanical stresses to the thermistor near a breaking line of the board vary depending on the mounting position of the thermistor. Refer to the figure on the right.
- The thermistor receives mechanical stresses different in size when the board is broken by different methods. The size of the stress the thermistor receives is smaller in the following order: pushing back<breaking along a slit<breaking along a V groove<breaking along a perforated line. In addition to thermistor placement, consider the board breaking method as well.

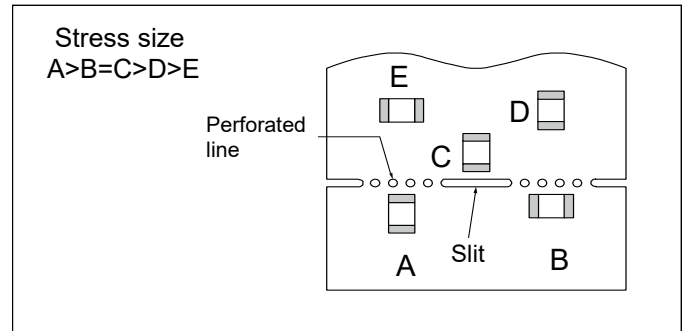

- When the thermistor is located near a heating element, such as a heater, if the thermistor is soldered directly to the heating element or is mounted together with the heating element on the same land, the thermistor exposed to a heat stress may crack. If you consider adopting such a layout, contact us first for consultation.

<Mounting density and space between components>

- When space between components is too narrow, solder bridges or solder balls have negative effects on the components. Be careful to provide proper space between the components.

<Mounting on the board>

- When the thermistor is mounted on the board, an excessive impact load, such as pressure from a suction nozzle for mounting the thermistor and mechanical impact/stress caused by a positional shift or positioning, may be applied to the thermistor. Prevent application of such an excessive impact load to the thermistor.
- A moulder needs to be checked and maintained regularly.
- When the bottom dead center of the suction nozzle is too low, an excessively large force is applied to the thermistor when it is mounted, which may crack the thermistor. Heed the following instructions when using the suction nozzle.
 - (1) Set the bottom dead center of the suction nozzle at the upper surface of the straightened board.
 - (2) Set the pressure of the suction nozzle equal to a static load between 1 N to 3 N.
 - (3) In the case of double-face mounting, put a backup pin on the lower surface (back) of the board to prevent the board from warping. This keeps the impact of the suction nozzle as small as possible. Typical examples of using the backup pin are shown in the following table.

Items	Case to avoid	Case recommended
Single-face mounting	Crack	The backup pin does not always need to be underneath the thermistor. Backup pin
Double-face mounting	Solder separation Crack	Backup pin

(4) Adjust the suction nozzle so that its bottom dead center is not too low.

- When positioning grippers wear out, they apply mechanical impact to part of the thermistor when positioning it, thus chipping or cracking the thermistor in some cases. Maintain the proper dimensions of the positioning grippers in their closed state and regularly carry out maintenance, check, or replacement of the positioning grippers.
- A thermistor mounted on a heavily warped printed board, may crack or break. Put a backup pin on the back of the board to reduce the warp of the board to 0.5 mm or less with 90 mm span width.

<Selecting flux>

- Flux may have a great effect on the performance of the thermistor. Before using the thermistor, check whether the flux has any effect on the performance of the thermistor.
 - (1) Use flux containing a halogen-based substance of 0.1 wt% (in terms of chlorine) or less.
Do not use highly acidic flux.
 - (2) Water-soluble flux remaining on the thermistor surface may impair its insulation resistance when cleaning work is insufficient. When using the water-soluble flux, clean the soldered part sufficiently to eliminate flux residues.

• Reflow soldering

A temperature condition under which reflow soldering is performed is represented by a temperature curve consisting of a preheating part, a temperature-rising part, a main heating part, and a gradual cooling part. Heating the thermistor rapidly creates excessive heat stress therein due to a large temperature difference and, because of this heat stress, the thermistor may thermally crack. Be sufficiently careful with a temperature difference resulting from rapid heating. The preheating part is a temperature area that is important for preventing a tombstone (chip rising) phenomenon. Be sufficiently careful with temperature control.

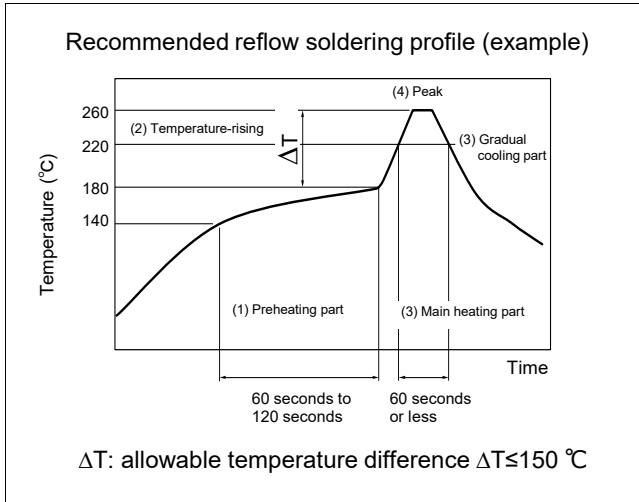

Items	Temperature condition	Time, heating rate
(1) Preheating part	140 °C to 180 °C	60 to 120 seconds
(2) Temperature-rising part	Preheating temperature to peak temperature	2 to 5 °C per second
(3) Main heating part	220 °C or higher	60 seconds or less
(4) Peak	260 °C or less	10 seconds or less
(5) Gradual cooling part	Peak temperature to 140 °C	1 to 4 °C per second

Avoid performing rapid cooling (forced cooling) during the gradual cooling part. Rapidly cooling the thermistor may result in thermal cracking of the thermistor. When dipping the thermistor in the cleaning solution right after soldering the thermistor, confirm that the surface temperature of the thermistor is 100 °C or lower. There is no problem with two cycles of reflow soldering under the recommended reflow soldering profile (example) conditions shown in the above diagram. Be sufficiently careful with deflection or warping of the board.

Note that the recommended soldering conditions indicate conditions under which the degradation of the product characteristics does not occur but do not indicate conditions under which stable soldering can be performed. Check and set conditions under which stable soldering can be performed, on a case-by-case basis.

thermistor temperatures vary depending on the mounted state of the thermistor. Make sure to confirm that the surface temperature of the thermistor is within the specified temperature when the thermistor is mounted and then use the thermistor.

• Soldering-iron-used soldering

In soldering-iron soldering, stress created by a rapid temperature change is applied directly to the thermistor. Be sufficiently careful in controlling the temperature of the soldering iron tip. Be careful not to let the soldering iron tip come in direct contact with the thermistor or its terminal electrode. The thermistor is particularly vulnerable to rapid heating and rapid cooling. When heated or cooled rapidly, the thermistor develops excessive heat stress therein resulting from the large temperature difference and because of this heat stress, may thermally crack. Observe the following instructions on preheating, gradual cooling, etc.

Once a thermistor soldered with a soldering iron is removed from the board, it cannot be used again.

(1) Condition 1 (preheating included)

- (a) Solder: : Use wire solder (with less chloride content) that is meant for soldering precision electronic equipment. (Wire diameter: 1.0 mm or less)
- (b) Preheating: : Preheat the thermistor sufficiently so that the difference between the solder temperature and the surface temperature of the thermistor is 150°C or less.
- (c) Temperature of the soldering iron tip : 300°C or lower (a required volume of solder is melted on the soldering iron tip in advance).
- (d) Gradual coolin : After soldering the thermistor, leave it in normal temperature conditions to let it cool gradually.

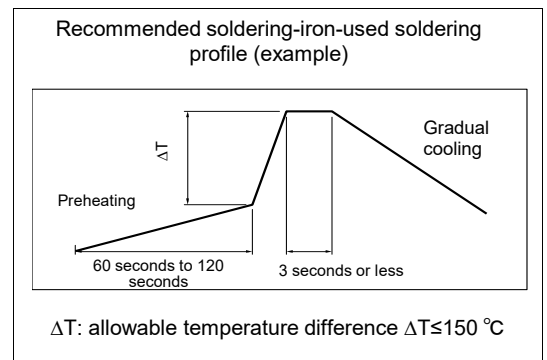

(2) Condition 2 (preheating not included)

If soldering iron tip conditions listed in the table on the right are met, the thermistor can be soldered with the soldering iron without preheating the thermistor.

- (a) Make sure that the soldering iron tip does not come in direct contact with the thermistor or its terminal electrode.
- (b) After preheating the land sufficiently with the soldering-iron tip, slide the soldering-iron tip toward the terminal electrode of the thermistor to solder the thermistor.

Soldering iron tip conditions in soldering without preheating

Items	Condition
Temperature of the soldering iron tip	270 °C or lower
Wattage	20 W or less
Shape of the soldering iron tip	ø3 mm or less
Soldering-iron applying time	3 seconds or less

<Inspection>

- When the printed board is inspected with measurement terminal pins after the thermistor is mounted on the board, the measurement terminal pins pressed against the printed board cause the board to warp, which may cause a crack to form on the thermistor.
 - (1) Put the backup pin on the back of the printed board to reduce the warp of the board to 0.5 mm or less with a 90 mm span width.
 - (2) Check whether the shape of the front ends of the measurement terminal pins poses no problem, whether the pins are equal in length, whether the pressure of the pins are not excessively high, and whether the set position of the pins is correct.

Items	Case to avoid	Case recommended
Warp in the board		

<Protective coat>

- When the thermistor is coated with or embedded in a resin to improve the thermistor's resistance to humidity and gas or to set the thermistor stationary, it is expected that the following problems will arise. In such cases, confirm the performance and reliability of the thermistor in advance.
 - (1) A solvent included in the resin infiltrates the thermistor and impairs its characteristics.
 - (2) Heat from chemical reaction (curing heat) generated by the resin when it cures exerts a negative effect on the thermistor.
 - (3) Expansion/shrinkage of the resin applies stress to the soldering part and causes it to crack.

<Splitting a multiple formation printed board>

- When splitting the board having components, including a mounted thermistor into multiple pieces, be careful not to apply bending stress or torsional stress to the board. If bending stress or torsional stress, shown in the following diagram, is applied to the board when it is split, the thermistor may develop a crack. Avoid, as much as possible, applying stress to the board.

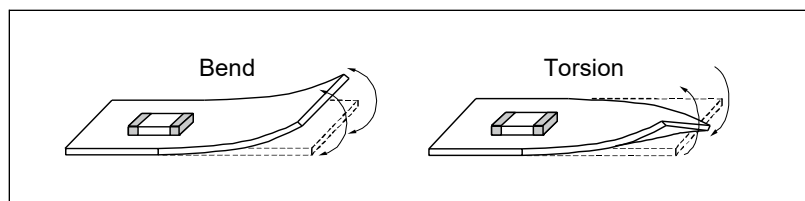

- Avoid manually splitting the board so as to keep mechanical stress to the board as small as possible. When splitting the board, use a splitting jig or a board splitter.

Multilayer NTC Thermistors

ERTJ series

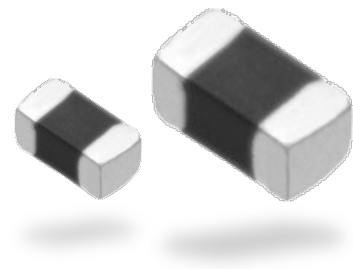

Features

- Surface Mount Device (0201·0402·0603)
- Highly reliable multilayer / monolithic structure
- Wide temperature operating range (-40 to 125 °C)
- Environmentally-friendly lead-free
- RoHS compliant

Recommended applications

- Mobile Phone
 - Temperature compensation for crystal oscillator
 - Temperature compensation for semiconductor devices
- Personal Computer and Peripheral Device
 - Temperature detection for CPU and memory device
 - Temperature compensation for ink-viscosity (Inkjet Printer)
- Battery Pack (secondary battery)
 - Temperature detection of battery cells
- Liquid Crystal Display
 - Temperature compensation of display contrast
 - Temperature compensation of display backlighting (CCFL)

Explanation of part numbers

1	2	3	4	5	6	7	8	9	10	11	12	Example
E	R	T	J	0	E	G	1	0	3	J	A	
Common code			Size code (inch size)		Packaging style code		B Value class code		Nominal resistance R ₂₅ (Ω)	Resistance tolerance code		Special specification
Product code		Type code		Z	0201	E		A	2701 to 2800	F ±1 %		Narrow tolerance type
ERT	NTC Thermistors	J Chip type (SMD) Multilayer type		0	0402	V		G	3301 to 3400	G ±2 %		Standard type
				1	0603			M	3801 to 3900	H ±3 %		
								P	4001 to 4100	J ±5 %		
								R	4201 to 4300			
								S	4301 to 4400			
								T	4401 to 4500			
								V	4601 to 4700			

The first two digits are significant figures of resistance and the third one denotes the number of zeros following them.

Construction

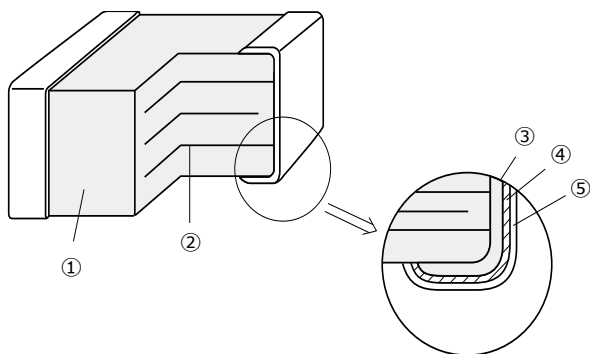

No.	Name
①	Semiconductive ceramics
②	Internal electrode
③	Substrate electrode
④	Terminal electrode
⑤	Intermediate electrode
	External electrode

Ratings

Size code (inch size)	Z(0201)	0(0402)	1(0603)
Operating temperature range	-40 to 125 °C		
Rated maximum power dissipation ^{*1}	33 mW	66 mW	100 mW
Dissipation factor ^{*2}	Approximately 1 mW / °C	Approximately 2 mW / °C	Approximately 3 mW / °C

*1: Rated Maximum Power Dissipation : The maximum power that can be continuously applied at the rated ambient temperature.

•The maximum value of power, and rated power is same under the condition of ambient temperature 25 °C or less. If the temperature exceeds 25 °C, rated power depends on the decreased power dissipation curve.

•Please see "Operating Power" for details.

*2: Dissipation factor : The constant amount power required to raise the temperature of the Thermistor 1 °C through self heat generation under stable temperatures.

•Dissipation factor is the reference value when mounted on a glass epoxy board (1.6 mmT).

Part number list of narrow tolerance type (Resistance tolerance : ±2 %, ±1 %)

● 0201 inch size

Part number	Nominal resistance at 25 °C (Ω)	Resistance tolerance	B Value at 25/50 (K)	B Value at 25/85 (K)
ERTJZEG103□A	10 kΩ	±1 %(F) or ±2 %(G)	(3380 K)	3435 K±1 %
ERTJZEP473□	47 kΩ		4050 K±1 %	(4100 K)
ERTJZEP683□	68 kΩ		4050 K±1 %	(4100 K)
ERTJZER683□	68 kΩ		4250 K±1 %	(4300 K)
ERTJZER104□	100 kΩ		4250 K±1 %	(4300 K)
ERTJZET104□	100 kΩ		4500 K±1 %	(4550 K)
ERTJZEV104□	100 kΩ		4700 K±1 %	(4750 K)

● 0402 inch size

Part number	Nominal resistance at 25 °C (Ω)	Resistance tolerance	B Value at 25/50 (K)	B Value at 25/85 (K)
ERTJ0EG103□A	10 kΩ	±1 %(F) or ±2 %(G)	(3380 K)	3435 K±1 %
ERTJ0EP333□	33 kΩ		4050 K±1 %	(4100 K)
ERTJ0EP473□	47 kΩ		4050 K±1 %	(4100 K)
ERTJ0EP683□	68 kΩ		4050 K±1 %	(4100 K)
ERTJ0ER104□	100 kΩ		4250 K±1 %	(4300 K)
ERTJ0ES104□	100 kΩ		4330 K±1 %	(4390 K)
ERTJ0EV104□	100 kΩ		4700 K±1 %	(4750 K)
ERTJ0EV224□	220 kΩ		4700 K±1 %	(4750 K)

● 0603 inch size

Part number	Nominal resistance at 25 °C (Ω)	Resistance tolerance	B Value at 25/50 (K)	B Value at 25/85 (K)
ERTJ1VG103□A	10 kΩ	±1 %(F) or ±2 %(G)	(3380 K)	3435 K±1 %
ERTJ1VS104□A	100 kΩ		(4330 K)	4390 K±1 %

□ : Resistance tolerance code

Part number list of standard type (Resistance tolerance : ±5 %, ±3 %)

● 0201 inch size

Part number	Nominal resistance at 25 °C (Ω)	Resistance tolerance	B Value at 25/50 (K)	B Value at 25/85 (K)
ERTJZET202□	2.0 kΩ	±3 %(H) or ±5 %(J)	4500 K±2 %	(4450 K)
ERTJZET302□	3.0 kΩ		4500 K±2 %	(4450 K)
ERTJZET472□	4.7 kΩ		4500 K±2 %	(4450 K)
ERTJZEG103□A	10 kΩ		(3380 K)	3435 K±1 %
ERTJZEP473□	47 kΩ		4050 K±2 %	(4100 K)
ERTJZEP683□	68 kΩ		4050 K±2 %	(4100 K)
ERTJZER683□	68 kΩ		4250 K±2 %	(4300 K)
ERTJZER104□	100 kΩ		4250 K±2 %	(4300 K)
ERTJZET104□	100 kΩ		4500 K±2 %	(4550 K)
ERTJZEV104□	100 kΩ		4700 K±2 %	(4750 K)
ERTJZET154□	150 kΩ		4500 K±2 %	(4750 K)
ERTJZET224□	220 kΩ		4500 K±2 %	(4750 K)

□ : Resistance tolerance code

Multilayer NTC Thermistors

Part number list of standard type (Resistance tolerance : $\pm 5\%$, $\pm 3\%$)

● 0402 inch size

Part number	Nominal resistance at 25 °C (Ω)	Resistance tolerance	B Value at 25/50 (K)	B Value at 25/85 (K)
ERTJ0EA220□	22 Ω	$\pm 3\%$ (H) or $\pm 5\%$ (J)	2750 K $\pm 3\%$	(2700 K)
ERTJ0EA330□	33 Ω		2750 K $\pm 3\%$	(2700 K)
ERTJ0EA400□	40 Ω		2750 K $\pm 3\%$	(2700 K)
ERTJ0EA470□	47 Ω		2750 K $\pm 3\%$	(2700 K)
ERTJ0EA680□	68 Ω		2800 K $\pm 3\%$	(2750 K)
ERTJ0EA101□	100 Ω		2800 K $\pm 3\%$	(2750 K)
ERTJ0EA151□	150 Ω		2800 K $\pm 3\%$	(2750 K)
ERTJ0ET102□	1.0 k Ω		4500 K $\pm 2\%$	(4450 K)
ERTJ0ET152□	1.5 k Ω		4500 K $\pm 2\%$	(4450 K)
ERTJ0ET202□	2.0 k Ω		4500 K $\pm 2\%$	(4450 K)
ERTJ0ET222□	2.2 k Ω		4500 K $\pm 2\%$	(4450 K)
ERTJ0ET302□	3.0 k Ω		4500 K $\pm 2\%$	(4450 K)
ERTJ0ER332□	3.3 k Ω		4250 K $\pm 2\%$	(4300 K)
ERTJ0ET332□	3.3 k Ω		4500 K $\pm 2\%$	(4450 K)
ERTJ0ET472□	4.7 k Ω		4500 K $\pm 2\%$	(4450 K)
ERTJ0ER472□	4.7 k Ω		4250 K $\pm 2\%$	(4300 K)
ERTJ0ER682□	6.8 k Ω		4250 K $\pm 2\%$	(4300 K)
ERTJ0EG103□A	10 k Ω		(3380 K)	3435 K $\pm 1\%$
ERTJ0EM103□	10 k Ω		3900 K $\pm 2\%$	(3970 K)
ERTJ0ER103□	10 k Ω		4250 K $\pm 2\%$	(4300 K)
ERTJ0ER153□	15 k Ω		4250 K $\pm 2\%$	(4300 K)
ERTJ0ER223□	22 k Ω		4250 K $\pm 2\%$	(4300 K)
ERTJ0EP333□	33 k Ω		4050 K $\pm 2\%$	(4100 K)
ERTJ0ER333□	33 k Ω		4250 K $\pm 2\%$	(4300 K)
ERTJ0ET333□	33 k Ω		4500 K $\pm 2\%$	(4580 K)
ERTJ0EP473□	47 k Ω		4050 K $\pm 2\%$	(4100 K)
ERTJ0ET473□	47 k Ω		4500 K $\pm 2\%$	(4550 K)
ERTJ0EV473□	47 k Ω		4700 K $\pm 2\%$	(4750 K)
ERTJ0EP683□	68 k Ω		4050 K $\pm 2\%$	(4100 K)
ERTJ0ER683□	68 k Ω		4250 K $\pm 2\%$	(4300 K)
ERTJ0EV683□	68 k Ω		4700 K $\pm 2\%$	(4750 K)
ERTJ0EP104□	100 k Ω		4050 K $\pm 2\%$	(4100 K)
ERTJ0ER104□	100 k Ω		4250 K $\pm 2\%$	(4300 K)
ERTJ0ES104□	100 k Ω		4330 K $\pm 2\%$	(4390 K)
ERTJ0ET104□	100 k Ω		4500 K $\pm 2\%$	(4580 K)
ERTJ0EV104□	100 k Ω		4700 K $\pm 2\%$	(4750 K)
ERTJ0ET154□	150 k Ω		4500 K $\pm 2\%$	(4580 K)
ERTJ0EV154□	150 k Ω		4700 K $\pm 2\%$	(4750 K)
ERTJ0EV224□	220 k Ω		4700 K $\pm 2\%$	(4750 K)
ERTJ0EV334□	330 k Ω		4700 K $\pm 2\%$	(4750 K)
ERTJ0EV474□	470 k Ω	4700 K $\pm 2\%$	(4750 K)	

□ : Resistance tolerance code

Multilayer NTC Thermistors

Part number list of standard type (Resistance tolerance : $\pm 5\%$, $\pm 3\%$)

● 0603 inch size

Part number	Nominal resistance at 25 °C (Ω)	Resistance tolerance	B Value at 25/50 (K)	B Value at 25/85 (K)
ERTJ1VA220□	22 Ω	$\pm 3\%$ (H) or $\pm 5\%$ (J)	2750 K $\pm 3\%$	(2700 K)
ERTJ1VA330□	33 Ω		2750 K $\pm 3\%$	(2700 K)
ERTJ1VA400□	40 Ω		2800 K $\pm 3\%$	(2750 K)
ERTJ1VA470□	47 Ω		2800 K $\pm 3\%$	(2750 K)
ERTJ1VA680□	68 Ω		2800 K $\pm 3\%$	(2750 K)
ERTJ1VA101□	100 Ω		2800 K $\pm 3\%$	(2750 K)
ERTJ1VT102□	1.0 k Ω		4500 K $\pm 2\%$	(4450 K)
ERTJ1VT152□	1.5 k Ω		4500 K $\pm 2\%$	(4450 K)
ERTJ1VT202□	2.0 k Ω		4500 K $\pm 2\%$	(4450 K)
ERTJ1VT222□	2.2 k Ω		4500 K $\pm 2\%$	(4450 K)
ERTJ1VT302□	3.0 k Ω		4500 K $\pm 2\%$	(4450 K)
ERTJ1VT332□	3.3 k Ω		4500 K $\pm 2\%$	(4450 K)
ERTJ1VR332□	3.3 k Ω		4250 K $\pm 2\%$	(4300 K)
ERTJ1VR472□	4.7 k Ω		4250 K $\pm 2\%$	(4300 K)
ERTJ1VT472□	4.7 k Ω		4500 K $\pm 2\%$	(4450 K)
ERTJ1VR682□	6.8 k Ω		4250 K $\pm 2\%$	(4300 K)
ERTJ1VG103□A	10 k Ω		(3380 K)	3435 K $\pm 1\%$
ERTJ1VR103□	10 k Ω		4250 K $\pm 2\%$	(4300 K)
ERTJ1VR153□	15 k Ω		4250 K $\pm 2\%$	(4300 K)
ERTJ1VR223□	22 k Ω		4250 K $\pm 2\%$	(4300 K)
ERTJ1VR333□	33 k Ω		4250 K $\pm 2\%$	(4300 K)
ERTJ1VP473□	47 k Ω		4100 K $\pm 2\%$	(4150 K)
ERTJ1VR473□	47 k Ω		4250 K $\pm 2\%$	(4300 K)
ERTJ1VV473□	47 k Ω		4700 K $\pm 2\%$	(4750 K)
ERTJ1VR683□	68 k Ω		4250 K $\pm 2\%$	(4300 K)
ERTJ1VV683□	68 k Ω		4700 K $\pm 2\%$	(4750 K)
ERTJ1VS104□A	100 k Ω		(4330 K)	4390 K $\pm 1\%$
ERTJ1VV104□	100 k Ω		4700 K $\pm 2\%$	(4750 K)
ERTJ1VV154□	150 k Ω		4700 K $\pm 2\%$	(4750 K)
ERTJ1VT224□	220 k Ω		4500 K $\pm 2\%$	(4580 K)

□ : Resistance tolerance code

Part number list of standard type (Resistance tolerance : ±5 %, ±3 %)

● Temperature and Resistance value (the resistance value at 25 °C is set to 1)/ Reference values

	ERTJ□□A to		ERTJ□□G to	ERTJ□□M to	ERTJ□□P to	ERTJ□□R to	ERTJ0ES to	ERTJ1VS to	ERTJ□□T to	ERTJ□□T to	ERTJ□□V to
B _{25/50}	2750 K	2800 K	(3375 K)	3900 K	4050 K	4250 K	4330 K	(4330 K)	4500 K	4500 K	4700 K
B _{25/85}	(2700 K)	(2750 K)	3435 K	(3970 K)	(4100 K)	(4300 K)	(4390 K)	4390 K	(4450 K)	(4580 K)	(4750 K)
T(°C)									*1	*2	
-40	13.05	13.28	20.52	32.11	33.10	43.10	45.67	45.53	63.30	47.07	59.76
-35	10.21	10.40	15.48	23.29	24.03	30.45	32.08	31.99	42.92	33.31	41.10
-30	8.061	8.214	11.79	17.08	17.63	21.76	22.80	22.74	29.50	23.80	28.61
-25	6.427	6.547	9.069	12.65	13.06	15.73	16.39	16.35	20.53	17.16	20.14
-20	5.168	5.261	7.037	9.465	9.761	11.48	11.91	11.89	14.46	12.49	14.33
-15	4.191	4.261	5.507	7.147	7.362	8.466	8.743	8.727	10.30	9.159	10.31
-10	3.424	3.476	4.344	5.444	5.599	6.300	6.479	6.469	7.407	6.772	7.482
-5	2.819	2.856	3.453	4.181	4.291	4.730	4.845	4.839	5.388	5.046	5.481
0	2.336	2.362	2.764	3.237	3.312	3.582	3.654	3.650	3.966	3.789	4.050
5	1.948	1.966	2.227	2.524	2.574	2.734	2.778	2.776	2.953	2.864	3.015
10	1.635	1.646	1.806	1.981	2.013	2.102	2.128	2.126	2.221	2.179	2.262
15	1.38	1.386	1.474	1.567	1.584	1.629	1.642	1.641	1.687	1.669	1.710
20	1.171	1.174	1.211	1.247	1.255	1.272	1.277	1.276	1.293	1.287	1.303
25	1	1	1	1	1	1	1	1	1	1	1
30	0.8585	0.8565	0.8309	0.8072	0.8016	0.7921	0.7888	0.7890	0.7799	0.7823	0.7734
35	0.7407	0.7372	0.6941	0.6556	0.6461	0.6315	0.6263	0.6266	0.6131	0.6158	0.6023
40	0.6422	0.6376	0.5828	0.5356	0.5235	0.5067	0.5004	0.5007	0.4856	0.4876	0.4721
45	0.5595	0.5541	0.4916	0.4401	0.4266	0.4090	0.4022	0.4025	0.3874	0.3884	0.3723
50	0.4899	0.4836	0.4165	0.3635	0.3496	0.3319	0.3251	0.3254	0.3111	0.3111	0.2954
55	0.4309	0.4238	0.3543	0.3018	0.2881	0.2709	0.2642	0.2645	0.2513	0.2504	0.2356
60	0.3806	0.3730	0.3027	0.2518	0.2386	0.2222	0.2158	0.2161	0.2042	0.2026	0.1889
65	0.3376	0.3295	0.2595	0.2111	0.1985	0.1832	0.1772	0.1774	0.1670	0.1648	0.1523
70	0.3008	0.2922	0.2233	0.1777	0.1659	0.1518	0.1463	0.1465	0.1377	0.1348	0.1236
75	0.2691	0.2600	0.1929	0.1504	0.1393	0.1264	0.1213	0.1215	0.1144	0.1108	0.1009
80	0.2417	0.2322	0.1672	0.1278	0.1174	0.1057	0.1011	0.1013	0.09560	0.09162	0.08284
85	0.2180	0.2081	0.1451	0.1090	0.09937	0.08873	0.08469	0.08486	0.08033	0.07609	0.06834
90	0.1974	0.1871	0.1261	0.09310	0.08442	0.07468	0.07122	0.07138	0.06782	0.06345	0.05662
95	0.1793	0.1688	0.1097	0.07980	0.07200	0.06307	0.06014	0.06028	0.05753	0.05314	0.04712
100	0.1636	0.1528	0.09563	0.06871	0.06166	0.05353	0.05099	0.05112	0.04903	0.04472	0.03939
105	0.1498	0.1387	0.08357	0.05947	0.05306	0.04568	0.04340	0.04351	0.04198	0.03784	0.03308
110	0.1377	0.1263	0.07317	0.05170	0.04587	0.03918	0.03708	0.03718	0.03609	0.03218	0.02791
115	0.1270	0.1153	0.06421	0.04512	0.03979	0.03374	0.03179	0.03188	0.03117	0.02748	0.02364
120	0.1175	0.1056	0.0565	0.03951	0.03460	0.02916	0.02734	0.02742	0.02702	0.02352	0.02009
125	0.1091	0.09695	0.04986	0.03470	0.03013	0.02527	0.02359	0.02367	0.02351	0.02017	0.01712

*1: Apply to products with a B_{25/50} constant of 4500 K and a resistance value of 25 °C less than 10 kΩ.

*2: Apply to products with a B_{25/50} constant of 4500 K and a resistance value of 25 °C of 10 kΩ or more.

* Applied only to ERTJ0ET104□

$$B_{25/50} = \frac{\ln(R_{25}/R_{50})}{1/298.15 - 1/323.15} \quad B_{25/85} = \frac{\ln(R_{25}/R_{85})}{1/298.15 - 1/358.15}$$

R₂₅=Resistance at 25.0±0.1 °C

R₅₀=Resistance at 50.0±0.1 °C

R₈₅=Resistance at 85.0±0.1 °C

Specification and test method

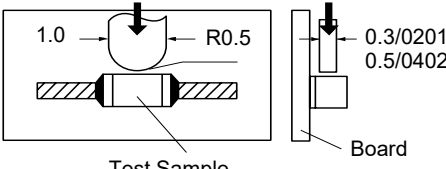
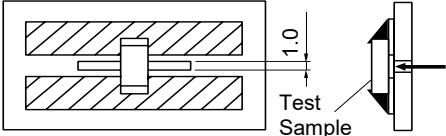
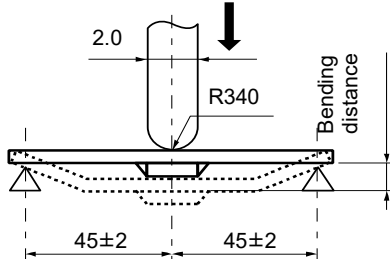
Item	Specifications	Testing method									
Rated Zero-power Resistance (R ₂₅)	Within the specified tolerance.	The value is measured at a power that the influence of self-heat generation can be negligible (0.1 mW or less), at the rated ambient temperature of 25.0 ± 0.1 °C.									
B Value	Shown in each Individual Specification. ※Individual Specification shall specify B _{25/50} or B _{25/85} .	The Zero-power resistances; R ₁ and R ₂ , shall be measured respectively at T ₁ (deg.C) T ₂ (deg.C) . The B value is calculated by the following equation. $B_{T_1/T_2} = \frac{\ln(R_1) - \ln(R_2)}{1/(T_1 + 273.15) - 1/(T_2 + 273.15)}$									
		<table border="1"> <thead> <tr> <th></th> <th>T₁</th> <th>T₂</th> </tr> </thead> <tbody> <tr> <td>B_{25/50}</td> <td>25.0 ± 0.1 °C</td> <td>50.0 ± 0.1 °C</td> </tr> <tr> <td>B_{25/85}</td> <td>25.0 ± 0.1 °C</td> <td>85.0 ± 0.1 °C</td> </tr> </tbody> </table>		T ₁	T ₂	B _{25/50}	25.0 ± 0.1 °C	50.0 ± 0.1 °C	B _{25/85}	25.0 ± 0.1 °C	85.0 ± 0.1 °C
	T ₁	T ₂									
B _{25/50}	25.0 ± 0.1 °C	50.0 ± 0.1 °C									
B _{25/85}	25.0 ± 0.1 °C	85.0 ± 0.1 °C									
Adhesion	The terminal electrode shall be free from peeling or signs of peeling.	<p>Applied force :</p> <p>Size 0201 : 2 N Size 0402, 0603 : 5 N Duration : 10 s Size : 0201, 0402</p>  <p>Test Sample Board</p> <p>Size : 0603 Unit : mm</p>  <p>Test Sample</p>									
Bending Strength	There shall be no cracks and other mechanical damage. R25 change: within ±5 %	<p>Bending distance : 1 mm Bending speed : 1 mm/ s</p>  <p>Unit : mm</p>									
Resistance to Soldering Heat	There shall be no cracks and other mechanical damage. (Narrow Tol. type) R25 change : within ±2 % B Value change : within ±1 % (Standard type) R25 change : within ±3 % B Value change : within ±2 %	<p>Soldering bath method Solder temperature : 270 ± 5 °C Dipping period : 3.0 ± 0.5 s Preheat condition</p> <table border="1"> <thead> <tr> <th>Step</th> <th>Temp (°C)</th> <th>Period(s)</th> </tr> </thead> <tbody> <tr> <td>1</td> <td>80 to 100</td> <td>120 to 180</td> </tr> <tr> <td>2</td> <td>150 to 200</td> <td>120 to 180</td> </tr> </tbody> </table>	Step	Temp (°C)	Period(s)	1	80 to 100	120 to 180	2	150 to 200	120 to 180
Step	Temp (°C)	Period(s)									
1	80 to 100	120 to 180									
2	150 to 200	120 to 180									
Solderability	More than 95 % of the soldered area of both terminal electrodes shall be covered with fresh solder.	<p>Soldering bath method Solder temperature : 230 ± 5 °C Dipping period : 4 ± 1 s Solder : Sn-3.0Ag-0.5Cu</p>									

Specification and test method

Item	Specifications	Testing method
Temperature cycling	(Narrow Tol. type)	Conditions of one cycle Step 1 : -40 °C, 30±3 min Step 2 : Room temp., 3 min max. Step 3 : 125 °C, 30±3 min Step 4 : Room temp., 3 min max. Number of cycles : 100 cycles
Humidity	R25 change : within ±2 % B Value change : within ±1 %	Temperature : 85 ±2 °C Relative humidity : 85 ±5 % Test period : 1000 +48/0 h
Biased humidity	(Standard type) R25 change : within ±3 % B Value change : within ±2 %	Temperature : 85 ±2 °C Relative humidity : 85 ±5 % Applied power : 10 mW(D.C.) Test period : 500 +48/0 h
Low temperature exposure		Temperature : -40 ±3 °C Test period : 1000 +48/0 h
High temperature exposure		Temperature : 125 ±3 °C Test period : 1000 +48/0 h

Typical application

- Temperature detection
Writing current control of HDD

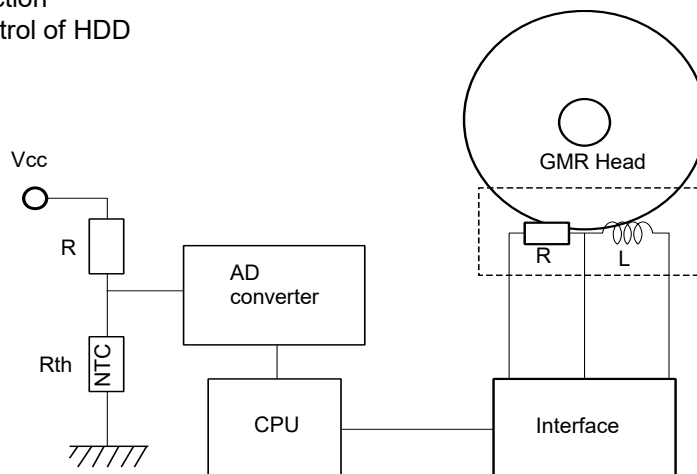

- Temperature compensation (Pseudo-linearization)
Contrast level control of LCD

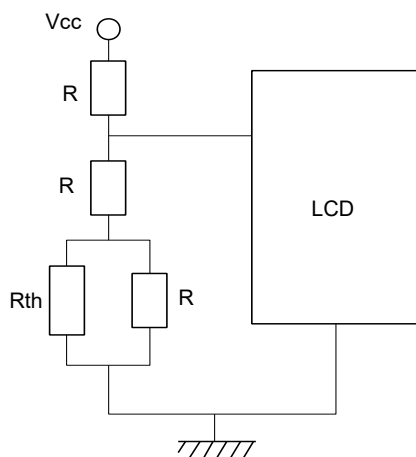

- Temperature compensation (RF circuit)
Temperature compensation of TCXO

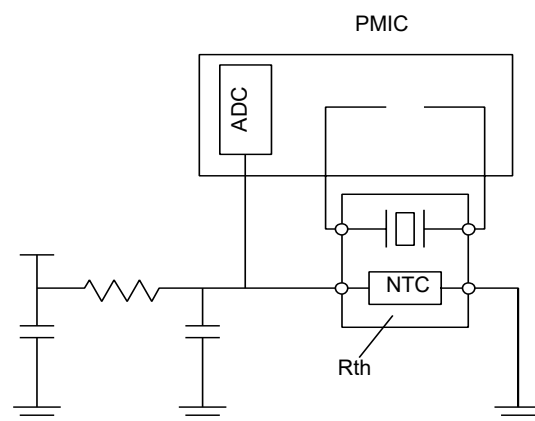

Dimensions in mm (not to scale)

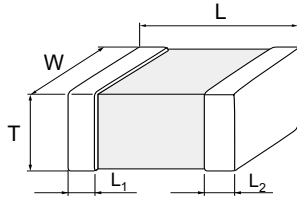

Unit : mm

Size code (inch size)	L	W	T	L ₁ L ₂
Z (0201)	0.60±0.03	0.30±0.03	0.30±0.03	0.15±0.05
0(0402)	1.0±0.1	0.50±0.05	0.50±0.05	0.25±0.15
1(0603)	1.60±0.15	0.8±0.1	0.8±0.1	0.3±0.2

Packaging methods (Taping)

● Standard packing quantities

Unit : mm

Size code (inch size)	Thickness	Kind of taping	Pitch	Quantity (pcs/reel)
Z (0201)	0.3	Pressed Carrier Taping	2	15,000
0(0402)	0.5	Punched Carrier Taping	2	10,000
1(0603)	0.8		4	4,000

● 2 mm Pitch (Pressed carrier taping) Size 0201

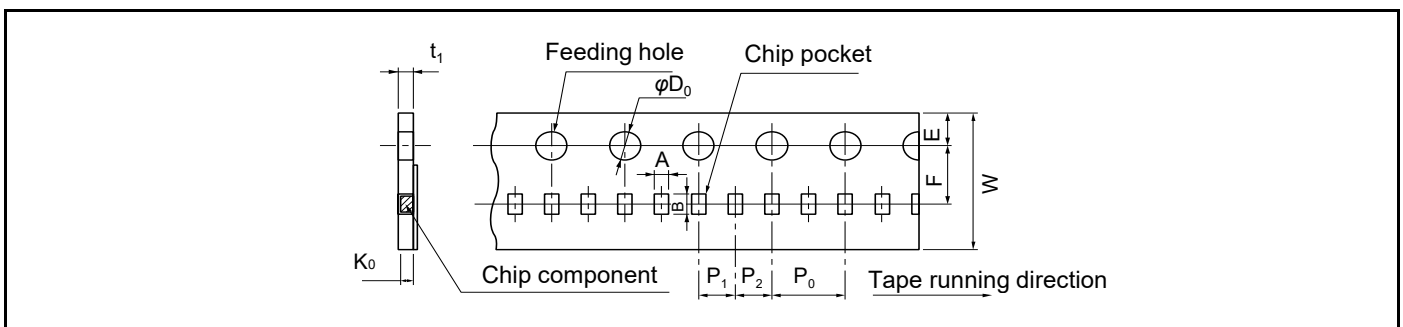

Symbol	A	B	W	F	E	P ₁	P ₂	P ₀	φD ₀	t ₁	K ₀
Unit (mm)	0.36 ±0.03	0.66 ±0.03	8.0 ±0.2	3.50 ±0.05	1.75 ±0.10	2.00 ±0.05	2.00 ±0.05	4.0 ±0.1	1.5 +0.1/0	0.55 max.	0.36 ±0.03

● 2 mm Pitch (Punched carrier taping) Size 0402

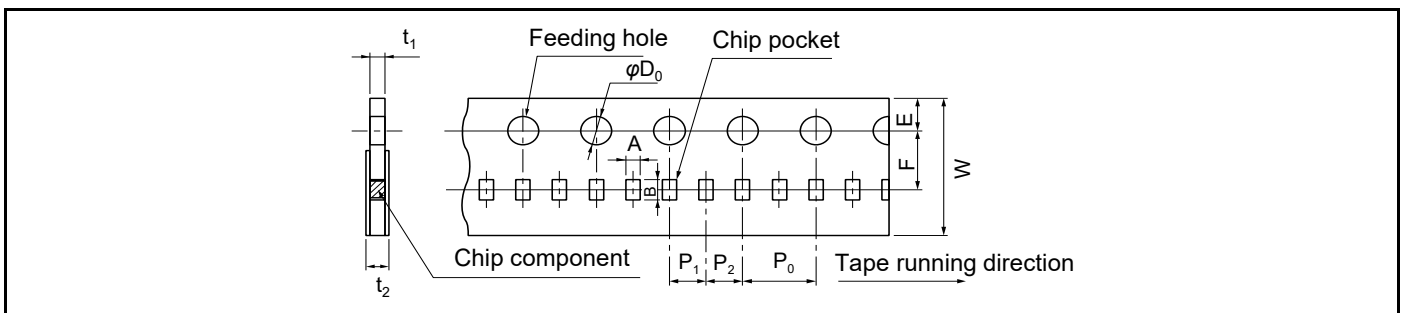

Symbol	A	B	W	F	E	P ₁	P ₂	P ₀	φD ₀	t ₁	t ₂
Unit (mm)	0.62 ±0.05	1.12 ±0.05	8.0 ±0.2	3.50 ±0.05	1.75 ±0.10	2.00 ±0.05	2.00 ±0.05	4.0 ±0.1	1.5 +0.1/0	0.7 max.	1.0 max.

● 4 mm Pitch (Punched Carrier Taping) Size 0603

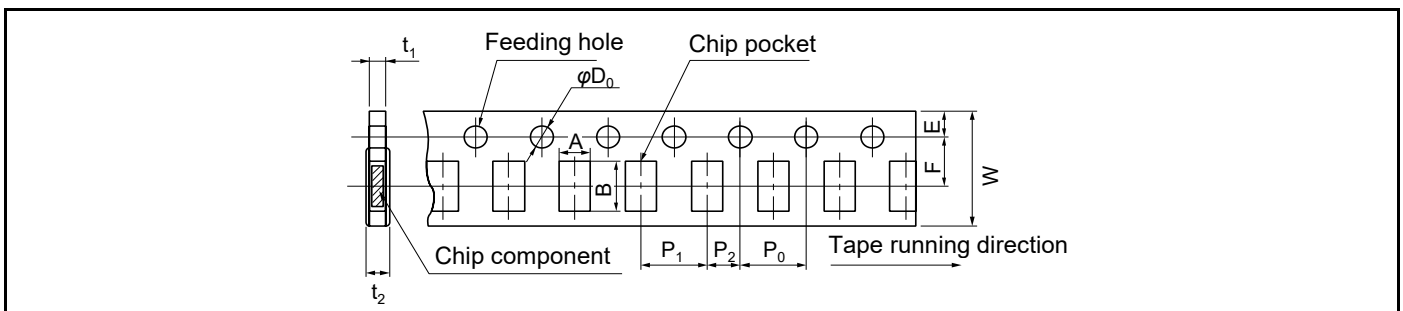

Symbol	A	B	W	F	E	P ₁	P ₂	P ₀	φD ₀	t ₁	t ₂
Unit (mm)	1.0 ±0.1	1.8 ±0.1	8.0 ±0.2	3.50 ±0.05	1.75 ±0.10	4.0 ±0.1	2.00 ±0.05	4.0 ±0.1	1.5 +0.1/0	1.1 max.	1.4 max.

Packaging methods (Taping)

● Reel for taping

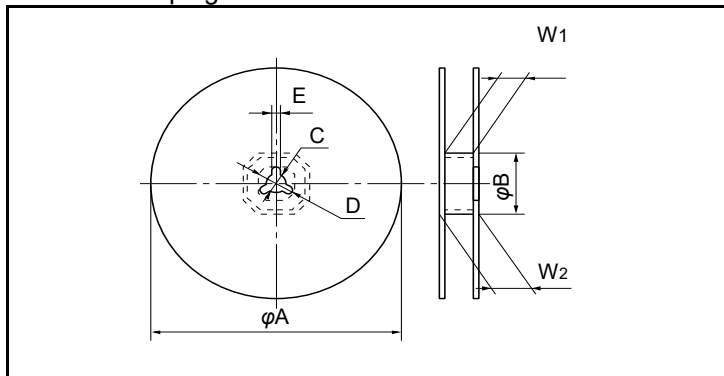

Symbol	ϕA	ϕB	C	D
Unit (mm)	180+0/-3	60.0+1.0/0	13.0±0.5	21.0±0.8
	E	W ₁	W ₂	
	2.0±0.5	9.0+1.0/0	11.4±1.0	

● Leader part and taped end

Leader part

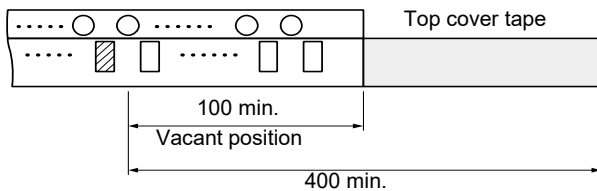

Taped end

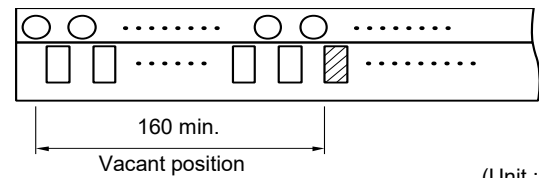

(Unit : mm)

Minimum quantity / Packing unit

Part number (inch size)	Minimum quantity / Packing unit	Packing quantity in carton	Carton L×W×H (mm)
ERTJZ (0201)	15,000	300,000	250×200×200
ERTJ0 (0402)	10,000	200,000	250×200×200
ERTJ1 (0603)	4,000	80,000	250×200×200

Part No., quantity and country of origin are designated on outer packages in English.

Matters to Be Observed When Using This Product

(NTC thermistor / Chip-type : For automotive)

Safety measures

- An NTC thermistor (chip-type) (hereinafter "the product" or "the thermistor") is intended for use in general-purpose and standard applications, such as temperature detection and temperature compensation in in-vehicle electronic equipment. The thermistor may deteriorate in performance or fail (short or open modes) when used improperly.
- If the thermistor in short mode is used, applied voltage may cause a large current to flow through the thermistor. Consequently, the thermistor heats up and may burn the circuit board. An abnormal state of the thermistor that results from a problem with its service conditions (use environment, design conditions, mounting conditions, etc.) may lead to, in a worst case scenario, burnout of the circuit board, serious accident, etc. Sufficiently check for what is described below before using the thermistor.

Use environments and cleaning conditions

- This product (thermistor) is not designed for use in the specific environments described below. Using the product in such specific environments or service conditions, therefore, may affect the performance of the product. Please check the performance and reliability of the product first and then use the product.
 - (1) Used in liquid, such as water, oil, chemicals, and organic solvents.
 - (2) Used in a place exposed to direct sunlight, an outdoor place with no shielding, or a dusty place.
 - (3) Used in a place where the product is heavily exposed to sea breeze or a corrosive gas, such as Cl₂, H₂S, NH₃, SO₂, or NO_x.
 - (4) Used in an environment where electromagnetic waves and radiation are strong.
 - (5) Located close to a heating component or a flammable material, such as a vinyl cable.
 - (6) Sealed or coated with a resin, etc.
 - (7) Solder flux of the soldered product is cleansed with a solvent, water, and a water-soluble cleaner (be careful with solder flux soluble to water).
 - (8) Used in a place where dew concentrates on the product.
 - (9) Used in a contaminated state. (Example) Touching a thermistor (with uncovered skin) mounted on a printed board leaves sebum on the thermistor. Do not handle the thermistor in this manner.
 - (10) Used in a place where excessive vibration or impact is applied to the product.
- Use the thermistor within the range of its specified ratings/capabilities. Using the thermistor under severe service conditions that are beyond the specified ratings/capabilities causes degraded performance or destruction of the thermistor, which may lead to scattering of thermistor fragments, smoke generation, ignition, etc. Do not use the thermistor at a working temperature or maximum allowable circuit voltage that exceeds the specified working temperature or maximum allowable circuit voltage. Do not locate the thermistor close to combustible materials.
- In an improper cleaning solution, with which the thermistor is cleaned, flux residues or other foreign matter may stick to the surface of the thermistor, which degrades the performance (insulation resistance, etc.) of the thermistor. In a polluted cleaning solution, the concentration of free halogen, etc., is high, and may result in poor/insufficient cleaning.
- Improper cleaning conditions (insufficient cleaning or excessive cleaning) may impair the performance of the thermistor.
 - (1) Insufficient cleaning
 - (a) A halogenous substance in flux residues may corrode a metal element, such as a terminal electrode.
 - (b) A halogenous substance in flux residues may stick to the surface of the thermistor and lower its insulation resistance.
 - (c) Tendencies described in (a) and (b) may be more notable with water-soluble flux than with rosin-based flux.Be careful about insufficient cleaning.
 - (2) Excessive cleaning

Ultrasonic waves that are too powerful from an ultrasonic cleaner cause the board to resonate, in which case the vibration of the board may cause the thermistor or a soldered part to crack or reduce the strength of the terminal electrode. Keep power output from the ultrasonic cleaner at 20 W/L or lower, its ultrasonic frequency at 40 kHz or lower, and an ultrasonic cleaning time at 5 minutes or less.

Response to anomalies and handling conditions

- Do not apply excessive mechanical impact to the thermistor. Because the thermistor body is made of ceramic, drop impact to the thermistor readily damages or cracks the thermistor. Once dropped on the floor, etc., the thermistor may have lost its sound quality and become failure-prone. Do not use said thermistor.
- When handling the board carrying the thermistor, be careful not to let the thermistor hit against another board. Take extra caution when handling or storing a stack of boards carrying thermistors. There are cases where a corner of a board will hit against a thermistor and damage or crack it, which may result in a failure of the thermistor, such as a drop in its insulation resistance. Do not reuse a thermistor that has been used on and removed from a board.

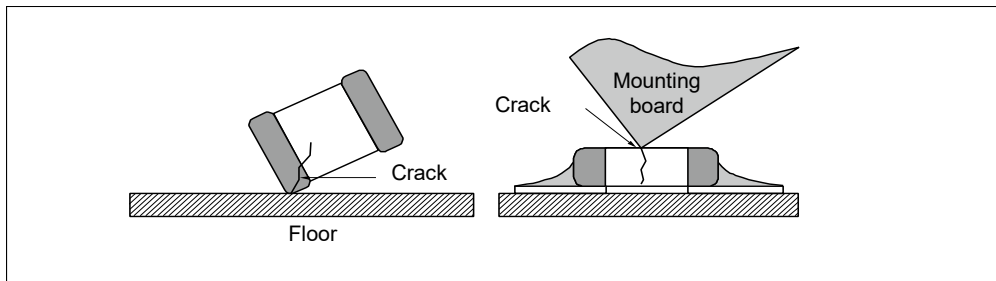

Reliability

To know the detailed specifications of individual products or specific evaluation test scores, please contact us.

We issue a delivery specification sheet for each product ordered. Please confirm with the sheet when you place an order with us.

Circuit design and circuit board design

- A working temperature at which a thermistor works in the circuit must be within the working temperature range specified in the specification sheet. A temperature at which a thermistor incorporated in the circuit is kept in storage without operating must be within the storage temperature range specified in the specification sheet. Do not use the thermistor at a higher temperature than the maximum working temperature.
- Ensure that a voltage applied across the terminals of the thermistor in use is equal to or lower than the maximum voltage (maximum power). When the thermistor is used in a condition where the thermistor is supplied with power exceeding the maximum power, self-heating by the thermistor becomes so intensive that the thermistor with high temperature may fail or burn out. Discuss safety measures, such as a protective circuit against an abnormal voltage, etc. The thermistor in use generates heat by itself even when supplied with power equal to or lower than the maximum power. This self-heating may make the thermistor incapable of exactly detecting the ambient temperature. When using the thermistor, ensure that a voltage applied across the terminals of the thermistor is equal to or lower than the maximum voltage (maximum power) and take the heat dissipation constant of the thermistor into consideration.

•Maximum power

It refers to the maximum of power that can be supplied consecutively to the thermistor in still air with a certain ambient temperature. Note that the maximum power when the ambient temperature is 25 °C or lower is equal to the rated power, and that the maximum power when the ambient temperature is higher than 25 °C follows a derating curve shown in a graph on the right.

•Heat dissipation constant

A heat dissipation constant represents power that the thermistor needs to raise its temperature by 1 °C by self-heating in a temperature steady state. Dividing power consumption by the thermistor by a temperature increment of the thermistor yields the heat dissipation constant.

The heat dissipation constant is expressed in units of (mW/ °C).

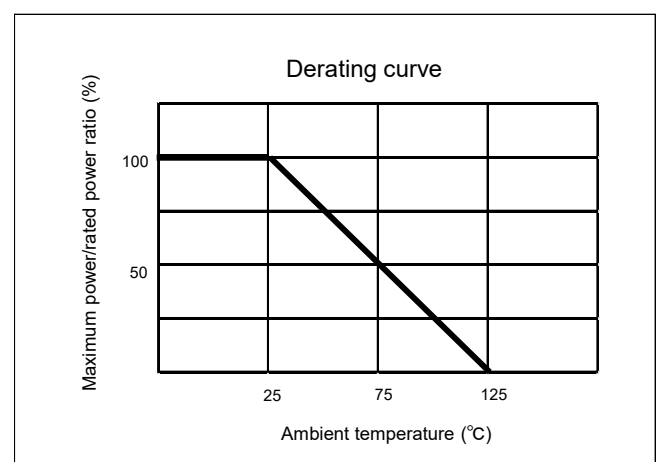

- The resistance of the thermistor changes with changes of the ambient temperature or by its self-heating. When measuring the resistance value of the thermistor in a circuit examination, acceptance inspection, etc., heed the following items.
 - ① Measurement : Measurement temperature shall be 25 ± 0.1 °C. We recommend measurement of the thermistor in a liquid (silicone oil, etc.) in which a measurement temperature is kept stable.
 - ② Power : Power supplied to the thermistor shall be 0.10 mW or less. We recommend resistance value measurement by a four-terminal measurement method, using a constant-current power supply.
- Using the thermistor on an alumina board has an expectation of performance degradation due to thermal impact (temperature cycle). Before using the thermistor, sufficiently confirm that the board does not affect the quality of the thermistor.

Mounting conditions

- The more solder deposited on the thermistor, the greater the stress to the thermistor, which leads to cracking of the thermistor. When designing a land on the board, determine the shape and dimensions of the land so that a proper volume of solder is applied in the land. Design the land such that its left and right sides are equal in size. In a case where solder volumes are different between the left and right sides of the land, a greater volume of solder takes more time to cool and solidify. As a result, stress acts on one side which may crack the thermistor.

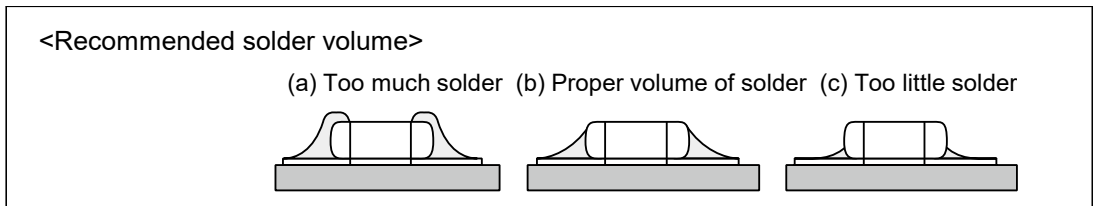

<Recommended land dimensions (example)>

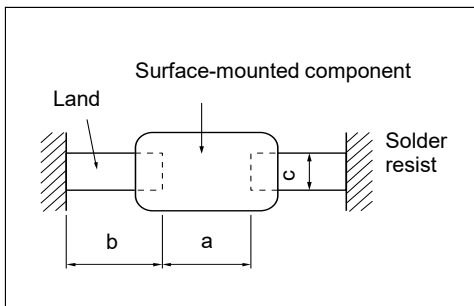

Shape symbol (JIS size)	Component dimensions			a	b	c
	L	W	T			
0 (1005)	1.0	0.5	0.5	0.4 to 0.5	0.4 to 0.5	0.4 to 0.5
1 (1608)	1.6	0.8	0.8	0.8 to 1.0	0.6 to 0.8	0.6 to 0.8

Unit: mm

<Using solder resist>

- Use solder resist to evenly distribute solder volumes on the left and right sides.
- When a component is located close to the thermistor, the thermistor is mounted together with a lead-attached component, or a chassis is located close to the thermistor, separate solder patterns from each other using the solder resist.

* Refer to cases to avoid and recommended examples shown on the right table.

Items	Case to avoid	Case recommended
		(Example of improving soldering by separating solder patterns)
Mounting the thermistor together with a lead-attached component	Lead of a lead-attached component 	Solder resist
Soldering in the vicinity of the chassis	Chassis Solder (earth solder) Electrode pattern 	Solder resist
Soldering a lead-attached component later	Lead of a component mounted later Solder iron 	Solder resist
Placing the products side by side	Part where too much solder is applied Land 	Solder resist

<Thermistor placement that avoids stress caused by warp in the board>

- When the board warps during or after soldering of the thermistor to the board, the warping of the board may cause the thermistor to crack. Place the thermistor so that stress caused by the warp is negligible to the thermistor.

Case to avoid	Case recommended
	 Set the thermistor sidewise relative to the direction in which

* Refer to the case to avoid and a case recommended example shown on the right table.

<Mechanical stress near a breaking line of the board>

- Mechanical stresses to the thermistor near a breaking line of the board vary depending on the mounting position of the thermistor. Refer to the figure on the right.
- The thermistor receives mechanical stresses different in size when the board is broken by different methods. The size of the stress the thermistor receives is smaller in the following order: pushing back<breaking along a slit<breaking along a V groove<breaking along a perforated line. In addition to thermistor placement, consider the board breaking method as well.

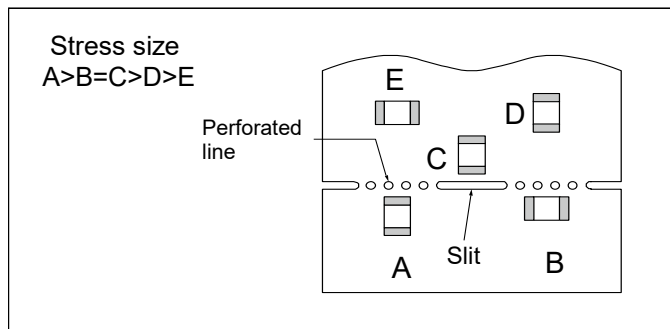

- When the thermistor is located near a heating element, such as a heater, if the thermistor is soldered directly to the heating element or is mounted together with the heating element on the same land, the thermistor exposed to a heat stress may crack. If you consider adopting such a layout, contact us first for consultation.

<Mounting density and space between components>

- When space between components is too narrow, solder bridges or solder balls have negative effects on the components. Be careful to provide proper space between the components.

<Mounting on the board>

- When the thermistor is mounted on the board, an excessive impact load, such as pressure from a suction nozzle for mounting the thermistor and mechanical impact/stress caused by a positional shift or positioning, may be applied to the thermistor. Prevent application of such an excessive impact load to the thermistor.
- A mounter needs to be checked and maintained regularly.
- When the bottom dead center of the suction nozzle is too low, an excessively large force is applied to the thermistor when it is mounted, which may crack the thermistor. Heed the following instructions when using the suction nozzle.
 - Set the bottom dead center of the suction nozzle at the upper surface of the straightened board.
 - Set the pressure of the suction nozzle equal to a static load between 1 N to 3 N.
 - In the case of double-face mounting, put a backup pin on the lower surface (back) of the board to prevent the board from warping. This keeps the impact of the suction nozzle as small as possible. Typical examples of using the backup pin are shown in the following table.

Items	Case to avoid	Case recommended
Single-face mounting	 Crack	 Backup pin
Double-face mounting	 Solder separation Crack	 Backup pin

(4) Adjust the suction nozzle so that its bottom dead center is not too low.

- When positioning grippers wear out, they apply mechanical impact to part of the thermistor when positioning it, thus chipping or cracking the thermistor in some cases. Maintain the proper dimensions of the positioning grippers in their closed state and regularly carry out maintenance, check, or replacement of the positioning grippers.

- A thermistor mounted on a heavily warped printed board, may crack or break. Put a backup pin on the back of the board to reduce the warp of the board to 0.5 mm or less with 90 mm span width.

<Selecting flux>

- Flux may have a great effect on the performance of the thermistor. Before using the thermistor, check whether the flux has any effect on the performance of the thermistor.
 - (1) Use flux containing a halogen-based substance of 0.1 wt% (in terms of chlorine) or less. Do not use highly acidic flux.
 - (2) Water-soluble flux remaining on the thermistor surface may impair its insulation resistance when cleaning work is insufficient. When using the water-soluble flux, clean the soldered part sufficiently to eliminate flux residues.

<Soldering>

- Reflow soldering

A temperature condition under which reflow soldering is performed is represented by a temperature curve consisting of a preheating part, a temperature-rising part, a main heating part, and a gradual cooling part. Heating the thermistor rapidly creates excessive heat stress therein due to a large temperature difference and, because of this heat stress, the thermistor may thermally crack. Be sufficiently careful with a temperature difference resulting from rapid heating. The preheating part is a temperature area that is important for preventing a tombstone (chip rising) phenomenon. Be sufficiently careful with temperature control.

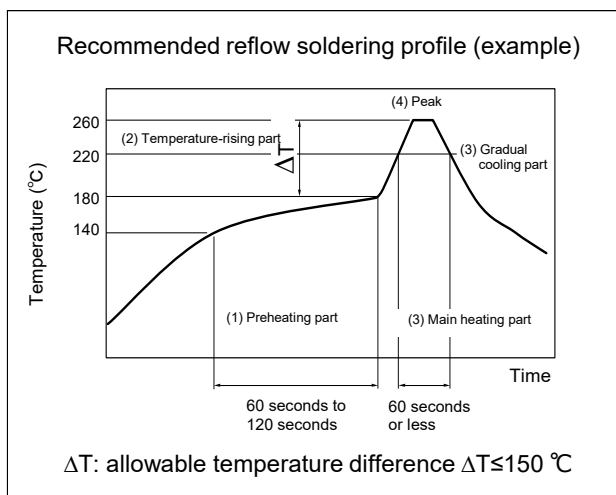

Items	Temperature condition	Time, heating rate
(1) Preheating part	140 °C to 180 °C	60 to 120 seconds
(2) Temperature-rising part	Preheating temperature to peak temperature	2 to 5 °C per second
(3) Main heating part	220 °C or higher	60 seconds or less
(4) Peak	260 °C or less	10 seconds or less
(5) Gradual cooling part	Peak temperature to 140 °C	1 to 4 °C per second

Avoid performing rapid cooling (forced cooling) during the gradual cooling part. Rapidly cooling the thermistor may result in thermal cracking of the thermistor. When dipping the thermistor in the cleaning solution right after soldering the thermistor, confirm that the surface temperature of the thermistor is 100 °C or lower. There is no problem with two cycles of reflow soldering under the recommended reflow soldering profile (example) conditions shown in the above diagram. Be sufficiently careful with deflection or warping of the board.

Note that the recommended soldering conditions indicate conditions under which the degradation of the product characteristics does not occur but do not indicate conditions under which stable soldering can be performed. Check and set conditions under which stable soldering can be performed, on a case-by-case basis.

- thermistor temperatures vary depending on the mounted state of the thermistor. Make sure to confirm that the surface temperature of the thermistor is within the specified temperature when the thermistor is mounted and then use the thermistor.

In soldering-iron soldering, stress created by a rapid temperature change is applied directly to the thermistor. Be sufficiently careful in controlling the temperature of the soldering iron tip. Be careful not to let the soldering iron tip come in direct contact with the thermistor or its terminal electrode.

The thermistor is particularly vulnerable to rapid heating and rapid cooling. When heated or cooled rapidly, the thermistor develops excessive heat stress therein resulting from the large temperature difference and because of this heat stress, may thermally crack. Observe the following instructions on preheating, gradual cooling, etc.

Once a thermistor soldered with a soldering iron is removed from the board, it cannot be used again.

(1) Condition 1 (preheating included)

- (a) Solder: : Use wire solder (with less chloride content) that is meant for soldering precision electronic equipment. (Wire diameter: 1.0 mm or less)
- (b) Preheating: : Preheat the thermistor sufficiently so that the difference between the solder temperature and the surface temperature of the thermistor is 150°C or less.
- (c) Temperature of the soldering iron tip : 300°C or lower (a required volume of solder is melted on the soldering iron tip in advance).
- (d) Gradual coolin : After soldering the thermistor, leave it in normal temperature conditions to let it cool gradually.

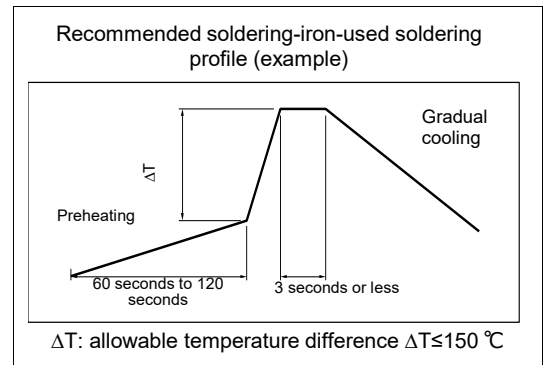

(2) Condition 2 (preheating not included)

If soldering iron tip conditions listed in the table on the right are met, the thermistor can be soldered with the soldering iron without preheating the thermistor.

- (a) Make sure that the soldering iron tip does not come in direct contact with the thermistor or its terminal electrode.
- (b) After preheating the land sufficiently with the soldering-iron tip, slide the soldering-iron tip toward the terminal electrode of the thermistor to solder the thermistor.

Soldering iron tip conditions in soldering without preheating

Items	Condition
Temperature of the soldering iron tip	270 °C or lower
Wattage	20 W or less
Shape of the soldering iron tip	ø3 mm or less
Soldering-iron applying time	3 seconds or less

<Inspection>

- When the printed board is inspected with measurement terminal pins after the thermistor is mounted on the board, the measurement terminal pins pressed against the printed board cause the board to warp, which may cause a crack to form on the thermistor.
 - (1) Put the backup pin on the back of the printed board to reduce the warp of the board to 0.5 mm or less with a 90 mm span width.
 - (2) Check whether the shape of the front ends of the measurement terminal pins poses no problem, whether the pins are equal in length, whether the pressure of the pins are not excessively high, and whether the set position of the pins is correct.

Items	Case to avoid	Case recommended
Warp in the board	<p>Measurement terminal pin</p> <p>Peeling, cracking</p>	<p>Measurement terminal pin</p> <p>Backup pin</p>

<Protective coat>

- When the thermistor is coated with or embedded in a resin to improve the thermistor's resistance to humidity and gas or to set the thermistor stationary, it is expected that the following problems will arise. In such cases, confirm the performance and reliability of the thermistor in advance.
 - (1) A solvent included in the resin infiltrates the thermistor and impairs its characteristics.
 - (2) Heat from chemical reaction (curing heat) generated by the resin when it cures exerts a negative effect on the thermistor.
 - (3) Expansion/shrinkage of the resin applies stress to the soldering part and causes it to crack.

<Splitting a multiple formation printed board>

- When splitting the board having components, including a mounted thermistor into multiple pieces, be careful not to apply bending stress or torsional stress to the board. If bending stress or torsional stress, shown in the following diagram, is applied to the board when it is split, the thermistor may develop a crack. Avoid, as much as possible, applying stress to the board.

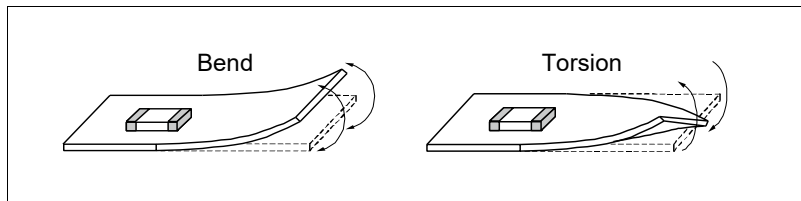

- Avoid manually splitting the board so as to keep mechanical stress to the board as small as possible. When splitting the board, use a splitting jig or a board splitter.
- Example of a board splitting jig
An example of a board splitting jig is shown in the following diagram. Holding the part of the board that is far from the jig and applying a load bend the board excessively. Holding the part of the board that is closer to the jig and applying a load allow you to split the board with less bending.

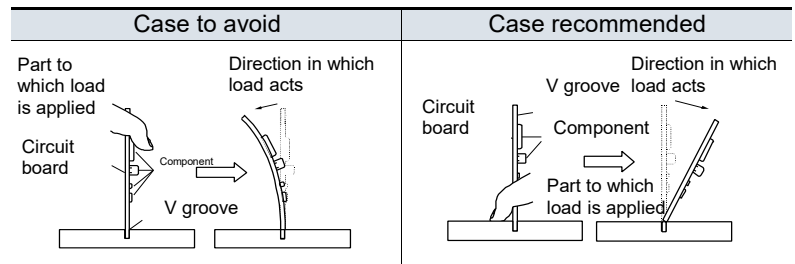
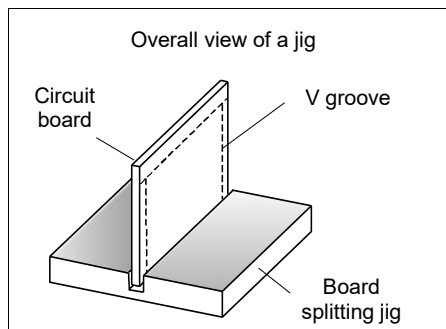

Storage conditions

- Avoid a high-temperature/high-humidity storage place and keep the thermistor in a storage place where temperature ranges from 5 °C to 40 °C and relative humidity ranges from 20% to 70%.
- Do not store the thermistor in a place where moisture, dust, or corrosive gas (hydrogen chloride, hydrogen sulfide, sulfur dioxide, ammonia, etc.) is present. It may impair the solderability of the terminal electrode. Also, in places where the thermistor package is exposed to heat, direct sunlight, etc., packaging tape may deform or stick to the thermistor which causes a problem when the thermistor is mounted. Be careful in such cases.
- A thermistor storage period shall be 12 months or less. When using a thermistor kept in storage for more than 12 months, confirm its solderability before using it.

Multilayer NTC Thermistors (Automotive Grade)

ERTJ-M series

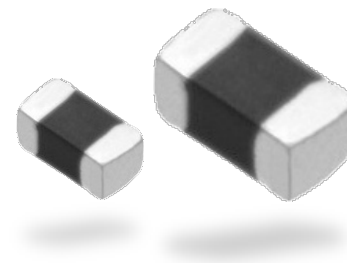

Features

- Surface Mount Device (0402・0603)
- Highly reliable multilayer / monolithic structure
- Wide temperature operating range (-40 to 150 °C)
- Environmentally-friendly lead-free
- RoHS compliant
- Automotive grade (this product can be tested under the conditions according to AEC-Q200 and the test results can be submitted.)

Recommended applications

- For car audio system
- For ECUs
- For electric pumps and compressors
- For LED lights
- For batteries
- For temperature detection of various circuits

Explanation of part numbers

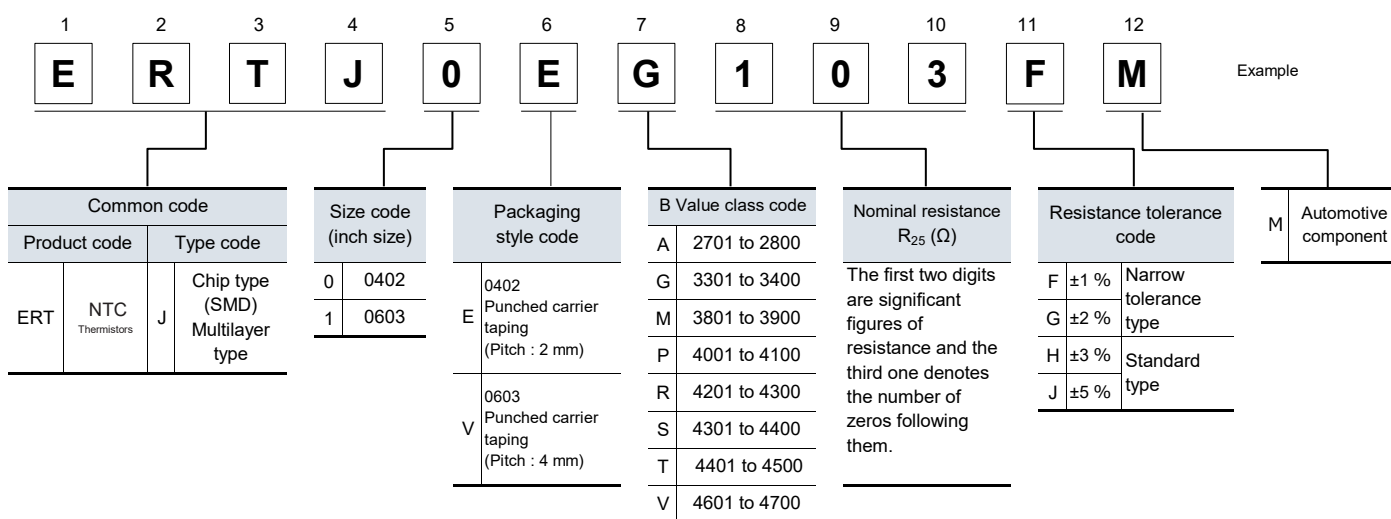

Construction

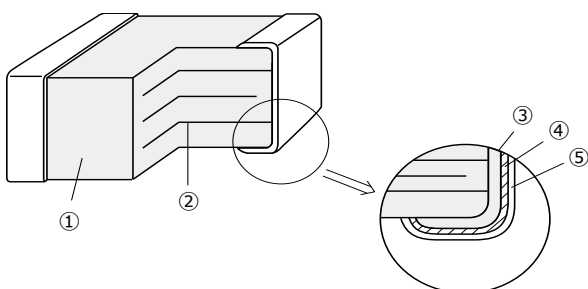

No.	Name	
①	Semiconductive ceramics	
②	Internal electrode	
③	Terminal electrode	Substrate electrode
④		Intermediate electrode
⑤		External electrode

Multilayer NTC Thermistors (Automotive Grade)

Ratings

Size code (inch size)	0(0402)	1(0603)
Operating temperature range	-40 to 150 °C	
Rated maximum power dissipation ^{*1}	66 mW	100 mW
Dissipation factor ^{*2}	Approximately 2 mW / °C	Approximately 3 mW / °C

- *1: Rated Maximum Power Dissipation : The maximum power that can be continuously applied at the rated ambient temperature.
 • The maximum value of power, and rated power is same under the condition of ambient temperature 25 °C or less. If the temperature exceeds 25 °C, rated power depends on the decreased power dissipation curve.
 • Please see "Operating Power" for details.
- *2: Dissipation factor : The constant amount power required to raise the temperature of the Thermistor 1 °C through self heat generation under stable temperatures.
 • Dissipation factor is the reference value when mounted on a glass epoxy board (1.6 mmT).

Part number list

● 0402 inch size

Part number	Nominal resistance at 25 °C (Ω)	B Value at 25/50 (K)	B Value at 25/85 (K)
ERTJ0EG202GM	2 kΩ±2 %	(3380 K)	3410 K±0.5 %
ERTJ0EG202HM	2 kΩ±3 %	(3380 K)	3410 K±0.5 %
ERTJ0EG202JM	2 kΩ±5 %	(3380 K)	3410 K±0.5 %
ERTJ0EG103□M	10 kΩ	3380 K±1 %	3435 K±1 %
ERTJ0EP473□M	47 kΩ	4050 K±1 %	(4100 K)
ERTJ0ER104□M	100 kΩ	4250 K±1 %	(4300 K)
ERTJ0ET104□M	100 kΩ	4485 K±1 %	(4550 K)
ERTJ0EV104□M	100 kΩ	4700 K±1 %	(4750 K)
ERTJ0EV474□M	470 kΩ	4700 K±1 %	(4750 K)

● 0603 inch size

Part number	Nominal resistance at 25 °C (Ω)	B Value at 25/50 (K)	B Value at 25/85 (K)
ERTJ1VK102□M	1 kΩ	3650 K±1 %	(3690 K)
ERTJ1VG103□M	10 kΩ	3380 K±1 %	3435 K±1 %
ERTJ1VP473□M	47 kΩ	4100 K±1 %	(4150 K)
ERTJ1VR104□M	100 kΩ	4200 K±1 %	(4250 K)
ERTJ1VV104□M	100 kΩ	4700 K±1 %	(4750 K)
ERTJ1VT224□M	220 kΩ	4485 K±1 %	(4550 K)

□ : Resistance Tolerance Code
 (F:±1 %, G:±2 %, H:±3 %, J:±5 %)

● Temperature and resistance value (the resistance value at 25 °C is set to 1) / Reference values

	ERTJ□□G~	ERTJ1VK~	ERTJ0EP~	ERTJ1VP~	ERTJ0ER~	ERTJ1VR~	ERTJ□□T~	ERTJ□□V~
B _{25/50}	(3380 K)	3650 K	4050 K	4100 K	4250 K	4200 K	4485 K	4700 K
B _{25/85}	3435 K	(3690 K)	(4100 K)	(4150 K)	(4300 K)	(4250 K)	(4550 K)	(4750 K)
T(°C)								
-40	20.52	25.77	33.10	34.56	42.40	40.49	46.47	59.76
-35	15.48	19.10	24.03	24.99	29.96	28.81	32.92	41.10
-30	11.79	14.29	17.63	18.26	21.42	20.72	23.55	28.61
-25	9.069	10.79	13.06	13.48	15.50	15.07	17.00	20.14
-20	7.037	8.221	9.761	10.04	11.33	11.06	12.38	14.33
-15	5.507	6.312	7.362	7.546	8.370	8.198	9.091	10.31
-10	4.344	4.883	5.599	5.720	6.244	6.129	6.729	7.482
-5	3.453	3.808	4.291	4.369	4.699	4.622	5.019	5.481
0	2.764	2.993	3.312	3.362	3.565	3.515	3.772	4.050
5	2.227	2.372	2.574	2.604	2.725	2.694	2.854	3.015
10	1.806	1.892	2.013	2.030	2.098	2.080	2.173	2.262
15	1.474	1.520	1.584	1.593	1.627	1.618	1.666	1.710
20	1.211	1.229	1.255	1.258	1.271	1.267	1.286	1.303
25	1	1	1	1	1	1	1	1
30	0.8309	0.8185	0.8016	0.7994	0.7923	0.7944	0.7829	0.7734
35	0.6941	0.6738	0.6461	0.6426	0.6318	0.6350	0.6168	0.6023
40	0.5828	0.5576	0.5235	0.5194	0.5069	0.5108	0.4888	0.4721
45	0.4916	0.4639	0.4266	0.4222	0.4090	0.4132	0.3896	0.3723
50	0.4165	0.3879	0.3496	0.3451	0.3320	0.3363	0.3123	0.2954
55	0.3543	0.3258	0.2881	0.2837	0.2709	0.2752	0.2516	0.2356
60	0.3027	0.2749	0.2386	0.2344	0.2222	0.2263	0.2037	0.1889
65	0.2595	0.2330	0.1985	0.1946	0.1831	0.1871	0.1658	0.1523
70	0.2233	0.1984	0.1659	0.1623	0.1516	0.1554	0.1357	0.1236
75	0.1929	0.1696	0.1393	0.1359	0.1261	0.1297	0.1117	0.1009
80	0.1672	0.1456	0.1174	0.1143	0.1054	0.1087	0.09236	0.08284
85	0.1451	0.1255	0.09937	0.09658	0.08843	0.09153	0.07675	0.06834
90	0.1261	0.1087	0.08442	0.08189	0.07457	0.07738	0.06404	0.05662
95	0.1097	0.09440	0.07200	0.06969	0.06316	0.06567	0.05366	0.04712
100	0.09563	0.08229	0.06166	0.05957	0.05371	0.05596	0.04518	0.03939
105	0.08357	0.07195	0.05306	0.05117	0.04585	0.04786	0.03825	0.03308
110	0.07317	0.06311	0.04587	0.04415	0.03929	0.04108	0.03255	0.02791
115	0.06421	0.05552	0.03979	0.03823	0.03378	0.03539	0.02781	0.02364
120	0.05650	0.04899	0.03460	0.03319	0.02913	0.03059	0.02382	0.02009
125	0.04986	0.04336	0.03013	0.02886	0.02519	0.02652	0.02043	0.01712
130	0.04413	0.03849	0.02629	0.02513	0.02184	0.02307	0.01755	0.01464
135	0.03916	0.03426	0.02298	0.02193	0.01898	0.02013	0.01511	0.01256
140	0.03483	0.03058	0.02013	0.01918	0.01654	0.01762	0.01304	0.01080
145	0.03105	0.02736	0.01767	0.01680	0.01445	0.01546	0.01127	0.00931
150	0.02774	0.02454	0.01553	0.01476	0.01265	0.01361	0.00976	0.00806

$$B_{25/50} = \frac{\ln(R_{25}/R_{50})}{1/298.15 - 1/323.15}$$

$$B_{25/85} = \frac{\ln(R_{25}/R_{85})}{1/298.15 - 1/358.15}$$

R₂₅=Resistance at 25.0±0.1 °C
 R₅₀=Resistance at 50.0±0.1 °C
 R₈₅=Resistance at 85.0±0.1 °C

Multilayer NTC Thermistors (Automotive Grade)

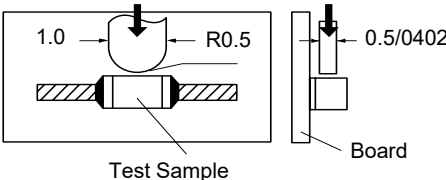
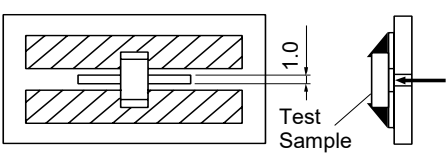
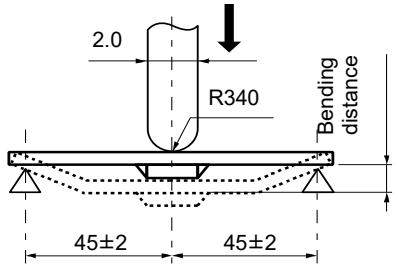
Specification and test method											
Item	Specifications	Testing method									
Rated Zero-power Resistance (R ₂₅)	Within the specified tolerance.	The value is measured at a power that the influence of self-heat generation can be negligible (0.1 mW or less), at the rated ambient temperature of 25.0 ± 0.1 °C.									
B Value	Shown in each Individual Specification. ※Individual Specification shall specify B _{25/50} or B _{25/85} .	<p>The Zero-power resistances; R₁ and R₂, shall be measured respectively at T₁ (deg.C) T₂ (deg.C) . The B value is calculated by the following equation.</p> $B_{T_1/T_2} = \frac{\ln(R_1) - \ln(R_2)}{1/(T_1 + 273.15) - 1/(T_2 + 273.15)}$ <table border="1" style="width: 100%; text-align: center;"> <thead> <tr> <th></th> <th>T₁</th> <th>T₂</th> </tr> </thead> <tbody> <tr> <td>B_{25/50}</td> <td>25.0 ± 0.1 °C</td> <td>50.0 ± 0.1 °C</td> </tr> <tr> <td>B_{25/85}</td> <td>25.0 ± 0.1 °C</td> <td>85.0 ± 0.1 °C</td> </tr> </tbody> </table>		T ₁	T ₂	B _{25/50}	25.0 ± 0.1 °C	50.0 ± 0.1 °C	B _{25/85}	25.0 ± 0.1 °C	85.0 ± 0.1 °C
	T ₁	T ₂									
B _{25/50}	25.0 ± 0.1 °C	50.0 ± 0.1 °C									
B _{25/85}	25.0 ± 0.1 °C	85.0 ± 0.1 °C									
Adhesion	The terminal electrode shall be free from peeling or signs of peeling.	<p>Applied force : Size 0402, 0603 : 5 N Duration : 10 s</p> <p>Size : 0402</p>  <p style="text-align: center;">Test Sample</p> <p style="text-align: right;">Board</p> <p>Size : 0603</p>  <p style="text-align: center;">Test Sample</p> <p style="text-align: right;">Board</p> <p style="text-align: right;">Unit : mm</p>									
Bending Strength	There shall be no cracks and other mechanical damage. R25 change : within ± 5 %	<p>Bending distance : 2 mm Bending speed : 1 mm/ s</p>  <p style="text-align: right;">Unit : mm</p>									
Resistance to Vibration	There shall be no cracks and other mechanical damage. R25 change : within ± 2 % B Value change : within ± 1 %	<p>Solder samples on a testing substrate, then apply vibration to them.</p> <p>Acceleration : 5 G Vibrational frequency : 10 to 2000 Hz Sweep time : 20 minutes 12 cycles in three directions, which are perpendicular to each other</p>									
Resistance to Impact	There shall be no cracks and other mechanical damage. R25 change : within ± 2 % B Value change : within ± 1 %	<p>Solder samples on a testing substrate, then apply impacts to them.</p> <p>Pulse waveform : Semisinusoidal wave, 11 ms Impact acceleration : 50 G Impact direction : X-X', Y-Y', Z-Z' In 6 directions, three times each</p>									

Multilayer NTC Thermistors (Automotive Grade)

Specification and test method

Item	Specifications	Testing method									
Resistance to Soldering Heat	There shall be no cracks and other mechanical damage. R25 change : within ± 2 % B Value change : within ± 1 %	Soldering bath method Solder temperature : 260 ± 5 °C, 270 ± 5 °C Dipping period : 3.0 ± 0.5 s, 10.0 ± 0.5 s Preheat condition									
		<table border="1"> <thead> <tr> <th>Step</th> <th>Temp (°C)</th> <th>Period(s)</th> </tr> </thead> <tbody> <tr> <td>1</td> <td>80 to 100</td> <td>120 to 180</td> </tr> <tr> <td>2</td> <td>150 to 200</td> <td>120 to 180</td> </tr> </tbody> </table>	Step	Temp (°C)	Period(s)	1	80 to 100	120 to 180	2	150 to 200	120 to 180
		Step	Temp (°C)	Period(s)							
		1	80 to 100	120 to 180							
2	150 to 200	120 to 180									
Solderability	More than 95 % of the soldered area of both terminal electrodes shall be covered with fresh solder.	Soldering bath method Solder temperature : 230 ± 5 °C Dipping period : 4 ± 1 s Solder : Sn-3.0Ag-0.5Cu									
Temperature Cycling	R25 change : within ± 2 % B Value change : within ± 1 %	Conditions of one cycle Step 1 : -55 ± 3 °C, 30 ± 3 min Step 2 : Room temp., 3 min max. Step 3 : 125 ± 5 °C, 30 ± 3 min Step 4 : Room temp., 3 min max. Number of cycles : 2000 cycles									
Humidity	R25 change : within ± 2 % B Value change : within ± 1 %	Temperature : 85 ± 2 °C Relative humidity : 85 ± 5 % Test period : 2000 +48/0 h									
Biased Humidity	R25 change : within ± 2 % B Value change : within ± 1 %	Temperature : 85 ± 2 °C Relative humidity : 85 ± 5 % Applied power : 10 mW(D.C.) Test period : 2000 +48/0 h									
Low Temperature Exposure	R25 change : within ± 2 % B Value change : within ± 1 %	Temperature : -40 ± 3 °C Test period : 2000 +48/0 h									
High Temperature Exposure 1	R25 change : within ± 2 % B Value change : within ± 1 %	Temperature : 125 ± 3 °C Test period : 2000 +48/0 h									
High Temperature Exposure 2	R25 change : within ± 3 % R25 change : within ± 2 %	Temperature : 150 ± 3 °C Test period : 1000 +48/0 h									

Multilayer NTC Thermistors (Automotive Grade)

Dimensions in mm (not to scale)

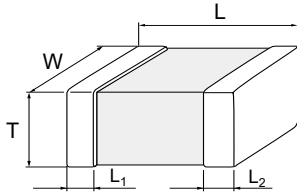

Unit : mm

Size code (inch size)	L	W	T	L ₁ L ₂
0(0402)	1.0±0.1	0.50±0.05	0.50±0.05	0.25±0.15
1(0603)	1.60±0.15	0.8±0.1	0.8±0.1	0.3±0.2

Packaging methods (Taping)

● Standard packing quantities

Unit : mm

Size code (inch size)	Thickness	Kind of taping	Pitch	Quantity (pcs/reel)
0(0402)	0.5	Punched carrier taping	2	10,000
1(0603)	0.8		4	4,000

● 2 mm Pitch (Punched Carrier Taping) Size 0402

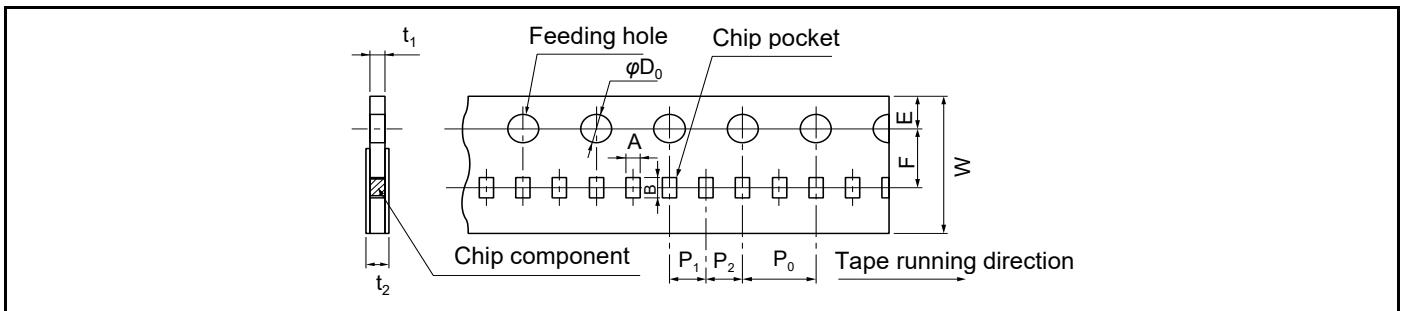

Symbol	A	B	W	F	E	P ₁	P ₂	P ₀	φD ₀	t ₁	t ₂
Unit (mm)	0.62 ±0.05	1.12 ±0.05	8.0 ±0.2	3.50 ±0.05	1.75 ±0.10	2.00 ±0.05	2.00 ±0.05	4.0 ±0.1	1.5 +0.1/0	0.7 max.	1.0 max.

● 4 mm Pitch (Punched Carrier Taping) Size 0603

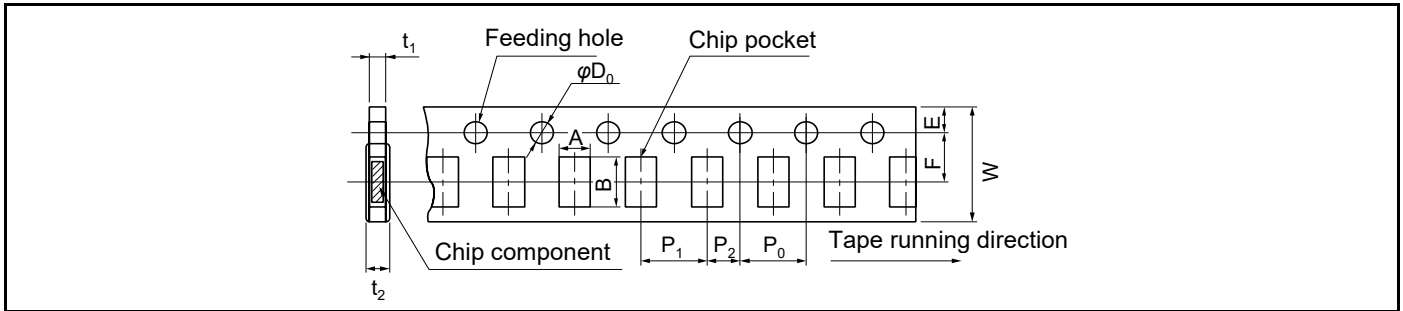

Symbol	A	B	W	F	E	P ₁	P ₂	P ₀	φD ₀	t ₁	t ₂
Unit (mm)	1.0 ±0.1	1.8 ±0.1	8.0 ±0.2	3.50 ±0.05	1.75 ±0.10	4.0 ±0.1	2.00 ±0.05	4.0 ±0.1	1.5 +0.1/0	1.1 max.	1.4 max.

● Reel for Taping

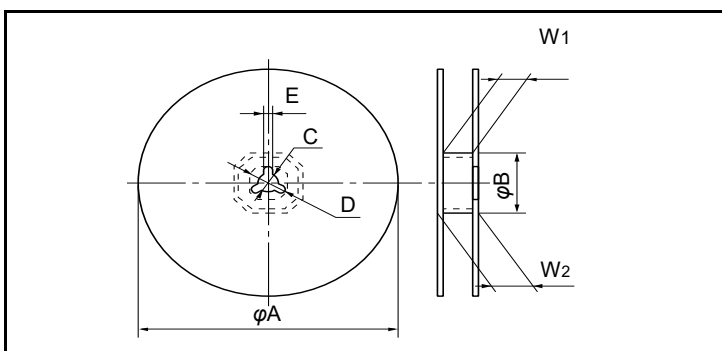

Symbol	φA	φB	C	D
Unit (mm)	180+0/-3	60.0+1.0/0	13.0±0.5	21.0±0.8
	E	W ₁	W ₂	
	2.0±0.5	9.0+1.0/0	11.4±1.0	

Packaging methods (Taping)

- Leader part and taped end

Leader part

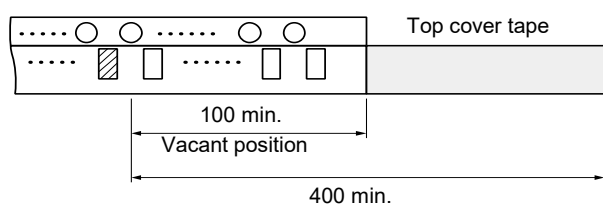

Taped end

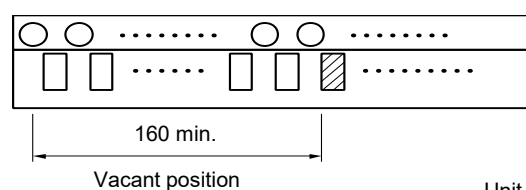

Unit : mm

Minimum quantity / Packing unit

Part number (inch size)	Minimum quantity / Packing unit	Packing quantity in carton	Carton L×W×H (mm)
ERTJ0 (0402)	10,000	200,000	250×200×200
ERTJ1 (0603)	4,000	80,000	250×200×200

Part No., quantity and country of origin are designated on outer packages in English.

Matters to Be Observed When Using This Product (PGS graphite sheet)

Use environments

- This product (graphite sheet) is not designed for use in specific environments. Using the product in specific environments or service conditions described below, therefore, may affect the performance of the product. Please check the performance and reliability of the product first and then use the product.
 - (1) Used in liquid, such as water, oil, chemicals, and organic solvents.
 - (2) Used in a place exposed to direct sunlight, an outdoor place with no shielding, or a dusty place.
 - (3) Used in a place where the product is heavily exposed to sea breeze or a corrosive gas, such as Cl₂, H₂S, NH₃, SO₂, or NO_x.
 - (4) Used in a contaminated state.
 - (5) Used in a place where acid is present nearby.
 - (6) Used in a temperature condition outside a specified working temperature range.
 - (7) Used in a depressurized or vacuum atmosphere.
- Temperatures of the graphite sheet in use vary depending on mounting conditions, service conditions, etc. Make sure to confirm that the temperature of the graphite sheet mounted on your board matches the specified temperature.

Handling conditions

- The product is likely to suffer mechanical damage when dropped on the floor. Avoid using such a product. The graphite sheet is soft and is therefore easily scratched or damaged. Do not rub or hit the graphite sheet against a hard object. A stripe, folding line, etc., formed on the graphite sheet may affect its heat conductivity.
- Do not reuse a graphite sheet having been used on a printed board and removed therefrom. A tearing load applied to the graphite sheet or a pointed object coming in contact with the sheet may tear the sheet or leave a hole thereon. Use the sheet with a protective material.
- The graphite sheet may get hotter during its use. Do not touch the graphite sheet in use. Touching the graphite sheet with a bare hand may degrade the graphite sheet in performance. Do not do it.
- Because the graphite sheet is conductive, you have to perform an insulation treatment on the graphite sheet if you want it to be insulative. Still, there is a concern that a conductive material in powder form may fall from the graphite sheet. Making the graphite sheet completely insulative, therefore, cannot be guaranteed.
- The heat conductivity of the graphite sheet changes depending on how it is used. Conduct a heat conductivity test of the graphite sheet before using it to see if its heat conductivity meets the use purpose.

Storage conditions

- Do not keep the graphite sheet in the following environments that may affect the performance of the graphite sheet.
 - (1) Stored in a place where the product is heavily exposed to sea breeze or a corrosive gas, such as Cl₂, H₂S, NH₃, SO₂, or NO_x.
 - (2) Stored in a place where the graphite sheet is exposed to UV-rays (storing the graphite sheet in a dark place is recommendable).
 - (3) Stored at a temperature different from the specified storage temperature.
- The storage period of the graphite sheet is one year or less from completion of a shipment inspection. Use the graphite sheet before this storage period expires.
- When the graphite sheet is incorporated in a circuit structure on the assumption that the graphite sheet is bonded, confirm the bonding performance of the graphite sheet before using it.

“PGS” Graphite Sheets

EYG type

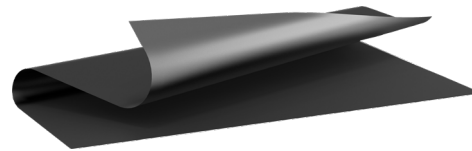

“PGS (Pyrolytic Graphite Sheet)” is a thermal conductivity sheet which is very thin, synthetically made, has high thermal conductivity, and is made from a polymer film. It is ideal for providing thermal management/heat-sinking in limited spaces. This material is flexible and can be cut into customizable shapes.

Features

- Excellent thermal conductivity : 700 to 1000 W/(m·K)
(2 times as high as copper, 3 to 5 time as high as aluminum)
- Lightweight: Specific gravity : 0.85 to 1.00 g/cm³
- Flexible and easy to be cut or trimmed. (withstands repeated bending)
- Low thermal resistance
- RoHS compliant

Recommended applications

- Semiconductor manufacturing equipment (Sputtering, Dry etching, Steppers)
- Optical communications equipment
- TIM(Thermal Interface Material)

Explanation of part numbers

- PGS only (EYGS*****)

1	2	3	4	5	6	7	8	9	10
E	Y	G	S	0	9	1	2	1	0
Product code		Style		Dimension			PGS thickness		
PGS Graphite Sheet		S PGS only		0912	90 mm × 115 mm		10	100 μm	
				1218	115 mm × 180 mm		07	70 μm	
				1823	180 mm × 230 mm				

Characteristics of PGS Graphite Sheets

Thickness	100 μm		70 μm	
		0.10±0.03 mm		0.07±0.015 mm
Density	0.85 g/cm ³		1.21 g/cm ³	
Thermal conductivity a-b plane	700 W/(m·K)		1000 W/(m·K)	
Electrical conductivity	10000 S/cm		10000 S/cm	
Extensional strength	20.0 MPa		20.0 MPa	
Expansion coefficient	a-b plane	9.3×10 ⁻⁷ 1/K		9.3×10 ⁻⁷ 1/K
	c axis	3.2×10 ⁻⁵ 1/K		3.2×10 ⁻⁵ 1/K
Heat resistance ^{*1}	400 °C			
Bending(angle 180,R5)	10000 cycles			

*1 : Withstand temperature refers to PGS only. (Lamination material such as PET tape etc. is not included)

Comparison of thermal conductivity (a-b plane)

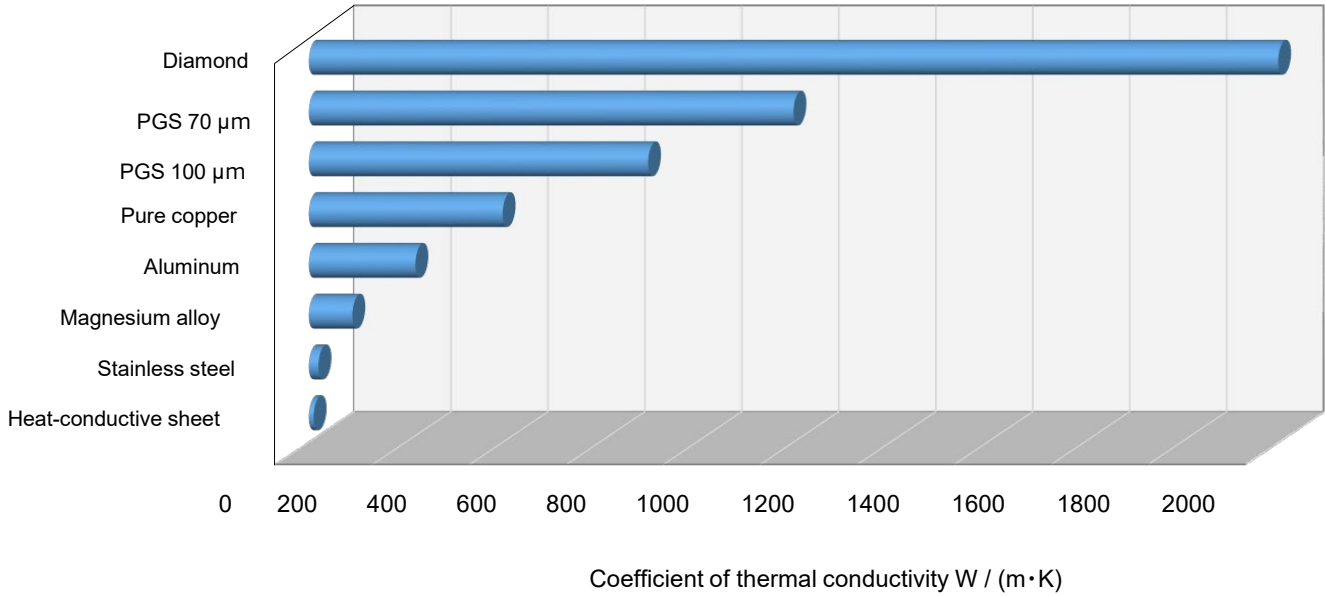

Layered structure of PGS

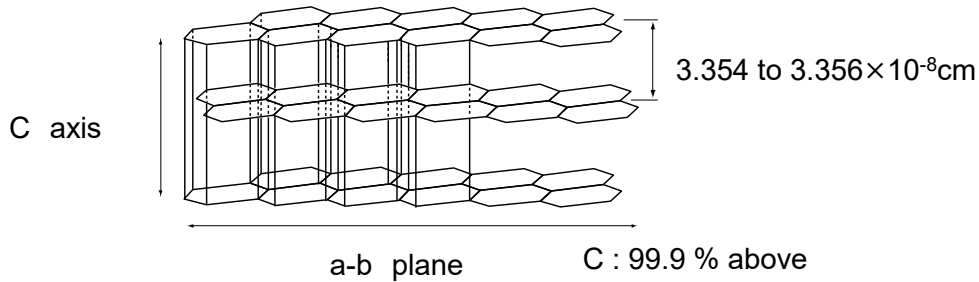

Electric field shield performance

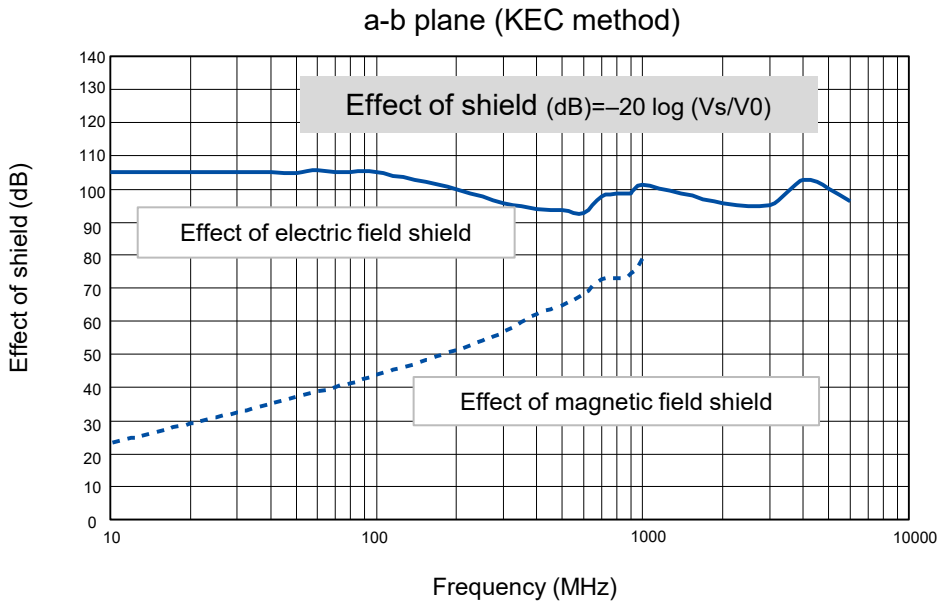

Type / Composition example

- Standard series (PGS 100, 70 μm series)

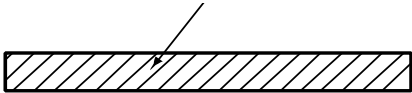
Type	PGS Only	
	S type	
Front face	-	
Rear face	-	
Structure	<p style="text-align: center;">PGS Graphite Sheets</p> 	
Features	<ul style="list-style-type: none"> ◎ High thermal conductivity, High flexibility ◎ Low thermal resistance ◎ Available up to 400 °C ◎ Conductive material 	
Withstand temperature	400 °C	
100 μm	Part No.	EYGS121810
	Thickness	100 μm
70 μm	Part No.	EYGS121807
	Thickness	70 μm

Minimum order

Item	Type	Part No.	Size	Minimum order
PGS Graphite Sheet Only	S type 100 μm	EYGS091210	90×115 mm	20
		EYGS121810	115×180 mm	10
		EYGS182310	180×230 mm	10
	S type 70 μm	EYGS091207	90×115 mm	20
		EYGS121807	115×180 mm	10
		EYGS182307	180×230 mm	10

- (1) The above-listed part number is sample part number for testing.
- (2) Please contact us about your request of custom part number which will be arranged separately.
- (3) Please contact us if quantity is below Minimum Order Quantity.

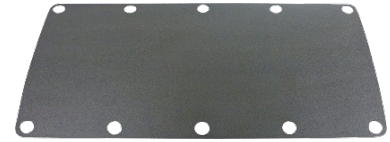

“GraphiteTIM (Compressible Type)” PGS with low thermal resistance EYGS, EYGR type

GraphiteTIM (Compressible Type) is a graphite sheet that is dedicated for use as a thermal interface material. The GraphiteTIM (Compressible Type) has very high compressibility compared to standard PGS, which enables reducing the thermal resistance by following gap, warpage, and distortion of targets/substrates. Excellent heat resistance and reliability of the GraphiteTIM help obtaining longer service life and higher performance of various components, such as power modules. The GraphiteTIM (Compressible Type) is cost-saving, because it may allow you to reduce your existing processes. Unlike grease, there is no necessity for printing process, since it is a sheet-type product. There are no problems that are found in grease and phase change materials in the GraphiteTIM, which makes it excellent TIM.

Features

- Thermal resistance : 0.2 K·cm²/W (600 kPa)
To draw a good thermal resistance from sheet, pressure the GraphiteTIM. A close adherence would make the product fit into the uneven part and enhance the performance.
- Thermal conductivity : X-Y direction 200 to 400 W/m·K,
Z direction (28 W/m·K)
- Compressibility : 40% or more (600 kPa)
- High and long term reliability : operating temperature range -55 to 400 °C
- RoHS compliant

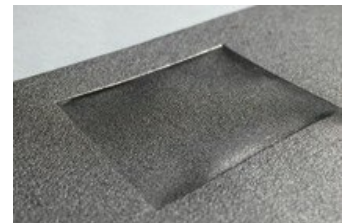

After pressure
to GraphiteTIM.

Recommended applications

For cooling/heat transfer of electronic devices that generates heat, such as power modules.

- Inverters and converters
- Car-mounted camera, motor control unit, automotive LED, luminous source of laser HUD, medical equipment
- Base station, Server

Install in IGBT module

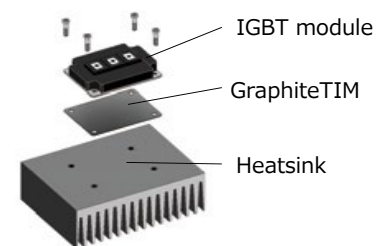

Explanation of part numbers

- GraphiteTIM (EYG*****Z***)

1	2	3	4	5	6	7	8	9	10	11	12
E	Y	G	S	0	9	1	8	Z	L	X	2
Product Code		Style		Dimension				Thickness of GraphiteTIM			
PGS		S		0909	90 mm × 90 mm			ZL	200 μm		
Graphite Sheet		R		0918	90 mm × 180 mm			ZR	250 μm		
				1818	180 mm × 180 mm						
											Suffix

* Please contact us for custom-made products.

“GraphiteTIM (Compressible Type)” PGS with low thermal resistance

Typical characteristics

Items	Test method	Condition	Data		
Thickness (μm)			200	250	350
Thermal resistance (K·cm ² /W)	TIM Tester	200 kPa	0.6	0.4	0.5
Compressibility (%)	TIM Tester	600 kPa	40	55	55
Thermal conductivity (W/m·K)	Laser PIT	X-Y	400	250	200
		Z	28	28	28
Flame resistance	UL-94V		V-0 equivalent		
Operating temperature range (°C)			-55 to 400		

Typical values, not guaranteed.

Thermal resistance and compressibility

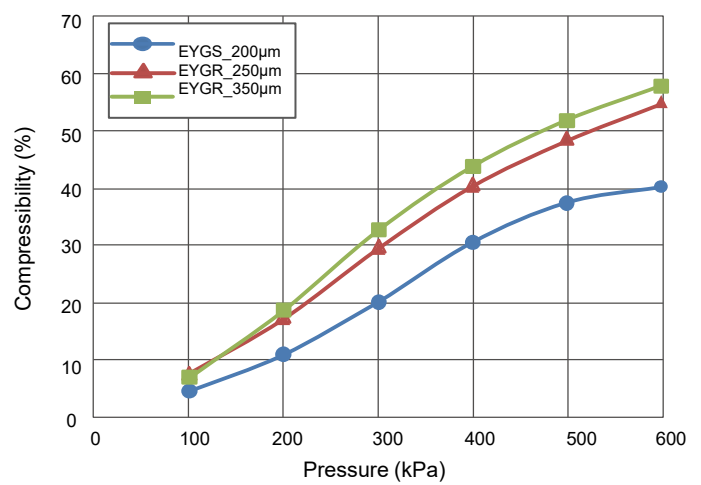
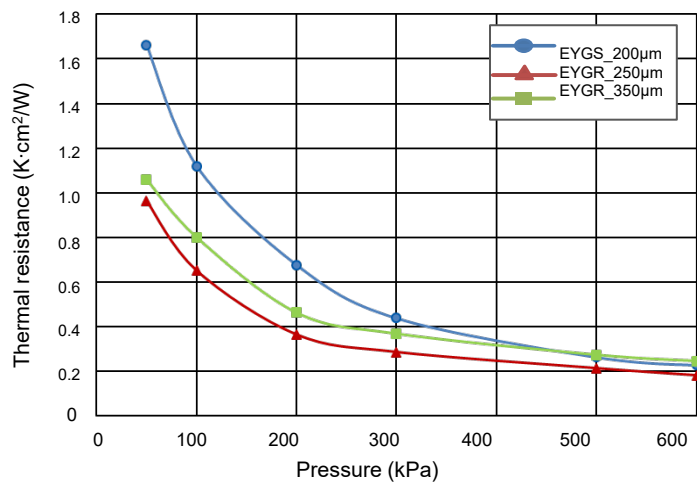

Type / Composition example

● GraphiteTIM(Compressible Type) standard form

Type		Sheet only		
		S type	R type	
Process for IGBT mounting				
Structure	Front			
	Side			
Operating temperature range		-55 °C to 400 °C		
Thickness : c		200 μm	250 μm	350 μm
Standard Part No.	90 x 90 mm	EYGS0909ZLX2	EYGR0909ZLX2	EYGR0909ZRX2
	90 x 180 mm	EYGS0918ZLX2	EYGR0918ZLX2	EYGR0918ZRX2
	180 x 180 mm	EYGS1818ZLX2	EYGR1818ZLX2	EYGR1818ZRX2

* Part numbers listed above are all standard samples for your consideration.



** Contact us for custom-made samples.

We can make samples in various forms and/or dimensions other than standard samples.

“GraphiteTIM (Compressible Type)” PGS with low thermal resistance

Type / Composition example

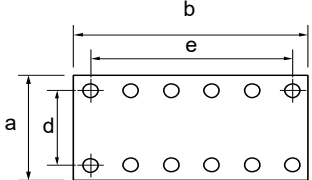
● PGS in IGBT forms

Type		Sheet only		
		S type	R type	
Process for IGBT mounting		-		
Structure	Front	 <p style="text-align: center;">* This shape is an example, please contact us for detailed shape of each part no.</p>		
	Side			
Operating temperature range		-55 °C to 400 °C		
Thickness : c		200 μm	250 μm	350 μm

No.	Standard Part No. 200 μm	Standard Part No. 250 μm	Standard Part No. 350 μm	a : Lateral size (mm)	b : Longitudinal size (mm)	Hole number	Hole diameter (ømm)	d : Lateral hole pitch (mm)	e : Longitudinal hole pitch (mm)
1	EYGS1431ZLAA	EYGR1431ZLAA	EYGR1431ZRAA	140	308	12	6	126	290
2	EYGS0925ZLWA	EYGR0925ZLWA	EYGR0925ZRWA	85	246	14	6	73	234
3	EYGS1419ZLWB	EYGR1419ZLWB	EYGR1419ZRWB	136	186	8	7.5	124	171
4	EYGS0917ZLWC	EYGR0917ZLWC	EYGR0917ZRWC	85	168	10	6	73	156
5	EYGS1316ZLAC	EYGR1316ZLAC	EYGR1316ZRAC	125	163	8	6.1	110	150
6	EYGS1216ZLWD	EYGR1216ZLWD	EYGR1216ZRWD	120	160	8	6	110	150
7	EYGS1116ZLMA	EYGR1116ZLMA	EYGR1116ZRMA	108.8	158	8	6	92.75	144
8	EYGS1315ZLGA	EYGR1315ZLGA	EYGR1315ZRGA	129.5	150	8	7	118.5	137.5
9	EYGS1314ZLWE	EYGR1314ZLWE	EYGR1314ZRWE	126	136	6	7.5	114	124
10	EYGS1014ZLAD	EYGR1014ZLAD	EYGR1014ZRAD	97.8	138	4	6.8	86	127
11	EYGS0714ZLAE	EYGR0714ZLAE	EYGR0714ZRAE	70	138	4	5.7	57	128
12	EYGS0714ZLAF	EYGR0714ZLAF	EYGR0714ZRAF	69	136	4	7.2	57	124
13	EYGS1113ZLMB	EYGR1113ZLMB	EYGR1113ZRMB	106	132	4	5.7	95	121
14	EYGS1313ZLGB	EYGR1313ZLGB	EYGR1313ZRGB	128	128	4	6.7	110	110
15	EYGS0713ZLAG	EYGR0713ZLAG	EYGR0713ZRAG	66	126	4	5.7	50	116
16	EYGS0813ZLMD	EYGR0813ZLMD	EYGR0813ZRMD	71	123	2	4.7	Center	116
17	EYGS1212ZLGC	EYGR1212ZLGC	EYGR1212ZRGC	120	120	4	5.7	110	110
18	EYGS0912ZLGD	EYGR0912ZLGD	EYGR0912ZRGD	88	120	4	5.7	78	110
19	EYGS0612ZLWF	EYGR0612ZLWF	EYGR0612ZRWF	60	120	4	5.7	50	110
20	EYGS0512ZLGE	EYGR0512ZLGE	EYGR0512ZRGE	53	118	2	5.7	Center	106
21	EYGS0811ZLGH	EYGR0811ZLGH	EYGR0811ZRGH	80	113	4	5.7	70	103
22	EYGS0811ZLWG	EYGR0811ZLWG	EYGR0811ZRWG	78	108	4	6.7	62	93
23	EYGS0611ZLWH	EYGR0611ZLWH	EYGR0611ZRWH	60	106	4	6.7	48	93
24	EYGS0411ZLWJ	EYGR0411ZLWJ	EYGR0411ZRWJ	43	106	2	5.7	Center	93
25	EYGS0610ZLAH	EYGR0610ZLAH	EYGR0610ZRAH	59.4	104	4	6.7	48	93
26	EYGS0410ZLAJ	EYGR0410ZLAJ	EYGR0410ZRAJ	43	103	2	5.7	Center	93
27	EYGS1010ZLME	EYGR1010ZLME	EYGR1010ZRME	98	98	4	6.7	87	87

“GraphiteTIM (Compressible Type)” PGS with low thermal resistance

Type / Composition example

No.	Standard Part No. 200 μm	Standard Part No. 250 μm	Standard Part No. 350 μm	a : Lateral size (mm)	b : Longitudinal size (mm)	Hole number	Hole diameter (ømm)	d : Lateral hole pitch (mm)	e : Longitudinal hole pitch (mm)
28	EYGS0409ZLGJ	EYGR0409ZLGJ	EYGR0409ZRGJ	44	93	2	6.7	Center	80
29	EYGS0509ZLGK	EYGR0509ZLGK	EYGR0509ZRGK	46	92	2	6.7	Center	80
30	EYGS0309ZLMF	EYGR0309ZLMF	EYGR0309ZRMF	32	92	2	6.7	Center	80
31	EYGS0409ZLMG	EYGR0409ZLMG	EYGR0409ZRMG	41	88	2	5.7	Center	80
32	EYGS0309ZLAK	EYGR0309ZLAK	EYGR0309ZRAK	29.5	90	2	6.6	Center	80
33	EYGS0509ZLMH	EYGR0509ZLMH	EYGR0509ZRMH	51	86	2	4.7	–	80
34	EYGS0508ZLMJ	EYGR0508ZLMJ	EYGR0508ZRMJ	46.2	83	2	4.7	–	77
35	EYGS0608ZLMK	EYGR0608ZLMK	EYGR0608ZRMK	55	78	2	4.5	Center	40
36	EYGS0607ZLGL	EYGR0607ZLGL	EYGR0607ZRGL	58	70	4	5.7	50	62
37	EYGS0507ZLML	EYGR0507ZLML	EYGR0507ZRML	45.3	66	2	4.7	–	60
38	EYGS0407ZLAL	EYGR0407ZLAL	EYGR0407ZRAL	40	66	1	7.7	Center	Center
39	EYGS0506ZLMM	EYGR0506ZLMM	EYGR0506ZRMM	48	55	1	4.5	Center	Center
40	EYGS0404ZLMP	EYGR0404ZLMP	EYGR0404ZRMP	36	38	1	4.5	Center	Center
41	EYGS1018ZLSA	EYGR1018ZLSA	EYGR1018ZRSA	104.5	183	8	7	93	171
42	EYGS1516ZLSB	EYGR1516ZLSB	EYGR1516ZRSB	148	158	8	5	137	150
43	EYGS1116ZLSC	EYGR1116ZLSC	EYGR1116ZRSC	112	158	8	5	101	150
44	EYGS0715ZLSD	EYGR0715ZLSD	EYGR0715ZRSD	67	153	4	5.6	57	143
45	EYGS0613ZLSE	EYGR0613ZLSE	EYGR0613ZRSE	61	128	4	5.6	50	116
46	EYGS0612ZLSF	EYGR0612ZLSF	EYGR0612ZRSF	63.3	124	4	5.6	50	110
47	EYGS0612ZLSG	EYGR0612ZLSG	EYGR0612ZRSG	61.5	124	4	5.6	50	110
48	EYGS1012ZLSH	EYGR1012ZLSH	EYGR1012ZRSH	104.5	121	4	6.7	93	109.5
49	EYGS0410ZLSJ	EYGR0410ZLSJ	EYGR0410ZRSJ	43	103	2	5.7	Center	93
50	EYGS0609ZLSK	EYGR0609ZLSK	EYGR0609ZRSK	61.5	91	4	5.6	50	77
51	EYGS0606ZLSL	EYGR0606ZLSL	EYGR0606ZRSL	58	62	2	5.6	44	50
52	EYGS0305ZLSM	EYGR0305ZLSM	EYGR0305ZRSM	27	51	1	4.6	Center	Center
53	EYGS0204ZLSN	EYGR0204ZLSN	EYGR0204ZRSN	24	37	1	4.6	Center	Center
54	EYGS0303ZLSP	EYGR0303ZLSP	EYGR0303ZRSP	29	32	1	4.5	Center	Center
55	EYGS0911ZLDA	EYGR0911ZLDA	EYGR0911ZRDA	92	109	4	6	78	93
56	EYGS1014ZLDB	EYGR1014ZLDB	EYGR1014ZRDB	98	138	4	6.7	86	127

Safety Precautions

When using our products, no matter what sort of equipment they might be used for, be sure to confirm the applications and environmental conditions with our specifications in advance.

Panasonic
INDUSTRY

Panasonic Industry Co., Ltd.
Device Solutions Business Division

1006 Kadoma, Kadoma City, Osaka
571-8506 Japan