

Compact Laser Displacement Sensor

HL-G1 Series

User's Manual

Console-dedicated Version

Introduction

Thank you for downloading the "Screen Data for GT-series Programmable Display for the HL-G1-series Compact Laser Displacement Sensor." Read this manual carefully and be sure you understand the information provided before attempting to install and operate the product so that the product will fully demonstrate its superior performance.

Refer to our website

(<https://industry.panasonic.com/global/en/downloads/?tab=manual>)

for the latest information on the product as well as the latest version of the manual.

■ Note

1. The illustrations of the product in the manual may differ from the actual design of the product.
2. The contents of this user's manual may change without notice for possible improvements in the future.
3. All rights reserved. No part of this publication may be reproduced, stored in a retrieval system, or transmitted, in any form, or by any means, mechanical, electronic, photocopying, recording, or otherwise, without the prior written permission of Panasonic Industry Co., Ltd.
4. The utmost attention has been paid to the creation of this manual. Should you find any errors, omissions or inaccuracies, contact the nearest office of Panasonic Industry Co., Ltd.
5. Panasonic Industry Co., Ltd. shall be in no case responsible for any consequences resulting from your operation of the product.

■ Conventions

The following conventions are used to indicate and classify precautions in this manual.

Always heed the information provided with them.





 WARNING	Indicates information that, if not heeded, is likely to result in loss of life or serious injury.
 CAUTION	Indicates information that, if not heeded, could result in relatively serious or minor injury, damage to the product, or faulty operation.
 CHECK	Explains matters that should be observed or mistakes that the user is apt to make.
 REFERENCE	Explains items that should be kept in mind, relevant information in detail, and references.

Table of Contents

Introduction	0
Table of Contents.....	1
1. Introduction of HL-G1 Dedicated Console	2
1-1 Using GT Series for HL-G1 Series	2
1-2 Applicable Programmable Display Models	3
1-3 Steps to Introduce Dedicated Console	4
2. Nomenclature	5
3. Acquiring and Writing Screen Data	6
3-1 Downloading Dedicated Software	6
3-2 Installation of GT Virtual UART Driver	7
3-3 Writing Screen Data	11
4. Sensor Connections and Initial Settings	12
4-1 Mounting Console.....	12
4-2 Connecting Dedicated Console to HL-G1.....	13
4-3 HL-G1 Settings.....	14
4-4 Changing and Saving Display Language of Console.....	15
5. Screen Configuration and Basic Operation	16
5-1 Top Menu Screen and Basic Buttons	16
5-2 Basic Console Operation	17
5-3 Console-dedicated Functions.....	20
6. Screen Transition Charts	22
6-1 GT02 Screen Transition.....	22
6-2 GT12 Screen Transition.....	25
7. Procedure for Deleting GT_USB Driver	28

1. Introduction of HL-G1 Dedicated Console

1-1 Using GT Series for HL-G1 Series

The HL-G1□□-S-J Compact Laser Displacement Sensor (a high-functional model of the HL-G1 Series) will work as a dedicated console or USB/RS-485 converter if the Panasonic Industry's GT-series Programmable Display is connected to the HL-G1□□-S-J and dedicated screen data is written to the Programmable Display. The setting and monitoring software tool HL-G1SMI is available to the HL-G1□□-S-J while HL-G1□□-S-J is used as a USB/RS-485 converter.

■ Used as Dedicated Console

By writing dedicated screen data to the Programmable Display, sensor head settings can be made to and measurement values can be monitored from the HL-G1□□-S-J as a dedicated console under remote control.

The number of sensor heads operable varies with the GT-series model.

For information on the applicable models and number of sensor heads operable, refer to "1-2 Applicable Programmable Display Models."

■ Used as RS-485 Console

A USB/RS-485 converter is required when using the setting and monitoring software tool HL-G1SMI through a personal computer (PC) for HL-G1-series sensor heads. The GT Series can be used as a USB/RS-485 converter.

The GT Series will be available as a converter after dedicated screen data is written to the GT Series.

Settings and monitoring will be available with a maximum of 16 sensor heads connected in the case of the HL-G1SMI.

When the GT Series is used as a converter, the control screen of the GT Series and communication behaviors of the sensor heads will be temporarily suspended while the PC is in communication with the sensor heads.

1-2 Applicable Programmable Display Models

Panasonic Industry's GT-series Programmable Display (any of the following models sold separately) can be used as a dedicated console by connecting the Programmable Display to the high-functional model (HL-G1□□-S-J) of the HL-G1 Compact Laser Displacement Sensor and writing dedicated screen data to the Programmable Display.

The dedicated console makes it possible to make sensor head settings and monitor measurement values remotely.

GT-series Programmable Display models applicable

- Applicable series names GT02 or GT12 Series
- Power supply voltage 24 VDC
- Communications port RS-485 (RS-422)
- SD card memory slot None (or not used)

Products applicable

No. of connection units	Product name	Screen	Backlight	Body color	Product no.
Single connection	GT02G	3.8-inch STN 240 x 96 dots	Green/Orange/Red	Pure black	AIG02GQ14D
				Hairline silver	AIG02GQ15D
	GT02M		White /Pink/ Red	Pure black	AIG02MQ14D
				Hairline silver	AIG02MQ15D
Multi connection (1 to 4 units)	GT12G	4.6-inch STN 320 x 120 dots	Green/Orange/Red	Pure black	AIG12GQ04D
				Hairline silver	AIG12GQ14D
				AIG12GQ05D	
				AIG12GQ15D	
	GT12M		White /Pink/ Red	Pure black	AIG12MQ04D
				AIG12MQ14D	
				AIG12MQ05D	
				AIG12MQ15D	

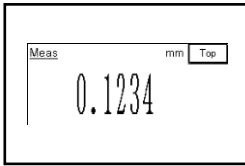

GT02 Series measurement value display

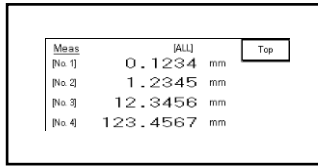

GT12 Series measurement value display (with four HL-G1 units connected)

- The GT02□ Series can control only a single sensor head when it is used as a dedicated console and up to 16 sensor heads when it is used as a USB/RS485 converter.
- The GT12□ Series can control up to four sensor heads when it is used as a dedicated console and up to 16 sensor heads when it is used as a USB/RS485 converter.

For information on the installation and connection of the GT Series, download the GT-series User's Manual. Read the manual carefully and be sure you understand the information provided before attempting to install and operate the GT Series.

1-3 Steps to Introduce Dedicated Console

This section provides brief information on the introduction of the GT Series as a dedicated console.

For the procedure in detail, refer to "3. Acquiring and Writing Screen Data".

- Preparation

- PC connected to the Internet
 - *For the operating environment of the PC, refer to "GT-series User's Manual".
- USB cable (for A-to-mini B-connector connection)
- Power supply for Programmable Display (24 VDC)

- Writing HL-G1-dedicated screen data to the GT-series

Acquiring and writing screen data

- [1] Downloading dedicated software: See 3-1.
- [2] Writing screen data to the GT Series: See 3-3.

- Using GT Series as HL-G1-dedicated console.

Connecting the console to the sensor head and making initial settings

- [1] Installation: See 4-1.
- [2] Connecting the dedicated console to the HL-G1: See 4-2.
- [3] Making HL-G1 settings: See 4-3.
- [4] Changing and saving the display language of the console: See 4-4.

Console operation

- [1] Basic operation: See 5-6.
- [2] Console-dedicated function: See 5-7.
- [3] Setting of each function and measurement value display (list of screen transition) : See 6.

- Used as USB/RS-485 converter

- [1] Installation: See 4-1.
- [2] Connection of PC and GT Series to HL-G1: See 4-2.

The PC and GT are connected with USB cable and the GT and HL-G1 are connected with RS-485 cable.
- [3] HL-G1 settings: See 4-3.

For each function of the sensor head, refer to the "HL-G1-series User's Manual".

2. Nomenclature

■ GT02 Series

Side view

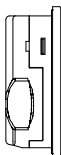

Front view

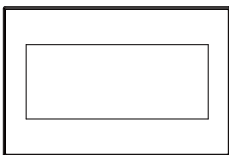

Side view

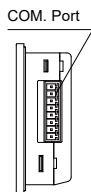

Rear view

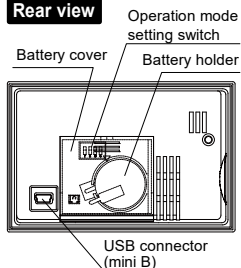

- Operation mode setting switch

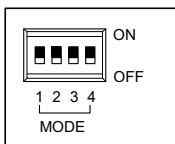

SW No.	Function	OFF	ON
1	Reserved (not used)	<u>Always turned OFF</u>	
2	Not allowed to go to system menu	Movement possible	Movement prohibited
3	Reserved (not used)	<u>Always turned OFF</u>	
4			

■ GT12 Series

Side view

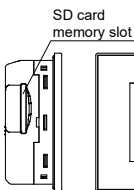

Front view

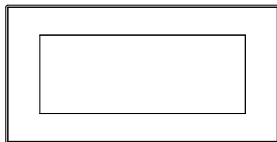

Side view

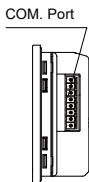

Rear view

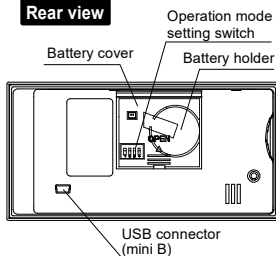

- Operation mode setting switch

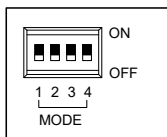

SW No.	Function	OFF	ON
1	Reserved (not used)	<u>Always turned OFF</u>	
2	Not allowed to go to system menu	Movement possible	Movement prohibited
3	Reserved (not used)	<u>Always turned OFF</u>	
4			

❗ CHECK

The SD memory card slot or internal battery is not used in the case of using either one of the above as a dedicated console for the HL-G1 Series.

3. Acquiring and Writing Screen Data

3-1 Downloading Dedicated Software

Download the applicable data file of dedicated software according to the communications method (RS-422 or RS-485) and the GT-series model to be used. The following data files are available.

Applicable model	Applicable product number	Dedicated software	Remarks
GT02G	AIG02GQ14D	Screen Data for Programmable Display GT02	Used to operate a single sensor head
	AIG02GQ15D		
GT02M	AIG02MQ14D		
	AIG02MQ15D		
GT12G	AIG12GQ04D	Screen Data for Programmable Display GT12	Used to operate a number of sensor heads
	AIG12GQ14D		
	AIG12GQ05D		
	AIG12GQ15D		
GT12M	AIG12MQ04D		
	AIG12MQ14D		
	AIG12MQ05D		
	AIG12MQ15D		

- 1 Go to the download page from the top page of our website.
<https://industry.panasonic.com/global/en/downloads/?tab=software>
- 2 Select "HL-G1-series Compact Laser Displacement Sensor", and download the applicable data file.
- 3 The downloading file is compressed (in zip). Uncompress the file in an appropriate folder.

3-2 Installation of GT Virtual UART Driver

The GT Virtual UART driver is required when writing screen data from the PC. Therefore, the GT Virtual UART driver must be installed to the PC before writing screen data. In addition, the GT Virtual UART driver will work as a COM port driver for the HL-G1SMI in the case of using the GT as a USB/RS485 converter.

❗ CHECK

The conventional GT_USB driver, if already installed, must be deleted before installing the GT Virtual UART driver. For the procedure in detail, refer to "7. Procedure for Deleting GT_USB Driver."

- Installation to PC (with Windows Vista or Windows 7 operating system)
 - 1 Wire a DC power supply to the GT, and connect the PC and GT over USB cable.
 - 2 The PC will automatically recognize the USB driver, and a new hardware detection wizard will be displayed. Click "Check later."
 - 3 Select "Control Panel" in the Start menu.

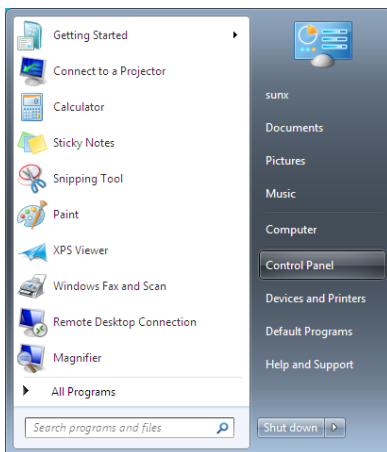

4 Select "System and Security" in the Control Panel.

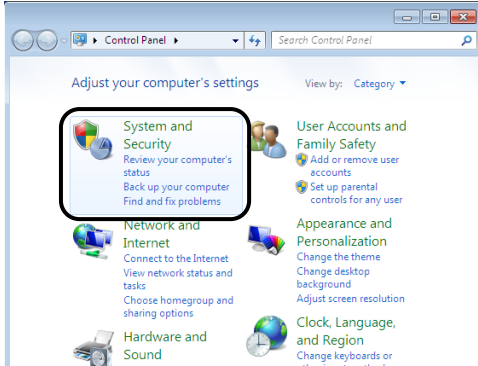

5 Select "System" in the System and Security.

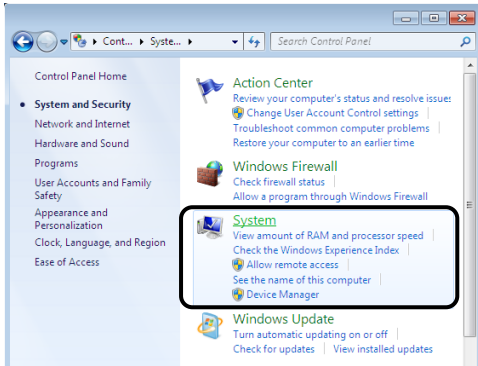

6 Select "Device Manager" in the System.

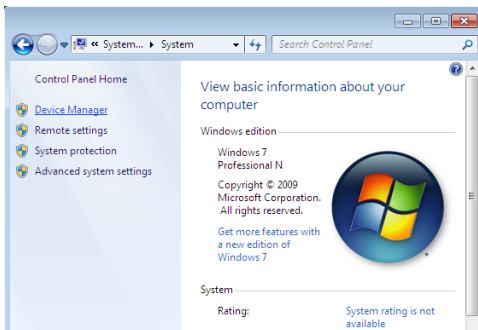

The User Account Control window will be displayed. Click "Continue (C)."

- 7 Right-click "Panasonic GT" in the Device Manager window, and select "Update Driver."

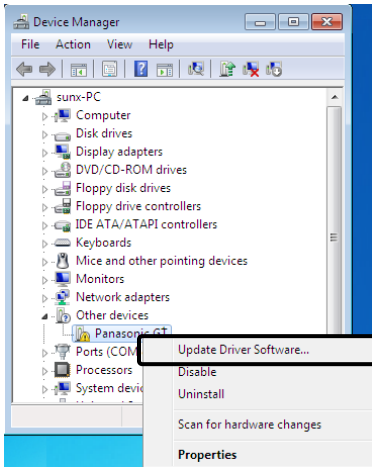

- 8 The Update Driver window will be displayed. Click "Browse my computer for driver software (R)."

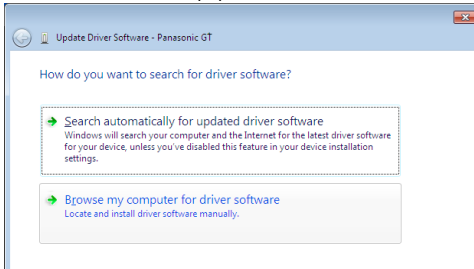

- 9 A list of drivers will appear. Select the folder copied and expanded in steps (1) and (2), and click "Next (N)."

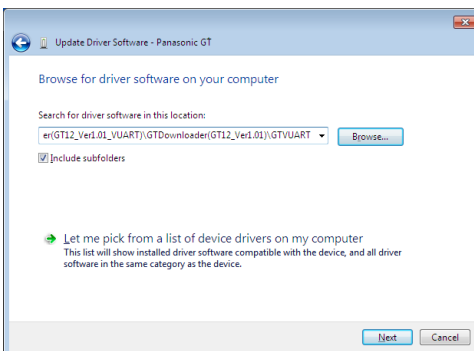

- 10** The Windows Security window will be displayed. Click "Install this driver (I)".

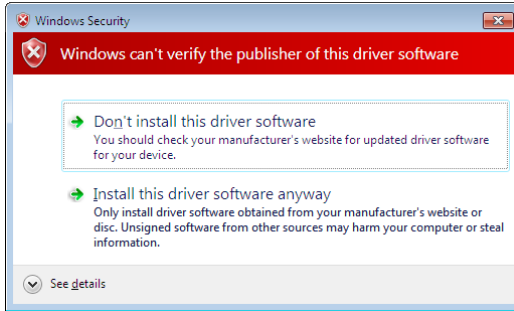

- 11** The Update Complete window will be displayed. Click "Close (C)."

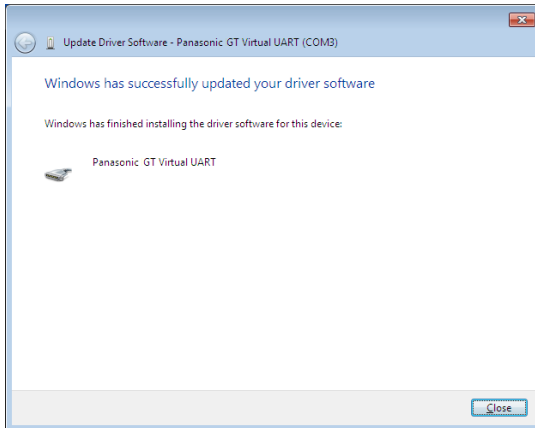

The installation of the GT Virtual UART driver to the PC will be completed at this stage.

3-3 Writing Screen Data

- 1 Click the "GTDownloader.exe" in the folder where the file has been expanded.

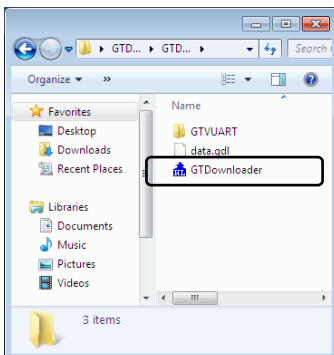

- 2 The message "Execute Download?" will be displayed in the prompt screen for the screen data. Select the COM port where GT is connected, and click the "OK" button.

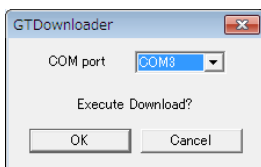

- 3 A progress screen will be displayed. Wait until the transfer of the data is completed.

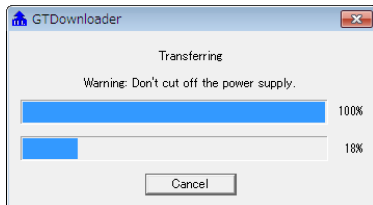

- 4 Click the "OK" button on completion of data transfer.

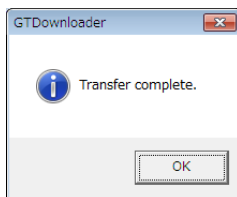

- 5 End.

4. Sensor Connections and Initial Settings

4-1 Mounting Console

For the installation of the GT Series in detail, refer to "Chapter 3 Installation and Wiring" of the "GT-series User's Manual".

Use the four mounting brackets and four mounting screws provided and mount the console to the mounting plate.

■ GT02 Series

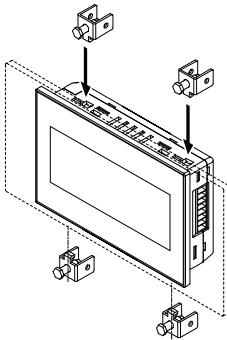

- (1) Insert the unit into the mounting plate.
- (2) Attach the mounting brackets to the grooves of the unit, and slide and fix the brackets. Tighten the screws and fix the unit to the mounting plate securely.

Note 1) Use a No. 1 Phillips screwdriver.

Note 2) Screw tightening torque of 0.2 to 0.3 N·m

Note 3) Do not tighten the screws in excess, or otherwise the front panel may deform and the touch switch cannot work properly. Be sure to keep the above torque range.

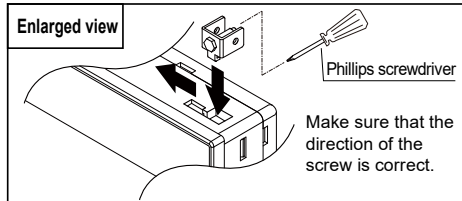

■ GT12 Series

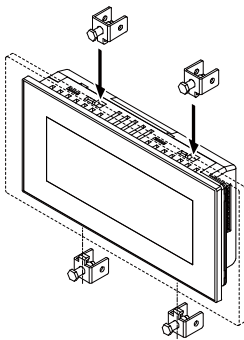

- (1) Insert the unit into the mounting plate.
- (2) Attach the mounting brackets to the grooves of the unit. Tighten the screws and fix the unit to the mounting plate securely.

Note 1) Use a No. 1 Phillips screwdriver.

Note 2) Screw tightening torque of 0.2 to 0.3 N·m

Note 3) Do not tighten the screws in excess, or otherwise the front panel may deform and the touch switch cannot work properly. Be sure to keep the above torque range.

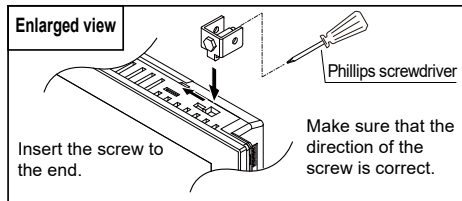

4-2 Connecting Dedicated Console to HL-G1

For general handling information on the GT Series, refer to the GT-series User's Manual.

- Connecting GT12 Series to HL-G1 (More than a single HL-G1 unit over RS-485)
 - Up to four HL-G1 units can be connected.
 - The console will be the terminator. Connect the ground terminal "E" to the signal "-RD".
 - Set the "Terminating resistor selection" for the terminating HL-G1 unit only, while turn OFF the terminating resistor for each intermediate HL-G1 unit connected through a bus line.
 - The shield of each HL-G1 extension cable is connected to the signal ground (SG) of the sensor head. Connect the shield to the 0 V (-) terminal of the power supply for the console.

Wire the SD and RD signal lines according to the diagram as shown below.

(+SD and -SD are connected with a twisted pair cable and so are +RD and -RD.)

- Short-circuit the +SD + RD terminals and -SD and -RD terminals.
- Connect the +SD and +RD terminals on the HL-G1 side and the +SD and +RD terminals on the console side.
- Connect the -SD and -RD terminals on the HL-G1 side and the -SD and -RD terminals on the console side.

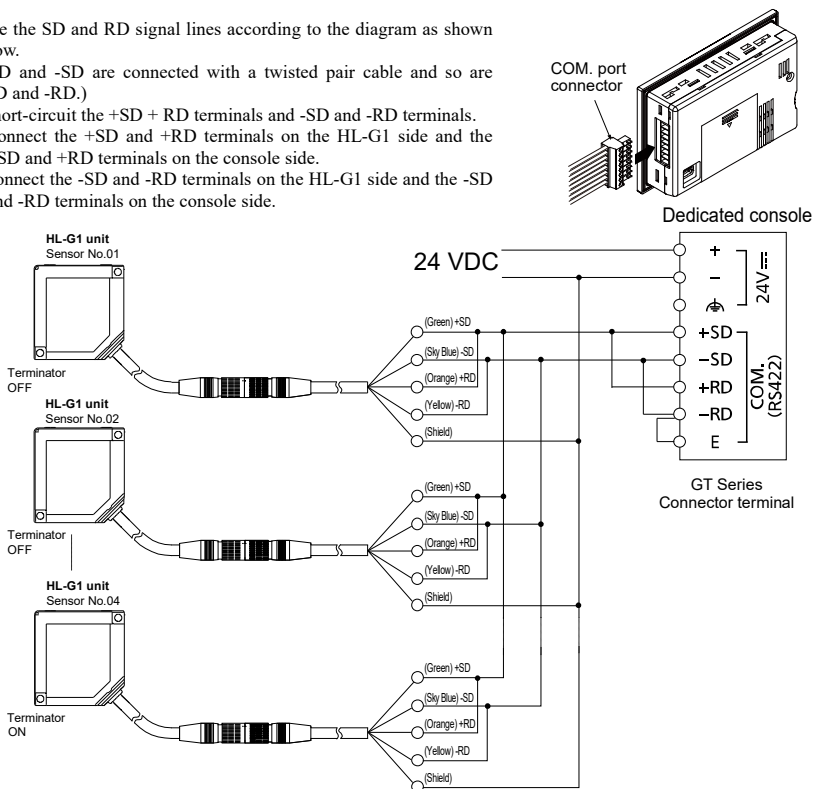

- Used as USB/RS-485 converter connect the PC and GT over USB cable.

4-3 HL-G1 Settings

Before using the compact console (GT-series unit) for communication with the HL-G1, select and set communications conditions on the HL-G1 side according to the communications specifications.

- HL-G1 Settings for communications conditions

COM Settings Prog

Item	GT02 Series (single-unit connections only)	GT12 Series (for multi-unit connections)
Terminating resistor selection	R3 (see note 1)	
Sensor No.	Optional	Specify 01 through 04 in sequence (see note 2)
Baud rate	38400bps (initial value)	
Connection mode	Multiple RS-485 [485-M] (initial value)	

Note 1: Terminating resistor selection from R1 or R2 may improve communication condition depending on the characteristics and length of the cable in use or the number of sensors connected.

Do not set the termination resistor for any sensor other than that located as terminator.

Note 2: Set the sensor numbers beginning with 01 in sequence if the sensors are connected over RS-485. If the sensor numbers are not consecutive, they will not be recognized and the sensors will not operate correctly.

Note 3: Sensor number settings will be required when using the HL-G1 as a dedicated console. Up to 16 units can be connected if the units are used as USB/RS-485 converters, in which case, however, be sure to set sensor numbers in sequence beginning with 01 with no duplication.

HL-G1 setting procedure

Example) In this example, sensor head number 01 is set as terminator and used over RS-485.

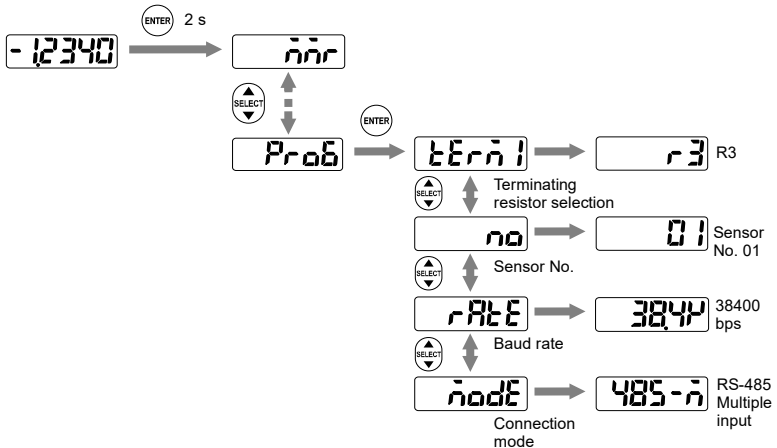

4-4 Changing and Saving Display Language of Console

The console screen will display in English when the console is started with the sensor head connected after screen data is written.

Environment settings for the console are required to change the displayed language on the screen.

The settings are saved in the sensor. Execute the Save command after making the settings. The settings will be lost with the sensor head turned OFF if the settings are not saved.

❗ CHECK

When the sensor head is initialized, the displayed language will return to English. In that case, set the language again and save it.

• Switching language

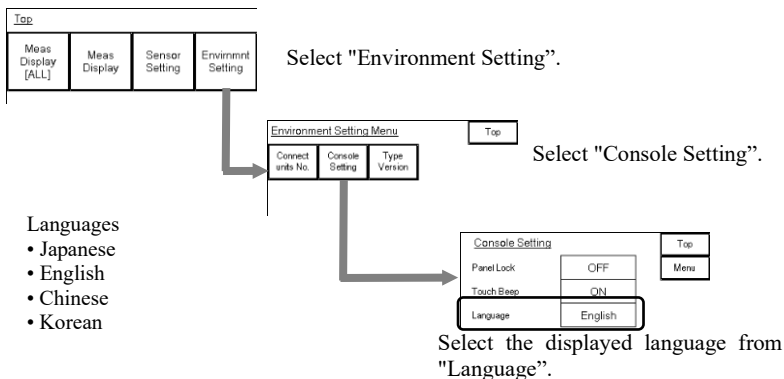

• Saving language settings

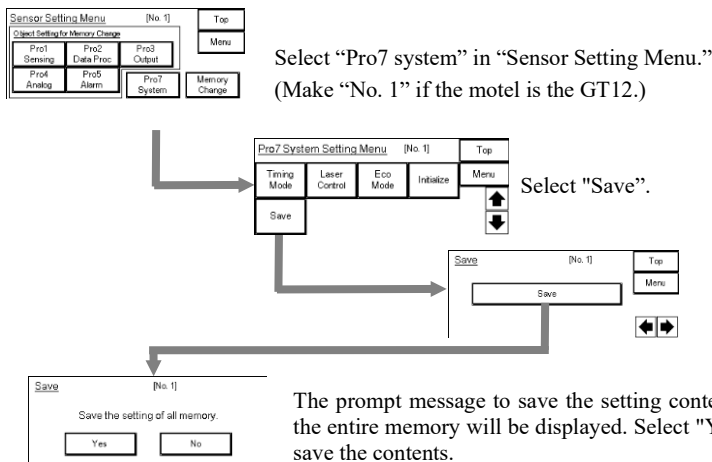

5. Screen Configuration and Basic Operation

5-1 Top Menu Screen and Basic Buttons

• Top menu

GT02 top menu

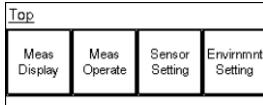

GT12 top menu

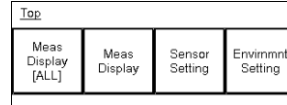

- ★ The top menu screen shows the above items.
The user can move to other screens through here.



Used to display the measurement value of the sensor connected.



Used to operate the measurement control of the sensor connected. (GT02 only)



Used to make various sensor settings.



Used to make console environment settings.



Used to display the measurement values of all the sensors connected. (GT12 only)

• Basic button operation

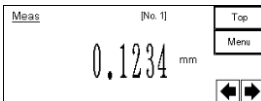

Top Returns to the top screen.

Menu Returns to each menu screen according to each setting.

• Operation during measurement value display

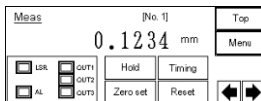

Hold The measurement value display is kept on hold (not refreshed).

Timing Used to implement the same action as timing input.

Zero set Used to switch the zero set and zero set OFF.

Reset Used to reset the measurement value kept on hold.

5-2 Basic Console Operation

■ Moving between Setting Screens

The operation screen is of hierarchic structure.



Touch the Up and Down Keys ( ) to go to the target screen and make necessary settings.

 ... The value of each item in the sensor setting menus (Pro1 through Pro7) will increase by 1.

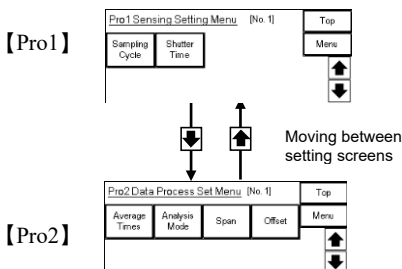
 ... The value of each item in the sensor setting menus (Pro 1 through Pro7) will decrease by 1.



■ Changing Sensor Head Number (GT12 Only)

To move between sensor head numbers, touch the Left and Right Keys ( )

 ... Press this key to go to the sensor head number that is 1 larger.

 ... Press this key to go to the sensor head number that is 1 smaller.

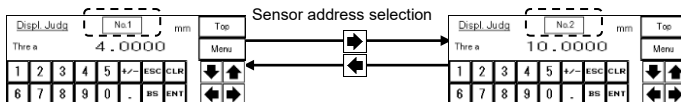

■ Selection

This section provides information on how to select the target item from multiple choices.

[Selection from a few choices]

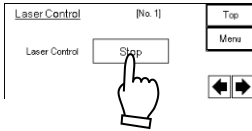

The selectable item changes as shown each time the key is touched.

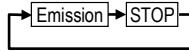

[Selection from many choices]

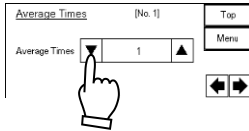

The selectable item changes as shown each time the Up Key (▲) is touched.

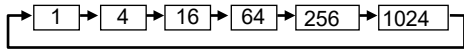

Press the Down Key (▼) to change the direction of selection.

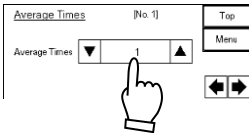

The value will return to the default value by touching the part (where the set value is displayed) between the Up and Down Keys.

■ Numeric Input

This section provides information on how to input numeric values, such as limit values and offset values. The keyboard will be displayed for items for which numeric input is possible.

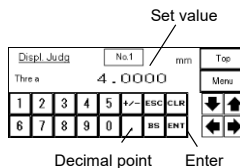

1 Touch the frame above the set value.

The system is ready to accept numeric input, and the cursor starts flashing.



2 Enter the integer part from the keyboard.

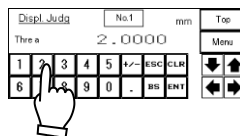

3 Touch the decimal (.) on the keyboard.

Input after the decimal point is acceptable. Input the value.

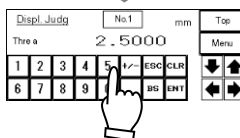
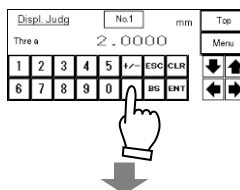

4 Touch the Enter Key (ENT) after the value is input.

The setting will be entered.

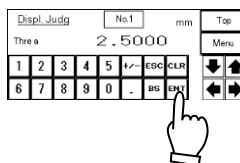

- * To cancel the numeric input, touch the Esc Key (ESC).
- * To clear the input, touch the CLR Key (CLR). Then the user can input the desired value again.
- * To clear the input, touch the BS Key (BS). Then the user can input the desired value again.

5-3 Console-dedicated Functions

■ Output setting menu

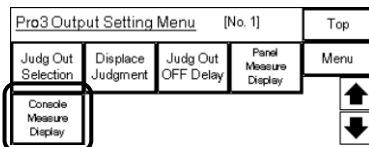

(GT-12 setting screen)

● Display console measurement value

Use this function to fix the console measurement value after the decimal point to 0.

Set this item to disable the change in the display of the minute measurement value of the console.

Set value: FULL, Set 1, Set 2, and Set 3

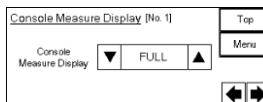

[FULL] The full value down to the fourth decimal place is displayed.

[Set 1] The fourth decimal point is fixed to 0.

[Set 2] The third and fourth decimal points are fixed to 0.

[Set 3] The second, third, and fourth decimal points are fixed to 0.

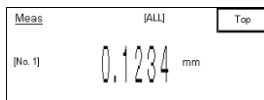

Select "FULL."

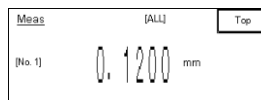

Select "Set 2."

- These settings are memory-dependent. Make settings for each memory number if memory change is used.

■ Environment setting menu

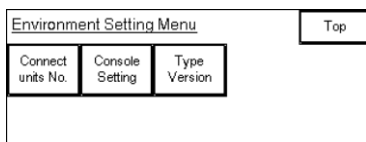

(GT-12 setting screen)

● Number of units connected (GT12 only)

Use this function to specify the number of sensor heads to be connected to the console and operated.

It is necessary that the sensor head numbers are set correctly.

Set value: 1, 2, 3, 4

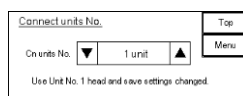

- Panel lock

Use this function to prevent set value changes with console key manipulation. It is possible to move between screens.

Set value: ON, OFF

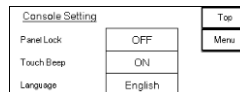

- Touch beep

Use this function to enable or disable the touch beep.

Set value: ON, OFF

- Language

Use this function to select the display language.

Set value: Japanese, English, Korean, Chinese

- Backlight color selection (GT02 only)

Use this function to select the switching method of backlight colors according to the state of judgment 2 of the sensor head.

Set value: White /Green (fixed), OUT2ON red, OUT2OFF red.

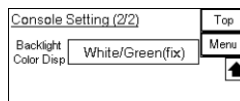

[White/Green (fix)] The backlight color is set according to the default of the display unit.

[OUT2ON red] The backlight color is changed to red by a measurement value that turns OUT2 ON.

[OUT2OFF red] The backlight color is changed to red by a measurement value that turns OUT2 FF.

- The ON/OFF operating conditions of OUT2 are set with "Judgment output selection" and "Displacement judgment".

- Type and Version display

Use this function to display the model number of each sensor head connected and the software version for the sensor head.

Type/Version		Top
No.1 HL-G103-S-J	Ver. 1.00	Menu
No.2 HL-G105-S-J	Ver. 1.00	
No.3 HL-G108-S-J	Ver. 1.00	
No.4 unknown	Ver. 1.00	
Console GT12		Ver. 1.00

❗ CHECK

Each set value need to be saved in the sensor head.

Be sure to execute "Pro7: System setting" → "Save" after making settings.

(Set and save "Sensor No. 01" (No. 1) in the case of connecting the GT12 to a number of sensor heads over RS-485.

Keep in mind that ettings will be lost with the sensor head turned OFF unless the settings are saved.

6. Screen Transition Charts

This section provides screen transition charts of the console dedicated to HL-G1. For details of each function, refer to the HL-G1 User's Manual provided with the sensor head.

6-1 GT02 Screen Transition

- Transition from top screen to each menu screen

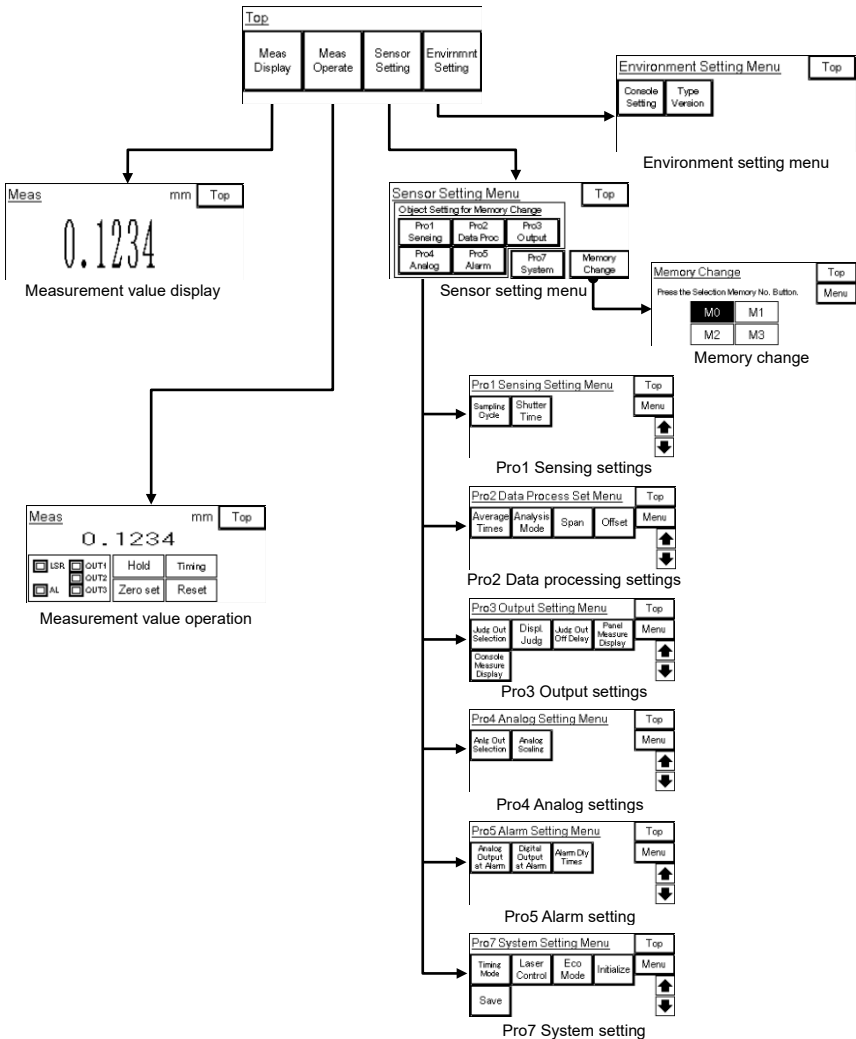

● Setting item screen for each setting menu (for GT02 use)

Pro1 Sensing Setting Menu		Top
Sampling Cycle	Shutter Time	Menu
		↑
		↓

Pro1: Sensing setting menu

Sampling Cycle		Top
Sampling Cycle	▼ 200us ▲	Menu
Sampling cycle		
Shutter Time		Top
Shutter Time	▼ Auto ▲	Menu
Recd LI Monitor 1 2 3 4		
Shutter time		

Pro2 Data Process Set Menu					Top
Average Times	Analysis Mode	Span	Offset		Menu
					↑
					↓

Pro2: Data processing menu

Average Times		Top							
Average Times	▼ 1 ▲	Menu							
Average times									
Analysis Mode		Top							
Analysis Mode	▼ Normal ▲	Menu							
Analysis mode									
Span		Top							
Span	▼ 1.0000 ▲	Menu							
1	2	3	4	5	%	PF	PA	↑	↓
6	7	8	9	0	.	%	↓		
Span									
Offset		Top							
Offset	▼ 0.0000 ▲	Menu							
1	2	3	4	5	%	PF	PA	↑	↓
6	7	8	9	0	.	%	↓		
Offset									

Pro3 Output Setting Menu					Top
Judg Out Selection	Displ. Judg	Judg Out Off Delay	Panel Measure Display		Menu
					↑
					↓

Pro3: Output setting menu

Judg Out Selection		Top							
Judg Out Selection	▼ Logic ▲	Menu							
Judgment output selection									
Displ. Judg		Top							
Displ. Judg	▼ No.1 mm ▲	Menu							
Thre a 4.0000									
1	2	3	4	5	%	PF	PA	↑	↓
6	7	8	9	0	.	%	↓		
Displacement judgment (Threshold a)									
Displ. Judg		Top							
Displ. Judg	▼ No.1 mm ▲	Menu							
Thre b -4.0000									
1	2	3	4	5	%	PF	PA	↑	↓
6	7	8	9	0	.	%	↓		
Displacement judgment (Threshold b)									
Displ. Judg		Top							
Displ. Judg	▼ No.1 mm ▲	Menu							
Hysteresis 0.0000									
1	2	3	4	5	%	PF	PA	↑	↓
6	7	8	9	0	.	%	↓		
Hysteresis									
Judg Out OFF Delay		Top							
Judg Out OFF Delay	▼ OFF ▲	Menu							
Judgment output OFF delay									
Panel Measure Display		Top							
Panel Meas Display	FULL	Menu							
Panel measurement value display									
Console Measure Display		Top							
Console Meas Display	▼ FULL ▲	Menu							
Console measurement value display									

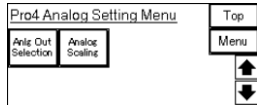

Pro4: Analog setting menu

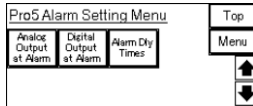

Pro5: Alarm setting menu

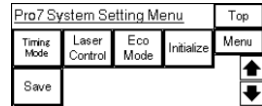

Pro7: System setting menu

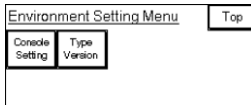
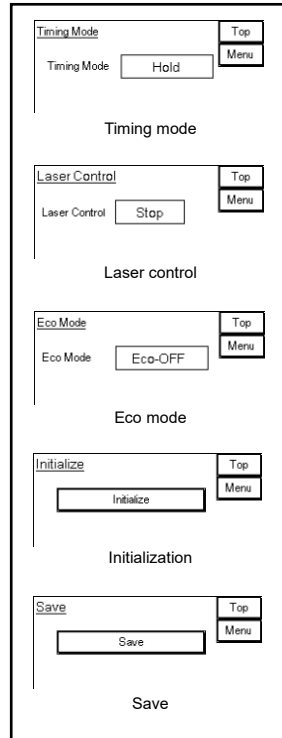
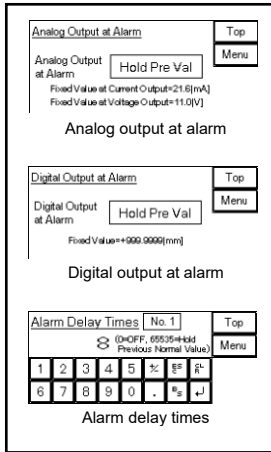
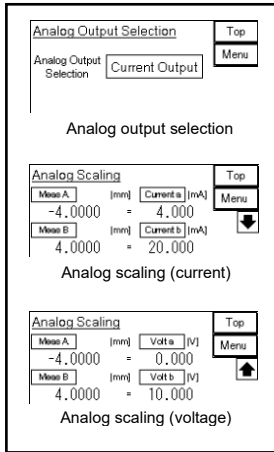

Environment setting menu

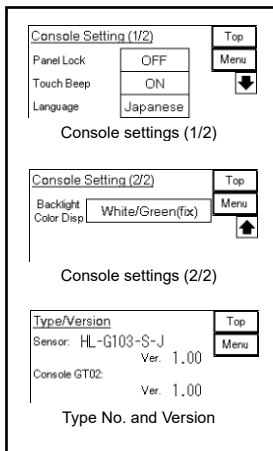

6-2 GT12 Screen Transition

- Transition from top screen to each menu screen

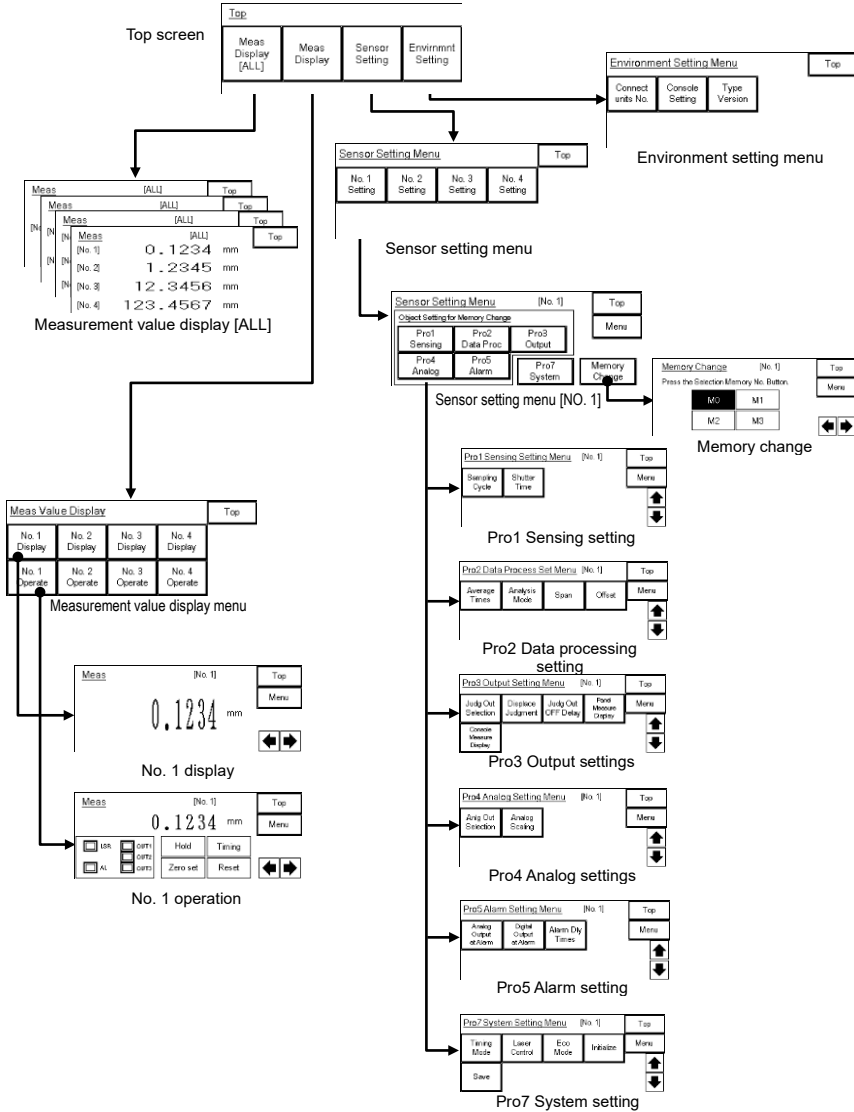

● Setting item screen for each setting menu (for GT12 use)

Pro1 Sensing Setting Menu (No. 1)		Top
Sampling Cycle	Shutter Time	Menu
		▲
		▼

Pro1: Sensing setting menu

Sampling Cycle (No. 1)		Top
Sampling Cycle ▼ 200us ▲		Menu
		◀ ▶
Shutter Time (No. 1)		Top
Shutter Time ▼ Auto ▲		Menu
Recd U Monitor 1 2 3 4		◀ ▶
Shutter time		

Pro2 Data Process Set Menu (No. 1)					Top
Average Times	Analysis Mode	Span	Offset	Menu	
					▲
					▼

Pro2: Data processing menu

Average Times (No. 1)		Top			
Average Times ▼ 1 ▲		Menu			
		◀ ▶			
Analysis Mode (No. 1)		Top			
Analysis Mode ▼ Normal ▲		Menu			
		◀ ▶			
Span (No. 1)		Top			
1 . 0000		Menu			
1	2	3	4	5	←/ESC CLR
6	7	8	9	0	./BS ENT
		◀ ▶			
Offset (No. 1)		Top			
0 . 0000		Menu			
1	2	3	4	5	←/ESC CLR
6	7	8	9	0	./BS ENT
		◀ ▶			
Offset					

Pro3 Output Setting Menu (No. 1)					Top
Judg Out Selection	Displace Judgment	Judg Out OFF Delay	Panel Measure Display	Menu	
					▲
					▼

Pro3: Output setting menu

Judg Out Selection (No. 1)		Top			
Judg Out Selection ▼ Logic ▲		Menu			
		◀ ▶			
Displ. Judg (No. 1)		Top			
Thre a 4 . 0000		Menu			
1	2	3	4	5	←/ESC CLR
6	7	8	9	0	./BS ENT
		◀ ▶			
Displacement judgment (Threshold a)					
		▲ ▼			
Displ. Judg (No. 1)		Top			
Thre b -4 . 0000		Menu			
1	2	3	4	5	←/ESC CLR
6	7	8	9	0	./BS ENT
		◀ ▶			
Displacement judgment (Threshold b)					
		▲ ▼			
Displ. Judg (No. 1)		Top			
Hysteresis 0 . 0000		Menu			
1	2	3	4	5	←/ESC CLR
6	7	8	9	0	./BS ENT
		◀ ▶			
Hysteresis					
Judg Out OFF Delay (No. 1)		Top			
Judg Out OFF Delay ▼ OFF ▲		Menu			
		◀ ▶			
Judgment output OFF delay					
Panel Measure Display (No. 1)		Top			
Panel Measure Display FULL		Menu			
		◀ ▶			
Panel measurement value display					
Console Measure Display (No. 1)		Top			
Console Measure Display ▼ FULL ▲		Menu			
		◀ ▶			
Console measurement value display					

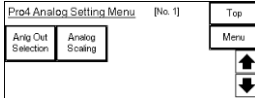

Pro4: Analog setting menu

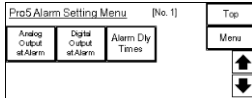

Pro5: Alarm setting menu

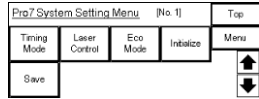

Pro7: System setting menu

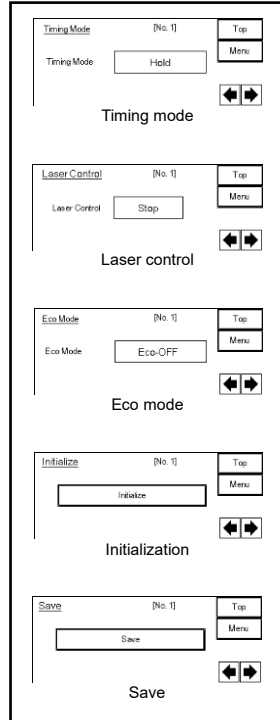
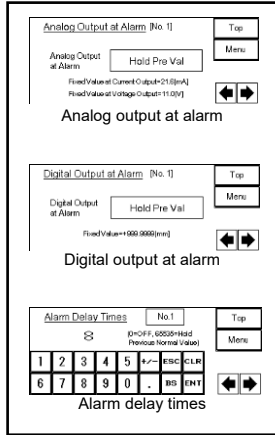
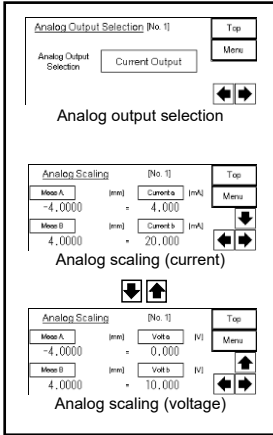

Environment setting menu

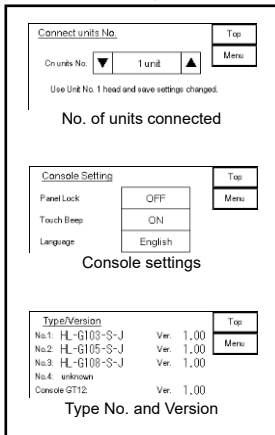

7. Procedure for Deleting GT_USB Driver

The conventional GT_USB driver, if already installed, must be deleted before installing the GT Virtual UART driver.

Pay the utmost attention not to delete other drivers. Devices will not operate if the corresponding drivers are deleted.

If the conventional GT_USB driver has not been installed, refer to "3-2. Installation of GT Virtual UART Driver" and newly install the latest GT Virtual UART driver.

❗ CHECK

Make Terminal GTWIN communications settings after installing the GT Virtual UART driver in the case of using the Terminal GTWIN screen creation tool for the GT-series Programmable Display.

Open "File" -> "Transfer" -> "COM Setting" -> "Network Type" -> "RS232C" in the menu bar so that the unit can be used in the conventional method.

● Deletion from PC (with Windows Vista or Windows 7 operating system)

- 1 Turn on the GT, and connect the PC and GT over USB cable.
If a new hardware detection wizard is displayed, there will be no need to take the procedure for deleting the GT_USB driver. Click "Check later (A)" and go to "3-2 Installation of GT Virtual UART Driver."
Click "Check later (A)."

- 2 Select "Control Panel" in the Start menu.

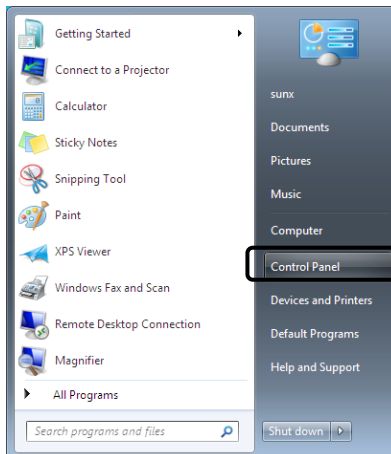

Select "Control Panel."

3 Select "System and Security" in the Control Panel.

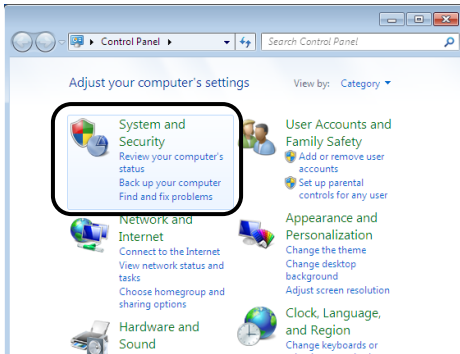

Double-click "System and Security."

4 Select "System" in the System and Security.

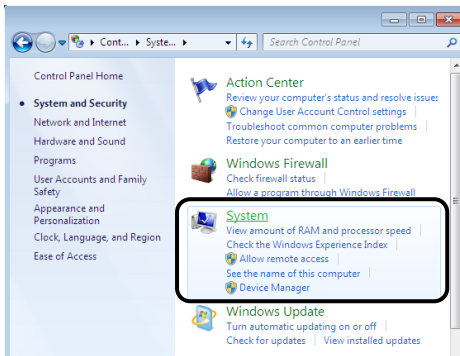

Double-click "System."

5 Select "Device Manager" in the System.

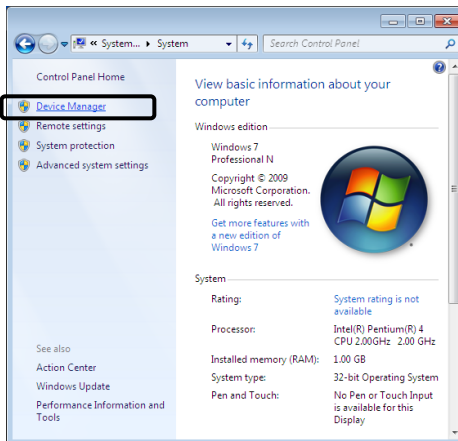

Click "Device Manager."

The User Account Control window will be displayed. Click "Continue (C)."

- 6 Right-click "Panasonic GT USB Driver Ver1.0" in the Device Manager window, and select "Uninstall"

Make sure not to delete drivers other than Panasonic GT USB Driver Ver1.0 for the GT.

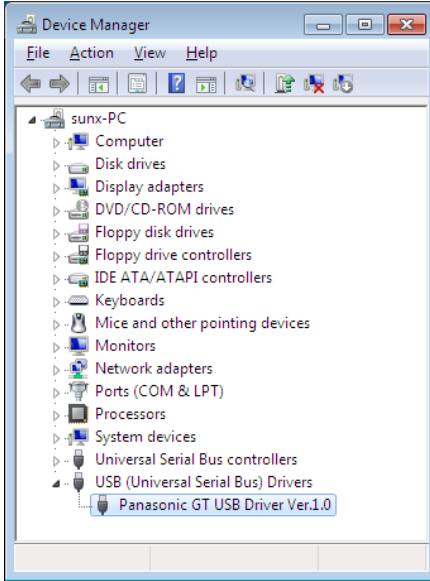

Click "USB (Universal Serial Bus) Drivers" in the Device Tree.

Right-click "Panasonic GT USB Driver Ver1.0."

Select "Uninstall (U)" in the right-click menu.

- 7 A confirmation window to uninstall the device will be displayed. Make sure that the device to be deleted is "Panasonic GT USB Driver Ver.1.0," check the Delete the driver software for this device option, and click "OK."



The installation of the GT_USB driver has been completed. Go to "3-2 Installation of GT Virtual UART Driver."

Revision history

Released date	Revision No.
October 2010	A first release
December 2010	The 1st edition
January 2011	The 2nd edition
February 2013	The 3 rd edition
September 2013	The 4 th edition
April 2024	The 5 th edition

Panasonic Industry Co., Ltd.

1006, Oaza Kadoma, Kadoma-shi, Osaka 571-8506, Japan
<https://industry.panasonic.com/>

Please visit our website for inquiries and about our sales network.

© Panasonic Industry Co., Ltd. 2013-2024

April, 2024

ME-HLG1DP(06)