

Panasonic[®] INSTRUCTION MANUAL

Ultra High-Speed, High-Accuracy Laser Displacement Sensor

Sensor Head

HL-C205□

MJE-HLC205 No.0097-61V

Thank you very much for purchasing Panasonic products. Read this Instruction Manual carefully and thoroughly for the correct and optimum use of this product. Kindly keep this manual in a convenient place for quick reference.

WARNING

- This product is intended to detect the objects and does not have the control function to ensure safety such as accident prevention. Do not use the product as a sensing device to protect human body.
- Be careful not to directly watch or touch the direct laser beam or reflected laser beam.
- The product was developed and manufactured for industrial use.

BEFORE USE

Before using the product, check the sensor head model and contents of packing.

- Sensor head model**
Check the model name of product at the top of sensor head.
- Packing**
Check that all of the following components are included in the package.
 - 1 sensor head unit
 - 1 Instruction manual
 - Laser warning labels [JIS/IEC/KS: 1 set, GB: 1 set (E type only)]

This product complies with CE Marking when used together with a controller and programmable display unit that are in compliance with CE Marking. Likewise, the product complies with UKCA Marking when used together with a controller and programmable display unit that are in compliance with UKCA Marking.

1 DESCRIPTION

- HL-C205B□, HL-C205C□ displacement sensor head achieves ultra high-speed and high-accurate measurement using linear image sensor as light receiving element to be used on equipment that require high-speed operation with high-accuracy.
- The product is used at diffuse or specular reflection sensor head by installing and setting.

2 CAUTIONS ON HANDLING LASER LIGHT

For the purpose of preventing any injury which may occur to the user by the use of the laser product in advance, the following standards have been established by the IEC Standards, JIS Standards, GB Standards, KS Standards and FDA Regulations.

IEC : IEC 60825-1:2014
 JIS : JIS C 6802:2014
 GB : GB 7247.1-2012
 KS : KS C IEC 60825-1:2013
 FDA : PART 1040.10, 1040.11(Laser Notice No.56)

These standards classifies laser products according to the level of hazard and provide the safety measures for respective classes.

- Laser hazardous class**
Classification according to IEC 60825-1:2014 (JIS C 6802:2014)

Class	Model	Description of hazardous evaluation
Class 2	HL-C205B(E) HL-C205B(E)-MK	Visible beam, low power. Blink response of eye affords protection.
Class 3R	HL-C205C(E) HL-C205C(E)-MK	Direct intrabeam viewing is hazardous, but risk is lower than for 3B.

WARNING label

<HL-C205B□>

In Japanese / English / Korean

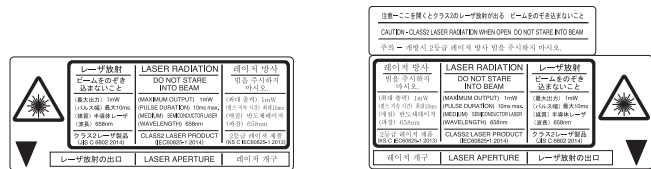

In Chinese (E type only)



<HL-C205C□>

In Japanese / English / Korean

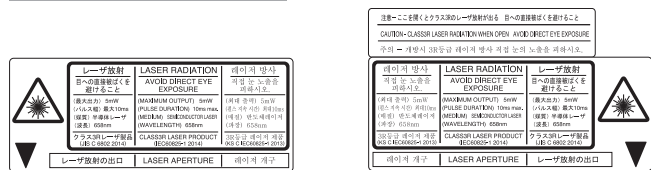

In Chinese (E type only)



FDA certification label

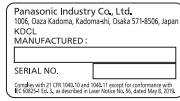

<Label position>

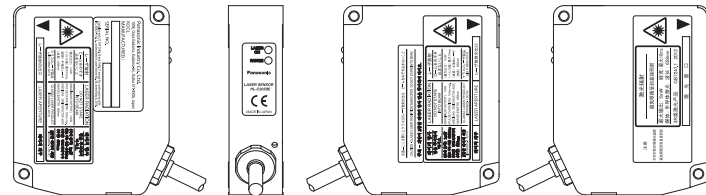

- Install the product so the laser beam comes higher or lower than eye level in order not to watch the beam directly during operation. Laser safety distance (Nominal Ocular Hazard Distance: NOHD) is approx. 0.4m. The laser beam must be terminated at the end of its path by a diffuse reflector or an absorber.
- Please contact our company if the system breaks down. It is not equipped with a function that stops laser radiation automatically during disassembling the sensor head. The users therefore may be exposed to laser beam in disassembling the sensor head.
- When this product is used in China, affix the Chinese warning label (accessory) on the label in the product.
- Do not use the system in the manner other than specified in this Instruction Manual.

3 SPECIFICATIONS

Model No.	HL-C205B(E)		HL-C205B(E)-MK		HL-C205C(E)		HL-C205C(E)-MK	
	Diffuse reflection	Specular reflection	Diffuse reflection	Specular reflection	Diffuse reflection	Specular reflection	Diffuse reflection	Specular reflection
Meas. method (Note 2)	Diffuse reflection / Specular reflection							
Measurement center distance	50mm	46mm	50mm	46mm	50mm	46mm	50mm	46mm
Measurement range (Note 3)	±5mm							
Beam source	Red semiconductor laser Class 2 (JIS/IEC/GB/KS), Class II (FDA) (Note 4) Max output: 1mW Emission Peak wavelength: 658nm				Red semiconductor laser Class 3R (JIS/IEC/GB/KS), Class IIIa (FDA) (Note 4) Max output: 5mW Emission Peak wavelength: 658nm			
Beam diameter (Note 5)	Approx. ø70µm		Approx. 70 × 1,000µm		Approx. ø70µm		Approx. 70 × 1,000µm	
Beam receiving element	Linear image sensor							
Resolution	0.2µm / average times: 256, 0.05µm / average times: 4,096 [E type (Note 6) 0.25µm / average times 256]							
Linearity	±0.03%F.S.							
Temperature characteristics	0.01%F.S./°C							
Indicator	Laser emission Green LED: Lights up during laser emission.							
	Meas. range Yellow LED: Near measurement center:ON, within measurement range:Blink, beyond the range:OFF							
Protective structure	IP67 (except connector)							
Pollution degree	2							
Insulation resistance	20M ohms or more by 500V DC megger (between all the terminals and enclosure.)							
Dielectric withstand	Commercial Frequency AC 500V for 1min. (between all the terminals and enclosure.)							
	Impulse ±1,000V 1.2/50µs (between all the terminals and enclosure.)							
Vibration resistance	Endurance: 10 to 55Hz (cycle: 1minute), Resistant amplitude of vibration: 1.5mm, in X, Y, and Z directions for 2 hours							
Shock resistance	196m/s ² in X, Y, and Z directions for 3 times							
Ambient illuminance (Note 7)	3,000lx or less (illuminance at beam receiving surface using incandescent lamp)							
Ambient temperature	0 to +45°C (No dew condensation or icing allowed), At storage: -20 to +70°C							
Ambient humidity	35 to 85%RH At storage:35 to 85%RH							
Ambient Height	2,000m or less							
Material	Main unit case / cover: Die-cast aluminum, Front cover: Glass							
Cable length	0.5m							
Cable extension	Extendible to 30m long maximum using the optional extension cable.							
Weight	Approx. 300g including cable weight							
Applicable regulations	Compliant with EU Law: EMC Directive / British Legislation: EMC Regulations							

- Notes: 1) Measuring conditions are as follows unless otherwise specified; connection with controller, power voltage: 24V DC, ambient temperature: 20°C, sampling cycle: 40µs, average times:256, at measurement center distance, object substance: white ceramic, and digital measurement value.
 2) Use the external ND filter (optional) in case the amount of reflected beam is too large on Specular Reflection installation.
 3) The measurement range is limited between +0.5 and +5.0mm (in case the sampling cycle is 20µs at diffuse reflection), between +0.5 and +5.0mm (in case the sampling cycle is 20µs at specular reflection), between +4.7 and +5.0mm (in case the sampling cycle is 10µs at diffuse reflection), or between +4.6 and +5.0mm (in case the sampling cycle is 10µs at specular reflection).
 4) This is based on the FDA Standard, according to Laser Notice No. 56 of the FDA Standard.
 5) The figure shows the value at measurement center distance. It is determined by 1/e² (approximately 13.5%) of center beam intensity. Due to leak light outside the specified area, the reflectance around the detecting point may be higher than at the point and this may affect the measurement value.
 6) The minimum resolution of 0.25µm can be achieved if the sensor head is connected to the controller that is not subject to "Foreign Exchange and Foreign Trade Law".
 7) The variation in ambient illuminance is ±0.03%F.S. or less.

4 EXPORT REGULATIONS BY JAPANESE GOVERNMENT

- HL-C205B(-MK) and HL-C205C(-MK) are subject to export control regulation by the Foreign Exchange and Foreign Trade Law. Export admission by Japanese government is required before the product is to be exported or brought out of the country. These products are also subject to Article 1.B.3.b.1 of Nuclear Suppliers Group in international export control regime and 2.B.6.b.1 of Wassenaar Arrangement.
 - Please follow the export control regulations required.
 - HL-C205BE(-MK) and HL-C205CE(-MK) (E type) are not subject to export control regulations under the condition that they are used combined with the non-pertinent controller to export control specified by Foreign Exchange and Foreign Trade Law.
- When they are combined with the pertinent controller to export control, they are subject to the Law. In this case export admission by Japanese government is required before the product is to be exported or brought out of the country.

5 CAUTIONS

Connection

- Turn off the power of controller before connecting or disconnecting the connectors.
- When connecting or disconnecting the connectors, be sure to hold the connector area not to apply extra force to the cable.
- Be careful not to touch terminals or to let foreign matter get in the connector after disconnecting connectors.
- Be careful not to apply force to around the connector of standard cable and extension cable. Do not bend the cables near connectors. Failure to do so causes disconnection of the cable.

Wiring

- Do not run the sensor cable along (bundled in parallel) with other wirings. Keep it at least 100mm away from other wires. Run the cable so it is separate from high voltage and power circuit lines. If it is necessary to run the cable in parallel with them, shield it by running through a grounded electrical conduit.
- Install the product as far away as possible from noise source such as high-voltage lines, high-voltage device, power lines, power device, machines which generate a large starting and stopping surge, welding machines and inverter motor.
- Do not pull the cable using a force more than 29.4N when routing the cable with the sensor head and controller fixed. At least 20 mm is required from the cable connection to the bend. The bending radius must be 30 mm or more.
- When the sensor head is moved around while in use, the cable in the moving part may be damaged. Therefore, use an extension cable for the moving part and, when the extension cable is damaged, immediately replace it. Otherwise, it may result in failure.

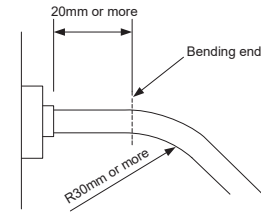

Cable Extension

- Use only one extension cable for connection between one sensor head and a controller.
- When the sensor head part is moved around while in use, fix the extension cable at a position 100 mm away from the mobile end.

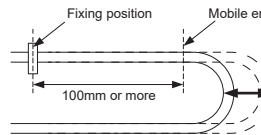

Warming up time

- Allow at least 30 minutes of warming up after turning on the power to ensure the performance of the product.

Environment

- The life of the semiconductor laser depends on the ambient temperature during use. When using the product near a heat source, take measures to lower the ambient temperature of the sensor head as possible. Mount the sensor on a device having good heat radiation because the sensor itself emits heat.
- Water, oil, or fingerprints on the emitter surface and receiver surface of sensor head reflects light. Dust and dirt on them block light. Keep them clean at all times. When cleaning these parts, wipe them off using a soft lint-free cloth or lens cleaning paper.
- Install the sensor head so ambient light such as sunlight or light with the same wavelength as laser beam should not enter the light receiver. If high accuracy is required, install a light shielding plate or the like on the sensor head.
- The controller and connectors are not structurally dustproof, waterproof, or corrosion-resistant. Do not use the product underwater or in the rain.
- Do not use the product in dusty places or that exposed to flammable or corrosive gases, droplet, direct sunlight, severe vibration or impact.

6 MEASUREMENT RANGE / INDICATOR

- Installation Mode: Diffuse

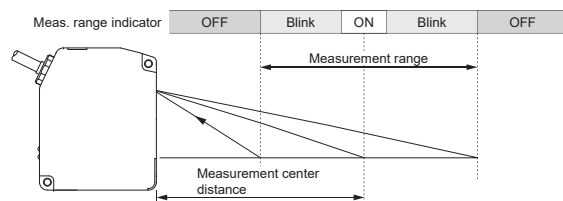

- The measurement range indicator at sampling cycle of 20µs or 10µs lights up at the center of limited measurement range.

7 MUTUAL INTERFERENCE AREA (Unit: mm)

- When installing 2 or more sensor heads side by side, mutual interference occurs if the laser spots from other sensor heads fall within the shaded areas in the right figure. Install sensor heads so the laser spots from other sensor heads fall outside the shaded areas.

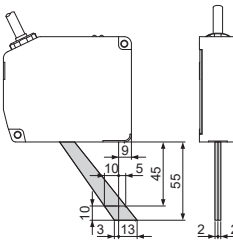

8 BEAM DIAMETER (Unit: mm)

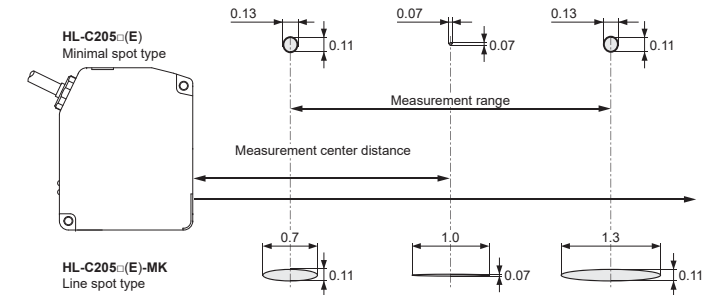

9 DIMENSIONS (Unit: mm)

- Installation Mode: Diffuse

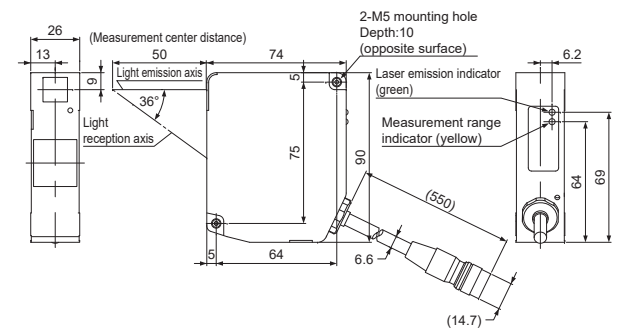

- Installation Mode: Specular

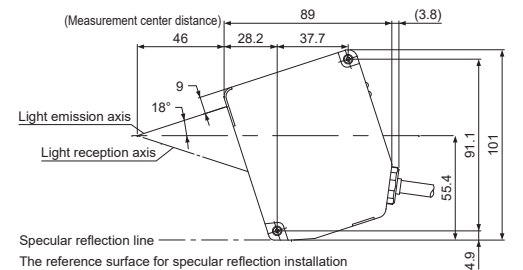

10 OPTION

- ND filter (product code: HL-C2F01) is optionally available to adjust the excessive received light intensity to an optimum level. This is useful when mounting the sensor head for specular reflection.

Panasonic Industry Co., Ltd.

1006, Oaza Kadoma, Kadoma-shi, Osaka 571-8506, Japan
<https://industry.panasonic.com/>

Please visit our website for inquiries and about our sales network.

Panasonic Industry Co., Ltd. 2024
 April, 2024

PRINTED IN JAPAN

