

Thru-Beam Type Digital Displacement  
Sensor

HG-T series

# User's Manual

---

(MEMO)

## Introduction

Thank you for purchasing an **HG-T** series thru-beam digital displacement sensor. Before using this product, read and understand this User's Manual. Use the product correctly and in the optimum manner. Keep this manual in a safe location for reference whenever necessary.

## Types of Manuals

The following user's manuals are available for the **HG-T** series. Refer to the appropriate manual according to your need.

The user's manuals are also available for download from our website (<https://industry.panasonic.com/>).

Unit name or purpose of use	Manual name	Manual code
HG-T Control Unit	HG-T User's Manual	WUME-HGTM
HG-T Configuration Tool	HG-T Configuration Tool User's Manual	WUME-HGTCT

### Please note

1. No part of this manual may be reproduced or reprinted in any form or by any means without prior written permission from Panasonic.
2. The contents of this manual are subject to change without notice for future improvement.
3. This manual has undergone strict quality control; but should you discover any dubious information, mistakes, misplaced pages, or missing pages, please contact your local dealer.

## Manual Configuration

Chapter 1	Before Using This Product	This chapter explains safety and handling precautions, laser safety standards, and other information that should be checked before using this product.
Chapter 2	System Configuration	This chapter explains the system configuration.
Chapter 3	Overview of <b>HG-T</b> Series	This chapter explains the principle of measurement and how to use this product when controllers are connected.
Chapter 4	Installation and Connections	This chapter explains installation, connections, wiring, and other work.
Chapter 5	Basic Usage	This chapter explains the flow of operations up to measurement startup, the base screen displayed when the power is turned ON, and basic operations.
Chapter 6	Setting up General Functions	This chapter explains details and settings for general functions.
Chapter 7	Setting up Extended Functions	This chapter explains details and settings for extended functions.
Chapter 8	Setting up Measurement Mode	This chapter explains details and setting methods for each measurement mode.
Chapter 9	Specifications and Dimensions	This chapter explains the specifications and dimensions.
Chapter 10	Maintenance	This chapter explains maintenance and inspection.
Chapter 11	Troubleshooting	This chapter explains troubleshooting and error codes.
Chapter 12	Appendix	This chapter provides menu structure.

## Product Version

This manual has been created based on the product functions available as of November 2020. For product version information, refer to "[1.6 Product Version and Functions](#)".

# Table of Contents

<b>1 Before Using This Product</b> .....	<b>1-1</b>
1.1 Safety Precautions (Always observe) .....	1-2
1.2 Handling Precautions.....	1-3
1.3 Laser Safety Standards .....	1-5
1.3.1 IEC/EN/JIS/GB/KS .....	1-5
1.3.2 FDA.....	1-6
1.4 Terminology.....	1-7
1.5 Contents of Package.....	1-8
1.6 Product Version and Functions .....	1-10
<b>2 System Configuration</b> .....	<b>2-1</b>
2.1 System Configuration.....	2-2
2.2 Description of Parts.....	2-3
2.2.1 Controller .....	2-3
2.2.2 Sensor head.....	2-5
2.2.3 Sensor Head Connection Cable .....	2-6
2.2.4 Side View Attachment.....	2-6
<b>3 Overview of HG-T Series</b> .....	<b>3-1</b>
3.1 Principle of Measurement .....	3-2
3.2 Role of Controllers .....	3-3
3.3 Using Connected Controllers .....	3-4
<b>4 Installation and Connections</b> .....	<b>4-1</b>
4.1 Mounting the Controller.....	4-2
4.1.1 Mounting on a DIN Rail .....	4-2
4.1.2 Removing from a DIN Rail .....	4-2
4.1.3 Controller Wiring Connection Diagrams.....	4-3
4.2 Attaching the Sensor Head .....	4-4
4.3 Connecting the Sensor Head Connection Cable .....	4-5
4.3.1 Connecting to the Sensor Head .....	4-5
4.3.2 Disconnecting from the Sensor Head .....	4-6
4.3.3 Connecting to the Controller .....	4-7
4.3.4 Disconnecting from the Controller.....	4-7
4.3.5 Connecting and Disconnecting to / from Controller Connector .....	4-7
4.4 Connecting Controllers .....	4-10
4.4.1 How to Connect .....	4-11
4.4.2 How to Remove .....	4-13
4.5 Mounting the Side View Attachment .....	4-14
<b>5 Basic Usage</b> .....	<b>5-1</b>
5.1 Using the Base Screen .....	5-2
5.1.1 Functions of Operation Pad and Display Unit .....	5-2

5.2	Flow of Operations up to Measurement Startup .....	5-6
5.3	Explanation of Basic Operation.....	5-8
5.3.1	Checking the Beam Axis .....	5-8
5.3.2	Adjusting the Beam Axis .....	5-9
5.3.3	Reference Waveform Registration .....	5-15
5.3.4	Teaching.....	5-16
5.4	Operation Mode .....	5-22
5.4.1	Auto Edge Detection Mode (ATE DGE) .....	5-22
5.4.2	Edge Detection Mode (EDGE).....	5-23
5.4.3	Outer diameter/Width Detection Mode (OUTWD) .....	5-24
5.4.4	Inner Diameter/Gap Detection Mode (INGAP) .....	5-25
5.4.5	Central Position Detection Mode (CENPOS).....	5-25
5.4.6	User-specified Edge Detection Mode (USREG).....	5-28
5.5	Settings on the Base Screen (Using Shortcut Keys) .....	5-31
5.5.1	Display Switching Mode.....	5-31
5.5.2	Preset.....	5-34
5.5.3	Saving and Loading Settings to / from Banks .....	5-36
5.5.4	Key Lock .....	5-39
5.5.5	Sensitivity Settings .....	5-40
5.6	Self-monitoring Function .....	5-47
5.6.1	Using the Self-monitoring Function .....	5-47
5.6.2	Statuses and Measures .....	5-48

## **6 Setting up General Functions..... 6-1**

6.1	Flow of Measurement Data.....	6-2
6.2	Setting Operation List .....	6-4
6.3	Detection Settings (DETECT) .....	6-9
6.3.1	Operation Mode (OPMODE) .....	6-9
6.3.2	Measurement Direction (DIRECT).....	6-10
6.3.3	Average Count (Response Time)(SPEED).....	6-11
6.4	Basic Settings (BASIC).....	6-15
6.4.1	HIGH Set Value (HISET).....	6-15
6.4.2	LOW Set Value (LOSET).....	6-16
6.4.3	Hysteresis (HYSTER) .....	6-18
6.4.4	Teaching Types (TEACH) .....	6-21
6.4.5	Tolerance <±> (TOL (±)) .....	6-22
6.4.6	Preset Value (PRVAL).....	6-23
6.4.7	Preset Data Selection (PROBJ) .....	6-24
6.4.8	Preset Save (PRESAVE) .....	6-25
6.4.9	Reference Waveform Save (WVSAVE).....	6-26
6.4.10	Output Operation (OUTPUT) .....	6-27
6.4.11	Analog Output Selection (A/OSSEL) .....	6-28
6.4.12	Menu Display Settings (MENU) .....	6-29
6.5	Initialization (RESET).....	6-31

6.6 Maintenance (MAINTEN)	6-32
<b>7 Setting up Extended Functions</b>	<b>7-1</b>
7.1 Setting Operation List	7-2
7.2 Advanced Settings (ADVANCE)	7-8
7.2.1 Hold Settings (HOLD)	7-8
7.2.2 Simultaneous Input (ALL IN)(For Master Units Only)	7-11
7.2.3 External Inputs (EXTIN)	7-13
7.2.4 External Outputs (EXTOUT)	7-15
7.2.5 External Output Delay Timer Selection (OUTDLY)	7-23
7.2.6 Number of Digits Displayed (DIGIT)	7-29
7.2.7 Analog Scaling (ANALOG)	7-30
7.2.8 Eco Mode (ECO)	7-35
7.2.9 Alarm Settings (ALARM)	7-36
7.2.10 Key Lock Function Selection (KEYLOCK)	7-41
7.2.11 Interference Prevention Function (INTFPR)(For Master Units Only)	7-42
7.2.12 Sampling Cycle (SAMPLE)	7-44
7.2.13 Reverse of Measured Value (REVERSE)	7-45
7.3 Calculation Settings (CALC)(For Master Units Only)	7-47
7.3.1 Calculation Mode (MODE)	7-47
7.3.2 Calculation Application Selection (APPLI)	7-48
7.4 Copy Settings (COPY)	7-53
7.4.1 Copy Individual Selection (COPYSEL)(For Master Units Only)	7-53
7.4.2 Copy Batch Selection (CHKALL)(For Master Units Only)	7-56
7.4.3 Copy Execution (COPYEXE)(For Master Units Only)	7-56
7.4.4 Copy Lock (LOCK)(For Slave Units Only)	7-57
7.5 Bank Settings (BANK)	7-59
7.5.1 Bank Save Selection (BNKDAT)	7-59
7.6 Calibration Settings (CALIB)	7-61
7.6.1 Calibration Selection (CALSEL)	7-61
<b>8 Setting up Measurement Mode</b>	<b>8-1</b>
8.1 Sample Hold Mode	8-2
8.1.1 Function	8-2
8.1.2 Behaviors at Hold Input	8-2
8.2 NG Hold Mode	8-3
8.2.1 Function	8-3
8.2.2 Behaviors at Hold Input	8-4
8.3 Peak Hold Mode	8-8
8.3.1 Function	8-8
8.3.2 Behaviors at Hold Input	8-8
8.4 Bottom Hold Mode	8-9
8.4.1 Function	8-9

8.4.2 Behaviors at Hold Input.....	8-9
8.5 Peak-to-peak Hold Mode .....	8-10
8.5.1 Function .....	8-10
8.5.2 Behaviors at Hold Input.....	8-10
8.6 Tab Cancellation Mode .....	8-11
8.6.1 Flow of Measurement Data during Tab Cancellation .....	8-12
8.6.2 Setting up the Function .....	8-14
8.6.3 Operations when the Tab is Detected .....	8-16
8.6.4 Response Time when the Tab Cancellation Function Is Enabled ....	8-17
8.6.5 Precautions when Using the Tab Cancellation Function.....	8-18
<b>9 Specifications and Dimensions .....</b>	<b>9-1</b>
9.1 Specifications.....	9-2
9.1.1 Controller .....	9-2
9.1.2 Sensor Head .....	9-9
9.2 Dimension Drawings .....	9-11
9.2.1 Controller .....	9-11
9.2.2 Sensor Head .....	9-13
9.2.3 Side View Attachment.....	9-14
<b>10 Maintenance .....</b>	<b>10-1</b>
10.1 Maintenance and Inspection.....	10-2
10.1.1 Maintenance Precautions .....	10-2
10.1.2 Main Inspection Items .....	10-2
<b>11 Troubleshooting .....</b>	<b>11-1</b>
11.1 Troubleshooting.....	11-2
11.2 Error Messages.....	11-5
<b>Appendix Menu Structure .....</b>	<b>App-1</b>
Menu Structure (General Function Display).....	App-2
Menu Structure (Extended Function Display).....	App-4



# 1 Before Using This Product

---



1.1 Safety Precautions (Always observe) .....	1-2
1.2 Handling Precautions.....	1-3
1.3 Laser Safety Standards .....	1-5
1.3.1 IEC/EN/JIS/GB/KS.....	1-5
1.3.2 FDA.....	1-6
1.4 Terminology.....	1-7
1.5 Contents of Package.....	1-8
1.6 Product Version and Functions.....	1-10









## 1.1 Safety Precautions (Always observe)





### 1.1 Safety Precautions (Always observe)

This section explains important rules that must be observed to prevent personal injury and property damage.

- **Safety precautions items are classified into “WARNING” and “CAUTION” depending on the level of hazard.**





 <b>WARNING</b>	Risk of death or serious injury.
 <b>CAUTION</b>	Risk of minor injury or property damage.

 <b>WARNING</b>	
	• Never use this product as a sensing device for personnel protection.
	• For sensing devices for personal protection, use products that conform to the laws and standards related to personal protection in each country, such as OSHA, ANSI, and IEC.
	• This product is designed to inspect (judge or measure) objects and so must not be used to ensure safety, for example, to prevent accidents that affect human lives or property.
	• Avoid observing beams in a dark surrounding environment.
	• Do not look at beams using an optical device such as an optical telephoto system.
	• Never attempt to disassemble, repair, or modify this product.
	• Control or adjustment according to procedures other than those provided in this Installation Instructions Manual may cause exposure to hazardous emitted laser beams.

 <b>CAUTION</b>	
	• For the controller DC power supply, only use a power supply that is isolated by means of an isolation transformer or otherwise.
	• There is a risk of short-circuiting and damage to the controller or power supply if a transformer such as an autotransformer is used. There is a risk of short-circuiting and damage to the controller or power supply if the controller is incorrectly mounted or connected.
	• The HG-TC series controller is designed to be used with the HG-T series special-purpose sensor head to satisfy the specifications. If the controller is used with any sensor head other than the special-purpose sensor head, the specifications will not be satisfied and malfunctioning or another problem may occur.

## 1.2 Handling Precautions

- In this manual, the following symbols are used to indicate safety information that must be observed.

	Indicates an action that is prohibited or a matter that requires caution.
	Indicates an action that must be taken.
	Indicates supplemental information.
	Indicates details about the subject in question or information useful to remember.
	Indicates operation procedures.

### ■ Handling precautions

#### Specifications

- This product has been developed / produced for industrial use only.
- This product (controller and sensor head receiver) uses an EEPROM.  
The EEPROM has a service life of one million setting operations.
- Do not use this product outside the range of the specifications. Risk of an accident and product damage.  
There is also a risk of a noticeable reduction of service life.

#### Power supply

- Verify that the supply voltage fluctuations are within the rating.
- If power is supplied from a commercial switching regulator, ensure that the frame ground (F.G.) terminal of the power supply is connected to an actual ground.
- Do not use during the initial transient time after the power supply is switched ON.
- To ensure performance, use the product at least 30 minutes (warm-up time) after the power is turned ON.

#### Wiring

- Make sure that the power is OFF before performing wiring or connection work for the controller.
- Note that there is a risk of damage or burning if the load is short-circuited or incorrectly wired.
- After wiring is completed, check the wiring carefully before turning ON the power.
- Do not wire the controller in parallel with a high-voltage line or power line or use the same conduit as these lines. Doing so may result in malfunctioning due to induction.
- Do not apply stress such as excessive bending or pulling to the extracted part of a cable.
- When connecting the sensor head connection cable to this product, do not apply force to the product.

#### Usage environment

- This product is suitable for indoor use only.
- The light emitting and receiving surfaces of the sensor head must be free of water, oil, fingerprints, and other substances that refract light as well as dust, grit, and other objects that intercept light.

## 1.2 Handling Precautions

---

If stains or dirt become attached to the sensor head surfaces, wipe them with a lint-free soft cloth or lens cleaning paper. If the surfaces are very dirty, wipe off dirt using a cotton swab (or similar material) moistened with absolute alcohol.

- Do not allow ambient light such as sunlight to directly hit the light receiving section of the sensor head. In particular, if precision is required, use this product by mounting a douser (or similar material) on the sensor head.
- When a measured object with a strong specular reflection component (such as glass or specular reflector) is detected, it may not be detected correctly due to the influences of light reflected from the measured object. In such a case, install a pair of emitter and receiver at a certain angle so that reflected light does not hit the emitter or receiver. After adjusting the angle, always check the beam axis. After checking the beam axis, if the beam axis is aligned, register the reference waveform. If the beam axis is misaligned, readjust the beam axis, and register the reference waveform.
- Avoid using this product in environments where condensation occurs due to sudden temperature change.
- Avoid dust, dirt, and steam.
- Avoid using the product in atmospheres that contain corrosive or other harmful gases.
- Ensure that the product does not come into contact with organic solvents such as thinner.
- Ensure that the product does not come into contact with strong acid or alkaline.
- Ensure that the product does not come into contact with oil or grease.
- This product cannot be used in an environment that contains flammable or explosive gases.
- Performance may not be satisfactory in a strong electromagnetic field.
- Do not use this product in locations subject to severe vibration or shock.
- This product is a precision device. Do not drop or otherwise subject to shock. Risk of product damage.
- Take care not to touch any terminals in the connector or allow foreign objects to enter the connector.
- The sensor head is watertight, but the connectors are not structurally resistant to dust, water or corrosion. Therefore, the HG-T series cannot be submerged in water or placed under falling water for measurement operation. Pay attention to the environment where the product is used.

### **Other matters**

- Never attempt to disassemble, repair, or modify the product.
- When the product becomes unusable or unneeded, dispose the product appropriately as industrial waste.

**1.3 Laser Safety Standards**

**1.3.1 IEC/EN/JIS/GB/KS**

For the purpose of preventing any injury which may occur to the user by the use of the laser product in advance, the following standards have been established by the IEC Standards, EN Standards, JIS Standards, GB Standards and KS Standards.

- IEC : IEC 60825-1:2014
- EN : EN 60825-1:2014/A11:2021
- JIS : JIS C 6802:2014
- GB : GB 7247.1-2012
- KS : KS C IEC 60825-1:2014

These standards classify laser products into classes according to the danger level of laser, and prescribe safety and preventive measures that should be implemented for each class.

This product belongs to “Class 1 laser product” according to IEC 60825-1:2014(EN 60825-1:2014/A11:2021) “Radiation Safety of Laser Products”.

**Explanation of danger level**

Classification	Overview of danger evaluation
Class 1	A laser that is safe when operated under operating conditions that can be reasonably foreseen.

■ **Warning label**

On the emitter side

● **HG-T1010**



● **HG-T1110**



<Label position>



## 1.3 Laser Safety Standards

### 1.3.2 FDA

#### ■ Exporting to the USA

If this product is incorporated into facilities or equipment to be exported to the US, it is subject to the laser regulations of the US Food and Drug Administration (FDA). To prevent laser products from affecting their users, PART1040 (Performance Standards for Light-Emitting Products) was established as one of the FDA regulations. These standards classify laser products into classes according to the hazard level of laser and prescribe safety and preventive measures that should be implemented for each class.

This product complies with the FDA regulations (FDA 21 CFR 1040.10 and 1040.11) in accordance with FDA Laser Notice No. 56, except for complying with IEC 60825-1 Ed. 3. (Class 1 laser product)

#### ■ FDA certificate / identification label

Complies with 21 CFR 1040.10 and 1040.11 except for conformance with IEC 60825-1 Ed. 3., as described in Laser Notice No. 56, dated May 8, 2019.

**Panasonic Industry Co., Ltd.**

1006, Oaza Kadoma, Kadoma-shi, Osaka 571-8506, Japan

MANUFACTURED :

#### ■ Label position

##### Emitter

- Common to **HG-T1010** and **HG-T1110**

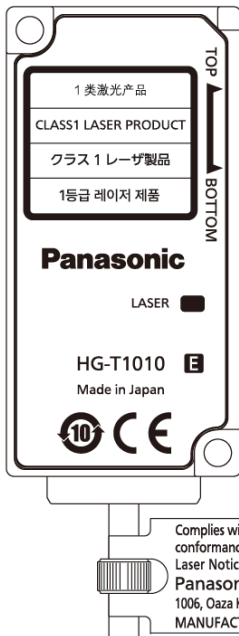

## 1.4 Terminology

Term	Description
Controller - Master unit	A controller that can be used on a standalone basis
Controller - Slave unit	A controller that is used by connecting to a master unit
Sensor head - Emitter	A sensor head emitter that is used by connecting to a controller
Sensor head - Receiver	A sensor head receiver that is used by connecting to a controller
Sensor head connection cable	A cable that is used to connect a sensor head and controller
Side view attachment	An attachment that is used to refract laser beams from the sensor head at 90 degrees
End plate	A plate that is used to secure both ends of controllers to prevent the connectors from coming off and causing a communication failure when controllers are connected
Communication unit	An interface unit that enables measurement data and other data of connected controllers to be monitored. <sup>(Note 1)</sup>

(Note 1) For details on communication units, refer to the user's manual for each communication unit.

## 1.5 Contents of Package

### 1.5 Contents of Package

The following accessories are included in the product package. Before using the product, make sure that no items are missing.

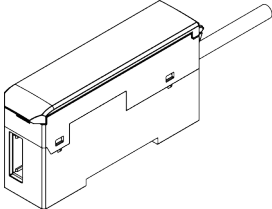
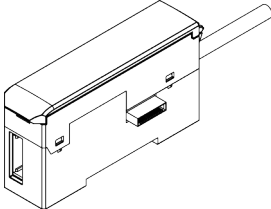
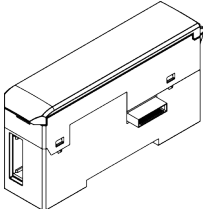
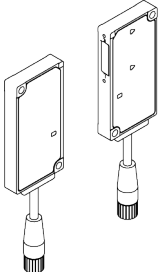
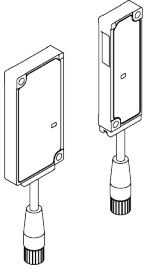
Controller	
<p><b>HG-TC101</b> / Master unit of high-performance NPN output type  <b>HG-TC101-P</b> / Master unit of high-performance PNP output type</p> <ul style="list-style-type: none"> <li>• Controller: 1 pc.</li> </ul>  <ul style="list-style-type: none"> <li>• Instruction Manual (English / Japanese, Chinese / Korean): 1 pc. each</li> <li>• General Information for Safety, Compliance, and Instructions : 1 pc.</li> </ul>	<p><b>HG-TC111</b> / Slave unit of high-performance NPN output type  <b>HG-TC111-P</b> / Slave unit of high-performance PNP output type</p> <ul style="list-style-type: none"> <li>• Controller: 1 pc.</li> </ul>  <ul style="list-style-type: none"> <li>• Instruction manual (English / Japanese, Chinese / Korean): 1 pc. each</li> <li>• General Information for Safety, Compliance, and Instructions : 1 pc.</li> </ul>
<p><b>HG-TC113</b> / Slave unit of wire-saving type</p> <ul style="list-style-type: none"> <li>• Controller: 1 pc.</li> </ul>  <ul style="list-style-type: none"> <li>• Instruction manual (English / Japanese, Chinese / Korean): 1 pc. each</li> <li>• General Information for Safety, Compliance, and Instructions : 1 pc.</li> </ul>	
Sensor head	
<p><b>HG-T1010</b> / Measurement width 10 mm, standard type</p> <ul style="list-style-type: none"> <li>• Sensor head (emitter and receiver): 1 set</li> </ul>  <ul style="list-style-type: none"> <li>• Instruction manual (English / Japanese, Chinese / Korean): 1 pc. each</li> </ul>	<p><b>HG-T1110</b> / Measurement width 10 mm, slim type</p> <ul style="list-style-type: none"> <li>• Sensor head (emitter and receiver): 1 set</li> </ul>  <ul style="list-style-type: none"> <li>• Instruction manual (English / Japanese, Chinese / Korean): 1 pc. each</li> </ul>



Sensor head	
<ul style="list-style-type: none"> <li>General Information for Safety, Compliance, and Instructions : 1 pc.</li> </ul>	<ul style="list-style-type: none"> <li>General Information for Safety, Compliance, and Instructions : 1 pc.</li> </ul>
Side view attachment	Sensor head connection cable
<b>HG-TSV10</b> / Side view attachment <ul style="list-style-type: none"> <li>Attachment: 1 pc. <a href="#">(Note 1)</a></li> <li>M2 screw with washer (length: 4 mm): 2 pcs.</li> </ul>	<b>CN-HT-C2</b> / Cable length 2 m <b>CN-HT-C5</b> / Cable length 5 m <b>CN-HT-C10</b> / Cable length 10 m <b>CN-HT-C20</b> / Cable length 20 m <ul style="list-style-type: none"> <li>Connection cable: 1 pc.</li> </ul>

(Note 1) HG-TSV10 is sold by one unit. Two units are required for a pair of emitter and receiver.

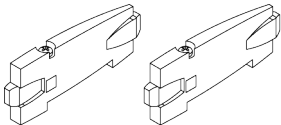
End plate
<b>MS-DIN-E</b> / End plate <ul style="list-style-type: none"> <li>Plate: Set of 2 pcs.</li> </ul>  <ul style="list-style-type: none"> <li>Instruction manual</li> </ul>

## 1.6 Product Version and Functions

### 1.6 Product Version and Functions

The following functions are added to the **HG-TC** series controllers and **HG-T** series sensor heads manufactured in November 2020 onwards.

Added function	Description	Remarks
Assigned edge detection mode	Operation mode	"6.3.1 Operation Mode ( <i>OPMODE</i> )"
Tab cancellation function	Hold setting	"7.2.1 Hold Settings ( <i>HOLD</i> )"
Hold state output	External output	"7.2.4 External Outputs ( <i>EXT.OUTPUT</i> )"
Measured value reversal selection function	Measured value reversal	"7.2.13 Reverse of Measured Value ( <i>REVERSES</i> )"



- The controllers and sensor heads manufactured in October 2020 or earlier do not support the above functions. Please note this point.

#### ■ <How to check manufacturing year and month>

Check the manufacturing lot No. shown in the following figure.

##### ■ Controller

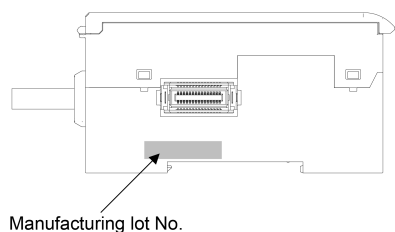

##### ■ Sensor head

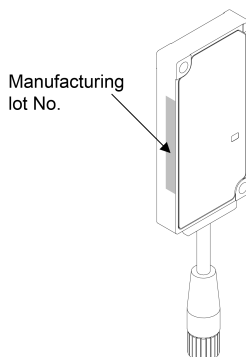

#### ■ <How to interpret the manufacturing lot No.>

OK1N (Manufactured in November 2020)

Manufacturing month [A (January), B (February), C (March) ... L (December)]

Manufacturing year [A (2010), B (2011), C (2012) ... J (2019)]  
 [0 (2020), 1 (2021), 2 (2022) ... 9 (2029)]

Switching between numerals and alphabets every 10 years.

# 2 System Configuration

---

2.1 System Configuration.....	2-2
2.2 Description of Parts.....	2-3
2.2.1 Controller .....	2-3
2.2.2 Sensor head.....	2-5
2.2.3 Sensor Head Connection Cable .....	2-6
2.2.4 Side View Attachment.....	2-6

## 2.1 System Configuration

### 2.1 System Configuration

The **HG-T** series consists of controllers, sensor head connection cables, and sensor heads.

For the controllers, master units (two types) and slave units (three types) are available. Up to 15 slave units can be connected to one master unit. For the sensor heads, two types are available. For the sensor head connection cables, four types are available.

Connecting a communication unit to the end of the connection enables information to be checked from outside. (Note 1)



- Always shut OFF the power before connecting or disconnecting a slave unit or communication unit to / from the master unit. If you connect or disconnect a unit with the power ON, the controller may become damaged.
- Insert the male connector all the way into the female connector. If the connectors are not completely connected, the controller may become damaged.
- To connect units, always mount them on a DIN rail. To do so, mount end plates **MS-DIN-E** (optional) so as to enclose the connected units at both ends.
- When connecting slave units to the master unit, connect only NPN output type units or only PNP output type units. Dissimilar output types cannot be connected together.

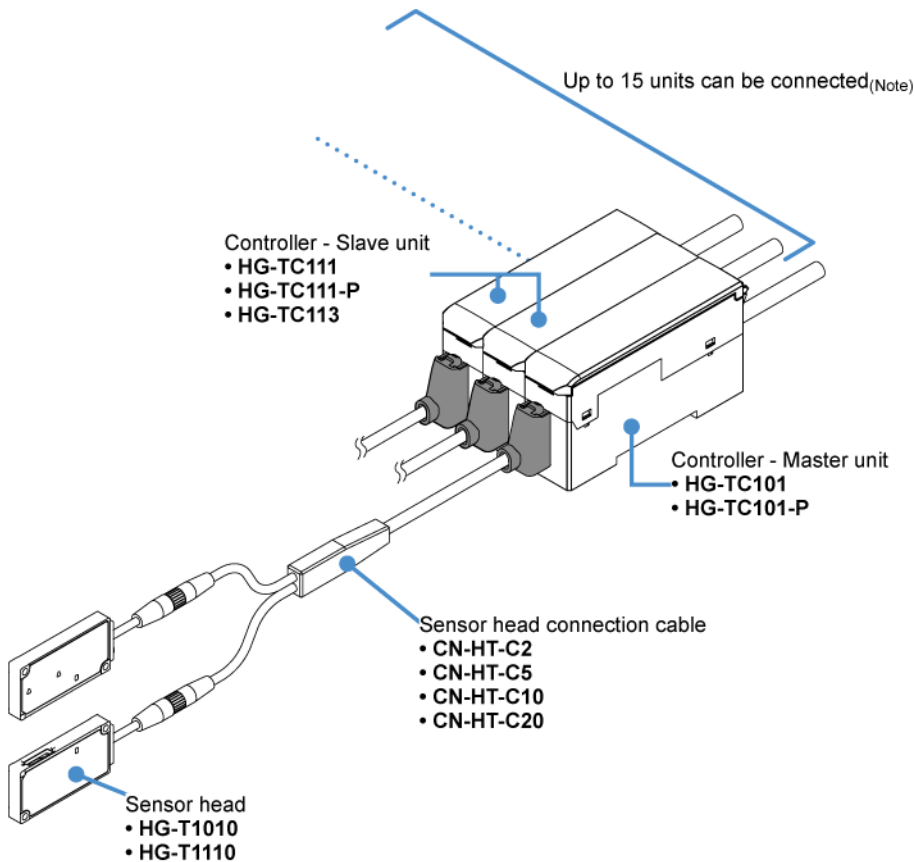

(Note 1) When a communication unit is connected, up to 14 slave units can be connected.

## 2.2 Description of Parts

### 2.2.1 Controller

**HG-TC101 / Master unit of high-performance NPN output type, HG-TC101-P / Master unit of high-performance PNP output type**

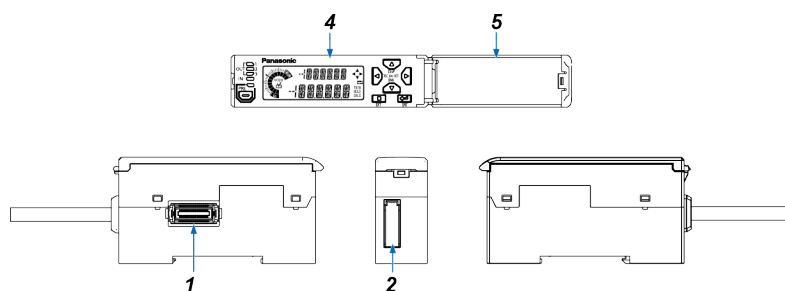

**HG-TC111 / Slave unit of high-performance NPN output type, HG-TC111-P / Slave unit of high-performance PNP output type**

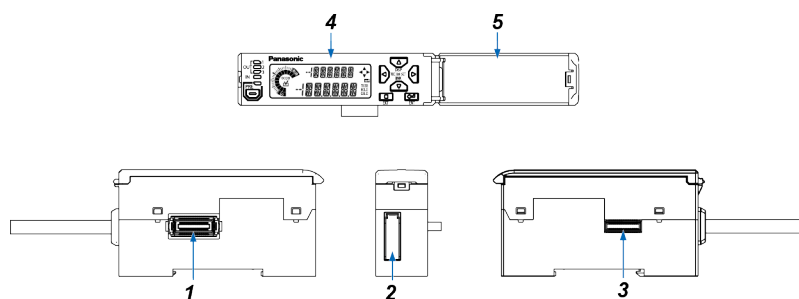

**HG-TC113 / Slave unit of wire-saving type**

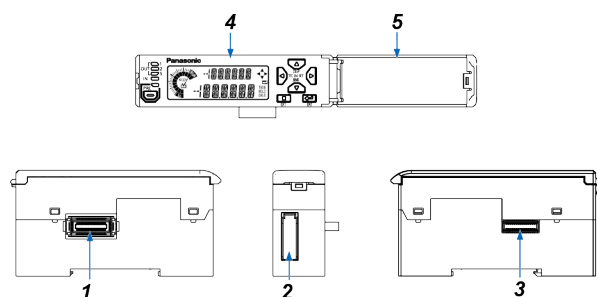

	Name	Function
1	Female connector	For connection to a slave unit. Remove the connector cover before connecting to a slave unit.
2	Sensor head connection cable connector	Connects the sensor head connection cable.
3	Male connector (for slave unit only)	For connection to a master unit or slave unit.

## 2.2 Description of Parts

	Name	Function
4	Digital display section / operation unit	For checking measured values and perform setting operation. For details, refer to the following page.
5	Digital display section / operation unit cover	Protects the display unit and operation unit. Keep the cover closed when the display unit / operation unit is not used.

### ■ Display unit / operation unit

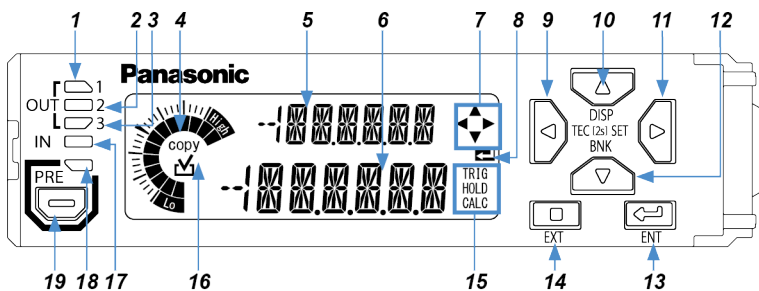

	Name	Function	
1	Output 1 indicator (Orange)	Lights up when output 1 is ON.	
2	Output 2 indicator (Orange)	Lights up when output 2 is ON.	
3	Output 3 indicator (Orange)	Lights up when output 3 is ON.	
4	Circle meter (Orange, green)	<ul style="list-style-type: none"> <li>Shows increases or decreases of the judgment value by meter display.</li> <li>Shows the level and item sequence of setting work by navigation display.</li> </ul>	
5	Digital display section / SUB (Green)	Shows the setting item and the item set using display switching mode.	
6	Digital display section / MAIN (White)	Shows the measured value, judgment value, and setting.	
7	Guide mark / arrow keys (White)	Lights up when each key (LEFT / RIGHT / UP / DOWN) is enabled during each setting operation.	
8	Guide mark / Enter (White)	Lights up when the ENTER key is enabled during each setting operation.	
9	LEFT key	Used to change setting items and settings when configuring settings, and to move through set value digits.	
10	UP key		
11	RIGHT key		
12	DOWN key		
13	ENTER key	Used to select setting items and apply settings when configuring settings.	
14	EXIT key	Used to exit a setting item or cancel a setting when configuring settings.	
15	Status mark	TRIG (White)	Lights up while the trigger input (external input) is ON.
		HOLD (White)	Lights up while the judgment value is held.
		CALC (White)	Lights up when calculation mode is set with a slave unit connected.
16	Copy checkmark (Orange)	"COPY" lights up for a setting item that can be copied to a slave unit when a master unit is set up. In this case, if the setting item is selected as a copy	

## 2.2 Description of Parts

	Name	Function
		target, the checkmark will light up and executing copy will perform copy processing.
17	Input indicator (White)	Lights up when external input 1, 2, or 3 is ON.
18	Preset indicator (Green)	Lights up when the preset function is used.
19	Preset key	Used to set and cancel the preset function.

### 2.2.2 Sensor head

#### HG-T1010

##### Emitter

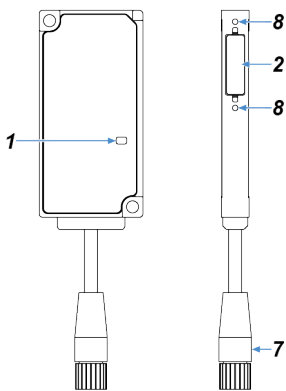

##### Receiver

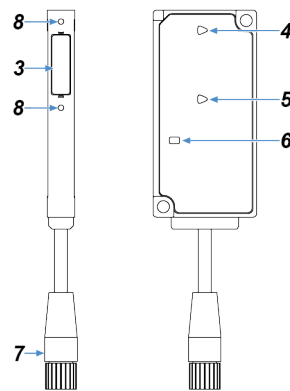

#### HG-T1110

##### Emitter

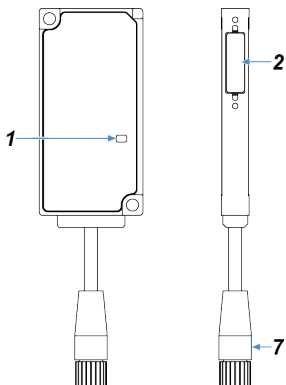

##### Receiver

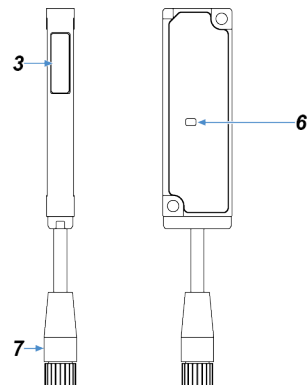

	Name	Function
1	Laser radiation indicator (Green)	Lights up when laser beams are emitted.
2	Light emitting surface	The surface that emits laser beams
3	Light receiving surface	The surface that receives laser beams

## 2.2 Description of Parts

	Name	Function
4	Beam axis adjustment indicator / TOP part (Orange / Green) <sup>(Note 1)</sup>	Indicates the beam axis adjustment state as light color (green or orange) and lighting state (lit, flashing, or unlit). (Only when the beam axis adjustment function is used)
5	Beam axis adjustment indicator / BOTTOM part (Orange / Green) <sup>(Note 1)</sup>	
6	Judgment output indicator (Orange / Green)	When controller judgment value is within the threshold range: Lights green. When controller judgment value is outside the threshold range: Lights orange. When the beam axis adjustment function is used: OFF
7	Sensor head connection cable connector	Connects the sensor head connection cable.
8	Female thread for mounting side view attachment	Connects the side view attachment and sensor head using an M2 screw with washer (length: 4 mm).

(Note 1) The **HG-T1110** is not equipped with the beam axis adjustment indicators (TOP / BOTTOM part).

### 2.2.3 Sensor Head Connection Cable

**CN-HT-C2** / Cable length 2 m

**CN-HT-C5** / Cable length 5 m

**CN-HT-C10** / Cable length 10 m

**CN-HT-C20** / Cable length 20 m

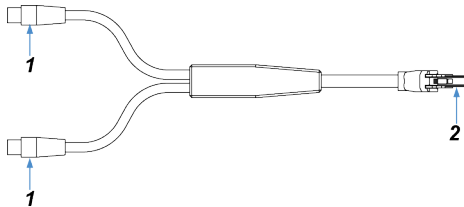

	Name	Function
1	Sensor head connector	Connects to the sensor head cable connector on the sensor head. There is no difference between the connectors on the emitter side and on the receiver side.
2	Controller connector	Connects to the sensor head cable connector on the controller.

### 2.2.4 Side View Attachment

**HG-TSV10**

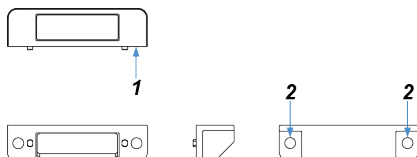



## 2.2 Description of Parts

---

	<b>Name</b>	<b>Function</b>
<b>1</b>	Sensor head mounting surface	Mounts the side view attachment on the light emitting and receiving surfaces of the sensor head
<b>2</b>	Sensor head mounting hole	Connects the side view attachment and sensor head using an M2 screw with washer (length: 4 mm).

(MEMO)

# 3 Overview of HG-T Series

---

3.1 Principle of Measurement .....	3-2
3.2 Role of Controllers .....	3-3
3.3 Using Connected Controllers .....	3-4

## 3.1 Principle of Measurement

### 3.1 Principle of Measurement

The sensor head emits belt-shaped laser beams from its emitter and receives them with the light receiving element (CMOS) of its receiver. If a measured object is inserted between the emitter and receiver of the sensor head, the bright section (light entry section) that receives laser beams and the dark section (light interception section) that is the shade of the measured object are projected on to the CMOS.

The difference in the amount of received light between each pixel of the CMOS is used to detect position information about the border between the light entry section and the light interception section and measure the object.

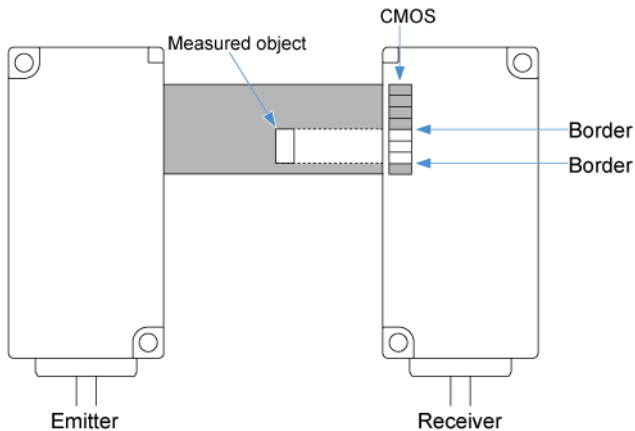

- The edge position of the measured object can be measured.

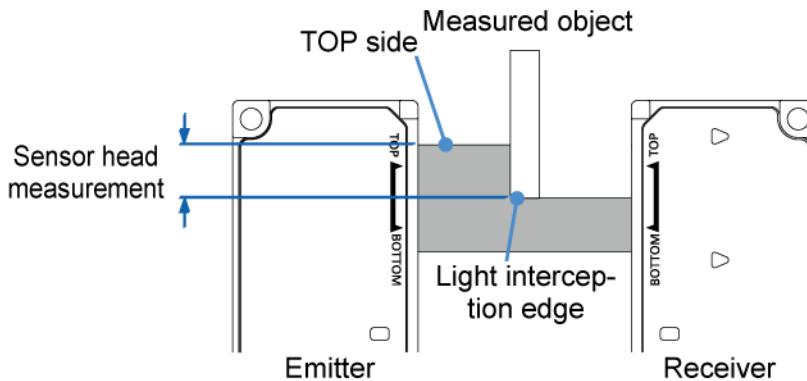

### 3.2 Role of Controllers

Sensor head measured values are sent from the sensor head to the controller. Measured values can be held in the controller and calculations performed. The results of the calculations are displayed as judgment values. Output judgment is based on judgment values. The controller is equipped with three outputs (OUT 1, OUT 2, and OUT 3) and with indicators that show the respective results of the three outputs.

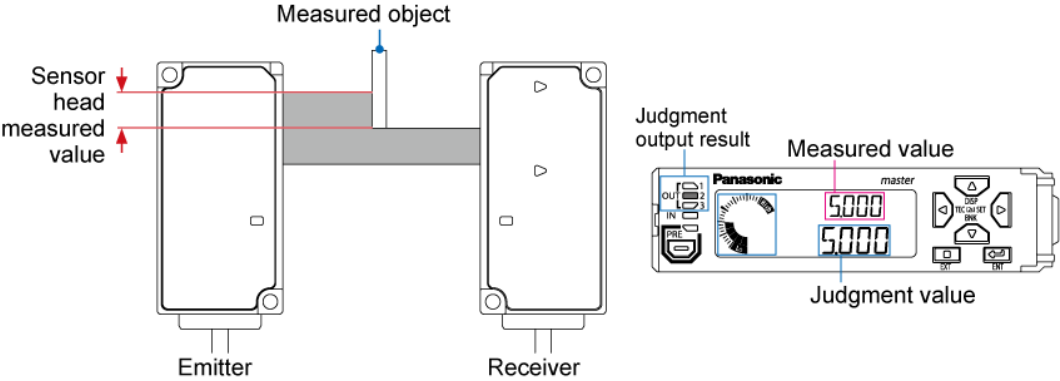

### 3.3 Using Connected Controllers

#### 3.3 Using Connected Controllers

The **HG-T** series enables measurement for various applications to be performed by connecting slave units to the master controller.

##### ■ Calculation setting

This function can perform calculation processing based on the measured values of the connected controllers and output the calculation results from the master unit.

##### Example: Thickness / width measurement

The measured values that the master unit and the slave unit obtain for the measured object are added.

This enables the width of the measured object to be measured.

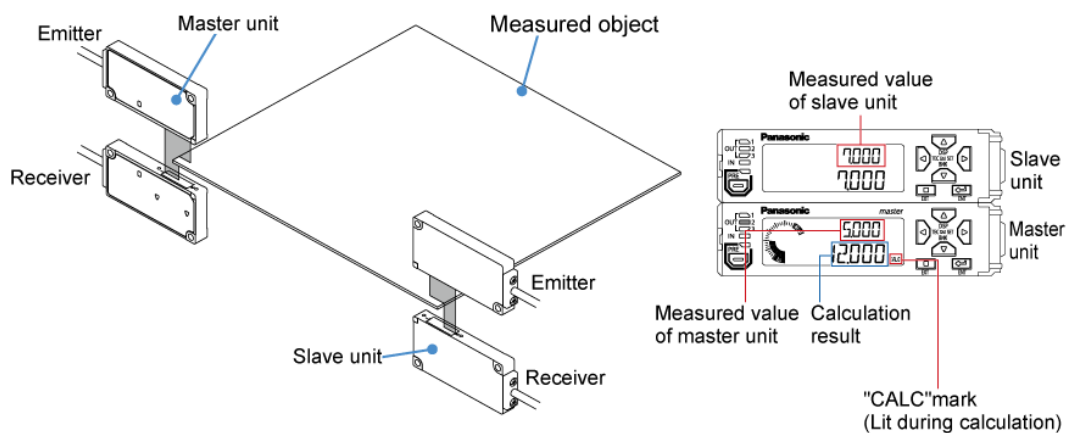

Other functions that are valid when controllers are connected include the interference prevention function and calculation output function.

# 4 Installation and Connections

---

4.1 Mounting the Controller.....	4-2
4.1.1 Mounting on a DIN Rail.....	4-2
4.1.2 Removing from a DIN Rail.....	4-2
4.1.3 Controller Wiring Connection Diagrams.....	4-3
4.2 Attaching the Sensor Head.....	4-4
4.3 Connecting the Sensor Head Connection Cable.....	4-5
4.3.1 Connecting to the Sensor Head.....	4-5
4.3.2 Disconnecting from the Sensor Head.....	4-6
4.3.3 Connecting to the Controller.....	4-7
4.3.4 Disconnecting from the Controller.....	4-7
4.3.5 Connecting and Disconnecting to / from Controller Connector.....	4-7
4.4 Connecting Controllers.....	4-10
4.4.1 How to Connect.....	4-11
4.4.2 How to Remove.....	4-13
4.5 Mounting the Side View Attachment.....	4-14

## 4.1 Mounting the Controller

---

### 4.1 Mounting the Controller

#### 4.1.1 Mounting on a DIN Rail

##### **1 2** Procedure

1. Fit the rear part of the mounting section of the controller on a DIN rail.
2. While pushing the rear of the mounting part forward, insert the front of the mounting part into the DIN rail.

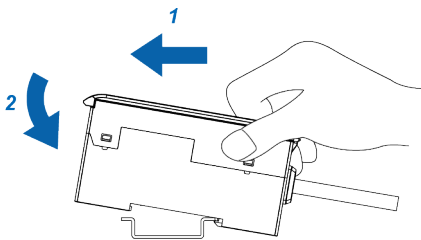

#### 4.1.2 Removing from a DIN Rail

##### **1 2** Procedure

1. Grasp the controller and push it forward.
2. Lift up the front part of the controller to remove it.

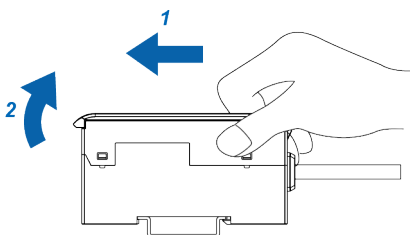



**4.1.3 Controller Wiring Connection Diagrams**

**HG-TC101, HG-TC101-P / Master unit**

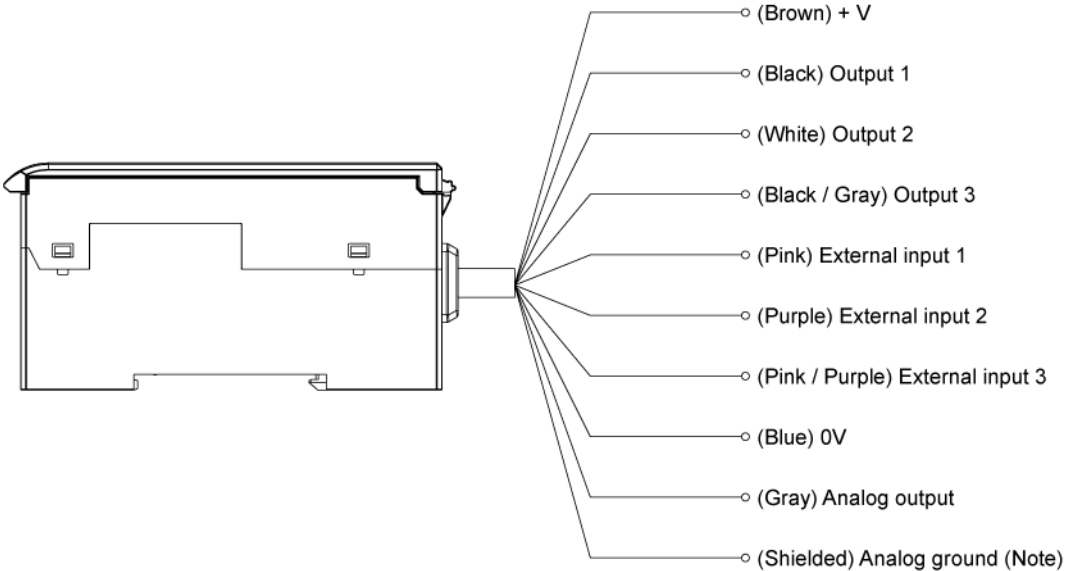

(Note 1) Use a shielded cable to extend the analog output line.

**HG-TC111, HG-TC111-P / Slave unit**

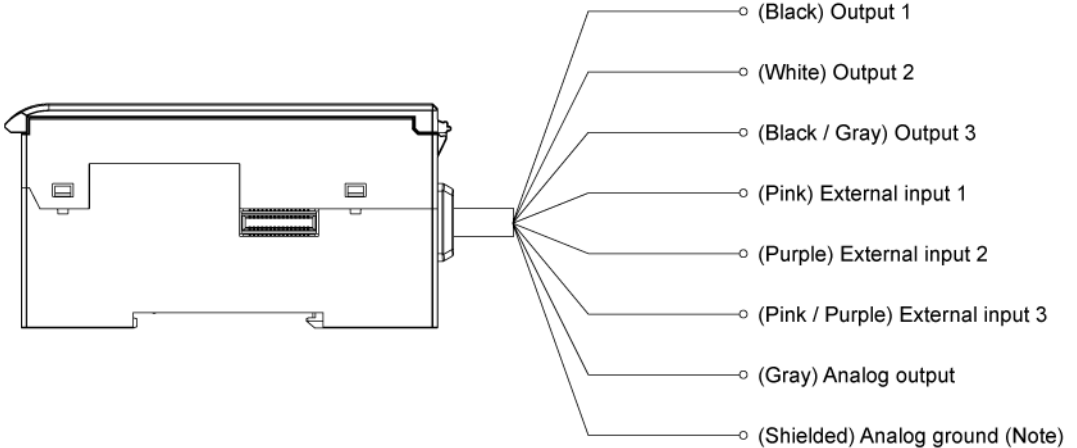

(Note 1) Use a shielded cable to extend the analog output line.

**Note**

- The **HG-TC111** and **HG-TC111-P** cables do not have +V or 0V. Power is supplied from the connector of the master unit.
- The **HG-TC113** does not have +V, 0V, or any I/O. The connector on the slave unit is used to connect to the master unit.

## 4.2 Attaching the Sensor Head

### 4.2 Attaching the Sensor Head

- The light emitting and receiving surfaces of the sensor head must be free of water, oil, fingerprints, and other substances that refract light as well as dust, grit, and other objects that intercept light.



If stains or dirt become attached to the sensor head surfaces, wipe them with a lint-free soft cloth or lens cleaning paper. If the surfaces are very dirty, wipe off dirt using a cotton swab (or similar material) moistened with absolute alcohol.

- A serial number is marked on each opposite surface of the light emitting and receiving surfaces of the sensor head.

Use a pair of emitter and receiver that have the same serial number.

Use M3 screws (to be prepared by the customer) to mount the sensor head.

Tighten the screws to a torque of 0.5 N·m.

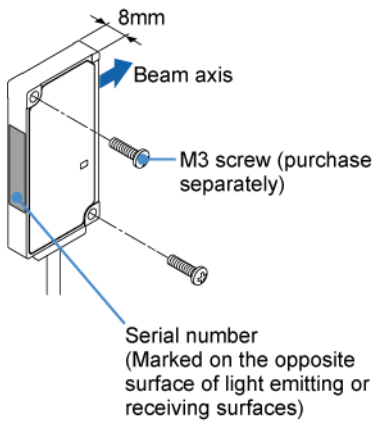

#### ■ Mounting hole dimensions

##### HG-T1010

##### Emitter

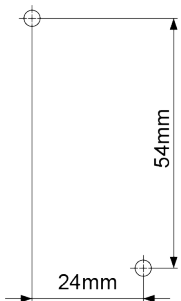

##### Receiver

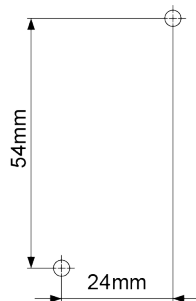

The mounting holes on the emitter and receiver are bilaterally symmetrical.

##### HG-T1110

##### Emitter

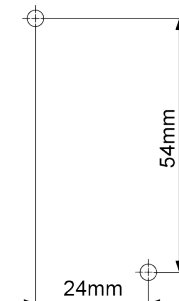

##### Receiver

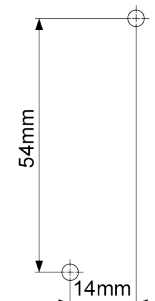

The mounting holes on the emitter and receiver are bilaterally asymmetrical.

### 4.3 Connecting the Sensor Head Connection Cable

Connect the controller and the sensor head using the **CN-HT-C** sensor head connection cable.

#### 4.3.1 Connecting to the Sensor Head



- If the sensor head connection cable is connected to the controller, always turn off the controller power before inserting or removing the connectors.
- Always grasp the connector body when connecting or disconnecting the connector. Wires may break if excessive stress is applied to the cable.
- After inserting the connectors, verify that both are attached firmly. If loose, a connector may fall out and cause an error.



- The sensor head connection cable branches into two cables. The cables are identical and can be connected to either the emitter or receiver.

1 2

#### Procedure

1. Insert the sensor head connecting cable to the sensor head connection cable connector of the sensor head with the mark aligned.

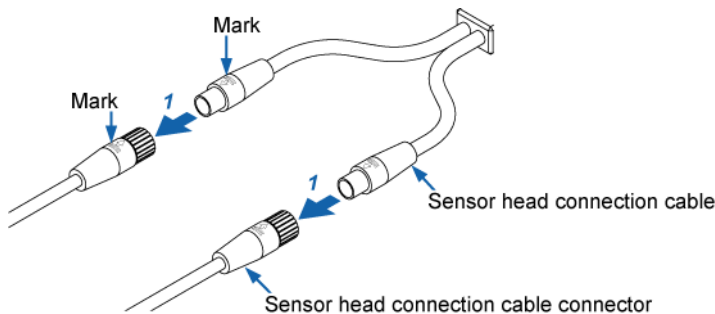

2. Turn the fastening ring on the sensor head connector in the direction of the arrow to fasten the ring firmly.

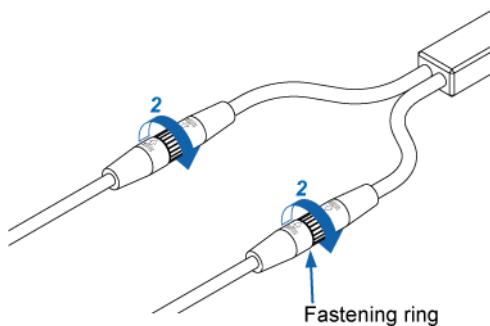

## 4.3 Connecting the Sensor Head Connection Cable

### 4.3.2 Disconnecting from the Sensor Head

#### 1 2 Procedure

1. Turn the fastening ring on the sensor head connector in the direction of the arrow to loosen the ring.

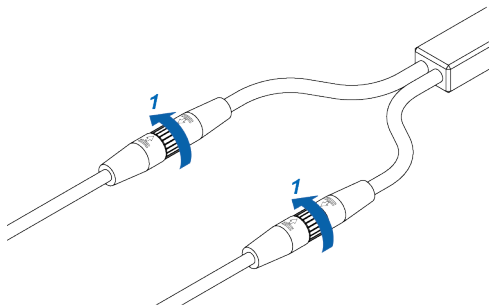

2. Grasp each connector on the sensor head connection cable and pull out to remove.

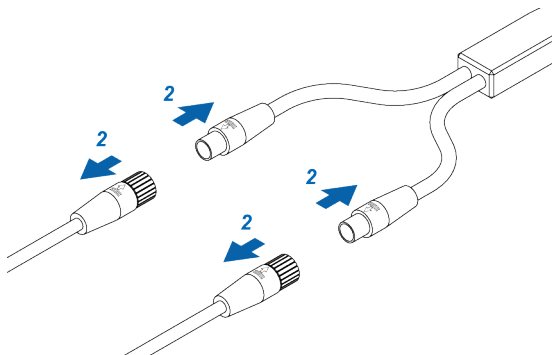

- When disconnecting, always make sure that the fastening ring has been completely loosened before pulling out the cable. Risk of damage if you pull the cable with excessive force (15 N or more) with the fastening ring tightened.

## 4.3 Connecting the Sensor Head Connection Cable

### 4.3.3 Connecting to the Controller

Insert the controller connector on the sensor head connection cable into the connector for the sensor head connection cable on the controller.

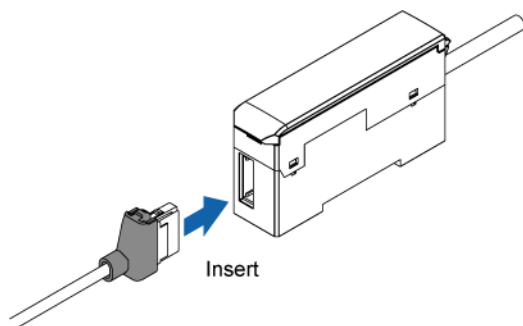

- Insert the connector firmly. Risk of sensor head or controller damage if not completely connected.

### 4.3.4 Disconnecting from the Controller

Grasp the controller, and while pressing on the lock release lever on the controller connector of the sensor head connection cable, pull the lever toward you to disconnect the cable.

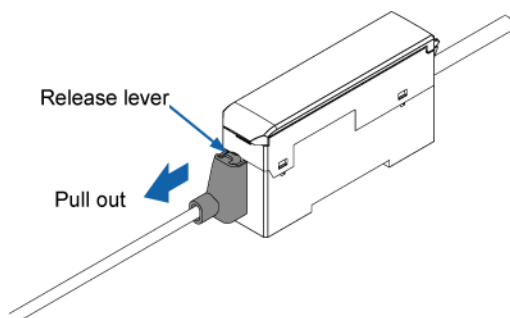

- If you attempt to disconnect the cable by pulling it without pressing the lock release lever, cable wire breakage and connector damage may occur.

### 4.3.5 Connecting and Disconnecting to / from Controller Connector

The cable on the controller connector side can be shortened.

Use the following procedures to disconnect and connect the cable from / to the controller connector.

## 4.3 Connecting the Sensor Head Connection Cable

### Disconnection procedure

#### 1 2 Procedure

1. Slide the protective cover in the direction of the arrow.

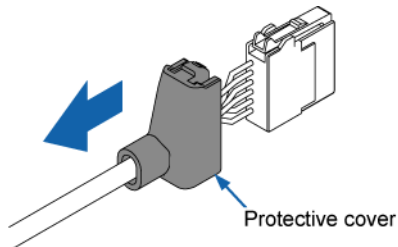

2. Press down on the wire insertion hole lever (white) with a flathead screwdriver (tip width 2 mm or less), and disconnect each wire.

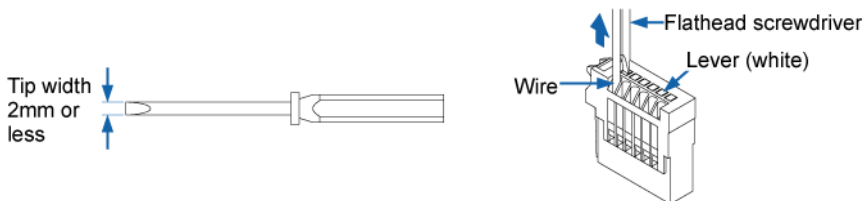

### Connection procedure

#### 1 2 Procedure

1. Align the tip of the wire with the "STRIP GAUGE" mark on the side of the connector, strip the cable so that the core wire length is 7 to 8 mm, and twist the core wires several times.

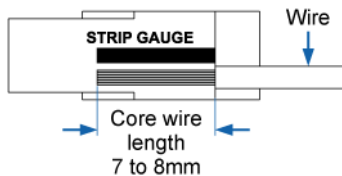

2. Using a flathead screwdriver with a tip width of 2 mm or less, press down the lever (white) on the operation unit until the lever locks.

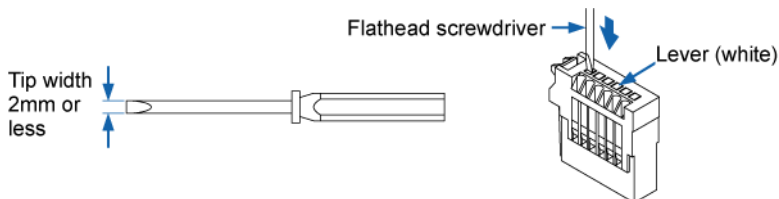

## 4.3 Connecting the Sensor Head Connection Cable

3. Insert the wire all the way into the wire insertion hole. Make sure that the jacketed part of the wire has entered the wire insertion hole and the tips of the core wires have passed through the connection part as shown below.

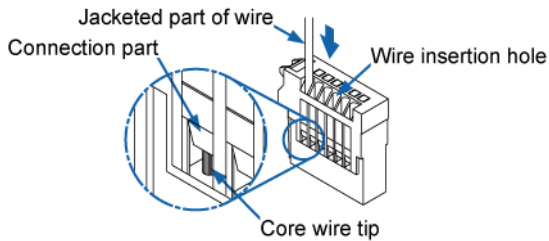

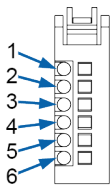
	Terminal No.	Connection cable
	1	Blue
	2	White
	3	Red
	4	Black
	5	Brown
	6	Yellow + Shields (x2)

4. Insert the tip of the flathead screwdriver into the release hole so that it contacts the bottom of the lever (white), and move the tip of the flathead screwdriver up. The lever (white) will make a "click" sound when it returns to its original position, and the wire will be locked.

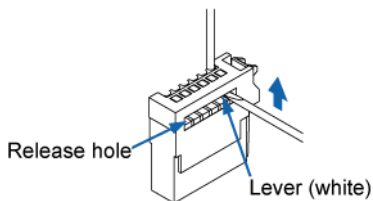

5. Pull on the wire gently to ensure that it does not come out.

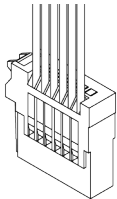

6. Slide the protective cover in the direction of the arrow to return the cover to its original position.

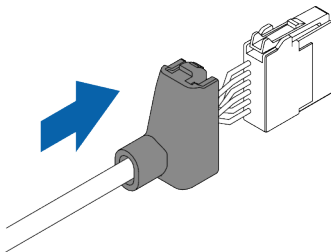

## 4.4 Connecting Controllers

---

### 4.4 Connecting Controllers

- Always shut OFF the power before connecting a slave unit to or disconnecting a slave unit from the master unit.

There is a risk of controller damage if you attempt connection or removal with the power ON.



- Insert the male connector firmly into the female connector. Risk of controller damage if not completely connected.
- When connecting slave units to a master unit, connect only NPN output types, or only PNP output types. Dissimilar output types cannot be connected together.
- An **HG-SC** series controller manufactured in January 2019 or earlier cannot be used together with an **HG-TC** series controller. To use these controllers together, use an **HG-SC** series controller manufactured in February 2019 or later.



- To connect units, the units must be mounted on a DIN rail. Attach end plates **MS-DIN-E** (optional) so as to enclose the connected units at the ends.



### Note

- Up to 15 slave units can be connected to a master unit. (Up to 14 slave units can be connected if a communication unit is connected.)
- If **HG-TC** series and **HG-SC** series controllers are used in combination, connect slave units of the same series (as the master unit) on the near side of the master unit and slave units of different series (from the master unit) on the far side of the master unit.

#### Example: When HG-TC□ is master unit

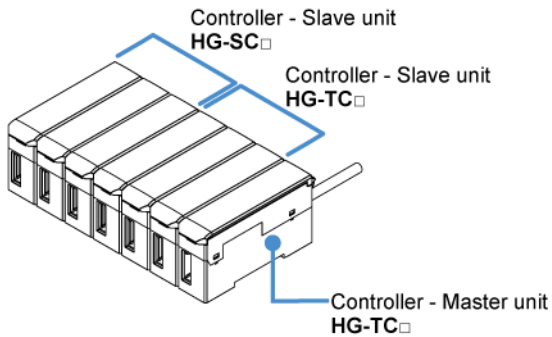

- If **HG-TC** series and **HG-SC** series controllers are used in combination, there are limitations on the functions below.

	Item	Description of limitation
1	Calculation function	Calculation is only performed when the slave unit is the same series as the master unit. Calculation is not performed when the slave unit series is different from the master unit series. "CALC" does not appear in the display of a slave unit of a different series.
2	Input all	The master unit only performs input all when the slave units are the same series. A slave unit of a different series from the master unit does not perform input even when the external input settings match those of the master unit.
3	Copy function	Copying is only performed when the slave unit is the same series as the master unit. When copying is executed, "NOW COPY" appears even on the display of a slave unit of a different series from the master unit, but copying is not performed.

### 4.4.1 How to Connect

For details on how to mount a controller, refer to "4.1 Mounting the Controller".

#### 1 2 Procedure

1. Mount a master unit on a DIN rail.

## 4.4 Connecting Controllers

---

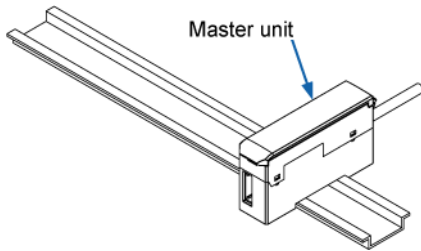

2. Remove the connector cover.

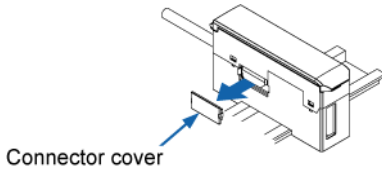

3. Mount each slave unit one at a time on the DIN rail. Remove all connector covers except for the cover on the end slave unit.

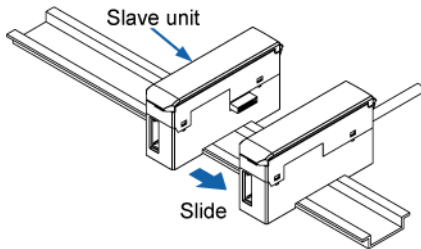

4. Slide each slave unit and connect the female and male connectors.

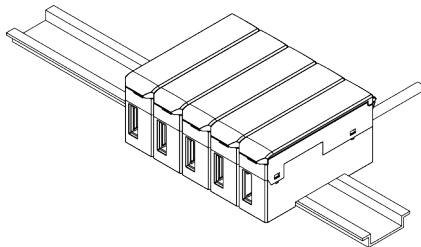

5. Attach end plates **MS-DIN-E** (optional) with the flat side facing in so as to enclose the connected units at the ends.

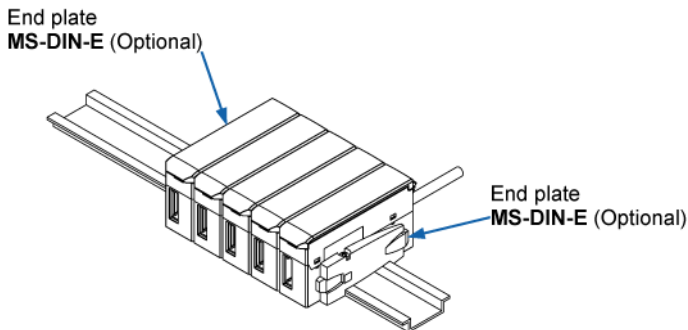

6. Tighten the screws to fasten the end plates.  
Tighten the screws to a torque of 0.3 N·m or less.



- Take care that this product might become damaged if the screws are tightened to a torque exceeding 0.3 N·m.

### 4.4.2 How to Remove

#### 1 2 Procedure

1. Loosen the screws on the end plates.
2. Remove the end plates.
3. Slide and remove the controllers, one at a time.

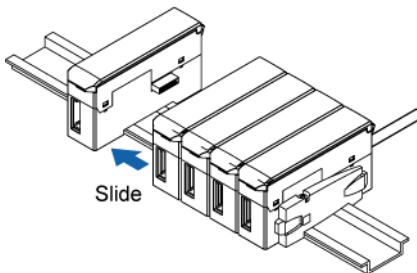

## 4.5 Mounting the Side View Attachment

### 4.5 Mounting the Side View Attachment



- Take care that the beam axis can be adjusted after a side view attachment is mounted on the emitter.
- After mounting a side view attachment on the sensor head, check whether the beam axis is aligned. After checking the beam axis, always register the reference waveform and check operations.

Mounting side view attachment **HG-TSV10** on sensor head **HG-T1010** makes various installations possible. (Note 1)

When mounting a side view attachment on the sensor head, use the M2 screws with a washer (length: 4 mm) provided.

Tighten the screws to a torque of 0.088 N·m or less.

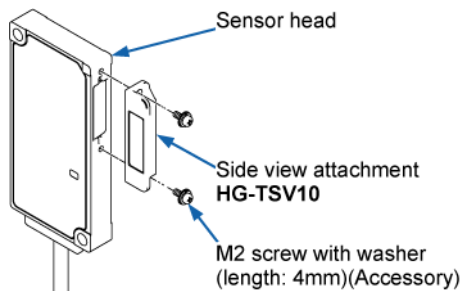

#### Example of HG-TSV10 mounted on both sides (Note 2)

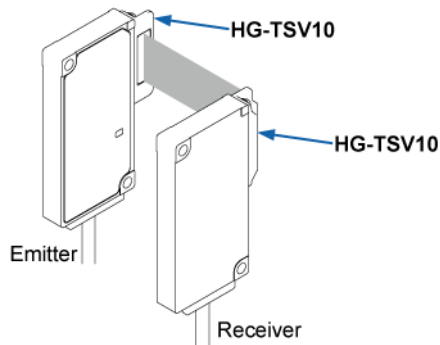

Notes 1): Side view attachments cannot be mounted on sensor head **HG-T1110** (measurement width 10 mm, slim type).

2): **HG-TSV10** is sold by one unit. Two pieces of attachment are required when using the attachment on both emitter and receiver.

#### ■ Specifications

Model No.	HG-TSV10
Combined sensor head	HG-T1010 <sup>(Note 1)</sup>
Installation distance	0 mm to 100 mm (typical)
Linearity <sup>(Note 2)</sup>	±56μm (typical)
Material	Main unit: LCP, optical surface: glass

## 4.5 Mounting the Side View Attachment

---

<b>Model No.</b>	<b>HG-TSV10</b>
Accessory	Set screw (M2 screw with washer, length: 4 mm): 2 pcs.
Weight	Approx. 2 g

(Note 1) Cannot be attached to the sensor head HG-T1110 (measurement width:10mm / slim type).

(Note 2) Measured at an installation distance of 100mm.

(MEMO)

# 5 Basic Usage

---

5.1 Using the Base Screen .....	5-2
5.1.1 Functions of Operation Pad and Display Unit .....	5-2
5.2 Flow of Operations up to Measurement Startup .....	5-6
5.3 Explanation of Basic Operation.....	5-8
5.3.1 Checking the Beam Axis .....	5-8
5.3.2 Adjusting the Beam Axis .....	5-9
5.3.3 Reference Waveform Registration .....	5-15
5.3.4 Teaching.....	5-16
5.4 Operation Mode .....	5-22
5.4.1 Auto Edge Detection Mode (ATE DGE) .....	5-22
5.4.2 Edge Detection Mode (EDGE).....	5-23
5.4.3 Outer diameter/Width Detection Mode (OUTWD) .....	5-24
5.4.4 Inner Diameter/Gap Detection Mode (INGAP) .....	5-25
5.4.5 Central Position Detection Mode (CENTPOS).....	5-25
5.4.6 User-specified Edge Detection Mode (USER DGE).....	5-28
5.5 Settings on the Base Screen (Using Shortcut Keys) .....	5-31
5.5.1 Display Switching Mode .....	5-31
5.5.2 Preset.....	5-34
5.5.3 Saving and Loading Settings to / from Banks .....	5-36
5.5.4 Key Lock .....	5-39
5.5.5 Sensitivity Settings .....	5-40
5.6 Self-monitoring Function .....	5-47
5.6.1 Using the Self-monitoring Function .....	5-47
5.6.2 Statuses and Measures .....	5-48

## 5.1 Using the Base Screen

### 5.1 Using the Base Screen

#### 5.1.1 Functions of Operation Pad and Display Unit

##### ■ Functions of the operation pad

##### Controller

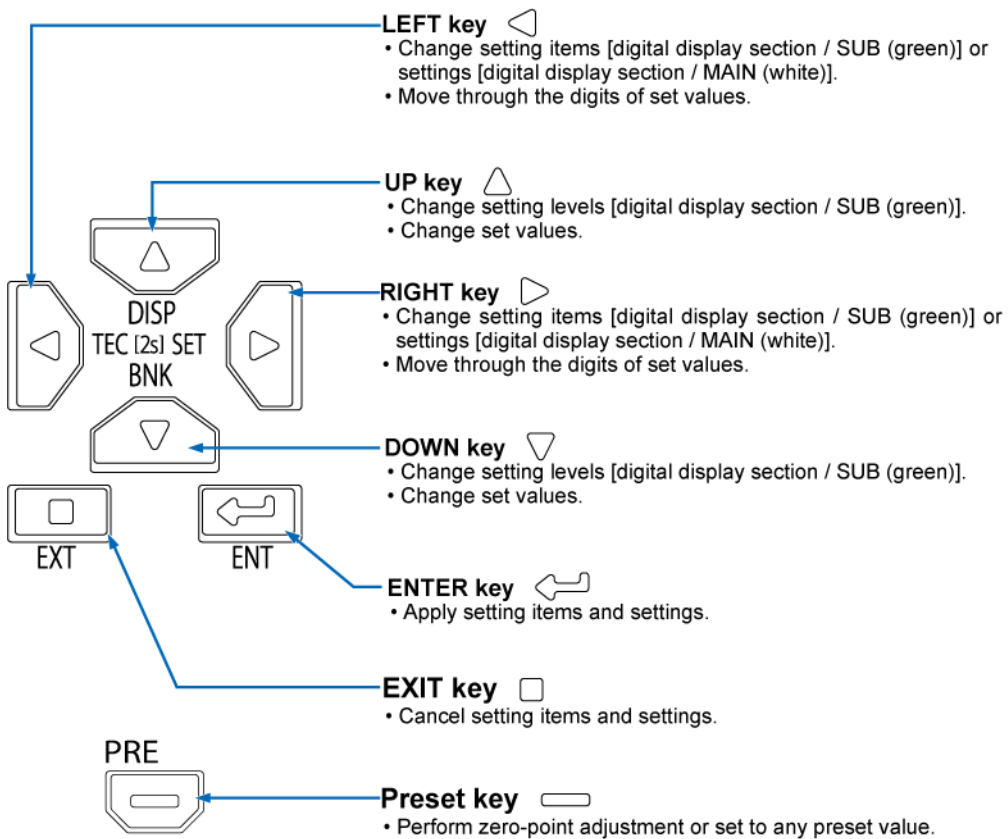
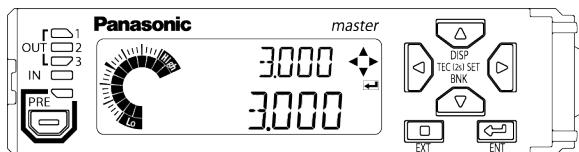





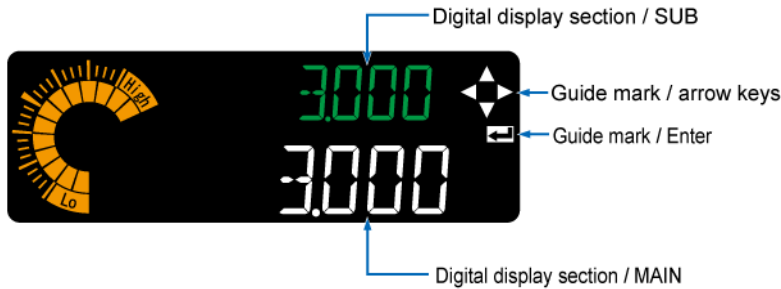

■ Functions of display unit

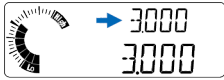

 (White)
Guide mark / arrow keys
<b>During measurement</b> Unlit as the keys are disabled.
<b>During setting</b> Only enabled arrow keys are lit.

 (White)
Guide mark / Enter
<b>During measurement</b> Unlit as the key is disabled.
<b>During setting</b> Lit when the Enter key must be pressed.

 (Green)
Digital display section / SUB
<b>During measurement</b> Shows the measured value.
<b>Example: Base screen</b>

<b>During setting</b> Shows the selected setting item.
<b>Example: Screen when HIGH set value is set</b>

 (White)
Digital display section / MAIN
<b>During measurement</b> Shows the judgment value that was used for judgment.

## 5.1 Using the Base Screen

3000(White)

### Example: Base screen



#### During setting

Shows the set value of the selected setting item.

### Example: Screen when HIGH set value is set



(Green / Orange)

Circle meter

#### During measurement

Shows position information about the measured object by incrementing or decrementing the meter count.

### Example: When the measured value is below LOW set value (Orange)

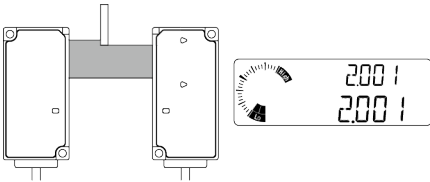

### Example: When the measured value is GO (Green)

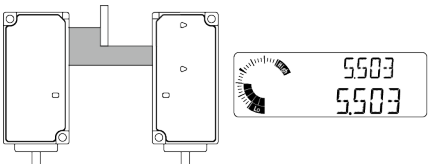

### Example: When the measured value is above HIGH set value (Orange)

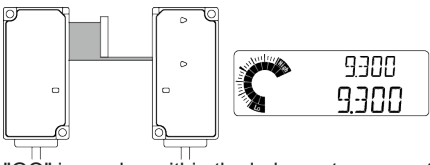

"GO" is a value within the judgment range set with the HIGH set value and LOW set value.

#### During setting

- Shows setting item positioner navigation (blinking).



(Green / Orange)

**Example: Setup menu screen**



- Shows the count when an operation key is held down.

**Example: Display switching mode screen**



**Note**

- When there is no measured object between the emitter and receiver during measurement mode, the display of the controller display unit is as shown below.

**State of sensor head**

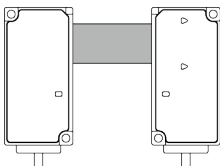

**State of controller display unit**

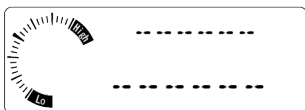

The state in which this screen is displayed is called "indeterminate state".

## 5.2 Flow of Operations up to Measurement Startup

---

### 5.2 Flow of Operations up to Measurement Startup

This section explains the flow of operations up to measurement startup by using auto edge detection mode as an example.

#### 1. Before power ON

Check package contents and confirm that all parts are complete.



#### 2. Installation

Install the controller and sensor head and connect the cables according to the installation and connection methods.

"4.1 Mounting the Controller"

"4.2 Attaching the Sensor Head"

"4.3 Connecting the Sensor Head Connection Cable"



#### 3. Power ON

Turn on the power supply and confirm that the controller display unit displays a message and laser beams are output from the sensor head (emitter).



#### 4. Checking the beam axis

Check whether the beam axis of the sensor head is aligned.

"5.3.1 Checking the Beam Axis"



#### 5. Adjust the beam axis if the beam axis is not aligned.

Readjust the beam axis according to the beam axis adjustment method.

"5.3.2 Adjusting the Beam Axis"



#### 6. Registering the reference waveform

Register the reference waveform according to the reference waveform registration method.

"5.3.3 Reference Waveform Registration"



#### 7. Setting up the functions

Perform operation mode settings, teaching settings, output settings, and output operation settings in this order to complete basic operation settings.

**7-1** Select and set operation mode "Auto edge detection mode". (Default)

"6.3.1 Operation Mode (OPMODE)"

## 5.2 Flow of Operations up to Measurement Startup

---

**7-2** Perform teaching "1-point teaching" (default) to set the GO range.  
"5.3.4 Teaching"

**7-3** Select and set output setting "3-value output". (Default)  
"7.2.4 External Outputs (EXTERNAL)"

**7-4** Select and set output operation setting "N.O. (Normally Open)". (Default)  
"6.4.10 Output Operation (OUTPUT)"



**8.** Start measurement

Measurement is started. Check the value measured by the controller and the judgment value.  
"5.1.1 Functions of Operation Pad and Display Unit"



**9.** Fine adjustment

To change the GO range, change the HIGH set value and LOW set value to any desired values.  
"6.4.1 HIGH Set Value (H.SET)"  
"6.4.2 LOW Set Value (L.SET)"

## 5.3 Explanation of Basic Operation



### 5.3 Explanation of Basic Operation

#### 5.3.1 Checking the Beam Axis

Check the beam axis to see if the emitter and receiver of the sensor head are installed correctly. For the controller, you can check the beam axis using the digital display section / MAIN (white), digital display section / SUB (green), and circle meter (orange or green).

For the sensor head, you can check the beam axis using the beam axis adjustment indicator / TOP part and beam axis adjustment indicator / BOTTOM part for the receiver. (Except for HG-T1110)

#### ■ How to display the screen for checking the beam axis (Beam axis adjustment mode)

Hold down the  key and  key simultaneously on the operation unit of the controller for two seconds.

#### ■ To check the beam axis using the controller

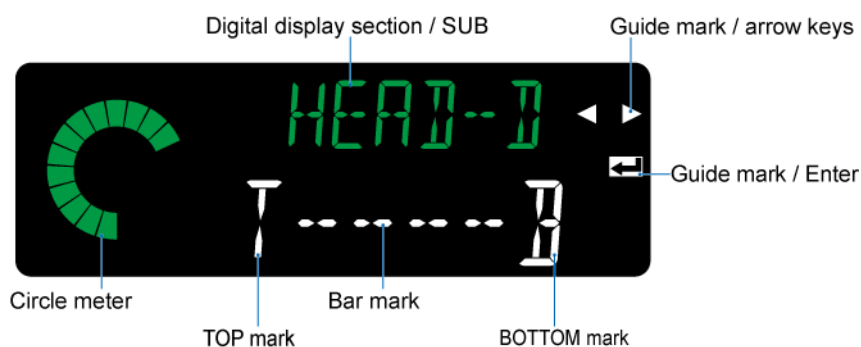

If the beam axis is aligned, all LED segments of the circle meter on the left side of the display unit light up in green.

At the same time, the bar mark in the middle of the display section / MAIN lights up in white. The guide mark / Enter on the right side of the display section also lights up in white.

#### ■ To check the beam axis using the sensor head (Except for HG-T1110)

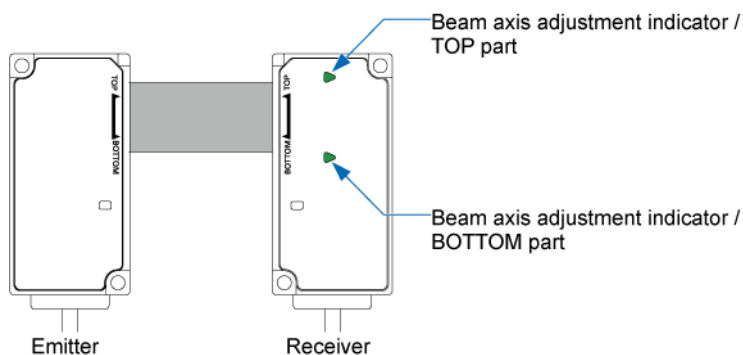

If the beam axis is aligned, both the beam axis adjustment indicator / TOP and beam axis adjustment indicator / BOTTOM on the sensor head receiver will light up in green.

Notes 1): The beam axis adjustment indicator on the sensor head receiver does not light up during measurement mode.

2): The **HG-T1110** is not equipped with beam axis adjustment indicators. Therefore, when the **HG-T1110** is used, the beam axis cannot be checked using the sensor head.

### Note

- If the beam axis of the sensor head is misaligned, refer to "5.3.2 Adjusting the Beam Axis" and adjust the beam axis.

If you confirm that the beam axis has been aligned, proceed to "Reference Waveform Registration".

### ■ How to return to measurement mode

You can return to measurement mode by pressing the  key on the operation unit of the controller.

## 5.3.2 Adjusting the Beam Axis

Invoke beam axis adjustment mode and check the state of the beam axis by using the display unit of the controller or the beam axis adjustment indicators on the sensor head receiver (except for **HG-T1110**).

### ■ Checking the beam axis on the display unit of the controller

**Example: The emitter is too low with respect to the receiver.**

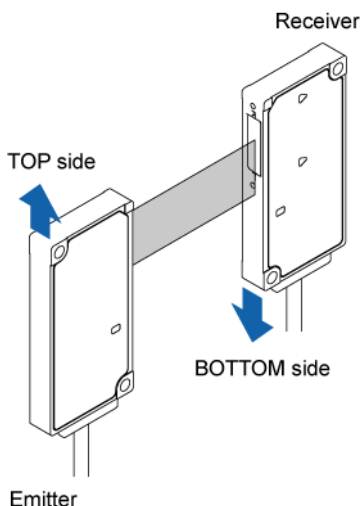

First, when adjusting the beam axis, select whether adjustment will be performed by moving the emitter or the receiver with the  /  key of the controller.

When "HEAD-E" (emitter base) is selected	When "HEAD-D" (receiver base) is selected
An arrow is displayed from "B" to "T". Move the emitter to the TOP side and adjust it.	An arrow is displayed from "T" to "B". Move the emitter to the BOTTOM side and adjust it.

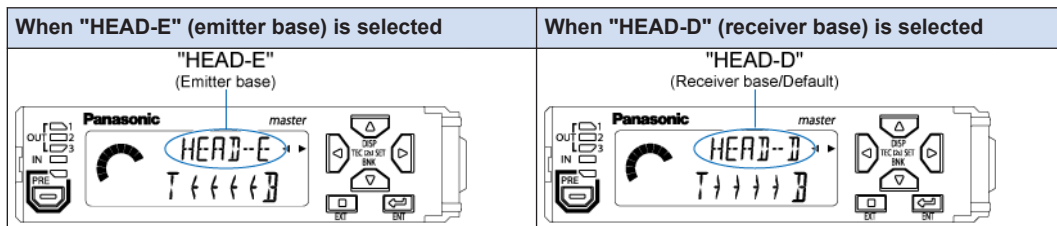

## 5.3 Explanation of Basic Operation



Depending on the state of the beam axis, the display unit of the controller changes the displays as shown below. Check the circle meter and bar mark.

Display unit of controller (when receiver base is set)			State of beam axis
State of circle meter (Orange)	State of bar mark (White)	State of guide mark / Enter (White)	
	T → → → → → D (Note 1)	Unlit	<ul style="list-style-type: none"> <li>The light-receiving side has shifted toward the TOP side (the light-emitting side has shifted toward the BOTTOM side).</li> </ul>
	T ← ← ← ← ← D (Note 1)	Unlit	<ul style="list-style-type: none"> <li>The light-receiving side has shifted toward the BOTTOM side (the light-emitting side has shifted toward the TOP side).</li> </ul>
All segments unlit	T - - - - - D	Unlit	<ul style="list-style-type: none"> <li>The beam axis is completely out of alignment.</li> <li>Laser emission stop input turns ON during beam axis adjustment.</li> <li>The measured object intercepts the entire beam axis.</li> </ul>
	T - - - - - D	Unlit	<ul style="list-style-type: none"> <li>The beam axis is aligned, but the amount of entering light is too much due to the influences of ambient light, etc.</li> </ul>
	T - - - - - D	Unlit	<ul style="list-style-type: none"> <li>Light enters, but the beam axis is inclined.</li> </ul>

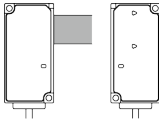

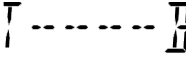
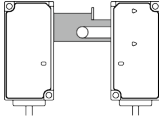
Display unit of controller (when receiver base is set)			State of beam axis
State of circle meter (Orange)	State of bar mark (White)	State of guide mark / Enter (White)	
			 <ul style="list-style-type: none"> <li>The beam axis is aligned, but the amount of entering light is too little. (The entire beam axis is covered with a transparent body.)</li> </ul>
		Unlit	 <ul style="list-style-type: none"> <li>Objects intercepting light or stains (adhering substances) exist inside the measurement area.</li> </ul>

(Note 1) If the base used for verifying beam axis adjustment is set to "HEAD-E" (emitter base), the display of the arrows will be reversed.

#### ■ Checking the beam axis using the beam axis adjustment indicators on the sensor head receiver (\* Except for HG-T1110)

Depending on the state of the beam axis of the sensor head, the displays of the beam axis adjustment indicators (TOP and BOTTOM parts) on the sensor head receiver change as shown below.

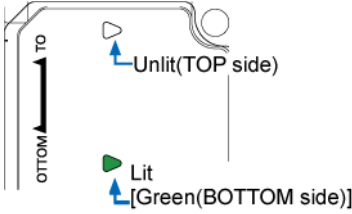
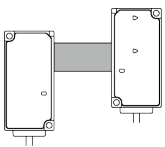
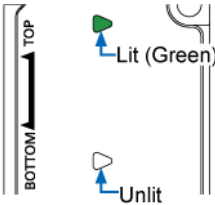
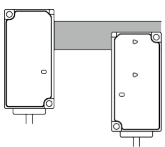
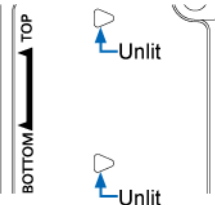
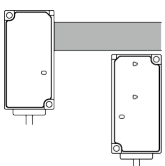

State of beam axis adjustment indicator (TOP / BOTTOM part)	State of beam axis
 <p>Unlit(TOP side) Lit [Green(BOTTOM side)]</p>	 <ul style="list-style-type: none"> <li>The light-receiving side has shifted toward the TOP side (the light-emitting side has shifted toward the BOTTOM side).</li> </ul>
 <p>Lit (Green) Unlit</p>	 <ul style="list-style-type: none"> <li>The light-receiving side has shifted toward the BOTTOM side (the light-emitting side has shifted toward the TOP side).</li> </ul>
 <p>Unlit Unlit</p>	 <ul style="list-style-type: none"> <li>The beam axis is completely out of alignment.</li> <li>Laser emission stop input turns ON during beam axis adjustment.</li> <li>The measured object intercepts the entire beam axis.</li> </ul>

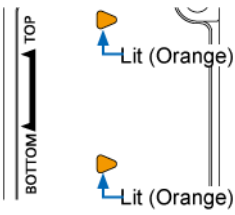
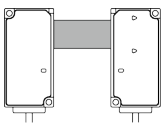
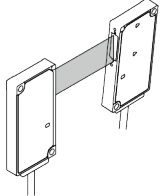
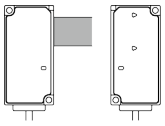
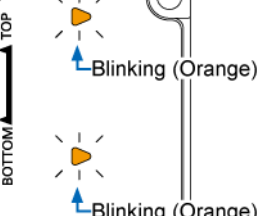
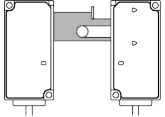
## 5.3 Explanation of Basic Operation



State of beam axis adjustment indicator (TOP / BOTTOM part)	State of beam axis
 <p>Lit (Orange)</p> <p>Lit (Orange)</p>	 <ul style="list-style-type: none"> <li>The beam axis is aligned, but the amount of entering light is too much due to the influences of ambient light, etc.</li> </ul>
	 <ul style="list-style-type: none"> <li>Light enters, but the beam axis is inclined.</li> </ul>
	 <ul style="list-style-type: none"> <li>The beam axis is aligned, but the amount of entering light is too little. (The entire beam axis is covered with a transparent body.)</li> </ul>
 <p>Blinking (Orange)</p> <p>Blinking (Orange)</p>	 <ul style="list-style-type: none"> <li>Objects intercepting light or stains (adhering substances) exist inside the measurement area.</li> </ul>

12

### Procedure

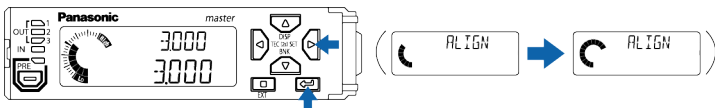
- Holding down the  key and  key for two seconds invokes beam axis adjustment mode. (The number of lit increments in the circle meter increases while the keys are held down.)



- Press the  or  key to select either receiver base or emitter base for beam axis adjustment. The sensor head that you move during beam axis adjustment should be selected as the base.

The following figure shows the situation where receiver base is selected

- "HEAD-D": Receiver base (Default)
- "HEAD-E": Emitter base

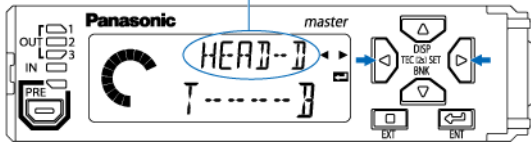

The beam axis adjustment method is explained below, using an example where the base of beam axis adjustment is set to "HEAD-D" (receiver base).

3. Check whether the beam axis of the sensor head is aligned, using the display unit of the controller or the beam axis adjustment indicators (TOP and BOTTOM parts) on the sensor head receiver.

#### Controller display unit

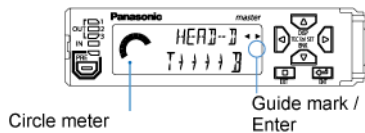

#### Sensor head

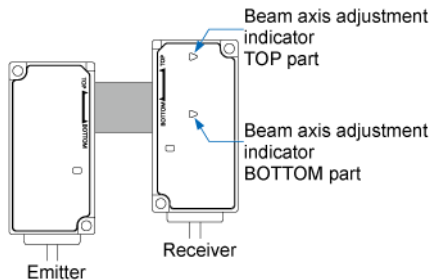

#### Note

- For the display of the display unit of the controller, refer to "[Checking the beam axis on the display unit of the controller](#)". For the display of the beam axis adjustment indicators on the sensor head receiver, refer to "[Checking the beam axis using the beam axis adjustment indicators on the sensor head receiver \(\\* Except for HG-T1110\)](#)".

4. Move the receiver of the sensor head vertically and laterally while checking the display unit of the controller.

For the HG-T1010, you can check the beam axis using the beam axis adjustment indicators on the sensor head receiver.

## 5.3 Explanation of Basic Operation

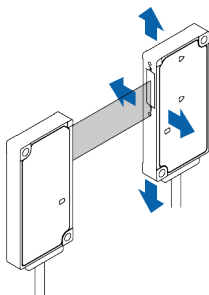

When the controller display unit displays the message shown in the following figure, move the receiver downward (toward BOTTOM).



5. If the beam axis of the sensor head is aligned, all LED segments of the circle meter on the display unit of the controller will light up in green and the guide mark / Enter will light up in white.



Circle meter  
All segments  
light up (Green)

Enter mark  
Lights up (White)

### Sensor head

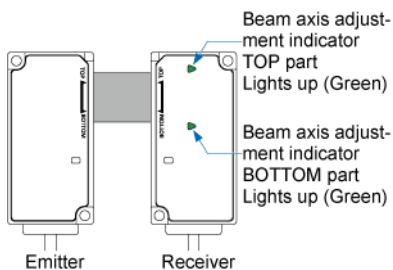

6. If you confirm that the beam axis has been aligned, proceed to ["5.3.3 Reference Waveform Registration"](#). To return to measurement mode, press the  key.

### 5.3.3 Reference Waveform Registration

By registering the reference waveform, you can register waveforms in a normal state. Registering normal waveforms helps to improve measurement accuracy and discover any abnormal changes that occur during operation.



- After installing this product, always register the reference waveform. Unless the reference waveform is registered, correct measurements cannot be made.
- Register the reference waveform when there is no measured object.
- When a measured object with a strong specular reflection component (such as glass or specular reflector) is detected, it may not be detected correctly due to the influences of light reflected from the measured object. In such a case, install a pair of emitter and receiver at a certain angle to the measured object so that reflected light does not hit the emitter or receiver. After adjusting the angle, always adjust the beam axis.

## 1 2 Procedure

1. Invoke beam axis adjustment mode and check that the beam axis is aligned, using the circle meter and guide mark / Enter on the display unit of the controller or the beam axis adjustment indicators (at TOP and BOTTOM parts) on the sensor head receiver.

#### Controller display unit

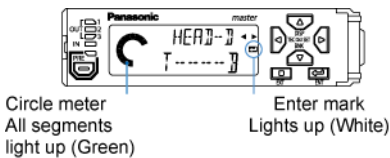

#### Sensor head

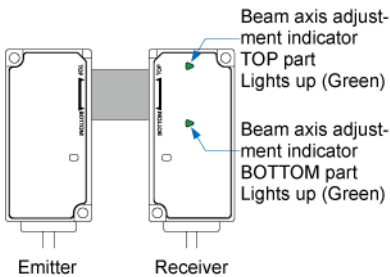

(Note 1) The **HG-T1110** is not equipped with beam axis adjustment indicators.

2. When the beam axis is aligned, pressing the  key registers the current waveform as the reference waveform. The registered reference waveform will be stored in the EEPROM of the sensor head receiver.



## 5.3 Explanation of Basic Operation

### Image of registered reference waveform

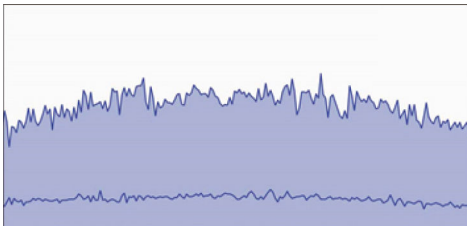

(Note 1) You can use the **HG-T Configuration Tool** software to view an image of the registered reference waveform.

### 5.3.4 Teaching

#### ■ Overview



Set the HIGH set value and LOW set value. The range between the LOW set value and the HIGH set value is set as GO range. Values within GO range are judged to be "GO", and values outside GO range are judged to be out-of-range (on LOW or HIGH side).

Term	Description
GO	Refers to the judgment range between the HIGH set value and LOW set value.

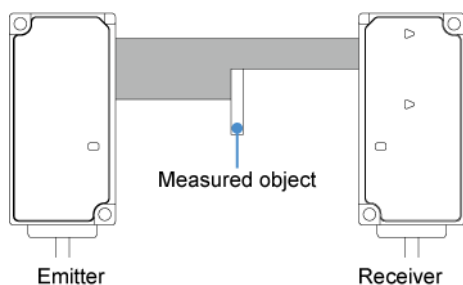
#### ■ Settings



Teaching type	Setting method
1-point teaching (Default)	<p>You can use a master workpiece to set upper and lower limit values. Use this method when you want to set judgment values for the workpiece as <math>\pm</math> tolerance.</p> <p style="text-align: center;"> <math>+0.100</math>              Upper limit value              Tolerance              Judgment value              Tolerance              Lower limit value  <math>-0.100</math> </p>
2-point teaching	<p>You can use two workpieces to set upper and lower limit values. Use this method when you want to judge workpieces within an upper limit and lower limit range.</p>

Teaching type	Setting method
	 <p>Upper limit value</p> <p>Lower limit value</p>
3-point teaching	<p>You can use a good workpiece, a HIGH-side defective workpiece, and a LOW-side defective workpiece to set upper and lower limit values.</p> <p>Use this method when you want to judge workpieces within a range that takes the intermediate values between good and HIGH-side or LOW-side defective workpieces as upper and lower limits.</p>  <p>Maximum value</p> <p>Upper limit value</p> <p>Median value</p> <p>Lower limit value</p> <p>Minimum value</p>

(Note 1) Upper and lower limit values are regarded as HIGH and LOW set values, respectively.

### Note

- The default setting for the tolerance is "0.100" ( $\pm 0.100$ ).

## When 1-point teaching is selected

### 1 2 Procedure

- Hold down the  key for 2 seconds. (The number of lit increments in the circle meter increases.)



"SET1" appears in the digital display section / SUB (green), and the digital display section / MAIN (white) blinks.



- Press the  key. The position of the master workpiece will be acquired as a judgment value.

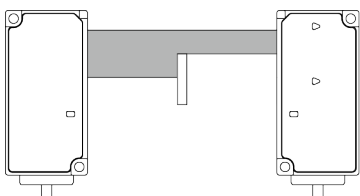

## 5.3 Explanation of Basic Operation

When teaching is completed, "GOOD" appears in the digital display section / MAIN (white), and the HIGH set value and LOW set value are applied. Then, the display will automatically return to the base screen.

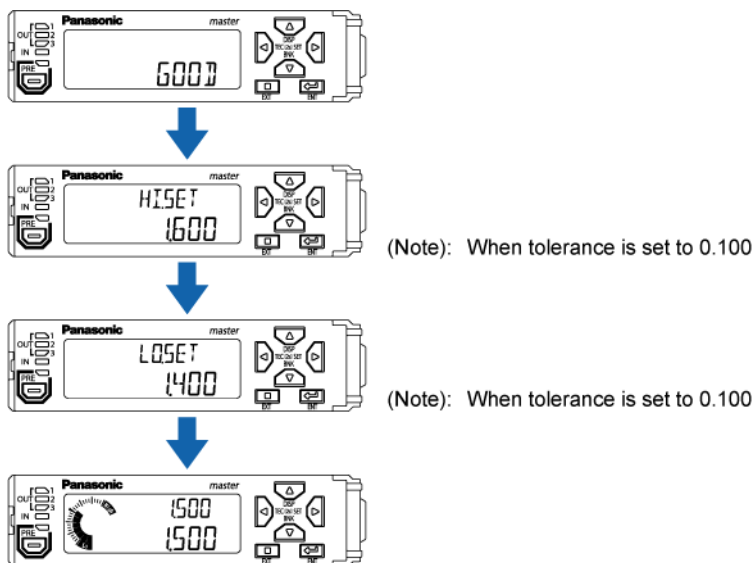

### Note

- Judgment results that appear in the display are described in the table below.

Digital display section / MAIN (White)	Description
GOOD	Stable measurement can be performed
HARD	Stable measurement cannot be performed <sup>(Note 1)</sup>
ERROR	Teaching did not take place correctly <sup>(Note 1)</sup>

(Note 1) If "HARD" or "ERROR" appears in the digital display section / MAIN, restore the controller to its normal state and then execute teaching again.

- If teaching is performed when one of the messages in the table below appears in the digital display section during measurement, teaching will not take place correctly and an error will be displayed. In this case, restore the controller to its normal state and then execute teaching.

Digital display section		Description
MAIN (White) / SUB (Green)	Display	
MAIN (white) SUB (Green)	-----	Immediately after the power is turned ON or a reset is input
MAIN (white)	OVER	When the upper or lower display limit is exceeded
MAIN (white)	ALARM	When an alarm is output
SUB (Green)	HWERR	When an error is output



## When 2-point teaching is selected

## 1 2 Procedure

1. Hold down the  key for 2 seconds. (The number of lit increments in the circle meter increases.)



2. "SET.1" appears in the digital display section / SUB (green), and the digital display section / MAIN (white) blinks.



3. Measure the first workpiece and then press  key.

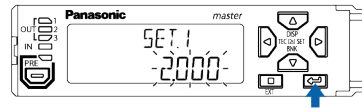
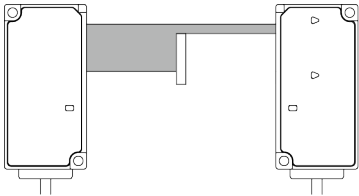

4. "SET.2" appears in the digital display section / SUB (green). Measure the second workpiece and then press  key.

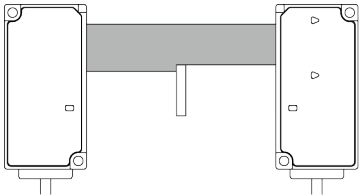

When teaching is completed, "GOOD" appears in the digital display section / MAIN (white), and the HIGH set value and LOW set value are applied. Then, the display will automatically return to the base screen.

## 5.3 Explanation of Basic Operation

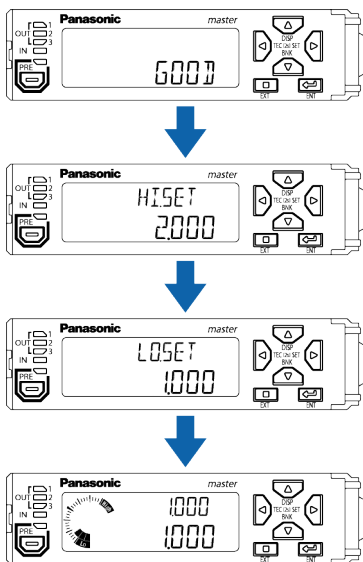

### Note

- The higher judgment value is set as the HIGH set value and the lower judgment value is set as the LOW set value, regardless of the order of "Step 3" and "Step 4".

## When 3-point teaching is selected

### 1 2 Procedure

- Hold down the key for 2 seconds. (The number of lit increments in the circle meter increases.)



- "SET.1" appears in the digital display section / SUB (green), and the digital display section / MAIN (white) blinks.



- Measure the HIGH-side defective workpiece and press the key.

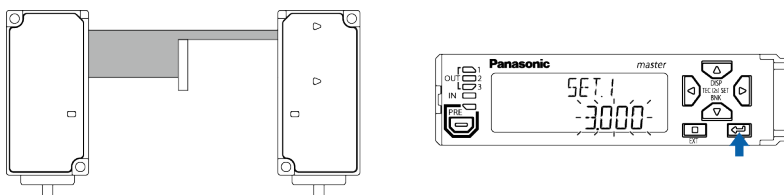

4. "SET.2" appears in the digital display section / SUB (green). Measure the good workpiece and press the  key.

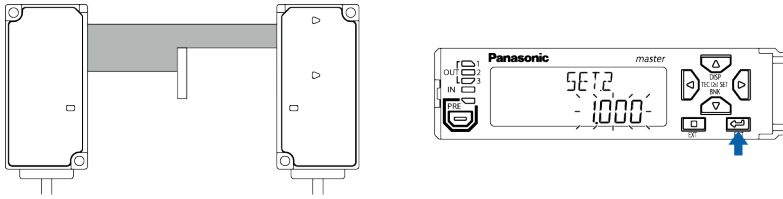

5. "SET.1" appears in the digital display section / SUB (green). Measure the LOW-side defective workpiece and press the  key.

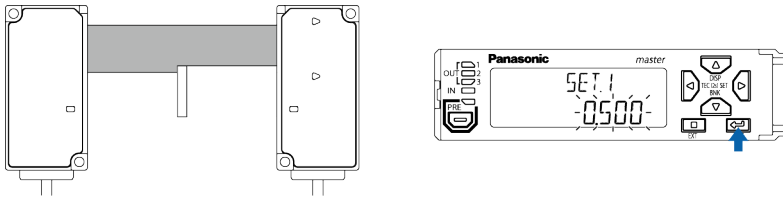

When teaching is completed, "GOOD" appears in the digital display section / MAIN (white), and the HIGH set value and LOW set value are applied. Then, the display will automatically return to the base screen.

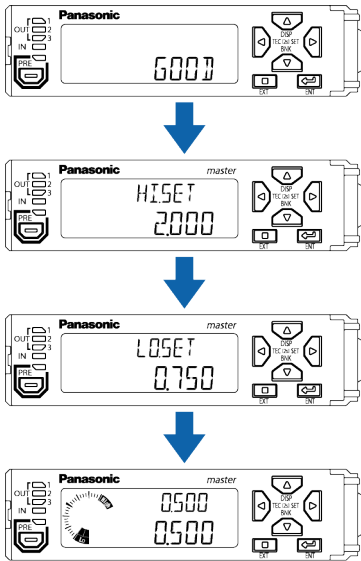

### Note

- Regardless of the order of "Step 3", "Step 4" and "Step 5", the workpiece judgment values are sorted in order from the highest to the lowest value. The intermediate value between the highest value and the median value is set as the HIGH set value, and the intermediate value between the lowest value and the median value is set as the LOW set value.

## 5.4 Operation Mode

### 5.4 Operation Mode

#### ■ Overview

You can set an operation mode according to the measurement method for the object to be measured.

- Auto edge detection mode (*ATEEDGE*)
- Edge detection mode (*EDGE*)
- Outer diameter / width detection mode (*OUTWD*)
- Inner diameter / gap detection mode (*INGAP*)
- Central position detection mode (*CENPOS*)
- User assigned edge detection mode (*USREDD*)

For the setting procedure for each operation mode, refer to "6.3.1 Operation Mode (*OPMODE*)".

#### 5.4.1 Auto Edge Detection Mode (*ATEEDGE*)

This mode automatically recognizes the direction in which the measured object enters the measurement area of the sensor head (TOP or BOTTOM side). The distance from the edge of the side where the measured object enters the measurement area to the edge of the measured object is measured.

##### When the measured object enters the measurement area from the TOP side

On the basis of the TOP side, the distance from the TOP side edge to the edge of the measured object is detected as the measured value.

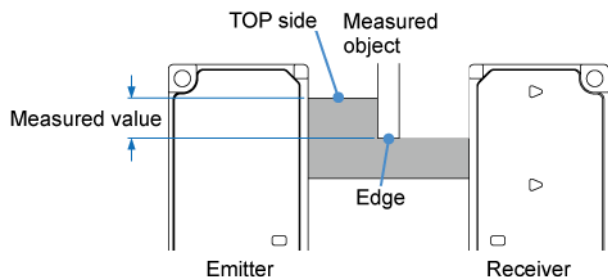

##### When the measured object enters the measurement area from the BOTTOM side

On the basis of the BOTTOM side, the distance from the BOTTOM side edge to the edge of the measured object is detected as the measured value.

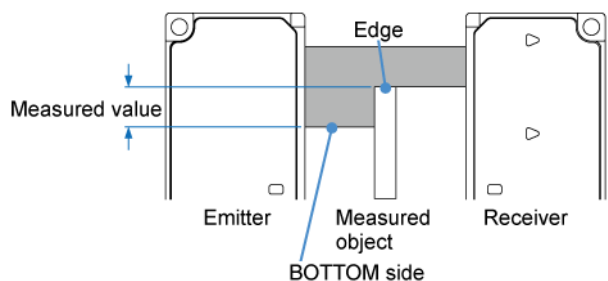

### Note

- The following states are judged to be indeterminate states and displayed as ".....".
  - Full light entry state
  - State in which more than one edge is detected (such as detection of transparent body)

If auto edge detection mode is set, the base position will be switched according to the direction (TOP or BOTTOM side) in which the measured object enters the measurement area of the sensor head, causing the HIGH and LOW set values to be switched.

### Example of switching between HIGH and LOW set values

#### When the measured object enters the measurement area from the TOP side

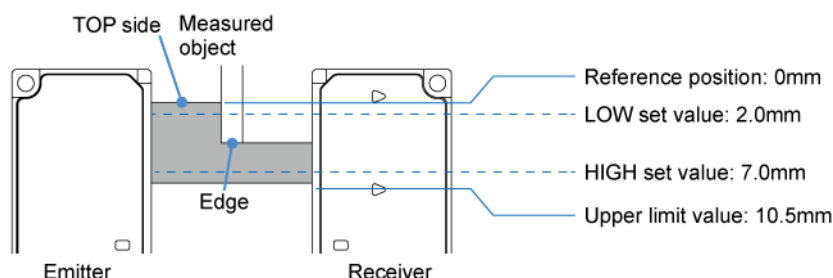

#### When the measured object enters the measurement area from the BOTTOM side

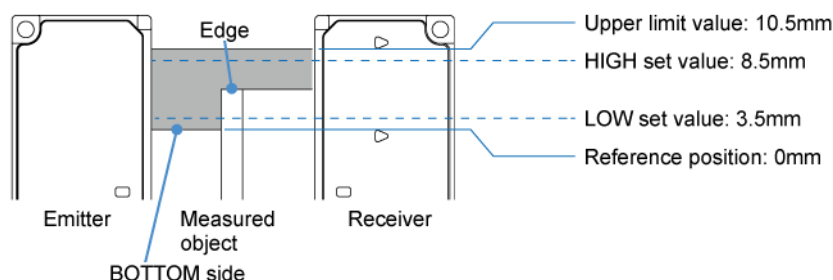

- When the measured object enters the measurement area from the TOP side, LOW set value 2.0 mm is used. When the measured object enters the measurement area from the BOTTOM side, LOW set value 2.0 mm is switched to HIGH set value 8.5 mm.
- When the measured object enters the measurement area from the BOTTOM side, HIGH set value 7.0 mm is used. When the measured object enters the measurement area from the TOP side, HIGH set value 7.0 mm is switched to LOW set value 3.5 mm.

### Note

- If auto edge detection mode is set, the upper limit for measured values is 10.5 mm.

## 5.4.2 Edge Detection Mode (EDGE)

When the direction in which the measured object enters the measurement area of the sensor head is specified as the TOP or BOTTOM side, this mode measures the distance from the TOP or BOTTOM side of the measurement area to the edge of the measured object.

## 5.4 Operation Mode

### ■ When the direction in which the measured object enters the measurement area is specified as the TOP side

On the basis of the TOP side, the distance from the TOP side edge to the edge of the measured object that is the nearest to the BOTTOM side among the sections switching from light interception to light entry is detected as the measured value.

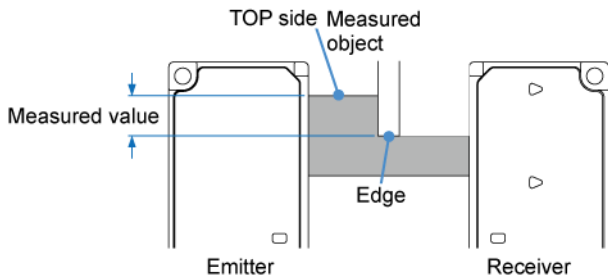

If the measured object enters the measurement area from the BOTTOM side, no measured value is detected and "10000" will be displayed.

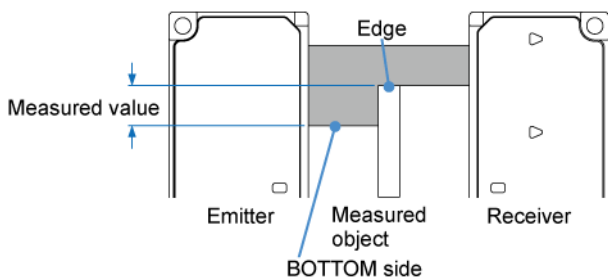

### ■ When the direction in which the measured object enters the measurement area is specified as the BOTTOM side

The measured object moves in the direction opposite to the one when the direction in which the measured object enters the measurement area is specified as the TOP side.

#### Note

- Full light entry state is displayed as "-----".
- For details on how to set the measurement direction, refer to "6.3.2 Measurement Direction (DIRECT)".

### 5.4.3 Outer diameter/Width Detection Mode (OUTWD)

This mode measures the outer diameter or width of the measured object.

On the basis of the TOP side, the distance from the edge switching from light entry to light interception that is nearer to the TOP side to the edge switching from light interception to light entry that is nearer to the BOTTOM side is detected as the measured value.

There is no need to set the measurement direction.

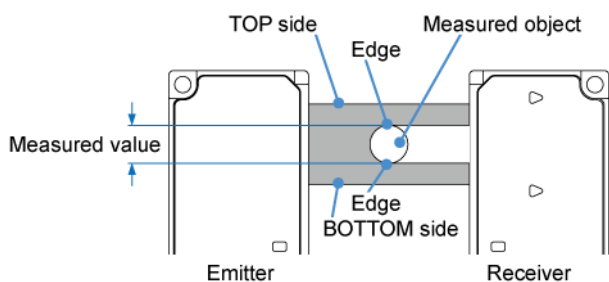

#### Note

- The following states are judged to be indeterminate states and displayed as ".....".
  - Full light interception state
  - Full light entry state

### 5.4.4 Inner Diameter/Gap Detection Mode (INGAP)

This mode measures the inner diameter or gap of the measured object.

On the basis of the TOP side, the distance from the edge switching from light interception to light entry that is nearer to the TOP side to the next edge switching from light entry to light interception is detected as the measured value.

There is no need to set the measurement direction.

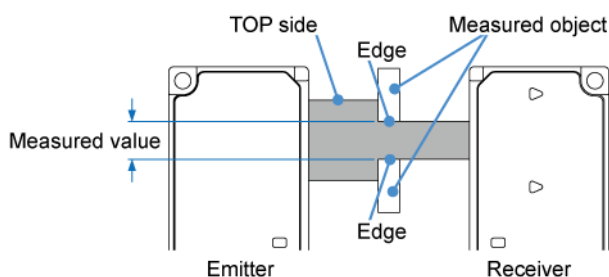

#### Note

- The following states are judged to be indeterminate states and displayed as ".....".
  - Full light interception state
  - Full light entry state

### 5.4.5 Central Position Detection Mode (CENPOS)

When an object such as a pin is measured, this mode measures the distance from either the TOP or BOTTOM side edge to the center of the measured object.

## 5.4 Operation Mode

### ■ When the measurement direction is specified as the TOP side

On the basis of the TOP side, the central value (A) between the first edge (B) switching from light entry to light interception and the last edge (C) switching from light interception to light entry is calculated.

The distance from the TOP side edge to the central value (A) is detected as the measured value.

$$A = (B + C)/2$$

B: The first edge that switches from light entry to light interception on the basis of the TOP side

C: The last edge that switches from light interception to light entry

Measured value = A - TOP side edge

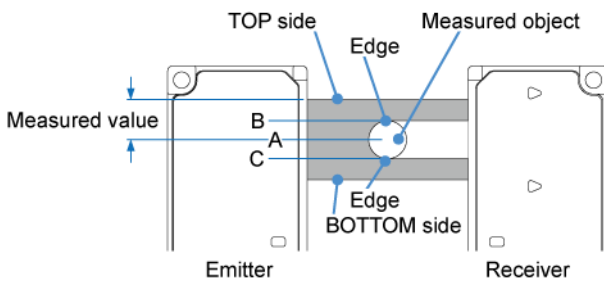

### ■ When the measurement direction is specified as the BOTTOM side

On the basis of the BOTTOM side, the central value (A) between the first edge (B) switching from light entry to light interception and the last edge (C) switching from light interception to light entry is calculated.

The distance from the BOTTOM side edge to the central value (A) is detected as the measured value.

$$A = (B+C)/2$$

B: The first edge that switches from light entry to light interception on the basis of the BOTTOM side

C: The last edge that switches from light interception to light entry

Measured value = BOTTOM side edge - A

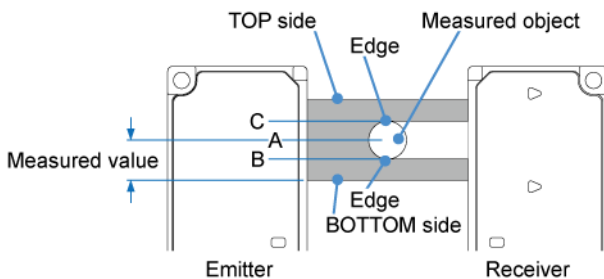



### Note

- The following states are judged to be indeterminate states and displayed as ".....".
  - Full light interception state
  - Full light entry state
- For details on how to set the measurement direction, refer to "[6.3.2 Measurement Direction \(DIRECT\)](#)".

## 5.4 Operation Mode

### 5.4.6 User-specified Edge Detection Mode (USER EDG)

When the measured object enters the detection area of the sensor head, the distance between two edges specified as desired is measured.



- Perform beam axis adjustment and reference waveform registration when there are no obstacles such as jigs.

Specified edges are specified as 1 to 10 in the order of occurrence starting from TOP.

One of specified edges can be specified as TOP or BOTTOM.

Note that Alarm 1 will be detected if 11 or more edges are recognized.

Both change from light interception to light entry and change from light entry to light interception are recognized as an edge.

#### ■ When measuring the distance between two specified edges (Example: Edge No. 1 and Edge No. 3)

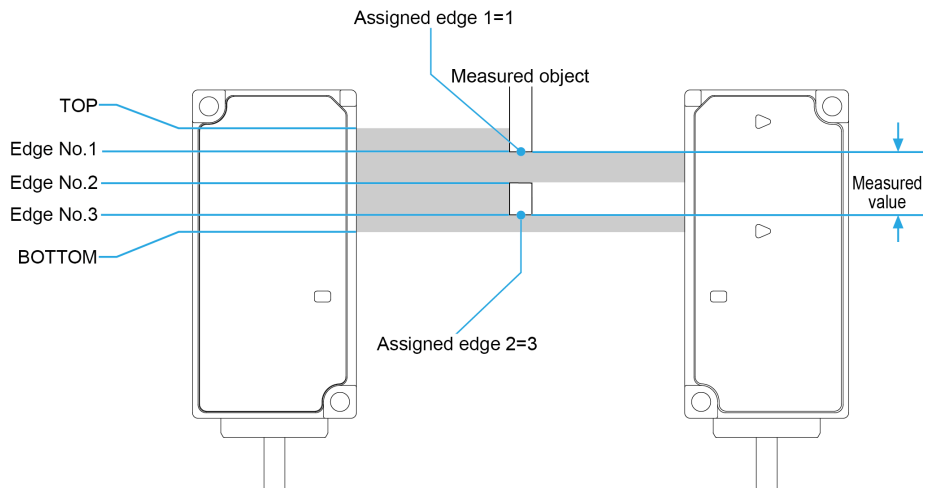

- When measuring the distance between the TOP or BOTTOM position and the specified edge position (Example: TOP and Edge No. 1)

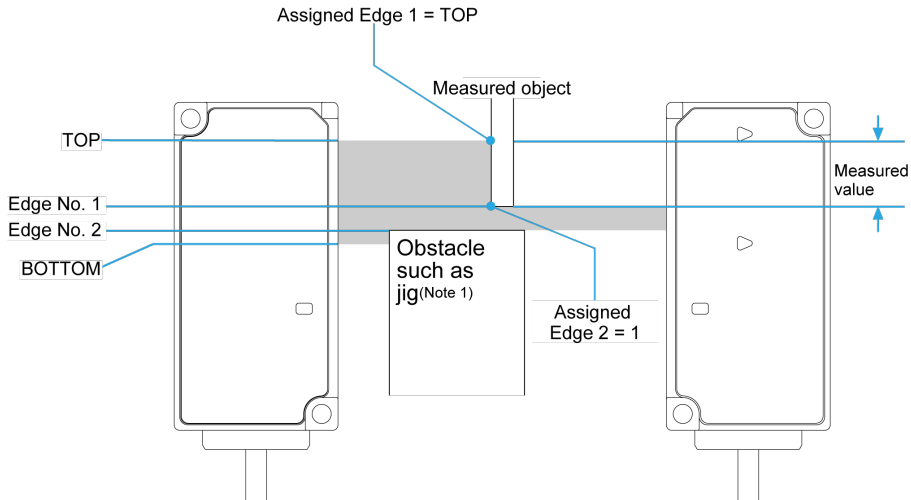

(Note 1) Perform beam axis adjustment and reference waveform registration when there are no obstacles.

**Note**

- Full light entry state is displayed as "-----".

■ Setting method

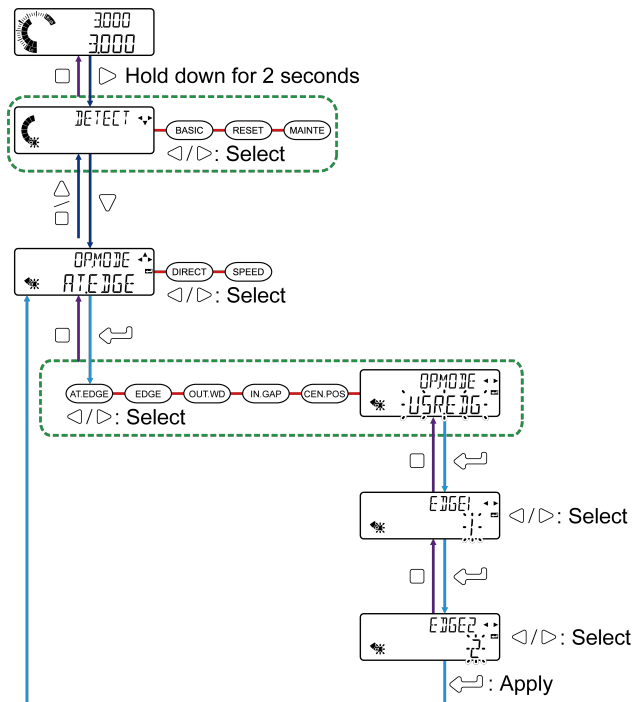

## 5.4 Operation Mode

---

Setting item	Setting range	Default value
Edge 1 (EDGE1)	TOP 1 to 10 BOTTOM	1
Edge 2 (EDGE2)	TOP 1 to 10 BOTTOM	2

### 5.5 Settings on the Base Screen (Using Shortcut Keys)

This section explains other functions that can be used from the base screen.

#### 5.5.1 Display Switching Mode

##### ■ Overview

You can change the display of the digital display section / SUB (green) as needed for the task. For example, if you select "Sensor head measured value", the actually measured value and judgment value can be simultaneously compared and displayed, making it easy to check the state of sensor head measurement.

##### ■ Settings

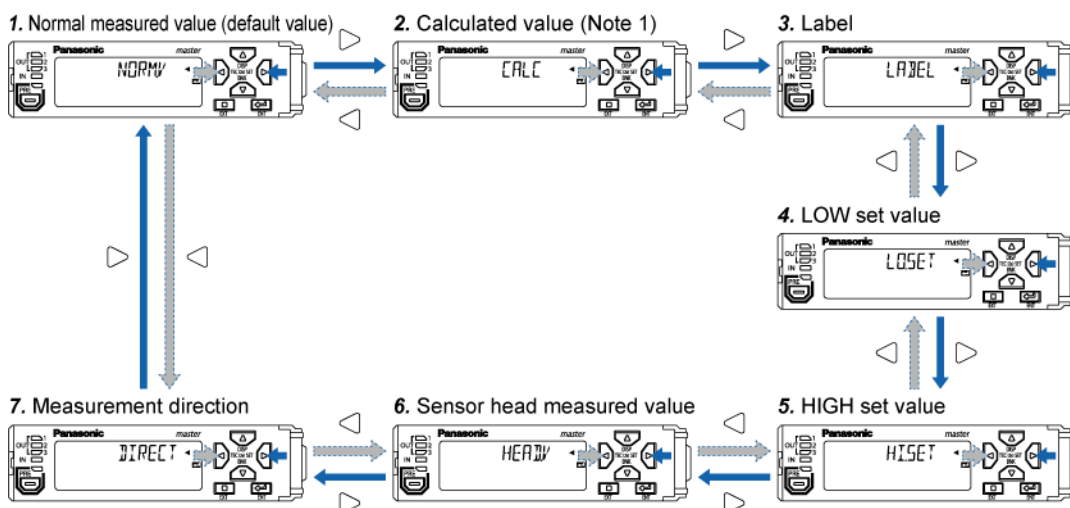

Name		Digital display section SUB (Green)	Description	Factory default state
1	Normal measured value	NORM	Shows the normal measured value. • When using the hold function, you can check internal measured values that are not held.	Default state
2	Calculated value (Note 1)	CALC	Shows the calculated value. • When using the calculation function and hold function, you can check calculation results that are not held.	-
3	Label	LABEL	You can view and set any values or characters. • This saves you the trouble of attaching sensor number and other labels on the controller.	-
4	LOW set value	LOSET	Shows the LOW set value. • You can check the judgment value and lower limit value at the same time.	-
5	HIGH set value	HISET	Shows the HIGH set value.	-

## 5.5 Settings on the Base Screen (Using Shortcut Keys)

Name	Digital display section SUB (Green)	Description	Factory default state
		<ul style="list-style-type: none"> <li>You can check the judgment value and upper limit value at the same time.</li> </ul>	
6 Sensor head measured value	HEAD.V	Shows the measured value from the sensor head. <ul style="list-style-type: none"> <li>When using the preset or calibration function, you can check the actual pre-correction measured value.</li> </ul>	-
7 Measurement direction	DIRECT	Shows the direction in which the measured object is inserted. You can check that the direction is the TOP or BOTTOM side.	-

(Note 1) Calculation function settings are configured on the master unit. When a setting other than "STAND" (standard difference) is selected for the calculation function, "CALC" appears only on the master unit. When the "STAND" (standard difference) setting is selected for the calculation function, "CALC" appears on the slave units but not on the master unit. When the calculation function is not used, this does not appear on either the master unit or the slave units.

"CALC" does not appear on a master unit that is not connected to slave units.

### Note

- "NORM.V" (Normal Value) is the normal measured value to which the preset, measurement direction, and calibration functions are reflected.
- "HEAD.V" (Head Value) is the measured value from the sensor head.
- The digital display section / MAIN (white) displays the judgment value that triggers judgment output ON / OFF based on the LOW set value and the HIGH set value. Analog output is also output based on the judgment value.

## 1 2 Procedure

- Hold down the  key for 2 seconds. (The number of lit increments in the circle meter increases.)

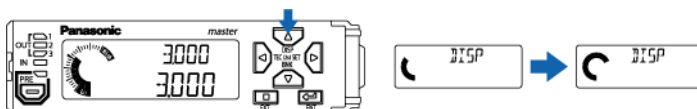

Long-press for 2 seconds

- "NORM.V" (normal measured value) appears in the digital display section / SUB (green).

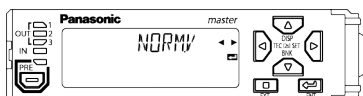

- Press the  /  key to switch to the item you want to display.

## 5.5 Settings on the Base Screen (Using Shortcut Keys)

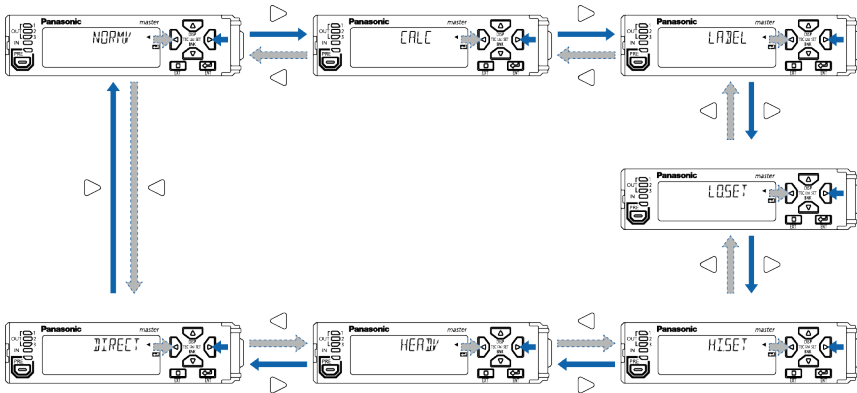

4. Press the  key to apply the setting and return to the base screen.

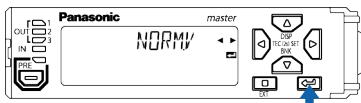

However, if you press the  key with "LABEL" selected, you will move to the label setting screen.

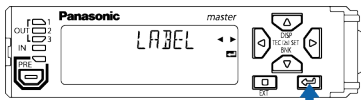

### Label settings

#### 1 2 Procedure

1. If you press the  key with "LABEL" selected in display switching mode, you will move to the label setting screen.

## 5.5 Settings on the Base Screen (Using Shortcut Keys)

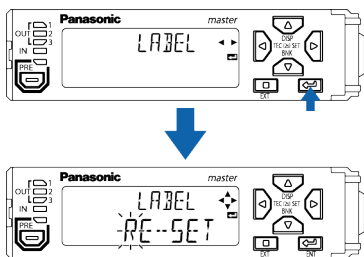

2. Press the  $\Delta$  /  $\nabla$  key to change the numeric character. Press the  $\triangleleft$  /  $\triangleright$  key to change the digit position.

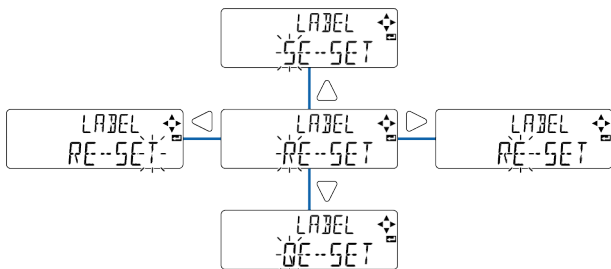

3. Press the  $\leftarrow$  key to apply the setting and return to the base screen.

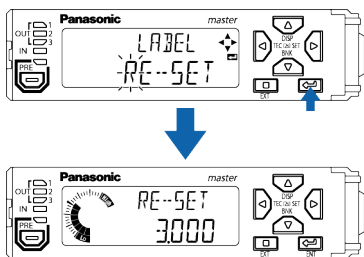

### 5.5.2 Preset

#### ■ Overview

You can perform zero-point adjustment and shift to any preset value.

You can perform reference zero-point adjustment when the sensor head has been replaced or when the workpiece has been changed, and set the dimensions of the master workpiece (or the like) as preset values for use as master values (reference values).

### Presets

12

#### Procedure

1. Perform master workpiece measurement.



## 5.5 Settings on the Base Screen (Using Shortcut Keys)

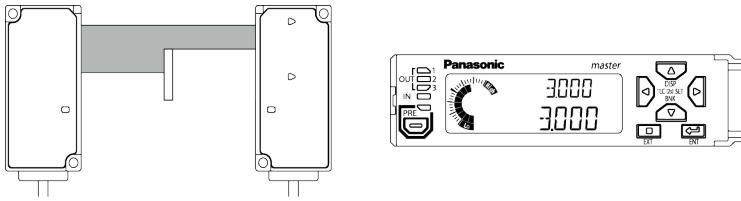

- Press the  key with the master workpiece measured.  
When the preset function turns ON, the preset indicator (green) lights up.  
If the preset value is set to "0.000" (default setting), you can perform zero-point adjustment.

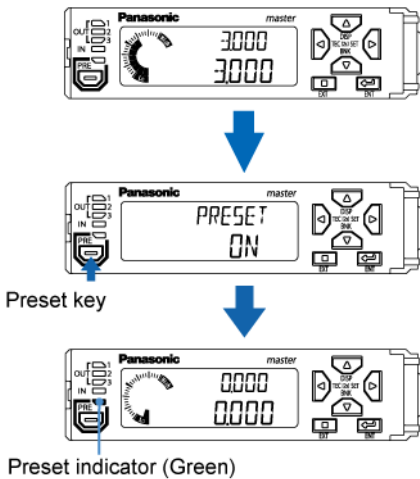

### Note

- If you change the preset value with the preset function turned OFF, the normal measured value will be shifted according to the preset value.
- To set preset values by external input, set external input to preset input.
- If you set preset values by key operation, the preset values are saved in internal memory and retained even after the power is turned OFF.
- The internal memory can be used approximately one million times.
- If one of the messages in the table below appears in the digital display section, the preset function has not been executed correctly and an error has occurred. In this case, restore the controller to its normal state and then execute the preset function.

Digital display section		Description
MAIN (White) / SUB (Green)	Display	
MAIN (White) SUB (Green)	-----	Immediately after the power is turned ON or a reset is input or when a measured object has not entered the measurement area
MAIN (White)	OVER	When the upper or lower display limit is exceeded
MAIN (White)	ALARM	When an alarm is output
SUB (Green)	HWERR	When an error is output

## 5.5 Settings on the Base Screen (Using Shortcut Keys)

### Canceling a preset

#### 1 2 Procedure

- To cancel the preset function, hold down the  key for 2 seconds.

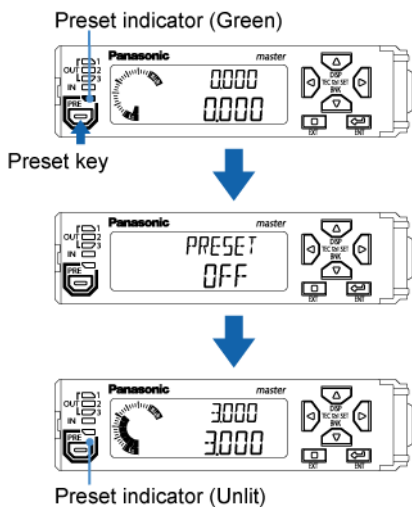

### 5.5.3 Saving and Loading Settings to / from Banks

#### ■ Overview

You can save or load the HIGH set value, LOW set value, or other settings to / from a specified bank (1 to 3).

You can use the bank function to save settings for an object to be measured in a bank beforehand and easily load the settings when needed.

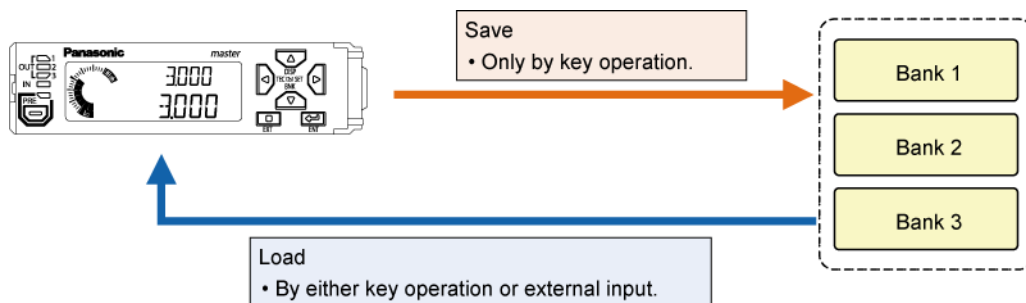

#### ■ Types of setting items saved to and loaded from banks

Setting item	Factory default state
All setting items	-
HIGH set value, LOW set value	Default state

## 5.5 Settings on the Base Screen (Using Shortcut Keys)

Setting item	Factory default state
HIGH set value, LOW set value, preset value, sensitivity adjustment, judgment level, judgment filter, edge 1, and edge 2	-

### Note

- For details on how to change the setting items saved to and loaded from banks, refer to "7.5 Bank Settings (BANK)".
- Set values saved to and loaded from banks are saved in internal memory and retained even after the power is turned OFF.
- The internal memory can be used approximately one million times.

### Saving and loading to / from banks by key operation

#### 1 2 Procedure

1. Hold down the  key for 2 seconds. (The number of lit increments in the circle meter increases.)

2. Press the  key to switch between "SAVE" and "LOAD".



3. Press the  key. "BANK1" appears in the digital display section / SUB (green), and "YES" appears in the digital display section / MAIN (white).



4. Press the  key to switch the bank.



5. Press the  key to set the bank. "YES" blinks in the digital display section / MAIN (white).

## 5.5 Settings on the Base Screen (Using Shortcut Keys)



6. Press the  key to switch between "YES" and "NO".



7. Press the  key.

If you selected "SAVE" in "Step 2", the current settings are saved to the bank.  
 If you selected "LOAD" in "Step 2", the settings saved in the bank are loaded.



8. Press the  key twice to return to the base screen.



### Loading by external input

By using bank A input and bank B input that are external inputs, the settings stored in each bank can be loaded by the external inputs.

Using combinations of bank A input and bank B input ON and OFF, you can load settings from each bank.

- Input external input signals for at least 20 ms.
- Bank A input and bank B input combinations are shown below.

Bank No. to load from	Bank A input	Bank B input
Bank 1	ON	OFF
Bank 2	OFF	ON
Bank 3	ON	ON

#### Note

- Settings cannot be saved to banks by external input.

### 5.5.4 Key Lock



#### ■ Overview

You can lock the operation keys to prevent accidental key operation during measurement.

While key lock is activated, all key operations other than key lock release cannot be performed.

### Key lock setting

#### 1 2 Procedure

1. Hold down the  key and  key simultaneously for 2 seconds. (The number of lit increments in the circle meter increases.)

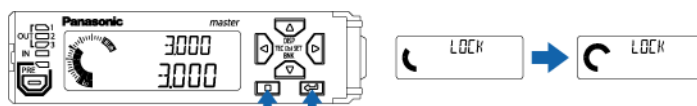

Hold down simultaneously for 2 seconds

2. "LOCK" appears in the digital display section / SUB (green), and "ON" appears in the digital display section / MAIN (white). Then, the display will automatically return to the base screen.



## 5.5 Settings on the Base Screen (Using Shortcut Keys)

### Note



- When any key is pressed, "LOCK" appears in the digital display section / SUB (green), and "ACT" appears in the digital display section / MAIN (white).



- Functions that use external input are enabled.
- You can configure settings to activate key lock automatically when key operation is not performed for 5 minutes or more.

### Key lock release

#### 1 2 Procedure

1. While key lock is enabled, hold down the  key and  key simultaneously for 2 seconds.

"OFF" appears in the digital display section / MAIN (white) and lock is released.

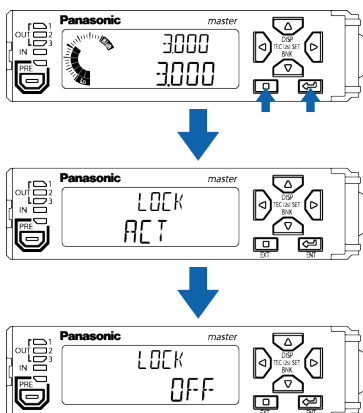

(Note 1) Even when auto key lock is enabled, you can use the above operation to release the lock.

### 5.5.5 Sensitivity Settings

#### Overview

You can adjust measurement sensitivity according to the light transmittance and measurement state of the measured object.

For sensitivity settings, you can set a judgment level and judgment filter. You can cope with various applications by combining judgment level and judgment filter settings.

#### Judgment level

Adjusting the judgment level enables objects with high transmittance to be measured stably.

## 5.5 Settings on the Base Screen (Using Shortcut Keys)

The judgment level is a set value that is used to judge whether the sensor head receiver is in a light entry state or light interception state according to the intensity of light received by the receiver.

If the intensity of received light that is registered as the reference waveform is regarded as 100% and the intensity of received light falls below a judgment level of 25% (default value), the receiver will be judged to be in a light interception state and the edge position will be calculated. For measured objects with high transmittance, you must increase the judgment level because light is received even in sections where light is intercepted.

### When the measured object is opaque

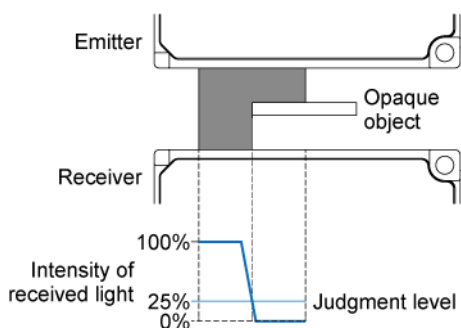

### When the measured object is translucent

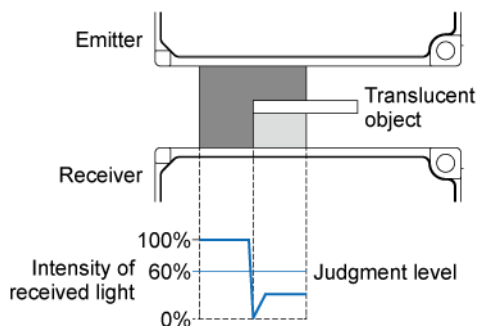

## 1 2 Procedure

1. Hold down the ◀ key and ▶ key simultaneously for 2 seconds. (The number of lit increments in the circle meter increases.)

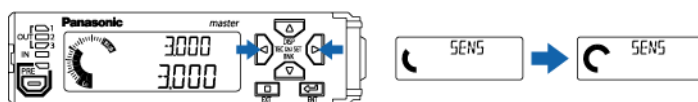

Hold down simultaneously for 2 seconds

2. "SEN.ADJ" (sensitivity settings) appears in the digital display section / SUB (green), and "DEFAULT" appears in the digital display section / MAIN (white).



## 5.5 Settings on the Base Screen (Using Shortcut Keys)

3. Press the  key to set the bank. "DEFALT" blinks in the digital display section / MAIN (white).

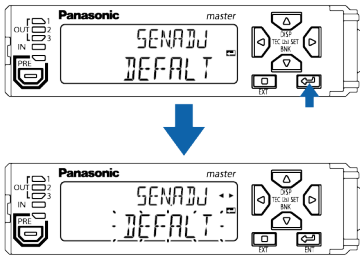



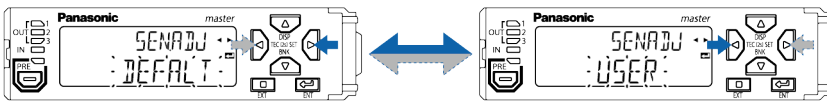

4. Press the  /  key to switch between "DEFALT" (default) and "USER" (user settings).



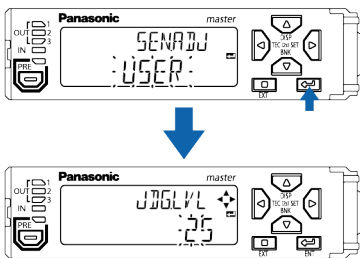

Sensitivity setting	Function
Default (DEFALT)	Sets to the default state.
User settings (USER)	Allows you to specify any desired judgment level value and judgment filter value.

5. Select "USER" (user settings) and press the  key. "JDG.LVL" (judgment level) appears in the digital display section / SUB (green), and "25" (default) appears in the digital display section / MAIN (white).

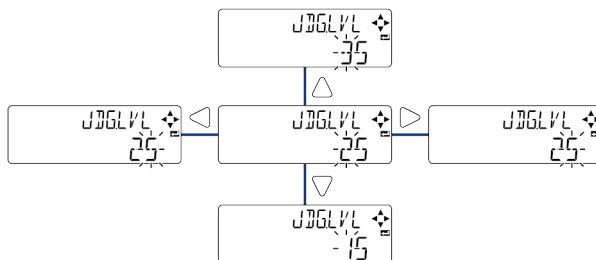

6. Set a judgment level. Press the  /  key to change the numeric character. Press the  /  key to change the digit position.



7. After setting the judgment level, press the  key. "JDG.FIL" (judgment filter) appears in the digital display section / SUB (green), and "9" (default) appears in the digital display section / MAIN (white).



## 5.5 Settings on the Base Screen (Using Shortcut Keys)

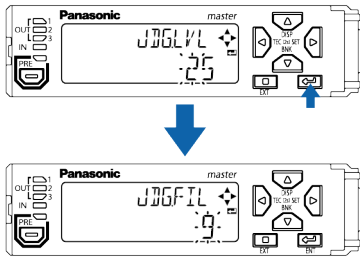

To return to the base screen halfway during setting, hold down the  key for 2 seconds.

### Setting method

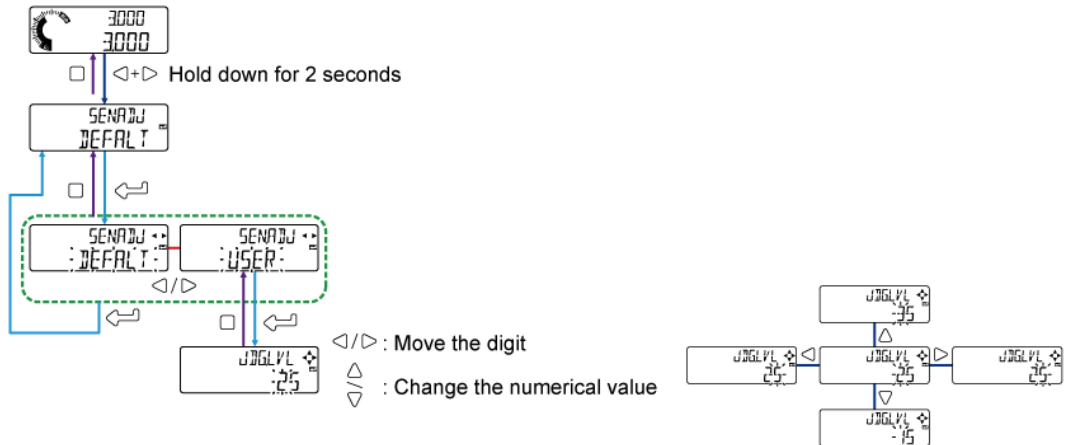

Setting item	Setting range	Default value
Judgment level (JDG.LVL)	10 to 90 (%)	25

### Judgment filter

Judgment filters can make measurement less affected by dirt and other foreign objects adhering to the glass cover of the sensor head emitter or receiver.

For judgment filter "3", only when at least three consecutive pixels appear in the light interception part of the sensor head receiver, the receiver is judged to be in a light interception state and the edge position (measured value) is calculated. When dirt adheres to the emitter or receiver, measurement can be continued unless at least three consecutive pixels appear in the light interception part.

If the filter value is too large, small objects cannot be measured.

## 5.5 Settings on the Base Screen (Using Shortcut Keys)

### For judgment filter "3"

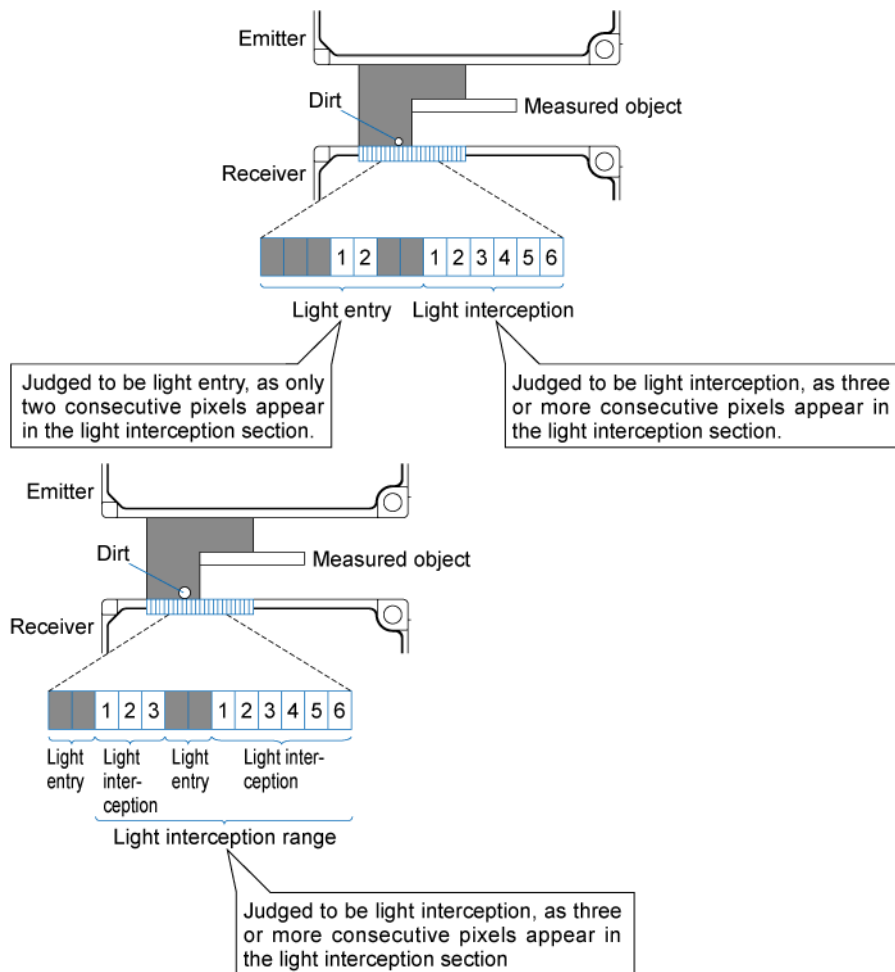

## 12 Procedure

1. Hold down the ◀ key and ▶ key simultaneously for 2 seconds. (The number of lit increments in the circle meter increases.)

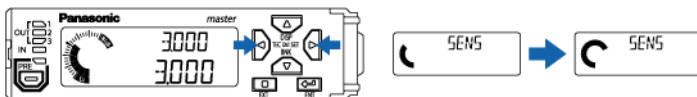

Hold down simultaneously for 2 seconds

2. "SEN.ADJ" (sensitivity settings) appears in the digital display section / SUB (green), and "DEFAULT" appears in the digital display section / MAIN (white).



## 5.5 Settings on the Base Screen (Using Shortcut Keys)

3. Press the  key to set the bank. "DEFAULT" blinks in the digital display section / MAIN (white).

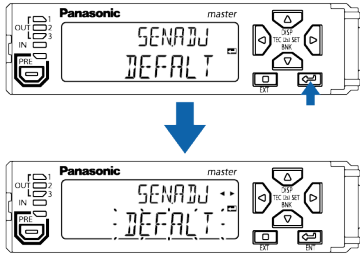

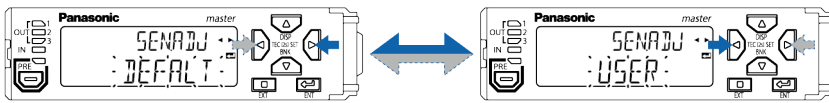

4. Press the  key to switch between "DEFAULT" (default) and "USER" (user settings).

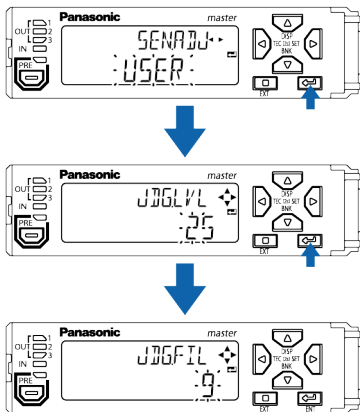

Sensitivity setting	Function
Default (DEFAULT)	Sets to the default state.
User settings (USER)	Allows you to specify any desired judgment level value and judgment filter value.

5. Select "USER" (user settings) and press the  key twice. "JDG.FIL" (judgment filter) appears in the digital display section / SUB (green), and "9" (default) appears in the digital display section / MAIN (white).



6. Set a judgment filter. Press the  key to change the numeric character. Press the  key to change the digit position.

## 5.5 Settings on the Base Screen (Using Shortcut Keys)

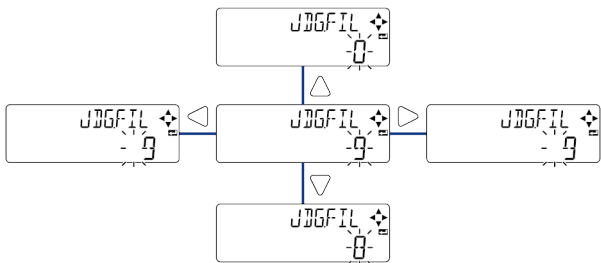

7. After setting a judgment filter, press the key. "FINISH" blinks in the digital display section / MAIN (white) and then the display returns to the base screen.

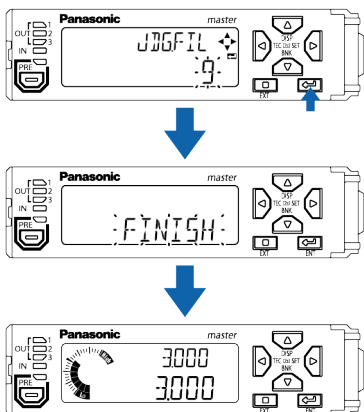

To return to the base screen halfway during setting, hold down the key for 2 seconds.

### Setting method

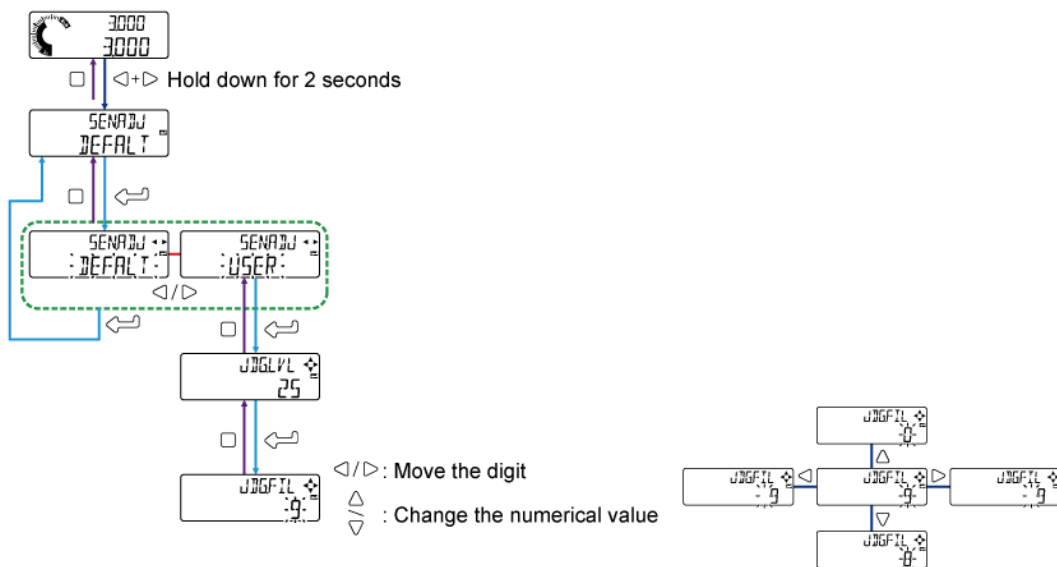

Setting item	Setting range	Default value
Judgment filter (JDG.FIL)	3 to 50	9

### 5.6 Self-monitoring Function

Self-monitoring function enables the sensor itself to judge various statuses (“normal status”, “unstable detection status”, “caution-required status”, and “abnormal status”) within its own device and send the status information to the host device.

The **HG-T** series sensors incorporate the self-monitoring function.

#### 5.6.1 Using the Self-monitoring Function

By combining the control system connected to PLC or PC via a network, this product, and the specified communication unit, you can easily check the sensor status (normal, notification, caution, or fault).

The sensor itself judges even the causes of cautions and errors, making cause investigation easier.

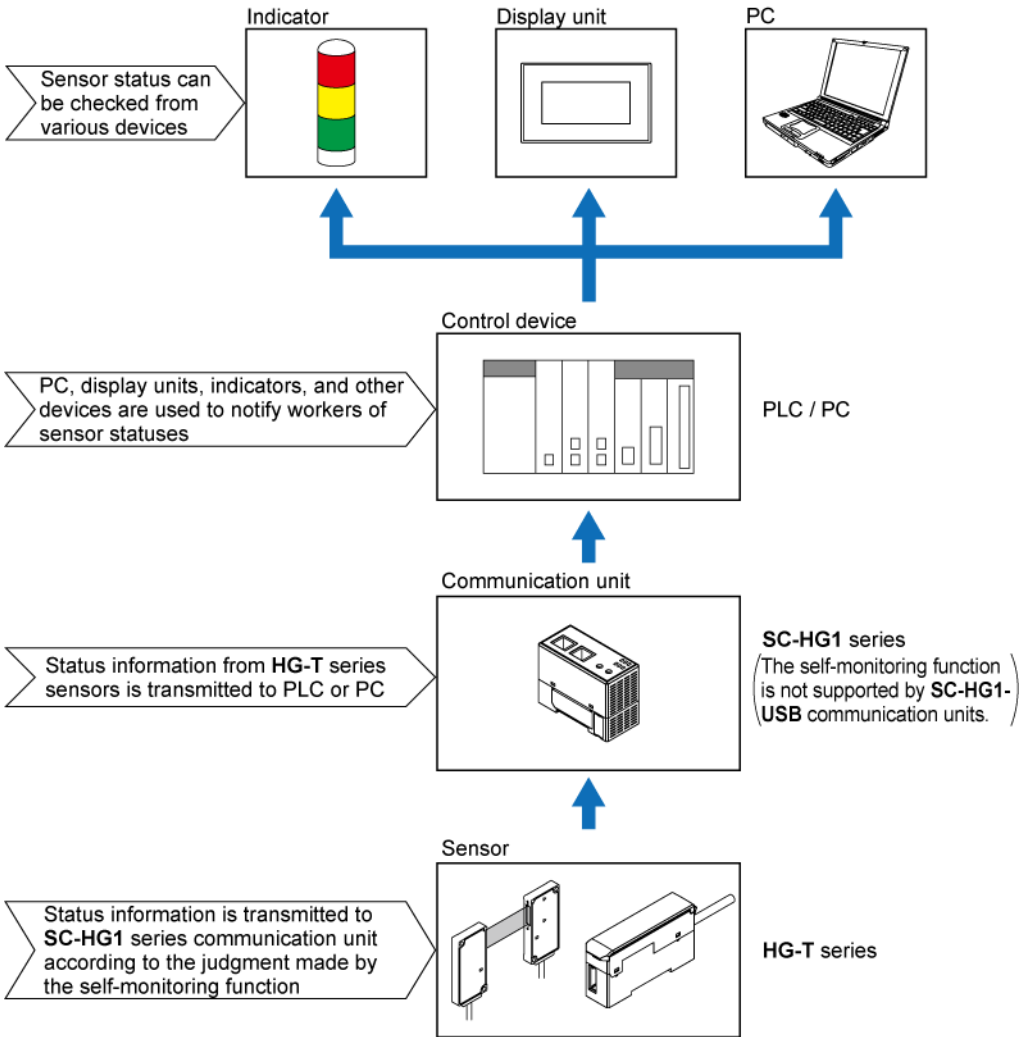

## 5.6 Self-monitoring Function

### 5.6.2 Statuses and Measures

The statuses judged by the self-monitoring function are classified into the following four categories.

When the status is “notification”, “caution”, or “fault”, you must check the installation state or maintain or replace the product.

Status	Description	Remarks
Normal	Normal state	The device is operating normally.
Notification	Unstable detection state	Review the settings.
Caution	State in which the device must be replaced	The device has almost reached its service life.
Fault	State in which the device is uncontrollable	The device is short-circuited or broken.

If “notification”, “caution”, or “fault” status is notified, take measures as shown in the following table.

	Response parameter	Measures	Reference page	Error code <sup>(Note 1)</sup>	Measurement alarm <sup>(Note 1)</sup>
Notif icati on	Sensor head unconnected	Status check	"P. 11-5"	E200	–
	Connected sensor head incompatible	Status check	"P. 11-5"	E230	–
	Connected unit count check error	Status check	"P. 11-5"	E160 (For master units only)	–
	NPN / PNP output type mixture error	Status check	"P. 11-5"	E100 (For master units only)	–
	Calculated unit count error	Status check	"P. 11-5"	E110 (For master units only)	–
	Copy execution error (Slave unit problem)	Status check	"P. 11-5"	E170 (For master units only)	–
	Detection capability limit (obtained edge information) <sup>(Note 2)</sup>	Sensing object check	"P. 11-2"	–	Measurement alarm 1
	The amount of entering light is too much due to the influences of ambient light, etc. <sup>(Note 2)</sup>	Status check	"P. 11-2"	–	Measurement alarm 1
	The amount of entering light decreases due to stain on the detection surface, beam axis misalignment, etc.	Sensing object check	"P. 11-2"	–	Measurement alarm 2
	The specified measurement direction differs from the insertion direction of the detected object.	Status check / Sensing object check	"P. 11-2"	–	Measurement alarm 2
CAU TIO N	Controller cumulative run time limit exceeded (87,600 hours)	Controller replacement	"P. 6-32"	–	–

Response parameter		Measures	Reference page	Error code <sup>(Note 1)</sup>	Measurement alarm <sup>(Note 1)</sup>
	Sensor head cumulative run time limit exceeded (87,600 hours)	Sensor head replacement	"P. 6-32"	–	–
	Controller memory saving count limit exceeded (1,000,000 times)	Controller replacement	–	–	–
	Sensor head memory saving count limit exceeded (for receivers only, 1,000,000 times)	Sensor head replacement	–	–	–
Fault	Controller memory function damaged	Controller replacement	"P. 11-5"	E600 / E610 / E620	–
	Sensor head memory function damaged	Sensor head replacement	"P. 11-5"	E630 (For receivers only) E640 (For emitters only)	–
	Output section short-circuit error	Status check / Replacement	"P. 11-5"	E700	–
	Detection circuit damaged	Sensor head replacement	"P. 11-5"	E240	–
	System error	Controller replacement	"P. 11-6"	E900 / E910 / E911 / E912 / E920	–

(Note 1) Error codes and measurement alarms are displayed on **HG-TC** controllers.

(Note 2) If "Alarm condition selection (ALM.CND)" is set to "Hold last value (HOLD)", Measurement alarm 1 is not notified.

#### Note

- For details on how to read each status, refer to the user's manual of the communication unit **SC-HG1** series that you use.

(MEMO)



# 6 Setting up General Functions

---

6.1	Flow of Measurement Data.....	6-2
6.2	Setting Operation List .....	6-4
6.3	Detection Settings ( <i>DETECT</i> ).....	6-9
6.3.1	Operation Mode ( <i>OPMODE</i> ).....	6-9
6.3.2	Measurement Direction ( <i>DIRECT</i> ).....	6-10
6.3.3	Average Count (Response Time)( <i>SPEED</i> ).....	6-11
6.4	Basic Settings ( <i>BASIC</i> ).....	6-15
6.4.1	HIGH Set Value ( <i>HISET</i> ).....	6-15
6.4.2	LOW Set Value ( <i>LOSET</i> ).....	6-16
6.4.3	Hysteresis ( <i>HYSTER</i> ).....	6-18
6.4.4	Teaching Types ( <i>TEACH</i> ).....	6-21
6.4.5	Tolerance <±> ( <i>TOL (±)</i> ).....	6-22
6.4.6	Preset Value ( <i>PRVAL</i> ).....	6-23
6.4.7	Preset Data Selection ( <i>PRDSEL</i> ).....	6-24
6.4.8	Preset Save ( <i>PRSAVE</i> ).....	6-25
6.4.9	Reference Waveform Save ( <i>RWSAVE</i> ).....	6-26
6.4.10	Output Operation ( <i>OUTPUT</i> ).....	6-27
6.4.11	Analog Output Selection ( <i>A/OSEL</i> ).....	6-28
6.4.12	Menu Display Settings ( <i>MENU</i> ).....	6-29
6.5	Initialization ( <i>RESET</i> ).....	6-31
6.6	Maintenance ( <i>MAINTEN</i> ).....	6-32



 **Note**

- When the measurement mode is set to the tab cancellation mode, the flow of measurement data is different. For details, refer to "[8.6.1 Flow of Measurement Data during Tab Cancellation](#)".

## 6.2 Setting Operation List

### 6.2 Setting Operation List

#### ■ Setting mode selection (General functions)

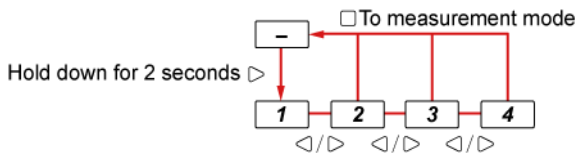

No.	Item	Display screen	Function	Reference page
-	Initial screen		-	-
1	Detection settings (DETECT)		This function allows you to set an operation mode, the direction of insertion, and average count according to the shape or application of the measured object.	"P. 6-9"
2	Basic settings (BASIC)		This function allows you to specify basic settings such as threshold values and output operation. Functions can also be extended with menu display settings.	"P. 6-15"
3	Initialization (RESET)		This function allows you to return all controller settings (other than calibration settings) to the factory default settings.	"P. 6-31"
4	Maintenance (MAINTE)		This function displays the cumulative operating periods for the controller and sensor head.	"P. 6-32"

#### Note

- Pressing the key in each setting mode allows you to enter a function selection item.
- You can extend function selection items from menu display settings in basic settings mode. For details on menu display settings, refer to "6.4.12 Menu Display Settings (MENU)".

#### ■ Function selection [Detection settings]

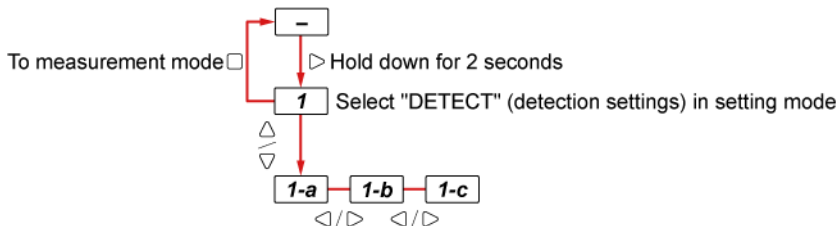

No.	Item	Display screen	Function	Reference page
-	Initial screen		-	-
1	Detection settings		-	-

No.	Item	Display screen	Function	Reference page
1-a	Operation mode (OP.MODE)		This function allows you to set an operation mode according to the use of the measurement method for the object to be measured. <Default: AT.EDGE>	"P. 6-9"
1-b	Measurement direction (DIRECT)		This function allows you to set the insertion direction of the measured object to the TOP or BOTTOM side. <Default: TOP>	"P. 6-10"
1-c	Average count (response time) (SPEED)		This function allows you to set the time period (response time) from when the sensor head starts measurement until a judgment value (JUDGE.V) is finalized and a judgment is output. The response time differs depending on whether the sampling cycle is high-speed sampling or standard sampling. <Default: 32>	"P. 6-11"

**Note**



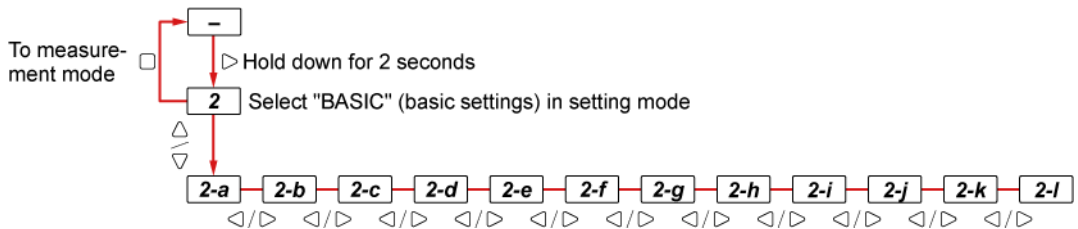

- The key operation (for the  $\Delta$  key) for returning to the setting mode selection screen also applies to the  $\square$  key.

**Function selection [Basic settings]**

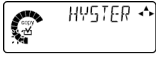
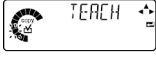
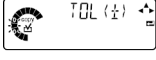
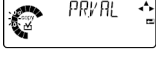
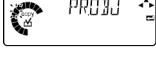
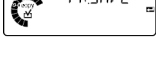
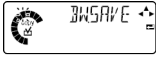

No.	Item	Display screen	Function	Reference page
-	Initial screen		-	-
2	Basic settings		-	-
2-a	HIGH set value (HI.SET)		This function allows you to manually set the HIGH set value (upper limit value) to any desired value. <Default: 5.000>	"P. 6-15"
2-b	LOW set value (LO.SET)		This function allows you to manually set the LOW set value (lower limit value) to any desired value. <Default: 1.000>	"P. 6-16"

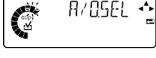
## 6.2 Setting Operation List

No.	Item	Display screen	Function	Reference page
2-c	Hysteresis (HYSTER)		If the judgment value (JUDGE.V) fluctuates in the vicinity of the HIGH/LOW set value, judgment output may turn ON and OFF repeatedly, resulting in unstable operations. Increasing the value of hysteresis makes operations stable. <Default: 0.003>	"P. 6-18"
2-d	Teaching type (TEACH)		This function allows you to set HIGH and LOW set values automatically. <Default: TCH.1>	"P. 6-21"
2-e	Tolerance <±> (TOL <±>)		When 1-point teaching is performed, the judgment value (JUDGE.V) of the master workpiece plus the tolerance is set as the HIGH set value and the judgment value of the master workpiece minus the tolerance is set as the LOW set value. <Default: 0.100>	"P. 6-22"
2-f	Preset value (PR.VAL)		When the preset function is set to ON, this function allows you to shift to any preset value (by addition/subtraction). When the preset function is set to OFF, this function shifts the normal measured value according to the preset value. <Default: 0.000>	"P. 6-23"
2-g	Preset data selection (PR.OBJ)		This function allows you to select target data (NORM.V or JUDGE.V) to be preset. <Default: NORM.V>	"P. 6-24"
2-h	Preset save (PR.SAVE)		Setting preset save to ON allows you to write information preset with external input to the EEPROM of the controller. Even if the power is turned OFF, the preset ON / OFF state and offset value remain stored. <Default: OFF>	"P. 6-25"
2-i	Reference waveform save (BW.SAVE)		This function is only valid for communication commands from the host device. Setting reference waveform save to ON allows you to write the reference waveform to the EEPROM of the sensor head receiver when reference waveform registration is executed with a communication command from the host device. <Default: OFF>	"P. 6-26"
2-j	Output operation (OUTPUT)		This function allows you to select an operation for judgment output. <Default: N.O.>	"P. 6-27"
2-k	Analog output selection (A/O.SEL)		This function allows you to select analog voltage output or analog current output. <Default: 1-5 V>	"P. 6-28"
2-l	Menu display setting (MENU)		This function allows you to select general function display or extended function display. <Default: NORMAL>	"P. 6-29"

**Note**

- The key operation (for the  $\triangle$  key) for returning to the setting mode selection screen also applies to the  $\square$  key.

■ Initialization settings

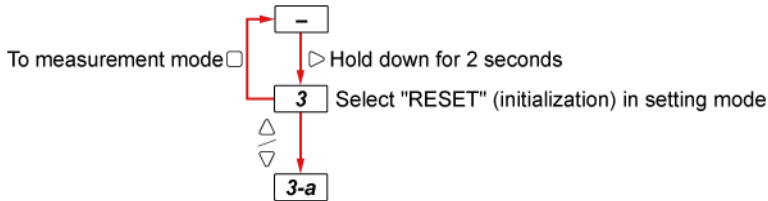

No.	Item	Display screen	Function	Reference page
-	Initial screen		-	-
<b>3</b>	Initialization		-	"P. 6-31"
<b>3-a</b>	Initialization (RESET)		This function allows you to return all controller settings (other than calibration settings) to the factory default settings.	

**Note**

- The key operation (for the  $\triangle$  key) for returning to the setting mode selection screen also applies to the  $\square$  key.

■ Maintenance

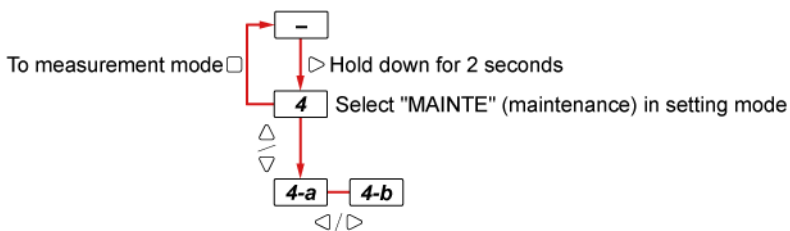



No.	Item	Display screen	Function	Reference page
-	Initial screen		-	-
<b>4</b>	Maintenance		-	-
<b>4-a</b>	Cumulative operating period (RUN.TIM)		This function displays the cumulative operating period for the controller.	"P. 6-32"

## 6.2 Setting Operation List

---

No.	Item	Display screen	Function	Reference page
4-b	Cumulative head operating period (HD.TIME)		This function displays the cumulative operating period for the sensor head.	

### Note

- The key operation (for the  key) for returning to the setting mode selection screen also applies to the  key.



### 6.3 Detection Settings (DETECT)

This function allows you to set an operation mode, the direction of insertion, and average count according to the shape or application of the measured object.

#### 6.3.1 Operation Mode (OPMODE)

Set an operation mode according to the measurement method for the object to be measured.

Operation mode	Function	Measurement direction setting
Auto edge detection mode (AT.EDGE)	This mode automatically recognizes the direction in which the measured object enters the measurement area of the sensor head (TOP or BOTTOM side). The distance from the edge of the side where the measured object enters the measurement area to the edge of the measured object is measured.	Not required
Edge detection mode (EDGE)	When the direction in which the measured object enters the measurement area of the sensor head is specified as the TOP or BOTTOM side, this mode measures the distance from the TOP or BOTTOM side of the measurement area to the edge of the measured object.	Required
Outer diameter / width detection mode (OUT.WD)	This mode measures the outer diameter or width of the measured object.	Not required
Inner diameter / gap detection mode (IN.GAP)	This mode measures the inner diameter or gap of the measured object.	Not required
Central position detection mode (CEN.POS)	When an object such as a pin is measured, this mode measures the distance from either the TOP or BOTTOM side to the center of the measured object.	Required
User-specified edge detection mode (USR.EDG)	When the measured object enters the detection area of the sensor head, the distance between two edges specified as desired is measured.	Not required

For details on each operation mode, refer to "5.4 Operation Mode".

## 6.3 Detection Settings (DETECT)

### Setting method

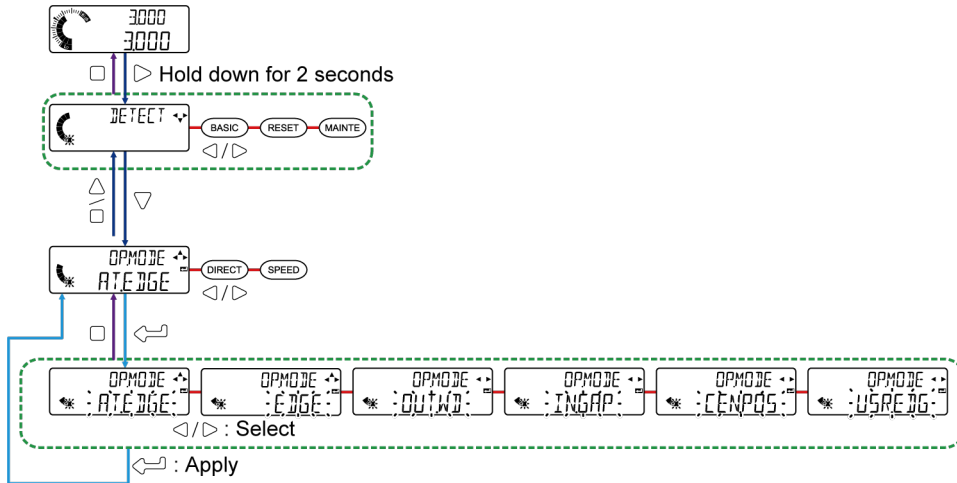

Setting item	Setting range	Default value
Operation mode (OP.MODE)	Auto edge detection mode (AT.EDGE) Edge detection mode (EDGE) Outer diameter / width detection mode (OUT.WD) Inner diameter / gap detection mode (IN.GAP) Central position detection mode (CEN.POS) User-specified edge detection mode (USR.EDG)	AT.EDGE

### 6.3.2 Measurement Direction (DIRECT)

This function sets the insertion direction of the measured object to the TOP or BOTTOM side.

Measurement direction	Function
TOP (TOP)	When the measured object is inserted from the TOP side
BOTTOM (BOTTOM)	When the measured object is inserted from the BOTTOM side

#### When set to TOP

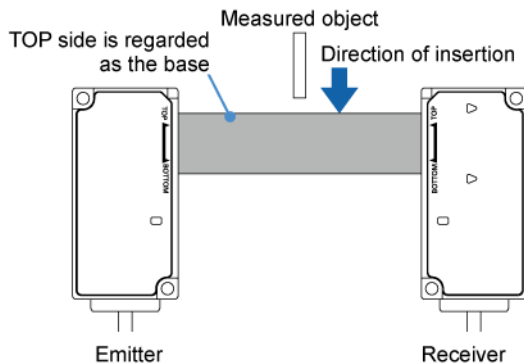

### When set to BOTTOM

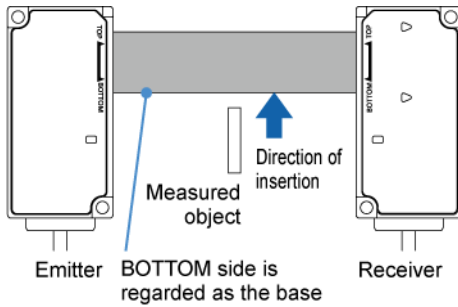

#### Note

- When the operation mode (OP.MODE) is set to auto edge detection mode (AT.EDGE), outer diameter / width detection mode (OUT.WD), inner diameter / gap detection mode (IN.GAP), or user assigned edge detection mode (USR.EDG), the measurement direction is displayed as "\*\*\*\*\*".

#### Setting method

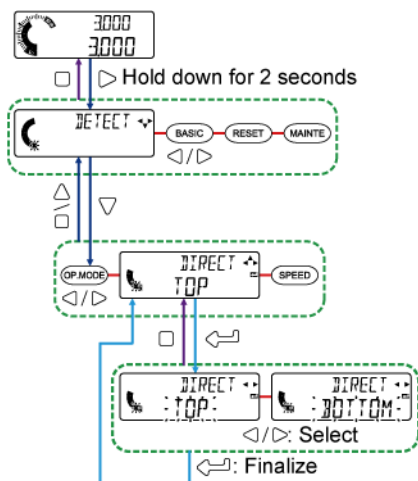

Setting item	Setting range	Default value
Measurement direction (DIRECT)	TOP (TOP) BOTTOM (BOTTOM)	TOP

### 6.3.3 Average Count (Response Time)(SPEED)

This function allows you to set the time period (response time) from when the sensor head starts measurement until a judgment value (JUDGE.V) is finalized and a judgment is output.

The response time differs depending on whether the sampling cycle is high-speed sampling or standard sampling.

## 6.3 Detection Settings (DETECT)

### Sampling cycle: Standard sampling "NORMAL"

Average count (number of times)	Sampling cycle (ms)	Response time (ms)	Update cycle (ms)
1	1	2	1
2	1	3	1
4	1	5	1
8	1	9	1
16	1	17	1
32	1	33	1
64	1	65	1
128	1	129	2
256	1	257	4
512	1	513	8
1,024	1	1,025	16

### Sampling cycle: High-speed sampling "HI-SPD"

Average count (number of times)	Sampling cycle (ms)	Response time (ms)	Update cycle (ms)
1	0.5	1.5	0.5
2	0.5	2	0.5
4	0.5	3	0.5
8	0.5	5	0.5
16	0.5	9	0.5
32	0.5	17	0.5
64	0.5	33	0.5
128	0.5	65	1
256	0.5	129	2
512	0.5	257	4
1,024	0.5	513	8

### When the average count is set to 8 (Sampling cycle: Standard sampling "NORMAL")

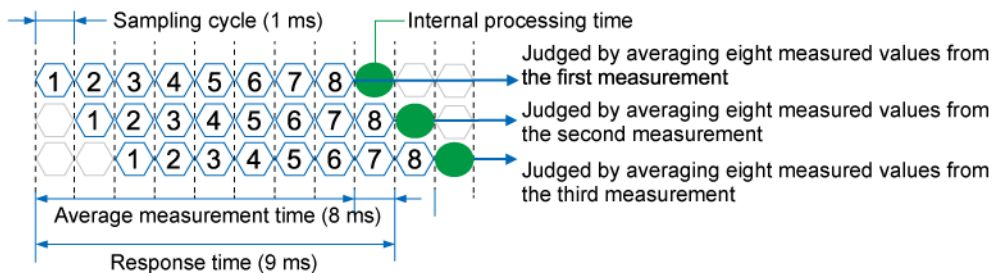

**Update cycle**

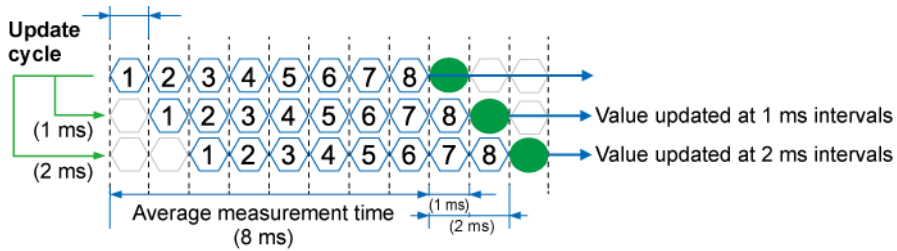

**Note**

- Setting the average count to a small value enables the sensor head to respond to momentary changes. Setting the average count to a large value enables the sensor head to be less influenced by sudden changes or similar events.
- Indeterminate value display "-----" appears until the average count is reached after reset input turns ON.
- For details on sampling cycles, refer to "7.2.12 Sampling Cycle (SAMPLE)".
- If "MODE" (calculation mode) is set to "CALC" (calculate), approximately 3 ms will be added to the response time for judgment output. For details on calculation mode, refer to "7.3.1 Calculation Mode (MODE)".

**Setting method**

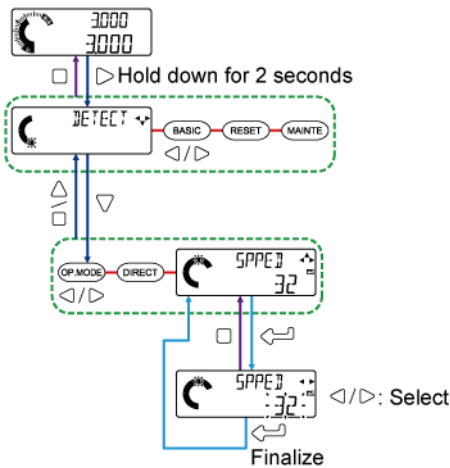

Setting item	Set value	Default value
Average count (response time) (SPEED)	1	32
	2	
	4	
	8	
	16	
	32	
	64	
	128	
	256	

## 6.3 Detection Settings (DETECT)

---

Setting item	Set value	Default value
	512 1024	

## 6.4 Basic Settings (BASIC)

This function allows you to specify basic settings such as threshold values and output operation. Functions can also be extended with menu display settings.

### 6.4.1 HIGH Set Value (HI.SET)

This function allows you to set the HIGH set value (upper limit value) to any desired value. If the judgment value (JUDGE.V) exceeds the HIGH set value, the judgment is output as HIGH.

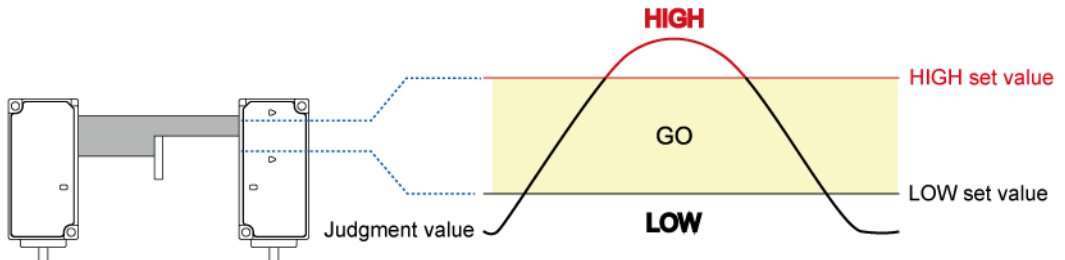

#### Note

- Be sure to set a HIGH set value that is greater than the LOW set value.
- The HIGH set value can be always displayed in the digital display section / SUB (green). For details, refer to "5.5.1 Display Switching Mode".
- By teaching, you can set HIGH and LOW set values. For details, refer to "5.3.4 Teaching".

#### Setting method

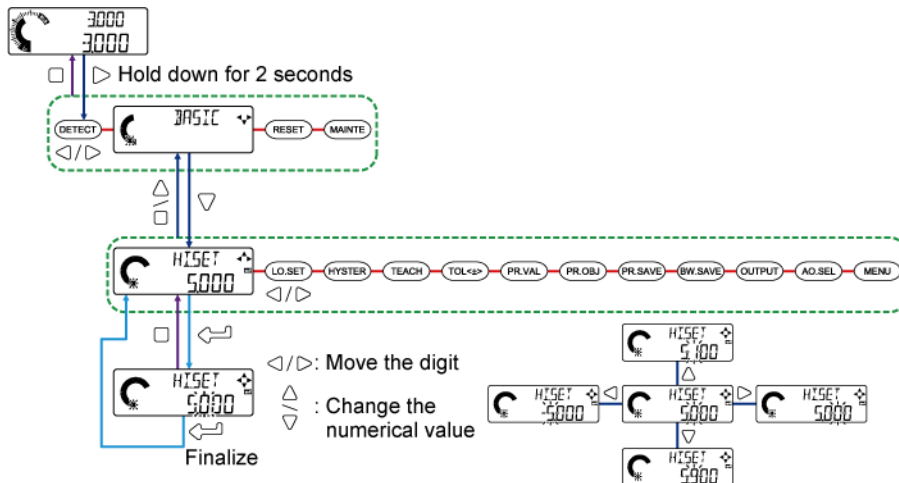

Setting item	Setting range	Default value
HIGH set value (HI.SET)	-199.999 to 199.999 (mm)	5.000

## 6.4 Basic Settings (BASIC)

### Note

- In addition to this method, you can also set a HIGH set value directly from the base screen during measurement.

## Setting a HIGH set value directly during measurement

### 1 2 Procedure

1. Press the  $\Delta$  key in the base screen. "HI.SET" appears in the digital display section / SUB (green), and the HIGH set value appears in the digital display section / MAIN (white).

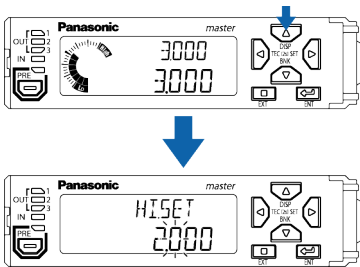

2. Press the  $\triangleleft$  /  $\triangleright$  key to change the digit position. Press the  $\Delta$  /  $\nabla$  key to increase or decrease the numerical value.

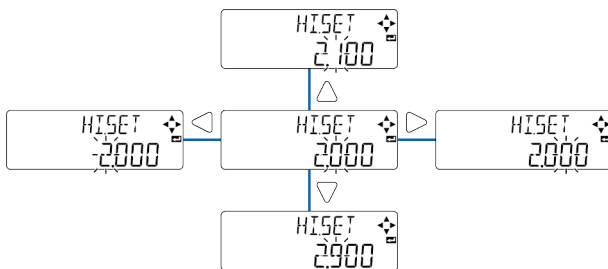

3. Press the  $\leftarrow$  key to finalize the setting.

### Note

- If you take no action for 5 seconds, the screen will automatically return to the base screen and the setting will be finalized.

### 6.4.2 LOW Set Value (LQSET)

This function allows you to set the LOW set value (lower limit value) to any desired value. If the judgment value (JUDGE.V) falls below the LOW set value, the judgment is output as LOW.



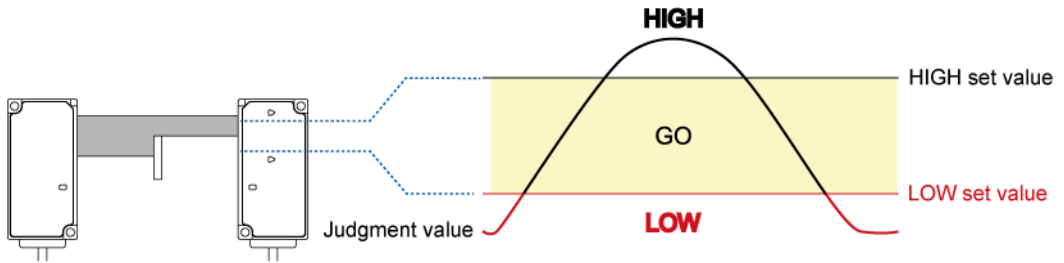

**Note**

- Be sure to set a LOW set value that is smaller than the HIGH set value.
- The LOW set value can be always displayed in the digital display section / SUB (green). For details, refer to "5.5.1 Display Switching Mode".
- By teaching, you can set HIGH and LOW set values. For details, refer to "5.3.4 Teaching".

**Setting method**

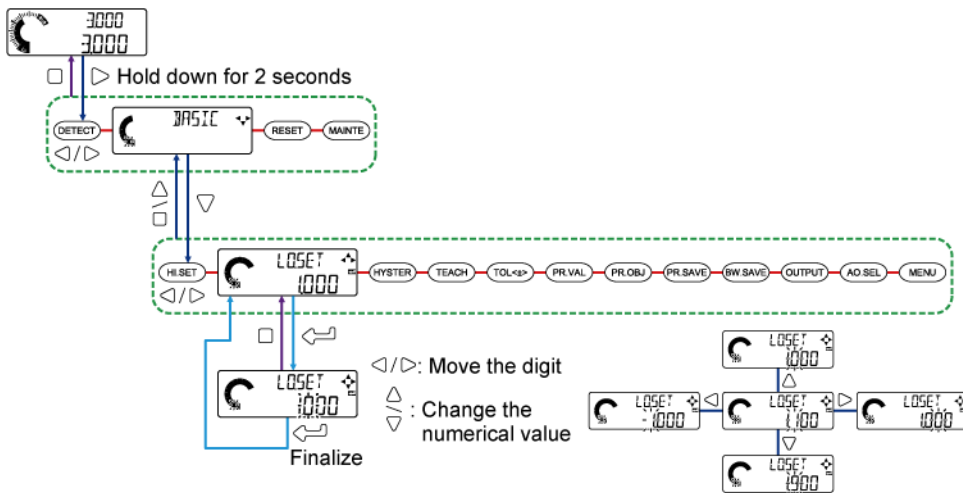

Setting item	Setting range	Default value
LOW set value (LO.SET)	-199.999 to 199.999 (mm)	1.000

**Note**

- In addition to this method, you can also set a LOW set value directly from the base screen during measurement.

## 6.4 Basic Settings (BASIC)

### Setting a LOW set value directly during measurement

#### 1 2 Procedure

1. Press the  $\nabla$  key in the base screen. "LO.SET" appears in the digital display section / SUB (green), and the LOW set value appears in the digital display section / MAIN (white).

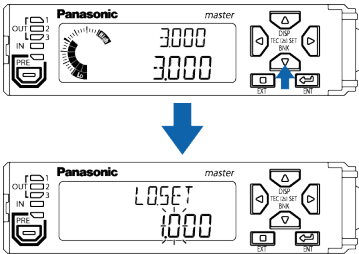

2. Press the  $\triangle$  /  $\triangleright$  key to change the digit position. Press the  $\triangle$  /  $\nabla$  key to increase or decrease the numerical value.

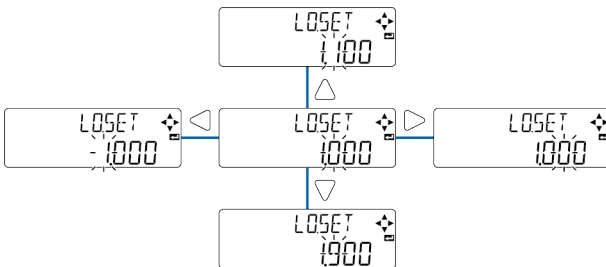

3. Press the  $\leftarrow$  key to finalize the setting.

#### Note

- If you take no action for 5 seconds, the screen will automatically return to the base screen and the setting will be finalized.

### 6.4.3 Hysteresis (HYSTER)

If the measured object vibrates in the vicinity of the HIGH/LOW set value, the judgment value may fluctuate, resulting in unstable operations. Increasing the value of hysteresis makes operations stable.

#### If hysteresis is "0"

The judgment value (JUDGE.V) fluctuates in the vicinity of the HIGH set value (or LOW set value), making judgment output unstable.

(In the following timing chart, external output is set to "3VAL" and output operation is set to "N.O.".)

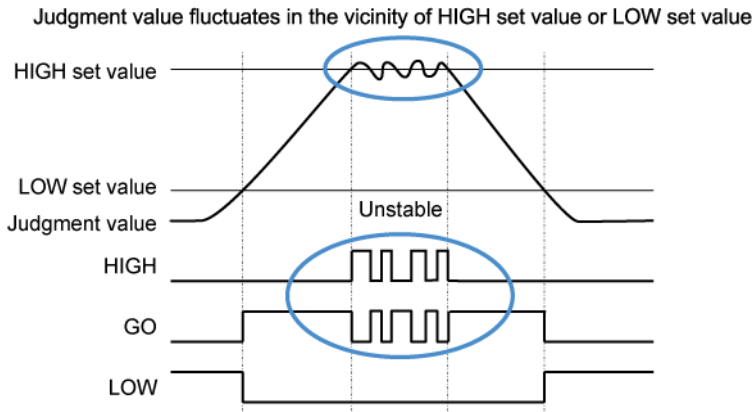

### If hysteresis is set

Even if the judgment value (JUDGE.V) fluctuates in the vicinity of the HIGH set value (or LOW set value), judgment output will be stable.

(In the following timing chart, external output is set to "3VAL" and output operation is set to "N.O.".)

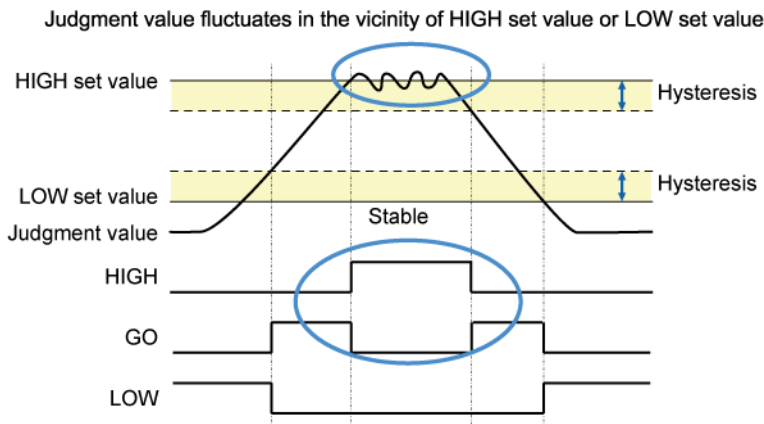

### Note

- For details on external output, refer to "7.2.4 External Outputs (EXT.OUTPUT)".
- For details on output operation, refer to "6.4.10 Output Operation (OUTPUT)".

## 6.4 Basic Settings (BASIC)

### Note

- Set hysteresis to a value that is smaller than the difference between the HIGH set value and LOW set value. If hysteresis is set to a value that is equal to or greater than the difference between the HIGH set value and LOW set value, the judgment is not output as "GO".

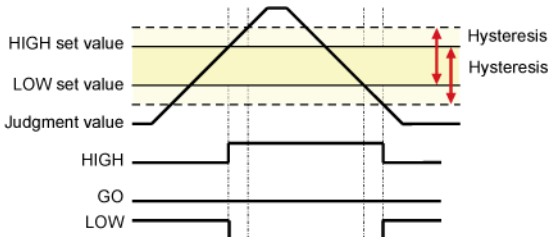

- Even if hysteresis is set, be sure to set a HIGH set value that is greater than the LOW set value. If the LOW set value is set to a value that is equal to or greater than the HIGH set value, the judgment is not output as "GO".

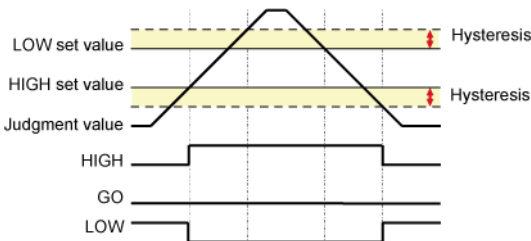

### Setting method

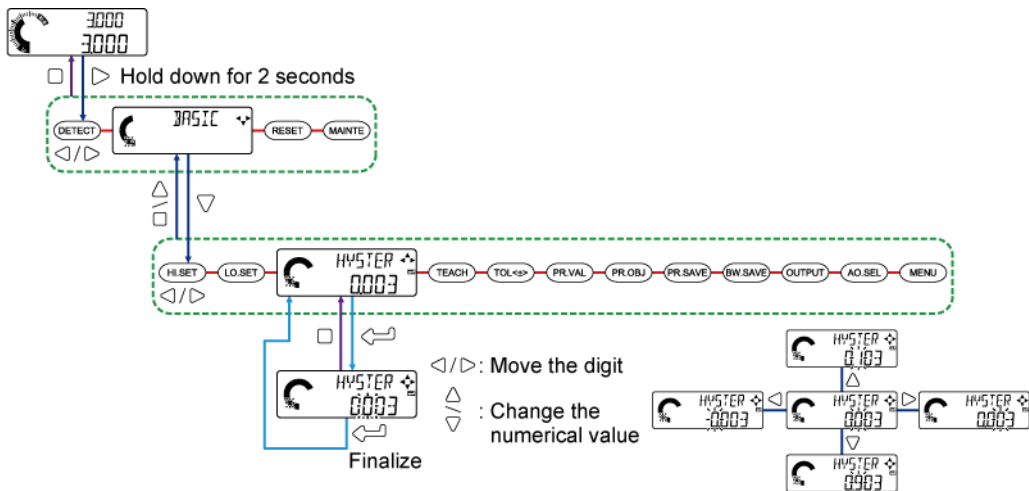

Setting item	Setting range	Default value
Hysteresis (HYSTER)	0 to 199.999 (mm)	0.003

**6.4.4 Teaching Types (TEACH)**

By teaching, you can automatically set HIGH and LOW set values. For the teaching method, you can select 1-point teaching, 2-point teaching, or 3-point teaching.

■ **Settings**

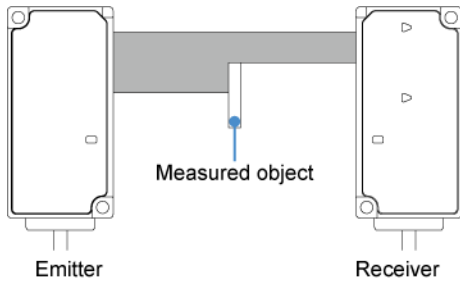

Teaching type	Setting method
1-point teaching (Default)	<p>You can use a master workpiece to automatically set upper and lower limit values. Use this method when you want to judge workpieces by a <math>\pm</math> tolerance.</p>
2-point teaching	<p>You can use two workpieces to automatically set upper and lower limit values. Use this method when you want to judge workpieces within an upper limit and lower limit range.</p>
3-point teaching	<p>You can use a good workpiece, a HIGH-side defective workpiece, and a LOW-side defective workpiece to automatically set upper and lower limit values. Use this method when you want to judge workpieces within a range that takes the intermediate values between good and defective workpieces as upper and lower limits.</p>

(Note 1) Upper and lower limit values are regarded as HIGH and LOW set values, respectively.

**Note**

- For details on how to perform teaching, refer to "5.3.4 Teaching".

## 6.4 Basic Settings (BASIC)

### Setting method

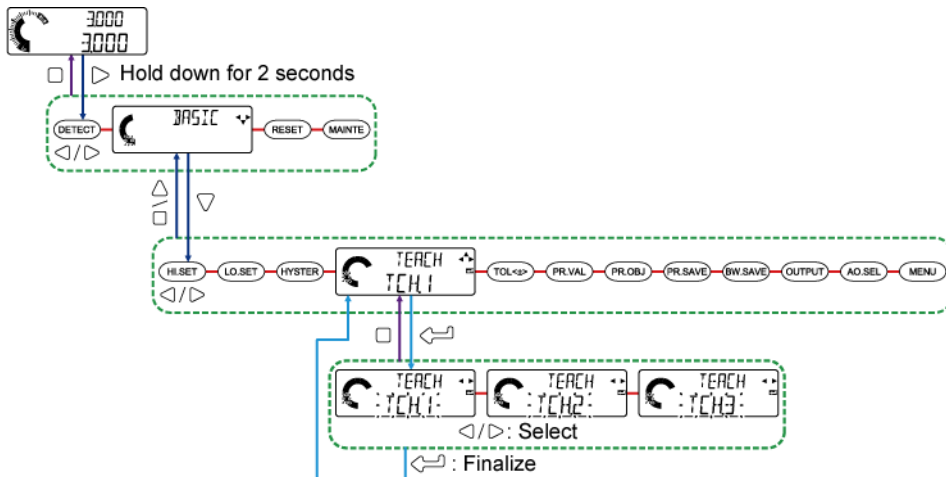

Setting item	Set value	Default value
Teaching type (TEACH)	1-point teaching (TCH.1) 2-point teaching (TCH.2) 3-point teaching (TCH.3)	TCH.1

### 6.4.5 Tolerance $\langle \pm \rangle$ (TOL $\langle \pm \rangle$ )

When 1-point teaching is performed, the judgment value (JUDGE.V) of the master workpiece plus the tolerance can be set as the HIGH set value and the judgment value of the master workpiece minus the tolerance can be set as the LOW set value.



(Note 1) When the tolerance ( $\pm$ ) is set to 1.000

#### Note

- Settings of tolerance  $\langle \pm \rangle$  are valid only when 1-point teaching is set.
- For details on how to perform 1-point teaching, refer to "5.3.4 Teaching".

■ Setting method

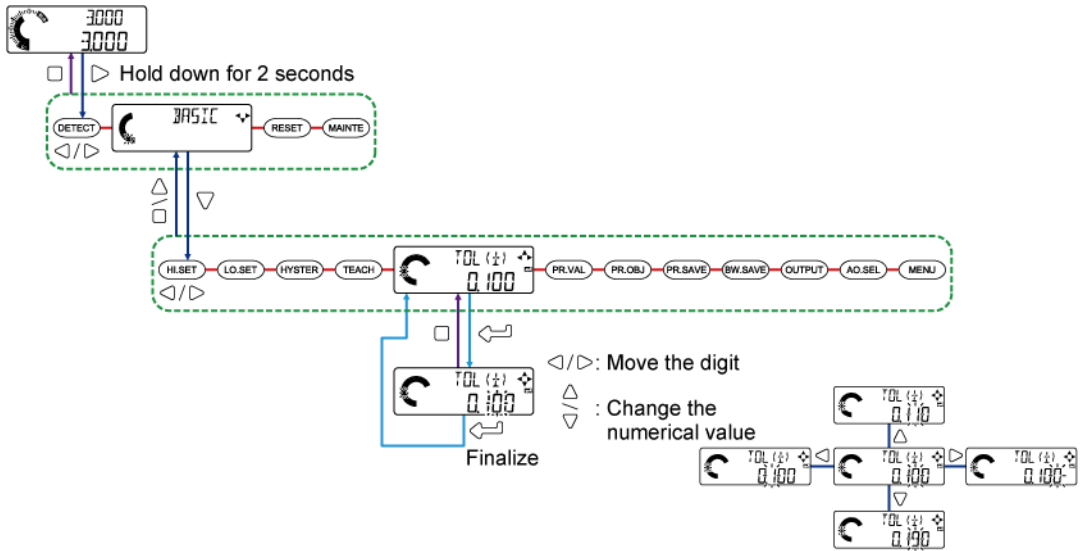

Setting item	Setting range	Default value
Tolerance ( $\pm$ )(TOL< $\pm$ >)	0 to 199.999	0.100

6.4.6 Preset Value (*PRVAL*)

When preset is performed, this function allows you to shift to any preset value (by addition/subtraction).

You can set the dimensions of the master workpiece (or the like) as preset values for use as master values (reference values).

Setting preset to OFF shifts the measured value.

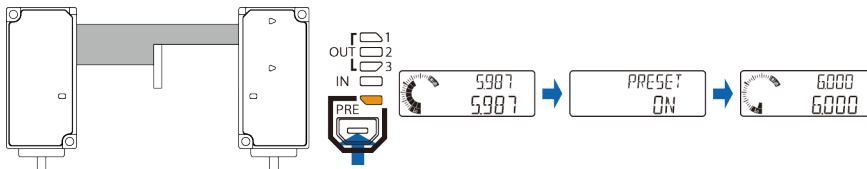

**Note**

- Setting preset to ON with the preset value set to 0 (default value) performs zero-point adjustment.
- If you change the preset value with preset set to OFF, the measured value will be shifted according to the preset value.
- Even if preset is being executed, any changes to preset value settings will be reflected.
- For details on the preset function, refer to "5.5.2 Preset".

## 6.4 Basic Settings (BASIC)

### ■ Setting method

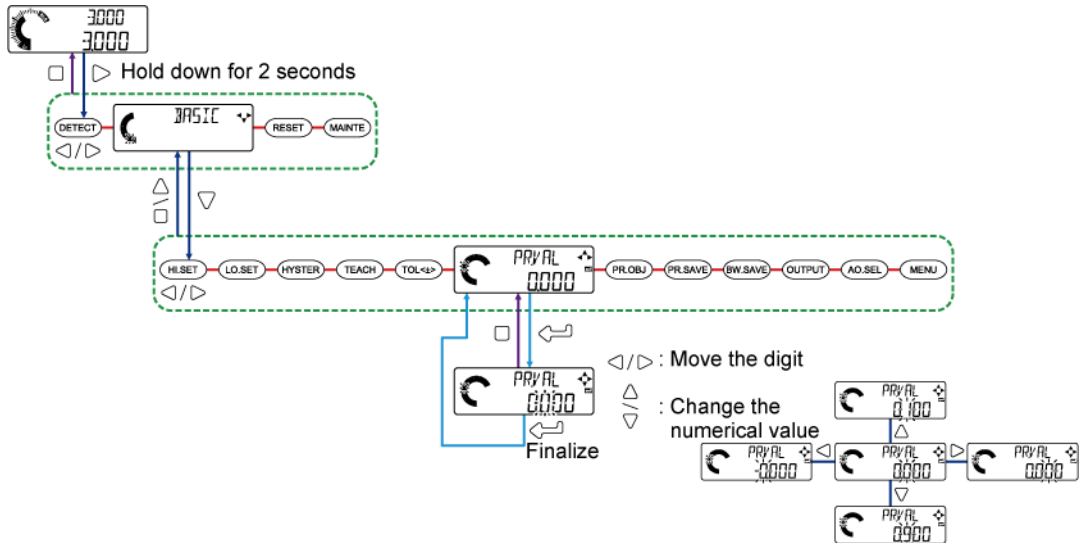

Setting item	Setting range	Default value
Preset value (PR.VAL)	-199.999 to 199.999 (mm)	0.000

### 6.4.7 Preset Data Selection (PROBJ)

This function allows you to select target data (NORM.V or JUDGE.V) to be preset. Selecting "Judgment value (JUDGE.V)" allows you to preset any value that you hold.

Preset data selection	Function
Normal measured value (NORM.V)	Normal measured values (NORM.V) are targeted for presetting.
Judgment value (JUDGE.V)	Judgment values (JUDGE.V) are targeted for presetting.

#### 📌 Note

- If you set preset data selection to "Judgment value (JUDGE.V)" and then set the calculation function to any application other than "standard difference", normal measured values (NORM.V) will be targeted.



### ■ Setting method

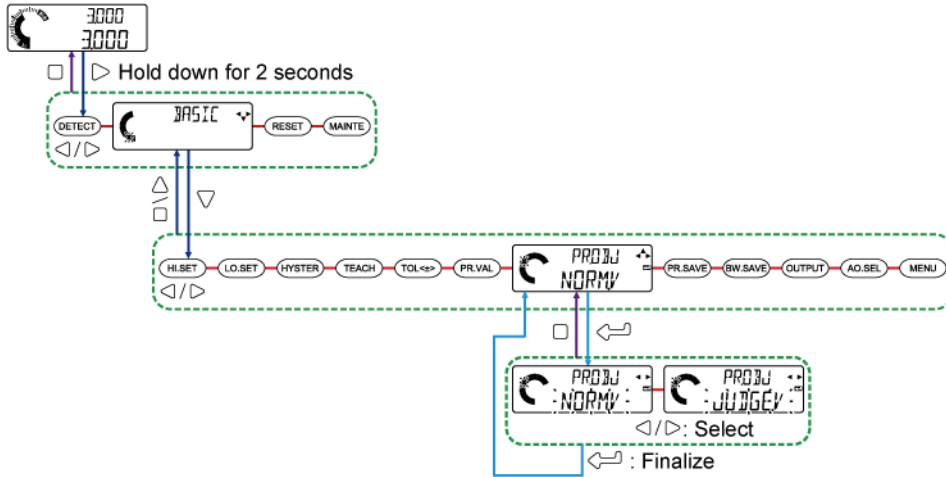

Setting item	Set value	Default value
Preset data selection (PR.OBJ)	Normal measured value (NORM.V) Judgment value (JUDGE.V)	NORM.V

### 6.4.8 Preset Save (PR.SAVE)

Setting PR.SAVE (preset save) to ON allows you to write information preset with external input to the EEPROM of the controller.

Even if the power is turned OFF, the preset value will remain stored.

When the power is turned ON, the controller reads the preset ON / OFF state and offset value that were written to the EEPROM last time.

#### Note

- The EEPROM of the controller can be rewritten approximately one million times. If there is no need to save preset values, set PR.SAVE (preset save) to OFF.
- If you set preset values by key operation, the preset values are saved in internal memory and retained even after the power is turned OFF.
- If preset input has been set for external input, preset can be performed by external input.
- For preset input by external input, refer to "7.2.3 External Inputs (EXT.IN)".



■ Setting method

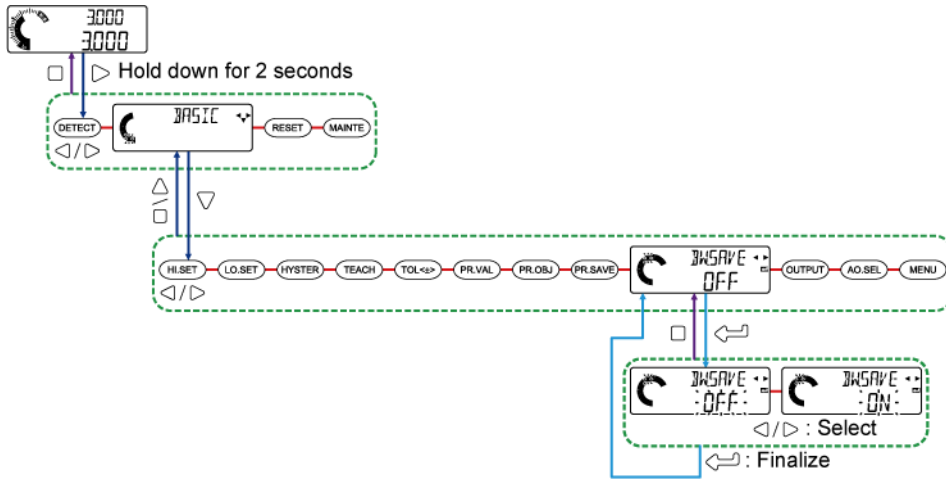

Setting item	Set value	Default value
Reference waveform save (BW.SAVE)	Reference waveform save OFF (OFF) Reference waveform save ON (ON)	OFF

6.4.10 Output Operation (OUTPUT)

This function allows you to select an operation for judgment output.

Output operation	Function
Normally open (N.O.)	ON is output at the time of judgment output.
Normally closed (N.C.)	OFF is output at the time of judgment output.

Example of output operation settings (for GO output)

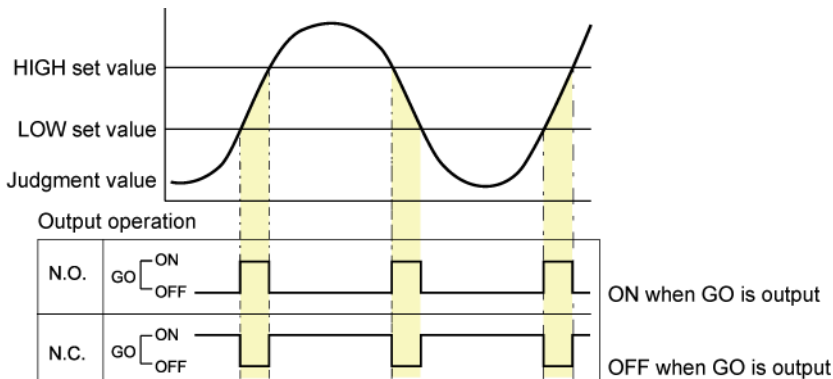

## 6.4 Basic Settings (BASIS)

### Setting method

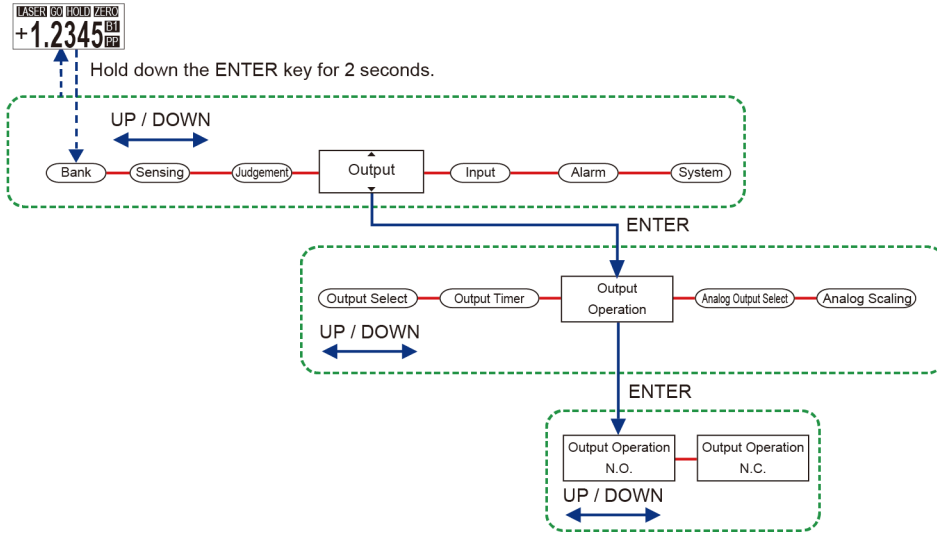

Setting item	Set value	Default value
Output operation (N.O./N.C.)	Normally open (N.O.) Normally closed (N.C.)	N.O.

### Note

- For alarm output when external output is "2VAL", "LOGIC", or "LOGIC2", output operation is "Normally Closed" (N.C.) regardless of the settings.
- For details on external output, refer to "7.2.4 External Outputs (EXT. OUT)".

### 6.4.11 Analog Output Selection (A/OSEL)

This function allows you to select analog output as either analog voltage output or analog current output.

Output operation	Function
Analog voltage output (1-5 V)	Analog output is selected as analog voltage output.
Analog current output (4-20 mA)	Analog output is selected as analog current output.

■ Setting method

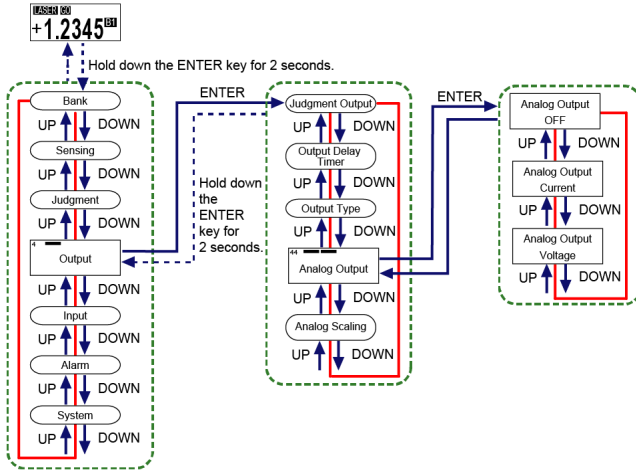

Setting item	Set value	Default value
Analog output selection (A/O.SEL)	Analog voltage output (1-5 V) Analog current output (4-20mA)	1 to 5 V

**Note**

- If output operation is an indeterminate state "-----", analog output is "1 V" when analog voltage output is set or "0 mA" when analog current output is set.
- If output operation is an alarm, analog output is "5.2 V" when analog voltage output is set or "0 mA" when analog current output is set.

**6.4.12 Menu Display Settings (MENU)**

Functions can be extended by changing the menu display settings.

Changing the menu display for extended settings display enables you to change the settings of the following functions.

Setting mode	Setting item
Advanced settings (ADVANC)	Hold settings (HOLD) Simultaneous input (ALL IN)(for master units only) External input (EXT.IN) External output (EXT.OUT) External output delay timer selection (OUT.DLY) Number of digits displayed (DIGIT) Analog scaling (ANALOG) Eco mode (ECO) Alarm settings (ALARM) Key lock function selection (KEYLOC) Interference prevention function (INTF.PR)(for master units only) Sampling cycle (SAMPLI)

## 6.4 Basic Settings (BASIC)

Setting mode	Setting item
	Reverse of measured value (REVERS)
Calculation settings (CALC)(for master units only)	Calculation mode (MODE) Calculation application selection (APPLI)
Copy settings (COPY)	Copy individual selection (CPY.SEL)(for master units only) Copy batch selection (CHK.ALL)(for master units only) Copy execution (CPY.EXE)(for master units only) Copy lock (LOCK)(for slave units only)
Bank settings (BANK)	Bank save selection (BNK.DAT)
Calibration settings (CALIB)	Calibration selection (CAL.SEL)

### Setting method

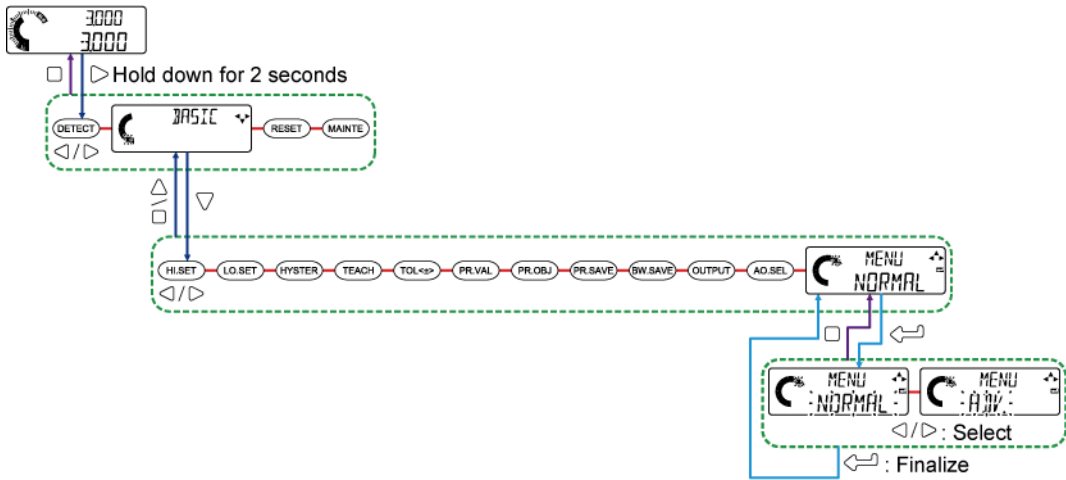

Setting item	Set value	Default value
Menu display settings (MENU)	General function display (NORMAL) Extended function display (ADV.)	NORMAL

### Note

- Turning OFF the power returns "MENU" (menu display settings) to "NORMAL" (general function display).

## 6.5 Initialization (RESET)

This function allows you to reset all the controller settings to the factory default settings. For each default value of general functions, refer to "6.2 Setting Operation List". For each default value of extended functions, refer to "7.1 Setting Operation List".

### Note

- The key operation (for the  $\Delta$  key) for returning to the setting mode selection screen also applies to the  $\square$  key.
- Reference waveform registration and calibration settings, key lock function settings, and settings stored in banks are not initialized.

### Setting method

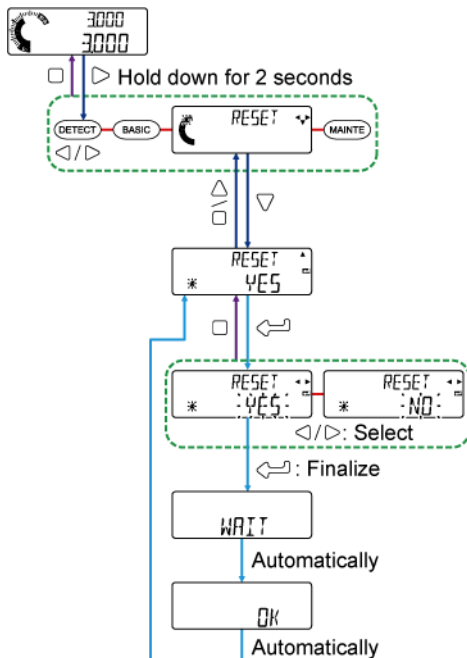

## 6.6 Maintenance (MAINTE)

### 6.6 Maintenance (MAINTE)

This function displays the cumulative operating periods for the controller and sensor head.

#### ■ Setting method

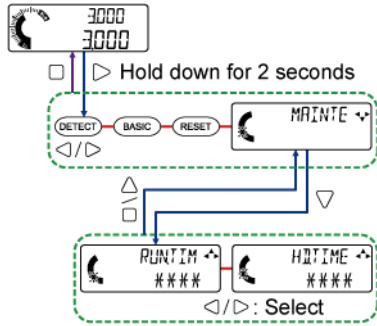

Item	Function
Cumulative operating period (RUN.TIM)	This function displays the cumulative operating period for the controller. (Units: h)
Cumulative head operating period (HD.TIME)	This function displays the cumulative operating period for the sensor head. (Units: h)

#### ■ Note

- The key operation (for the  $\Delta$  key) for returning to the setting mode selection screen also applies to the  $\square$  key.



# 7 Setting up Extended Functions

This chapter explains the functions that can be newly set up when the display menu is changed from general functions to extended functions.

7.1 Setting Operation List .....	7-2
7.2 Advanced Settings (ADVANCE) .....	7-8
7.2.1 Hold Settings (HOLD) .....	7-8
7.2.2 Simultaneous Input (ALL IN)(For Master Units Only).....	7-11
7.2.3 External Inputs (EXTIN).....	7-13
7.2.4 External Outputs (EXTOUT).....	7-15
7.2.5 External Output Delay Timer Selection (OUTDLY).....	7-23
7.2.6 Number of Digits Displayed (DIGIT).....	7-29
7.2.7 Analog Scaling (ANALOG).....	7-30
7.2.8 Eco Mode (ECO).....	7-35
7.2.9 Alarm Settings (ALARM).....	7-36
7.2.10 Key Lock Function Selection (KEYLOCK).....	7-41
7.2.11 Interference Prevention Function (INTFPR)(For Master Units Only) .....	7-42
7.2.12 Sampling Cycle (SAMPLE).....	7-44
7.2.13 Reverse of Measured Value (REVER5).....	7-45
7.3 Calculation Settings (CALC)(For Master Units Only).....	7-47
7.3.1 Calculation Mode (MODE).....	7-47
7.3.2 Calculation Application Selection (APPLI).....	7-48
7.4 Copy Settings (COPY) .....	7-53
7.4.1 Copy Individual Selection (COPYSEL)(For Master Units Only) .....	7-53
7.4.2 Copy Batch Selection (CHKALL)(For Master Units Only) .....	7-56
7.4.3 Copy Execution (COPYEXE)(For Master Units Only) .....	7-56
7.4.4 Copy Lock (LOCK)(For Slave Units Only) .....	7-57
7.5 Bank Settings (BANK).....	7-59
7.5.1 Bank Save Selection (BNKDAT).....	7-59
7.6 Calibration Settings (CALIB).....	7-61
7.6.1 Calibration Selection (CALSEL).....	7-61

## 7.1 Setting Operation List

■ **Setting mode selection**

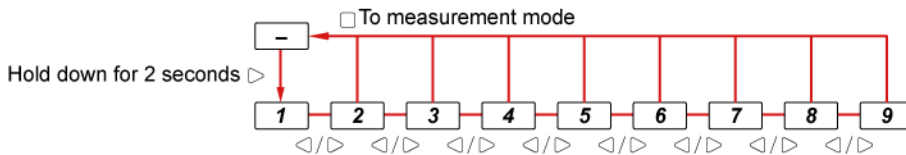

	No.	Item	Display screen	Function	Reference page
	-	Initial screen		-	-
General functions	1	Detection settings		-	-
	2	Basic settings		-	-
Extended functions	3	Advanced settings (ADVANC)		This function allows you to specify more detailed settings such as hold settings and alarm settings.	"P. 7-8"
	4	Calculation settings (for master units only) (CALC)		This function can perform calculation processing based on the measured values of the connected controllers and display the judgment results in the display section of the master unit or output them from the master unit.	"P. 7-47"
	5	Copy settings (COPY)		The settings on the master unit can be copied to the slave units connected to the master unit.	"P. 7-53"
	6	Bank settings (BANK)		This function allows you to save or load the HIGH set value, LOW set value, or other settings to/from a specified bank (1 to 3).	"P. 7-59"
	7	Calibration settings (CALIB)		This function allows you to reduce installation errors when replacing the sensor head, for example.	"P. 7-61"
General functions	8	Initialization (RESET)		-	-
	9	Maintenance (MAINTE)		-	-

**Note**

- Pressing the key in each setting mode allows you to enter a function selection item.
- For details on detection settings, basic settings, initialization, and maintenance, refer to "6 Setting up General Functions".

■ Function selection [Advanced settings]

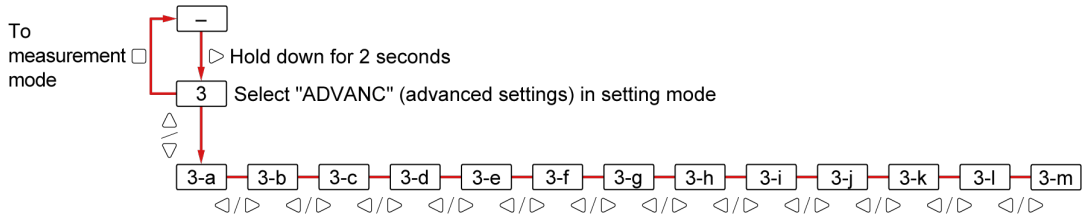

No.	Item	Display screen	Function	Reference page
-	Initial screen		-	-
3	Advanced settings		-	-
3-a	Measurement mode (MEAS)		This function allows you to select a measurement mode. <Default: S-H>	"P. 7-8"
	Trigger mode (TRG)		This function allows you to select an action for external trigger input. HOLD / 1SHOT <Default: HOLD>	"P. 7-8"
3-b	Simultaneous input (for master units only) (ALL IN)		Setting simultaneous input in a master unit causes all the slave units connected to the master unit to enter the same input signal state as the master unit. <Default: ONE>	"P. 7-11"
3-c	External input (EXT.IN)		This function allows you to select a combination of signals to be input to external input 1, input 2, and input 3 from five types. <Default: P/R/T>	"P. 7-13"
3-d	External output (EXT.OUT)		This function allows you to select a combination of signals to be output from external output 1, output 2, and output 3 from four types. <Default: 3 VAL>	"P. 7-15"
3-e	External output delay timer selection (OUT.DLY)		This function allows you to set an external output timer and external output delay timer. <Default: OFF>	"P. 7-23"
	External output delay timer setting (OD.TIME)		This function allows you to set an external output delay timer when ON.DLY (ON delay), OFF.DLY (OFF delay), or SS.DTY (single shot delay) is selected. <Default: 100>	
3-f	Number of digits displayed (DIGIT)		This function allows you to switch the number of digits after the decimal point in the digital display section. <Default: 0.001>	"P. 7-29"
3-g	Analog scaling (ANALOG)		This function allows you to set scaling for analog output.	"P. 7-30"

## 7.1 Setting Operation List

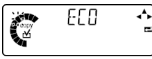
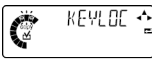
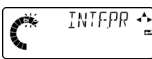
No.	Item	Display screen	Function	Reference page
	Upper limit value of scaling (ANA.HI)		<Default: DEFAULT> This function allows you to set the upper limit value for scaling when analog scaling is set to "FREE". <Default: 10.000>	"P. 7-32"
	Lower limit value of scaling (ANA.LO)		This function allows you to set the lower limit value for scaling when analog scaling is set to "FREE". <Default: 0.000>	
3-h	Eco mode (ECO)		This function allows you to turn OFF the backlight on the display unit of the controller to save electricity when the display unit is not used. <Default: OFF>	"P. 7-35"
3-i	Alarm settings (ALARM)	Alarm delay count (DELAY)	This function allows you to set the number of delays that triggers alarm output. <Default: 1000>	"P. 7-37"
		Alarm condition selection (ALM.CND)	This function allows you to select either the held condition or alarm condition of the last measured value for the judgment output and measured value at the time of measurement alarm 1 occurrence. <Default: HOLD>	"P. 7-38"
		Stain check (STA.CHK)	This function judges the influence of stain on the detection surface according to the intensity of received light and outputs measurement alarm 2. <Default: LOW>	"P. 7-38"
		Stain threshold (STA.THR)	This function allows you to set a stain threshold value when stain check is set to USER. <Default: 55>	
		Connected units count check (for master units only) (CON.CHK)	This function checks the number of connected controllers and outputs an alarm when the number of connected controllers changes. <Default: OFF>	"P. 7-39"
		Reverse insertion check (DIR.CHK)	This function outputs a measurement alarm when edge detection mode detects that the specified measurement direction differs from the insertion direction of the detected object. <Default: ON>	"P. 7-40"
3-j	Key lock function selection (KEYLOC)		This function allows you to configure settings to activate key lock automatically. <Default: MANUAL>	"P. 7-41"
3-k	Interference prevention function (for master units only) (INTF.PR)		This function allows you to install each sensor head close to each other. <Default: ON>	"P. 7-42"

No.	Item	Display screen	Function	Reference page
3-l	Sampling cycle (SAMPLI)		This function allows you to set the sampling cycle to standard sampling or high-speed sampling. <Default: HI-SPD>	"P. 7-44"
3-m	Reverse of measured value (REVERS)		This function allows you to implement a mirror inversion of the judgment value at 0 mm as its base. <Default: FWD>	"P. 7-45"

**Note**

- The key operation (for the key) for returning to the setting mode selection screen also applies to the key.

**Function selection [Calculation settings (for master units only)]**

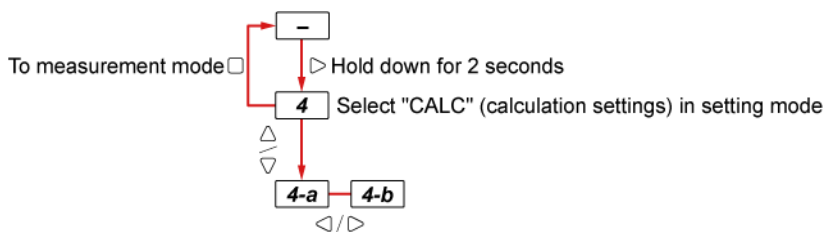

No.	Item	Display screen	Function	Reference page
-	Initial screen		-	-
4	Calculation settings (for master units only)		-	-
4-a	Calculation mode (MODE)		This function allows you to specify whether to perform calculations. <Default: NO.CALC>	"P. 7-47"
4-b	Calculation application selection (APPLI)		This function allows you to set calculation application selection when calculation mode is set to "CALC". You can select an application to be used for calculation. <Default: MAX>	"P. 7-48"

**Note**

- The key operation (for the key) for returning to the setting mode selection screen also applies to the key.

## 7.1 Setting Operation List

### ■ Function selection [Copy settings]

#### Master unit

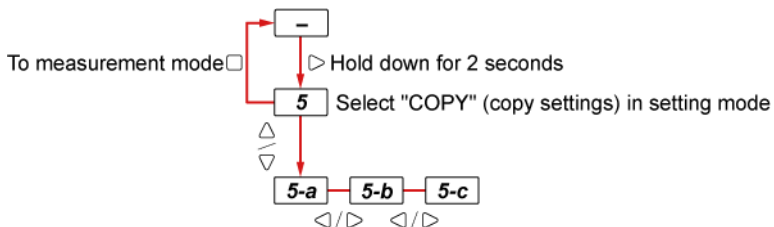

#### Slave unit

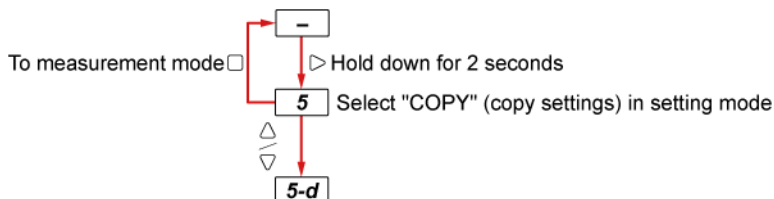

No.	Item	Display screen	Function	Reference page
-	Initial screen		-	-
5	Copy settings		-	-
5-a	Copy individual selection (for master units only) (CPY.SEL)		This function allows you to select copy target items individually and copy them from the master unit to a slave unit.	"P. 7-53"
5-b	Copy batch selection (for master units only) (CHK.ALL)		This function allows you to select all copy target items at the same time. <Default: YES>	"P. 7-56"
5-c	Copy execution (for master units only) (CPY.EXE)		This function allows you to copy the settings of copy individual selection or copy batch selection from the master unit to a slave unit. <Default: YES>	"P. 7-56"
5-d	Copy lock (for slave units only) (LOCK)		This function allows you to prohibit copying from the master unit. <Default: OFF>	"P. 7-57"

#### Note

- The key operation (for the key) for returning to the setting mode selection screen also applies to the  key.

■ Function selection [Bank settings]

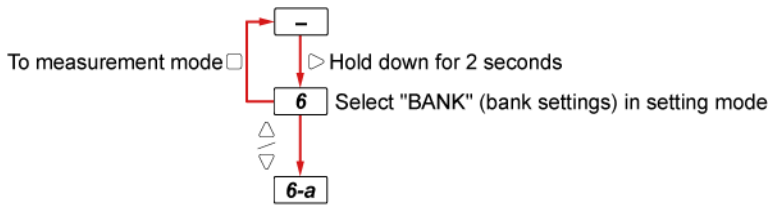

No.	Item	Display screen	Function	Reference page
-	Initial screen		-	-
6	Bank settings		-	-
6-a	Bank save selection (BNK.DAT)		This function allows you to select the settings stored in the bank when loading them. <Default: THRS>	"P. 7-59"

**Note**

- The key operation (for the  $\triangle$  key) for returning to the setting mode selection screen also applies to the  $\square$  key.

■ Function selection [Calibration settings]

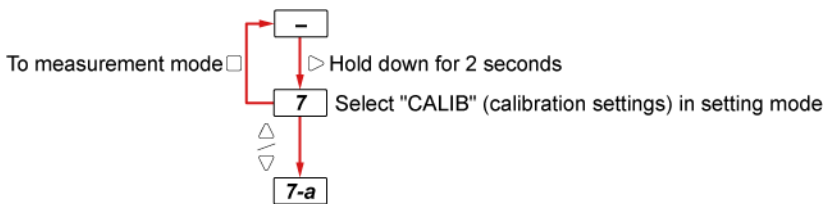

No.	Item	Display screen	Function	Reference page
-	Initial screen		-	-
7	Calibration settings		-	-
7-a	Calibration selection (CAL.SEL)		This function allows you to select a setting method for calibration. <Default: DEFAULT>	"P. 7-61"

**Note**

- The key operation (for the  $\triangle$  key) for returning to the setting mode selection screen also applies to the  $\square$  key.

## 7.2 Advanced Settings (ADVANCE)

### 7.2 Advanced Settings (ADVANCE)

#### 7.2.1 Hold Settings (HOLD)

This function sets the method for holding a judgment value (JUDGE.V).

To output normal measured values in real time, set the measurement mode to sample hold "S-H" and leave external inputs turned OFF.

### Measurement mode function (MEAS)

This function allows you to select a judgment value holding method from the following six types of measurement mode.

Measurement mode(MEAS)	Function	Reference page
Sample hold (S-H)	This function holds and outputs the judgment value (JUDGE.V) only when external input is ON. When external input is OFF, the judgment value (JUDGE.V) is updated as necessary before being output. (Real-time output)	"P.8-2"
peak hold(P-H)	When external input is turned ON, the maximum value during the sampling period is held and output as the judgment value (JUDGE.V). When external input is turned OFF, the maximum value during the sampling period is continuously updated.	"P.8-8"
Bottom hold (B-H)	When external input is turned ON, the minimum value during the sampling period is held and output as the judgment value (JUDGE.V). When external input is turned OFF, the minimum value during the sampling period is continuously updated.	"P.8-9"
Peak-to-peak hold (P-P)	The difference between the maximum value (top) and minimum value (bottom) is held and output as the judgment value (JUDGE.V).	"P.8-10"
NG hold (NG-H)	This function holds LOW judgment and HIGH judgment output.	"P.8-3"
Tab cancellation (hold) (TB.CNCL)	When the amount of change in the judgment value exceeds the tab judgment threshold specified as desired, the judgment value is held and output. After the change has settled, hold is released after a certain period of time.	"P.8-11"

### Reset input

When a reset signal is input, this function resets the measured values, judgment values, and other values that have been stored.

#### Note

- If the calculation application selection function is set to "STAND" (standard difference), the hold settings of the master unit will be cleared.
- Depending on the settings of the calculation application selection function, the hold settings of the slave unit that are used for calculation will be cleared.



## External trigger input

This section explains how to hold judgment values using external trigger input. You can select from two types: hold and one-shot.

### ■ Hold

If external trigger input turns ON, this function holds the judgment value (JUDGE.V) while the input is ON.

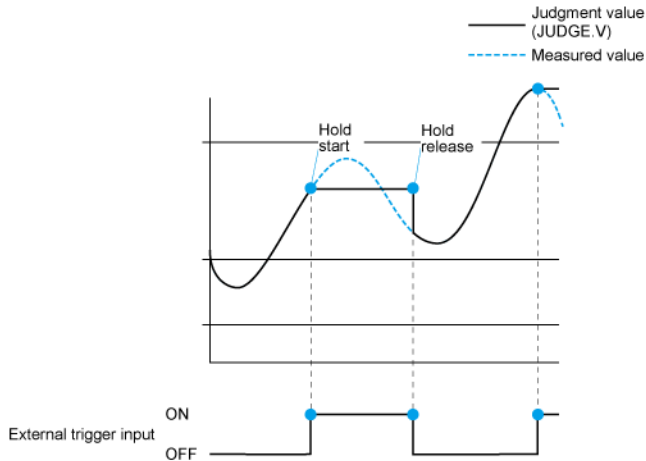

### ■ One-shot

Each time external trigger input turns ON (a rising edge is reached), this function updates and holds the judgment value (JUDGE.V).

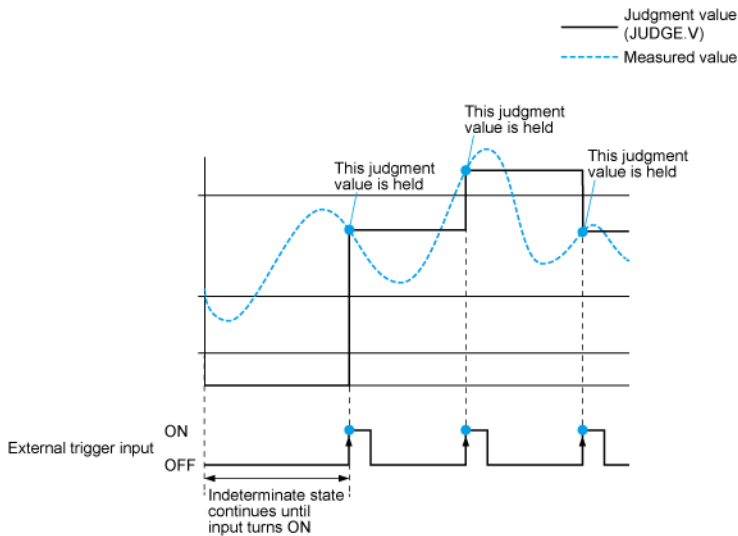

## 7.2 Advanced Settings (ADVANCE)

### ■ Notes on reset input

#### Note

- If reset input is used, the following respective behaviors occur when external trigger input is not used, when hold is selected for external trigger input, and one-shot is selected for external trigger input.

#### When external trigger input is not used

When a reset signal is input, an indeterminate state occurs for the length of time equivalent to the average count (response time).

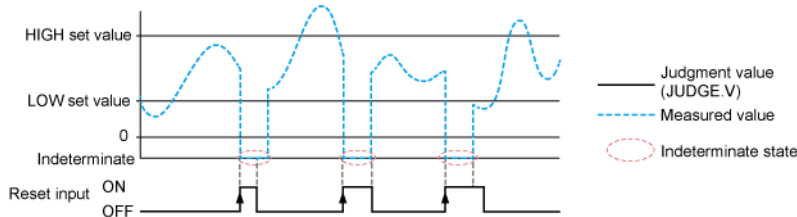

#### When external trigger input is set to hold

If a reset signal is input when trigger input is ON, an indeterminate state occurs and judgment output is held. The indeterminate state is retained until trigger input turns OFF.

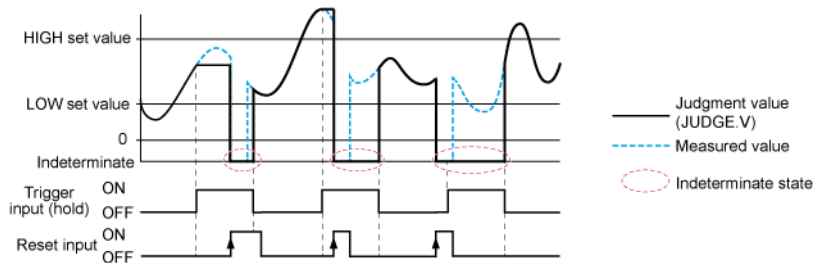

#### When external trigger input is set to one-shot

If a reset signal is input with the judgment output held, an indeterminate state occurs and the judgment output remains held. The indeterminate state is retained until the next trigger input occurs.

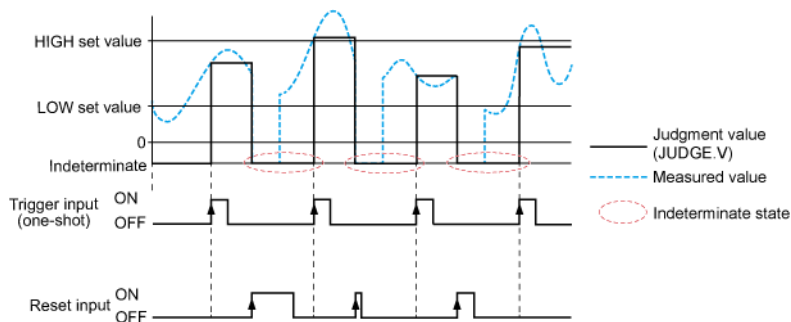

For details on how to use external trigger input, refer to "7.2.3 External Inputs (EXT. I/O)".

Setting method

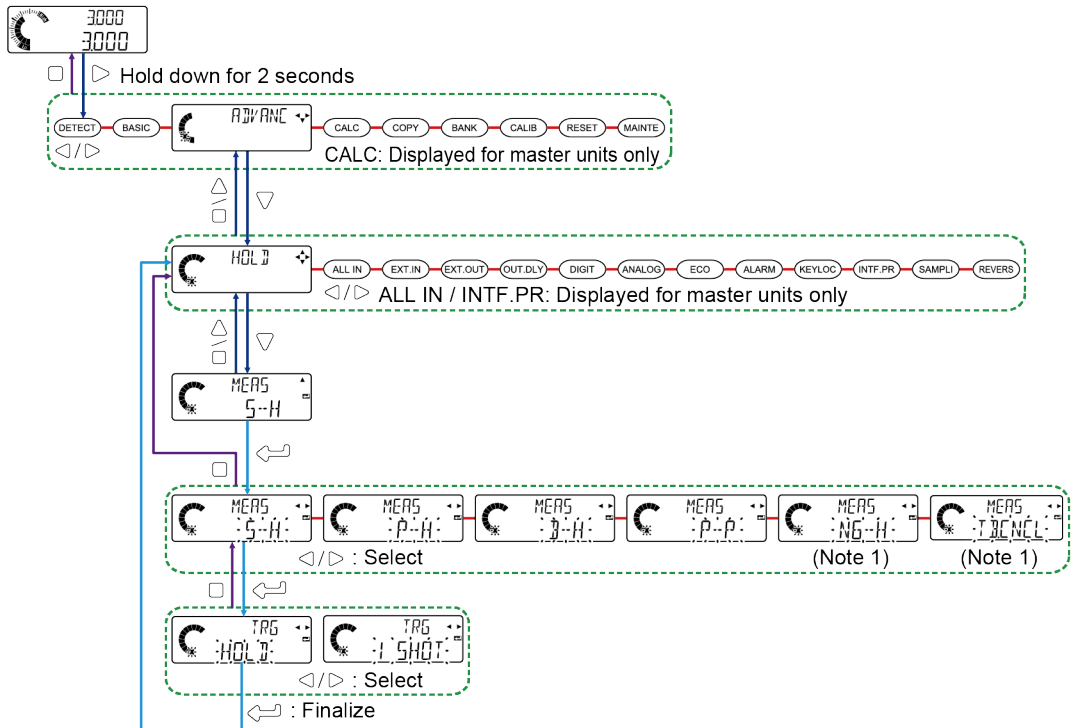

(Note 1) When either the NG hold or tab cancellation mode is selected, no settings are available for the trigger mode (TRG).

Setting item	Set value	Default value
Hold settings (HOLD)	Sample hold (S-H) Peak hold (P-H) Bottom hold (B-H) Peak-to-peak hold (P-P) NG hold (NG-H) Tab cancellation (TB.CNCL)	S-H
Trigger mode (TRG)	Hold (HOLD) 1 Shot (1SHOT)	HOLD

**Note**

- When the tab cancellation mode is selected, settings are different. For details, refer to "8.6.2 Setting up the Function".

7.2.2 Simultaneous Input (ALL IN)(For Master Units Only)

Setting simultaneous input in a master unit has all the slave units connected to the master unit receive the same input signal as the master unit and perform behaviors according to the input settings of the master unit.

## 7.2 Advanced Settings (ADVANCE)

Simultaneous input	Function
Standalone (ONE)	External inputs for the master unit and slave units are performed separately. Slave units input external signals according to the settings of external input.
Simultaneous (ALL) <sup>(Note 1)</sup>	When the master unit receives an input, all the slave units connected to the master unit also receive the same input. The external input signal state of the master unit is reflected in the slave units, regardless of the external input signal state of each slave unit.

(Note 1) If simultaneous input is set, the minimum input time for trigger input is 3 ms or more.

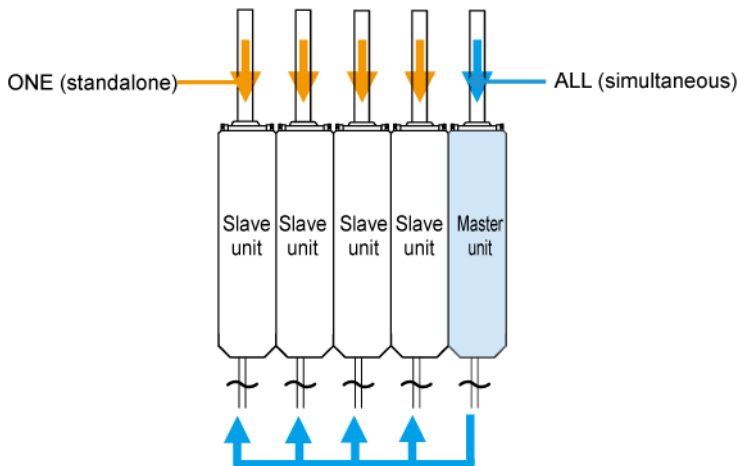

### Note

- Simultaneous input can only be set for master units connected to slave units.

### Setting method

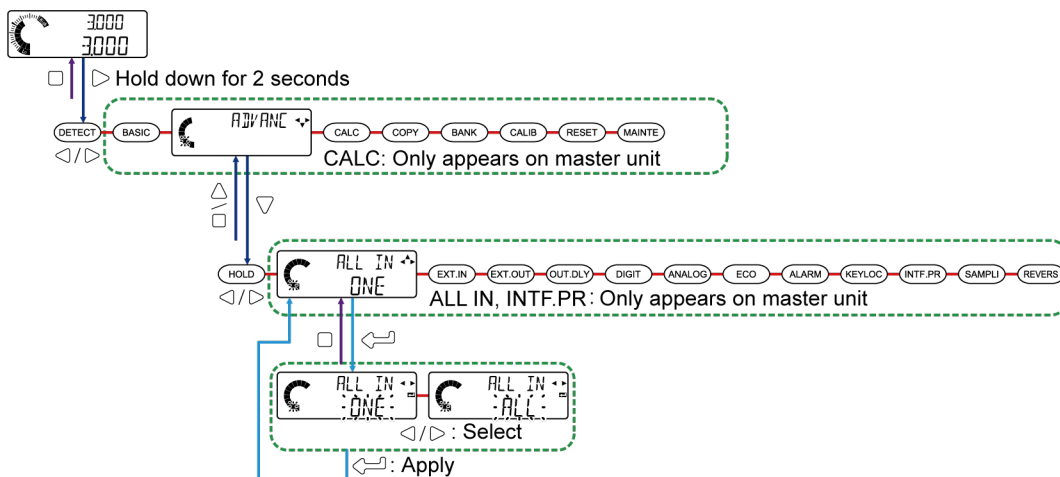

Setting item	Set value	Default value
Input all (ALL IN)	Standalone (ONE) Simultaneous (ALL)	ONE

### 7.2.3 External Inputs (EXT.IN)

This function allows you to select a combination of signals to be input to external input 1, input 2, and input 3 from five types.

#### Preset

You can perform zero-point adjustment and shift to any preset value.

For details, refer to "5.5.2 Preset".

#### Reset

When a reset signal is input, measured values, calculated values, and other values are reset.

For details on how to use hold, refer to "7.2.1 Hold Settings (HOLD Ⓜ)".

#### Trigger

If a trigger signal is input, the judgment value (JUDGE.V) is held while the signal is being input.

For details, refer to "7.2.1 Hold Settings (HOLD Ⓜ)".

#### Bank A / B

The contents of each bank can be read by combining bank A input and bank B input.

For details on how to combine the inputs of each bank, refer to "5.5.3 Saving and Loading Settings to / from Banks".

#### Laser emission stop

While a laser emission stop signal is being input, laser radiation is stopped.

External input setting combinations are shown below.

External input	Input signal combinations		
	Input 1 (Pink)	Input 2 (Purple)	Input 3 (Pink / Purple)
Preset / Reset / Trigger (P/R/T)	Preset	Reset	Trigger
Bank A / Bank B / Preset (BANK/P)	Bank A	Bank B	Preset
Bank A / Bank B / Reset (BANK/R)	Bank A	Bank B	Reset
Bank A / Bank B / Trigger (BANK/T)	Bank A	Bank B	Trigger
Preset / Trigger / Laser emission stop (P/T/L)	Preset	Trigger	Laser emission stop

#### ■ Minimum input time

The minimum input time and standby time differ according to the input type.

#### Preset input

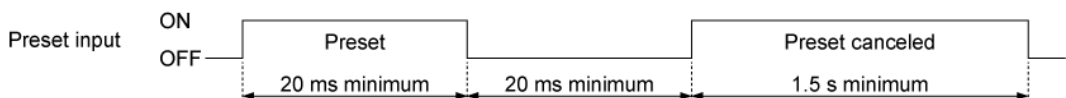

#### Reset input

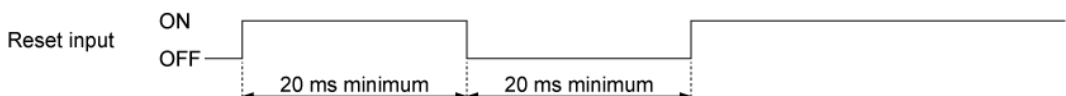

## 7.2 Advanced Settings (ADVANCE)

### Trigger input



### Bank A input / Bank B input

#### When bank 1 or bank 2 is used

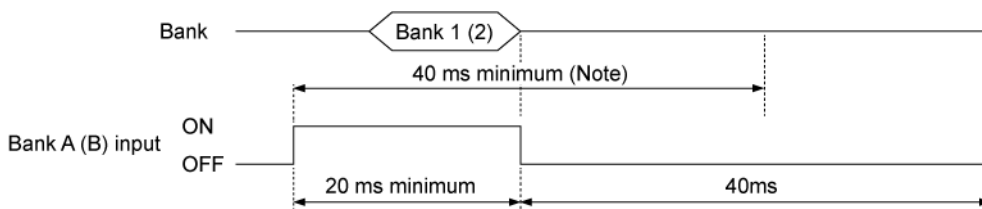

(Note 1) The minimum input time is 90 ms when "BNK.DAT" (bank save selection) is set to "ALL".

#### When bank 3 is used

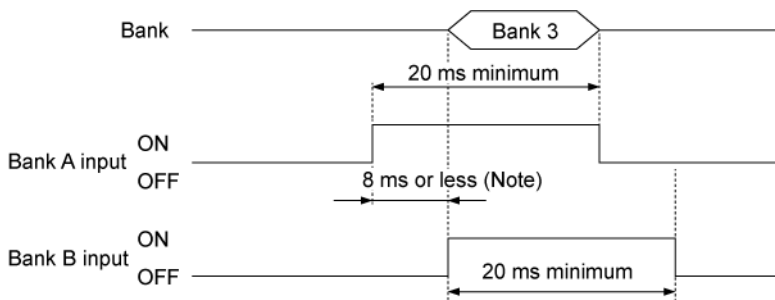

(Note 1) If the start of bank A input or bank B input is delayed by 8 ms or more, the content of bank 3 may be read after read processing for the input signal that is input earlier is executed.

### Laser emission stop input

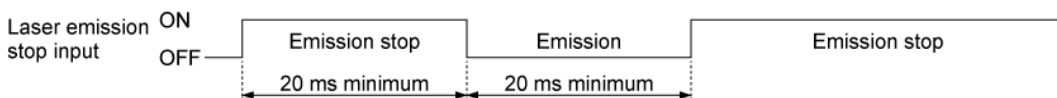

(Note 1) The laser radiation indicator (green) of the sensor head emitter remains unlit while a laser emission stop signal is being input.

If beam axis adjustment mode is invoked with the laser emission stop signal set to ON, "E510" will be displayed in the digital display section of the controller.

While laser emission remains stopped, "....." is displayed indicating an indeterminate state.

### Note

- For I/O circuit diagrams for controllers, refer to "9.1.1 Controller".
- For details on simultaneous input (ALL IN)(For Master Units Only)".

■ Setting method

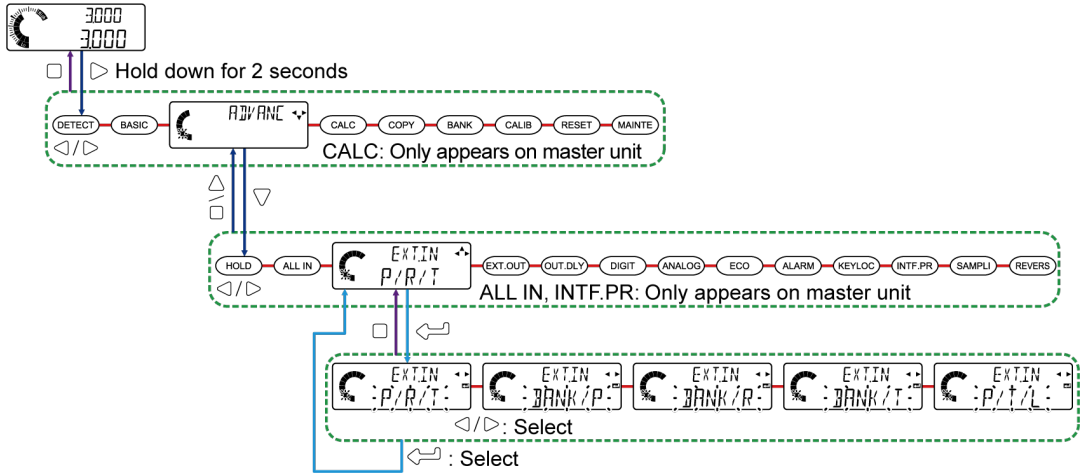

Setting item	Set value	Default value
External input (EXT.IN)	Preset / Reset / Trigger (P/R/T) Bank A / Bank B / Preset (BANK/P) Bank A / Bank B / Reset (BANK/R) Bank A / Bank B / Trigger (BANK/T) Preset / Trigger / Laser emission stop (P/T/L)	P/R/T

7.2.4 External Outputs (EXT.OUT)

This function allows you to select a combination of signals to be output from external output 1, output 2, and output 3 from five types. This product is equipped with an alarm signal output function. When the sensor head does not operate correctly, alarm signals enable you to take prompt action. It is also equipped with a signal (hold output) that allows you to check the hold status. Therefore, hold operation status can be grasped in real time.

Set value	Display	Function
3-value		This function uses OUT1, OUT2, and OUT3 to control ON / OFF according to the judgment value.
2-value		This function uses OUT1 and OUT2 to control ON / OFF according to the judgment value. OUT3 is used to control ON / OFF when an alarm (error) occurs.
Logic		This function uses OUT1 and OUT2 to control ON / OFF as logical value representation according to the judgment value. OUT3 is used to control ON / OFF when an alarm (error) occurs.
Logic 2		OUT1 is used to control ON / OFF when all the connected controllers are in GO state. OUT2 is used to control ON / OFF when the master unit is in GO state. OUT3 is used to control ON / OFF when an alarm (error) occurs on any of the connected controllers.

## 7.2 Advanced Settings (ADVANCE)

Set value	Display	Function
Hold		OUT1: Used to turn the output ON/OFF depending on the hold status. OUT2: Used to control ON/OFF when the unit is in GO state. OUT3: Used to control ON/OFF when an alarm (error) occurs.

### Note

- You must set judgment output operation to N.O. or N.C. For details, refer to "6.4.10 Output Operation (OUTPUT)". Default: N.O. (Normally Open)
- For each alarm output when external output is set to "2-value", "Logic", or "Logic 2", output operation is "Normally Closed" (N.C.) regardless of the set value of output operation.
- Alarm output is generated when an error or alarm occurs.

For details on errors, refer to "11.2 Error Messages".

Alarms are classified into measurement alarm 1 and measurement alarm 2.

Alarm type	Description	Measured value	Judgment output
Measurement alarm 1	This alarm occurs when the intensity of received light is saturated due to ambient light or when an edge exceeding the measurement capability occurs.	Previous value or ALARM (optional)	Judgment output based on the previous value or alarm output (optional)
Measurement alarm 2	This alarm occurs when stain check is activated.	Measured value	Alarm output

For details on how to set an alarm, refer to "7.2.9 Alarm Settings (ALARM)".



3-value

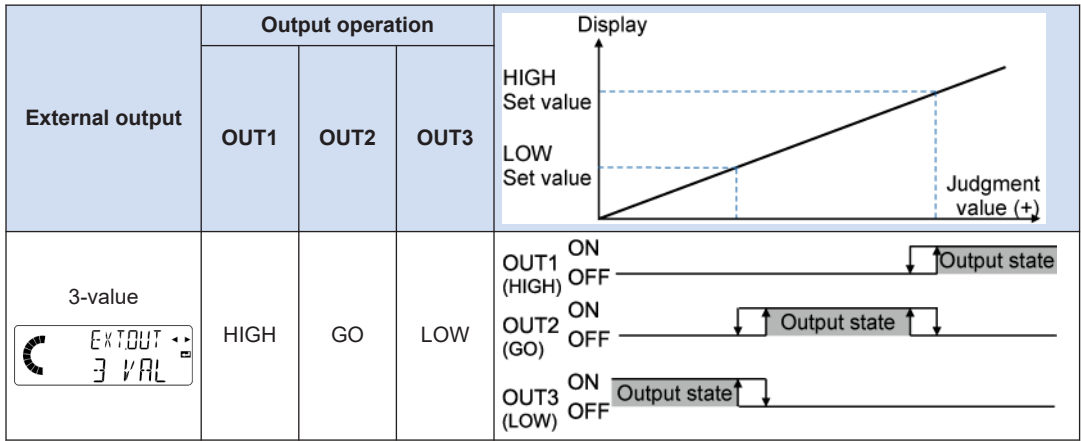

When N.O. is set

Output operation		Indeterminate	Below the lower limit of measurement range	Within GO range	Above the upper limit of measurement range	Alarm
Output 1	HIGH	OFF	OFF	OFF	ON	ON
Output 2	GO	OFF	OFF	ON	OFF	OFF
Output 3	LOW	OFF	ON	OFF	OFF	ON

When N.C. is set

Output operation		Indeterminate	Below the lower limit of measurement range	Within GO range	Above the upper limit of measurement range	Alarm
Output 1	HIGH	ON	ON	ON	OFF	OFF
Output 2	GO	ON	ON	OFF	ON	ON
Output 3	LOW	ON	OFF	ON	ON	OFF

3-value output does not have alarm-specific output. Judgments can be made according to the logical judgment of 3-value.

## 7.2 Advanced Settings (ADV/ANL)

### 2-value

External output	Output operation			
	OUT1	OUT2	OUT3	
2-value 	HIGH / LOW	GO	Alarm	

#### When N.O. is set

Output operation		Indeterminate	Below the lower limit of measurement range	Within GO range	Above the upper limit of measurement range	Alarm
Output 1	HIGH/LOW	OFF	ON	OFF	ON	ON
Output 2	GO	OFF	OFF	ON	OFF	OFF
Output 3	Alarm	ON	ON	ON	ON	OFF

#### When N.C. is set

Output operation		Indeterminate	Below the lower limit of measurement range	Within GO range	Above the upper limit of measurement range	Alarm
Output 1	HIGH / LOW	ON	OFF	ON	OFF	OFF
Output 2	GO	ON	ON	OFF	ON	ON
Output 3	Alarm	ON	ON	ON	ON	OFF

2-value output has alarm-specific output.

Logic

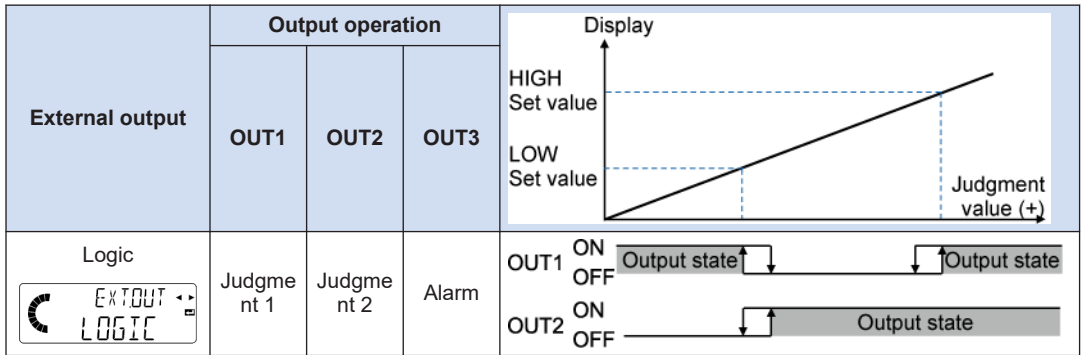

When N.O. is set

Output operation		Indeterminate	Below the lower limit of measurement range	Within GO range	Above the upper limit of measurement range	Alarm
Output 1	Judgment 1	OFF	ON	OFF	ON	ON
Output 2	Judgment 2	OFF	OFF	ON	ON	ON
Output 3	Alarm	ON	ON	ON	ON	OFF

When N.C. is set

Output operation		Indeterminate	Below the lower limit of measurement range	Within GO range	Above the upper limit of measurement range	Alarm
Output 1	Judgment 1	ON	OFF	ON	OFF	OFF
Output 2	Judgment 2	ON	ON	OFF	OFF	OFF
Output 3	Alarm	ON	ON	ON	ON	OFF

Logical output has alarm-specific output. (Output 3) Furthermore, logical output makes LOW/HIGH identifiable in logical operation of judgment 1 and judgment 2.

## 7.2 Advanced Settings (ADVANCE)

### Logic 2

External output	Output operation			
	OUT1	OUT2	OUT3	
Logic 2 	ALL GO (All connected controllers)	GO (Master unit)	Alarm (Any of connected controllers)	

#### When N.O. is set

Output operation		Indeterminate	Below the lower limit of measurement range	Within GO range	Above the upper limit of measurement range	Alarm
Output 1	ALL GO	OFF	OFF	ON <sup>(Note 1)</sup>	OFF	OFF
Output 2	GO	OFF	OFF	ON <sup>(Note 2)</sup>	OFF	OFF
Output 3	Alarm	ON	ON	ON	ON	OFF <sup>(Note 3)</sup>

(Note 1) Turns ON when all the connected controllers are in GO state.

(Note 2) Turns ON when the master unit is in GO state.

(Note 3) Turns OFF when an alarm (error) occurs on any of the connected controllers.

#### When N.C. is set

Output operation		Indeterminate	Below the lower limit of measurement range	Within GO range	Above the upper limit of measurement range	Alarm
Output 1	ALL GO	ON	ON	OFF <sup>(Note 1)</sup>	ON	ON
Output 2	GO	ON	ON	OFF <sup>(Note 2)</sup>	ON	ON
Output 3	Alarm	ON	ON	ON <sup>(Note 3)</sup>	ON	OFF <sup>(Note 3)</sup>

(Note 1) Turns OFF when all the connected controllers are in GO state.

(Note 2) Turns OFF when the master unit is in GO state.

(Note 3) Turns OFF when an alarm (error) occurs on any of the connected controllers.

When hold is set

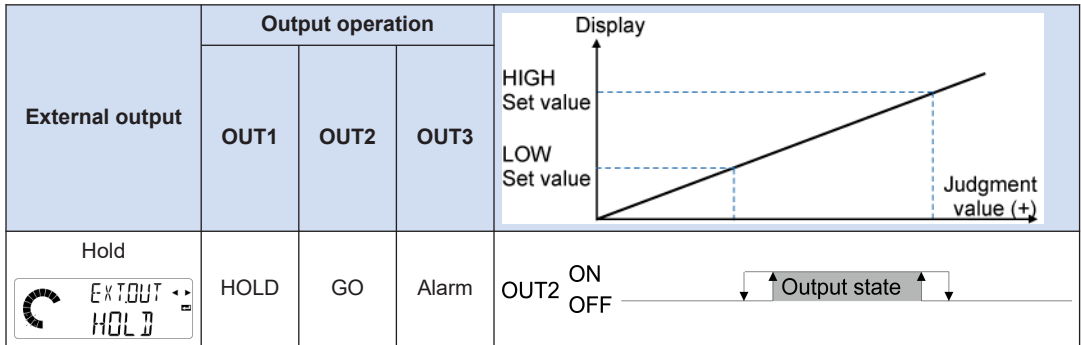

When N.O. is set

Output operation		Indeterminate	Below the lower limit of measurement range	Within GO range	Above the upper limit of measurement range	Alarm occurrence
Output 1	HOLD	Output differs according to the settings of the measurement mode. Refer to the content of HOLD (Output 1) based on the measurement mode.				
Output 2	GO	OFF	OFF	ON	OFF	OFF
Output 3	Alarm	ON	ON	ON	ON	OFF

When N.C. is set

Output operation		Indeterminate	Below the lower limit of measurement range	Within GO range	Above the upper limit of measurement range	Alarm occurrence
Output 1	HOLD	Output differs according to the settings of the measurement mode. Refer to "Contents of HOLD (Output 1) based on the measurement mode".				
Output 2	GO	ON	ON	OFF	ON	ON
Output 3	Alarm	ON	ON	ON	ON	OFF

■ Contents of HOLD (Output 1) based on the measurement

HOLD (Output 1) is output as shown below.

Output operation table

Hold type	Hold action: When N.O. is set		Hold action: When N.C. is set	
	While held	While unheld	While held	While unheld
Sample hold (Note 2)	ON	OFF	OFF	ON
Peak hold	ON	ON	OFF	OFF

## 7.2 Advanced Settings (ADV/ANL)

Hold type	Hold action: When N.O. is set		Hold action: When N.C. is set	
	While held	While unheld	While held	While unheld
Bottom hold	ON	ON	OFF	OFF
Peak-to-peak hold	ON	ON	OFF	OFF
NG hold	ON	OFF	OFF	ON
Tab cancellation	ON	OFF	OFF	ON

- (Note 1) If "STAND" (standard difference) for the calculation function is selected for the master unit or a setting other than "STAND" (standard difference) is selected for each slave unit, judgment values will remain unheld at all times.
- (Note 2) If "1SHOT" (one-shot) is selected for external trigger input, judgment values will remain held at all times.
- (Note 3) The "HOLD" status mark lights up and goes out in the same way as shown in "Hold action: When N.O. is set" in the table above.

### Note

#### • Output 1 / 2 / 3 indicator operations

ON / OFF operations of output 1, output 2, and output 3 indicators are interlocked with output operation ON / OFF. (When output turns ON, the corresponding indicator lights up.)

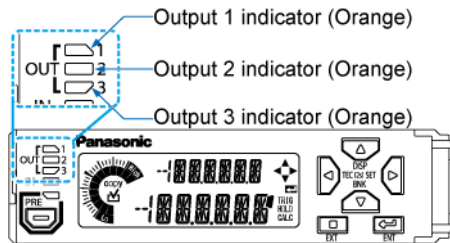

	3-value	2-value	Logic	Logic 2	Hold
Output 1 indicator	HIGH	HIGH / LOW	Judgment 1	ALL GO	HOLD
Output 2 indicator	GO	GO	Judgment 2	GO	GO
Output 3 indicator	LOW	Alarm	Alarm	Alarm	Alarm

■ Setting method

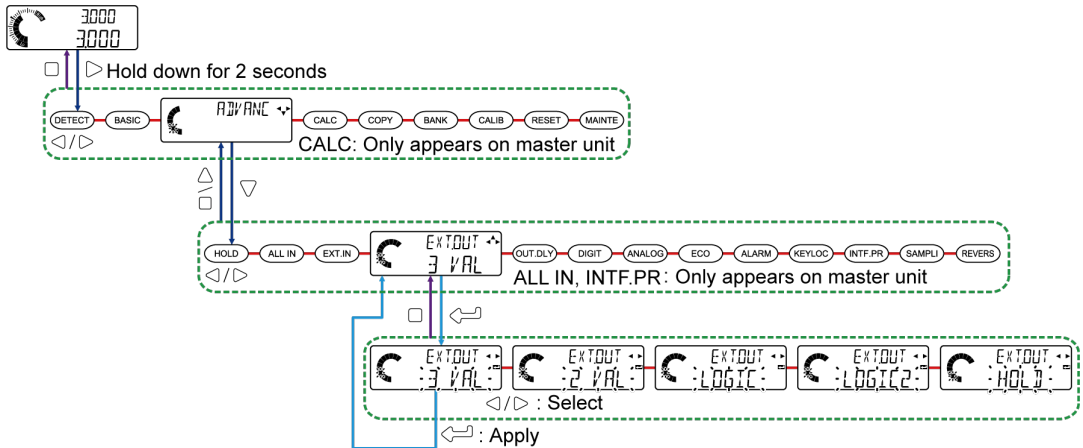

Setting item	Set value	Default value
External output (EXT.OUT)	3-value (3 VAL) 2-value (2 VAL) Logic (LOGIC) Logic 2 (LOGIC2) Hold (HOLD)	3 VAL

7.2.5 External Output Delay Timer Selection (OUT.DLY)

This function allows you to set an external output timer and external output delay timer.

Simultaneous input	Function
No timer (OFF)	The timer is set to OFF.
ON delay (ON.DLY)	The behavior required for GO judgment output of external output to change from OFF to ON is delayed by the time set in the external output delay timer. (External output delay timer: 1 to 9,999 ms)
OFF delay (OFF.DLY)	The behavior required for GO judgment output of external output to change from ON to OFF is delayed by the time set in the external output delay timer. (External output delay timer: 1 to 9,999 ms)
Single shot delay (SS.DTY)	When GO judgment output of external output turns ON, GO judgment output is forcibly turned OFF after the time set in the external output delay timer has elapsed. (External output delay timer: 1 to 9,999 ms)

**Note**

- This function is enabled only when output operation is GO or ALL GO.

■ External output

Set value	3-value	2-value	Logic	Logic 2	Hold
External output delay timer selection	Enabled	Enabled	Disabled	Enabled	Enabled

## 7.2 Advanced Settings (ADVANCE)

### Note

- When "EXT.OUT" (external output) is set to "LOGIC", "OUT.DLY" (external output delay timer selection) is disabled.
- For details on external output, refer to "7.2.4 External Outputs (EXT.OUT)".

### No timer (OFF)

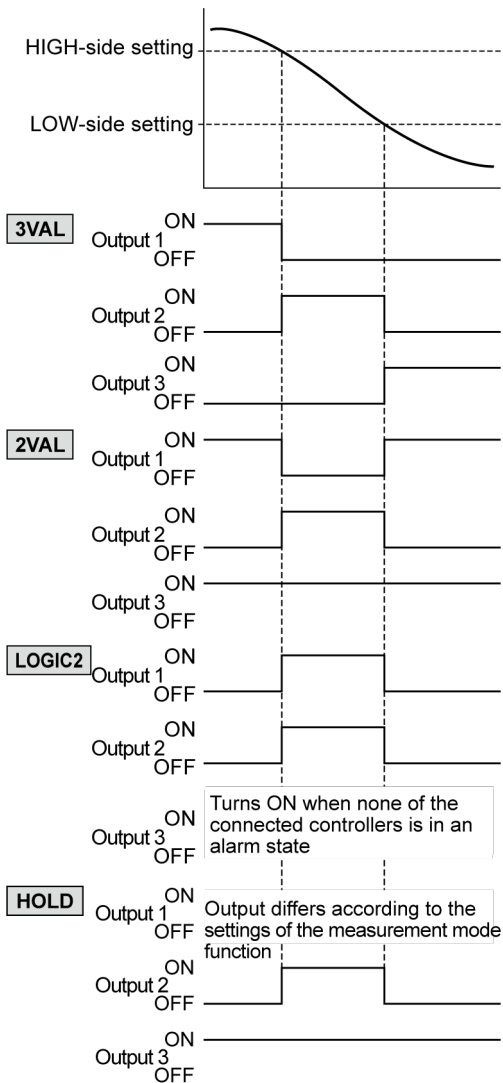



■ ON delay (ON.DLY)

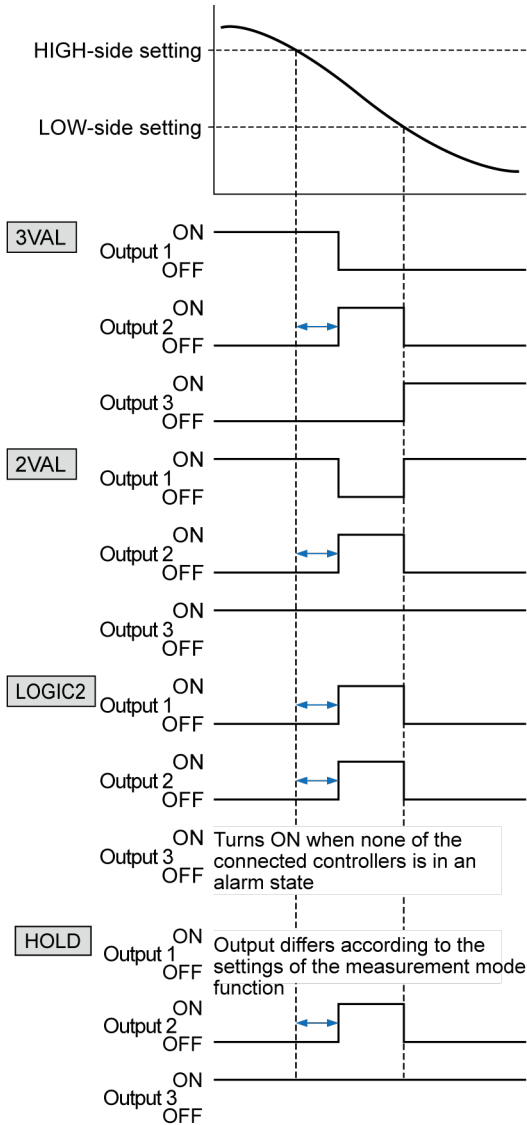

(Note 1) The arrows (  $\longleftrightarrow$  ) shown in the above figure indicate the time set in the external output delay timer.

## 7.2 Advanced Settings (ADVANCE)

### ■ OFF delay (OFF.DLY)

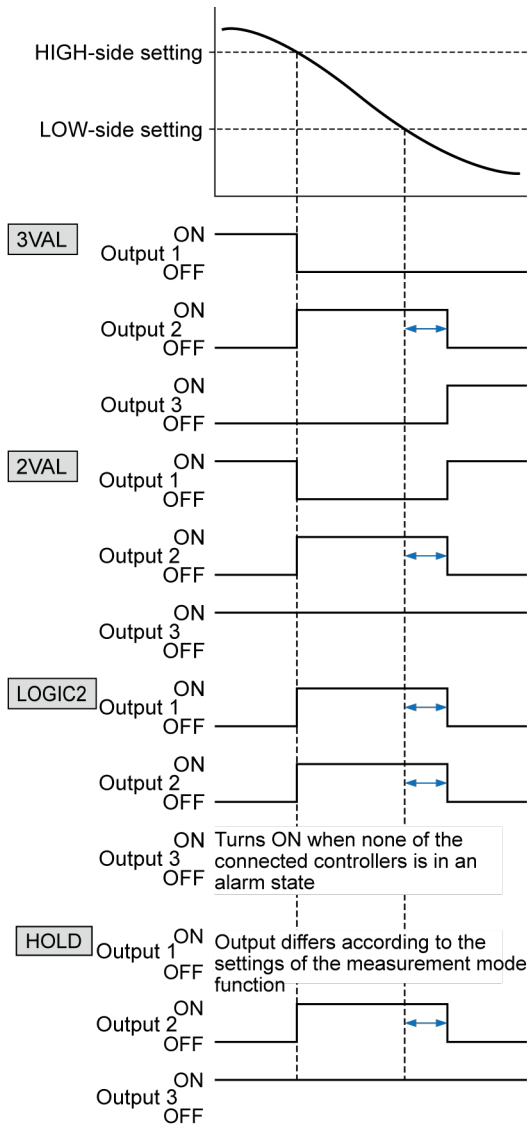

(Note 1) The arrows (  $\longleftrightarrow$  ) shown in the above figure indicate the time set in the external output delay timer.

■ Single shot delay (SS.DTY)

When the external output delay timer setting is shorter than the elapsed time of GO judgment output

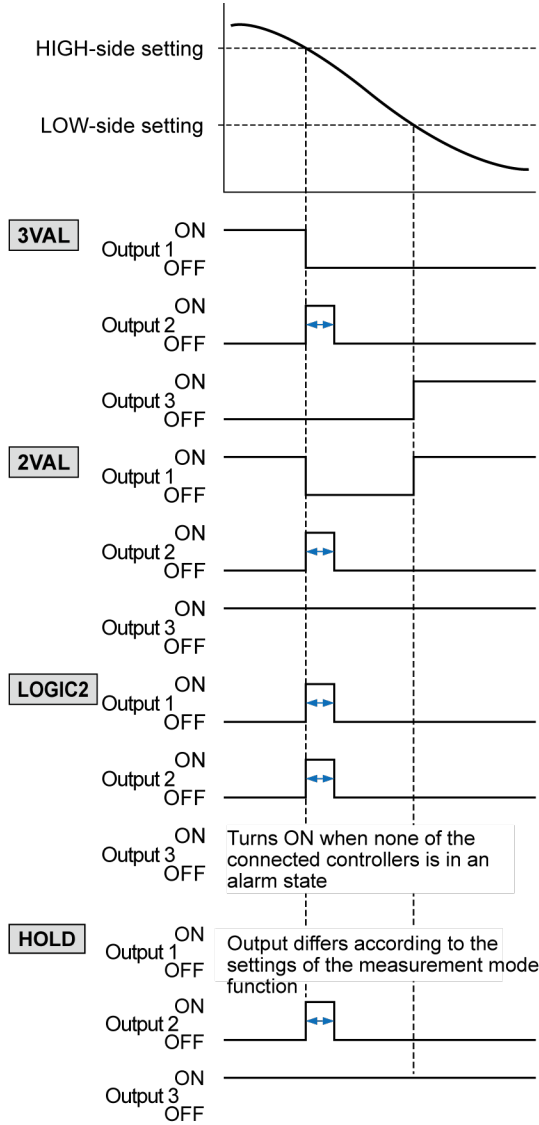

(Note 1) The arrows (  $\longleftrightarrow$  ) shown in the above figure indicate the time set in the external output delay timer.

## 7.2 Advanced Settings (ADVANCE)

**When the external output delay timer setting is longer than the elapsed time of GO judgment output**

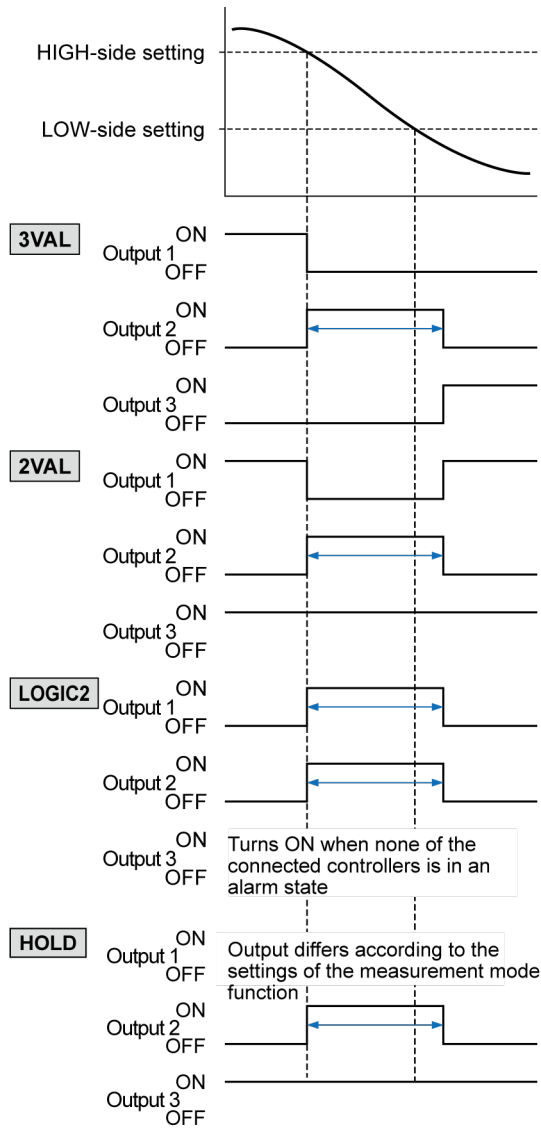

(Note 1) The arrows (  $\longleftrightarrow$  ) shown in the above figure indicate the time set in the external output delay timer.

■ Setting method

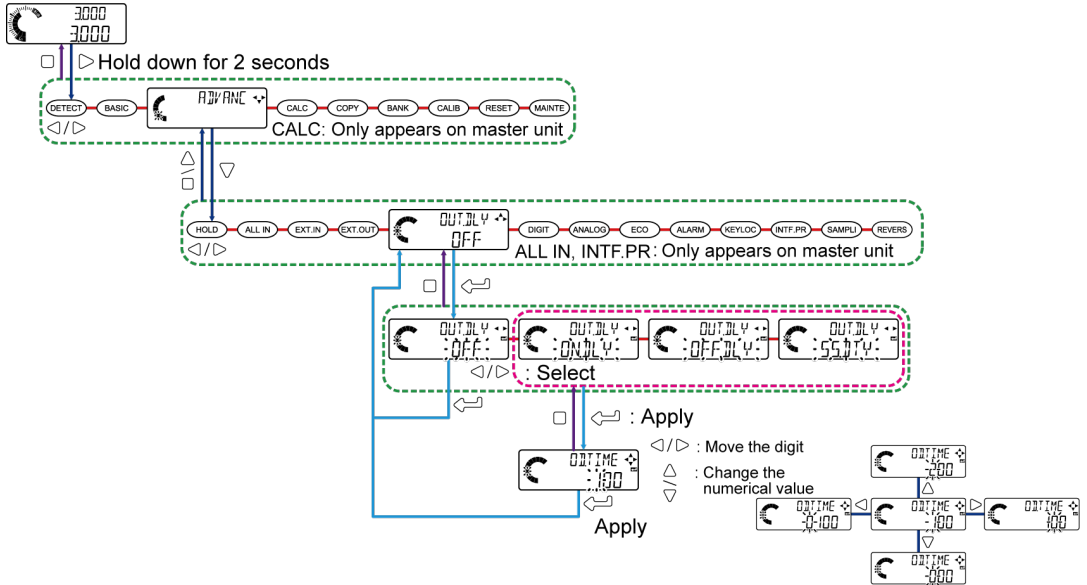

Setting item	Set value	Default value
External output delay timer selection (OUT.DLY)	No timer (OFF) ON delay (ON.DLY) OFF delay (OFF.DLY) Single shot delay (SS.DLY)	OFF
External output delay timer setting (OD.TIME)	1 to 9999 (ms)	100

7.2.6 Number of Digits Displayed (DIGIT)

This function allows you to switch the number of digits after the decimal point in the digital display section.

Three digits after the decimal point

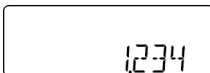

Two digits after the decimal point

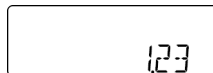

One digit after the decimal point

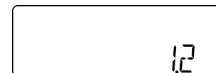

**Note**

- Digital numbers are displayed right-justified, regardless of the specified number of digits displayed.
- Any numbers after the specified number of digits displayed are displayed in rounddown calculations.

## 7.2 Advanced Settings (ADVANCE)

### ■ Setting method

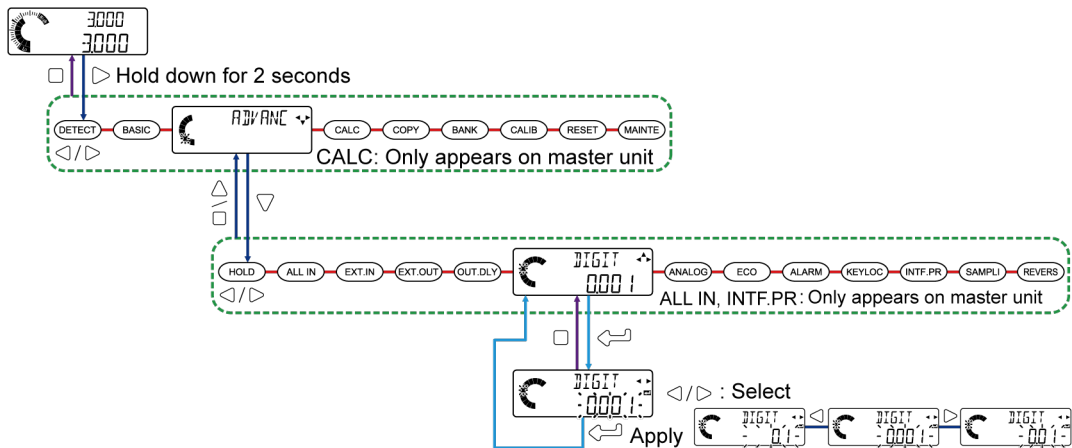

Setting item	Set value	Default value
Number of digits displayed (DIGIT)	Three digits after the decimal place (0.001) Two digits after the decimal place (0.01) One digit after the decimal place (0.1)	0.001

### ■ Note

- Changing the number of digits displayed has no influence on judgment output and measured values loaded through communication.

## 7.2.7 Analog Scaling (ANALOG)

This function allows you to select default (DEFAULT) or free (FREE) for scaling of analog output. If you set free (FREE), you can select the method for setting the upper and lower limit values for scaling of analog output.

Analog scaling	Function
Default (DEFAULT)	Analog current is output according to the maximum measurement width of the sensor head.
Free (FREE)	The upper and lower limit values of analog output can be set to any desired values. For details on how to set the upper and lower limit values, refer to " <a href="#">Upper and lower limit values for scaling (ANALHI / ANALO)</a> ".

### ■ When "DEFAULT" (default) is set

The upper limit value is the maximum measurement width of the sensor head to be used.  
The lower limit value is "0.000", regardless of the sensor head.

Analog voltage output

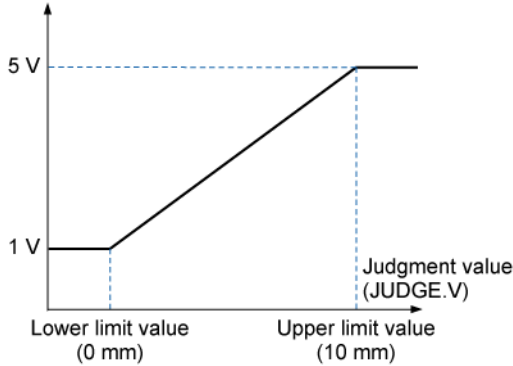

Analog current output

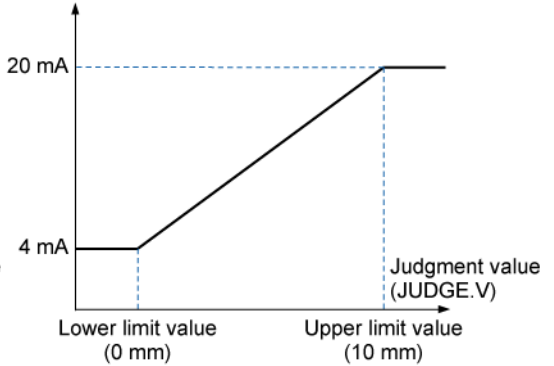

■ When "FREE" (free) is set

For details on how to set the upper and lower limit values, refer to "6.6.8 Upper and lower limit values for scaling".

Analog current output

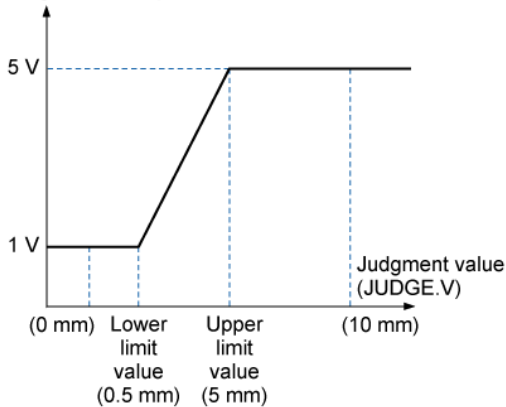

Analog current output

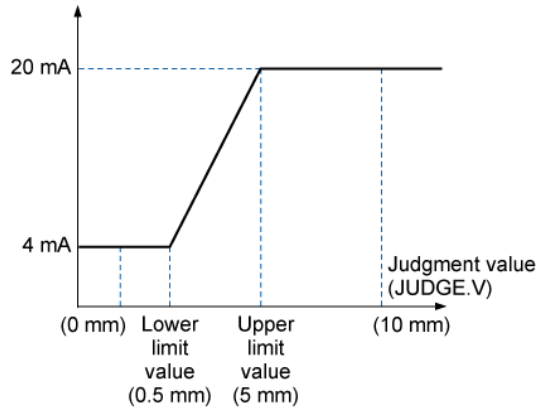

■ Analog voltage / current output specifications

Analog voltage / current output specifications are common to "DEFAULT" (default) and "FREE" (free) settings.

**When the voltage output range is 1 to 5 V**

Voltage output range	1 to 5 V
Resolution	0.1 mV
Alarm output (Note 1)	5.2V
Error output	5.2V
Indeterminate state	1V
Linearity	±0.05% F.S.
Output resistance	100 Ω max.

**When the current output range is 4 to 20 mA**

Current output range	4 to 20 mA
----------------------	------------

## 7.2 Advanced Settings (ADVANCE)

Resolution	0.3 $\mu$ A
Alarm output (Note 1)	0 mA
Error output	0 mA
Indeterminate state	0 mA
Linearity	$\pm 0.25\%$ F.S.
Maximum load impedance	250 $\Omega$ max.

(Note 1): If the set value of "ALM.CND" (alarm condition selection) is held by measurement alarm 1, when alarm 1 occurs, alarm output depends on the state of the measured value that is held when the alarm occurs.

### ■ Setting method

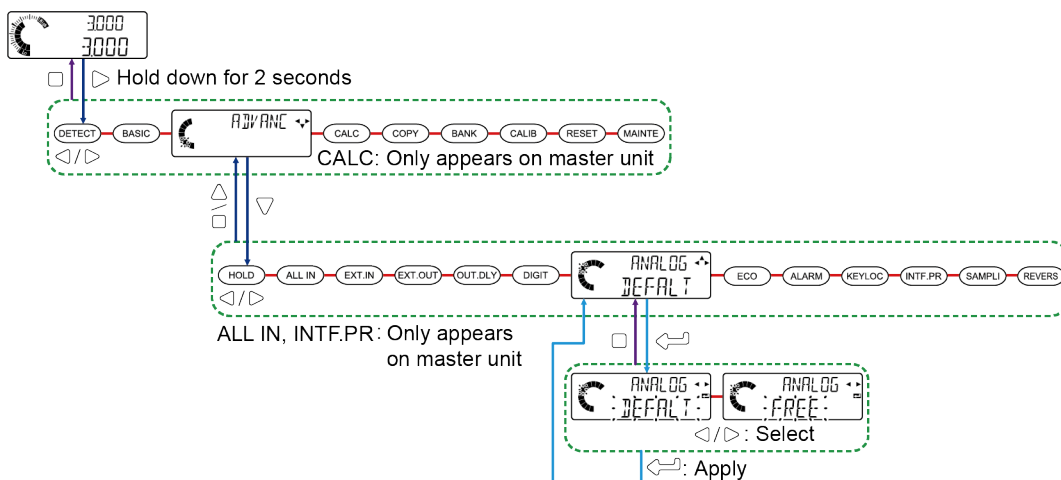

Setting item	Setting range	Default value
Analog scaling (ANALOG)	Default (DEFALT) Free (FREE)	DEFALT

### ■ Upper and lower limit values for scaling (ANALHI / ANALLO)

If "ANALOG" (analog scaling) is set to "FREE", you can set the upper and lower limit values for scaling to any desired values. After setting the upper limit value for scaling, set the lower limit value for scaling.



**When the lower limit value for scaling is smaller than the upper limit value for scaling**

Analog voltage output

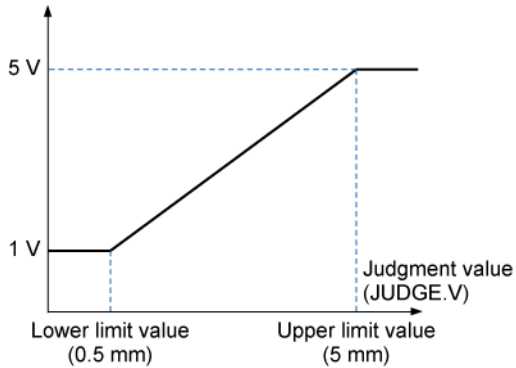

Analog current output

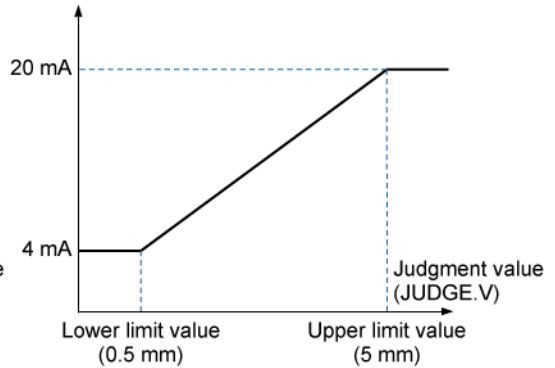

**When the lower limit value for scaling is greater than the upper limit value for scaling**

Analog voltage output

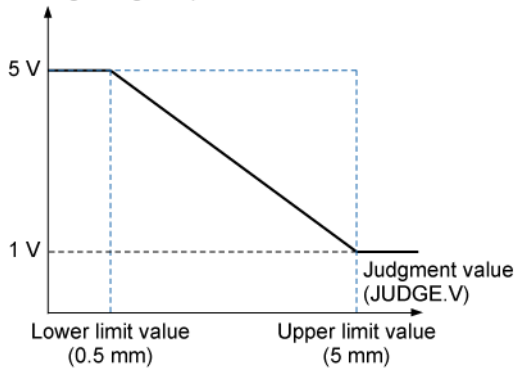

Analog current output

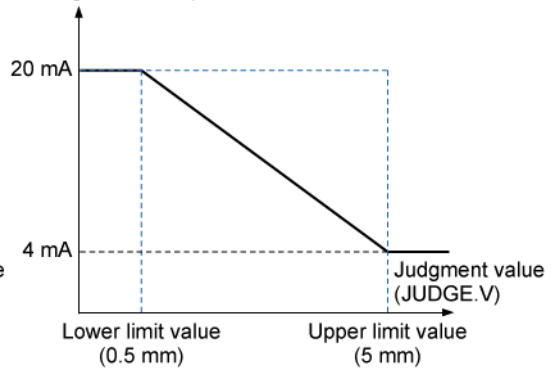

**When the lower limit value for scaling is equal to the upper limit value for scaling**

Analog voltage output

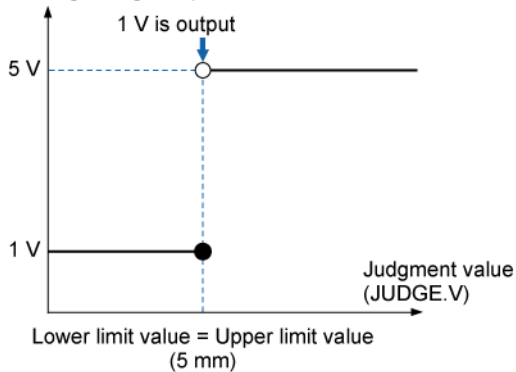

Analog current output

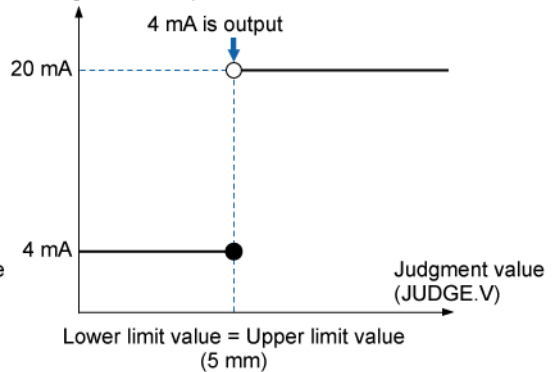

## 7.2 Advanced Settings (ADVANCE)

### ■ Setting method

#### Setting the upper limit value for scaling

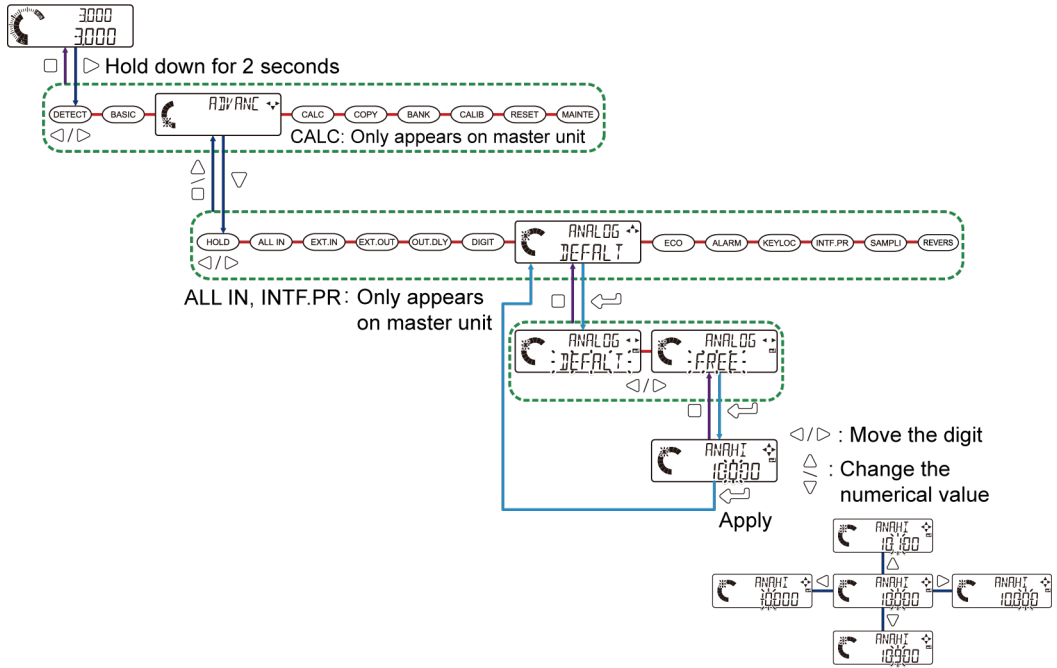

Setting item	Setting range	Default value
Upper limit value of scaling (ANA.HI)	-199.999 to 199.999 (mm)	10.000

Setting the lower limit value for scaling

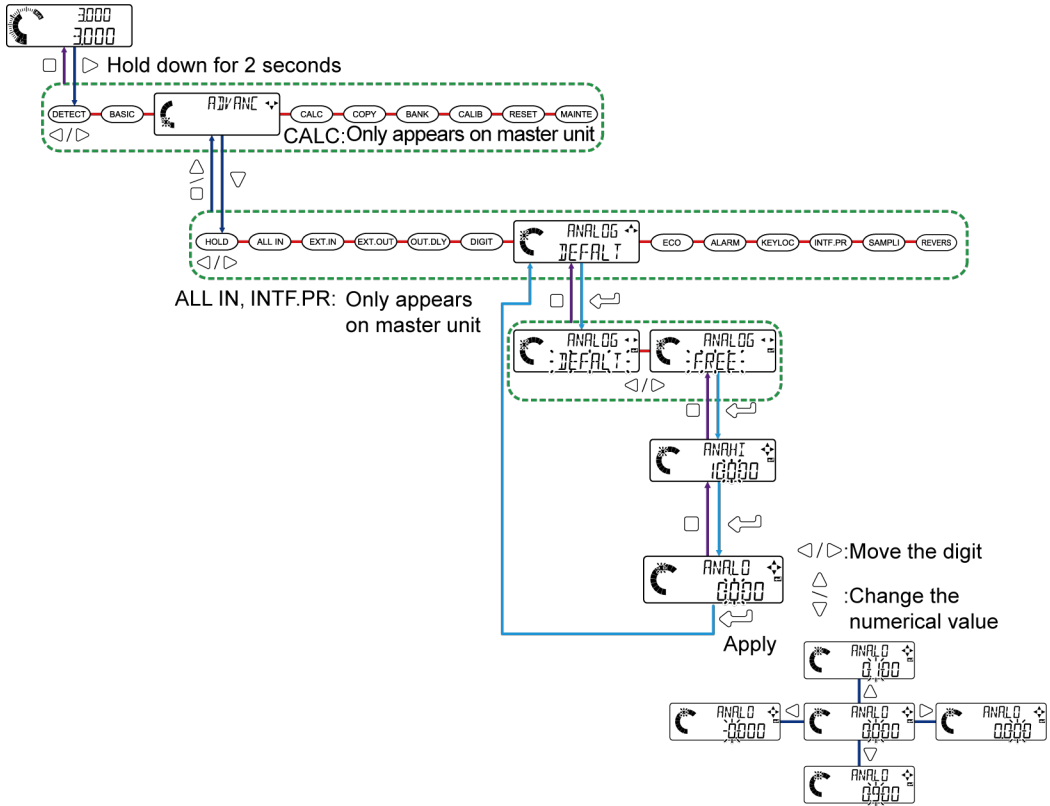

Setting item	Setting range	Default value
Lower limit value of scaling (ANA.LO)	-199.999 to 199.999 (mm)	0.000

7.2.8 Eco Mode (ECO)

This function allows you to turn OFF the backlight on the display unit of the controller to save electricity when the display unit is not used.

If Eco mode is set to ON, the backlight on the display unit will go out when no key is operated for 30 seconds.

If you press any key when the backlight on the display unit is unlit, the backlight will light up.

**Note**

- If an error occurs when the backlight is unlit, the backlight will light up.
- While an error is being displayed, the backlight does not go out.

## 7.2 Advanced Settings (ADVANCE)

### Setting method

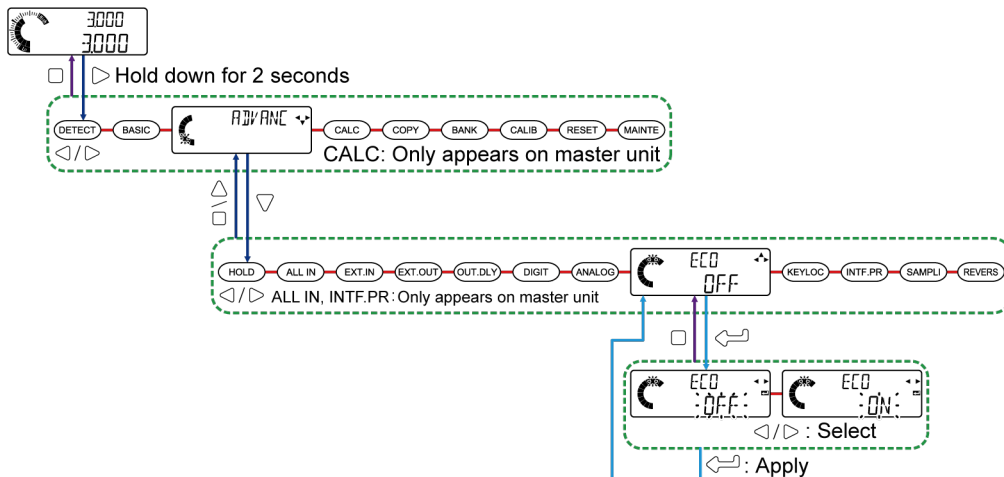

Setting item	Setting range	Default value
Eco mode (ECO)	Eco OFF (OFF) Eco ON (ON)	OFF

### 7.2.9 Alarm Settings (ALARM)

This function allows you to specify whether to detect alarms and to set alarm detection conditions.

Alarms are divided into two types (measurement alarm 1 and measurement alarm 2).

Measurement alarm 1 occurs when the sensor head becomes unable to make measurements. This alarm occurs when an edge exceeding the measurement capability occurs or when the intensity of received light is saturated due to ambient light.

Measurement alarm 2 occurs when the sensor head becomes dirty, when the number of connected controllers is changed, or when the specified measurement direction differs from the insertion direction of the detected object. (Each function can be set to ON or OFF.) Digital measured values are output directly as measured values. However, they are reflected in judgment output.

Alarm type	Description	Measured value	Judgment output
Measurement alarm 1	This alarm occurs when the intensity of received light is saturated due to ambient light or when an edge exceeding the measurement capability occurs.	Previous value or ALARM (optional)	Judgment output based on the previous value or alarm output (optional)
Measurement alarm 2	This alarm occurs when the sensor head becomes dirty, when the specified measurement direction differs from the insertion direction of the detected object.	Measured value	Alarm output

■ Alarm setting items

Alarm settings have the following items.

Alarm settings	Function	Alarm type
Alarm delay count (DELAY)	This function allows you to set the number of delays that triggers alarm output.	Measurement alarm 1 Measurement alarm 2
Alarm condition selection (ALM.CND)	This function allows you to select either the held condition or alarm condition of the last measured value for the output and display at the time of alarm occurrence.	Measurement alarm 1
Stain check (STA.CHK)	This function judges the influence of stain on the detection surface according to the intensity of received light and outputs an alarm.	Measurement alarm 2
Connected units count check (CON.CHK)	This function allows you to check the number of connected controllers.	E160 <sup>(Note 1)</sup>
Reverse insertion check (DIR.CHK)	This function outputs an alarm when the specified measurement direction differs from the insertion direction of the detected object.	Measurement alarm 2

(Note 1) This function is included in the alarm settings, but error code "E160" is displayed. (No alarm is output.)

■ Alarm delay count

This function allows you to set the number of delays that triggers alarm output. While an alarm is being delayed, the last measured value is held.

Setting method

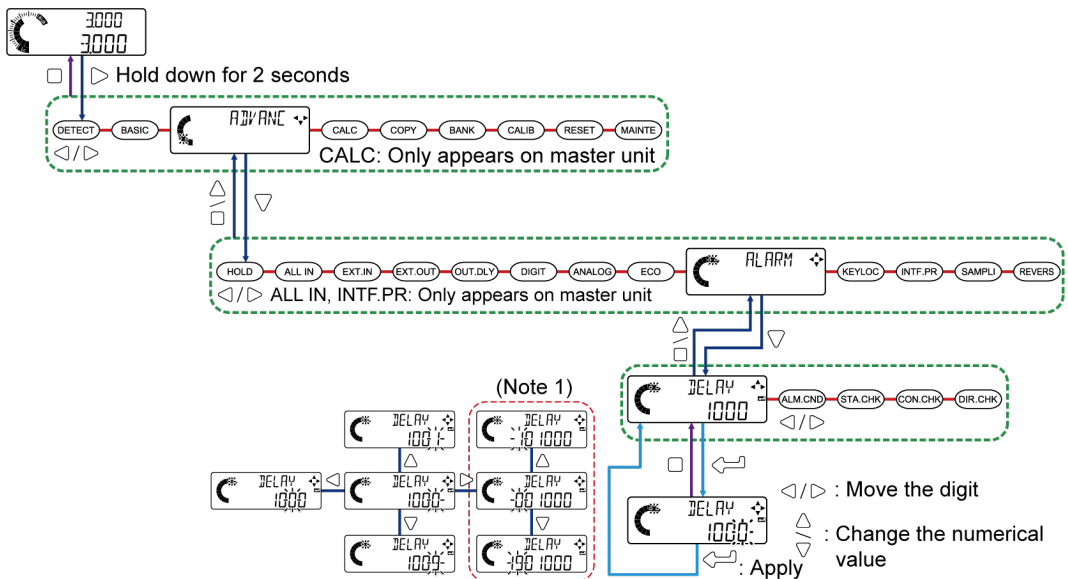

(Note 1) If you press the Enter key when the alarm delay count is outside the setting range, "\*\*\*\*\*" will be displayed in the digital display section / MAIN (white), indicating an error.

Setting item	Setting range	Default value
Alarm delay count (DELAY)	1 to 1000	1000

## 7.2 Advanced Settings (ADVANCE)

### ■ Alarm condition selection

This function allows you to select either the held condition or alarm condition of the last normal measured value (NORM.V) for the measured value at the time of measurement alarm 1 occurrence. If you do not use measurement alarm 1, select "HOLD" (Hold last value).

External output changes according to the measured value.

#### Setting method

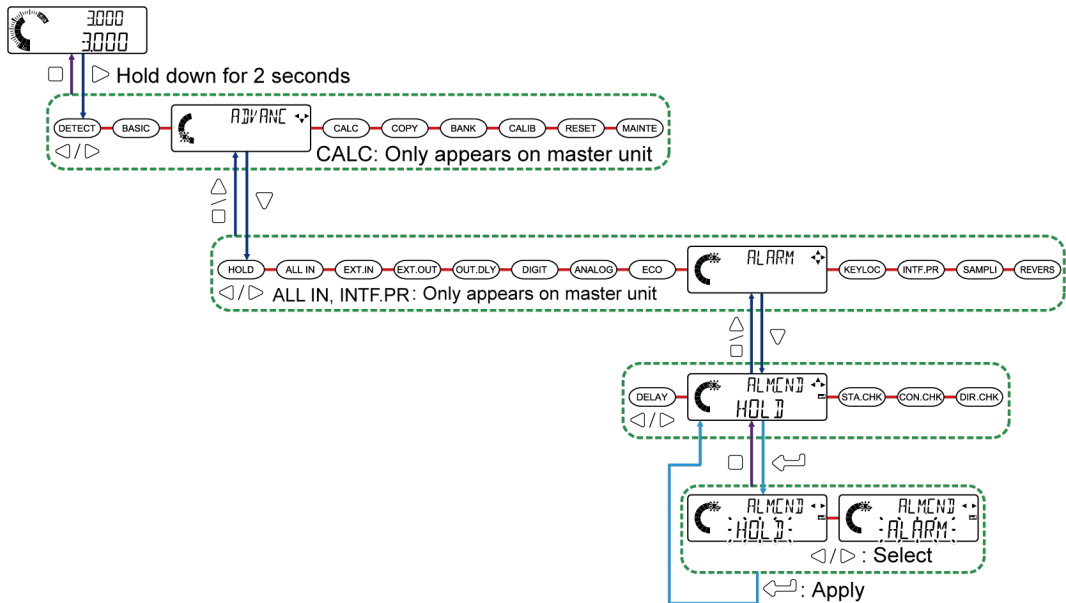

Setting item	Setting range	Default value
Alarm condition selection (ALM.CND)	Hold last value (HOLD) Alarm output (ALARM)	HOLD

### ■ Stain check

This function judges the influence of stain on the detection surface according to the intensity of received light and outputs measurement alarm 2.

Stain check	Function
Low sensitivity setting ON (LOW)	Stain check turns ON and sensitivity to stain is low. When there is severe stain on the light emitting or receiving surface of the sensor head, measurement alarm 2 is output. (Set value: 55)
High sensitivity setting ON (HIGH)	Stain check turns ON and sensitivity to stain is high. Even if there is only slight stain on the light emitting or receiving surface of the sensor head, measurement alarm 2 is output. (Set value: 80)
User setting ON (USER)	Stain check turns ON and measurement alarm 2 is output when the intensity of received light falls below any specified stain threshold value.
Stain check OFF (OFF)	Stain check turns OFF.

**Setting method**

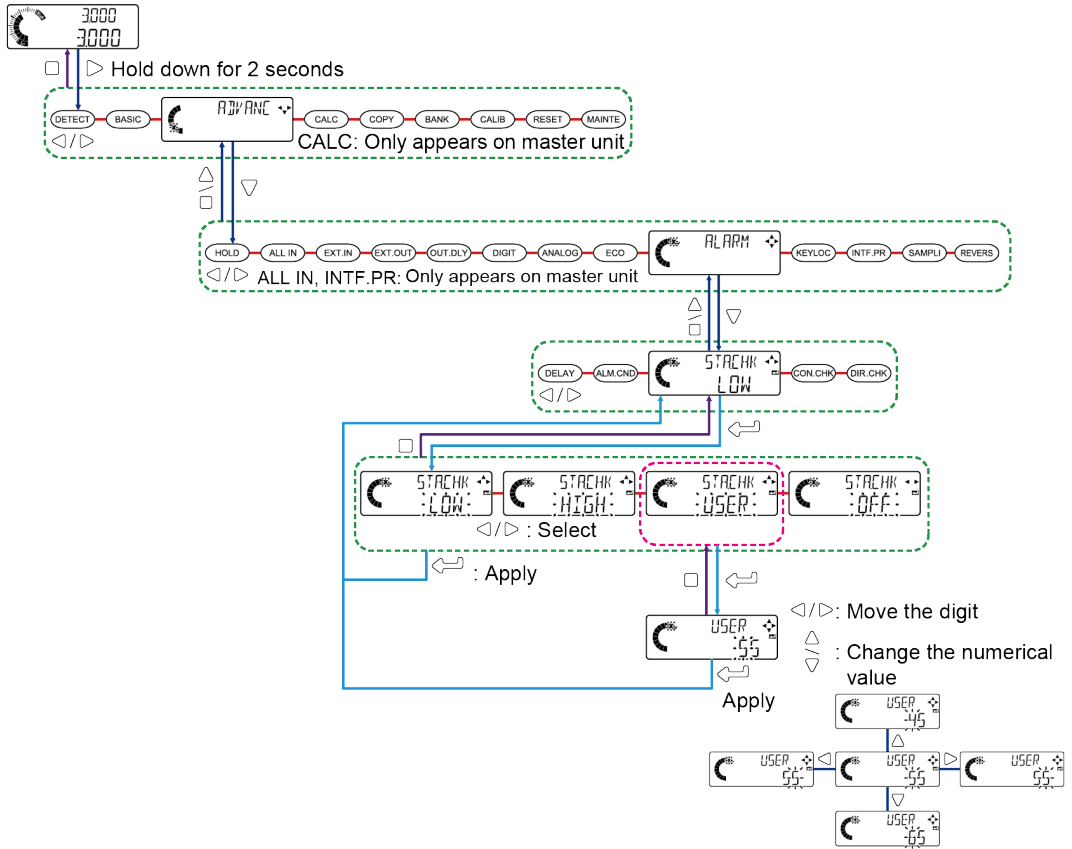

Setting item	Setting range	Default value
Stain check (STA.CHK)	Low sensitivity setting ON (LOW) High sensitivity setting ON (HIGH) User setting ON (USER) Stain check OFF (OFF)	LOW
Stain threshold (STA.THR)	50 to 95 (%)	55

■ **Connected units count check (for master units only)**

This function checks the number of connected controllers and outputs an alarm when the number of connected controllers changes.

If the actual number of connected controllers changes from the number of connected controllers that exist when "CON.CHK" (Connected units count check) is set to ON, error "E160" will be output.

When changing the number of connected controllers, first set "CON.CHK" (Connected units count check) to OFF, change the number of connected controllers, and then set "CON.CHK" (Connected units count check) to ON again.

## 7.2 Advanced Settings (ADVANCE)

### Setting method

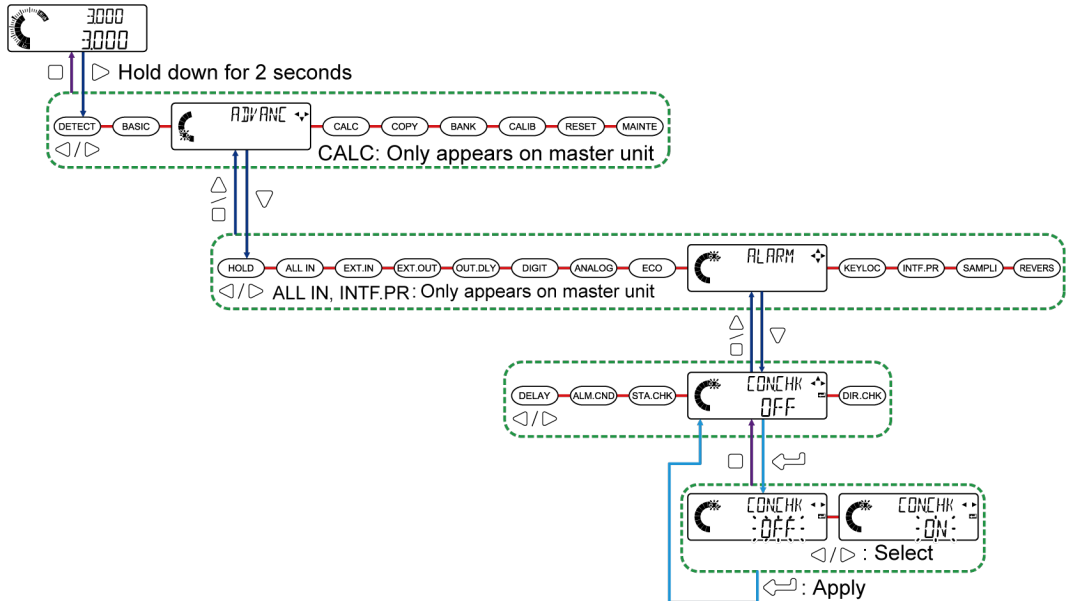

Setting item	Setting range	Default value
Connected units count check (CON.CHK)	Check OFF (OFF) Check ON (ON)	OFF

### Note

- "CON.CHK" (Connected units count check) can only be set for master units.

### Reverse insertion check

This function outputs measurement alarm 2 when the specified measurement direction differs from the insertion direction of the detected object.



### Setting method

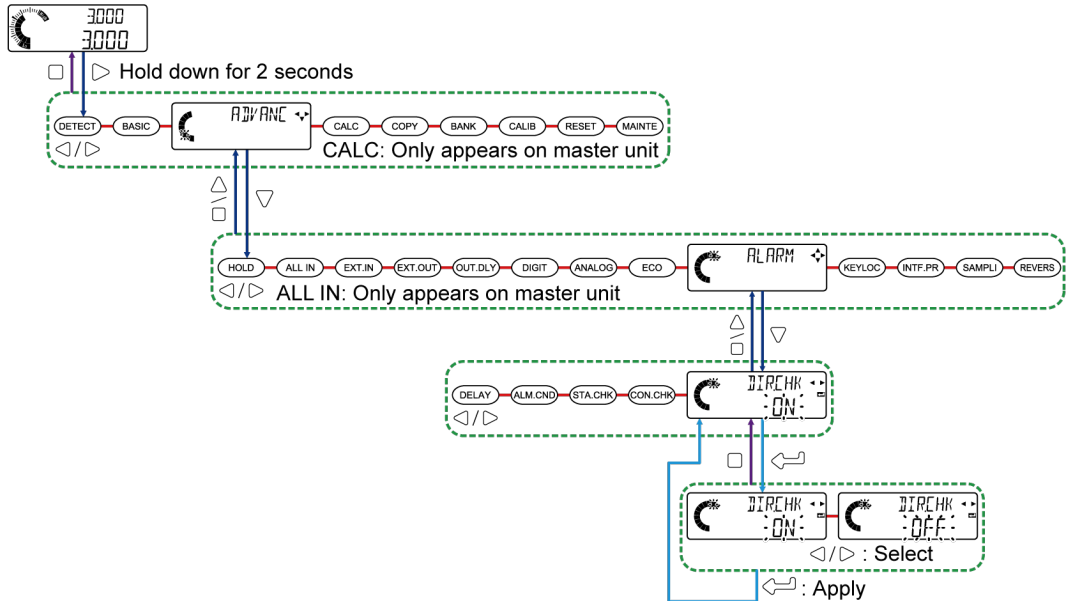

Setting item	Setting range	Default value
Reverse insertion check (DIR.CHK)	Check ON (ON) Check OFF (OFF)	ON

### Note

- "DIR.CHK" (Reverse insertion check) takes effect only when the operation mode is set to edge detection mode (EDGE).

### 7.2.10 Key Lock Function Selection (KEYLOCK)

This function allows you to configure settings to activate key lock automatically when five minutes have elapsed since key operation was performed last time.

The unlocking method for automatic key lock is the same as for manual key lock.

## 7.2 Advanced Settings (ADVANCE)

### ■ Setting method

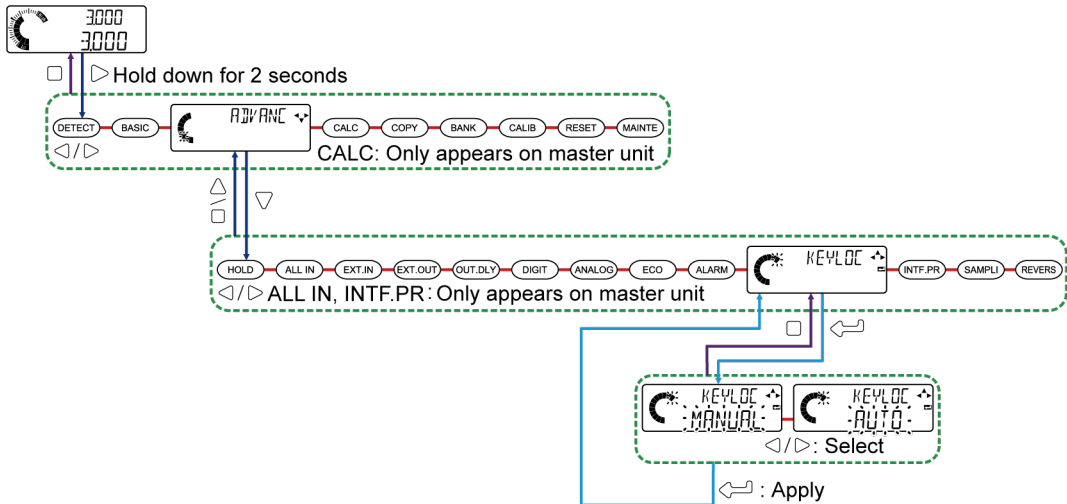

Setting item	Set value	Default value
Key lock (KEYLOC)	Manual (MANUAL) Automatic (AUTO)	MANUAL

### 📌 Note

- Time counting starts when "AUTO" is set.  
If any of all the keys to be used is pressed even once, the elapsed time count will be cleared and then time counting will start again.
- For details on how to set manual key lock, refer to "5.5.4 Key Lock".

### 7.2.11 Interference Prevention Function (INTFPR)(For Master Units Only)

This function has the controller prevent interference caused by light going around among sensor heads. The function works among four connected controllers.

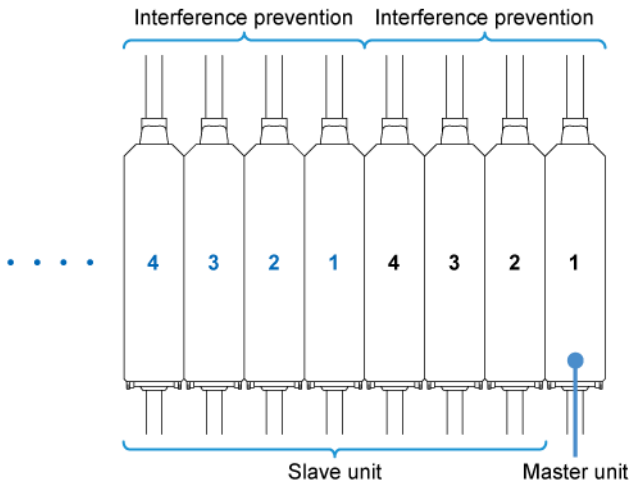

**Example: Positioning a glass plate**

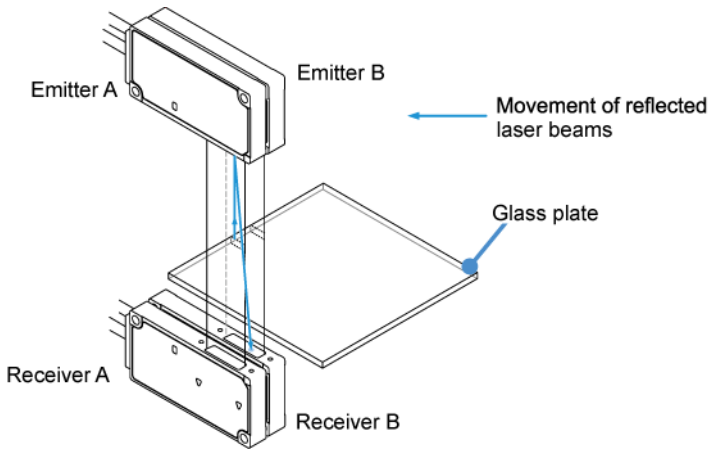

■ **Setting method**

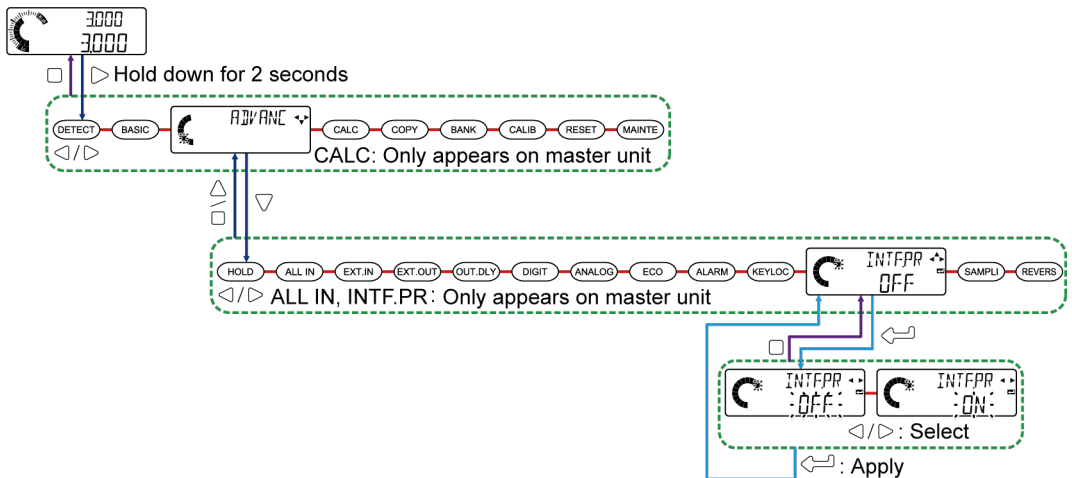

## 7.2 Advanced Settings (ADVANCE)

Setting item	Set value	Default value
Interference prevention function (INTF.PR)	Interference prevention function ON (ON) Interference prevention function OFF (OFF)	ON

### 7.2.12 Sampling Cycle (SAMPLI)

This function enables the sampling cycle to be changed according to the moving speed of the object.

Selecting "NORMAL" (standard sampling) enables measurement to be less influenced by the surrounding environment.

Sampling cycle	Function
High-speed sampling (HI-SPD)	The sampling cycle is set to 0.5 ms.
Standard sampling (NORMAL)	The sampling cycle is set to 1 ms.

#### Setting method

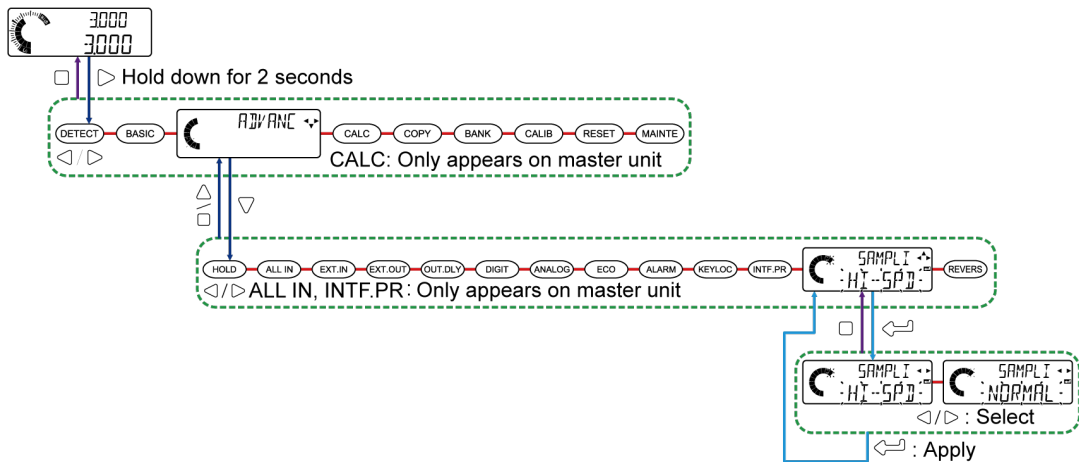

Setting item	Setting range	Default value
Sampling cycle (SAMPLI)	High-speed sampling (HI-SPD) Standard sampling (NORMAL)	HI-SPD

#### Note

- If "HI-SPD" (high-speed sampling) is used, measurement will be more influenced by ambient light.
- If "NORMAL" (standard sampling) is used, response time will become slower.

For details on response time, refer to "6.3.3 Average Count (Response Time)(SPEED)".

**7.2.13 Reverse of Measured Value (REVER5)**

This function implements a mirror inversion of the judgment value at 0 mm as its base.

Set value	Judgment value range
Not reversed (FWD)	0.000 mm to 10.000 mm
Reversed (REV)	0.000 mm to -10.000 mm

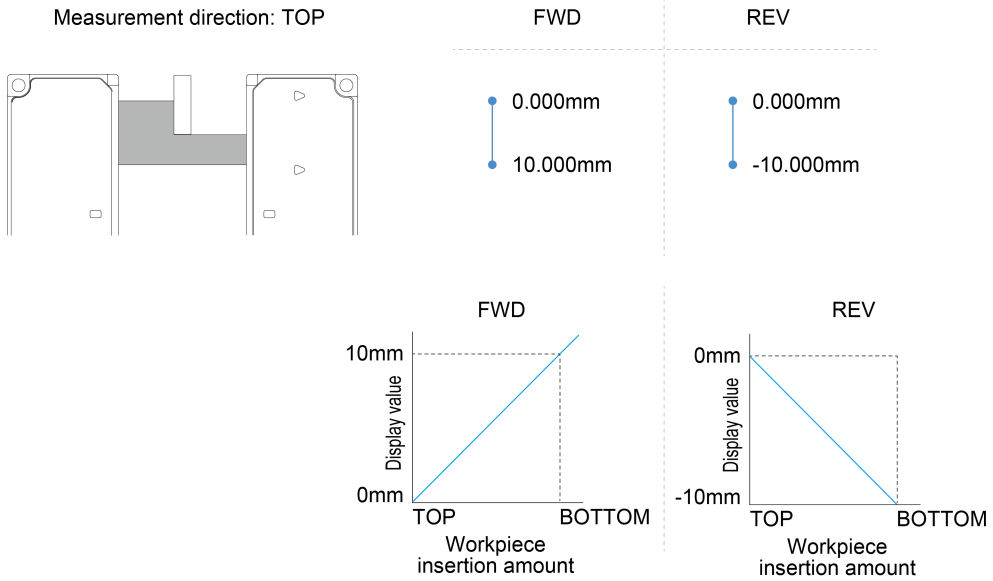

**Note**

The measured value reversal function can be set only when the detection mode is set to auto edge detection mode, edge detection mode, or user assigned edge mode.

**Setting method**

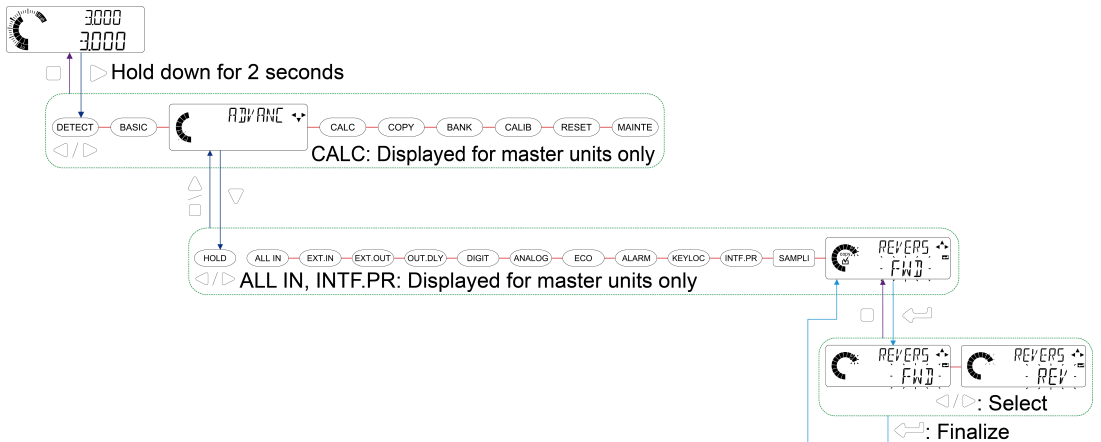

## 7.2 Advanced Settings (ADVANCE)

---

Setting item	Set value	Default value
Reverse of measured value (REVERS)	Not reversed (FWD) Reversed (REV)	FWD

### 7.3 Calculation Settings (CALC)(For Master Units Only)

This function can perform calculation processing based on the measured values of the connected controllers and display the judgment results in the digital display section of the master unit or output them from the master unit.

#### Note

- When performing calculation settings, be sure to connect slave units to the master unit.  
If no slave unit is connected to the master unit, "MODE" (calculation mode) and "APPLI" (calculation application selection) will not be displayed.
- The calculation setting menu is only displayed for master units.

#### 7.3.1 Calculation Mode (MODE)

In calculation mode, you can specify whether to perform calculations.

Calculation mode	Function
No calculation (NOCALC)	Each slave unit connected to the master unit can be operated individually without performing calculations.
Calculation execution (CALC)	This function can use the specified application to perform calculation processing for the measured values of the master unit and the slave units connected to it and display the judgment results in the display section of the master unit or output them from the master unit.

#### Setting method

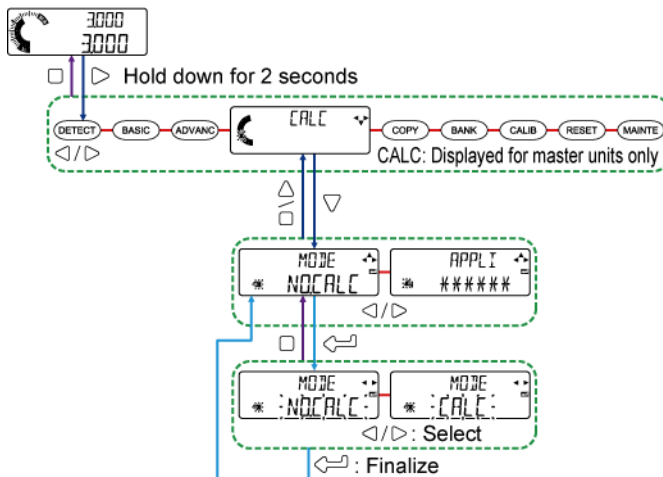

Setting item	Set value	Default value
Calculation mode (MODE)	No calculation (NO.CALC) Calculation execution (CALC)	NO.CALC

## 7.3 Calculation Settings (CAL)(For Master Units Only)

### 7.3.2 Calculation Application Selection (APPL I)

When "MODE" (calculation mode) is set to "CALC", this function allows you to set calculation application selection.

You can select an application to be used for calculation.

The function of each application is described in the following table.

Application	Function	Number of slave units required
Maximum value (MAX)	The maximum value of the measured values of the connected controllers is used as the calculated value.	At least one unit
Minimum value (MIN)	The minimum value of the measured values of the connected controllers is used as the calculated value.	At least one unit
Average value (AVERAG)	The value obtained by dividing the sum of the measured values of the connected controllers by the number of controllers is used as the calculated value. [Calculated value] = ([Master unit] + [Slave unit 1] + ... + [Slave unit n]) ÷ (1 + n)	At least one unit
Standard difference (STAND)	The measured value of each connected slave unit and the measured value (used as the base) of the master unit are calculated. The value obtained by subtracting the measured value of the master unit from the measured value of each slave unit is used as the calculated value. The calculated value is output from each slave unit. [Calculated value] = [Slave unit n] - [Master unit]	At least one unit
Thickness / width (THICK)	The value obtained by adding the measured values of the master unit and slave unit to the measured object is used as the calculated value. [Calculated value] = [Master unit] + [Slave unit 1]	One unit

The CALC status mark is lit on the controller that is performing calculations.

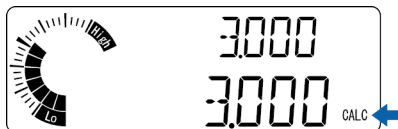

#### Note

- If "THICK" (thickness/width) is selected, when the number of connected slave units is greater than the specified number, the slave unit nearest the master unit is used for calculation. Other slave units are not used for calculation.



### ■ Setting method

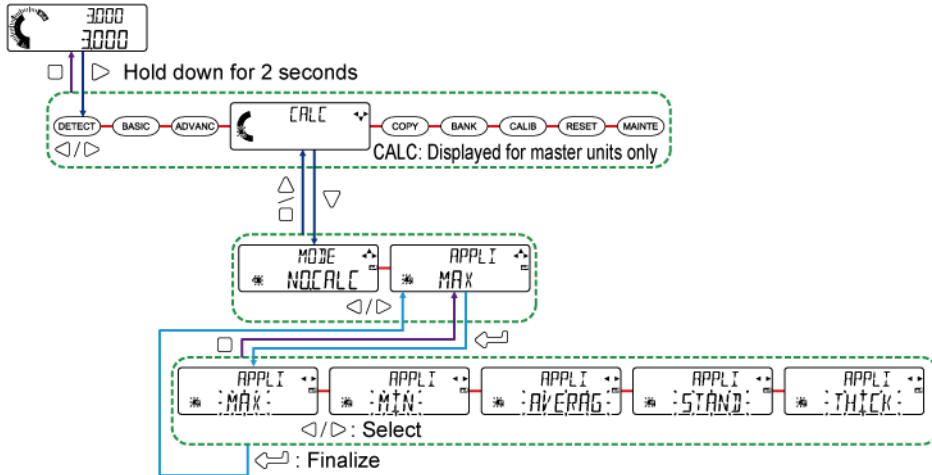

Setting item	Set value	Default value
Application (APPLI)	Maximum value (MAX) Minimum value (MIN) Average value (AVERAG) Standard difference (STAND) Thickness / width (THICK)	MAX

### ■ Maximum value (MAX)

The largest measured value of the measured values of the master unit and slave units is used as the calculated value.

The maximum measured value of the slave unit is used as the calculated value of the master unit.

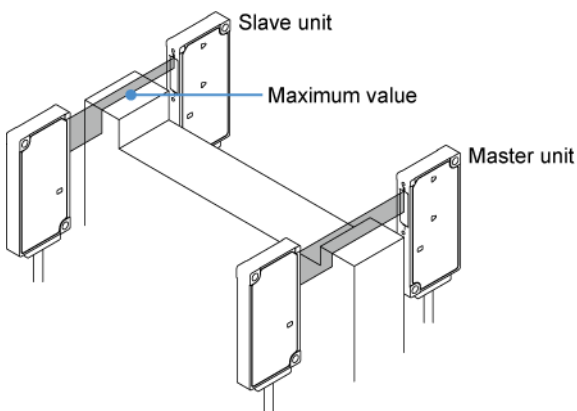

- None of the connected slave units outputs judgment results. (Always OFF)
- The response time for judgment output is the respective response times of the master unit and slave unit plus 3 ms.
- The judgment value (JUDGE.V) (calculation result) is displayed in the digital display section / MAIN (white) of the master unit.

## 7.3 Calculation Settings (ALL)(For Master Units Only)

The normal measured value (NORM.V) is displayed in the digital display section / MAIN (white) of the slave unit.

### ■ Minimum value (MIN)

The smallest measured value of the measured values of the master unit and slave units is used as the calculated value.

The minimum measured value of the master unit is used as the calculated value of the master unit.

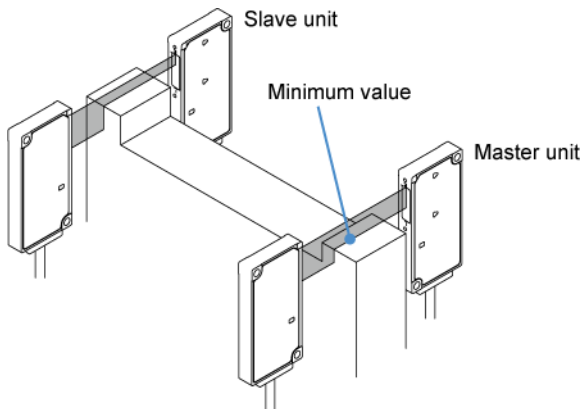

- None of the connected slave units outputs judgment results. (Always OFF)
- The response time for judgment output is the respective response times of the master unit and slave unit plus 3 ms.

### ■ Average value (AVERAGE)

The average value of the measured values of the master unit and slave units is used as the calculated value.

$([\text{Master unit}] + [\text{Slave unit 1}] + \dots + [\text{Slave unit n}]) \div (1 + n)$  is used as the calculated value of the master unit.

Where, n is the number of slave units

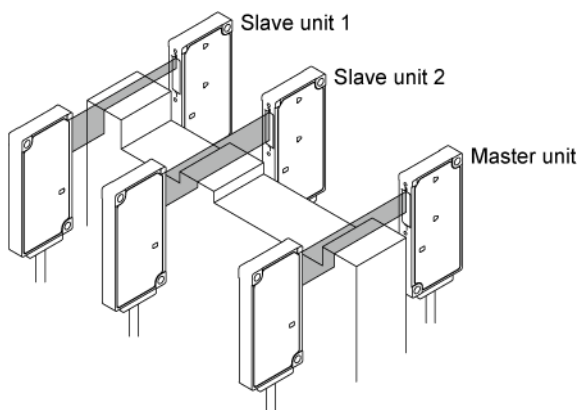

- None of the connected slave units outputs judgment results. (Always OFF)
- The response time for judgment output is the respective response times of the master unit and slave unit plus 3 ms.

### ■ Standard difference (STAND)

For each slave unit, the difference between the measured value of the master unit and that of the slave unit is used as the calculated value.

This application causes each slave unit to output judgment results.

The measured value of slave unit 2 minus the measured value of the master unit is used as the calculated value of slave unit 2.

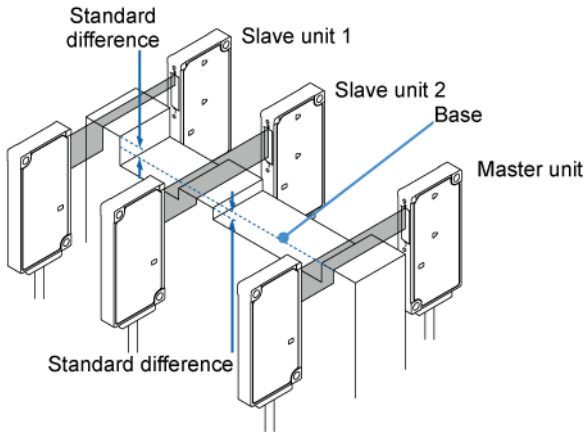

- The master unit performs judgment operations as a single unit that does not perform calculations.
- The master unit cannot use the hold function.
- The response time for judgment output is the respective response times of the master unit and slave unit plus 3 ms.

### ■ Thickness/width (THICK)

A measured object is placed between two sensor heads to calculate the thickness or width of the object.

Calculated value = Measured value of master unit + Measured value of slave unit 1

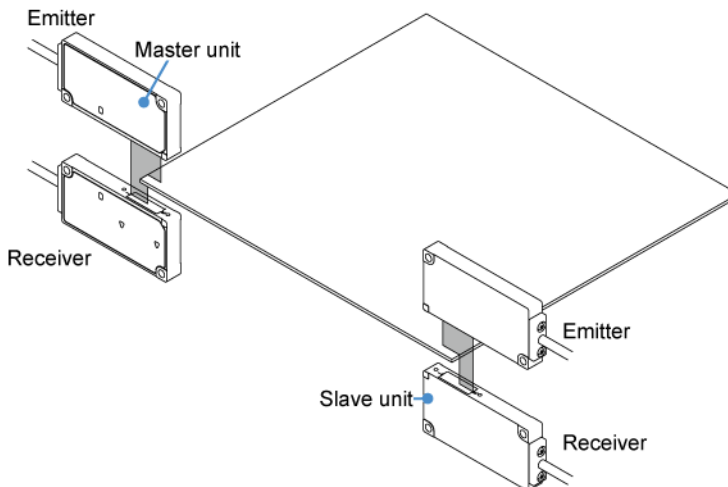

- The slave unit nearest the master unit does not output judgment results. (Always OFF)

## 7.3 Calculation Settings (LFL)(For Master Units Only)

---

If two or more slave units are connected, the second and subsequent slave units make normal judgments without performing calculations.

- The response time for judgment output by the master unit is the respective response times of the master unit and slave unit plus 3 ms.

### **Note**

- Application settings can be selected when at least one slave unit is connected.

## 7.4 Copy Settings (COPY)

The settings on the master unit can be copied to the slave units connected to the master unit. Settings to be copied from the master unit to the slave units can be selected individually. You can also select all the settings at the same time.

When "CPY.EXE" (copy execution) for the master unit is enabled (set to "YES"), copy is executed if you press the ENTER key.

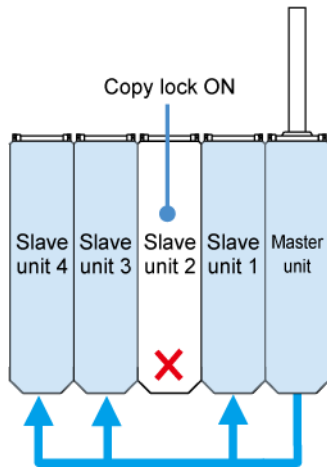

### Note

- You cannot copy the settings stored in banks.
- Slave units are equipped with a function that prohibits copying from the master unit.  
For details on copy lock, refer to "7.4.4 Copy Lock (LOCK)(For Slave Units Only)".

### 7.4.1 Copy Individual Selection (COPYSEL)(For Master Units Only)

This function allows you to select copy target items individually and copy them from the master unit to a slave unit.

#### Copy target items

Settings	Item
Detection settings (DETECT)	Operation mode (OP.MODE)
	Measurement direction (DIRECT)
Basic settings (BASIC)	HIGH set value (HI.SET)
	LOW set value (LO.SET)
	Hysteresis (HYSTER)
	Teaching type (TEACH)
	Tolerance <±>(TOL<±>)
	Preset value (PR.VAL)
	Preset data selection (PR.OBJ)

## 7.4 Copy Settings (COPY)

Settings	Item
	Preset save (PR.SAVE)
	Reference waveform save (BW.SAVE)
	Average count (response time)(SPEED)
	Output operation (OUTPUT)
	Analog output selection (A/O.SEL)
Advanced settings (ADVANC)	Hold settings (HOLD)
	External input (EXT.IN)
	External output (EXT.OUT)
	External output delay timer selection (OUT.DLY)
	Number of digits displayed (DIGIT)
	Eco mode (ECO)
	Alarm settings (ALARM)
	Key lock function selection (KEYLOC)
Reverse of measured value (REVERS)	

### Display of copy target items

Tick marks are displayed for the items that are specified as copy targets on the basic settings (BASIC) or advanced settings (ADVANC) screen.



Copy target



Not copy target

### Note

- Executing "CHK.ALL" (copy batch selection) selects all the copy target items as copy targets.
- You can use the preset key to individually select basic settings (BASIC) or advanced settings (ADVANC) items that are to be copied or not to be copied.

### ■ Setting method

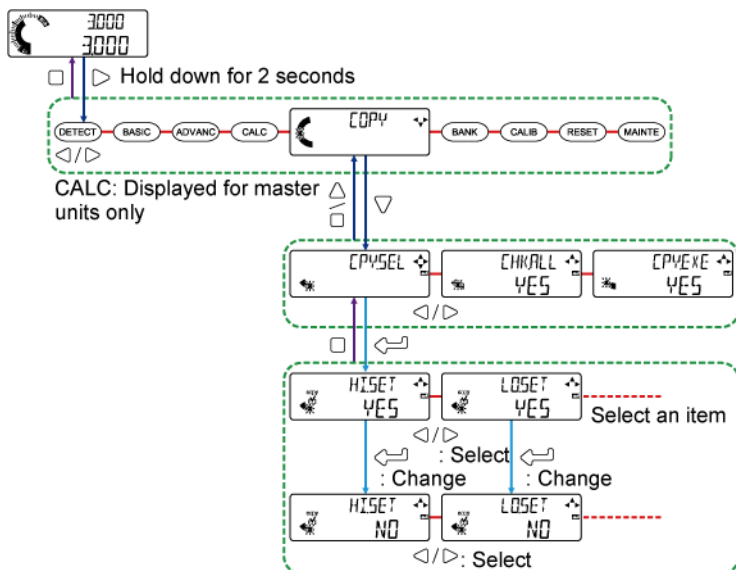

Setting item	Set value	Default value	
Copy select individual (CPY.SEL)	Operation mode (OP.MODE)	: YES / NO	YES
	Measurement direction (DIRECT)	: YES / NO	YES
	Average count (response time)(SPEED)	: YES / NO	YES
	HIGH set value (HI.SET)	: YES / NO	YES
	LOW set value (LO.SET)	: YES / NO	YES
	Hysteresis (HYSTER)	: YES / NO	YES
	Teaching type (TEACH)	: YES / NO	YES
	Tolerance <±>(TOL<±>)	: YES / NO	YES
	Preset value (PR.VAL)	: YES / NO	YES
	Preset data selection (PR.OBJ)	: YES / NO	YES
	Preset save (PR.SAVE)	: YES / NO	YES
	Reference waveform save (BW.SAVE)	: YES / NO	YES
	Output operation (OUTPUT)	: YES / NO	YES
	Analog output selection (A/O.SEL)	: YES / NO	YES
	Hold settings (HOLD)	: YES / NO	YES
	External input (EXT.IN)	: YES / NO	YES
	External output (EXT.OUT)	: YES / NO	YES
	External output delay timer selection (OUT.DLY)	: YES / NO	YES
	Number of digits displayed (DIGIT)	: YES / NO	YES
	Eco mode (ECO)	: YES / NO	YES
Alarm settings (ALARM)	: YES / NO	YES	





■ Setting method

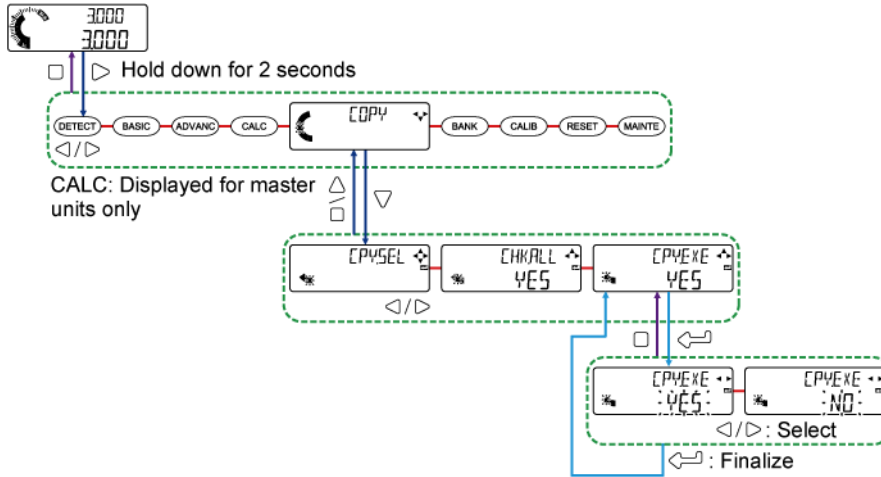

Setting item	Set value	Default value
Copy execution (CPY.EXE)	Execute (YES) Do not execute (NO)	YES

**Note**

- When copy is executed, "NOW" appears in the digital display section / SUB (green), and "COPY" appears in the digital display section / MAIN (white).

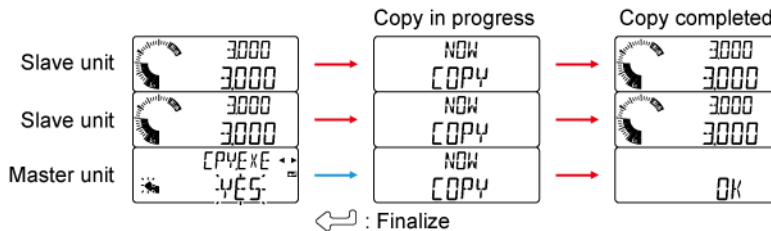

**7.4.4 Copy Lock (LOCK)(For Slave Units Only)**

Copy lock can only be set for slave units.

Setting copy lock to a slave unit allows you to prohibit copying from the master unit to that slave unit.

## 7.4 Copy Settings (COPY)

### Setting method

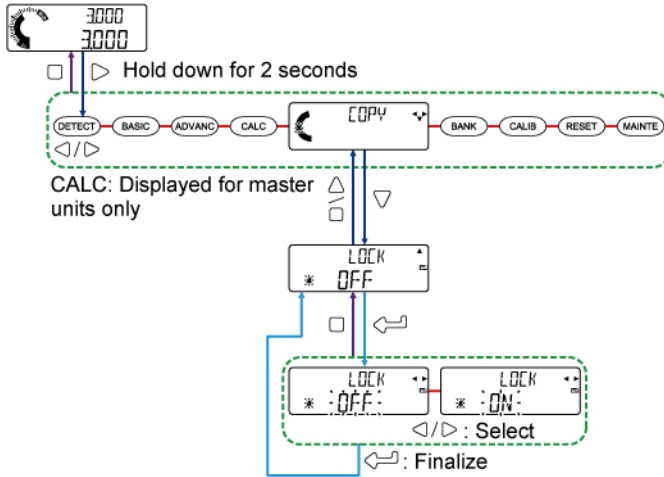

Setting item	Set value	Default value
Copy lock (LOCK)	Copy lock OFF (OFF) Copy lock ON (ON)	OFF

### Note

- On the slave unit for which copy lock is set, while copy is being executed, "COPY" appears in the digital display section / SUB (green), and "LOCK" appears in the digital display section / MAIN (white).

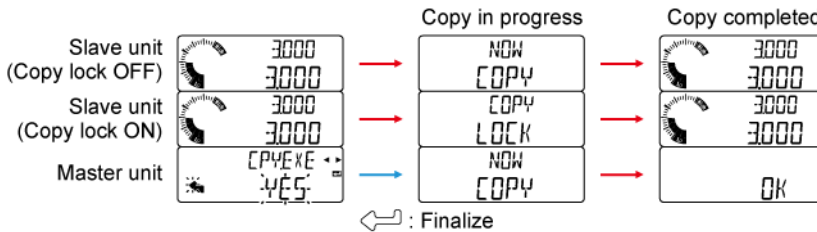

## 7.5 Bank Settings (BANK)

This function allows you to select the settings stored in the bank when loading them.

### 7.5.1 Bank Save Selection (BANK.BAT)

This function allows you to select the settings to be read from or written to the bank.

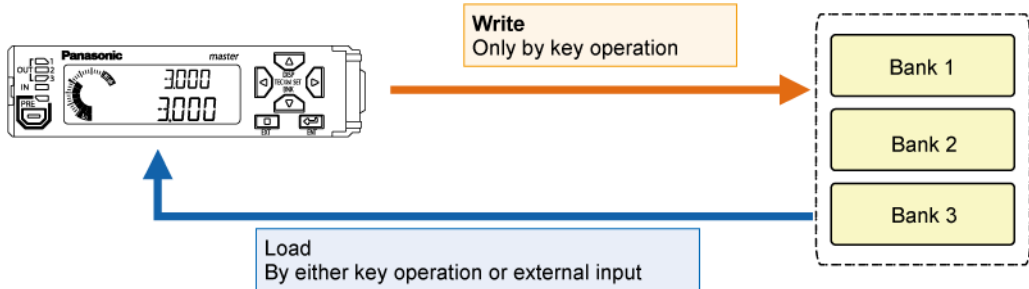

Bank save selection	Function
HIGH set value and LOW set value (THRS)	Selects the HIGH set value and LOW set value.
HIGH set value, LOW set value, preset value, sensitivity adjustment, judgment level, judgment filter, edge 1, and edge 2 (THRS.PR)	Selects the HIGH set value, LOW set value, preset value, sensitivity adjustment, judgment level, judgment filter, edge 1, or edge 2
All items (ALL)	Selects all items

#### Note

- The settings that have been read from the bank will be retained even if the power is turned OFF.
- For details on how to perform write and read operations, refer to "5.5.3 Saving and Loading Settings to / from Banks".

#### Setting method

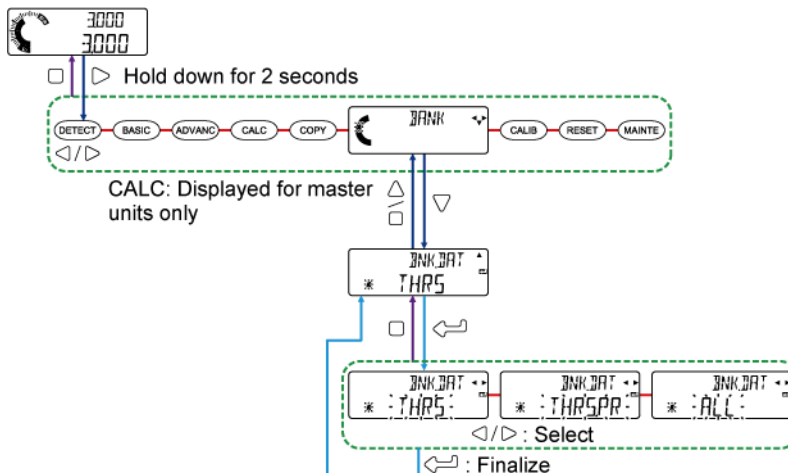

## 7.5 Bank Settings (BANK)

---

Setting item	Set value	Default value
Bank save selection (BNK.DAT)	HIGH set value and LOW set value (THRS) HIGH set value, LOW set value, preset value, sensitivity adjustment, judgment level, judgment level, judgment filter, edge 1, and edge 2 (THRS.PR) All items (ALL)	THRS

## 7.6 Calibration Settings (CALI)

### 7.6.1 Calibration Selection (CALSEL)

This function allows you to reduce installation errors when replacing the sensor head, for example.

Calibration settings	Set value	Function
Calibration selection (CAL.SEL)	Default (DEFAULT)	Calibration is reset to the factory default state.
	User settings (USER)	Calibration is executed according to the preset value and span is corrected.
	Measured value 1 (CL.SET1)	For span adjustment, the measured object is moved to target point 1 and measured value 1 is obtained.
	Adjusted value 1 (AJ.VAL1)	A target value for measured value 1 is numerically input.
	Measured value 2 (CL.SET2)	For span adjustment, the measured object is moved to target point 2 and measured value 2 is obtained.
	Adjusted value 2 (AJ.VAL2)	A target value for measured value 2 is numerically input.

#### Note

- In the following cases, calibration cannot be executed. "ERROR" is displayed in the digital display section / MAIN (white).
  - The magnitude relation between the target value and the measured value does not match (the signs of the target value and measured value do not match).
  - As a result of span adjustment, the adjusted magnification exceeds twice the factory default span.
  - The measured value is in an indeterminate state ("-----" displayed).
  - The measured value is outside the measurement range ("+OVER" or "-OVER" displayed).
  - The measured value is in an alarm or error state.

## 7.6 Calibration Settings (CAL I)

### Setting method

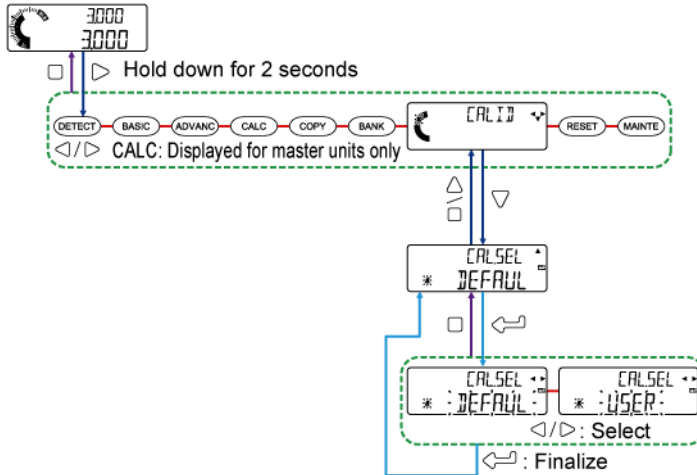

Setting item	Set value	Default value
Calibration selection (CAL.SEL)	Default (DEFAULT) User settings (USER)	DEFAULT

### When "USER" (user settings) is set

If you set "USER" (user settings), you must set the following four values in the figure below: Measured value 1 (CL.SET1), adjusted value 1 (AJ.VAL1), measured value 2 (CL.SET2), and adjusted value (AJ.VAL2).

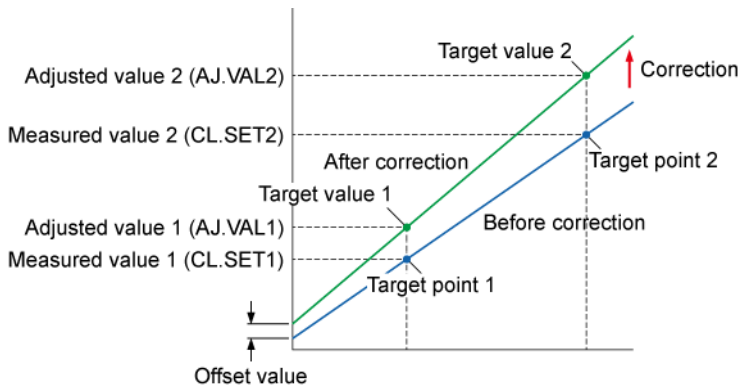

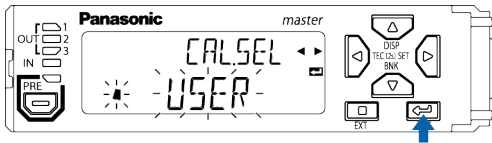

### 1.2 Procedure

1. Select "USER" (user settings) and press the key.



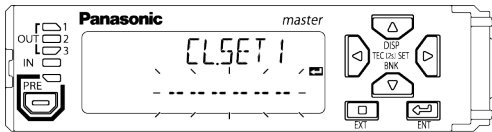



- "CL.SET1" (measured value 1) appears in the digital display section / SUB (green), and "....." appears in the digital display section / MAIN (white).

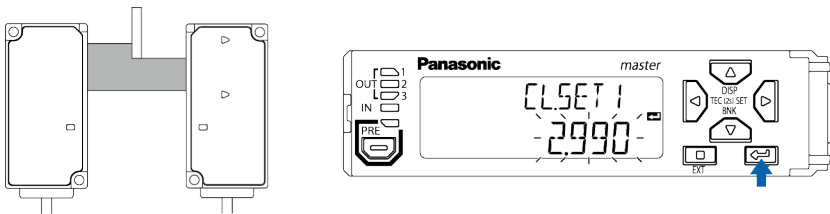

- Insert the measured object between the emitter and receiver of the sensor head, and press the  key when the object is at any desired position.



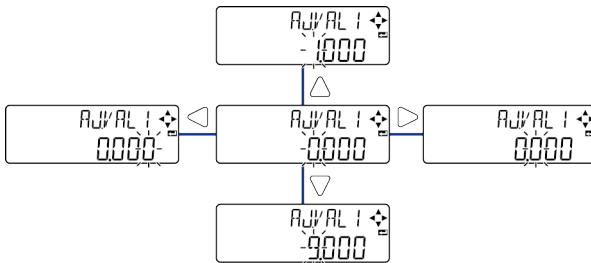

- Enter adjusted value 1 (AJ.VAL1). After entering the value, press the  key.  
 LEFT/RIGHT arrow keys ( / ): Move the digit.  
 UP/DOWN arrow keys ( / ): Change the numerical value.



Setting item		Set value	Default value
USER (user settings)	Adjusted value 1 (AJ.VAL1)	-199.999 to 199.999 (mm)	0.000

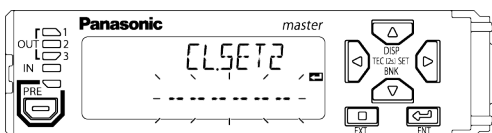



- "CL.SET2" (measured value 2) appears in the digital display section / SUB (green), and "....." appears in the digital display section / MAIN (white).

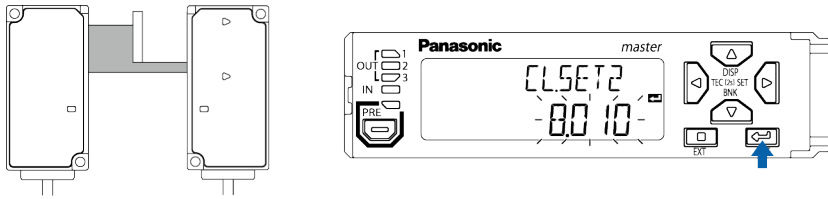

- Insert the measured object between the emitter and receiver of the sensor head, and press the  key when the object is at any desired position.

## 7.6 Calibration Settings (CALI)



7. Enter adjusted value 2 (AJ.VAL2). After entering the value, press the  key.  
 LEFT/RIGHT arrow keys (  /  ): Move the digit.  
 UP/DOWN arrow keys (  /  ): Change the numerical value.

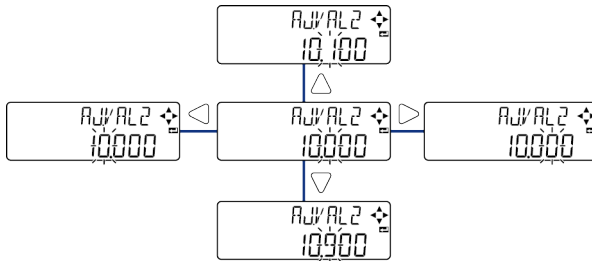

Setting item		Set value	Default value
User settings (USER)	Adjusted value 2 (AJ.VAL2)	-199.999 to 199.999 (mm)	10.000

8. If a measured value is obtained correctly, "GOOD" will be displayed and then the display will be automatically returned to the calibration selection screen.

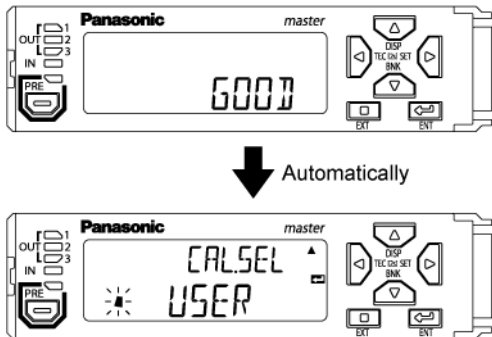



# 8 Setting up Measurement Mode

---

8.1 Sample Hold Mode .....	8-2
8.1.1 Function .....	8-2
8.1.2 Behaviors at Hold Input.....	8-2
8.2 NG Hold Mode .....	8-3
8.2.1 Function .....	8-3
8.2.2 Behaviors at Hold Input.....	8-4
8.3 Peak Hold Mode .....	8-8
8.3.1 Function .....	8-8
8.3.2 Behaviors at Hold Input.....	8-8
8.4 Bottom Hold Mode .....	8-9
8.4.1 Function .....	8-9
8.4.2 Behaviors at Hold Input.....	8-9
8.5 Peak-to-peak Hold Mode .....	8-10
8.5.1 Function .....	8-10
8.5.2 Behaviors at Hold Input.....	8-10
8.6 Tab Cancellation Mode .....	8-11
8.6.1 Flow of Measurement Data during Tab Cancellation .....	8-12
8.6.2 Setting up the Function .....	8-14
8.6.3 Operations when the Tab is Detected .....	8-16
8.6.4 Response Time when the Tab Cancellation Function Is Enabled ....	8-17
8.6.5 Precautions when Using the Tab Cancellation Function.....	8-18

## 8.1 Sample Hold Mode

### 8.1 Sample Hold Mode

#### 8.1.1 Function

When external trigger input turns ON, the judgment value (JUDGE.V) is held. When external trigger input turns OFF, the hold state is released and returned to the state in which the judgment value is updated as necessary. (Real-time output)

#### 8.1.2 Behaviors at Hold Input

##### Example of implementation

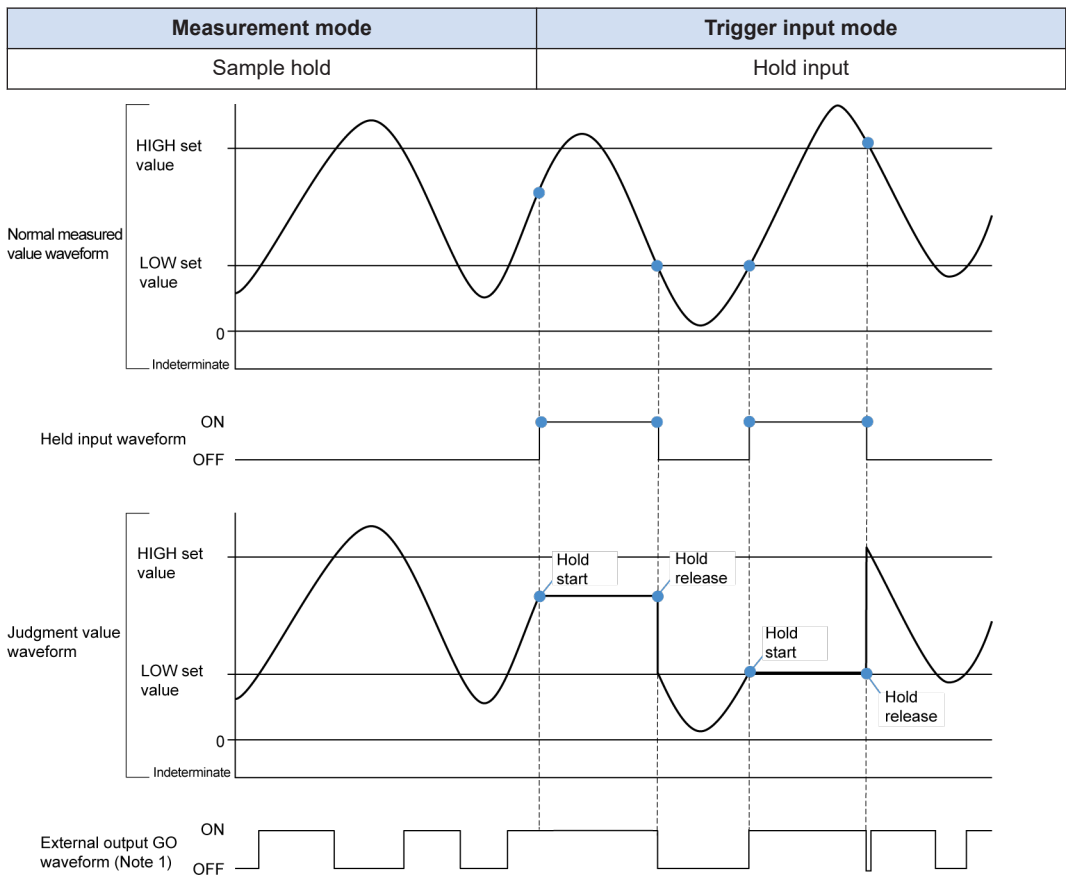

(Note 1) The above figure is an example of output when external output is set to 3-value "3VAL". In external output, judgment results are output according to the output settings.

## 8.2 NG Hold Mode

### 8.2.1 Function

This function holds judgment output when output is judged to be HIGH or LOW during the output judgment period (the period during which external trigger input is OFF). [The judgment value waveform of NG hold has the same behavior as that of sample hold.]

The HIGH judgment value or LOW judgment value that is held is released when the external trigger input is turned OFF.

It can also be released by using the reset input function.

While the external trigger input is ON, the judgment value (JUDGE.V) and judgment result are held.

## 8.2 NG Hold Mode

### 8.2.2 Behaviors at Hold Input

#### Example of implementation

Measurement mode	Trigger input mode
NG hold	Hold input

#### Behavior when output is judged to be HIGH during the output judgment period

If NG occurs on the HIGH side during the output judgment period, HIGH will be retained as the content of NG.

Then, even if NG occurs on the LOW side, the content of NG output will not be changed.

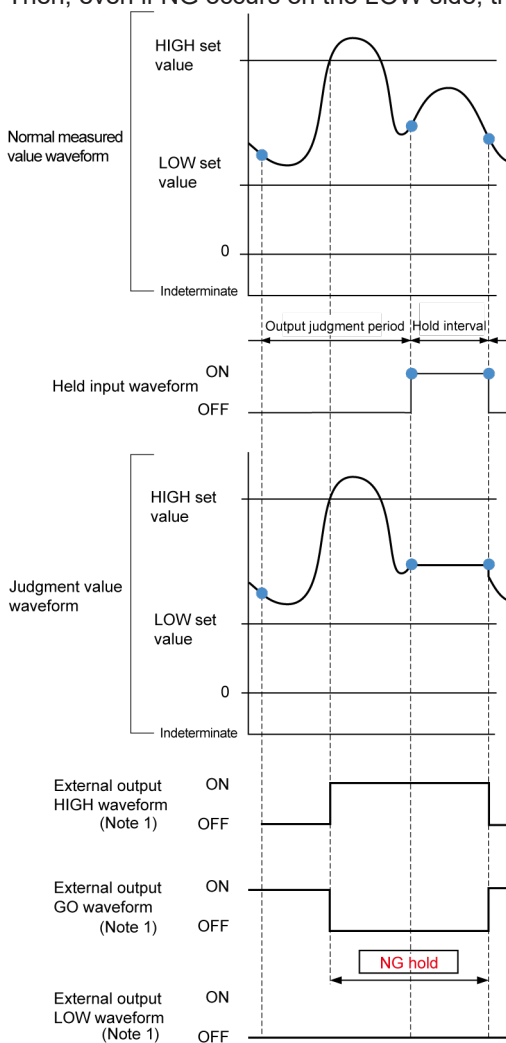

(Note 1) The above figure is an example of output when external output is set to 3-value "3VAL". In external output, judgment results are output according to the output settings.

## 8.2 NG Hold Mode

### Behavior when output is judged to be LOW during the output judgment period

If NG occurs on the LOW side during the output judgment period, LOW will be retained as the content of NG.

Then, even if NG occurs on the HIGH side, the content of NG output will not be changed.

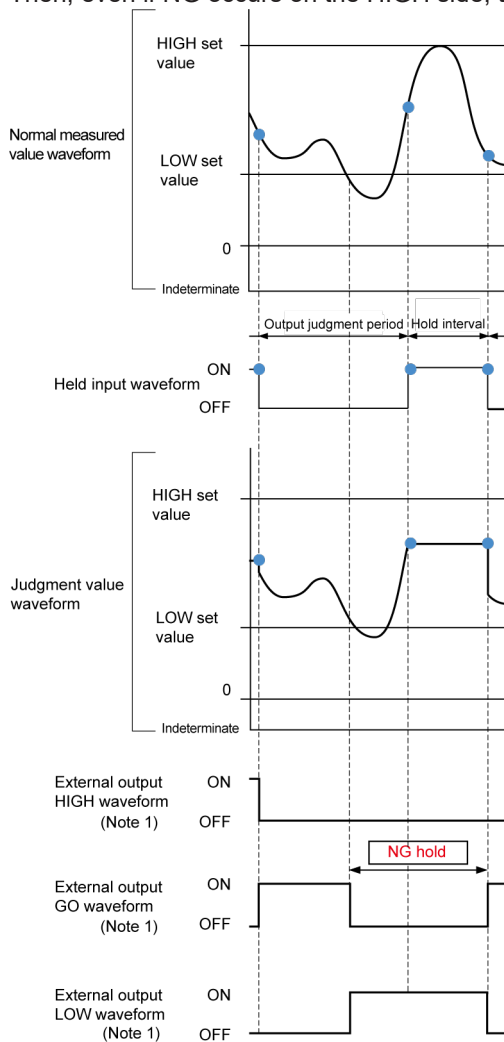

(Note 1) The above figure is an example of output when external output is set to 3-value "3VAL". In external output, judgment results are output according to the output settings.

### Behavior when output is judged to be GO during the output judgment period

If neither HIGH-side NG nor LOW-side NG occurs during the output judgment period, NG hold will not be performed.

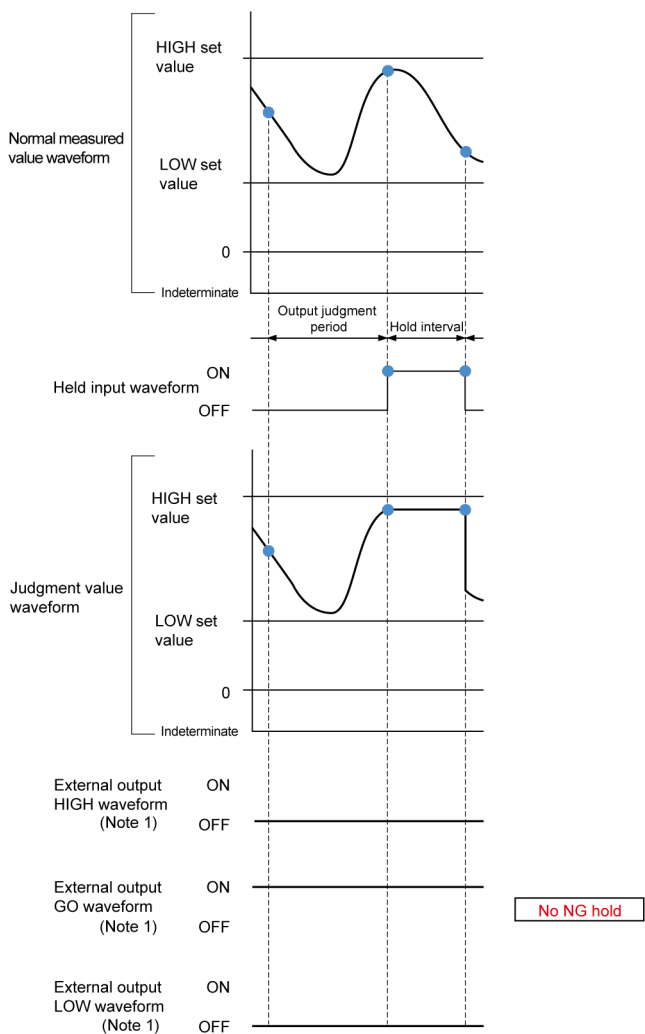

(Note 1) The above figure is an example of output when external output is set to 3-value "3VAL". In external output, judgment results are output according to the output settings.

## 8.3 Peak Hold Mode

### 8.3 Peak Hold Mode

#### 8.3.1 Function

When external trigger input turns ON, the maximum value during any sampling period is held as the judgment value (JUDGE.V). During the sampling period, the maximum value is updated as necessary and used as the judgment value.

#### 8.3.2 Behaviors at Hold Input

##### Example of implementation

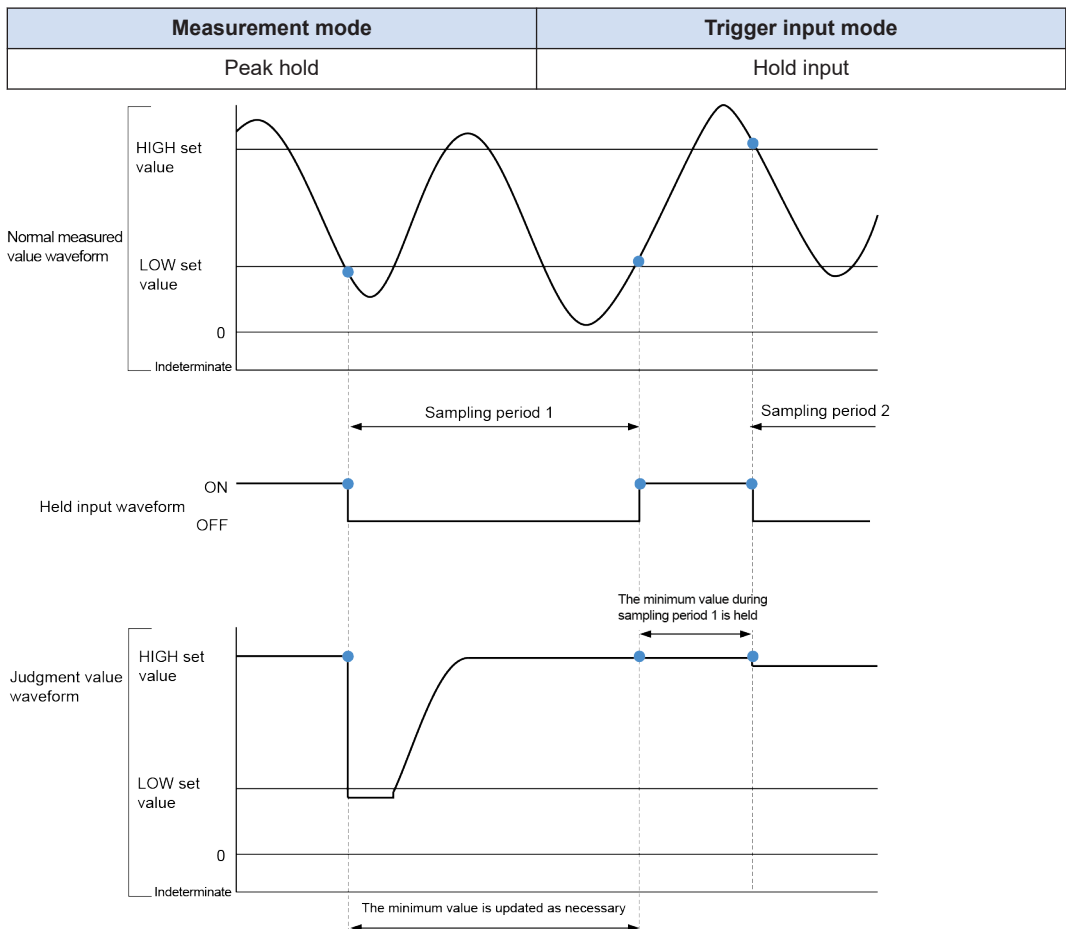



**8.4 Bottom Hold Mode**

**8.4.1 Function**

When external trigger turns ON, the minimum value during any sampling period is held as the judgment value (JUDGE.V). During the sampling period, the minimum value is updated as necessary and used as the judgment value.

**8.4.2 Behaviors at Hold Input**

**Example of implementation**

Measurement mode	Trigger input mode
Bottom hold	Hold input

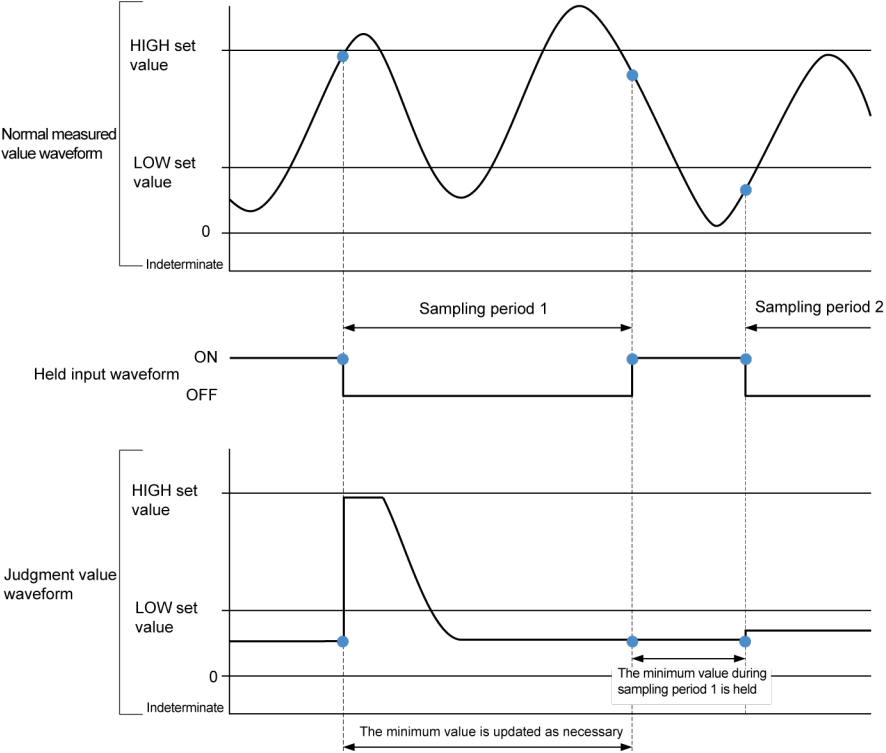

## 8.5 Peak-to-peak Hold Mode

### 8.5 Peak-to-peak Hold Mode

#### 8.5.1 Function

When external trigger input turns ON, the normal measured value (NORM.V) during any sampling period minus the value obtained by subtracting the minimum value from the maximum value is held as the judgment value (JUDGE.V). During the sampling period, the value obtained by subtracting the minimum value from the maximum value is updated as necessary.

#### 8.5.2 Behaviors at Hold Input

##### Example of implementation

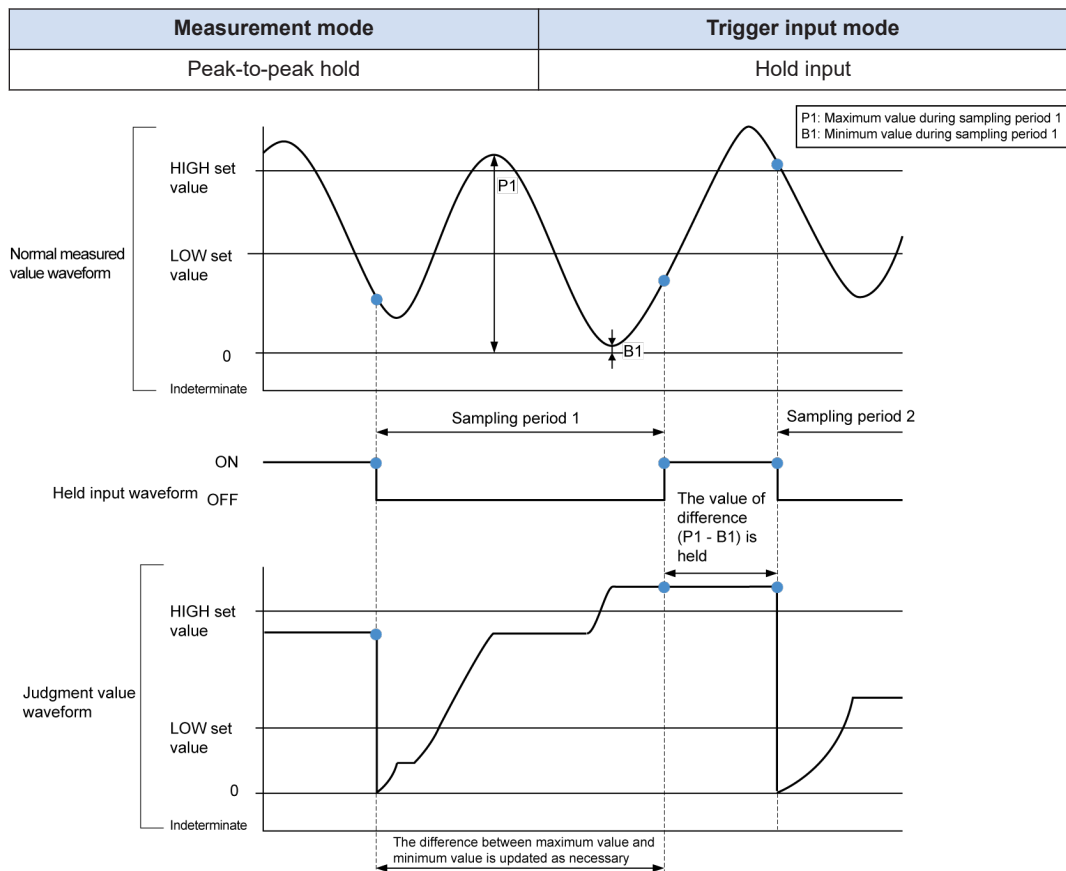

## 8.6 Tab Cancellation Mode

The tab cancellation function cancels any rapid changes in the edge positions of the workpiece to prevent these changes from being reflected in the judgment value.

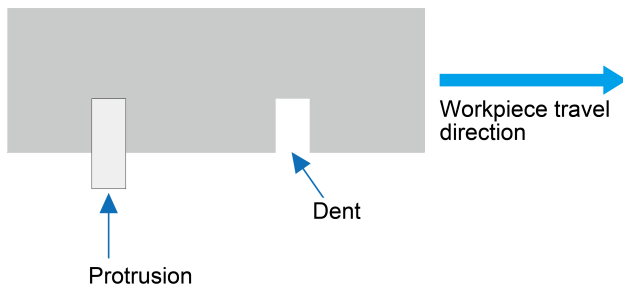

While this function is being used, if a rapid change occurs to any edge position of the workpiece, the judgment value obtained immediately before the measured value begins to change will be held for a certain period of time.



When enabling the tab cancellation mode, make sure that measured values can be detected at all times.

If an indeterminate value is input halfway through the measurement, the tab cancellation mode may not function normally.

## 8.6 Tab Cancellation Mode

### 8.6.1 Flow of Measurement Data during Tab Cancellation

If the tab cancellation function is enabled, the measurement data flow explained in "6.1 Flow of Measurement Data" will change. The tab cancellation function is executed as shown in the following flowchart.

<Normal flow>

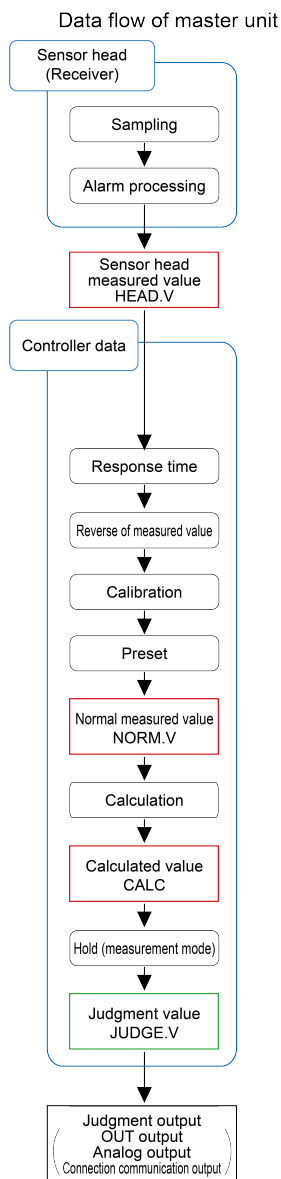

<Flow when the tab cancellation function is enabled>

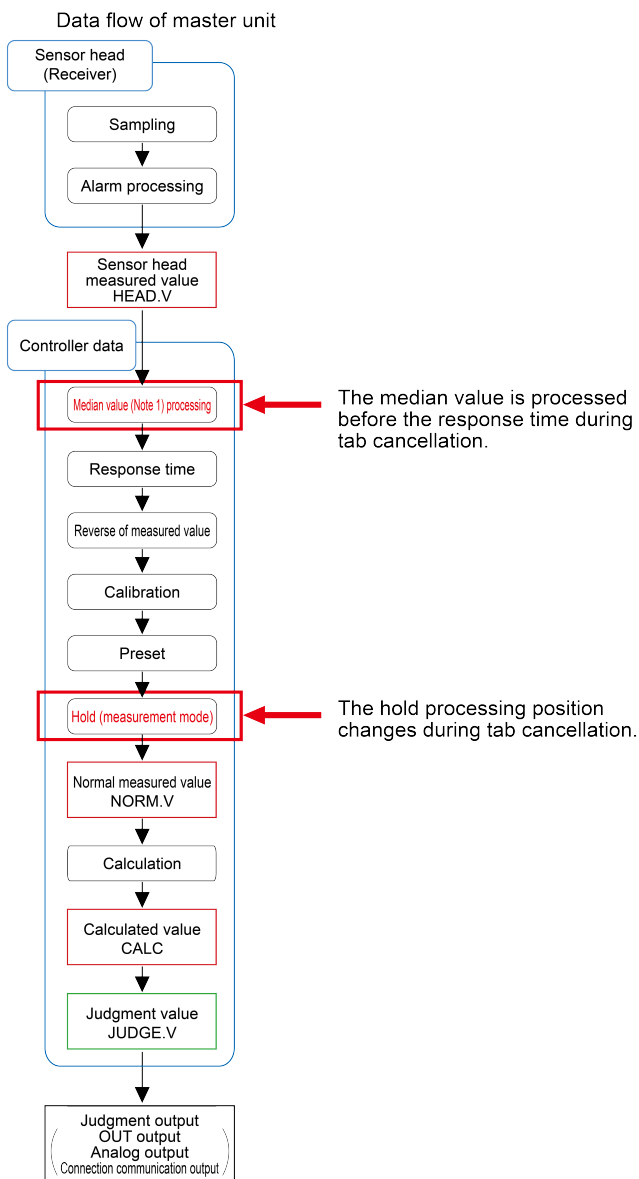

(Note 1) The median value (MEDIAN filter value) is a value that is located in a middle position when data values collected within a certain period of time are arranged in ascending order. (If the number of data values is an even number, the median value is obtained by adding up the two data values in the middle and then dividing the obtained value by 2.) If the tab cancellation function is enabled,

measured values will be output by always subjecting the measured values obtained from the sensor head to measured value processing.

**i Info.**

**Median value (MEDIAN filter value) calculation**

- This calculation method eliminates rapid changes in measured values.
- Measured values are compared by the specified number of times of measured value comparison and a median value of the compared values is selected and adopted as a judgment value.
- The number of times of comparison can be specified in "TB.CNT" (tab detection count).

**Median of odd numbers**

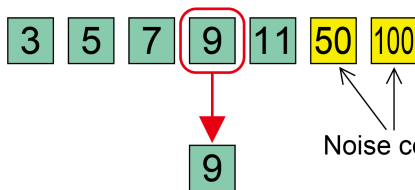

**Median of even numbers**

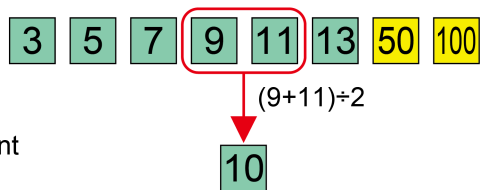

- When the tab cancellation function is OFF, the average value method is adopted.
- When the tab cancellation function is ON, median value processing is followed by averaging processing.

**In case of an average value**

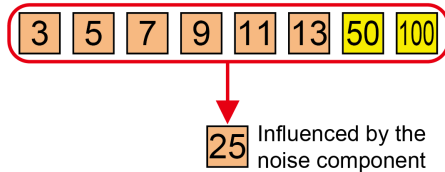

## 8.6 Tab Cancellation Mode

### 8.6.2 Setting up the Function

The tab cancellation function is selected from the hold settings.

For details on hold settings, refer to "7.2.1 Hold Settings (HOLD Ⓙ)".

To enable the tab cancellation function, you must set up the following parameters.

Setting item	Setting range	Default value
Tab threshold (STA.THR )	0.100 to 20.000 (mm)(Settable by 0.001)	1.000
Tab detection count (TB.CNT)	5 to 23 (Settable by 1)	17

#### ■ Tab threshold

A threshold is set to judge particular measured values as tabs.

Whether to cancel a tab is judged according to the size of displacement during a particular period of time.

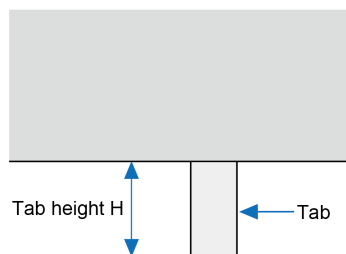

As a guide, set the threshold to approximately 20% to 50% of tab height H in the direction of tab ejection.

#### **i** Info.

- The smaller the value, the more often skipping occurs. However, if the value is too small, meanders on a sheet may be misidentified as tabs, causing hold settings to be applied.

#### ■ Tab detection count

As a change time parameter to judge particular measured values as tabs, the sampling count for MEDIAN filter values is set as "tab detection count".

The greater the sampling count, the longer the judgment time, affecting the response time.

For details, refer to "8.6.4 Response Time when the Tab Cancellation Function Is Enabled".

#### **i** Info.

- If the tab shape is trapezoidal or if the tab is inclined in the direction of movement (or in other similar cases), the magnitude of displacement caused by the tab will become more gentle. In such a case, the sampling count must be increased.
- If the sampling count is too small, meanders on a sheet may be misidentified as tabs, causing hold settings to be applied.
- When the tab cancellation function is enabled, hold settings can also be applied to master units whose calculation application selection is set to "STAND" (standard difference) and slave units whose calculation application selection is set to a setting other than "STAND" (standard difference).

■ Setting method

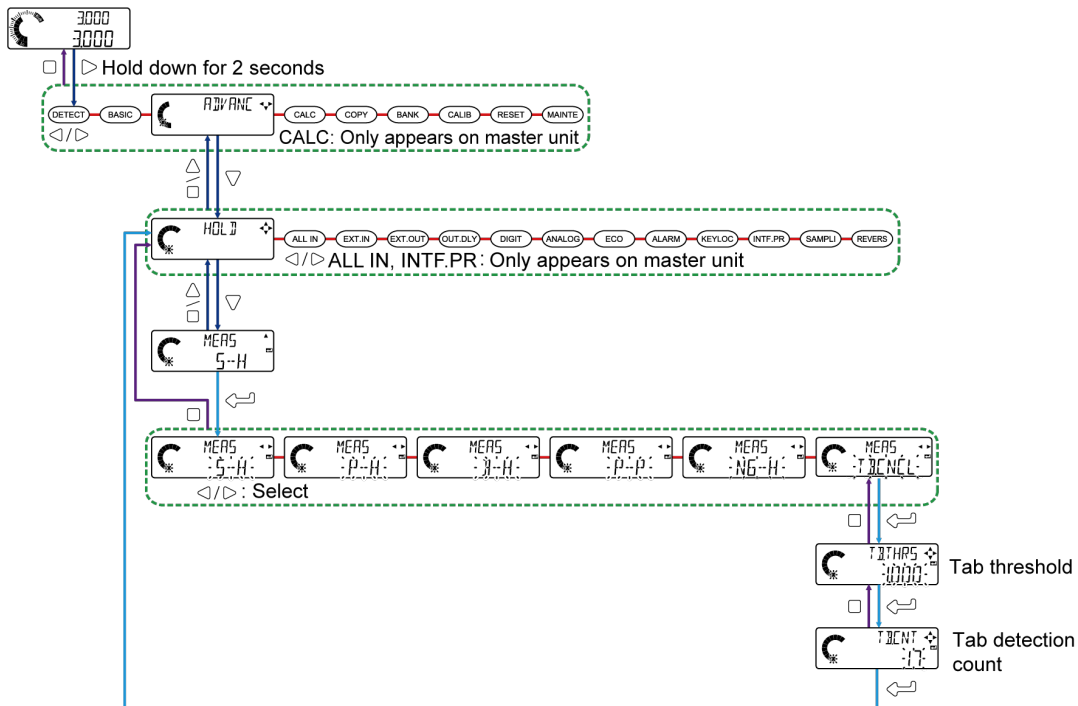

## 8.6 Tab Cancellation Mode

---

### 8.6.3 Operations when the Tab is Detected

When this product recognizes a sudden change in measured values and judges that the change satisfies the conditions required to set the tab cancellation function, it holds the judgment value (median filter value) right before the change.

In a certain period after the sudden change subsides, the judgment value will be released from the hold.

This product automatically judges and implements to start or release the hold.

#### ■ Hold starting condition

The hold starting condition is as follows.

A change that exceeds the tab judgment threshold within the detection time for a tab has occurred.

The detection time for a tab can be calculated as follows.

Sampling cycle x Tab counts/2

#### Example:

Sampling cycle: Standard sampling "NORMAL" of 1 ms

Tab counts: 17 (default)

detection time for a tab = 8.5 msec

#### ■ Hold releasing condition

The hold releasing conditions are as follows.

After an occurrence of a hold, the value has returned to a level close to the original measured value (original measured value  $\pm$  tab judgment threshold).

The hold is released after an elapse of the hold release count.

Hold release count can be calculated as follows.

Sampling cycle x (Average count + Tab counts)

#### Example:

Sampling cycle: Standard sampling "NORMAL" of 1 ms

Average count: 16

Tab counts: 17 (default)

Hold release count = 33 msec



### 8.6.4 Response Time when the Tab Cancellation Function Is Enabled

When the tab cancellation function is enabled, median filter calculation is performed. As a result, a delay occurs in outputting the measured value (response time).

#### **Response time when the tab cancellation function is enabled**

Sampling cycle x (Average count + Tab counts - 1) + Update cycle

#### **Example:**

Sampling cycle: Standard sampling "NORMAL" of 1 ms

Average count: 16

Tab counts: 17 (default)

Update cycle: 1 ms

Response time: 33 msec

## 8.6 Tab Cancellation Mode

### 8.6.5 Precautions when Using the Tab Cancellation Function

If the tab cancellation function does not work properly, check the following points and set up the parameters again.



To enable the tab cancellation function, you must enter a reset before measurement. After setting up the tab cancellation function, use external input to reset the measurement.

#### ■ If measured values are output as they are while the tab section is measured

Judgment value

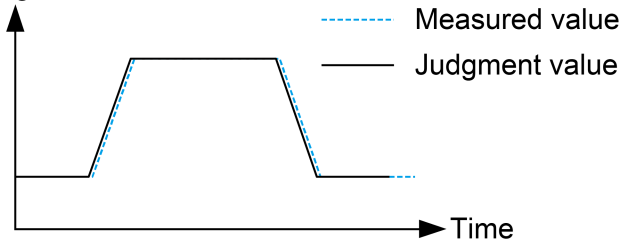

1. Check whether ADVANC > HOLD > MEAS is set to TB.CNCL.
2. Check that TB.THRS is set to a value that is approximately 20% to 50% of the tab height in the direction of tab ejection.

#### ■ If measured values are output with a slight change in values depending on the tab while the tab section is measured

Judgment value

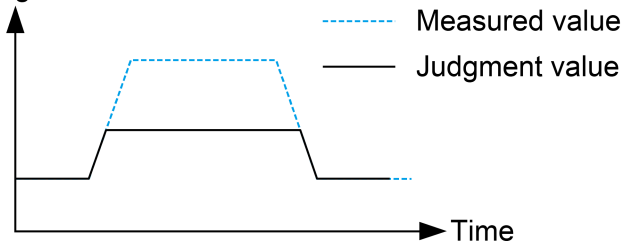

1. Increase the TB.CNT value. (Be careful that the response time changes.)
2. Decrease the TB.THRES value. (Note that if it is set to an excessively small value, the tab cancellation may be applied due to meandering of the sheet.)

#### ■ If the measured value is held at the tab height

Judgment value

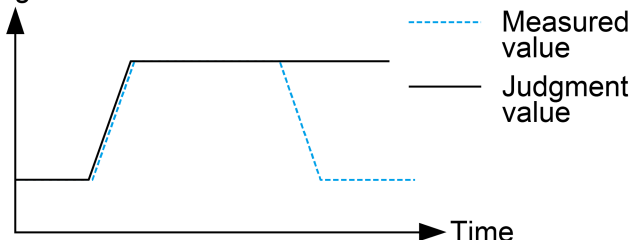

1. If the hold cannot be released, reset the measured value using an external input. In the default setting, the purple external input 2 is used to reset the measured value.
2. Increase the TB.CNT value. (Be careful that the response time changes.)
3. Decrease the TB.THRS value. (Note that if it is set to an excessively small value, the tab cancellation may be applied due to meandering of the sheet.)

(MEMO)

# 9 Specifications and Dimensions

---

9.1 Specifications .....	9-2
9.1.1 Controller .....	9-2
9.1.2 Sensor Head .....	9-9
9.2 Dimension Drawings .....	9-11
9.2.1 Controller .....	9-11
9.2.2 Sensor Head .....	9-13
9.2.3 Side View Attachment .....	9-14

## 9.1 Specifications

### 9.1 Specifications

#### 9.1.1 Controller

Measured at a supply voltage of +24 V DC and an ambient temperature of +20 °C, unless otherwise indicated.

Type		Master unit	Slave unit		
		High-performance type		Wire-saving type	
Model No.	NPN output	HG-TC101	HG-TC111	HG-TC113	
	PNP output	HG-TC101-P	HG-TC111-P		
Number of connectable units		Up to 15 slave units can be connected to a master unit. (Up to 14 slave units can be connected if a communication unit is connected.)			
Supply voltage		24 V DC $\pm$ 10%, including 0.5 V ripple (P-P)			
Current consumption <sup>(Note 1)</sup>		100 mA or less (when sensor head is connected)			
Analog output (Switching type) <sup>(Note 2)</sup>	Analog voltage output	<ul style="list-style-type: none"> <li>Voltage output range: 1 to 5 V / F.S. (default value)</li> <li>Output when alarm occurs: 5.2 V</li> <li>Linearity: <math>\pm</math>0.05% F.S.</li> <li>Output impedance: 100 <math>\Omega</math> max.</li> </ul>		—	
	Analog current output	<ul style="list-style-type: none"> <li>Current output range: 4 to 20 mA / F.S. (default value)</li> <li>Output when alarm occurs: 0 mA</li> <li>Linearity: <math>\pm</math>0.25% F.S.</li> <li>Load impedance: 250 <math>\Omega</math> max.</li> </ul>		—	
Control output (Output 1 / Output 2 / Output 3)		<b>NPN output type</b> NPN open-collector transistor <ul style="list-style-type: none"> <li>Maximum sink current: 50mA<sup>(Note 3)</sup></li> <li>Applied voltage: 30 V DC or less (between output and 0 V)</li> <li>Residual voltage: 1.5 V or less (at 50 mA sink current)</li> <li>Leakage current: 0.1mA or less</li> </ul>			—
		<b>PNP output type</b> PNP open-collector transistor <ul style="list-style-type: none"> <li>Maximum source current: 50 mA<sup>(Note 3)</sup></li> <li>Applied voltage: 30 V DC or less (between output and +V)</li> <li>Residual voltage: 1.5 V or less (at 50 mA source current)</li> <li>Leakage current: 0.1 mA or less</li> </ul>			
		Short-circuit protection			
		Judgment output			
Alarm output		Open when alarm occurs			

Type		Master unit	Slave unit		
		High-performance type		Wire-saving type	
Model No.	NPN output	HG-TC101	HG-TC111		
	PNP output	HG-TC101-P	HG-TC111-P		
External output switching		Output 1, Output 2, and Output 3 can be switched to 3-value, 2-value, Logic, and Logic 2.		—	
External input (Input 1 / Input 2 / Input 3)		<b>NPN output type</b> Non-contact input or NPN open-collector transistor <ul style="list-style-type: none"> <li>Input conditions               <ul style="list-style-type: none"> <li>Invalid: +8 V to +V DC or open</li> <li>Valid: 0 to +1.2 V DC</li> </ul> </li> <li>Input impedance: Approx. 10 kΩ</li> </ul>			—
		<b>PNP output type</b> Non-contact input or PNP open-collector transistor <ul style="list-style-type: none"> <li>Input conditions               <ul style="list-style-type: none"> <li>Invalid (0 to +0.6 V DC or open)</li> <li>Valid: +4 V to + V DC</li> </ul> </li> <li>Input impedance: Approx. 10 kΩ</li> </ul>			
		Trigger input	Input time 2 ms or more (ON)		
		Laser emission stop input	Input time 20 ms or more (ON)		
		Preset input	Input time 20 ms or more (ON)		
		Reset input	Input time: 20 ms or more (ON)		
Bank input A / B	Input time: 20 ms or more (ON)				
External input switching		Input 1, Input 2, and Input 3 can be switched to "Preset / Reset / Trigger", "Bank Input A / Bank Input B / Select (Preset, Reset, Trigger)", or "Laser emission stop".		—	
Sampling cycle		1 ms (standard sampling) or 0.5 ms (high-speed sampling)			
Average count (response time) <sup>(Note 4)</sup>		Switching type: 1 time (2 ms), 2 times (3 ms), 4 times (5 ms), 8 times (9 ms), 16 times (17 ms), 32 times (33 ms), 64 times (65 ms), 128 times (129 ms), 256 times (257 ms), 512 times (513 ms), and 1,024 times (1,025 ms)			
Display resolution		1 μm			
Display range		-199.999 to 199.999 mm			
Protection		IP40 (IEC)			
Contamination level		2			
Ambient temperature		-10 to +45°C (No condensation or icing) <sup>(Note 3)</sup> , Storage: -20 to +60°C			
Ambient operating humidity		35% to 85% RH, Storage: 35% to 85% RH			
Elevation		2,000 m or less <sup>(Note 5)</sup>			
Insulation resistance		20 MΩ or higher, using 250 V DC megger connected between all supply terminals and case			
Withstand voltage		1,000 V AC for one minute between all supply terminals and case			

## 9.1 Specifications

Type		Master unit	Slave unit	
		High-performance type		Wire-saving type
Model No.	NPN output	HG-TC101	HG-TC111	HG-TC113
	PNP output	HG-TC101-P	HG-TC111-P	
Vibration resistance		10 to 150 Hz frequency, 0.75 mm double amplitude (10 to 58 Hz), Maximum acceleration 49 m/s <sup>2</sup> (58 to 150 Hz) in X, Y and Z directions for two hours each		
Shock resistance		98 m/s <sup>2</sup> (approx. 10 G) in X, Y and Z directions 5 times each		
Materials		Case: Polycarbonate, Cover: Polycarbonate, Switches: Polyacetal		
Cable		0.2 mm <sup>2</sup> 2-conductor (brown and blue lead wires) / 0.15 mm <sup>2</sup> 7-conductor 2m composite cable	0.15 mm <sup>2</sup> 7-conductor 2m composite cable	—
Weight (main unit only)		Approx. 140 g	Approx. 140 g	Approx. 60 g
Standards compliance		EU Law : EMC Directive / British Legislation: EMC Regulations		

(Note 1) Current consumption does not include analog current output.

(Note 2) Linearity is a value calculated from digitally measured values at F.S. = 16mA for current output or F.S. = 4 V for voltage output.

(Note 3) When slave units are connected to the master unit, the maximum sink current and source current of control output and ambient temperature vary depending on the number of connected slave units as shown below.

Number of connected slave units		Maximum sink current and source current of control output	Ambient temperature
	When communication unit is connected		
1 to 7 units	1 to 6 units	20 mA	-10 to +45°C
8 to 15 units	7 to 14 units	10 mA	

(Note 4) Average count (response time) is for when the sampling cycle is set to 1 ms (standard sampling). Response times differ when the sampling cycle is set to 0.5 ms (high-speed sampling).

(Note 5) Do not use or store this product in environments where ambient air is pressurized to an air pressure higher than the atmospheric pressure at an altitude of 0 m.



■ I/O circuit diagrams

HG-TC101 / NPN output type

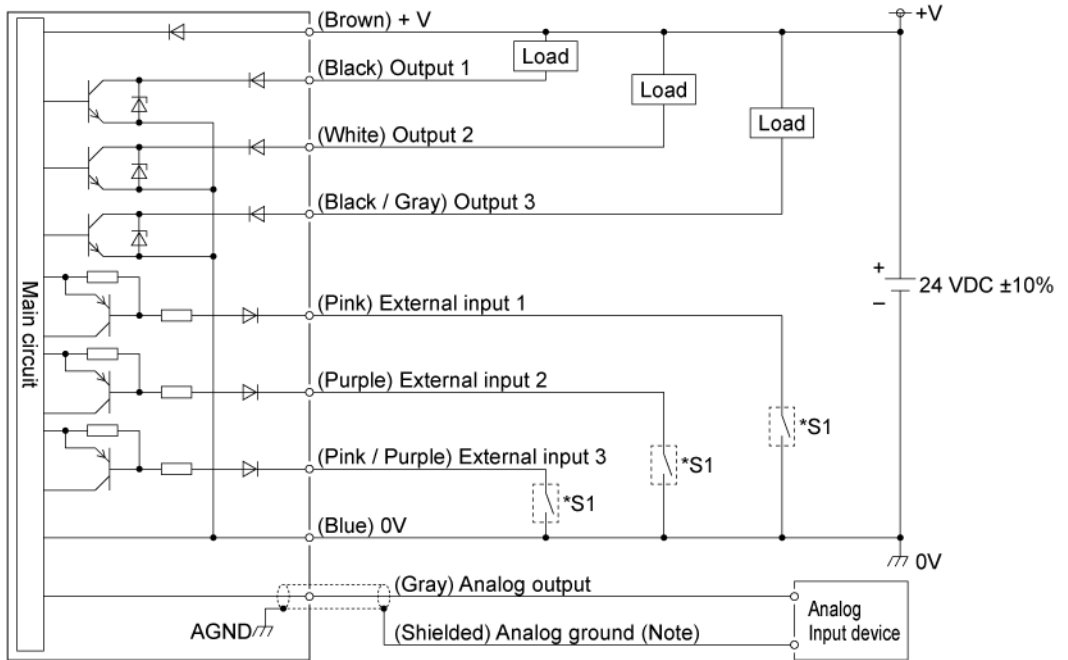

\*S1

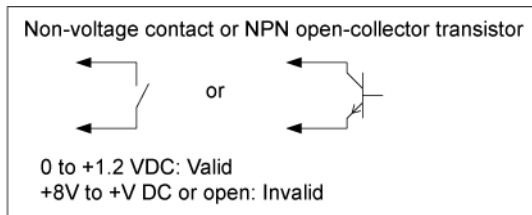

(Note 1) Use shielded cables for analog output.

**Note**

- All outputs are equipped with short-circuit protection. If any one of outputs 1 to 3 short-circuits, all outputs temporarily turn OFF. The outputs automatically recover when the short-circuit state is cleared.

## 9.1 Specifications

### HG-TC101-P / PNP output type

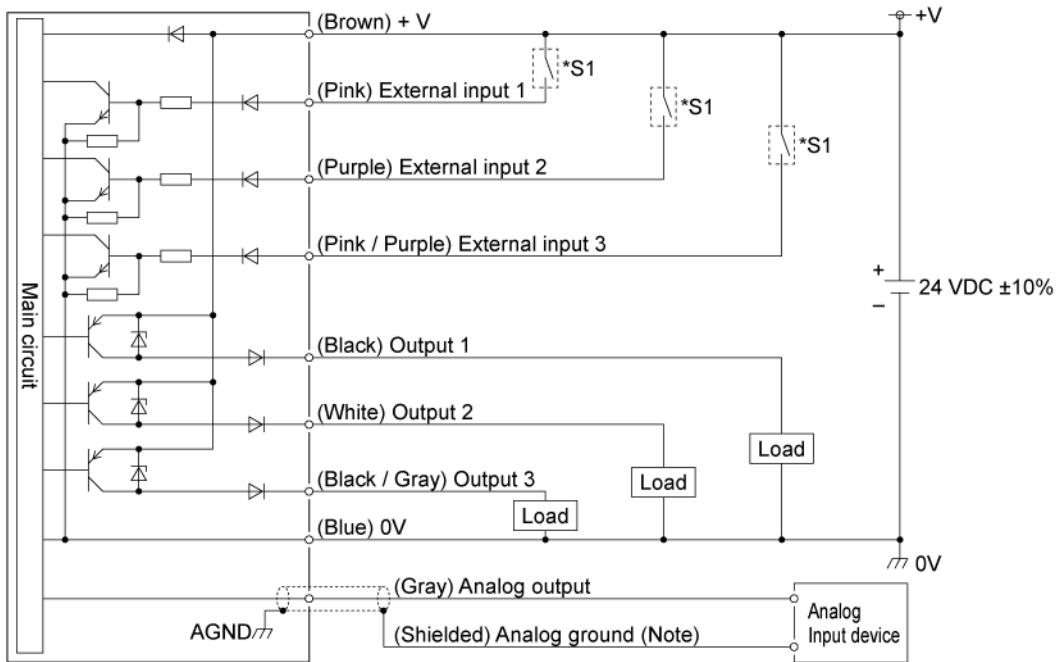

**\*S1**

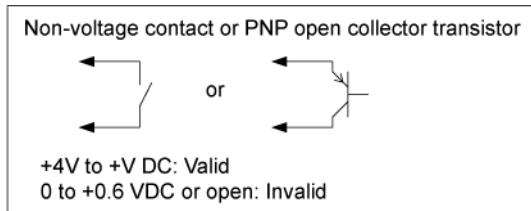

(Note 1) Use shielded cables for analog output.

#### Note

- All outputs are equipped with short-circuit protection. If any one of outputs 1 to 3 short-circuits, all outputs temporarily turn OFF. The outputs automatically recover when the short-circuit state is cleared.

**HG-TC111 / NPN output type**

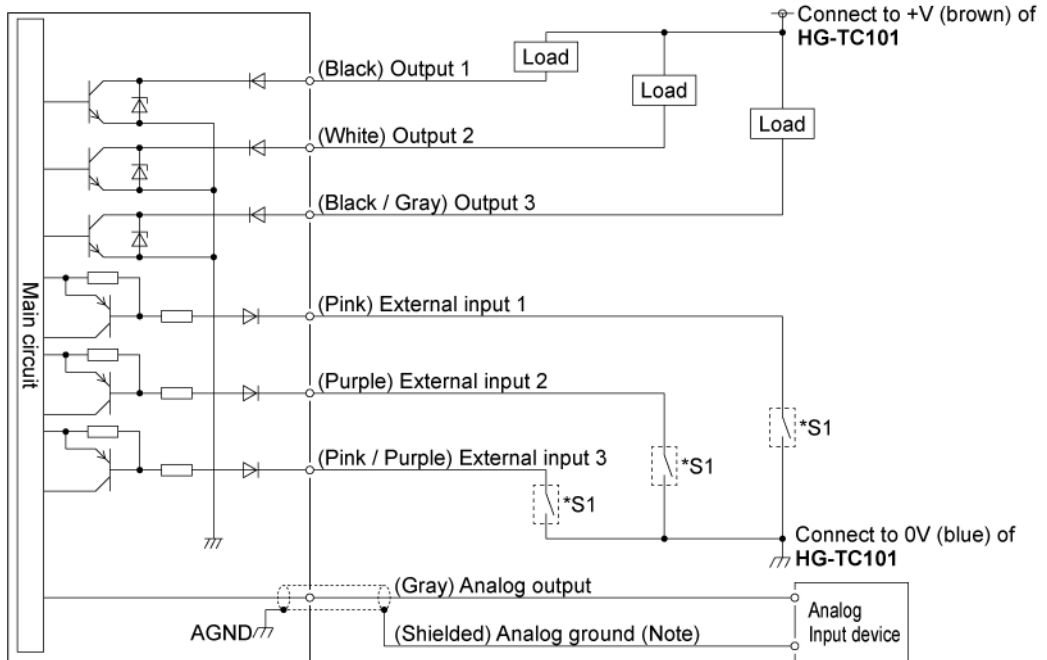

**\*S1**

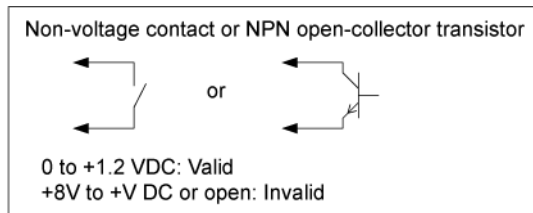

(Note 1) Use shielded cables for analog output.

**Note**

- All outputs are equipped with short-circuit protection. If any one of outputs 1 to 3 short-circuits, all outputs temporarily turn OFF. The outputs automatically recover when the short-circuit state is cleared.
- The **HG-TC111** cable does not have +V or 0V. Power is supplied from the connector of the master unit.

## 9.1 Specifications

### HG-TC111-P / PNP output type

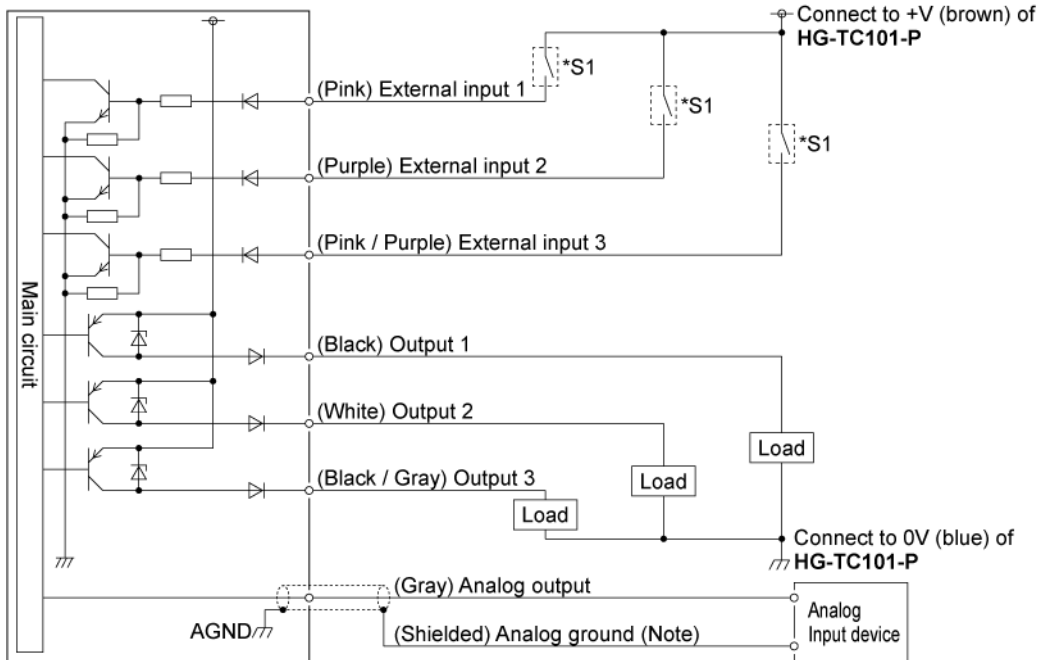

#### \*S1

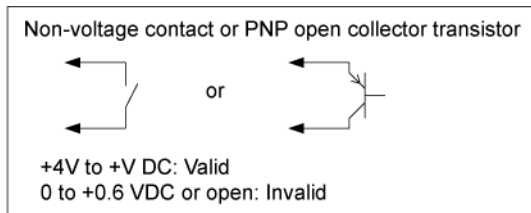

(Note 1) Use shielded cables for analog output.

#### Note

- All outputs are equipped with short-circuit protection. If any one of outputs 1 to 3 short-circuits, all outputs temporarily turn OFF. The outputs automatically recover when the short-circuit state is cleared.
- The HG-TC111-P cable does not have +V or 0V. Power is supplied from the connector of the master unit.

## 9.1.2 Sensor Head

Type	Measurement width 10 mm / Standard type	Measurement width 10 mm / Slim type
Model No.	HG-T1010	HG-T1110
Position detection method	CMOS-based	
Installation distance	0 to 500mm	0 to 500mm
When side view attachment HG-TSV10 is mounted	0 to 100mm (typical)	-
Measurement width	10 mm	
Light source	Red semiconductor laser: Class 1 [IEC/EN/JIS/GB/KS Standards, FDA Regulations <sup>(Note 1)</sup> Maximum output: 0.3 mW, Peak emission wavelength: 655 nm	
Sampling cycle	1 ms (standard sampling) or 0.5 ms (high-speed sampling)	
Repeatability <sup>(Note 2)</sup>	1 μm (Installation distance: 20 mm) 2.5 μm (Installation distance: 100 mm) 5 μm (Installation distance: 500 mm)	
Linearity <sup>(Note 3)</sup>	±0.12% F.S (Installation distance: 20 mm) ±0.28% F.S (Installation distance: 100 mm)	
Minimum sensing object <sup>(Note 4)</sup>	φ0.5 mm (Installation distance: 500 mm)	
Temperature characteristics <sup>(Note 5)</sup>	±0.03%F.S./°C	
Protection	IP67 (IEC)(Excluding connectors)	
Pollution degree	2	
Ambient temperature	-10 to +45°C (No condensation or icing), Storage: -20 to +60°C	
Ambient operating humidity	35% to 85% RH, Storage: 35% to 85% RH	
Ambient illuminance	Incandescent light: 5,000 lx or less at the light-receiving face <sup>(Note 6)</sup>	
Elevation	2,000 m or lower <sup>(Note 7)</sup>	
Insulation resistance	20 MΩ or higher, using 250 V DC megger (between all terminals and case)	
Vibration resistance	10 to 55 Hz with 1.5 mm amplitude in X, Y and Z directions for two hours each	
Shock resistance	196 m/s <sup>2</sup> in X, Y and Z directions three times each	
Grounding method	Capacitor grounding	
Materials	Case: Aluminum die casting, Light emitting and light receiving surfaces: Glass	
Cable	0.2-m 4-conductor shielded cable with round connectors	
Weight (main unit only)	Emitter: Approx. 30 g, Receiver: Approx. 30 g	Emitter: Approx. 30 g, Receiver: Approx. 25 g
Standards compliance	EU Law : EMC Directive / British Legislation: EMC Regulations / FDA Regulations	

## 9.1 Specifications

---

All the specifications shown above are based on the values that are digitally measured when the sensor head is combined with controller **HG-TC**.

This does not apply when Side View Attachment **HG-TSV10** (optional) is mounted.

Specification conditions that are not particularly specified are shown below.

- Ambient temperature: +20°C
- Average number of controller setting times: 16 times
- Measured object: Opaque knife edge
- Installation distance: 100 mm
- Measured object position conditions: Middle position of installation distance / Half shading

- (Note 1) This product complies with the FDA regulations (FDA 21 CFR 1040.10 and 1040.11) in accordance with FDA Laser Notice No. 56, except for complying with IEC 60825-1 Ed. 3.
- (Note 2) Peak-to-peak value of variations in digital measured values at the middle position of the installation distance and under half shading conditions
- (Note 3) Indicates an error with the ideal straight line of digital measured values.
- (Note 4) When the light is blocked at the center position of 500 mm installation distance
- (Note 5) When the light is half-blocked at the center position of 100 mm installation distance
- (Note 6) When the sampling cycle of the controller is set to "standard sampling"
- (Note 7) Do not use or store this product in environments where ambient air is pressurized to an air pressure higher than the atmospheric pressure at an altitude of 0 m.

9.2 Dimension Drawings

9.2.1 Controller

Units: mm

**HG-TC101, HG-TC101-P / Master unit of high-performance type**

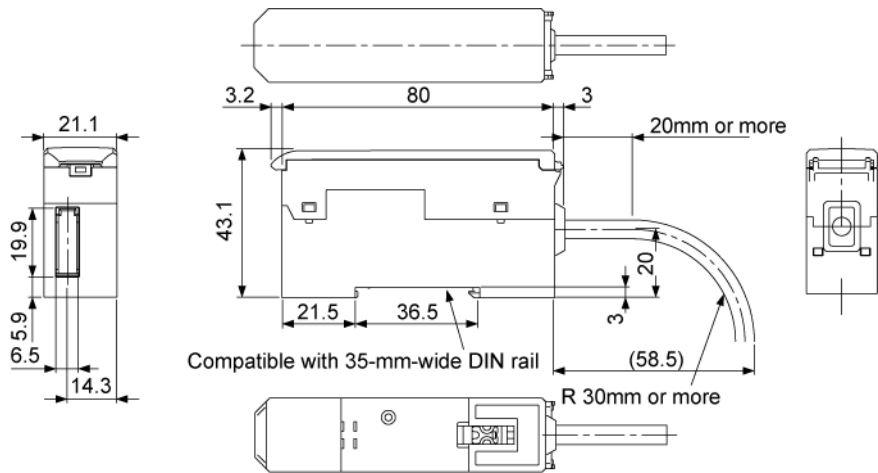

**HG-TC111, HG-TC111-P / Slave unit of high-performance type**

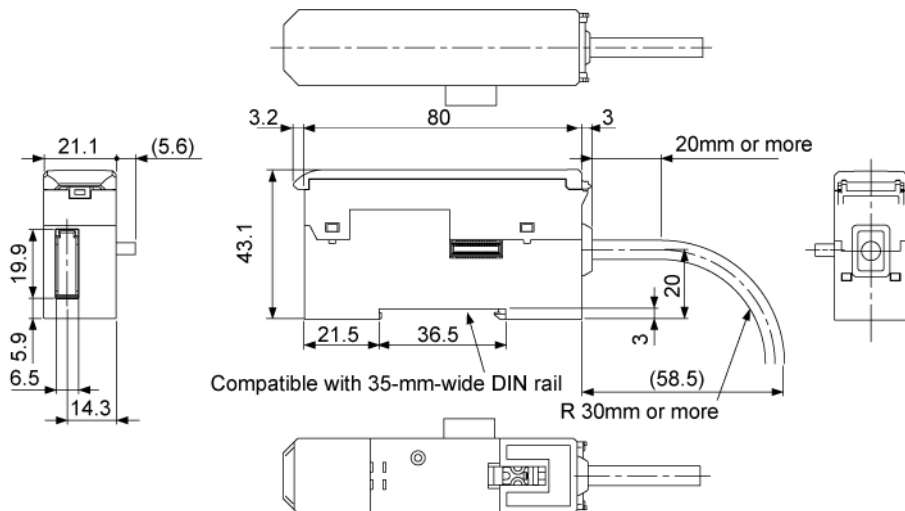

## 9.2 Dimension Drawings

### HG-TC113 / Slave unit of wire-saving type

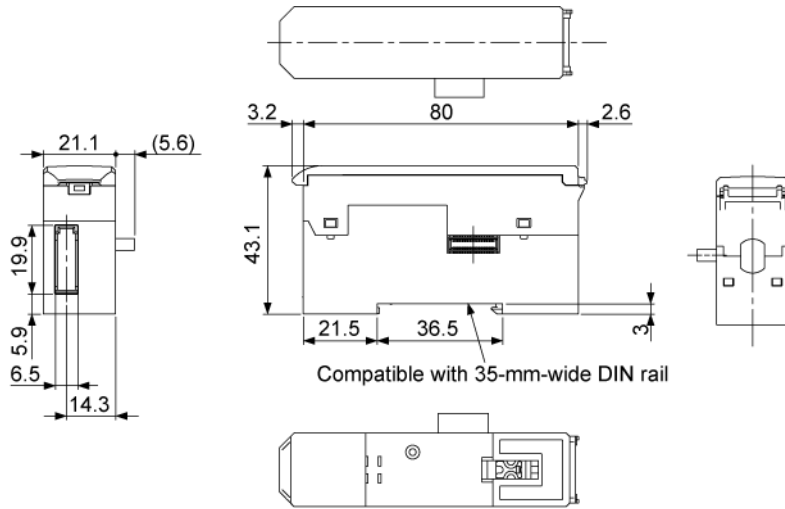

### Sensor head connection cable CN-HT-C□ (option) mounting diagram (Common to HG-TC101 / HG-TC101-P, HG-TC111 / HG-TC111-P, and HG-TC113)

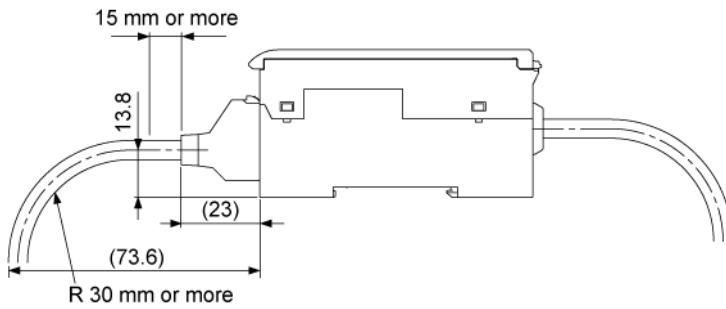



9.2.2 Sensor Head

HG-T1010 / Measurement width 10 mm, standard type

Units: mm

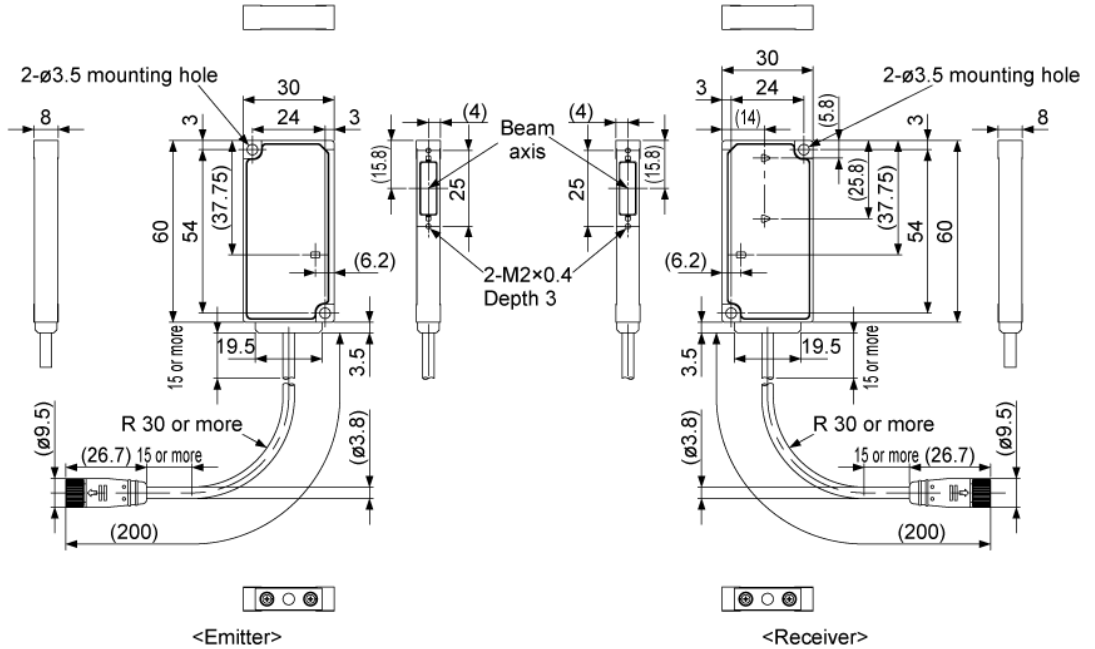

HG-T1110 / Measurement width 10 mm, slim type

Units: mm

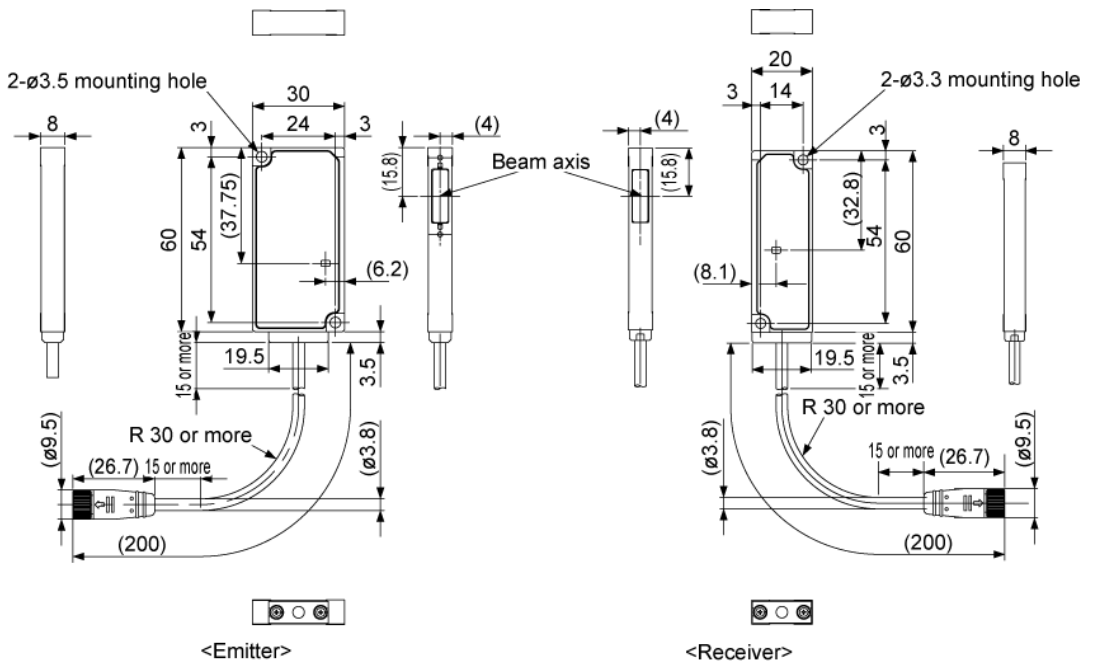

## 9.2 Dimension Drawings

### 9.2.3 Side View Attachment

#### HG-TSV10

Units: mm

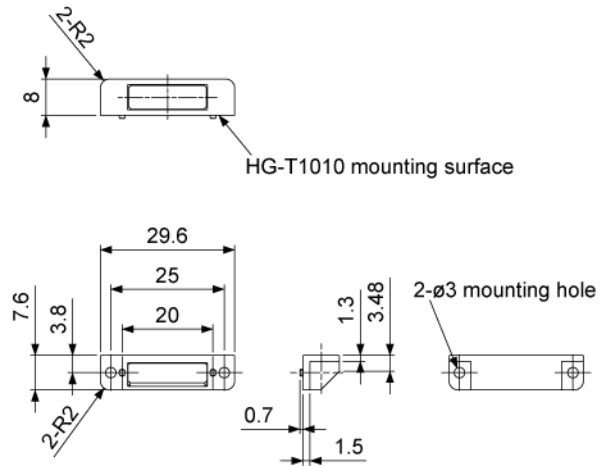

Notes 1): Side view attachments cannot be mounted on sensor head **HG-T1110** (measurement width 10 mm, slim type).

# 10 Maintenance

---

10.1 Maintenance and Inspection .....	10-2
10.1.1 Maintenance Precautions .....	10-2
10.1.2 Main Inspection Items .....	10-2

## 10.1 Maintenance and Inspection

---

### 10.1 Maintenance and Inspection

#### 10.1.1 Maintenance Precautions

- Always turn OFF the power before cleaning the product.
- Never use thinner, benzene, or other organic solvents to wipe off dirt or dust.
- To remove any dirt that adheres to the controller and the light emitting and light receiving surfaces of the sensor head, use compressed air or gently wipe off using a clean, soft cloth. If the surfaces are very dirty, wipe off dirt using a cotton swab (or similar material) moistened with absolute alcohol.

#### 10.1.2 Main Inspection Items

Inspect the controller regularly to maintain performance and enable optimum use.

The main inspection items are as follows:

- Have any input and output terminals become loose or come off?
- Is the supplied power within the rated voltage range (24 V DC  $\pm 10\%$ )?
- Is the ambient temperature within the specified range (-10 to +45°C)?
- Is the ambient humidity within the specified range (35 to 85% RH)?
- Does any dirt or foreign objects adhere to the light emitting and receiving surfaces of the sensor head?
- Has the cumulative operating period of the sensor head or controller exceeded 87,600 hours?

# 11 Troubleshooting

---

11.1 Troubleshooting.....	11-2
11.2 Error Messages.....	11-5

## 11.1 Troubleshooting

### 11.1 Troubleshooting

Solutions to frequently encountered problems and errors are described below.

#### Note

- Check the wiring.
- Check the voltage and capacity of the power supply.
- When the **HG-T** controller manufactured prior to January 2019 is used, some functions will be restricted. For details, consult your Panasonic representative.

Symptom	Cause	Solution	Reference page
Nothing is displayed in the digital display section of the controller	Power is not supplied.	Check if the capacity of the power supply is sufficient. Connect the power supply correctly.	"P.9-2"
	The controller is not connected correctly.	Check the controller connections.	"P.4-10"
	Eco mode is ON.	Set Eco mode to OFF.	"P.7-35"
Judgment value is not displayed correctly	Laser emission stop input is ON.	Set laser emission stop input to OFF.	"P.7-13"
	The measured object is not within the measurement range.	Check if the measured object is within the measurement range.	-
	Obstacles exist within the measurement range.	Remove the obstacles.	-
	The hold function is ON.	Check the settings of the hold function.	"P.7-8"
	The sensor head is not installed correctly.	Install the emitter and receiver correctly.	"P.4-4"
	The operation mode is not set correctly.	Check the settings of the operation mode.	"P.6-9"
	The specified direction of measurement is opposite to the direction in which the measured object is inserted.	Change the specified direction of measurement to TOP or BOTTOM.	"P.6-10"
Display of judgment values is not stable	The reference waveform is not registered correctly.	After adjusting the beam axis, register the reference waveform.	"P.5-15"
	The average count is set to a small value (response time is fast).	Set the average count to a large value (response time is slow).	"P.6-11"
	Dust, dirt, or other foreign matters adhere to the light emitting and receiving surfaces of the sensor head.	To remove any dirt that adheres to the light emitting and light receiving surfaces of the sensor head, use compressed air or gently wipe off using a clean, soft cloth. If the surfaces are very dirty, wipe off dirt using a cotton swab (or similar material) moistened with absolute alcohol.	-
	Dust, dirt, or other foreign matters adhere to the measured object.	Remove any dust, dirt, or other foreign matters that adhere to the measured object.	-

Symptom	Cause	Solution	Reference page
	The receiver of the sensor head is receiving ambient light from surrounding photoelectric sensors, inverters, or other devices.	Mount a shielding plate to prevent ambient light from hitting the receiver of the sensor head. Mount a shielding plate at a certain angle to the sensor head.	-
	Dust, grit, or other substances are flying in the operating environment.	Use a dust collector or similar device to remove and prevent dust, grit, and other substances from flying in the operating environment.	-
	The sensor head is installed in a location subject to severe vibration.	Take measures against vibration.	-
	Mutual interference is occurring.	Set the interference prevention function to ON.	"P.7-42"
	The distance between the installed emitter and receiver exceeds the specified range.	Ensure that the distance between the installed emitter and receiver is within the specified range.	"P.9-9"
	The distance between the sensor head receiver and the measured object is too far.	Make the distance between the installed emitter and receiver as short as possible.	-
	The serial number of the emitter differs from that of the receiver.	Use a pair of emitter and receiver with the same serial number.	-
Judgment value shifts	The reference waveform is not registered correctly.	After adjusting the beam axis, register the reference waveform.	"P.5-15"
	The measured object is inclined relative to the measurement range.	Place the measured object in the correct position.	-
	The distance between the installed emitter and receiver exceeds the specified range.	Ensure that the distance between the installed emitter and receiver is within the specified range.	"P.9-9"
	Dust, dirt, or other foreign matters adhere to the light emitting and receiving surfaces of the sensor head.	To remove any dirt that adheres to the light emitting and light receiving surfaces of the sensor head, use compressed air or gently wipe off using a clean, soft cloth. If the surfaces are very dirty, wipe off dirt using a cotton swab (or similar material) moistened with absolute alcohol.	-
	Dust, dirt, or other foreign matters adhere to the measured object.	Remove any dust, dirt, or other foreign matters that adhere to the measured object.	-
	The preset value is not set correctly.	Specify the preset value correctly.	"P.6-23"
	Analog scaling is not set correctly.	Set analog scaling correctly.	"P.7-30"
Analog output is not generated correctly.	Analog output line is not wired correctly.	Wire the analog output line correctly.	"P.4-3"
Keys cannot be operated	The key lock function is ON.	Set the key lock function to OFF.	"P.7-41"

## 11.1 Troubleshooting

---

### **Important**

If the product still does not operate normally after you check the above, consult your Panasonic representative.



## 11.2 Error Messages

If an error occurs during setting or measurement, one of the errors below will appear in the digital display section / MAIN.

Error display	Cause	Solution
E 100	Both NPN output types and PNP output types are connected.	Connect only units of the same output type.
E 110	Number of connectable units exceeded.	Make sure that no more than 15 slave units are connected to a master unit (or no more than 14 slave units are connected if a communication unit is connected).
E 120	Controllers cannot communicate with each other.	Switch OFF the power, make sure the controllers are connected correctly, and then switch ON the power again.
E 130		
E 140	The calculation function is valid but no slave units are connected.	Change calculation mode to OFF.
E 150	The calculation function is valid but an insufficient number of slave units are connected.	Change calculation mode to OFF or change the calculation application selection setting.
E 160	The saved number of connected units does not match the actual number of connected units.	Make sure that the saved number of connected units matches the actual number of connected units and then switch ON the power again.
E 170	The master unit executed copying, but copying failed due to abnormal behavior of the slave unit.	Check whether the connected slave unit is <b>HG</b> series.
E200	<ul style="list-style-type: none"> <li>• Sensor head not connected.</li> <li>• Broken wire in sensor head connection cable.</li> <li>• Sensor head failure.</li> <li>• Sensor head other than <b>HG-T</b> series connected.</li> </ul>	<ul style="list-style-type: none"> <li>• Check if the sensor head is correctly connected.</li> <li>• Check if there is a broken wire in the sensor head connection cable. If there is a broken wire in the sensor head connection cable, replace the cable.</li> <li>• Replace the sensor head.</li> <li>• Connect an <b>HG-T</b> series sensor head.</li> </ul>
E230	Both connected sensor heads are emitters or receivers.	Connect an emitter and receiver correctly.
E240	Emitter problem.	Replace the emitter.
E500	Unable to preset by external input.	<ul style="list-style-type: none"> <li>• Check if you attempted to preset immediately after the power was turned ON or a reset was input.</li> <li>• Check if the system is in an indeterminate state.</li> <li>• Check if the display value is outside the display upper / lower limit.</li> <li>• Check if an alarm has occurred.</li> </ul>
E5 10	The beam axis adjustment function was executed when laser emission stop input was ON.	Set laser emission stop input to OFF and then execute the beam axis adjustment function.
E600	Unable to write to the EEPROM of the controller.	<ul style="list-style-type: none"> <li>• Switch the power OFF and then ON, and execute initialization of the controller from setting mode.</li> <li>• If the controller does not recover after the above action, it is possible that the EEPROM write count is over one million. Replace the controller.</li> </ul>
E6 10	Unable to read from the EEPROM of the controller.	
E620	The controller EEPROM write count is over the service life of 1 million times.	

## 11.2 Error Messages

Error display	Cause	Solution
E630	<ul style="list-style-type: none"> <li>Unable to write or read to / from the EEPROM of the sensor head receiver.</li> <li>Data is invalid.</li> </ul>	<ul style="list-style-type: none"> <li>Switch the power OFF and then ON, and execute initialization of the controller from setting mode.</li> <li>If the controller does not recover after the above action, consult your Panasonic representative.</li> </ul>
E640	<ul style="list-style-type: none"> <li>Unable to write or read to / from the EEPROM of the sensor head emitter.</li> <li>Data is invalid.</li> </ul>	
E700	The detection output load has short-circuited and overcurrent is flowing.	Switch OFF the power and check the load.
E900	An error has occurred inside the controller.	Switch the power OFF and then ON, and execute initialization of the controller from setting mode.
E910		
E911		
E912		
E920		

### ■ Important

If an error occurs again after you cleared it:

- Check if an excessive force is applied to the controller or the sensor head.
- If the product still does not operate normally after you check the above, consult your Panasonic representative.

# Appendix Menu Structure

---

Menu Structure (General Function Display).....	App-2
Menu Structure (Extended Function Display) .....	App-4

# Menu Structure (General Function Display)

## Menu Structure (General Function Display)

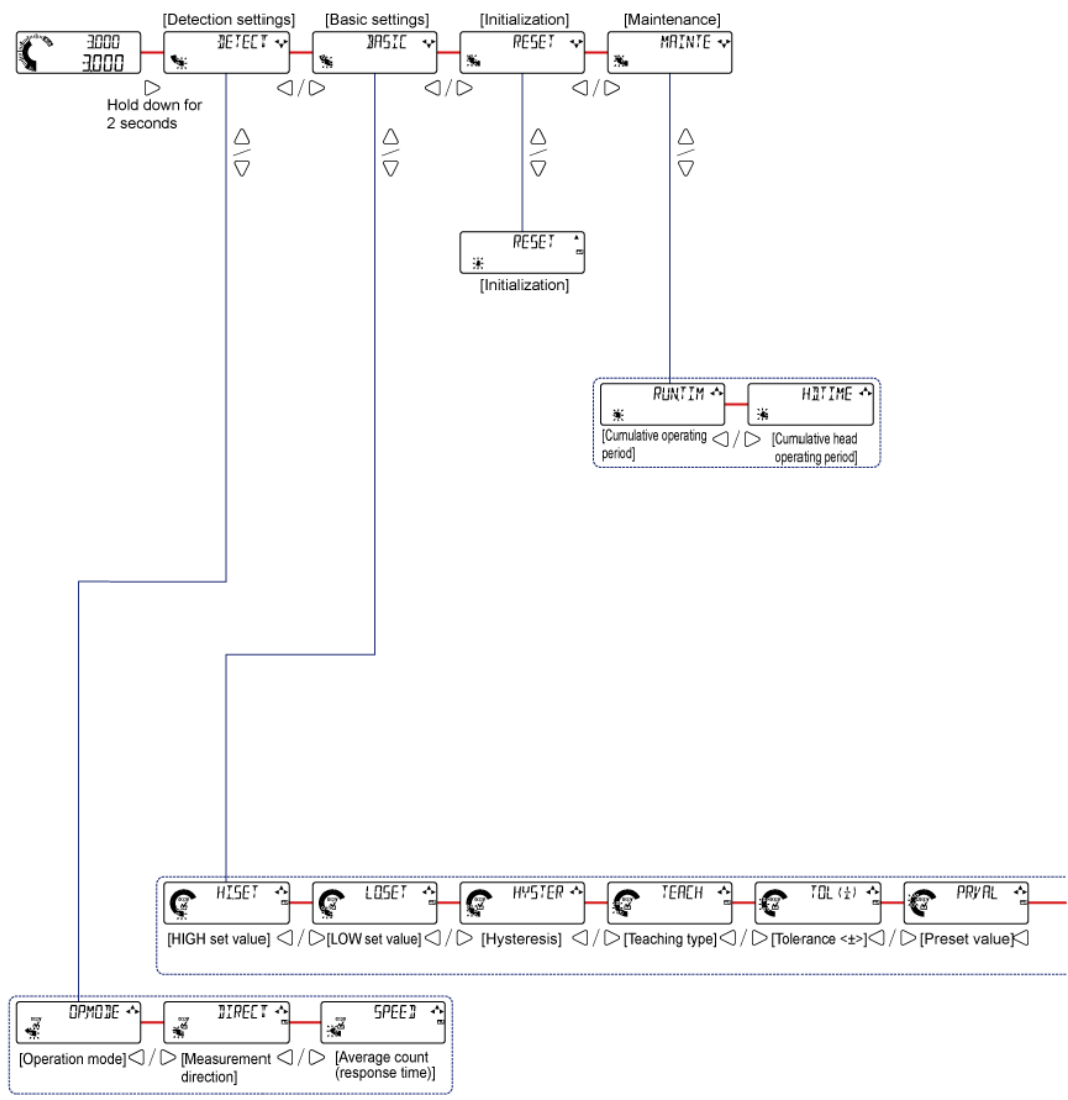

# Menu Structure (General Function Display)

---

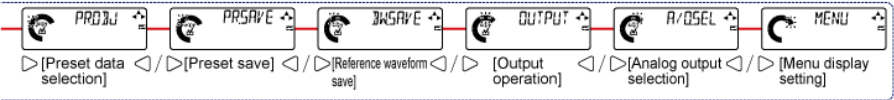

# Menu Structure (Extended Function Display)

## Menu Structure (Extended Function Display)

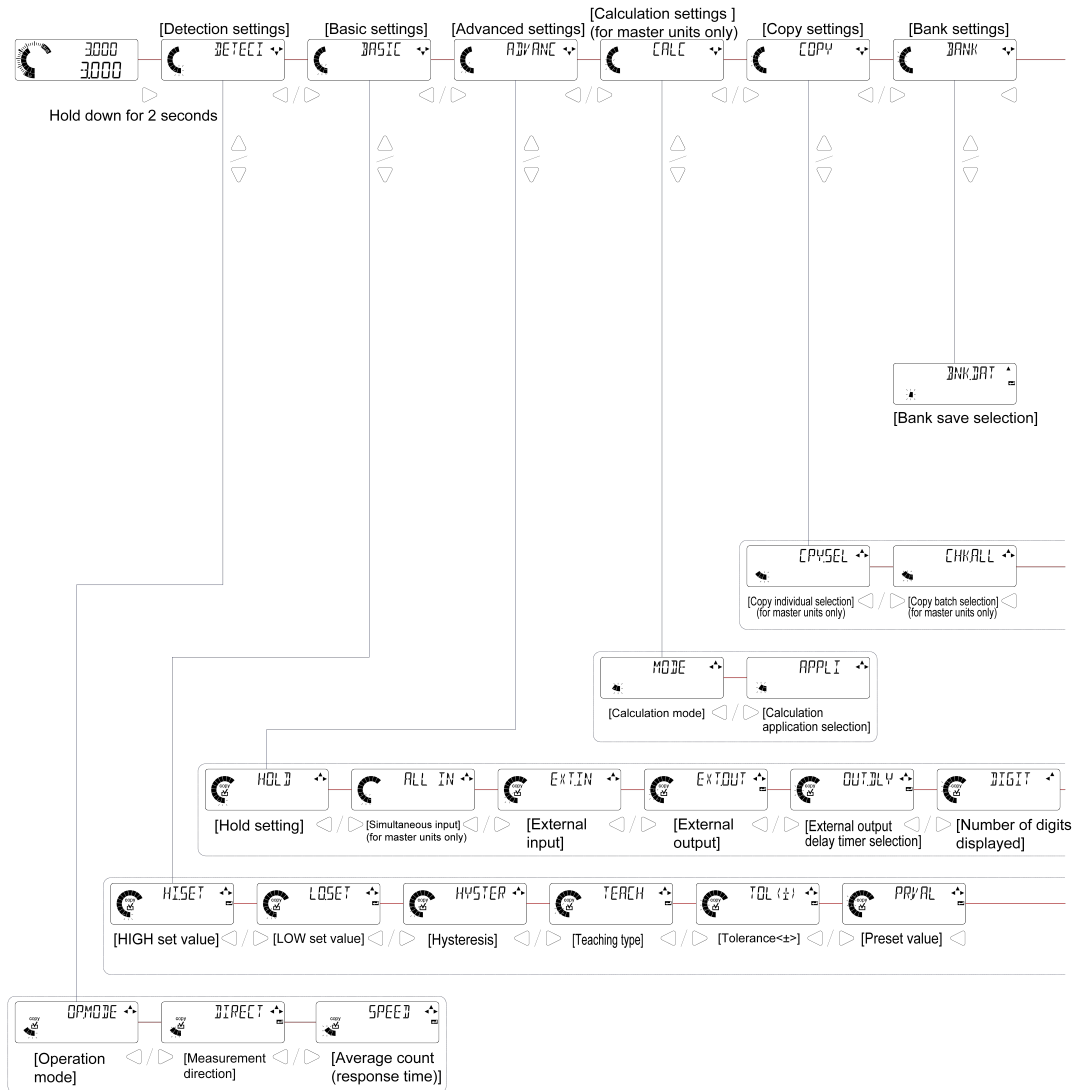

# Menu Structure (Extended Function Display)

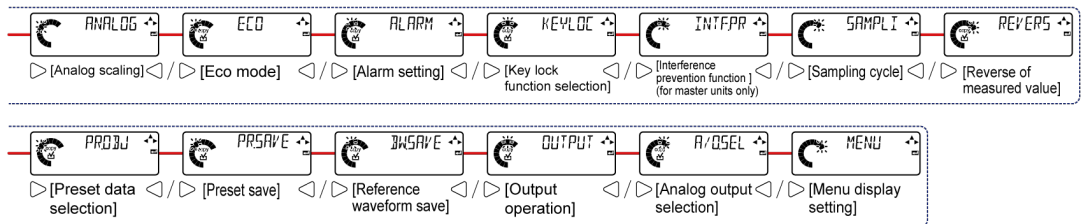
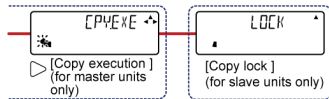
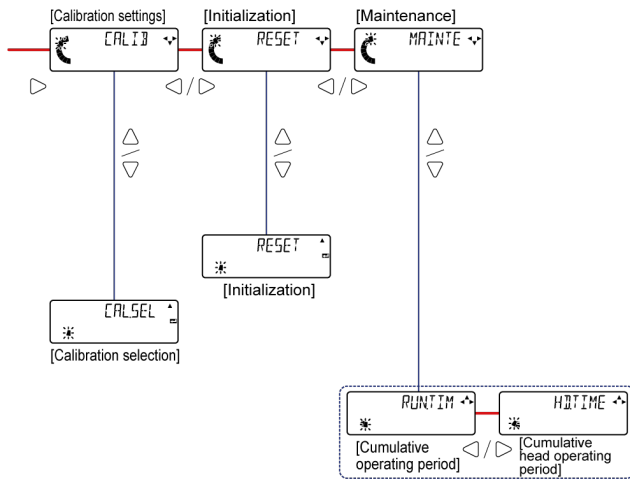

(MEMO)



## Revision History

Revision history	Revision date	Revision item
First edition	Oct. 5, 2018	
Second edition	Nov. 12, 2018	Correction of mistakes
Third edition	Feb. 1, 2019	"Chapter 6 Setting up General Functions", "Chapter 7 Setting up Extended Functions", "Chapter 11 Appendix" added
Fourth edition	Dec. 1, 2019	Correction of mistakes, "5.6 Self-monitoring Function" added
Fifth edition	Apr. 28, 2020	Manual format changed, correction of mistakes
Sixth edition	Nov. 1, 2020	Ver. 1.20 supported "1.6 Product Version and Functions", "5.4.6 User-specified Edge Detection Mode", "7.2.13 Reverse of Measured Value", and "7.7 Tab Cancellation Function" added
Seventh edition	June. 1, 2021	"Chapter 8 Setting up Measurement Mode" added, correction of mistakes
Eighth edition	Apr. 1, 2024	Made revisions in line with the change of the company name.
Nine edition	Jul. 15, 2024	Added installation distance for when side view attachment HG-TSV10 is mounted.

## Order Placement Recommendations and Considerations

The Products and Specifications listed in this document are subject to change (including specifications, manufacturing facility and discontinuing the Products) as occasioned by the improvements of Products. Consequently, when you place orders for these Products, Panasonic Industry Co., Ltd. asks you to contact one of our customer service representatives and check that the details listed in the document are commensurate with the most up-to-date information.

### [Safety precautions]

Panasonic Industry Co., Ltd. is consistently striving to improve quality and reliability. However, the fact remains that electrical components and devices generally cause failures at a given statistical probability. Furthermore, their durability varies with use environments or use conditions. In this respect, check for actual electrical components and devices under actual conditions before use. Continued usage in a state of degraded condition may cause the deteriorated insulation. Thus, it may result in abnormal heat, smoke or fire. Carry out safety design and periodic maintenance including redundancy design, design for fire spread prevention, and design for malfunction prevention so that no accidents resulting in injury or death, fire accidents, or social damage will be caused as a result of failure of the Products or ending life of the Products.

The Products are designed and manufactured for the industrial indoor environment use. Make sure standards, laws and regulations in case the Products are incorporated to machinery, system, apparatus, and so forth. With regard to the mentioned above, confirm the conformity of the Products by yourself.

Do not use the Products for the application which breakdown or malfunction of Products may cause damage to the body or property.

- i) usage intended to protect the body and ensure security of life
- ii) application which the performance degradation or quality problems, such as breakdown, of the Products may directly result in damage to the body or property

It is not allowed the use of Products by incorporating into machinery and systems indicated below because the conformity, performance, and quality of Products are not guaranteed under such usage.

- i) transport machinery (cars, trains, boats and ships, etc.)
- ii) control equipment for transportation
- iii) disaster-prevention equipment / security equipment
- iv) control equipment for electric power generation
- v) nuclear control system
- vi) aircraft equipment, aerospace equipment, and submarine repeater
- vii) burning appliances
- viii) military devices
- ix) medical devices (except for general controls)
- x) machinery and systems which especially require the high level of reliability and safety

### [Acceptance inspection]

In connection with the Products you have purchased from us or with the Products delivered to your premises, please perform an acceptance inspection with all due speed and, in connection with the handling of our Products both before and during the acceptance inspection, please give full consideration to the control and preservation of our Products.

### [Warranty period]

Unless otherwise stipulated by both parties, the warranty period of our Products is one year after the purchase by you or after their delivery to the location specified by you. The consumable items such as battery, relay, filter and other supplemental materials are excluded from the warranty.

### [Scope of warranty]

In the event that Panasonic Industry Co., Ltd. confirms any failures or defects of the Products by reasons solely attributable to Panasonic Industry Co., Ltd. during the warranty period, Panasonic Industry Co., Ltd. shall supply the replacements of the Products, parts or replace and/or repair the defective portion by free of charge at the location where the Products were purchased or delivered to your premises as soon as possible.

However, the following failures and defects are not covered by warranty and we are not responsible for such failures and defects.

- (1) When the failure or defect was caused by a specification, standard, handling method, etc. which was specified by you.
- (2) When the failure or defect was caused after purchase or delivery to your premises by an alteration in construction, performance, specification, etc. which did not involve us.
- (3) When the failure or defect was caused by a phenomenon that could not be predicted by the technology at purchasing or contracted time.
- (4) When the use of our Products deviated from the scope of the conditions and environment set forth in the instruction manual and specifications.
- (5) When, after our Products were incorporated into your products or equipment for use, damage resulted which could have been avoided if your products or equipment had been equipped with the functions, construction, etc. the provision of which is accepted practice in the industry.
- (6) When the failure or defect was caused by a natural disaster or other force majeure.
- (7) When the equipment is damaged due to corrosion caused by corrosive gases etc. in the surroundings.

The above terms and conditions shall not cover any induced damages by the failure or defects of the Products, and not cover your production items which are produced or fabricated by using the Products. In any case, our responsibility for compensation is limited to the amount paid for the Products.

### [Scope of service]

The cost of delivered Products does not include the cost of dispatching an engineer, etc. In case any such service is needed, contact our sales representative.

**Panasonic Industry Co., Ltd.**

(MEMO)

---

## Panasonic Industry Co., Ltd.

1006, Oaza Kadoma, Kadoma-shi, Osaka 571-8506, Japan  
<https://industry.panasonic.com/>

Please visit our website for inquiries and about our sales network.

© Panasonic Industry Co., Ltd. 2018-2024  
July, 2024

WUME-HGT-9