

PROGRAMMABLE DISPLAY

**GT series**

General-purpose serial communication

**Manual**

---

# Safety Precautions

Observe the following notices to ensure personal safety or to prevent accidents.  
To ensure that you use this product correctly, read this User's Manual thoroughly before use.  
Make sure that you fully understand the product and information on safety.  
This manual uses two safety flags to indicate different levels of danger.

## **WARNING**

**If critical situations that could lead to user's death or serious injury is assumed by mishandling of the product:**

- Always take precautions to ensure the overall safety of your system, so that the whole system remains safe in the event of failure of this product or other external factor.
- DO NOT USE THE PROGRAMMABLE DISPLAY TO CONTROL SAFETY FEATURES OR OTHER CRITICAL OPERATIONS OF EQUIPMENT OR SYSTEMS. A COMMUNICATION ERROR (FOR ANY REASON) MIGHT PREVENT SUCH SAFETY FEATURES OR CRITICAL OPERATIONS FROM FUNCTIONING PROPERLY.
- Do not use this product in areas with inflammable gas. It could lead to an explosion.
- Exposing this product to excessive heat or open flames could cause damage to the lithium battery or other electronic parts.
- Battery may explode if mistreated. Do not recharge, disassemble or dispose of fire.

## **CAUTION**

**If critical situations that could lead to user's injury or only property damage is assumed by mishandling of the product.**

- To prevent excessive exothermic heat or smoke generation, use this product at the values less than the maximum of the characteristics and performance that are assured in these specifications.
- Do not dismantle or remodel the product. It could cause excessive exothermic heat or smoke generation.
- Do not touch the terminal while turning on electricity. It could lead to an electric shock.
- Use the external devices to function the emergency stop and interlock circuit.
- Connect the wires or connectors securely.  
The loose connection could cause excessive exothermic heat or smoke generation.
- Do not allow foreign matters such as liquid, flammable materials, metals to go into the inside of the product. It could cause excessive exothermic heat or smoke generation.
- Do not undertake construction (such as connection and disconnection) while the power supply is on. It could lead to an electric shock.
- The control force of the touch switches should be less than the specification of the product. Failure to do so could lead to a damage to the product or a personal injury.
- These touch switches operate using analog resistance membrane. Do not press more than one point on the screen at a time. Doing so might operate a switch located in the middle of the points pressed if one exists, and could lead to a damage to the facility or an accident.

# Copyright / Trademarks

- This manual and its contents are copyrighted.
- You may not copy this manual in whole or part, without written consent of Panasonic Industry Co., Ltd.
- Windows is a registered trademark of Microsoft Corporation in the United States and other countries.
- Ethernet is a registered trademark of Fuji Xerox Co., Ltd. and Xerox Corp.
- SDHC logo and SD logo are trademarks.
- All other company names and product names are trademarks or registered trademarks of their respective owners.

# Table of Contents

---

<b>1. Communication Methods</b>	<b>1-1</b>
<b>1.1 Communicating with External Devices</b>	<b>1-2</b>
1.1.1 Communication Between GT and External Devices	1-2
1.1.2 Communication Mode Type	1-3
<b>1.2 Internal Memory Configuration</b>	<b>1-5</b>
<b>2. Settings and Connections</b>	<b>2-1</b>
<b>2.1 Setting on GTWIN</b>	<b>2-2</b>
2.1.1 Selecting PLC Model	2-2
2.1.2 Selecting Communication Mode	2-3
2.1.3 Communication Parameters	2-4
2.1.4 Transmission of GT Configuration Data	2-5
<b>2.2 Connecting to External Devices</b>	<b>2-6</b>
<b>3. Command Response Mode</b>	<b>3-1</b>
<b>3.1 What is Command Response Mode</b>	<b>3-2</b>
3.1.1 Overview of Communication Mode	3-2
3.1.2 Setting Communication Conditions	3-2
3.1.3 Basic Formats	3-3
3.1.4 Control Codes	3-4
3.1.5 Command Codes	3-4
3.1.6 BCC (Block Check Code)	3-5
3.1.7 Error Codes	3-6
3.1.8 Restrictions	3-6
<b>3.2 Command Code Reference</b>	<b>3-7</b>
<b>4. Two-way 1 Mode</b>	<b>4-1</b>
<b>4.1 What is Two-way 1 Mode</b>	<b>4-2</b>
4.1.1 Overview of Communication Mode	4-2
4.1.2 Setting Communication Conditions	4-2
4.1.3 Change in CTS Signal When Responded from GT (Except GT01)	4-3
4.1.4 Basic Formats	4-4
4.1.5 Control Codes	4-5
4.1.6 Command Codes	4-5
4.1.7 BCC (Block Check Code)	4-6
4.1.8 Error Codes	4-7
4.1.9 Restrictions	4-7
<b>4.2 Command Code Reference</b>	<b>4-8</b>

4.2.1 Transmitting Commands From External Device	4-8
4.2.2 Transmitting Messages From GT	4-13
<b>5. Two-way 2 Mode</b>	<b>5-1</b>
<b>5.1 What is Two-way 2 Mode</b>	<b>5-2</b>
5.1.1 Overview of Communication Mode	5-2
5.1.2 Setting Communication Conditions	5-3
5.1.3 Change in CTS Signal When Responded from GT (Except GT01)	5-4
5.1.4 Basic Formats	5-5
5.1.5 Control Codes	5-6
5.1.6 Command Codes	5-6
5.1.7 BCC (Block Check Code)	5-7
5.1.8 Error Codes	5-8
5.1.9 Restrictions	5-8
<b>5.2 Command Code Reference</b>	<b>5-9</b>
5.2.1 Transmitting Commands From External Device	5-9
5.2.2 Transmitting Messages From GT	5-15
<b>6. Documentation</b>	<b>6-1</b>
<b>6.1 ASCII Code Table</b>	<b>6-2</b>
<b>6.2 Error Codes Table</b>	<b>6-3</b>
<b>6.3 Sheet for Basic Communication Area Allocation</b>	<b>6-4</b>
<b>6.4 Connection Diagrams</b>	<b>6-7</b>
6.4.1 Precautions when connecting GT	6-7
6.4.2 RS232C Connection	6-7
6.4.3 RS422 Connection	6-8
6.4.4 RS485 Connection (In Command Response Mode Only)	6-8

# Chapter 1

---

## Communication Methods

# 1.1 Communicating with External Devices

## 1.1.1 Communication Between GT and External Devices

The communication between the GT and an external device is carried out via the GT internal memories. The external device can “control screens” or “display data” by reading/writing the GT internal memories.



### Reference:

For the details on the commands to read/write the internal memories, refer to <Chapter 3, 4 and 5>.

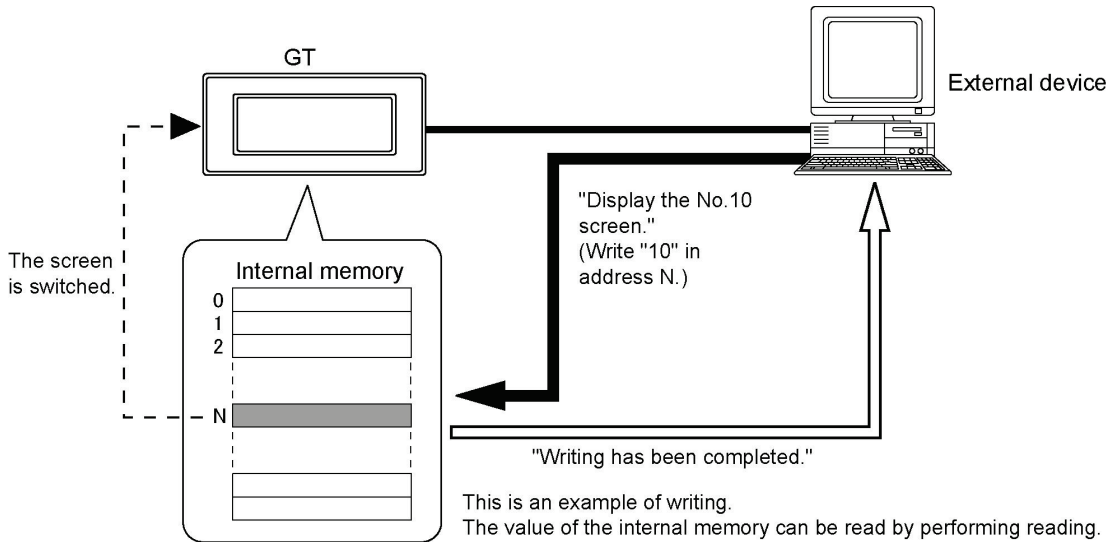

Depending on the communication mode settings, the GT can send a message informing the external device when a switch was pressed.

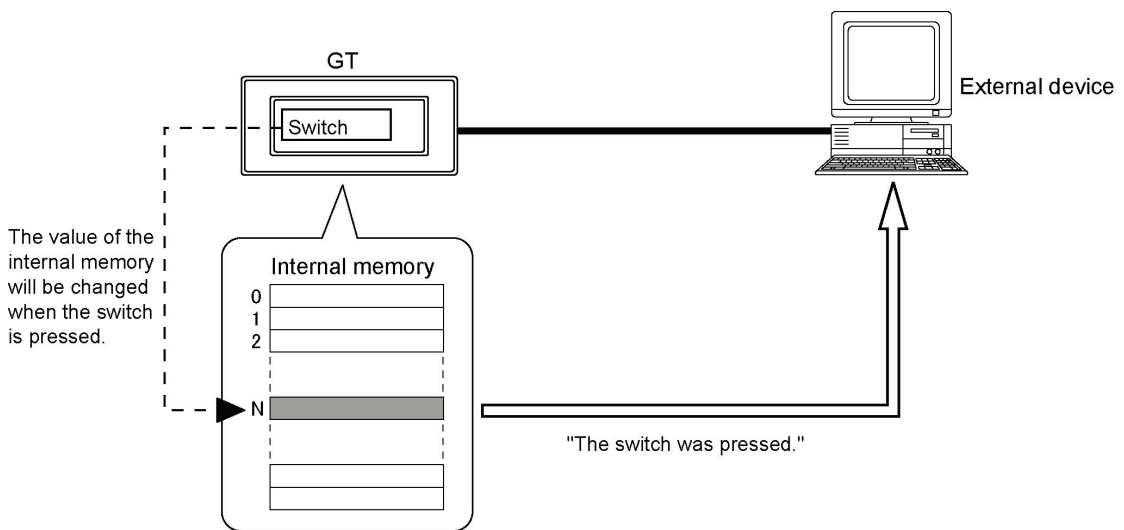

## 1.1.2 Communication Mode Type

The general-purpose serial communication for the GT supports three types of communication modes. Select one of them as usage.

### (1) Command Response mode

The command response mode is an interactive communication mode that an external device sends a command to the GT, and the GT sends back a response. A maximum of 63 GTs can be connected to one external device. (A maximum of 32 units can be connected when using Matsushita C-NET adapter.) In the command response mode, the external device has always the transmission right, and the GT only sends back a response to a command from the external device. Therefore, the external device waits for a response from the GT after sending a command to read the information on the switch input/data settings of the GT.

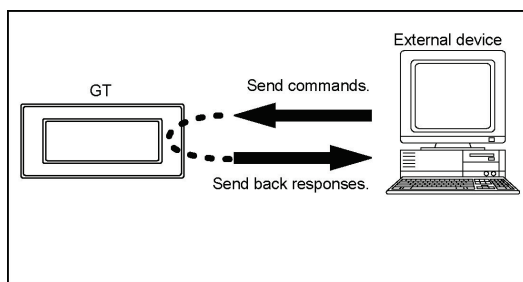

### (2) Two-Way 1 mode

In the two-way 1 mode, an external device sends a command to the GT, and the GT sends a message for transmitting the information on the switch input/data settings. In this mode, the GT does not send back a response for a command to the external device. (It sends back a response for a readout command.) The external device and the GT both have the transmission right. Therefore, the external device waits for the message transmission from the GT by interruption, etc., in order to receive a message for transmitting the information on the switch input/data settings.



**Note:** As no response is returned in the two-way 1 mode, the external device cannot detect errors. In the two-way 2 mode that the response function is available, the external device can detect errors because no response is returned.

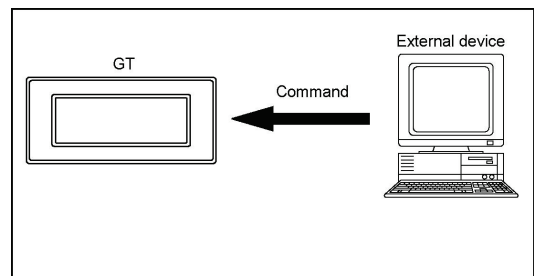
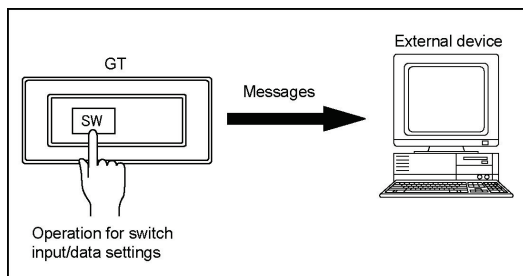

### (3) Two-Way 2 mode

In the two-way 2 mode, an external device sends a command to the GT, and the GT sends a message for transmitting the information on the switch input/data settings. In this mode, the GT sends back a response for a command to the external device.

The external device and the GT both have the transmission right. Therefore, the external device waits for the message transmission from the GT by interruption, etc., in order to receive a message for transmitting the information on the switch input/data settings.



**Key Point:** In the two-way 2 mode that the response function is available, the external device can detect errors because no response is returned.

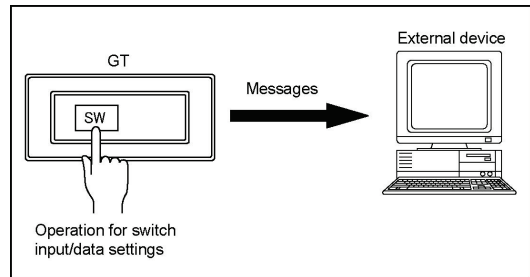
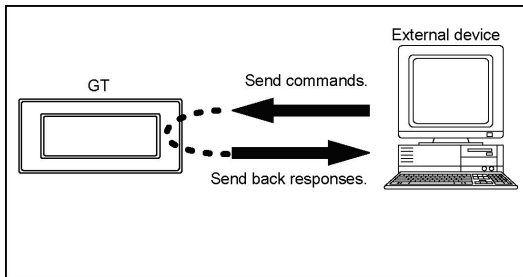



## 1.2 Internal Memory Configuration

There are two types of memories such as “GDT” and “WGR” in the internal memories of the GT. These internal memories are called “internal devices”.

Bit/Word devices		No.	Remarks
Bit device	Internal relay	GR0 to GR255F	
Word device	Internal relay	WGR0 to WGR255	
	Data register	GDT0 to GDT2047	
	Special Data Register	GDT9080 to GDT9086	Built-in clock data

### GDT

GDT is a device (memory) area that is convenient to be used for the data treated in word unit, and it is called “data register”.

The device size is 0000 to 2047.

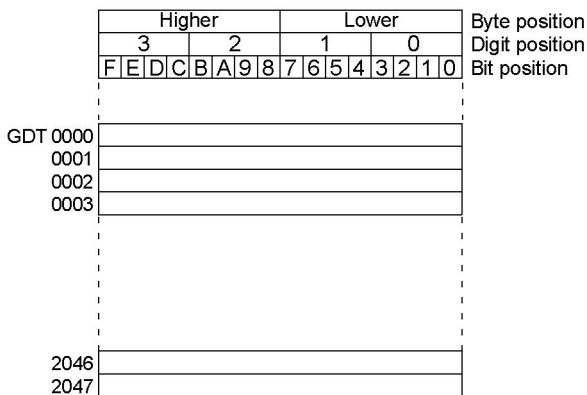

### WGR

WGR is a device (memory) area that is convenient to be used for the data treated in bit unit, and it is called “internal relay”.

The device size is 0000 to 0255.

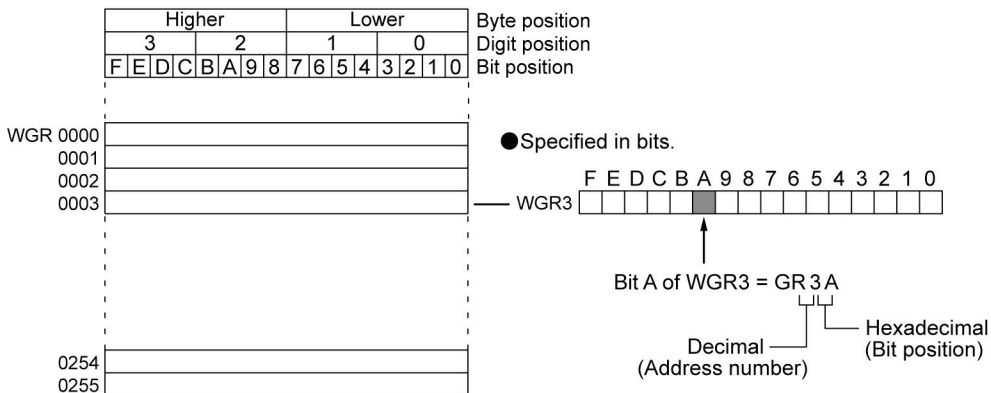

### Clock data storage devices (GDT9080 to GDT9086)

The data of the clock built in the GT is stored in the data registers GDT9080 to GDT9086. The data can be read by using the readout command of the data registers.

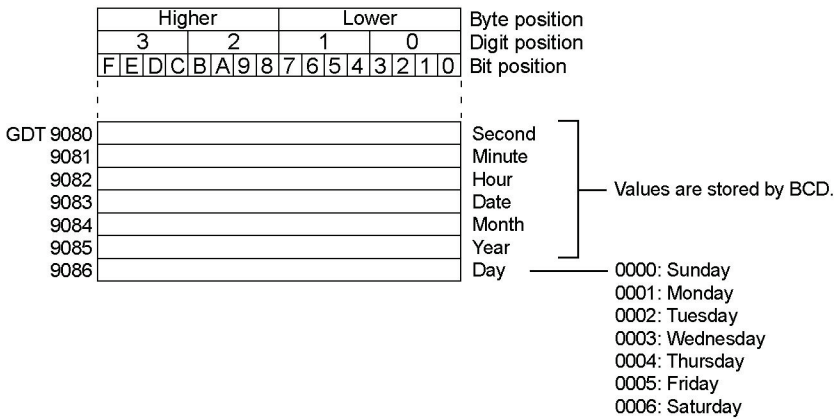

**Note:**

- The built-in clock in the GT cannot be adjusted from the external device. Change the mode of the GT to the setting mode and select “Clock” from the menu to adjust the time.



**Reference:** For the detailed procedure, refer to <GT Series Technical Manual>.

- The clock function is not available for the models that a battery cannot be installed.
- The values of era name stored in GDT9085 are the last two digits of the year.

# Chapter 2

---

## Settings and Connections

## 2.1 Setting on GTWIN

---

The general-purpose serial communication is set using the screen creation tool software Terminal GTWIN.

### 2.1.1 Selecting PLC Model

---

For using the general-purpose serial communication, select "General-Purpose Serial" for PLC Model. Selecting "Create New File" from the start-up menu displays the following dialog box to select models. Click on the  button at the window of the PLC model, and select "General-Purpose Serial" from the pull-down menu.

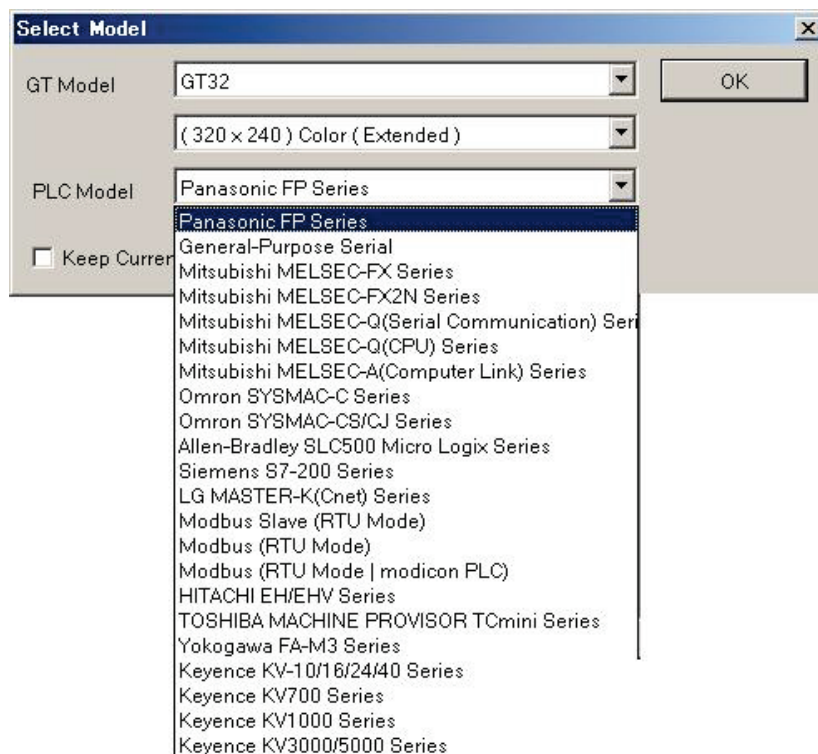

## 2.1.2 Selecting Communication Mode

“Terminal GTWIN”. Select “File” → “Configuration” → “GT Configuration”. The “GT Configuration” dialog box is displayed. Clicking the “Basic Setup” tab displays the following screen. Select the communication mode for the general-purpose serial communication.

### “Basic Setup” screen

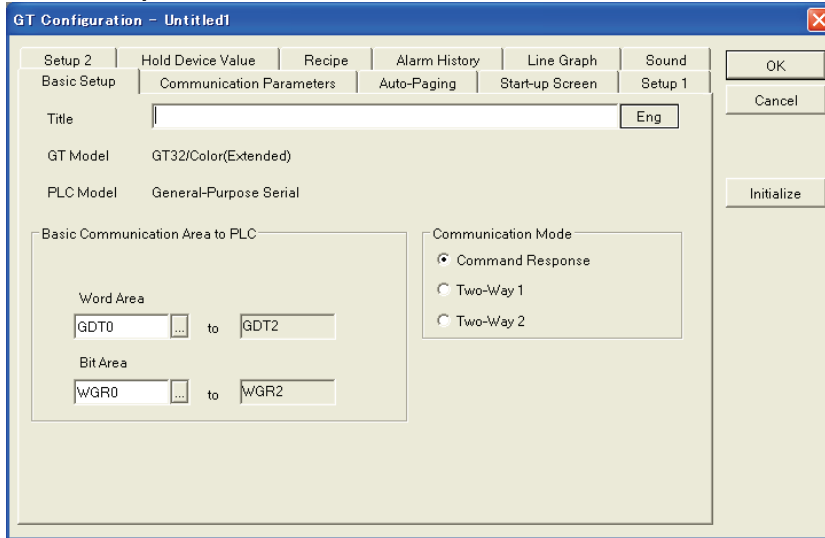

### Selecting Communication Mode

Select any one of the communication modes, “Command Response”, “Two-Way 1” and “Two-Way 2”.

## 2.1.3 Communication Parameters

Selecting “File” → “Configuration” → “GT Configuration” of GTWIN displays the “GT configuration” dialog box. Clicking the “Communication Parameters” tab displays the following screen.

This is where communication parameters for the external device connected to the GT are set.

### “Communication Parameters” screen (GT01, GT11, GT21)

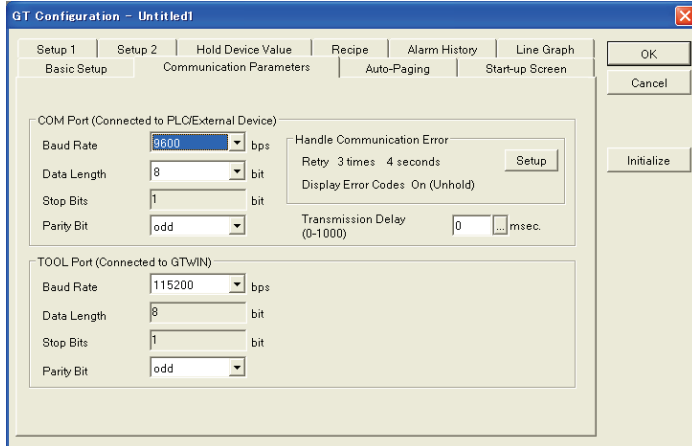

### “Communication Parameters” screen (GT02, GT02L, GT03-E, GT05, GT12, GT32, GT32-E)



### Unit numbers

Specify “unit numbers” when more than one GTs are connected using C-NET.

### COM Port (Connected to PLC/External device)

This is used to specify the baud rate and transmission format when the GT is connected to an external device.

Clicking on the  button displays a pull-down menu from which the value to be set can be selected.

- **Baud rate:** Select 9600, 19200, 38400, 57600 or 115200.
- **Data length:** Select either “7 bits” or “8 bits”.
- **Stop bit:** This is fixed at “1 bit”.
- **Parity:** Select “None”, “Odd” or “Even”.

## Communication System

Select a communication system according to the used communication system.  
(The RS485 communication can be used in the command response mode only.)

## Transmission Delay

The time taken to send the next data from receiving data from an external equipment can be adjusted with the GT. The delay time longer than the preset value can be held by specifying the time until sending data. Set it when the external equipment cannot receive data properly as data transmission is too quick from the GT.

## CS/RS Control (GT02, GT02L, GT03-E, GT05, GT12, GT32, GT32-E)

Select either "Off" or "On". When selecting "On", RS(RTS) always outputs LOW and the transmission is interrupted according to the input status (LOW/HIGH) of CS(CTS). (This setting is available for the RS232C type.)



### Key Point:

GT01 does not have the terminal for CS/RS signal control. When replacing GT01 with GT02, GT02L, GT03-E, GT05, GT12, GT32 or GT32-E, setting the CS/RS control to "Off" enables to replace the models without changing the wirings for external devices.



### Note:

When "Transfer Data After Clear GT Screen" is performed or "Clear F-ROM" is performed from the setting mode of the system menu without connecting a CS/RS signal line although the CS/RS control is set to "On", garbage data is sent to the external device from the GT. (Except GT01, GT11 and GT21)

## 2.1.4 Transmission of GT Configuration Data

The settings specified in 2.1.1 to 2.1.4 will be effective when the "GT Configuration" data is transferred to the GT. (The "GT Configuration" data will be automatically transferred once all the data are transferred.)

Transfer Data - Untitled1

Data to Transfer

- All Data
- Base Screen
- Configuration
- Keyboard Screen
- Login Screen
- Flow Display
- Write Device
- Data Logging
- SD Recipe
- Recipe
- Operation Security Password

Direction

- GTWIN->GT
- GT->GTWIN

Buttons: OK, Cancel, COM Settings, Password, IP Address

Transfer Data After Clear GT Screen:

Update the firmware automatically:

Verify:

Base Screen No.

Keyboard Screen No.

Login Screen No.

SD Recipe No.

Recipe File No.

## 2.2 Connecting to External Devices

The GT is connected to an external device with a RS232C or RS422(RS485) interface.

The RS485 communication can be used in the command response mode only.

### 1:1 connection

1:1 connection is to connect one external device with one GT. The connection is cross connection that each other's sent data signals and received data signals are exchanged.

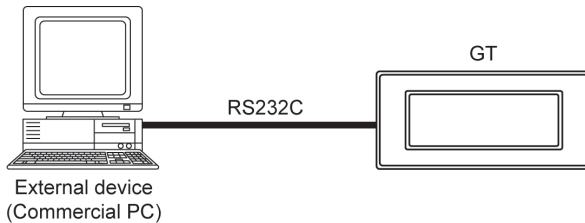

### 1:n connection

1:n connection is to connect one external device and more than two GTs. The connection is multi-dropped connection using devices such as C-NET adapter.



#### Note:

For 1:n communication, the usable communication mode is the command response mode only.

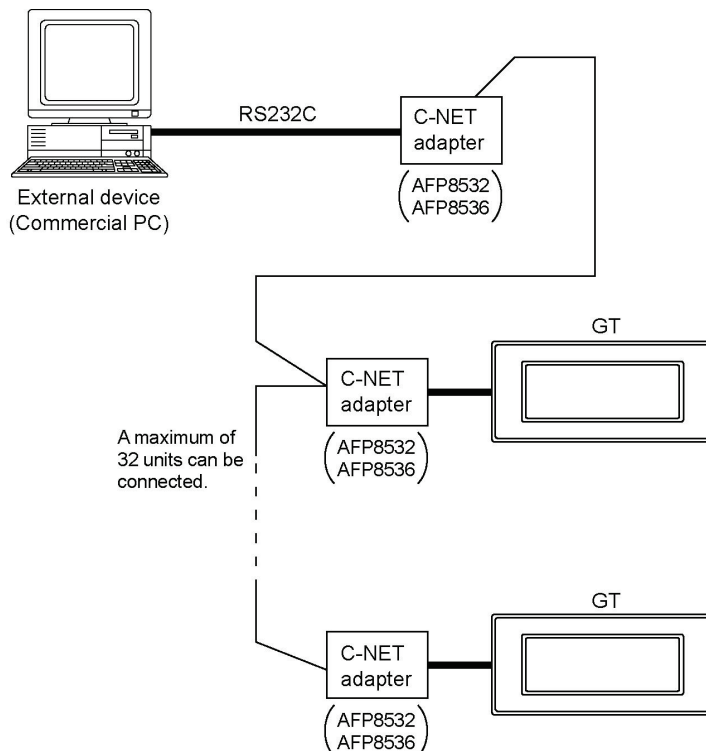

Note) A RS485 - RS232C converter that enables the connection with a maximum of 63 units is necessary to use up to 63 GTs. A maximum of 32 units are connected with the C-NET adapter.



# Chapter 3

---

## Command Response Mode

## 3.1 What is Command Response Mode

### 3.1.1 Overview of Communication Mode

In the command response mode, once a command is sent to the GT from an external device, a response will be sent back to the external device from the GT.

The GT always sends back a response when it received a command. When any response is not sent back, check if the connection of the communication cable is correct or the sent command is correct.

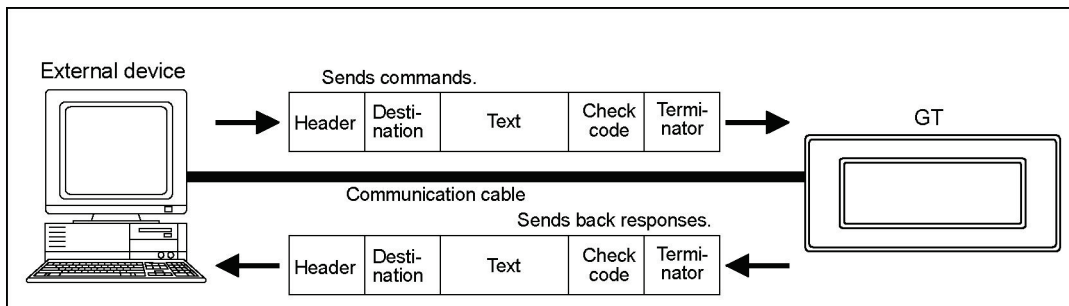

### 3.1.2 Setting Communication Conditions

- Specify the unit numbers within a range of 00 to 63. When making 1:n connection with the external device, do not specify the same unit number for multiple GTs.
- The settings for "Baud rate", "Data length" and "Parity check" should be the same as the communication settings specified on the external device.
- It is not necessary to use the CS/RS control signals in the command response mode. When connecting an external device that does not control them, short-circuit the "RS" and "CS" terminals of the COM port on the GT side or set "CS/RS Control" to "Off"

Item	Settings	Caution
Unit number	00 to 63	Do not specify the same unit number for multiple GTs.
Baud rate	115200/57600/38400/19200/9600 bps	These settings should be the same as the settings specified on the external device.
Data length	7/8 bits	
Stop bits	Fixed: 1 bit	
Parity check	Odd/Even/Invalid	
CS/RS signal control	No CS/RS signal (GT01) Fixed: On (GT11, GT21) On/Off (Other models)	The CS/RS signals are not used in the command response mode.

Note) CS/RS signal (control) is not available for GT01.



#### Reference:

For the details of the communication parameters of GT, refer to <2.1 Setting on GTWIN>.

### 3.1.3 Basic Formats

The formats of the commands sent from the external device and the responses sent back from the GT are as follows.

#### Command

This is a message to be sent to the GT from the external device. Create this command according to the format on the computer.

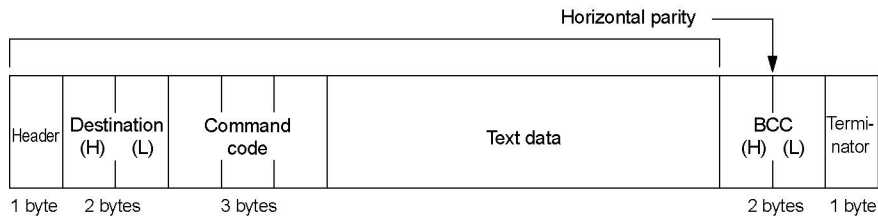

#### Response

(1) In normal condition:

This is a message to be sent back to the external device from the GT. Analyze this message according to the format, and check the operation results, or retrieve the data.

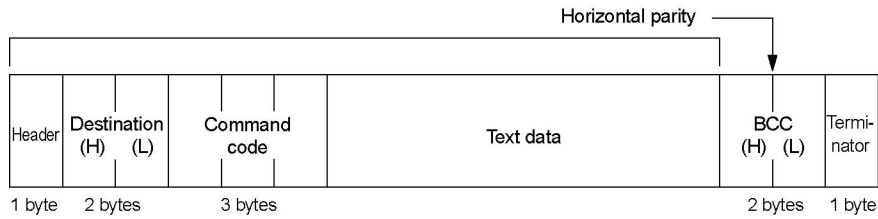

(2) When an error occurred:

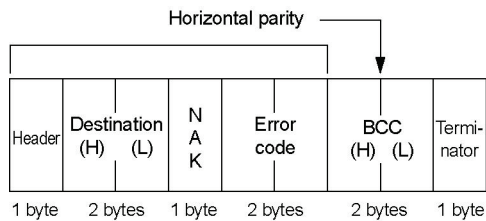

### 3.1.4 Control Codes

---

The control codes (header and terminator) are as follows.

Name	Character	ASCII code	Function
Header	?	3F	Beginning of a message.
Terminator	CR	0D	Completion of a message.
NAK	NAK	15	Response when an error occurs.

### 3.1.5 Command Codes

---

The command codes are as follows.

Type	Character	ASCII code			Function
Read	WDR	57	44	52	Read data area in word unit
	SRR	53	52	52	Read single relay bit
	PRR	50	52	52	Read multiple relay bits
	WRR	57	52	52	Read relay in word unit
Write	WDW	57	44	57	Write data area in word unit
	BDW	42	44	57	Write data area in byte unit
	DDW	44	44	57	Write data area in digit unit
	SDW	53	44	57	Write data area in bit unit
	WRW	57	52	57	Write relay in word unit
	BRW	42	52	57	Write relay in byte unit
	DRW	44	52	57	Write relay in digit unit
SRW	53	52	57	Write relay in bit unit	

### 3.1.6 BCC (Block Check Code)

BCC is the horizontal parity that is from the beginning of the command and response to the end of the text data, and that is two characters of ASCII code which the exclusive OR of the data in the subject range was converted to.

When the BCC check is not performed in the communication conditions for the GT, use "\*\*\*" instead of BCC.

#### Calculation example of BCC

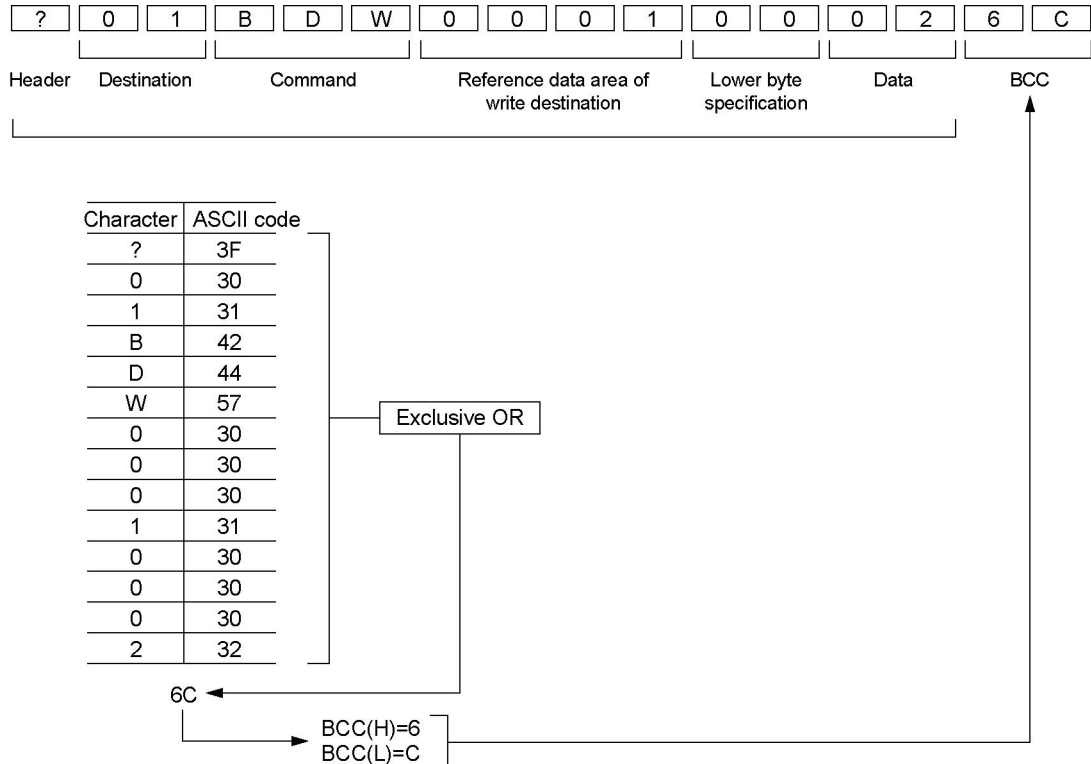

#### Calculation example of BCC in Basic program

```

10 INPUT "==" , A$
20 ANS=0
30 FOR I=1 TO LEN(A$)
40 ANS=ANS XOR ASC(MID$(A$, I, 1))
50 NEXT I
55 PRINT HEX$(ANS)
60 GOTO 10
Ok
run
==> ?01BDW00010002
6C
==>
    
```

### 3.1.7 Error Codes

The error codes are as follows.

#### Error codes

##### For GT01, GT11 and GT21

Error code	Error name	Measures
ER00	BCC error	The value of BCC may be incorrect. Check if there is no calculation mistake.
ER01	Format error	A command format may be incorrect. Check if it is correct.
ER02	NOT supported error	A command used is not supported with the version of the GT. Upgrade the version of the GT, or use another command.
ER03	Address error	The address specified does not exist in the GT. Check the address of the transmitted command.
ER04	Receive buffer overflow	The sent command exceeds the receivable number of bytes. Check the number of bytes of the sent command.
ER05	Requested overflow	The sent readout command exceeds the number of bytes that can send back. Check the number of the read words.
ER06	Data error	The communication condition for the GT may be unmatched with the condition for a destination device. Check the communication conditions.
ER07	Data write inhibit error	A command for the address that writingn is not available was sent. Check the address of the sent command.

##### For GT02, GT02L, GT03-E, GT05, GT12, GT32 and GT32-E

Error code	Error name	Measures
**0000	BCC error	The value of BCC may be incorrect. Check if there is no calculation mistake.
**0001	Format error	A command format may be incorrect. Check if it is correct.
**0002	NOT supported error	A command used is not supported with the version of the GT. Upgrade the version of the GT, or use another command.
**0003	Address error	The address specified does not exist in the GT. Check the address of the transmitted command.
**0004	Receive buffer overflow	The sent command exceeds the receivable number of bytes. Check the number of bytes of the sent command.
**0005	Requested overflow	The sent readout command exceeds the number of bytes that can send back. Check the number of the read words.
**0006	Data error	The communication condition for the GT may be unmatched with the condition for a destination device. Check the communication conditions.
**0007	Data write inhibit error	A command for the address that writingn is not available was sent. Check the address of the sent command.

Note) These are the error codes related to communicaiton.

### 3.1.8 Restrictions

#### Allowable bytes sent and received

The allowable number of bytes to be sent and received in the GT is up to 512 bytes (including CR). Therefore, a command or response of which size is more than 513 bytes cannot be sent from the external device.

## 3.2 Command Code Reference

### [WDR] Read data area in word unit

The word device area in the GT is read in word unit.

#### Command

?	Destination (H) (L)	W	D	R	Starting address of reference data area (4 digits)	Number of words (4 digits)	BCC (H) (L)	CR
---	------------------------	---	---	---	--	-------------------------------	----------------	----

#### Response

?	Destination (H) (L)	W	D	R	Data 1 (4 digits)	....	Data n (4 digits)	BCC (H) (L)	CR
					(Higher)		(Lower)		

### [SRR] Read single relay bit

The bit device area in the GT is read specifying one bit.

#### Command

?	Destination (H) (L)	S	R	R	Contact number	BCC (H) (L)	CR	
					BCD (3 digits)	HEX (1 digit)		

#### Response

?	Destination (H) (L)	S	R	R	Contact data (2 digits)	BCC (H) (L)	CR
					When OFF : 00 When ON : 01		

**[PRR] Read multiple relay bits**

The bit device area in the GT is read in bit unit.

**Command**

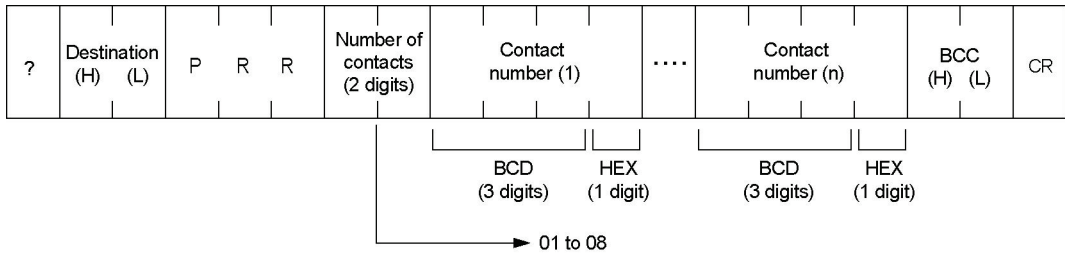

**Response**

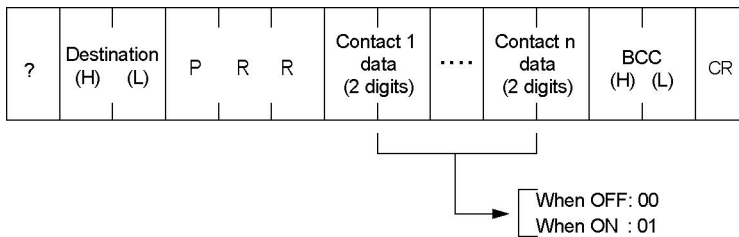

**[WRR] Read relay in word unit**

The bit device area in the GT is read in word unit.

**Command**

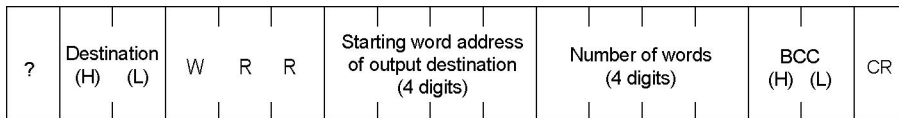

**Response**

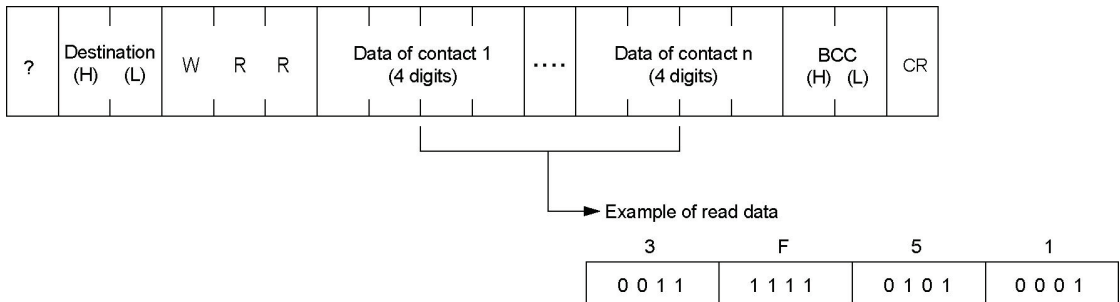



**[WDW] Write data area in word unit**

The word device area in the GT is written in word unit.

**Command**

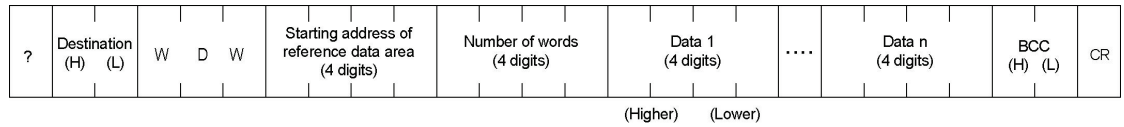

**Response**

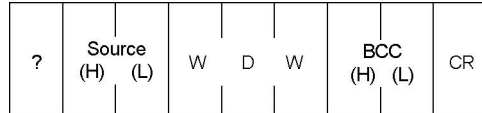

**[BDW] Write data area in byte unit**

The word device area in the GT is written in byte unit.

**Command**

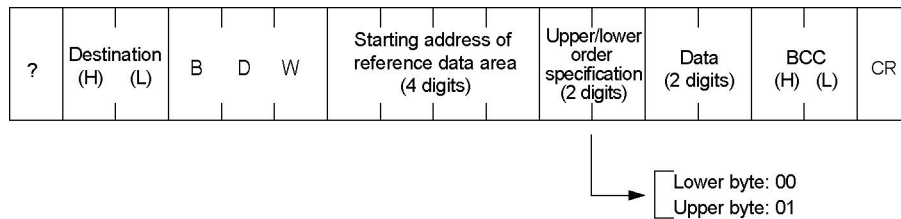

**Response**

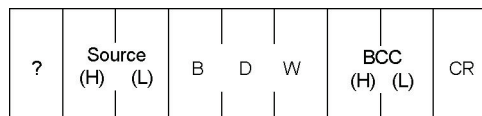

**[DDW] Write data area in digit unit**

The word device area in the GT is written in digit unit.

**Command**

?	Destination (H) (L)	D	D	W	Starting address of reference data area (4 digits)	Digit speci- fica- tion	Data	BCC (H) (L)	CR
---	------------------------	---	---	---	--	----------------------------------	------	----------------	----

(1 digit)(1 digit)

Specify 0 to 3.

F E D C	B A 9 8	7 6 5 4	3 2 1 0
3	2	1	0

**Response**

?	Source (H) (L)	D	D	W	BCC (H) (L)	CR
---	-------------------	---	---	---	----------------	----

**[SDW] Write data area in bit unit**

The word device area in the GT is written in bit unit.

**Command**

?	Destination (H) (L)	S	D	W	Starting address of reference data area (4 digits)	Bit speci- fication	ON/ OFF speci- fication	BCC (H) (L)	CR
---	------------------------	---	---	---	--	---------------------------	----------------------------------	----------------	----

(1 digit)(1 digit)

0: OFF  
1: ON

Specify 0 to F.

**Response**

?	Source (H) (L)	S	D	W	BCC (H) (L)	CR
---	-------------------	---	---	---	----------------	----

### [WRW] Write relay in word unit

The bit device area in the GT is written in word unit.

#### Command

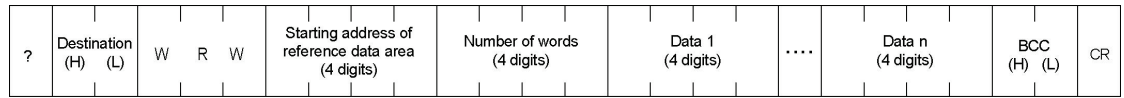

↑  
Highest-order digit is always "0".  
(WGR0000 to WGR0255)

#### Response

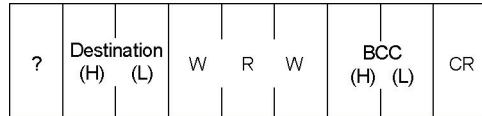

### [BRW] Write relay in byte unit

The bit device area in the GT is written in byte unit.

#### Command

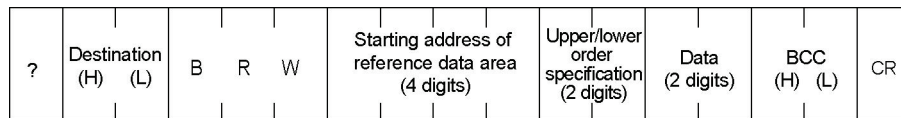

↑  
Highest-order digit is always "0".  
(WGR0000 to WGR0255)

→ Lower byte: 00  
Upper byte: 01

#### Response

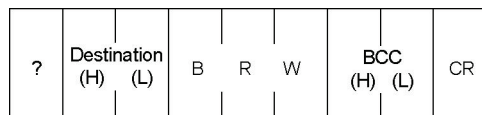

**[DRW] Write relay in digit unit**

The bit device area in the GT is written in digit unit.

**Command**

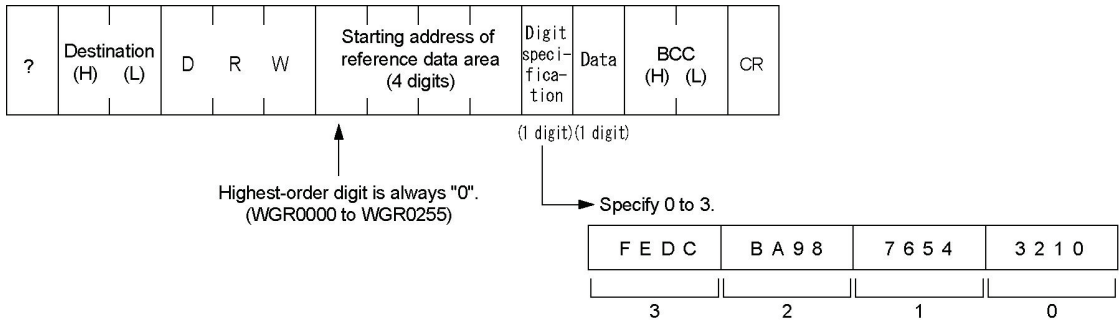

**Response**

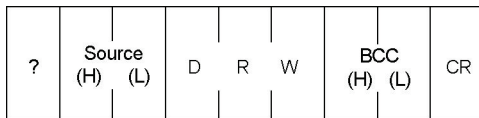

**[SRW] Write relay in bit unit**

The bit device area in the GT is written in bit unit.

**Command**

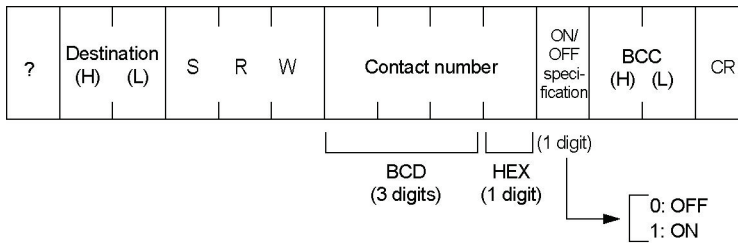

**Response**

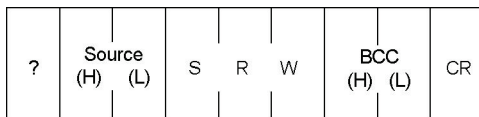

# Chapter 4

---

## Two-way 1 Mode

# 4.1 What is Two-way 1 Mode

## 4.1.1 Overview of Communication Mode

In the two-way 1 mode, an external device sends a command to the GT, and the GT sends a message for transmitting the information on the switch input/data settings. The GT does not send back a response for a command to the external device. If you need to send back responses, use the two-way 2 mode. (It sends back a response for a readout command.)

As the RS and CS signals are not available for the GT01, it is recommended to use the two-way 2 mode.



**Note:** As no response is returned in the two-way 1 mode, the external device cannot detect errors. In the two-way 2 mode that the response function is available, the external device can detect errors because no response is returned.

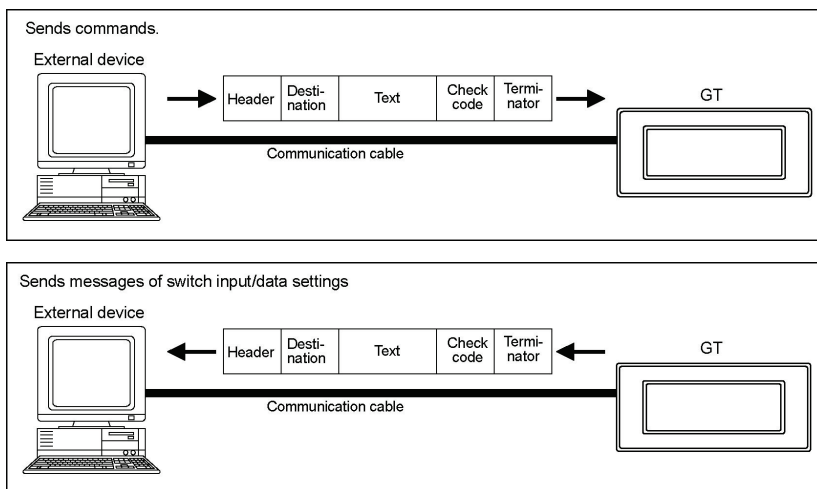

## 4.1.2 Setting Communication Conditions

- The communication in the two-way 1 mode is only available for 1:1 connection, and specify the unit numbers within a range of 00 to 63.
- The settings for "Baud rate", "Data length" and "Parity check" should be the same as the communication settings specified on the external device.
- Connect the CS/RS on the GT and external device when the CS/RS control is necessary. When unnecessary, short-circuit the "RS" and "CS" terminals on the GT side or set "CS/RS Control" to "Off".

Item	Settings	Caution
Unit number	00 to 63	Do not specify the same unit number for multiple GTs.
Baud rate	115200/57600/38400/19200/9600 bps	These settings should be the same as the settings specified on the external device.
Data length	7/8 bits	
Stop bits	Fixed: 1 bit	
Parity check	Odd/Even/Invalid	
CS/RS signal control	No CS/RS signal (GT01) Fixed: On (GT11, GT21) On/Off (Other models)	The CS/RS signals are not used in the command response mode.

Note) CS/RS signal (control) is not available for GT01.



**Reference:**

For the details of the communication parameters of GT, refer to <2.1 Setting on GTWIN>.

### 4.1.3 Change in CTS Signal When Responded from GT (Except GT01)

---

In the two-way 1 mode, the external device and the GT both have the transmission right, so if a command is sent from the external device when a message is being sent from the GT, the normal communication may be interfered. The GT monitors the L/H level <sup>Note)</sup> of the CS (CTS), and in the above case it temporarily interrupts the message transmission so that the normal communication will be maintained. The communication program for the two-way 1 mode should be created at the external device side considering the points below.

1) When the CS (CTS) changes from L to H during a message being sent, the GT will stop sending the message at the time that the CS (CTS) changes to H, and then restart sending the rest of the message after it changes to L.

If a command to request a response is sent from the external device during a message is being sent when the CS (CTS) is H, the GT will resend the rest of the message at the time that the CTS changes to L, and then send a response to the received command.

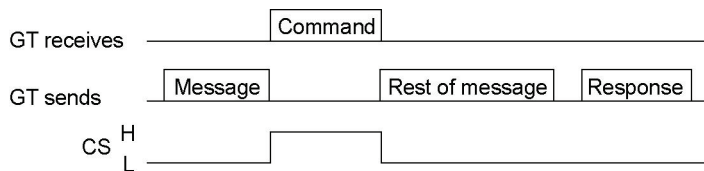

2) If a command is sent from the external device during a message is being sent when the CS (CTS) is L, the GT will continue the message transmission being receiving the command.

3) If commands are sent successively during a message being sent under the condition that a response cannot be sent back and the CS (CTS) is L, the GT will send back a response. However, in that case, it is not assured to which command the response was sent back.

4) When sending commands successively, the next command should be sent after intervals of more than 50 ms.

5) If a screen where to jump is complicated, it may need a long time for GT to change the screen. If commands are sent successively when changing a screen, confirm the time interval of the consecutive commands using the screen data used. The time interval may need to be more than 50 ms depending on the complexity of a screen.

Note) The L/H level shows the signal at the microcomputer port level. It means that L=0 and H=1.

For the voltage of the RS232C port, the plus voltage is output at the level L and the minus voltage at the level H.

## 4.1.4 Basic Formats

### Command

This is a message to be sent to the GT from the external device. Create this command according to the format on the computer.

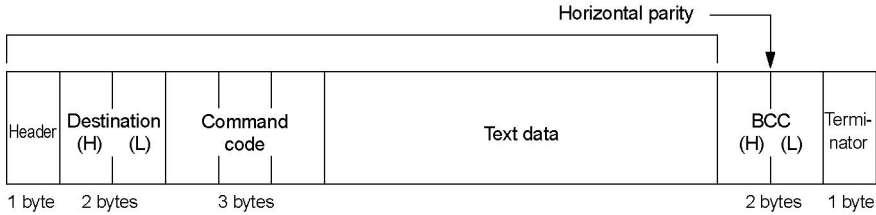

### Response

This is a message to be sent back to the external device from the GT when a readout command was sent. Analyze this message according to the format, and check the operation results, or retrieve the data. For write commands, there is no response (confirmation for the write result).

(2) In normal condition:

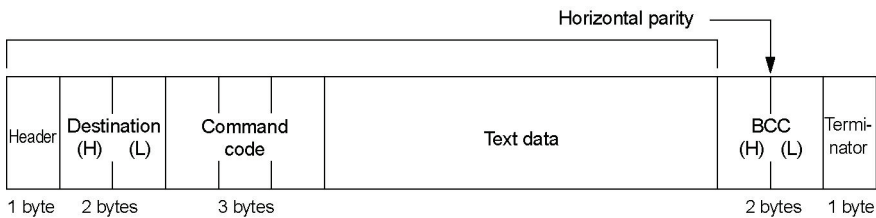

(2) When an error occurred:

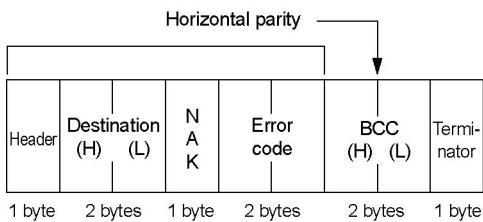

### Message

This is a message to be sent to the external device when the switch operation was performed on the GT. Analyze this message according to the format, and check the operation results, or retrieve the data.

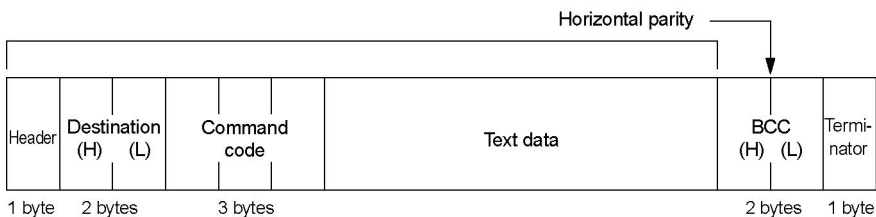



## 4.1.5 Control Codes

The control codes (header and terminator) are as follows.

Name	Character	ASCII code	Function
Header	?	3F	Beginning of a message.
Terminator	CR	0D	Completion of a message.
NAK	NAK	15	Response when an error occurs.

## 4.1.6 Command Codes

The command codes are as follows.

### Command codes used for commands transmitted from external device to GT

Type	Character	ASCII code			Function
Read	WDR	57	44	52	Read data area in word unit
	SRR	53	52	52	Read single relay bit
	PRR	50	52	52	Read multiple relay bits
	WRR	57	52	52	Read relay in word unit
Write	WDW	57	44	57	Write data area in word unit
	BDW	42	44	57	Write data area in byte unit
	DDW	44	44	57	Write data area in digit unit
	SDW	53	44	57	Write data area in bit unit
	WRW	57	52	57	Write relay in word unit
	BRW	42	52	57	Write relay in byte unit
	DRW	44	52	57	Write relay in digit unit
SRW	53	52	57	Write relay in bit unit	

### Command codes included in messages transmitted from GT to external device

Type	Character	ASCII code			Function
Send message	WDR	57	44	52	Send information on data area in word unit
	SRR	53	52	52	Send information on single relay bit
	WRR	57	52	52	Send information on relay in word unit



#### Note:

Even when the GT internal device is not directly operated like this, the information on the internal device changed by the GT internal operation may be sent to the external device as a message.

### 4.1.7 BCC (Block Check Code)

BCC is the horizontal parity that is from the beginning of the command and response to the end of the text data, and that is two characters of ASCII code which the exclusive OR of the data in the subject range was converted to.

When the BCC check is not performed in the communication conditions for the GT, use "\*\*\*" instead of BCC.

#### Calculation example of BCC

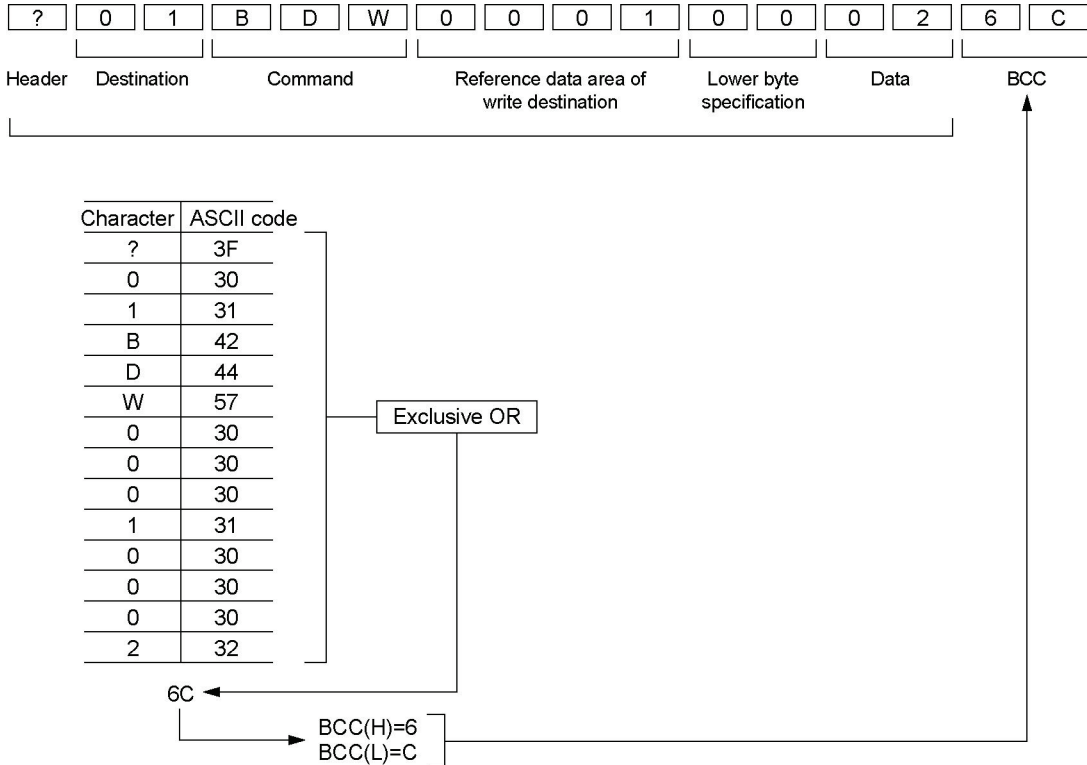

#### Calculation example of BCC in Basic program

```

10 INPUT "==",A$
20 ANS=0
30 FOR I=1 TO LEN(A$)
40 ANS=ANS XOR ASC(MID$(A$,I,1))
50 NEXT I
55 PRINT HEX$(ANS)
60 GOTO 10
Ok
run
==> ?01BDW00010002
6C
==>

```

## 4.1.8 Error Codes

The error codes are as follows.

### For GT01, GT11 and GT21

Error code	Error name	Measures
ER00	BCC error	The value of BCC may be incorrect. Check if there is no calculation mistake.
ER01	Format error	A command format may be incorrect. Check if it is correct.
ER02	NOT supported error	A command used is not supported with the version of the GT. Upgrade the version of the GT, or use another command.
ER03	Address error	The address specified does not exist in the GT. Check the address of the transmitted command.
ER04	Receive buffer overflow	The sent command exceeds the receivable number of bytes. Check the number of bytes of the sent command.
ER05	Requested overflow	The sent readout command exceeds the number of bytes that can send back. Check the number of the read words.
ER06	Data error	The communication condition for the GT may be unmatched with the condition for a destination device. Check the communication conditions.
ER07	Data write inhibit error	A command for the address that writingn is not available was sent. Check the address of the sent command.

### For GT02, GT02L, GT03-E, GT05, GT12, GT32 and GT32-E

Error code	Error name	Measures
**0000	BCC error	The value of BCC may be incorrect. Check if there is no calculation mistake.
**0001	Format error	A command format may be incorrect. Check if it is correct.
**0002	NOT supported error	A command used is not supported with the version of the GT. Upgrade the version of the GT, or use another command.
**0003	Address error	The address specified does not exist in the GT. Check the address of the transmitted command.
**0004	Receive buffer overflow	The sent command exceeds the receivable number of bytes. Check the number of bytes of the sent command.
**0005	Requested overflow	The sent readout command exceeds the number of bytes that can send back. Check the number of the read words.
**0006	Data error	The communication condition for the GT may be unmatched with the condition for a destination device. Check the communication conditions.
**0007	Data write inhibit error	A command for the address that writingn is not available was sent. Check the address of the sent command.

Note) These are the error codes related to communicaiton.

## 4.1.9 Restrictions

### Allowable bytes sent and received

The allowable number of bytes to be sent and received in the GT is up to 512 bytes (including CR). Therefore, a command or response of which size is more than 513 bytes cannot be sent from the external device.

### Restrictions on transmitting messages

In the two-way communication mode, a message will not be sent if the following changes occur in the basic communication area. However, a message is sent if these areas are changed directly using parts such as switch parts. When readout is necessary, use the readout command.

Number of displayed screen
BAT bit
Data input in progress flag
BAT LOW flag

## 4.2 Command Code Reference

---

### 4.2.1 Transmitting Commands From External Device

---

#### [WDR] Read data area in word unit

The word device area in the GT is read in word unit.

##### Command

?	Destination (H) (L)	W D R	Starting address of reference data area (4 digits)	Number of words (4 digits)	BCC (H) (L)	CR
---	------------------------	-------	--	-------------------------------	----------------	----

##### Response

?	Destination (H) (L)	W D R	Data 1 (4 digits)	....	Data n (4 digits)	BCC (H) (L)	CR
			(Higher)	(Lower)			

#### [SRR] Read single relay bit

The bit device area in the GT is read specifying one bit.

##### Command

?	Destination (H) (L)	S R R	Contact number	BCC (H) (L)	CR
			BCD (3 digits)	HEX (1 digit)	

##### Response

?	Destination (H) (L)	S R R	Contact data (2 digits)	BCC (H) (L)	CR
			When OFF : 00 When ON : 01		

### [PRR] Read multiple relay bits

The bit device area in the GT is read in bit unit.

#### Command

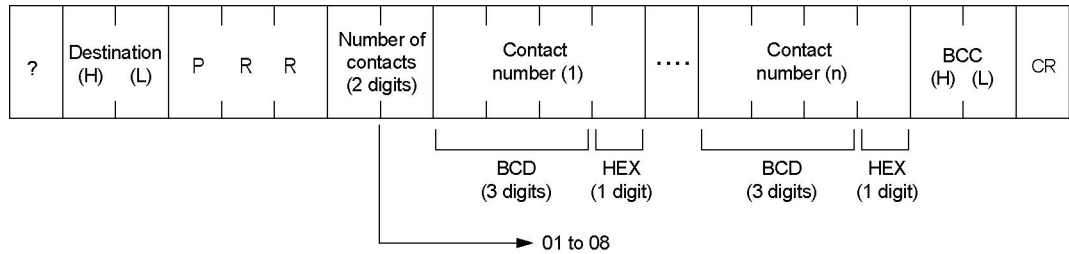

#### Response

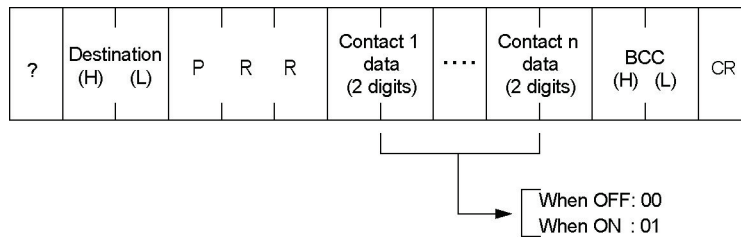

### [WRR] Read relay in word unit

The bit device area in the GT is read in word unit.

#### Command

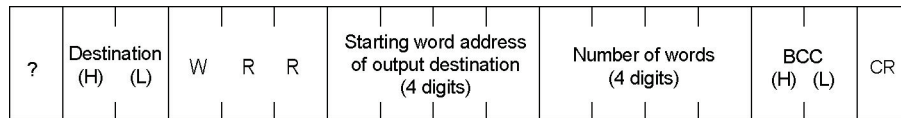

#### Response

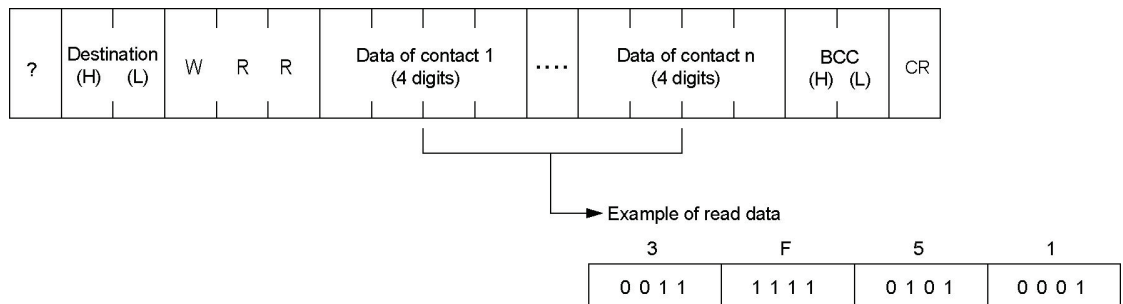

**[WDW] Write data area in word unit**

Data is written in the word device area of the GT in word unit.

**Command**

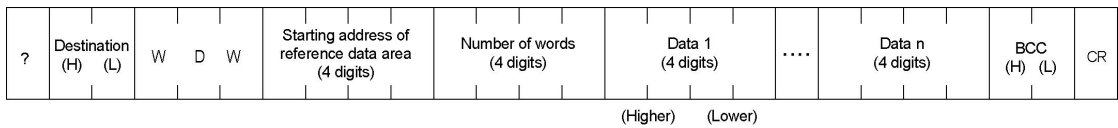

**[BDW] Write data area in byte unit**

Data is written in the word device area of the GT in byte unit.

**Command**

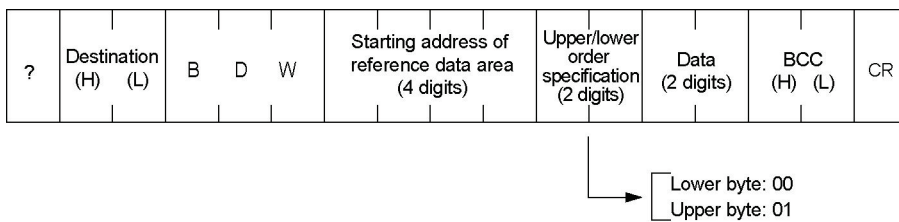

**[DDW] Write data area in digit unit**

Data is written in the word device area of the GT in digit unit.

**Command**

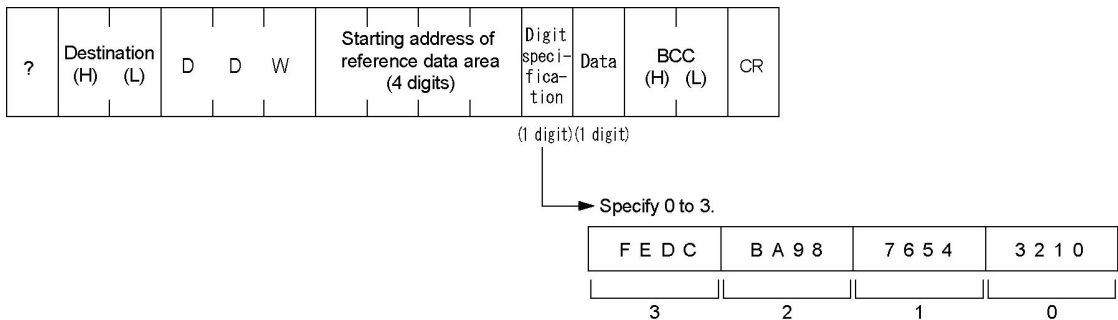

**[SDW] Write data area in bit unit**

Data is written in the word device area of the GT in bit unit.

**Command**

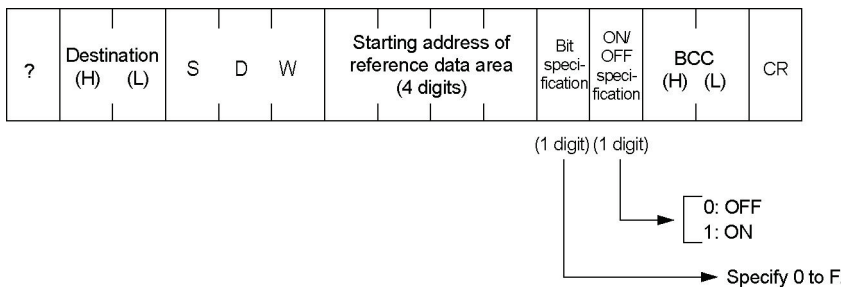

### [WRW] Write relay in word unit

The bit device area in the GT is written in word unit.

#### Command

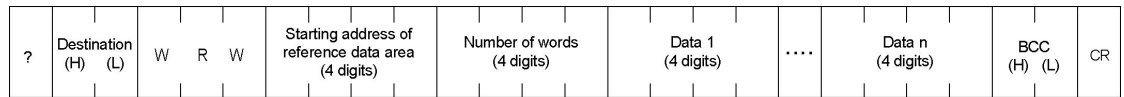

↑  
Highest-order digit is always "0".  
(WGR0000 to WGR0255)

### [BRW] Write relay in byte unit

The bit device area in the GT is written in byte unit.

#### Command

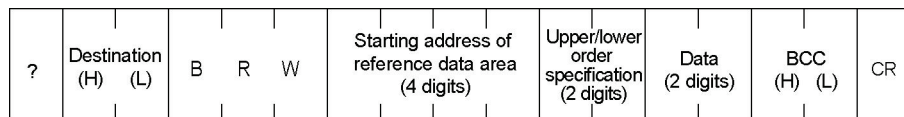

↑  
Highest-order digit is always "0".  
(WGR0000 to WGR0255)

└─ Lower byte: 00  
└─ Upper byte: 01

**[DRW] Write relay in digit unit**

The bit device area in the GT is written in digit unit.

**Command**

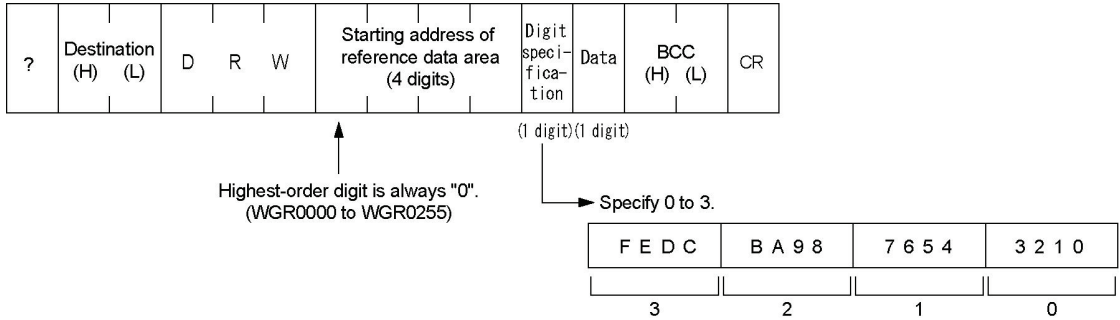

**[SRW] Write relay in bit unit**

The bit device area in the GT is written in bit unit.

**Command**

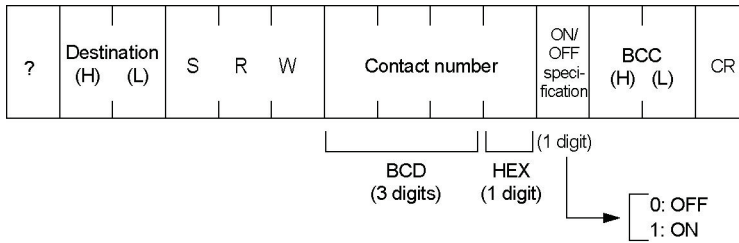



## 4.2.2 Transmitting Messages From GT

### [WDR] Send information on data area in word unit

Data in word unit is sent to a host computer from the GT.

#### Message

?	Destination (H) (L)	W	D	R	Starting address of reference data area (4 digits)	Number of words (4 digits)	Data 1 (4 digits)	....	Data n (4 digits)	BCC (H) (L)	CR
---	------------------------	---	---	---	--	-------------------------------	----------------------	------	----------------------	----------------	----

### [SRR] Send information on single relay bit

The information on On/Off of relay is sent to a host computer from the GT.

#### Message

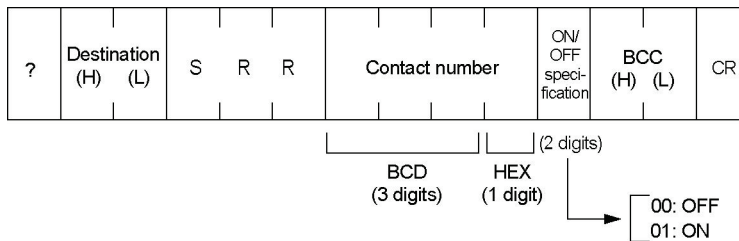

### [WRR] Send information on relay in word unit

Data in the relay area in word unit is sent to a host computer from the GT.

#### Message

?	Destination (H) (L)	W	R	R	Starting address of reference relay (4 digits)	Number of words (4 digits)	Data 1 (4 digits)	....	Data n (4 digits)	BCC (H) (L)	CR
---	------------------------	---	---	---	--	-------------------------------	----------------------	------	----------------------	----------------	----

### How to distinguish between message data and response data from the GT

When using the two-way communication mode, in some cases it is hard to distinguish between the message sent from the GT and the response to the readout command sent from the external device (WDR, SRR, WRR).

In order to distinguish them, adjust the numbers of words and contacts of the readout command sent from the external device.

The GT sends 1-word message when the data format of the write destination that is specified in the switch part or data part is 1 word.

When the format is 2 words, the GT sends 2-word message. It depends on the digit numbers for ASCII of the data part.

Try to make the length of the message sent from the GT different from the length of the response to the readout command sent from the external device, to enable to distinguish them according to the length.



# Chapter 5

---

## Two-way 2 Mode

## 5.1 What is Two-way 2 Mode

### 5.1.1 Overview of Communication Mode

In the two-way 2 mode, an external device sends a command to the GT, and the GT sends a message for transmitting the information on the switch input/data settings. In this mode, the GT sends back a response for a command to the external device.

The readout commands in the word device area and the bit device area (with responses) can be used.



**Key Point:** In the two-way 2 mode that the response function is available, the external device can detect errors because no response is returned.

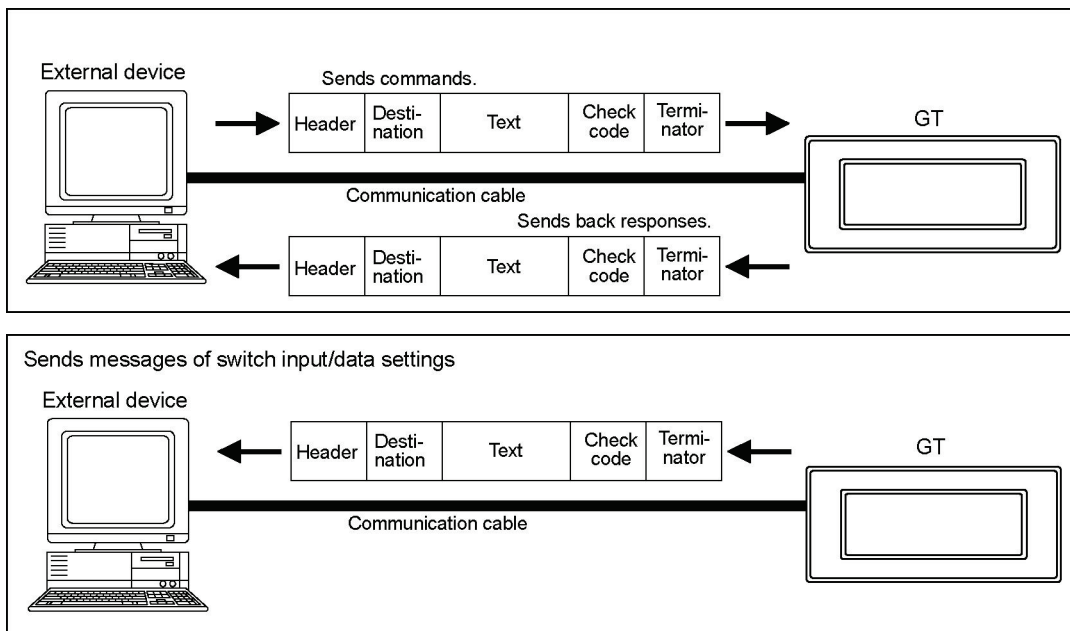

#### [Using two-way 2 mode on GT01]

- The external device should support full-duplex transmission to use the two-way 2 mode on the GT01.

## 5.1.2 Setting Communication Conditions

- The communication in the two-way 2 mode is only available for 1:1 connection, and specify the unit numbers within a range of 00 to 63.
- The settings for "Baud rate", "Data length" and "Parity check" should be the same as the communication settings specified on the external device.
- In the two-way 2 mode, it is recommended to perform the CS/RS signal control to prepare for the case that the response to a command from an external device and a message from the GT are sent at the same time.

Item	Settings	Caution
Unit number	00 to 63	Do not specify the same unit number for multiple GTs.
Baud rate	115200/57600/38400/19200/9600 bps	These settings should be the same as the settings specified on the external device.
Data length	7/8 bits	
Stop bits	Fixed: 1 bit	
Parity check	Odd/Even/Invalid	
CS/RS signal control	No CS/RS signal (GT01) Fixed: On (GT11, GT21) On/Off (Other models)	The CS/RS signals are not used in the command response mode.

Note) CS/RS signal (control) is not available for GT01.



### Reference:

For the details of the communication parameters of GT, refer to <2.1 Setting on GTWIN>.

### 5.1.3 Change in CTS Signal When Responded from GT (Except GT01)

---

In the two-way 2 mode, the external device and the GT both have the transmission right, so if a command is sent from the external device when a message is being sent from the GT, the normal communication may be interfered. The GT monitors the L/H level <sup>Note)</sup> of the CS (CTS), and in the above case it temporarily interrupts the message transmission so that the normal communication will be maintained. The communication program for the two-way 2 mode should be created at the external device side considering the points below.

1) When the CS (CTS) changes from L to H during a message being sent, the GT will stop sending the message at the time that the CS (CTS) changes to H, and then restart sending the rest of the message after it changes to L.

If a command to request a response is sent from the external device during a message is being sent when the CS (CTS) is H, the GT will resend the rest of the message at the time that the CTS changes to L, and then send a response to the received command.

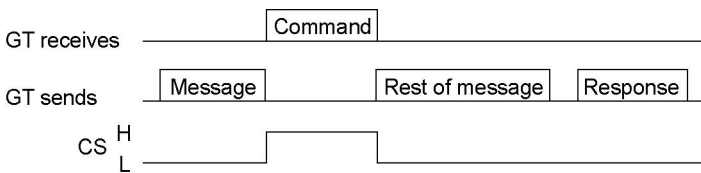

2) If a command is sent from the external device during a message is being sent when the CS (CTS) is L, the GT will continue the message transmission being receiving the command.

3) If commands are sent successively during a message being sent under the condition that a response cannot be sent back and the CS (CTS) is L, the GT will send back a response. However, in that case, it is not assured to which command the response was sent back.

4) When sending commands successively, the next command should be sent after intervals of more than 50 ms.

5) If a screen where to jump is complicated, it may need a long time for GT to change the screen. If commands are sent successively when changing a screen, confirm the time interval of the consecutive commands using the screen data used. The time interval may need to be more than 50 ms depending on the complexity of a screen.

Note) The L/H level shows the signal at the microcomputer port level. It means that L=0 and H=1.

For the voltage of the RS232C port, the plus voltage is output at the level L and the minus voltage at the level H.

## 5.1.4 Basic Formats

### Command

This is a message to be sent to the GT from the external device. Create this command according to the format on the computer.

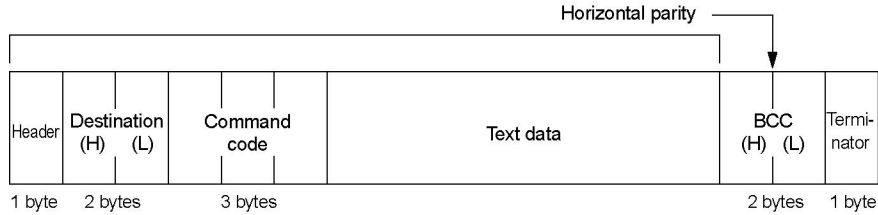

### Response

This is a message to be sent back to the external device from the GT. Analyze this message according to the format, and check the operation results, or retrieve the data.

(1) In normal condition:

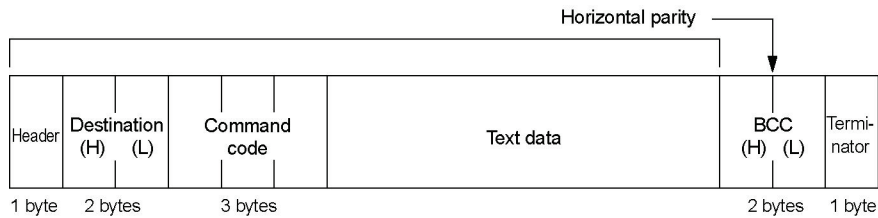

(2) When an error occurred:

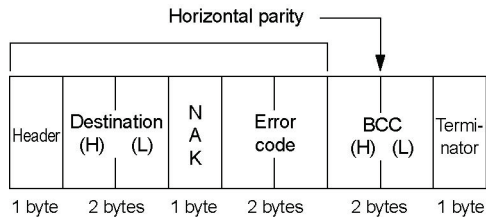

### Message

This is a message to be sent to the external device when the switch operation was performed on the GT. Analyze this message according to the format, and check the operation results, or retrieve the data.

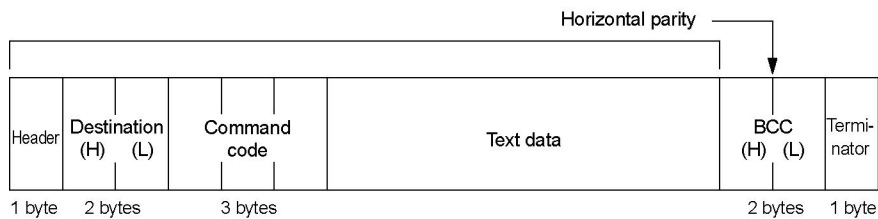

## 5.1.5 Control Codes

The control codes (header and terminator) are as follows.

Name	Character	ASCII code	Function
Header	?	3F	Beginning of a message.
Terminator	CR	0D	Completion of a message.
NAK	NAK	15	Response when an error occurs.

## 5.1.6 Command Codes

The command codes are as follows.

### Command codes used for commands transmitted from external device to GT

Type	Character	ASCII code			Function
Read	WDR	57	44	52	Read data area in word unit
	SRR	53	52	52	Read single relay bit
	PRR	50	52	52	Read multiple relay bits
	WRR	57	52	52	Read relay in word unit
Write	WDW	57	44	57	Write data area in word unit
	BDW	42	44	57	Write data area in byte unit
	DDW	44	44	57	Write data area in digit unit
	SDW	53	44	57	Write data area in bit unit
	WRW	57	52	57	Write relay in word unit
	BRW	42	52	57	Write relay in byte unit
	DRW	44	52	57	Write relay in digit unit
SRW	53	52	57	Write relay in bit unit	

### Command codes included in messages transmitted from GT to external device

Type	Character	ASCII code			Function
Sent message	WDR	57	44	52	Send information on data area in word unit
	SRR	53	52	52	Send information on single relay bit
	WRR	57	52	52	Send information on relay in word unit



#### Note:

Even when the GT internal device is not directly operated like this, the information on the internal device changed by the GT internal operation may be sent to the external device as a message.



## 5.1.7 BCC (Block Check Code)

BCC is the horizontal parity that is from the beginning of the command and response to the end of the text data, and that is two characters of ASCII code which the exclusive OR of the data in the subject range was converted to.

When the BCC check is not performed in the communication conditions for the GT, use "\*\*\*" instead of BCC.

### Calculation example of BCC

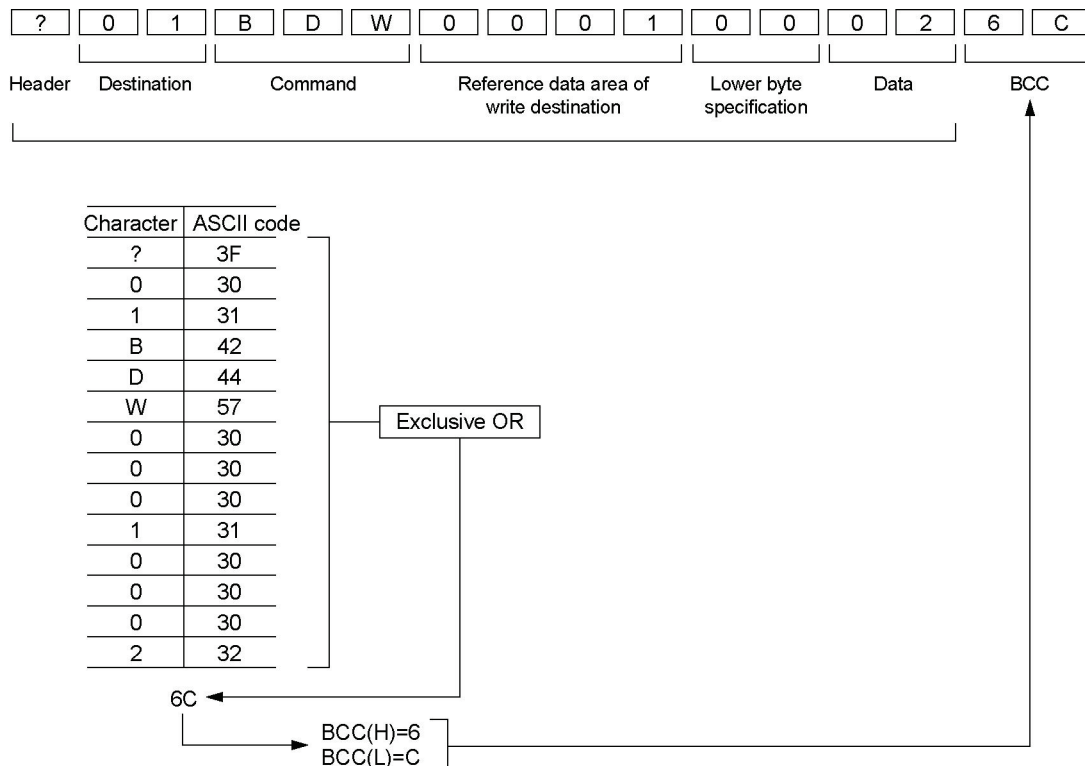

### Calculation example of BCC in Basic program

```

10 INPUT "==" , A$
20 ANS=0
30 FOR I=1 TO LEN(A$)
40 ANS=ANS XOR ASC(MID$(A$, I, 1))
50 NEXT I
55 PRINT HEX$(ANS)
60 GOTO 10
Ok
run
==> ?01BDW00010002
6C
==>

```

## 5.1.8 Error Codes

The error codes are as follows.

### For GT01, GT11 and GT21

Error code	Error name	Measures
ER00	BCC error	The value of BCC may be incorrect. Check if there is no calculation mistake.
ER01	Format error	A command format may be incorrect. Check if it is correct.
ER02	NOT supported error	A command used is not supported with the version of the GT. Upgrade the version of the GT, or use another command.
ER03	Address error	The address specified does not exist in the GT. Check the address of the transmitted command.
ER04	Receive buffer overflow	The sent command exceeds the receivable number of bytes. Check the number of bytes of the sent command.
ER05	Requested overflow	The sent readout command exceeds the number of bytes that can send back. Check the number of the read words.
ER06	Data error	The communication condition for the GT may be unmatched with the condition for a destination device. Check the communication conditions.
ER07	Data write inhibit error	A command for the address that writingn is not available was sent. Check the address of the sent command.

### For GT02, GT02L, GT03-E, GT05, GT12, GT32 and GT32-E

Error code	Error name	Measures
**0000	BCC error	The value of BCC may be incorrect. Check if there is no calculation mistake.
**0001	Format error	A command format may be incorrect. Check if it is correct.
**0002	NOT supported error	A command used is not supported with the version of the GT. Upgrade the version of the GT, or use another command.
**0003	Address error	The address specified does not exist in the GT. Check the address of the transmitted command.
**0004	Receive buffer overflow	The sent command exceeds the receivable number of bytes. Check the number of bytes of the sent command.
**0005	Requested overflow	The sent readout command exceeds the number of bytes that can send back. Check the number of the read words.
**0006	Data error	The communication condition for the GT may be unmatched with the condition for a destination device. Check the communication conditions.
**0007	Data write inhibit error	A command for the address that writingn is not available was sent. Check the address of the sent command.

Note) These are the error codes related to communicaiton.

## 5.1.9 Restrictions

### Allowable bytes sent and received

The allowable number of bytes to be sent and received in the GT is up to 512 bytes (including CR). Therefore, a command or response of which size is more than 513 bytes cannot be sent from the external device.

### Restrictions on transmitting messages

In the two-way 2 mode, a message will not be sent if the following changes occur in the basic communication area. However, a message is sent if these areas are changed directly using parts such as switch parts. When readout is necessary, use the readout command.

Number of displayed screen
BAT bit
Data input in progress flag
BAT LOW flag

## 5.2 Command Code Reference

### 5.2.1 Transmitting Commands From External Device

#### [WDR] Read data area in word unit

The word device area in the GT is read in word unit.

##### Command

?	Destination (H) (L)	W	D	R	Starting address of reference data area (4 digits)	Number of words (4 digits)	BCC (H) (L)	CR
---	------------------------	---	---	---	--	-------------------------------	----------------	----

##### Response

?	Destination (H) (L)	W	D	R	Data 1 (4 digits)	....	Data n (4 digits)	BCC (H) (L)	CR
					(Higher)	(Lower)			

#### [SRR] Read single relay bit

The bit device area in the GT is read specifying one bit.

##### Command

?	Destination (H) (L)	S	R	R	Contact number	BCC (H) (L)	CR	
					BCD (3 digits)	HEX (1 digit)		

##### Response

?	Destination (H) (L)	S	R	R	Contact data (2 digits)	BCC (H) (L)	CR
					When OFF: 00 When ON : 01		

**[PRR] Read multiple relay bits**

The bit device area in the GT is read in bit unit.

**Command**

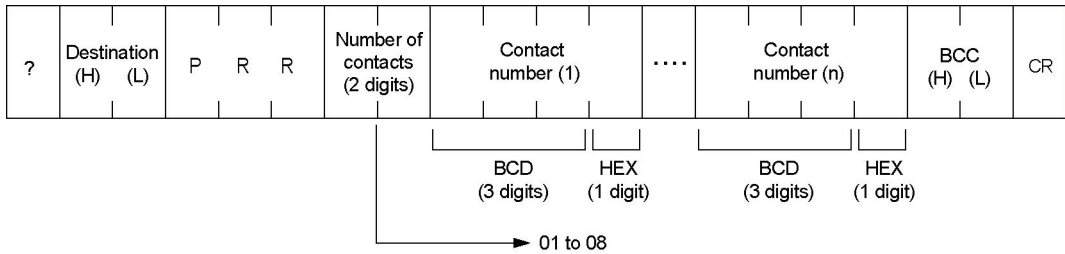

**Response**

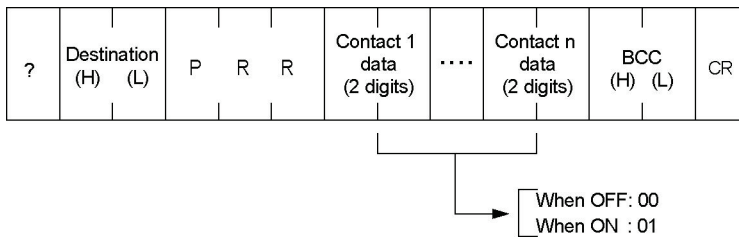

**[WRR] Read relay in word unit**

The bit device area in the GT is read in word unit.

**Command**

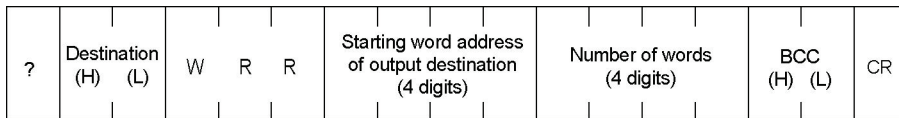

**Response**

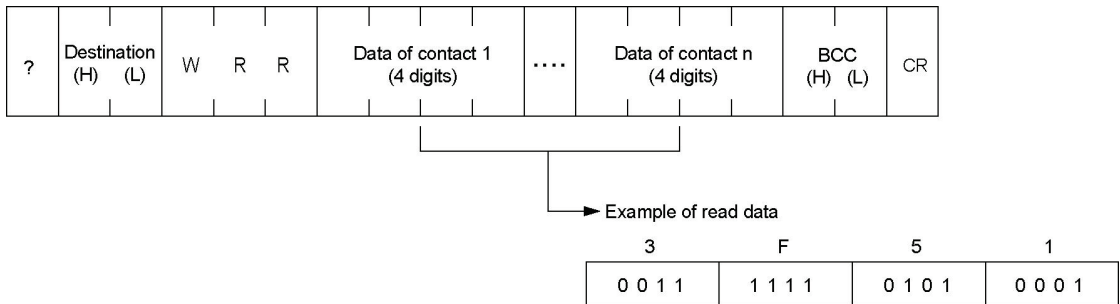

**[WDW] Write data area in word unit**

The word device area in the GT is written in word unit.

**Command**

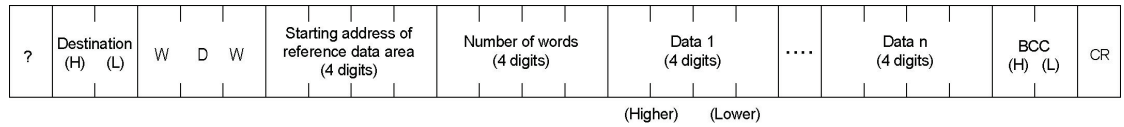

**Response**

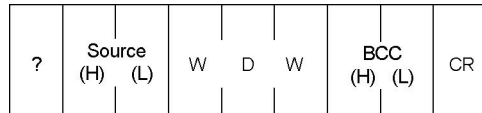

**[BDW] Write data area in byte unit**

The word device area in the GT is written in byte unit.

**Command**

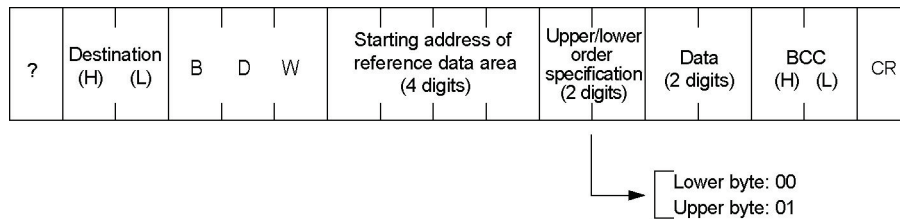

**Response**

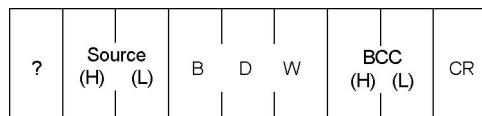

**[DDW] Write data area in digit unit**

The word device area in the GT is written in digit unit.

**Command**

?	Destination (H) (L)	D	D	W	Starting address of reference data area (4 digits)	Digit speci- fica- tion	Data	BCC (H) (L)	CR
---	------------------------	---	---	---	--	----------------------------------	------	----------------	----

(1 digit)(1 digit)

Specify 0 to 3.

F E D C	B A 9 8	7 6 5 4	3 2 1 0
3	2	1	0

**Response**

?	Source (H) (L)	D	D	W	BCC (H) (L)	CR
---	-------------------	---	---	---	----------------	----

**[SDW] Write data area in bit unit**

The word device area in the GT is written in bit unit.

**Command**

?	Destination (H) (L)	S	D	W	Starting address of reference data area (4 digits)	Bit speci- fication	ON/ OFF speci- fication	BCC (H) (L)	CR
---	------------------------	---	---	---	--	---------------------------	----------------------------------	----------------	----

(1 digit)(1 digit)

0: OFF  
1: ON  
Specify 0 to F.

**Response**

?	Source (H) (L)	S	D	W	BCC (H) (L)	CR
---	-------------------	---	---	---	----------------	----

### [WRW] Write relay in word unit

The bit device area in the GT is written in word unit.

#### Command

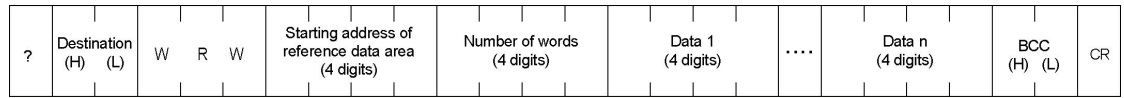

↑  
Highest-order digit is always "0".  
(WGR0000 to WGR0255)

#### Response

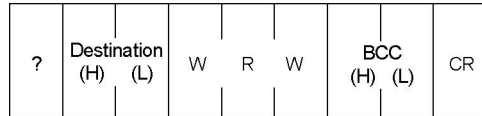

### [BRW] Write relay in byte unit

The bit device area in the GT is written in byte unit.

#### Command

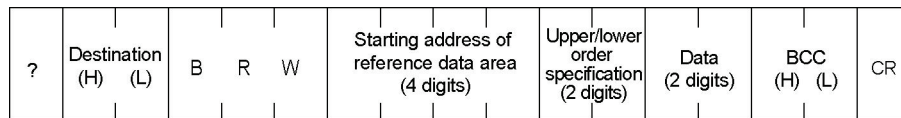

↑  
Highest-order digit is always "0".  
(WGR0000 to WGR0255)

→ Lower byte: 00  
Upper byte: 01

#### Response

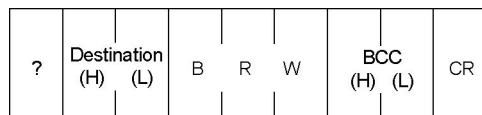

**[DRW] Write relay in digit unit**

The bit device area in the GT is written in digit unit.

**Command**

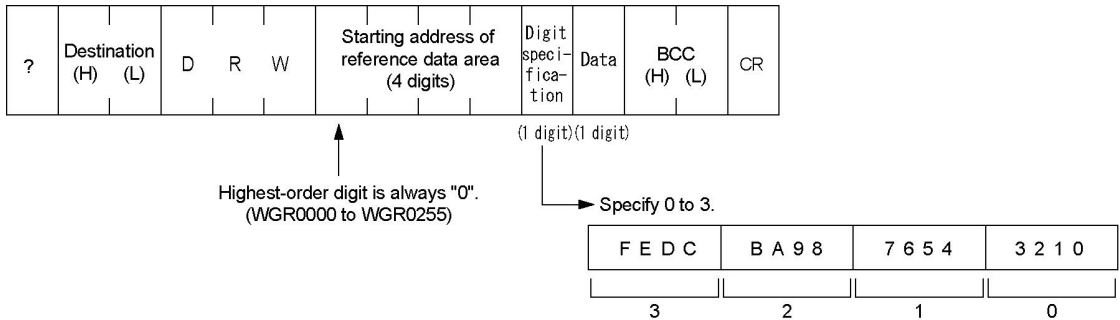

**Response**

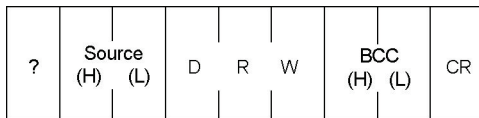

**[SRW] Write relay in bit unit**

The bit device area in the GT is written in bit unit.

**Command**

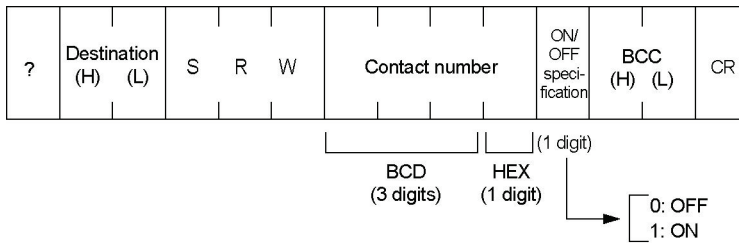

**Response**

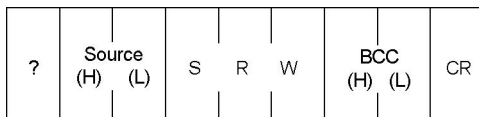



## 5.2.2 Transmitting Messages From GT

### [WDR] Send information on data area in word unit

Data in word unit is sent to a host computer from the GT.

#### Message

?	Destination (H) (L)	W	D	R	Starting address of reference data area (4 digits)	Number of words (4 digits)	Data 1 (4 digits)	....	Data n (4 digits)	BCC (H) (L)	CR
---	------------------------	---	---	---	--	-------------------------------	----------------------	------	----------------------	----------------	----

### [SRR] Send information on single relay bit

The information on On/Off of relay is sent to a host computer from the GT.

#### Message

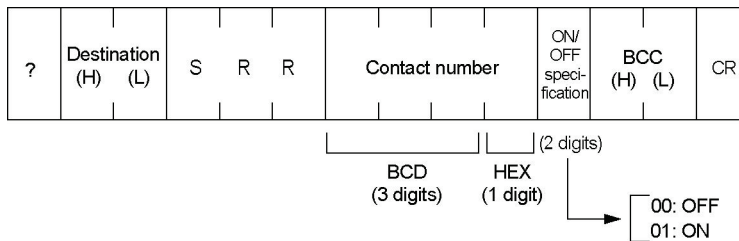

### [WRR] Send information on relay in word unit

Data in the relay area in word unit is sent to a host computer from the GT.

#### Message

?	Destination (H) (L)	W	R	R	Starting address of reference relay (4 digits)	Number of words (4 digits)	Data 1 (4 digits)	....	Data n (4 digits)	BCC (H) (L)	CR
---	------------------------	---	---	---	--	-------------------------------	----------------------	------	----------------------	----------------	----

### How to distinguish between message data and response data from the GT

When using the two-way communication mode, in some cases it is hard to distinguish between the message sent from the GT and the response to the readout command sent from the external device (WDR, SRR, WRR).

In order to distinguish them, adjust the numbers of words and contacts of the readout command sent from the external device.

The GT sends 1-word message when the data format of the write destination that is specified in the switch part or data part is 1 word.

When the format is 2 words, the GT sends 2-word message. It depends on the digit numbers for ASCII of the data part.

Try to make the length of the message sent from the GT different from the length of the response to the readout command sent from the external device, to enable to distinguish them according to the length.



# Chapter 6

---

## Documentation

# 6.1 ASCII Code Table

b7	b6	b5	b4	b3	b2	b1	b0	R	C									
										b7								
										b6	0	0	0	0	1	1	1	1
										b5	0	0	1	1	0	0	1	1
										b4	0	1	0	1	0	1	0	1
											0	1	2	3	4	5	6	7
				0	0	0	0	0	0		NUL	DEL	SPACE	0	@	P	`	p
				0	0	0	1	1	1		SOH	DC1	!	1	A	Q	a	q
				0	0	1	0	2	2		STX	DC2	"	2	B	R	b	r
				0	0	1	1	3	3		ETX	DC3	#	3	C	S	c	s
				0	1	0	0	4	4		EOT	DC4	\$	4	D	T	d	t
				0	1	0	1	5	5		ENQ	NAK	%	5	E	U	e	u
				0	1	1	0	6	6		ACK	SYN	&	6	F	V	f	v
				0	1	1	1	7	7		BEL	ETB	'	7	G	W	g	w
				1	0	0	0	8	8		BS	CAN	(	8	H	X	h	x
				1	0	0	1	9	9		HT	EM	)	9	I	Y	i	y
				1	0	1	0	A	A		LF	SUB	*	:	J	Z	j	z
				1	0	1	1	B	B		VT	ESC	+	;	K	[	k	{
				1	1	0	0	C	C		FF	FS	,	<	L	¥	l	
				1	1	0	1	D	D		CR	GS	-	=	M	]	m	}
				1	1	1	0	E	E		SO	RS	.	>	N	^	n	~
				1	1	1	1	F	F		SI	US	/	?	O	_	o	DEL

## 6.2 Error Codes Table

An error code will be displayed in the upper right corner of the screen when an error occurs. The error code will be disappeared when the error is solved.

### For GT01, GT11 and GT21

Error code	Error name	Measures
ER00	BCC error	The value of BCC may be incorrect. Check if there is no calculation mistake.
ER01	Format error	A command format may be incorrect. Check if it is correct.
ER02	NOT supported error	A command used is not supported with the version of the GT. Upgrade the version of the GT, or use another command.
ER03	Address error	The address specified does not exist in the GT. Check the address of the transmitted command.
ER04	Receive buffer overflow	The sent command exceeds the receivable number of bytes. Check the number of bytes of the sent command.
ER05	Requested overflow	The sent readout command exceeds the number of bytes that can send back. Check the number of the read words.
ER06	Data error	The communication condition for the GT may be unmatched with the condition for a destination device. Check the communication conditions.
ER07	Data write inhibit error	A command for the address that writingn is not available was sent. Check the address of the sent command.

### For GT02, GT02L, GT03-E, GT05, GT12, GT32 and GT32-E

Error code	Error name	Measures
**0000	BCC error	The value of BCC may be incorrect. Check if there is no calculation mistake.
**0001	Format error	A command format may be incorrect. Check if it is correct.
**0002	NOT supported error	A command used is not supported with the version of the GT. Upgrade the version of the GT, or use another command.
**0003	Address error	The address specified does not exist in the GT. Check the address of the transmitted command.
**0004	Receive buffer overflow	The sent command exceeds the receivable number of bytes. Check the number of bytes of the sent command.
**0005	Requested overflow	The sent readout command exceeds the number of bytes that can send back. Check the number of the read words.
**0006	Data error	The communication condition for the GT may be unmatched with the condition for a destination device. Check the communication conditions.
**0007	Data write inhibit error	A command for the address that writingn is not available was sent. Check the address of the sent command.

Note) These are the error codes related to communicaiton.



**Reference:** Other error codes

<GT series User's Manual No. ARCT1F511E>

## 6.3 Sheet for Basic Communication Area Allocation

Word device area [Part bit area]

Size ( ) words

Address	Application															
	F	E	D	C	B	A	9	8	7	6	5	4	3	2	1	0
( )																
( )																
( )																
( )																
( )																
( )																
( )																
( )																
( )																
( )																

Word device area [Part area]

Size ( ) words

Address	Application															
	F	E	D	C	B	A	9	8	7	6	5	4	3	2	1	0
( )																
( )																
( )																
( )																
( )																
( )																
( )																
( )																
( )																
( )																

Bit device

Size ( ) words

Address	Application															
	F	E	D	C	B	A	9	8	7	6	5	4	3	2	1	0
( )																
( )																
( )																
( )																
( )																
( )																
( )																
( )																
( )																
( )																



## 6.4 Connection Diagrams

### 6.4.1 Precautions when connecting GT

-If noise is a problem, use a shielded cable and employ countermeasures such as installing a ferrite core if necessary. Also take measures so that the shielding doesn't peel off and noise such as static electricity does not interfere.

-The number of units, transmission distance and baud rate may differ depending on the device connected. Verify with the device being used.

-The maximum cable length for RS232C type is 15 m, also RS422 (5 V) type is 30 m.

-The maximum transmission distance is 500 m for the 24 V RS422 type.

-When connecting to the RS485, it may not be connected depending on the timing for switching between the transmission and reception at the external device. Please check it using the actual equipment. The terminal unit setting varies according to the external device to be connected. Confirm it before setting a terminal unit.

### 6.4.2 RS232C Connection

#### - GT01

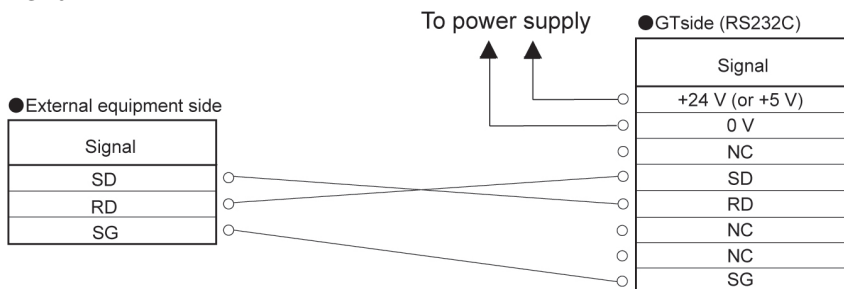

#### - When not performing CS/RS control (except GT01)

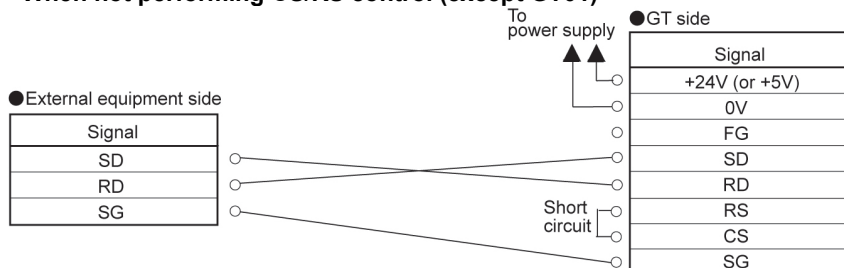

Note) The CS/RS at the GT side should be short-circuited.

However, short-circuiting is not required when setting "CS/RS Control" to "Off" in the "Communication Parameter" tab in the GTWIN "GT Configuration" dialog box.

#### - When performing CS/RS control (except GT01)

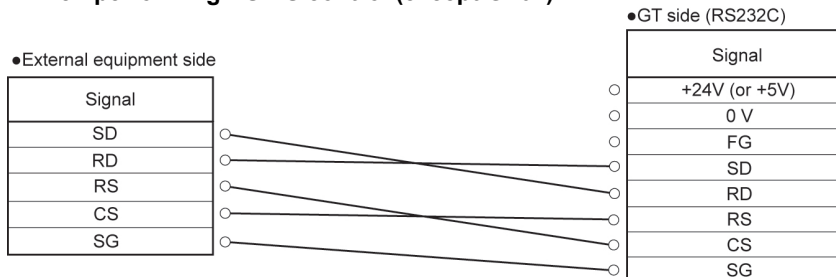

### 6.4.3 RS422 Connection

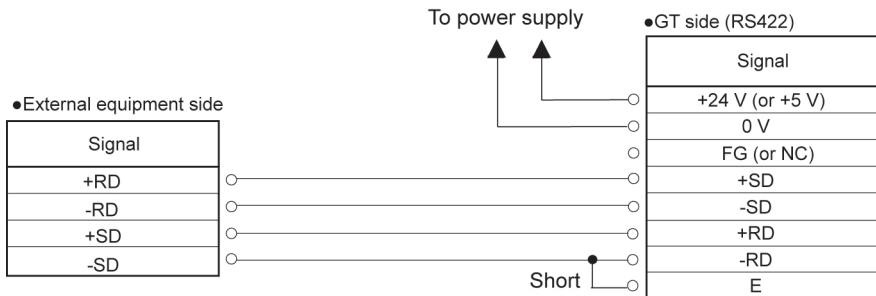

### 6.4.4 RS485 Connection (In Command Response Mode Only)

- 1:1 connection

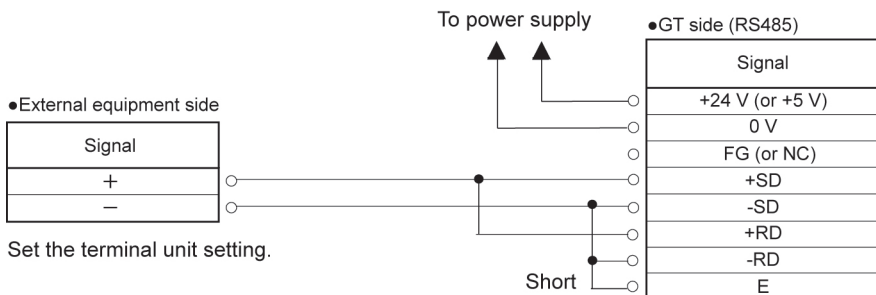

- When connecting more than one GT  
(Only when the communication mode is the command response mode)

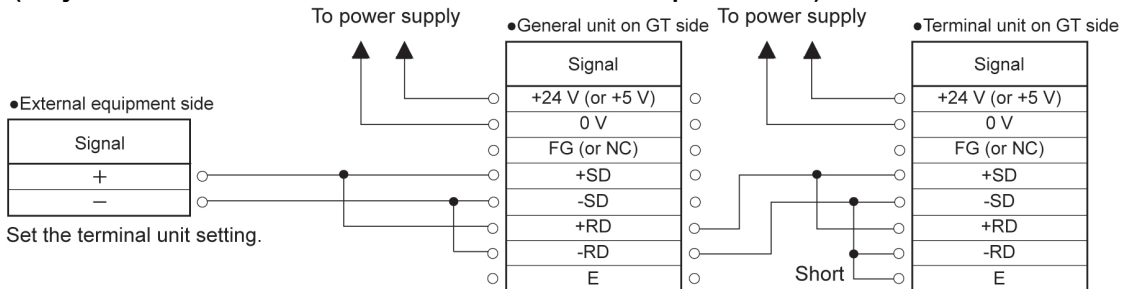

\* Wiring should extend from one unit to the next.  
Never run two wires from a single unit to two other units.

• Correct wiring



• Incorrect wiring

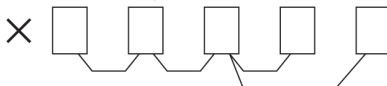

## Record of changes

Manual No.	Date	Description of changes
ARCT1F356E	JAN.2005	First Edition
ARCT1F356E-1	JAN.2006	2 <sup>nd</sup> Edition Additions: GT21
ARCT1F356E-2	NOV.2006	3 <sup>th</sup> Edition Additions: GT32 GT01R
ARCT1F356E-3	OCT.2007	4 <sup>th</sup> Edition Additions: GT05
ARCT1F356E-4	FEB.2009	5 <sup>th</sup> Edition Change of Company name
ARCT1F356E-5	JUL.2009	6 <sup>th</sup> Edition Additions: GT12
ARCT1F356E-6	Sep.2009	7 <sup>th</sup> Edition
ARCT1F356E-7	JUL.2010	8 <sup>th</sup> Edition Additions: GT02
ARCT1F356E-8	DEC.2010	9 <sup>th</sup> Edition Additions: GT02L Change of Company name
ARCT1F356E-9	AUG.2011	10 <sup>th</sup> Edition Additions: GT32-E
ARCT1F356E-10	DEC.2011	11 <sup>th</sup> Edition
ARCT1F356E-11	JUL.2013	12 <sup>th</sup> Edition Additions: GT03-E
ARCT1F356E-12	NOV.2013	13 <sup>th</sup> Edition
WUME-GTCOM-01	APR.2024	14 <sup>th</sup> Edition Change in Corporate name

---

## **Panasonic Industry Co., Ltd.**

1006, Oaza Kadoma, Kadoma-shi, Osaka 571-8506, Japan  
<https://industry.panasonic.com/>

Please visit our website for inquiries and about our sales network.

© **Panasonic Industry Co., Ltd. 2005-2024**

April, 2024

WUME-GTCOM-01