

Web Server Function Manual

Web Creator Ver.3.4.2 compliant

[Applicable model]

- Programmable Controller: FP7
- Control Unit: ELC500
- Eco-POWER METER: KW2M-X

Introduction

Thank you for purchasing a Panasonic product. Before you use the product, please carefully read through the user's manual, and understand it in detail to use the product properly.

Types of Manual

- There are different types of user's manual for the FP7 series. Please refer to a relevant manual for the unit and purpose of your use.
- The manuals can be downloaded on our website:
https://industrial.panasonic.com/ac/e/dl_center/manual/

Unit name or purpose of use	Manual name	Manual code
FP7 Power Supply Unit		
FP7 CPU Unit	FP7 CPU Unit User's Manual (Hardware)	WUME-FP7CPUH
	FP7 CPU Unit Command Reference Manual	WUME-FP7CPUPGR
	FP7 CPU Unit User's Manual (Logging Trace Function)	WUME-FP7CPULOG
	FP7 CPU Unit User's Manual (Security Function)	WUME-FP7CPUSEC
Instructions for Built-in LAN Port	FP7 CPU Unit User's Manual (LAN Port Communication)	WUME-FP7LAN
	FP7 CPU Unit User's Manual (Ethernet Expansion Function)	WUME-FP7CPUETEX
	FP7 CPU Unit User's Manual (EtherNet/IP Communication)	WUME-FP7CPUETIP
	Web Server Function Manual	WUME-FP7WEB
Instructions for Built-in COM Port	FP7 series User's Manual (SCU communication)	WUME-FP7COM
FP7 Extension Cassette (Communication) (RS-232C/RS485 type)		
FP7 Extension Cassette (Communication) (Ethernet type)	FP7 series User's Manual (Communication cassette Ethernet type)	WUME-FP7CCET
FP7 Extension (Function) Cassette Analog Cassette	FP7 Analog Cassette User's Manual	WUME-FP7FCA
FP7 Digital Input/Output Unit	FP7 Digital Input/Output Unit User's Manual	WUME-FP7DIO
FP7 Analog Input Unit	FP7 Analog Input Unit User's Manual	WUME-FP7AIH
FP7 Analog Output Unit	FP7 Analog Output Unit User's Manual	WUME-FP7AOH
FP7 Thermocouple Multi-analog Input Unit	FP7 Thermocouple multi-analog input unit FP7 RTD input unit User's Manual	WUME-FP7TCRTD
FP7 RTD Input Unit		
FP7 Multi Input / Output Unit	FP7 Multi Input / Output Unit User's Manual	WUME-FP7MXY
FP7 High-speed Counter Unit	FP7 High-speed counter Unit User's Manual	WUME-FP7HSC
FP7 Pulse Output Unit	FP7 Pulse Output Unit User's Manual	WUME-FP7PG

Types of Manual

Unit name or purpose of use	Manual name	Manual code
FP7 Positioning Unit	FP7 Positioning Unit User's Manual	WUME-FP7POSP
FP7 Serial Communication Unit	FP7 series User's Manual (SCU communication)	WUME-FP7COM
FP7 Multi-wire Link Unit	FP7 Multi-wire Link Unit User's Manual	WUME-FP7MW
FP7 Motion Control Unit	FP7 Motion Control Unit User's Manual	WUME-FP7MCEC
PHLS System	PHLS System User's Manual	WUME-PHLS
Programming Software FPWIN GR7	FPWIN GR7 Introduction Guidance	WUME-FPWINGR7

Product Configuration of Web Server Function and Precautions for Use

1. Web server function

The following contents can be monitored in a browser.

System Web: The FP7 system web is a content prepared for the FP7 CPU unit as standard.

Customer Web: Contents that customers create using the Web Creator can be uploaded.

For using the Web server function, use the following versions.

- FP7 CPU unit: Ver.4.10 or later (It can be used in Ver.3.40 to 3.99.)
 - Web Creator: Ver.2.0.0 or later
 - FPWIN GR7: Ver.2.60 or later
 - FPWIN Pro7: Ver.7.11 or latter
 - ELC500: All versions
 - KW2M-X: All versions
- * For using the Web Creator Ver.2.0.0 or later, use the FP7 CPU unit Ver.4.10 or later.

2. Control Web Creator (AFPSWC)

This is software for creating, saving, uploading, and downloading contents of the customer Web.

Precautions for use

- For using the Web Creator, it is necessary to insert the key unit (AFPSWCKEY) to a PC.
- If the key unit is not inserted, the Web Creator cannot be started and used.
- The Web creator cannot be started from the remote drive.
- The Web Creator can be activated with Windows7/8/10 (32-bit/64-bit) only.
- For uploading data to the Web server or testing, connect it to the FP7 / ELC500 unit using Ethernet.
- Use a cross cable for connecting them directly, and use a straight/cross cable for connecting them via a hub.
- Avoid conflict with the communication of GR7.
- When uploading/downloading to the Web server, the default is the port 32769 of the system connection.

Web browsers accessible to the Web server

OS	Supported browser
Windows	<ul style="list-style-type: none">· Google Chrome· Mozilla Firefox· Opera· Internet Explorer 11
OS X	<ul style="list-style-type: none">· Safari· Google Chrome· Mozilla Firefox
iOS	<ul style="list-style-type: none">· Safari· Google Chrome
Android	<ul style="list-style-type: none">· Google Chrome

*1: Windows, Windows7, 8, 10, Internet Explorer 11 are registered trademarks or trademarks of Microsoft Corporation in the United States and/or other countries.

Google Chrome and Android are registered trademarks of Google Inc..

Safari and OS X are trademarks or registered trademarks of Apple Inc. in the United States.

iOS is a trademark or registered trademark of Cisco in the United States and/or other countries.

Firefox is a registered trademark of Mozilla Foundation in the United States and/or other countries.

Opera is a trademark or registered trademark of Opera Software ASA.

Precautions for Using Network Function

■ Precautions concerning network

There is the risk of suffering following damage as this unit can be used connecting to the network with the Web server function or FTP server function

- (1) Information leakage through this unit
- (2) Illegal operations of this unit by a malicious third party
- (3) Obstructing or stopping this unit by a malicious third party

Sufficient network security measures should be taken using the system configuration as follows at your own risk to prevent such damages.

Recommended network topology

It should be the connection system using a local IP address on a dedicated line network (including a virtual network).

Use SSL communication between a browser and the FP7 / ELC500 Web server to enhance security more.

For making the SSL setting, upload the server certificate to the FP7.

For details of the setting method, refer to Server Certificate Setting Server Certificate Setting.

When using the SSL communication for accessing the FTP server or Web server of the FP7 / ELC500, use the products of the following versions.

FP7 CPU unit: Ver.4.10 or later (It can be used in Ver.3.40 to 3.99.)

Web Creator: Ver.2.0.0 or later

ELC500: All versions

1. For using VPN (Virtual Private Network)

Install the FP7 / ELC500 under the environment in which a virtual dedicated line network is built via WAN.

It is recommended to use the FP7 / ELC500 through a FW (firewall).

Furthermore, it is recommended to use the SSL communication.

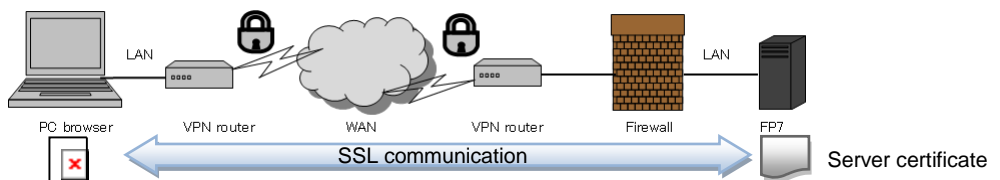

2. For using dedicated line network (Private Network)

Install the FP7 under the environment in which a dedicated line network is built.

It is recommended to use the FP7 / ELC500 through a FW (firewall).

Furthermore, it is recommended to use the SSL communication.

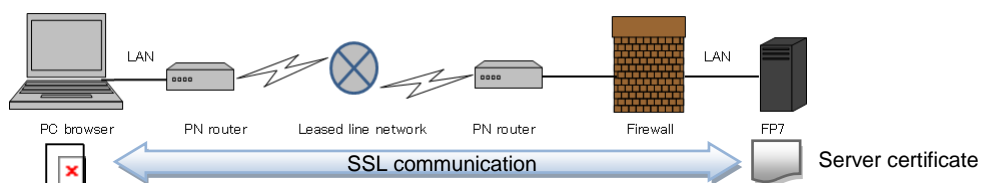

Table of Contents

1. Web Server Function	1-1
1.1 Overview of Web Server Function.....	1-2
1.1.1 Types of Web Server	1-2
1.1.2 Performance of Web Server.....	1-2
1.2 Method of Connecting to Web Server	1-3
1.2.1 Specification Method on Browser.....	1-3
1.2.1.1 Method by specifying IP address	1-3
1.2.1.2 Method by Specifying Name (Server Name)	1-3
1.2.2 Inheritance of Host Address of Customer Web Contents	1-4
1.2.3 Connecting via Local Network.....	1-6
1.2.3.1 Connecting to One FP7 / ELC500 Unit.....	1-6
1.2.3.2 Connecting to Multiple FP7 / ELC500 Units.....	1-7
1.2.4 Connecting via Global Network.....	1-8
1.2.4.1 Connecting to One FP7 / ELC500 Unit (1).....	1-8
1.2.4.2 Connecting to One FP7 / ELC500 Unit (2).....	1-10
1.2.4.3 Connecting to Multiple FP7 / ELC500 Units.....	1-12
1.2.5 Connection Using SSL	1-14
1.2.5.1 Restrictions on SSL Communication	1-14
1.2.5.2 Connecting via Local Network	1-14
1.2.5.3 Connecting via Global Network.....	1-16
1.3 Customer Web	1-18
1.3.1 Outline of Method of Using Customer Web	1-18
2. Installing Web Creator	2-1
2.1 Method of Installing Web Creator	2-2
2.2 Folder Structure of Web Creator	2-5

2.3	Changes in Web Creator Ver.3.0.0 or later	2-7
2.3.1	Changes in Web Creator Ver.3.1.0	2-7
2.3.2	Changes in Web Creator Ver.3.2.0	2-9
2.4	Projects Created with Versions Earlier Than Ver.3.0.0	2-10
3.	Web Creator Function	3-1
3.1	Overview of Web Creator	3-2
3.2	How to Start Web Creator	3-5
3.3	Project Folder	3-6
3.3.1	Differences by Web Server Models	3-6
3.3.2	Creating Project Folder at Startup	3-7
3.3.3	Specifying Existing Project Folder at Startup	3-10
3.3.4	Acquiring Project from Web Server at Startup and Editing It	3-13
3.3.5	Creating Project Folder from Operation Menu	3-16
3.3.6	Specifying Project Folder from Operation Menu	3-19
3.4	Project Management	3-21
3.4.1	Configuration of Project Data	3-21
3.4.2	Project Setting	3-22
3.4.2.1	Link with Ladder Projects	3-24
3.4.2.2	Display Setting of language Switching Menu	3-27
3.4.3	Creating Groups	3-28
3.4.4	Creating Screens	3-30
3.4.5	Importing Other Project Screens	3-32
3.4.6	Upload	3-34
3.4.7	Download	3-36
3.4.8	Importing Projects	3-38
3.4.9	Exporting Projects	3-42
3.4.10	Multilingual Message Setting	3-44
3.5	Screen Editing	3-47
3.5.1	Open	3-47
3.5.2	Screen Creation	3-49

3.5.2.1	Enlarging or reducing a screen	3-51
3.5.2.2	Copying parts or undoing	3-53
3.5.3	Presetting for Test	3-54
3.5.4	Screen Test	3-55
3.5.5	File Storage	3-56
3.5.6	Screen Setting	3-57
3.5.7	Functions of Web Parts	3-58
3.5.7.1	Common Functions to Web Parts	3-58
3.5.7.1.1	Multilingualization of Parts Display	3-58
3.5.7.1.2	Method of Specifying Character Size Larger Than 100 px	3-59
3.5.7.1.3	New Operations When Operating Parts.....	3-60
3.5.7.2	Functions of Major Web Parts.....	3-64
3.5.7.2.1	Slider Parts	3-64
3.5.7.2.2	Rotary Switch Parts	3-65
3.5.7.2.3	Dialog Parts	3-67
3.5.7.2.4	Meter Parts	3-69
3.5.7.2.5	Extended Graph Parts (Improvement in Ver.3.1.0)	3-72
3.5.7.2.6	Data Parts (Improvement in Ver.3.1.0).....	3-85
3.5.7.2.7	Media Player Parts.....	3-92
3.5.7.2.8	Level Graph Parts	3-94
3.5.7.2.9	Integration Graph Parts.....	3-98
3.5.7.2.10	SD Card Logging Graph Parts	3-104
3.5.7.2.11	Operation History	3-108
3.5.7.2.12	Camera Parts.....	3-150
3.5.7.2.13	General-use Camera Parts	3-153
3.5.7.2.14	Text Parts	3-154
3.5.7.2.15	Table Parts	3-155
3.5.7.2.16	Shapes Parts	3-159
3.5.8	Functions of Web Creator	3-162
3.5.8.1	Server Certificate Setting	3-162
3.5.8.1.1	Setting Server Certificate in PLC	3-162
3.5.8.1.2	Deleting Server Certificate Information from PLC	3-166
3.5.8.1.3	Registering Root Certificate in PC	3-169
3.5.8.2	Security Setting	3-172

3.5.8.3	Banner Setting	3-176
3.5.8.4	PDF Screen Setting	3-179
3.5.8.5	Page Switch Setting	3-183
3.5.8.6	Screen Number Notification Setting	3-185
3.5.8.7	Fine Adjustment Function of Part Arrangement	3-187
3.5.8.8	Function for Confirming Content Size	3-187
3.5.8.9	Multi-language Switching Function of Web Creator	3-188
3.5.8.10	Monitor Function	3-189
3.5.8.11	Automatic Enlargement of Attached Images	3-190
3.6	Execution Method	3-192
3.7	Method of Closing Web Creator	3-193
3.8	Types of Web Parts and Descriptions of Properties	3-194
4.	FP7 System Web Function	4-1
4.1	Overview of FP7 System Web	4-2
4.2	Login Screen	4-3
4.3	CPU status indication > Model information Screen	4-5
4.4	CPU status indication > Operation state Screen	4-6
4.5	CPU status indication > Project header Screen	4-14
4.6	CPU status indication > System monitor area Screen	4-15
4.7	CPU status indication / System history Screen	4-25
4.8	CPU status indication / EtherNet/IP monitor	4-28
4.9	Error indication > Unit error Screen	4-31
4.10	Error indication > Error alarm relay Screen	4-33
4.11	Data monitor Screen	4-34

1

Web Server Function

1.1 Overview of Web Server Function

1.1.1 Types of Web Server

The following two types of Web server functions are available.

■ Customer Web

Screen (contents) designed by the Web Creator can be uploaded and monitored.

■ FP7 System Web

This is a content stored in the FP7 CPU unit as a standard. It cannot be edited.

For using the web server function, it is necessary to make the following settings in Built-in ET-LAN of FP7 Configuration.

- Setting the Add-on to "Use".
- Setting the Web Server function to "Use System Only", "Use Customer Only", or "Use System and Customer".
- Setting the time zone for the SNTP setting, e.g.: For Japan, +0900

1.1.2 Performance of Web Server

About the performance of the web server

■ Number of concurrent accesses

Up to 16 sessions can be accessed simultaneously.

■ Size of storable contents

- The size of storable contents by FP7 / ELC500 or Eco-POWER METER is up to 13.83 MB.
 - * 13.83 MB = 14,503,936 bytes
- For using 13.83 MB as the contents capacity for FP7, update the versions of various software to the following versions or later.

FP7 CPU unit: Ver.4.10 or later (It can be used in Ver.3.40 to 3.99.)

Web Creator: Ver.2.0.0 or later

* If either one of them is an older version, the capacity of storable contents is only used up to **6.86 MB**.

* For using the Web Creator Ver.2.0.0 or later, use the FP7 CPU unit Ver.4.10 or later.

For confirming the current content size, refer to 3.5.8.7 Fine Adjustment Function of Part Arrangement.

1.2 Method of Connecting to Web Server

1.2.1 Specification Method on Browser

The web server uses port number 80. This port number cannot be changed.

The following two methods are available for connecting to the web server.

1.2.1.1 Method by specifying IP address

Specify the following addresses on the browser.

<For customer web>

- When Index.html (initial screen) exists in the customer web.

IP address

Example) 192.168.1.210

http://192.168.1.210/cu/index.html is displayed.

- When specifying the customer web URL

IP address/cu/sample.html

Example) 192.168.1.210/cu/sample.html

http://192.168.1.210/cu/sample.html is displayed.

<For FP7 system web>

IP address/sys/

Example) 192.168.1.210/sys/

http://192.168.1.210/sys/index.html is displayed.

1.2.1.2 Method by Specifying Name (Server Name)

1) Method of registering in Windows

Edit the file "hosts" under the folder "C:\Windows\System32\drivers\etc", and add an IP address and server name.

Example) Web server: 192.168.1.210

Server name: www.fp7webserver.com

Add the next line at the bottom line of the file "hosts" and save.

192.168.1.210 www.fp7webserver.com # FP7 Server

* Only the administrator can edit "hosts".

2) For using DNS

Example) http://www.fp7webserver.com/cu/index.html

1.2.2 Inheritance of Host Address of Customer Web Contents

- An IP address is specified on a browser for connecting to the customer web.
- This IP address is inherited for each screen group, screen, and web part.
- Separate host addresses can be set for each screen group, screen, and web part. The default is the common setting. Normally, you can use the default setting as is.
- For connecting to another web server by individual screen or web part, specify an IP address other than the common setting.
- The setting priority of the host address is as follows.
(Low) Project setting < Screen group setting < Screen setting < Web parts (High)
For the common setting, a next higher priority setting is applied.

[Concrete example of host address inheritance]

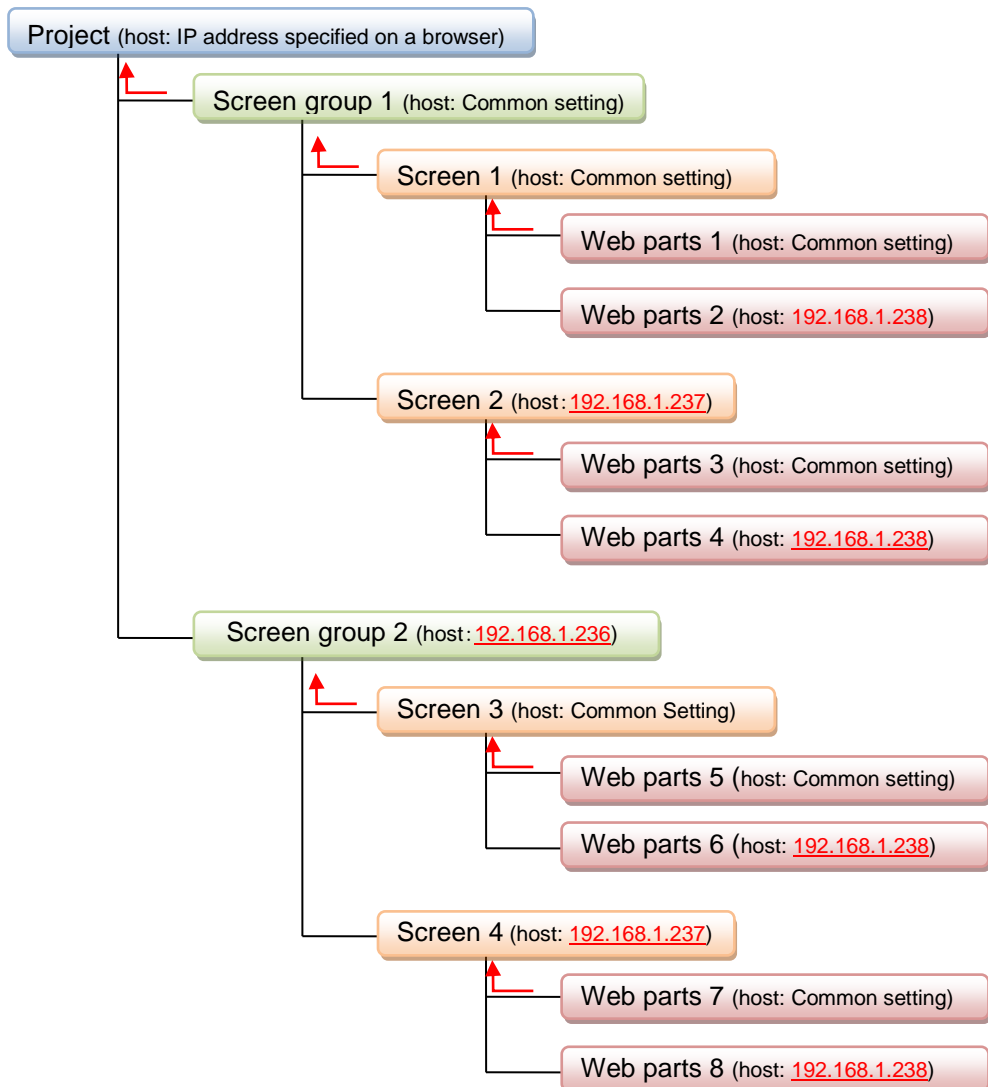

The data acquisition destinations of the above-mentioned web parts are as follows.

Group	Screen	Web part	Data acquisition destination
Screen group 1 (Common setting)	Screen 1 (Common setting)	Web part 1 (Common setting)	IP address specified on a browser
		Web part 2 (Host is specified)	Specified address of Web part 2 (192.168.1.238)
	Screen 2 (Host is specified)	Web part 3 (Common setting)	Specified address of screen 2 (192.168.1.237)
		Web part 4 (Host is specified)	Specified address of Web part 4 (192.168.1.238)
Screen group 2 (Host is specified)	Screen 3 (Common setting)	Web part 5 (Common setting)	Specified address of group 2 (192.168.1.236)
		Web part 6 (Host is specified)	Specified address of Web part 6 (192.168.1.238)
	Screen 4 (Host is specified)	Web part 7 (Common setting)	Specified address of screen 4 (192.168.1.237)
		Web part 8 (Host is specified)	Specified address of Web part 8 (192.168.1.238)

1.2.3 Connecting via Local Network

1.2.3.1 Connecting to One FP7 / ELC500 Unit

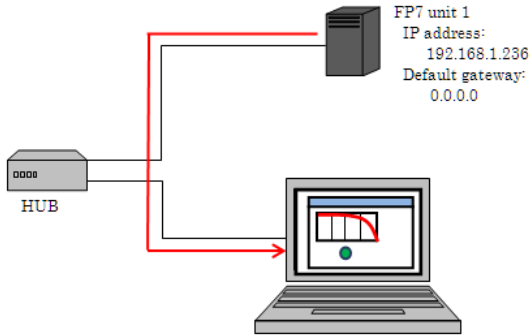

Example) When connecting to the FP7 unit 1 from browser via local network
[Preparation 1] An IP address is allocated to the FP7 CPU unit.

Set the default gateway to "0.0.0.0".

[How to specify an address]

1. Specification method on a browser

Specify the IP address of the FP7 CPU unit.

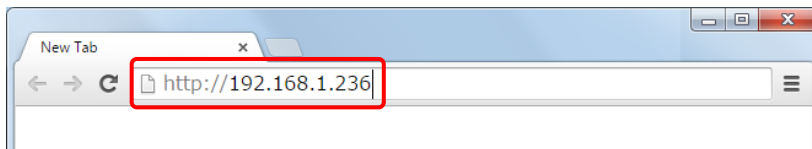

The FP7 web server uses port number 80.

It can be omitted when connecting with the port number 80.

2. Host address setting for screen group, screen, and web parts

When acquiring contents from the unit 1 and monitoring data of the unit 1 only, there is no need to change the default common setting of the host address referred by each screen group, screen, and web part.

common parameters	
device	
host address	Global settings
network protocol	Global settings
switch read device	type: Global device type: DT,n No.: 0
switch write device	type: Global device type: DT,n No.: 0

Setting example of a web part

1.2.3.2 Connecting to Multiple FP7 / ELC500 Units

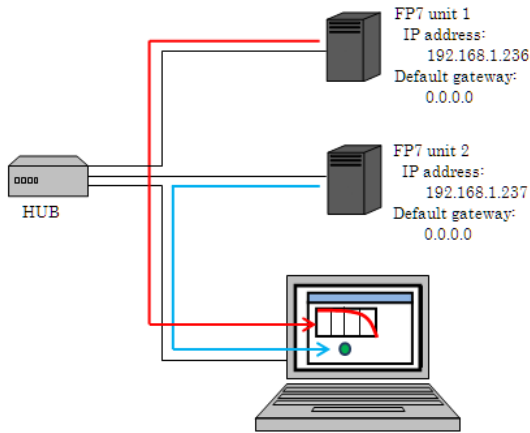

Example) When connecting to the FP7 unit 1 from browser, downloading contents, and monitoring the FP7 unit 2 from that web part (This type of connection method is called a cross-domain connection.)

[Preparation 1] Allocate IP addresses to the FP7 CPU units.

Set the default gateways to "0.0.0.0".

[How to specify addresses]

1. Specification method on a browser

Specify the IP addresses of the FP7 CPU units.

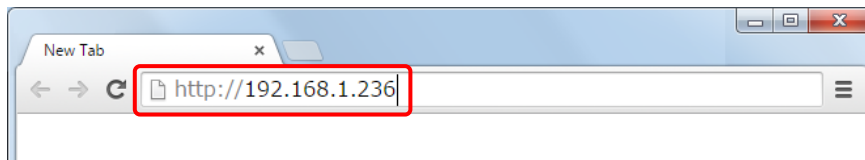

2. Host address setting for screen group, screen, and web parts

Set the IP address of the unit 2 to the host address of a web part connected to the FP7 CPU (unit 2).

common parameters	
device	
host address	192.168.1.237 IP address of the unit 2
network protocol	Global settings
lamp status	type: Global
	device type: DT,n
	No.: 0
lamp status mode	a

Setting example of a web part

1.2.4 Connecting via Global Network

1.2.4.1 Connecting to One FP7 / ELC500 Unit (1)

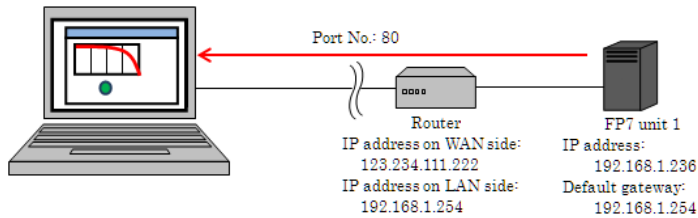

Example) When connecting to the FP7 unit 1 from browser via global network

[Preparation 1] Allocate an IP address to the FP7 CPU unit.

For the default gateway setting of the FP7, specify the IP address on a LAN side of a router which performs address conversion. Communication cannot be performed properly without this setting.

[Preparation 2] Set a broadband router.

- Use a router having the NATP function of destination address.
- Set an IP address on a LAN side.
- Set an IP address on a WAN side. (such as a global IP address or URL)
- The destination NAT table of the router is set as follows.

Setting on WAN side Setting on LAN side

Port No. 80 : IP address of FP7 CPU unit 1 + Port No. 80

Concrete setting example

NAT Table

Group	IP address of WAN	Protocol		IP address of LAN	Port number of LAN
Group1	WAN IP address	HTTP(TCPPort:80)	←→	192.168.1.236	HTTP(TCPPort:80)

Note)

Do not use the DMZ (demilitarized zone) setting for security reasons.

[How to specify an address]

1. Specification method on a browser (Specifying an IP address)

An IP address on a WAN side of a router or a fixed private IP address of VPN is specified in the format of "IP address on WAN side of router: Port No.".

Concrete example:

For connecting to the unit 1: IP address on the WAN side of the router

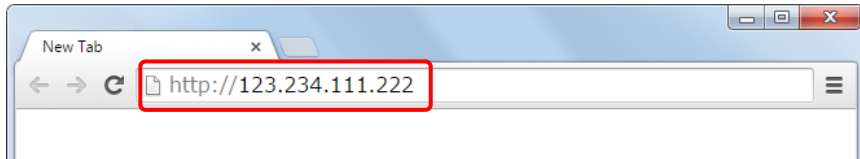

It can be omitted when connecting with the port number 80.

2. Specification method on a browser (2) (When using DNS)

It is specified in the format of "URL of the router: Port No.".



It can be omitted when connecting with the port number 80.

3. Host address setting for screen group, screen, and web parts

When acquiring contents from the unit 1 and monitoring data of the unit 1 only, there is no need to change the default common setting of the host address referred by each screen group, screen, and web part.

<input checked="" type="checkbox"/> common parameters		
<input checked="" type="checkbox"/> device		
host address	Global settings	
network protocol	Global settings	
switch read device	type	Global
	device type	DT,n
	No.	0
switch write device	type	Global
	device type	DT,n
	No.	0

Setting example of a web part

1.2.4.2 Connecting to One FP7 / ELC500 Unit (2)

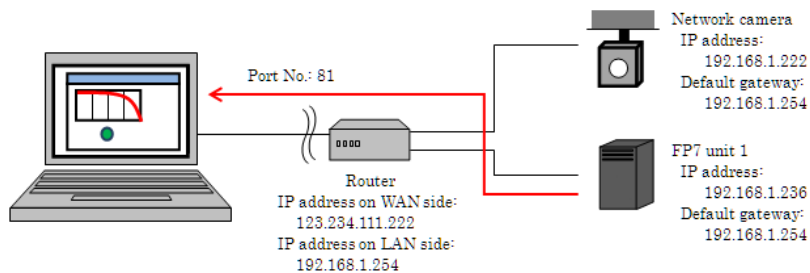

Example) When connecting to the FP7 unit using a port number other than 80

[Preparation 1] An IP address is allocated to the FP7 CPU unit.

For the default gateway setting of the FP7, specify the IP address on a LAN side of a router which performs address conversion. Communication cannot be performed properly without this setting.

[Preparation 2] Set a broadband router.

- Use a router having the NATP function of destination address.
- Set an IP address on a LAN side.
- Set an IP address on a WAN side. (such as a global IP address or URL)
- The destination NAT table of the router is set as follows.

Setting on WAN side Setting on LAN side

Port No. 80 : IP address of network camera + Port No. 80

Port No. 81 : IP address of FP7 CPU unit 1 + Port No. 80

Concrete setting example

NAT Table

Group	IP address of WAN	Protocol		IP address of LAN	Port number of LAN
Group1	WAN IP address	HTTP(TCPPort:80)	←→	192.168.1.222	TCPPort:80
	WAN IP address	TCPPort:81	→	192.168.1.236	TCPPort:80

[How to specify an address]

1. Method of specifying an address by browser (Specifying an address)

An IP address on a WAN side of a router or a fixed private IP address of VPN is specified in the format of "IP address on WAN side of router: Port No.".

Concrete example:

For connecting to the unit 1: IP address on the WAN side of the router: 81

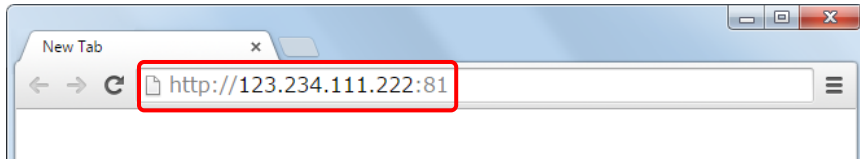

2. Specifications method on a browser (2) (When using DNS)

It is specified in the format of "URL of the router: Port No.".



3. Host address setting for screen group, screen, and web parts

When acquiring contents from the unit 1 and monitoring data of the unit 1 only, there is no need to change the default common setting of the host address referred by each screen group, screen, and web part.

The address inherited in the common setting is the "Address on the WAN side: Port No." entered in the browser.

<input type="checkbox"/> common parameters		
<input type="checkbox"/> device		
host address	Global settings	
network protocol	Global settings	
switch read device	type	Global
	device type	DT,n
	No.	0
switch write device	type	Global
	device type	DT,n
	No.	0

Setting example of a web part

1.2.4.3 Connecting to Multiple FP7 / ELC500 Units

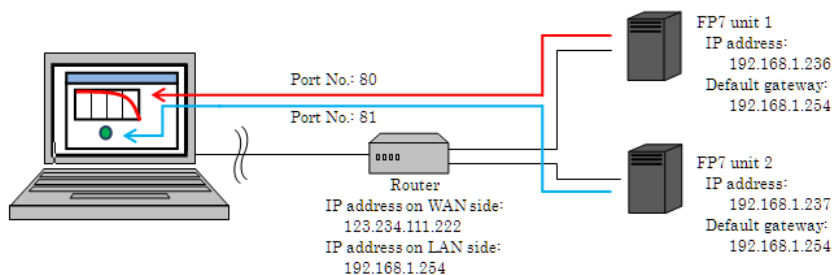

Example) When downloading a content connecting to the FP7 unit 1 from browser and monitoring the FP7 unit 2 with its web part

[Preparation 1] IP addresses are allocated to the FP7 CPU units.

For the default gateway setting of the FP7 units, specify the IP address on a LAN side of a router which performs address conversion. Communication cannot be performed properly without this setting.

[Preparation 2] Set a broadband router.

- Use a router having the NATP function of destination addresses.
- Set an IP address on a LAN side.
- Set an IP address on a WAN side. (such as a global IP address or URL)
- The destination NAT table of the router is set as follows.

Setting on WAN side Setting on LAN side

Port No. 80 : IP address of FP7 CPU unit 1 + Port No. 80

Port No. 81 : IP address of FP7 CPU unit 2 + Port No. 80

Concrete setting example

NAT Table

Group	IP address of WAN	Protocol		IP address of LAN	Port number of LAN
Group1	WAN IP address	HTTP(TCPPort:80)	←→	192.168.1.236	TCPPort:80
	WAN IP address	TCPPort:81	→	192.168.1.237	TCPPort:80

[How to specify addresses]

1. Specification method on a browser

An IP address on a WAN side of a router or a fixed private IP address of VPN is specified in the format of "IP address on WAN side of router: Port No.".

Concrete example:

For connecting to the unit 1: IP address on the WAN side of the router

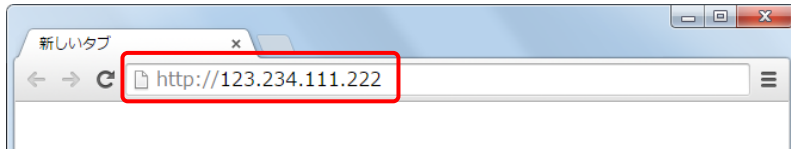

It can be omitted when connecting with the port number 80.

2. Host address setting for screen group, screen, and web parts

Set "IP address on the WAN side: Port No. registered in the NAT table" to the host address of a web part connected to the FP7 CPU (unit 2).

common parameters		
device		
host address	123.234.111.222:81	
network protocol	Global settings	
lamp status	type	Global
	device type	DT,n
	No.	0
lamp status mode	a	

IP address on the WAN side:
Port No. registered in the NAT
table

Note)

When a test operation is performed by the Web Creator in a local environment, it cannot communicate with the unit 2 if the IP address on the WAN side is specified for the host address.

For a test operation, set the host address to "IP address of the unit 2: Port No. 80".

For details of the test method, refer to "3.5.4 Screen Test".

1.2.5 Connection Using SSL

1.2.5.1 Restrictions on SSL Communication

Example) When connecting to two FP7 units (Unit 1 and unit 2)

	FP7 unit 1	FP7 unit 2	
SSL setting	N/A	N/A	Usable (Refer to the previous chapter.)
A: Available	N/A	A	This combination is not usable.
N/A: Not available	A	N/A	This combination is not usable.
	A	A	Usable

1.2.5.2 Connecting via Local Network

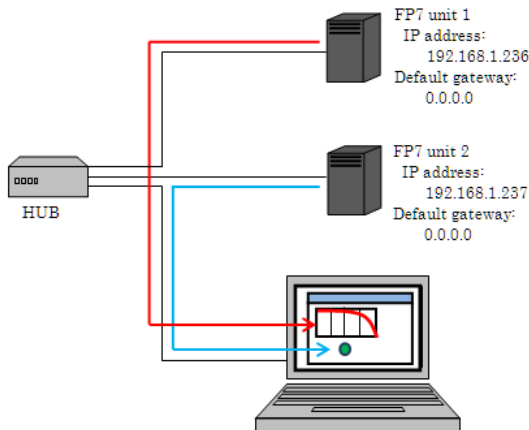

Example) When connecting to the FP7 unit 1 from a browser, downloading contents, and monitoring the FP7 unit 2 from that web part
(This type of connection method is called a cross-domain connection.)

[Preparation 1] IP addresses are allocated to the FP7 CPU units.

Set the default gateways to "0.0.0.0".

[Preparation 2] Set server certificates for the FP7 CPU units.

Server certificates can be set from the Web Creator.

For details, refer to "3.5.8.1.1 Setting Server Certificate in PLC".

[Preparation 3] Register a root certificate in a PC.

Register a root certificate that is issued by the publisher of the server certificate registered in the FP7 CPU unit in the PC.

Without the root certificate, a content screen is not displayed even when connecting to the FP7 CPU unit.

For details, refer to "3.5.8.1.3 Registering Root Certificate in PC".

[How to specify addresses]

1. Specification Method on Browser

Specify https and the IP addresses of the FP7 CPU units.

Concrete example:

For connecting to the unit 1: https://IP address of the unit 1



The SSL communication uses the port number 443, however, it can be omitted.

2. Host address setting for screen group, screen, and web parts

Set the IP address of the unit 2 to the host address of a web part connected to the FP7 CPU (unit 2).

⊞ common parameters

⊞ device

host address	<input type="text" value="192.168.1.237"/>	IP address of the unit 2
network protocol	Global settings	▼
lamp status	type	Global
	device type	DT,n
	No.	0
lamp status mode	a	▼

Setting example of a web part

1.2.5.3 Connecting via Global Network

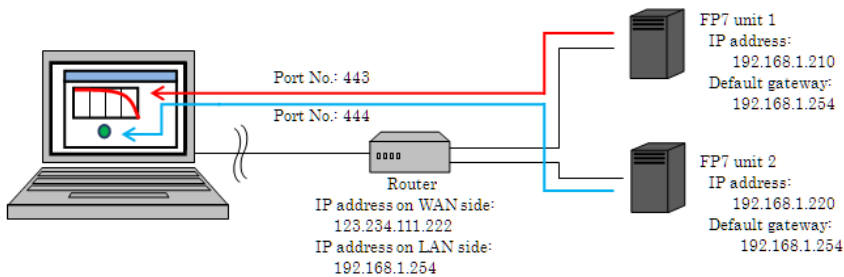

Example) When downloading a content connecting to the FP7 unit 1 from browser and monitoring the FP7 unit 2 with its web part

[Preparation 1] IP addresses are allocated to the FP7 CPU units.

For the default gateway setting of the FP7, specify the IP address on a LAN side of a router which performs address conversion. Communication cannot be performed properly without this setting.

[Preparation 2] Set a broadband router.

- Use a router having the NAPT function of destination addresses.
- Set an IP address on a LAN side.
- Set an IP address on a WAN side. (such as a global IP address or URL)
- The destination NAT table of the router is set as follows.

Setting on WAN side Setting on LAN side
 Port No. 443 : IP address of FP7 CPU unit 1 + Port No. 443
 Port No. 444 : IP address of FP7 CPU unit 2 + Port No. 443

Note) When using a port number other than 443, use an unused port.

Concrete setting example

NAT Table

Group	IP address of WAN	Protocol		IP address of LAN	Port number of LAN
FP7WebSSL	WAN IP address	TCP	Port:443 <—>	192.168.1.210	TCP
	WAN IP address	TCP	Port:444 —>	192.168.1.220	TCP

[Preparation 3] Set server certificates for the FP7 CPU units.

Server certificates can be set from the Web Creator.
For the domain of the certificate, register the IP address of the router on the WAN side.
 For details, refer to "3.5.8.1.1 Setting Server Certificate in PLC".

[Preparation 4] Register a root certificate in a PC.

Register a root certificate that is issued by the publisher of the server certificate registered in the FP7 CPU unit in the PC.
Without the root certificate, a content screen is not displayed even when connecting to the FP7 CPU unit.

For details, refer to "3.5.8.1.3 Registering Root Certificate in PC".

[How to specify addresses]

1. Specification Method on Browser

An IP address on a WAN side of a router or a fixed private IP address of VPN is specified in the format of "https://IP address on WAN side of router: Port No.".

Concrete example:

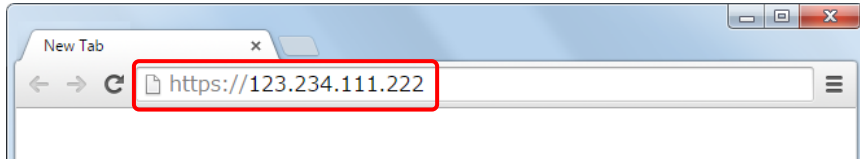

The SSL communication uses the port number 443, however, it can be omitted.

2. Host address setting for screen group, screen, and web parts

Set "IP address on the WAN side: Port No. registered in the NAT table" to the host address of a web part connected to the FP7 CPU (unit 2).

common parameters

device

host address	<input type="text" value="123.234.111.222:444"/>	IP address on the WAN side: Port No. registered in the NAT table
network protocol	Global settings	
lamp status	type	Global
	device type	DT,n
	No.	0
lamp status mode	a	

Setting example of a web part

1.3 Customer Web

1.3.1 Outline of Method of Using Customer Web

The following is the general flow of using the customer web.

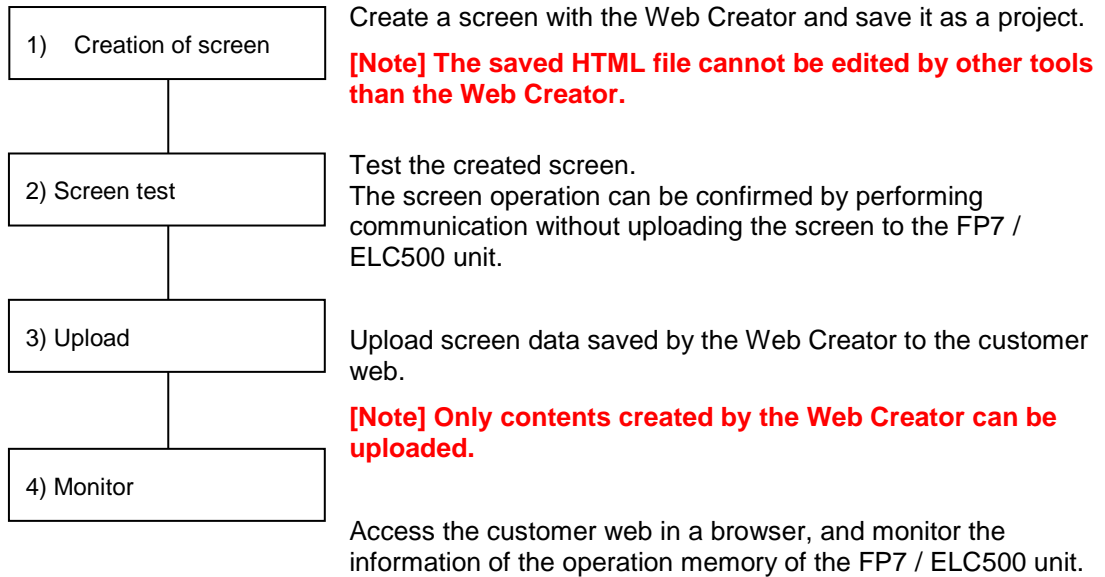

2

Installing Web Creator

2.1 Method of Installing Web Creator

The procedure of installing the Web Creator is as follows.



◆ PROCEDURE

1. Start the installer of the Web Creator.

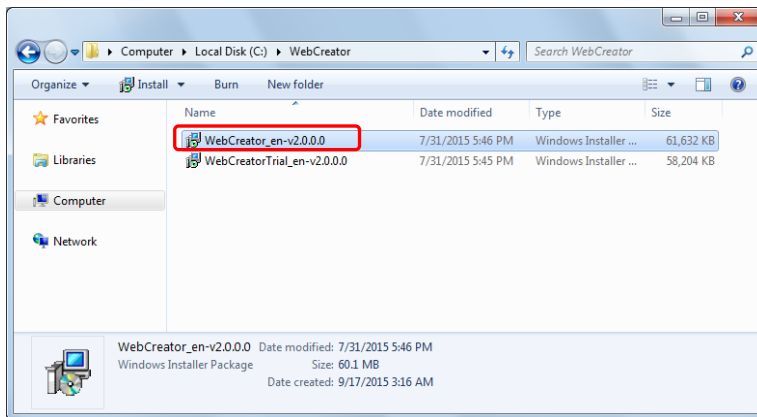

* There are the installers of Japanese version and English version, however, the contents to be installed are the same.

There is no need to install the both versions.

2. Proceed the operation according to the guidance of the installer.

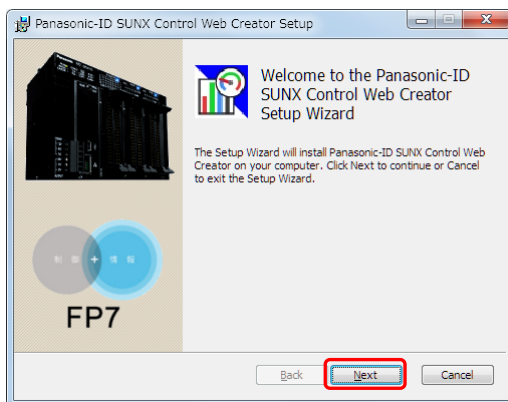

3. Confirm the software license agreement, and check the box for accepting the agreement.

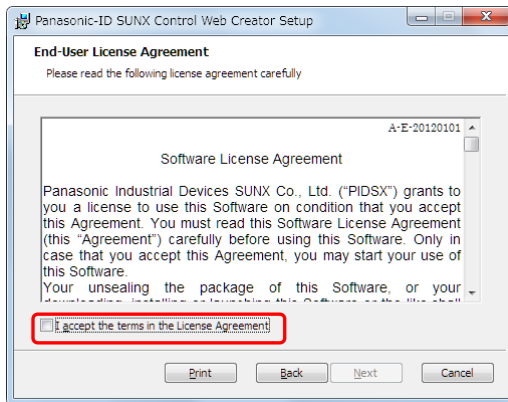

4. Select an installation destination.

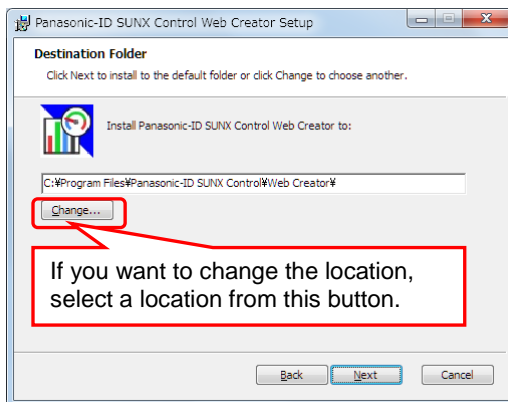

5. Start the installation.

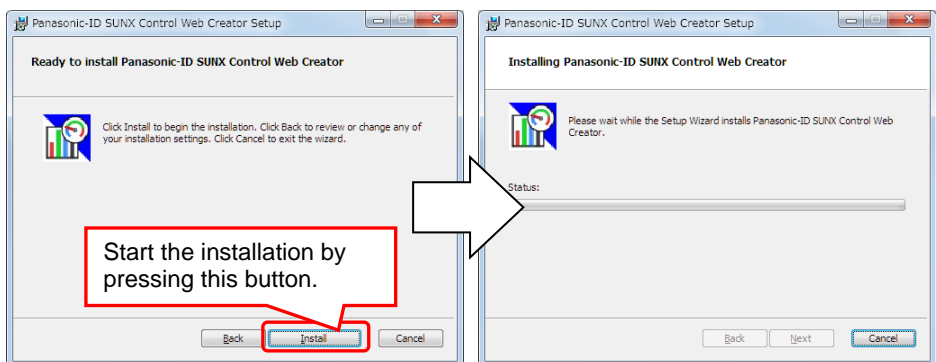

6. Finish the installation.

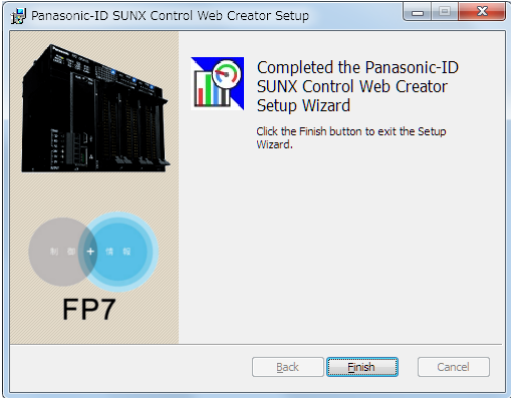

2.2 Folder Structure of Web Creator

■ Content folder

Data is created in the following folders in my document folder.

The project data for FP7 / ELC500 and for Eco-POWER METER are created in different folders respectively.

For adding a file, save it into a folder suitable for its purpose. In the case of a background image file, save it into the backgrounds folder.

Web Creator	└─	WebContents: Storage folder of project folder when selecting FP7 / ELC500
		└─ xxx.gst : User-created project data
		└─ ssl : Storage folder of server certificate (Details)
		└─ downloads : Storage location of download data
	└─	WebContents_ECO : Project when selecting Eco-POWER METER
		Storage folder of data
		└─ xxx.gst : User-created project data
		└─ downloads : Storage location of download data
	└─	WebCommons : Storage folder of project common file
		└─ audio : Storage folder of audio file (Details)
		└─ beeps : Storage folder of switch operation sound
		└─ pdf : Storage folder of PDF file (Details)
		└─ img : Storage folder of web part image file (*1)
		└─ backgrounds : Storage folder of background image file
		└─ cfonts : Storage folder of font file
		└─ textures : Storage folder of texture file
		└─ video : Storage folder of moving image file (Details)
	└─	Ladder : Storage folder of import ladder file (Details)
	└─	Exports : Storage folder of export project (Details)
	└─	Imports : Storage folder of import project (Details)

*1: For saving the server certificate, create a "ssl" folder directly under a project folder used, and save it into this folder.

■ Application installation folder

The following files are created in the folder specified at the time of installation.

WebCreator	└─ WebCreator.exe	: Execution file
	└─ WebCreator.png	: Icon image file
	└─ mfc100u.dll	: DLL file for Web Creator
	└─ msvc100.dll	: DLL file for Web Creator
	└─ msucr100.dll	: DLL file for Web Creator
	└─ WebCertWrite.dll	: DLL file for Web Creator
	└─ WebDataWrite.dll	: DLL file for Web Creator
	└─ WebDataWrite_ECO.dll	: DLL file for Web Creator
	└─ WebReadDataConvert.dll	: DLL file for Web Creator
	└─ WebWriteDataConvert.dll	: DLL file for Web Creator
	└─ KeyPairVerify.dll	: DLL file for Web Creator
	└─ libeay32.dll	: DLL file for OpenSSL (*)
	└─ ssleay32.dll	: DLL file for OpenSSL (*)

*: In this product, the software developed by OpenSSL Project is incorporated for using OpenSSL Toolkit. (<http://www.openssl.org/>)

2.3 Changes in Web Creator Ver.3.0.0 or later

2.3.1 Changes in Web Creator Ver.3.1.0

■ Defect correction in Ver.3.0.0

No	Item	Description
1	Download	<p>Corrected the problem that switches or meter parts are not displayed on a test or monitor screen when using a project which is applied to the following case.</p> <p>- When using project data created with a Web Creator earlier than Ver.3.0.0 by downloading with Web Creator Ver.3.0.0.</p> <p>This fault does not occur when opening project data created with a Web Creator earlier than Ver.3.0.0 and stored in a disk.</p> <p>Please do not use Web Creator Ver.3.0.0. Please use Ver.3.1.0. For details, refer to the description below the table.</p>
2	Upload SSL certificate...	<p>Corrected the problem that the SSL certificate cannot be uploaded after the upload of contents.</p> <p>For using the certificate stored in the server, FP7CPU Ver.4.25 or later, or 3.45 to 3.99 should be used.</p>
3	Switch parts Lamp-switch parts	<p>Corrected the timing of the occurrence of an operation event when the switch mode is set to "invert" and the operation is registered for the up/down operation. (Details)</p>

● Detail of the defect correction item 1

When a project created with a Web creator earlier than Ver.3.0.0 is downloaded with the Ver.3.0.0, the monitor screen after a test or upload is not displayed correctly as the project cannot be converted properly. The project may not be restored to its original data.

Please do not use Web Creator Ver.3.0.0. Please use Ver.3.1.0.

By reloading and saving the project that cannot be displayed correctly as above again after the upgrading the Web Creator to Ver.3.1.0, the project is converted to the correct data.

Earlier than Web Creator Ver.3.0.0



(1) Upload



In the case of Ver.3.0.0, screens may not be displayed correctly.

Web Creator Ver.3.0.0



(2) Download



(3) Upload

Normal display



Abnormal display



•Detail of the defect correction item 3

The timing of the occurrence of an operation when the switch mode is set to "invert" was corrected as illustrated below.

The both figures before correction and after correction show the operations when "audio playback" is set for the DOWN operation and "adding 10 to DT100" for the UP operation.

Before Ver.3.1.0 (Before correction)

Before the correction, "the DOWN operation is executed when left-clicking (pressing) a part with a mouse" and "the UP operation is executed when left-clicking (releasing) a part with a mouse".

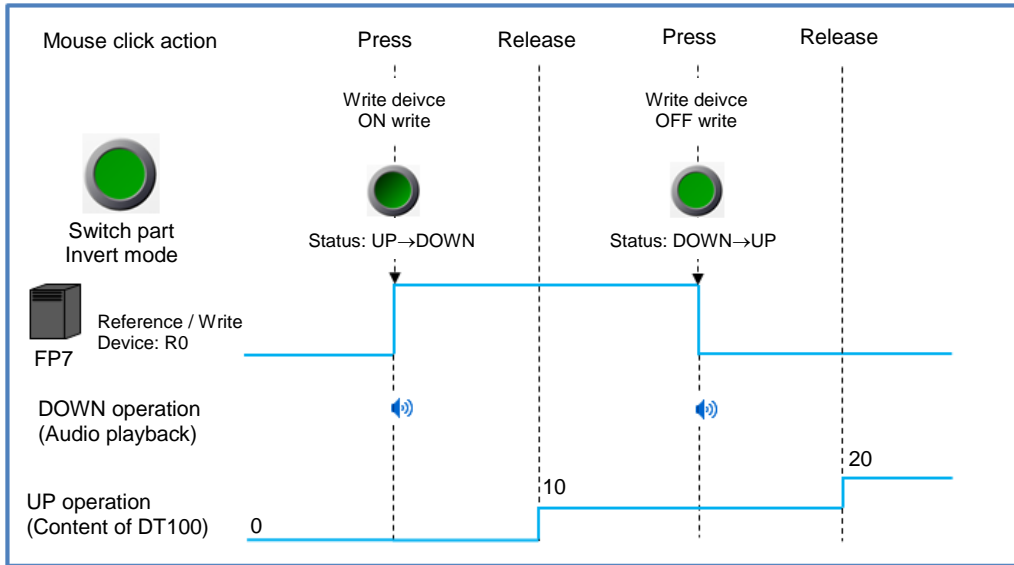

Ver.3.1.0 (After correction)

After the correction, "the DOWN operation is executed when the switch status changes from UP to DOWN" and "the UP operation is executed when the switch status changes from DOWN to UP".

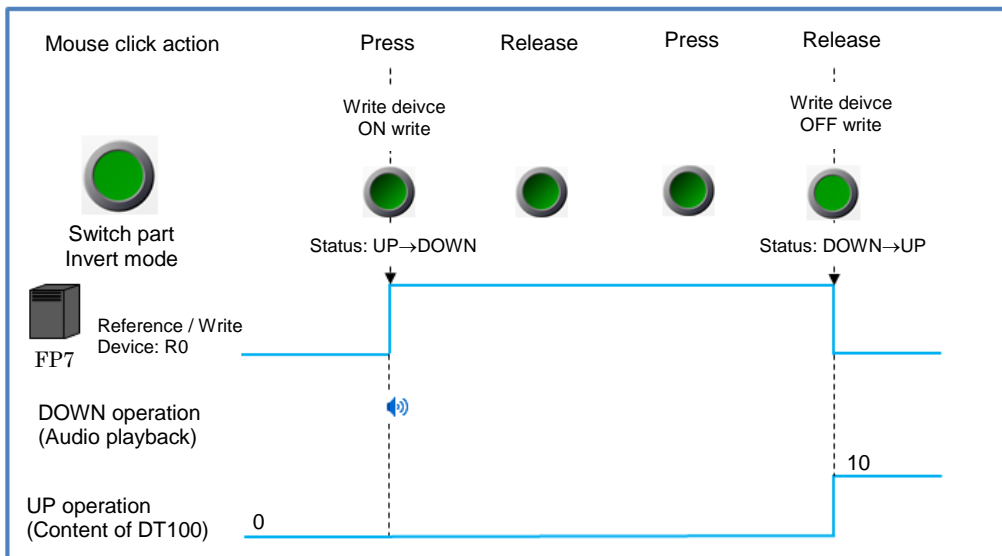

■ Overview of improved functions of Ver.3.1.0

No	Item	Description
1	Extended graph parts	- The time unit for the x axis can be specified when using trend graphs. - The setting items of x-axis properties " decimals " and " increment " were eliminated. The x-scale display can be adjusted by "X magnification". 3.5.7.2.5 Extended Graph Parts (Improvement in Ver.3.1.0)
2	Data parts Table parts	Added Time 0 (BIN) to "format". For details of table parts, also refer to the following data parts. 3.5.7.2.6 Data Parts (Improvement in Ver.3.1.0)

■ Precaution when using extended graphs created with a Web Creator earlier than Ver.3.0.0 on Ver.3.1.0

The items "initial display" and "magnification(1=all view)" has been added to the extended graph settings in Ver.3.0.0. As all data is displayed with these default settings, the initial graph display position differs when using extended graphs created with a Web Creator earlier than Ver.3.0.0. on Ver.3.0.0 or later.

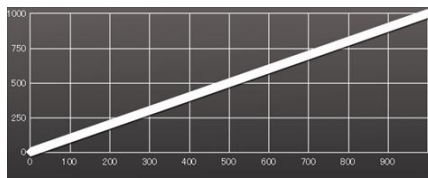

The data like the left figure is displayed as an extended graph whose number of display data is 1000.

Displayed with the version earlier than Ver.3.0.0

The data corresponding to the graph width is displayed first from the trailing point of a graph.

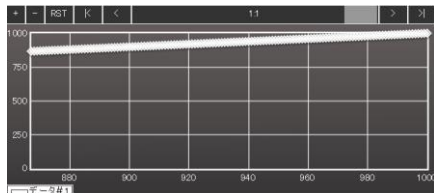

Displayed with Ver.3.0.0 or later

All data is displayed first.

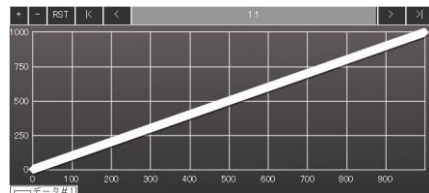

When the initial display of extended graphs is set to the version earlier than Ver.3.0.0, the settings for extended graphs should be specified as follows; "initial display = trailing points", "magnification (1=all view) = No. of all data / No. of data displayed first".

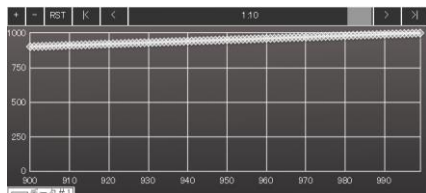

Initial display: trailing points
magnification (1=all view): 10
100 data is displayed first from the trailing point.

2.3.2 Changes in Web Creator Ver.3.2.0

It supports the new product ELC500.

2.4 Projects Created with Versions Earlier Than Ver.3.0.0

For using a project created by the version of Web Creator earlier than Ver.3.0.0, the project should be opened and saved once by the Web Creator Ver.3.0.0 or later.

The content data are automatically converted by saving the project.

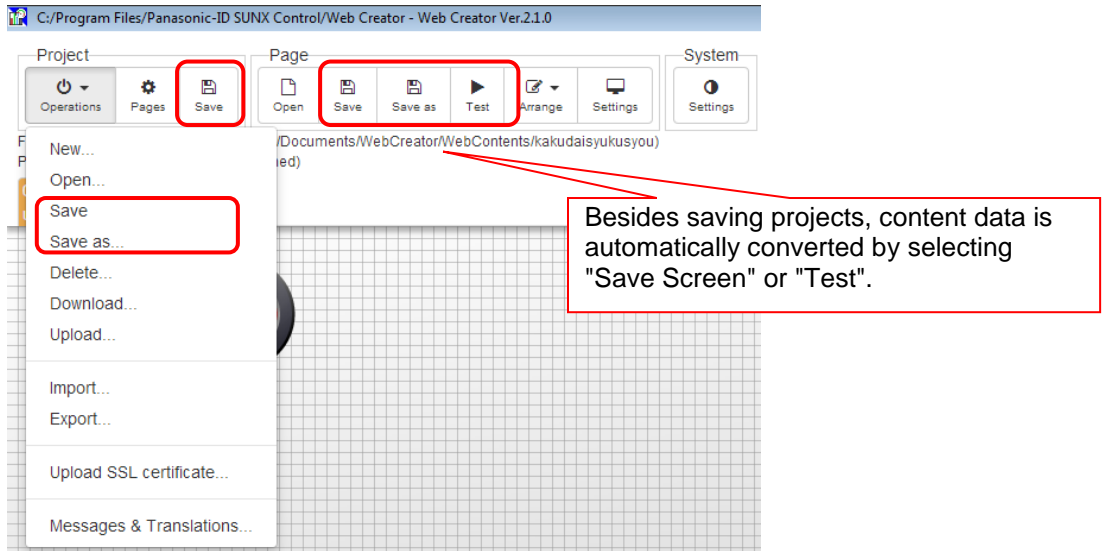

When trying to uploading data or confirming the content capacity without saving the project, a message will be displayed.

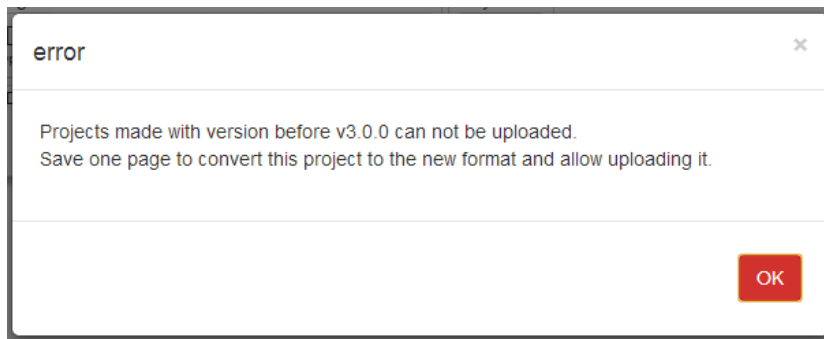

Note)

Projects saved by the Web Creator Ver.3.0.0 or later cannot be used by the Web Creator Ver.3.0.0 or earlier.

3

Web Creator Function

3.1 Overview of Web Creator

■ What is Web Creator?

- The Web Creator is software for creating and saving contents displayed on the customer web.
- Contents can be created by arranging web parts or graphics such as switches, lamps and meters and setting those properties.

■ What is project data?

- Created monitor screens and settings such as communication settings and security settings are called project data.
- Project data is stored in a project folder created by the Web Creator.

■ What is web part?

- Web part is a part unit that is composed of control part (such as switches), data part (such as meters) and static part (texts).
- By setting the properties, the operation memory of the FP7 / ELC500 can be monitored or set, or monitor screen pages can be switched.

■ What is graphic?

- Graphic is a part unit having a shape such as square, circle, and arrow. By setting the properties, the size or color arrangement can be adjusted.

■ Screen configuration

Screen configuration of Web Creator

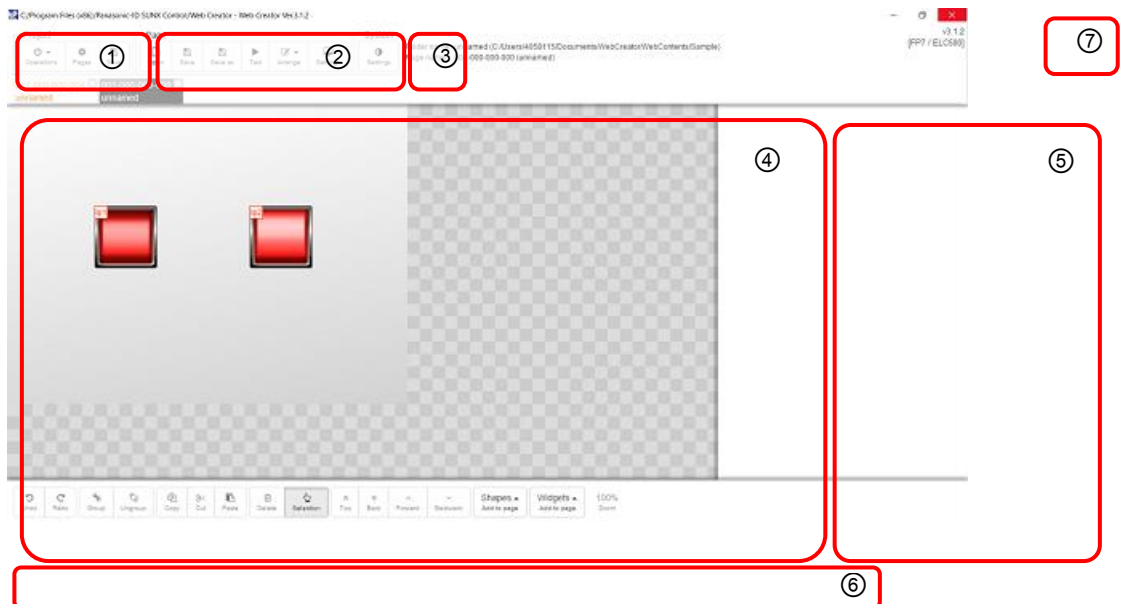

① Project menu: Project operation menu

- 1) Operations : Displays the operation menu.
 - a) New... : Creates a new project
 - b) Open... : Opens an existing project.
 - c) Save : Overwrites and saves a project.
 - d) Save as... : Saves a project as a specified name.
 - e) Delete... : Deletes a new project
 - f) Download : Downloads project data to PC from the FP7 /ELC500.
 - g) Upload : Transfers project data to the FP7 / ELC500 from PC.
 - h) Upload SSL certificate... : Sets/deletes the SSL certificate for/from the FP7 / ELC500.
 - i) Messages & Translations...: Defines a message displayed with a message part.
- 2) Multicopy : Controls the creation/deletion and settings of groups and screens.
- 3) Save : Overwrites and saves a project.

② Page menu

- 1) Open : Screen operation menu
- 1) Open : Opens a screen created by project management.
- 2) Save : Overwrites and saves the screen being edited.
- 3) Save as : Saves the screen being edited as a specified name.
- 4) Test : Confirms the operation of saved screen data communicating with the FP7 / ELC500.
- 5) Arrange : Displays the screen editing menu.
 - a) Multicopy... : Copies a selected part for a specified number continuously.
 - b) Mirroring : Switches the positions of selected multiple parts.
 - c) Center : Arranges selected multiple parts in the center of the screen.
 - d) Align... : Aligns selected multiple parts.
 - e) Delete all : Deletes all parts arranged in the screen.

③ System menu : Makes the settings related to the whole operation of the Web Creator.

④ Drawing area : Arranges various parts.

⑤ Property setting area : Displays the properties of arranged parts.

⑥ Toolbar

- 1) Undo : Toolbar for screen editing
- 1) Undo : Undoes the operation.
- 2) Redo : Redoes the operation.
- 3) Group : Groups selected multiple parts.
- 4) Ungroup : Ungroups a set of items.
- 5) Copy : Copies a selected part.
- 6) Cut : Cuts a selected part.
- 7) Paste : Pastes a selected part.
- 8) Delete : Deletes a selected part.
- 9) Selection : Changes the mode to the state in which parts are selectable in the drawing area.
- 10) Top : Moves the layer in which a selected part is arranged to the top (forward).
- 11) Back : Moves the layer in which a selected part is arranged to the bottom (backward).

- 12) Forward : Moves the layer in which a selected part is arranged to the layer next above (forward).
 - 13) Backward : Moves the layer in which a selected part is arranged to the layer next below (backward).
 - 14) Shapes Add to page : Arranges shapes parts such as circle, triangle, and square.
 - 15) Widgets Add to page : Arranges prepared parts.
- ⑦ Model and version information: Displays the model information of contents and version of the Web Creator.

3.2 How to Start Web Creator



◆ PROCEDURE

1. Insert the Key Unit (AFPSWCKEY) to the PC you use beforehand.
2. The Web Creator can be started from the Start menu "Web Creator".

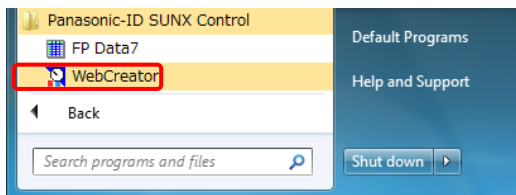

3. The Web Creator starts.



The display language of the Web Creator is determined by the language of OS at the time of startup.

The display language is switched according to the language of OS as follows.

Other languages: English display

Japanese OS: Japanese display

The display language of the Web Creator can be changed.

Once the display language is changed, the selected language is also used from the next startup.

For details of the method of switching the display language, refer to "3.5.8.9 Multi-language Switching Function of Web Creator".

3.3 Project Folder

A project folder should be specified before creating a screen.

Create or specify a project folder when starting the Web Creator or from the "Operations" menu of the project menu of the Web Creator.

* When the project folder is for the project for FP7 / ELC500, it can be created in WebContents folder.

The project for Eco-POWER METER can be created in Web-Contents_ECO folder.

3.3.1 Differences by Web Server Models

The model of a web server should be selected for creating a project by Web Creator.

Usable parts and functions depend on the selected web server model.

The contents that differ depending on each web server model are as follows.

	FP7 / ELC500	Eco-POWER METER
Parts	<ul style="list-style-type: none"> •None 	<ul style="list-style-type: none"> •Media player parts cannot be selected. •Writing operation is not available from each part. •For the device that can be specified in the part setting, the DT of global device is fixed.
Functions	<ul style="list-style-type: none"> •None 	<ul style="list-style-type: none"> •The screen switching function by a command from a controller is not available. •The screen number notification function is not available. •The SSL certificate setting function is not available.

* Except the above parts and functions, the same functions are available for the FP7 / ELC500 and Eco-POWER METER.

Note)

It is not possible to upload contents to other models than that selected when creating the project.

Also, the project cannot be converted to that for a different model. Make sure that you do not select a wrong model.

3.3.2 Creating Project Folder at Startup

Create a new project folder from the start screen.



◆ PROCEDURE

1. Click "Create a new project" in the start screen.

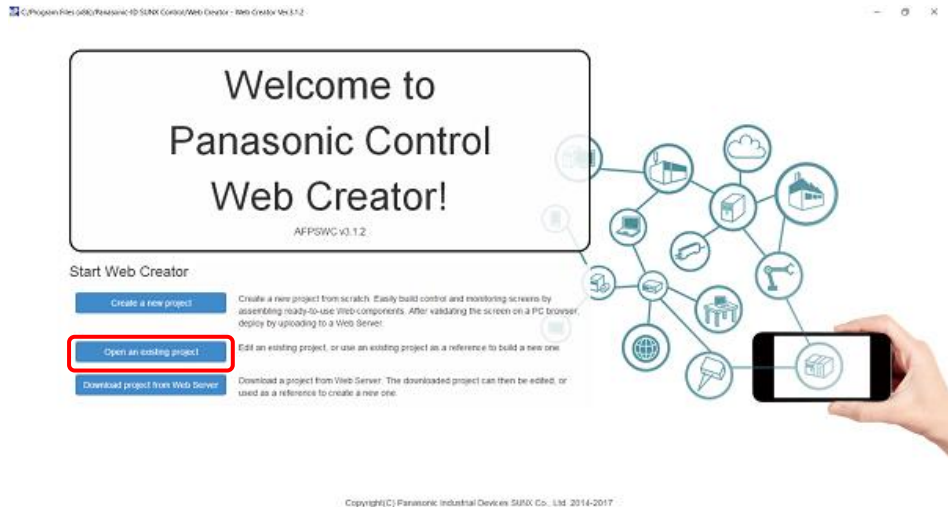

2. Select the model of the web server that is used in a created project.

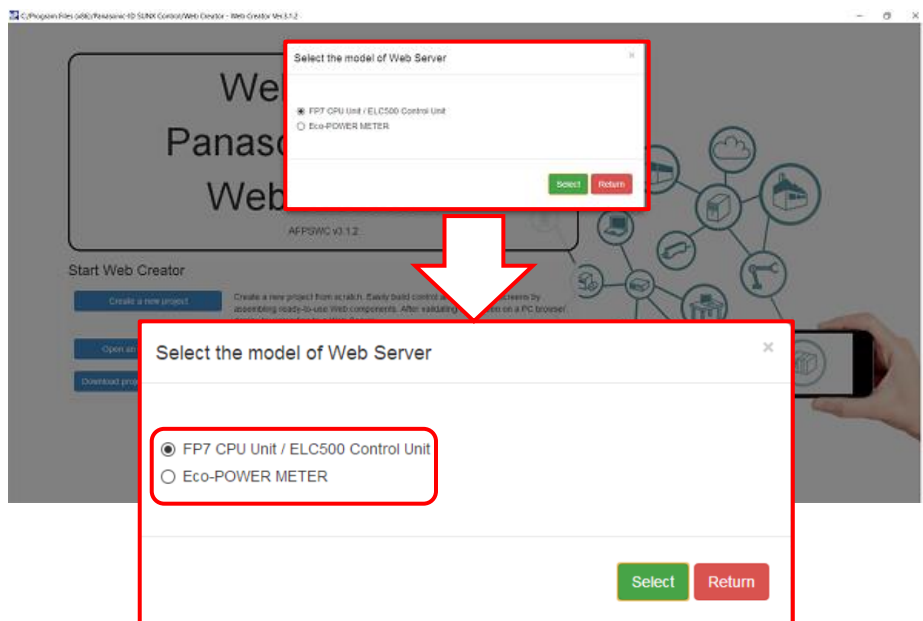

3. The list of projects is displayed.

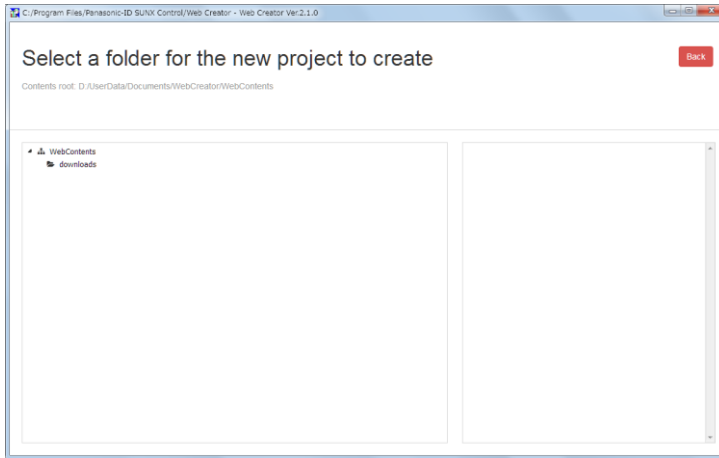

The project list of the selected model is displayed.

4. Clicking the WebContents (WebContents_ECO) displays the "New folder" button.

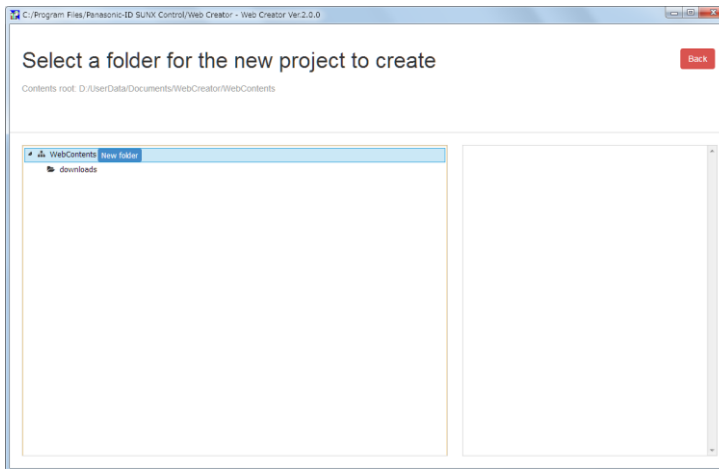

5. Click the " New folder " button to open the screen to enter a folder name. Enter a folder name, and click the "Create" button.

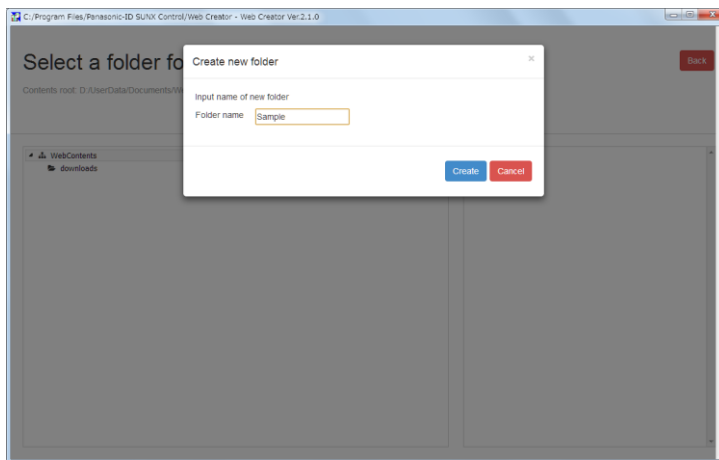

6. Click the "New project" button displayed by clicking on the created folder and create the project.

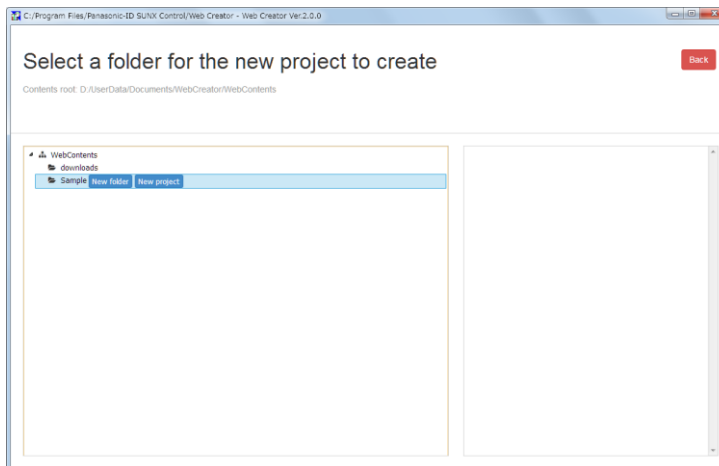

7. Once the project is created, the screen moves to the project management screen.

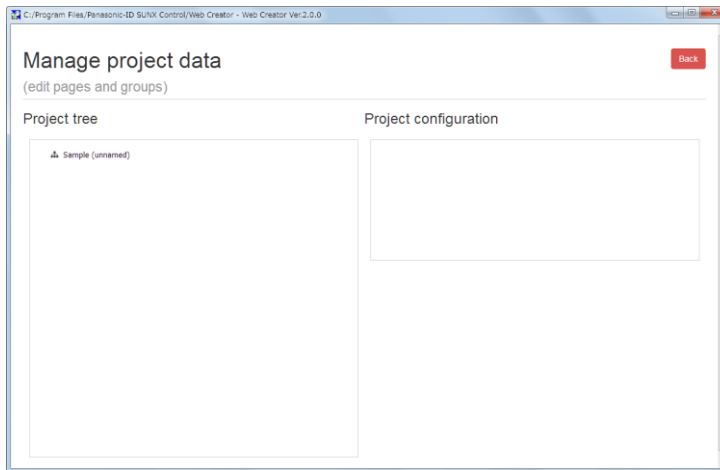

For creating groups or screens subsequently, carry out the creation from the project tree. Refer to "3.4 Project Management".

3.3.3 Specifying Existing Project Folder at Startup

Specify an existing project folder from the start screen.



◆ PROCEDURE

1. Click "Open an existing project" in the start screen.



2. Select the model of the web server.

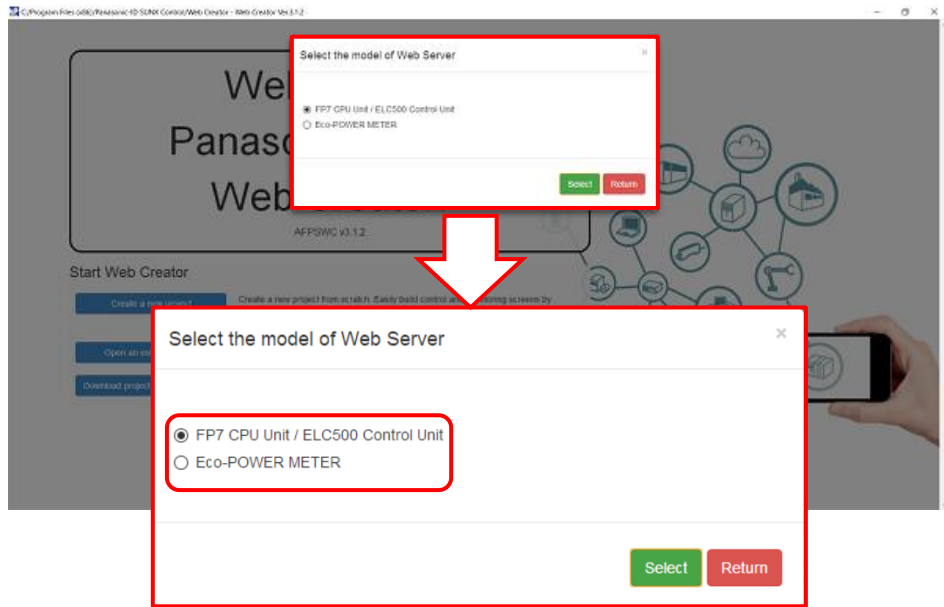

3. The list of existing projects is displayed.

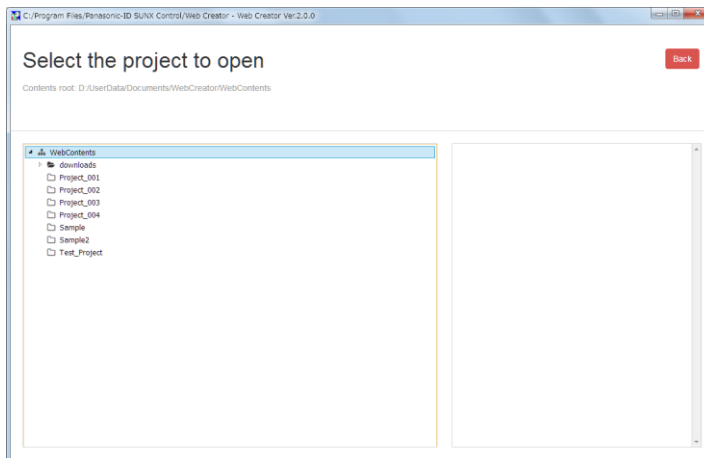

4. Clicking on the folder you want to open displays the "Open project" button. Click the button to open the project.

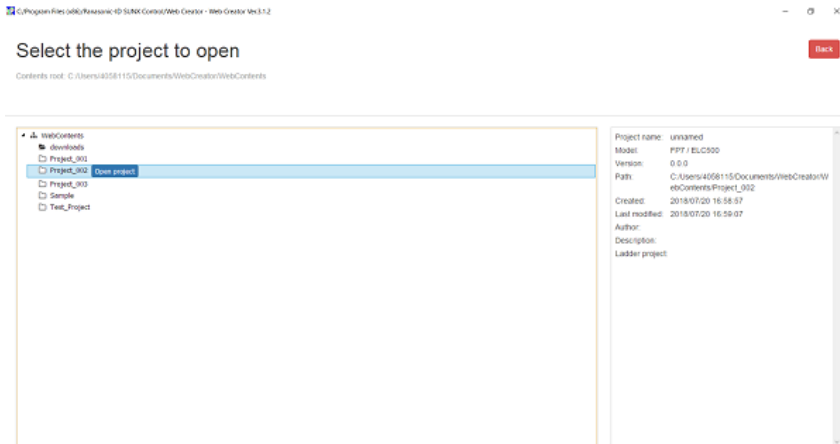

5. Once the project is opened, the screen moves to the project management screen.

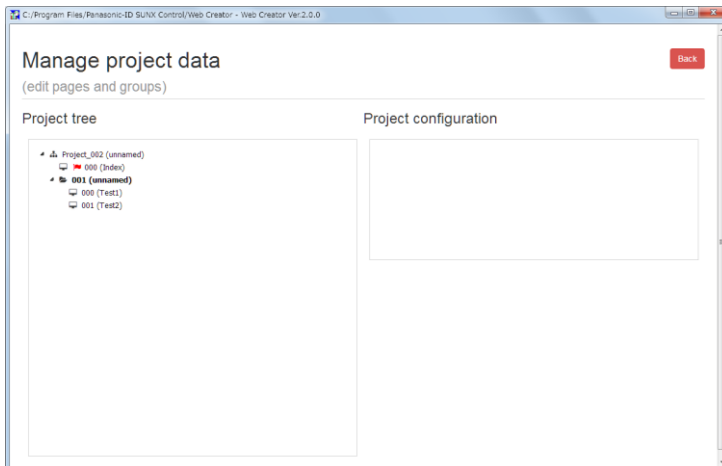

For opening an existing screen subsequently, open it from the project tree. For creating groups or screens, carry out the creation from the project tree. Refer to "3.4 Project Management".

3.3.4 Acquiring Project from Web Server at Startup and Editing It

Download a project from the Web Server in the start screen and edit the project.



◆ PROCEDURE

1. Click "Download project from Web Server" in the start screen.



2. Select the model of the web server to which the project is downloaded.

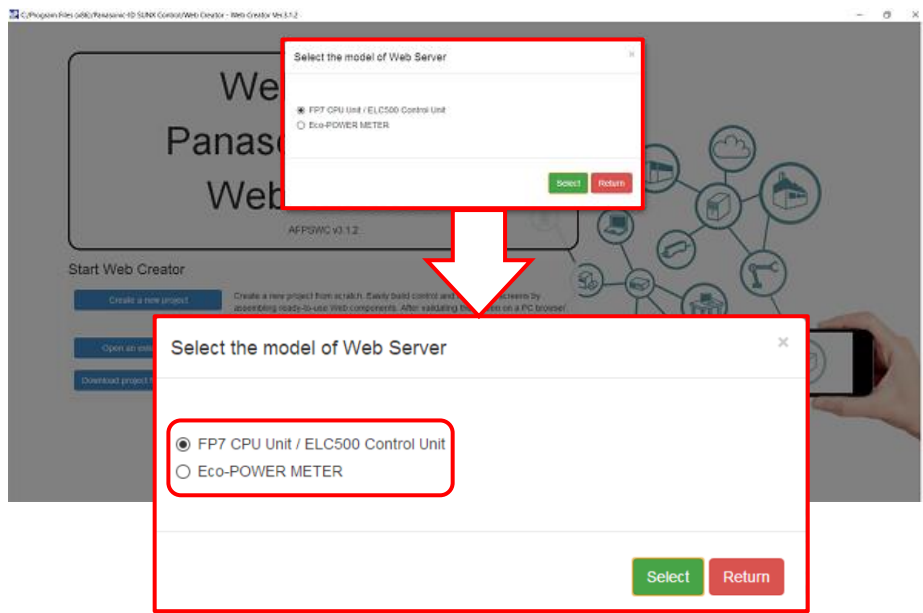

If the model of the web server is different from the selected model, the download cannot be performed.

3. Confirm the IP address, user ID and password* of the source Web Server *, and click "Download".

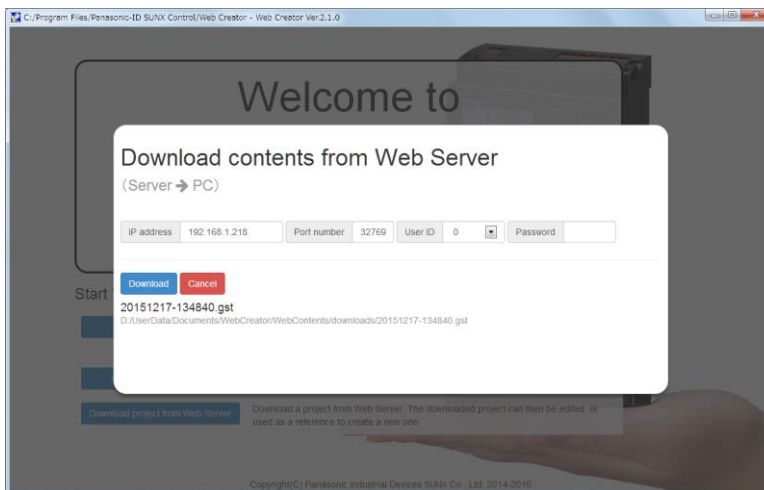

The default IP address is displayed for a download destination. Change it to the desired IP address.

The user ID and password varies by the security setting of FP7 / ELC500.

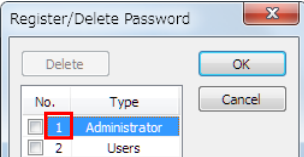
Security setting	User ID and Password
None	Connect as a master user. User ID: 0, Password: Not required
FPWIN GR7S security settings (FP7 only)	User ID: Number for administrator used when the password has been registered. (Figure below) Password: Administrator password used when the password has been registered.  (How to confirm) "Tools" > "PLC Security Settings" > "Register/Delete Password"
FPWIN Pro7 security settings	User ID: 1, Password: Password registered in Security Settings. (How to confirm) "Online" > "Security Settings"

* When the web server's model for a project currently being edited and the destination web server's model are different, the project cannot be downloaded.

* When downloading contents from the Eco-POWER METER, use the following settings; Port number: 32769, User ID: 1, Password: SystemWeb.

4. Pressing the "Close" button after the completion of download moves the screen to the project management screen.

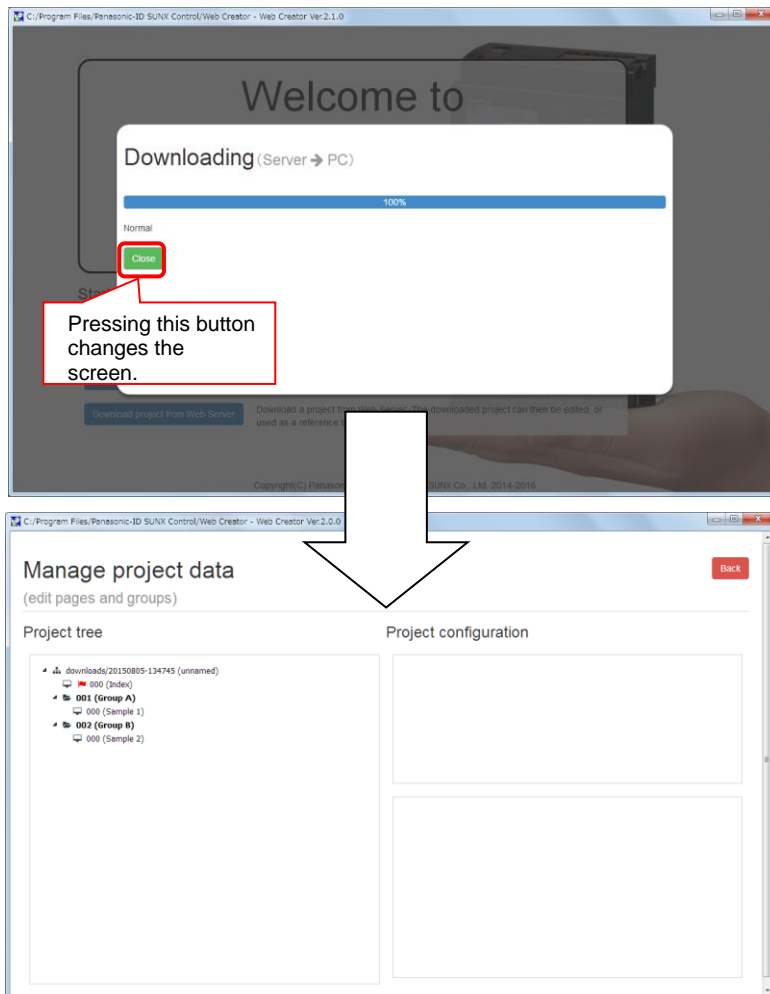

3.3.5 Creating Project Folder from Operation Menu

Create a new project folder from "Operations" > "New.." of the project menu of the Web Creator.



◆ PROCEDURE

1. Select the model of the web server that is used in a created project.

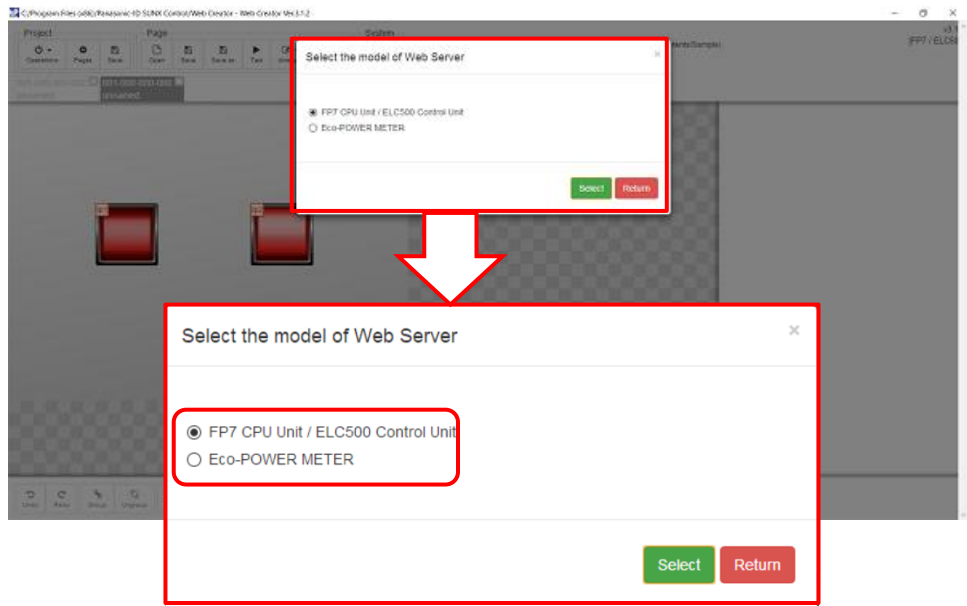

2. Specify a project folder newly created.

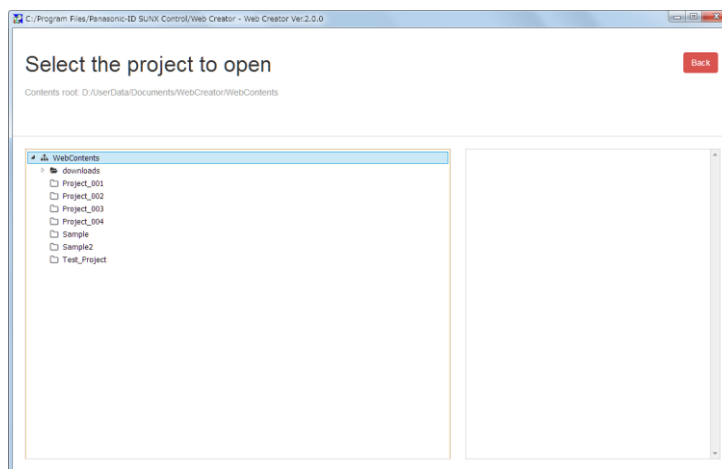

3. Clicking the WebContents (WebContents_ECO) displays the "New folder" button.

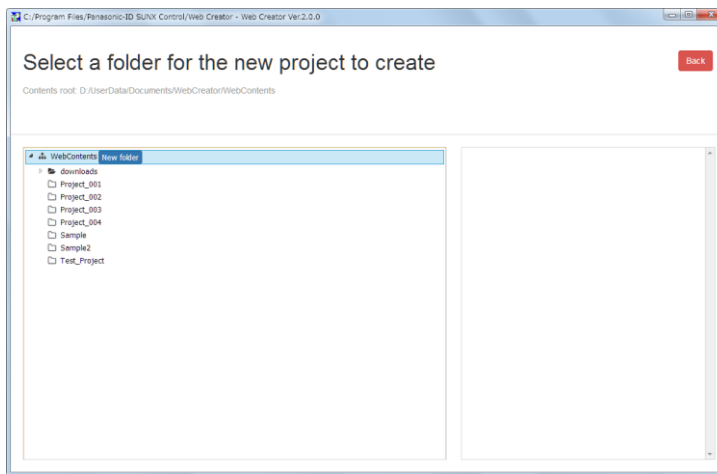

4. Click the "New folder" button to open the screen to enter a folder name. Enter a folder name, and click the "Create" button.

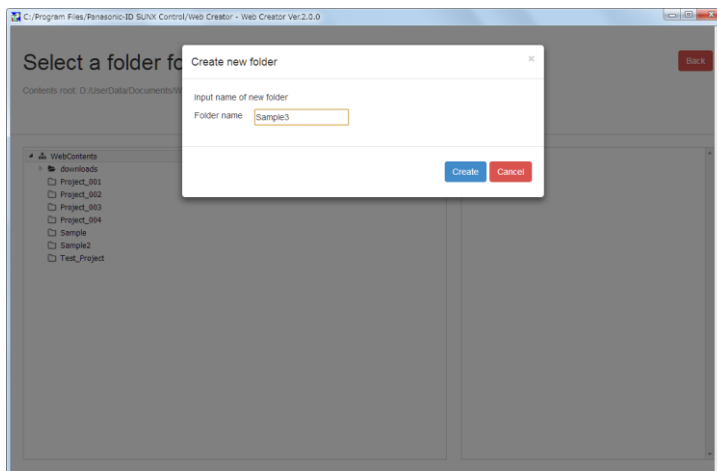

5. Click the "New project" button to create the project.

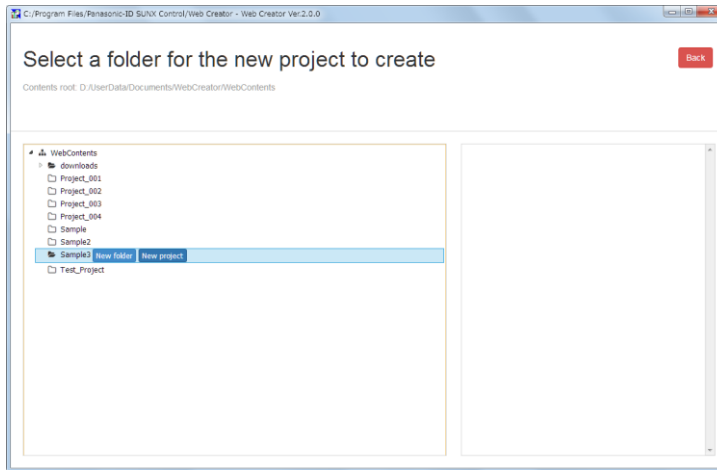

6. Once the project is created, the screen moves to the project management screen.

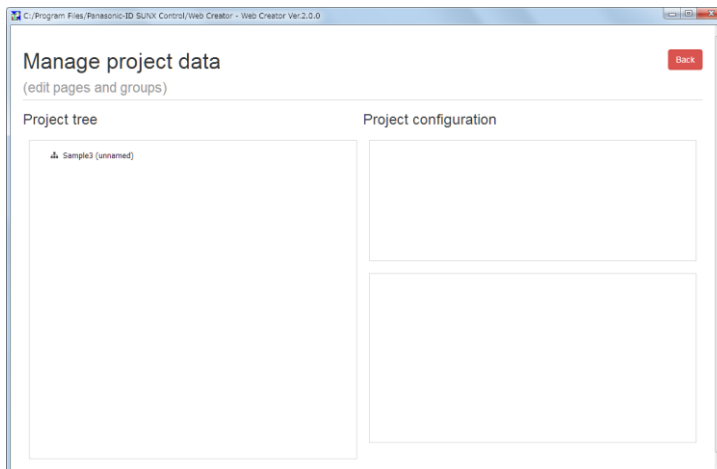

For creating groups or screens subsequently, carry out the creation from the project tree. Refer to "3.4 Project Management".

3.3.6 Specifying Project Folder from Operation Menu

Specify an existing project folder from "Operations" > "Open..." of the project menu of the Web Creator.



◆ PROCEDURE

1. Select the model of the web server that is used in a project to be read.

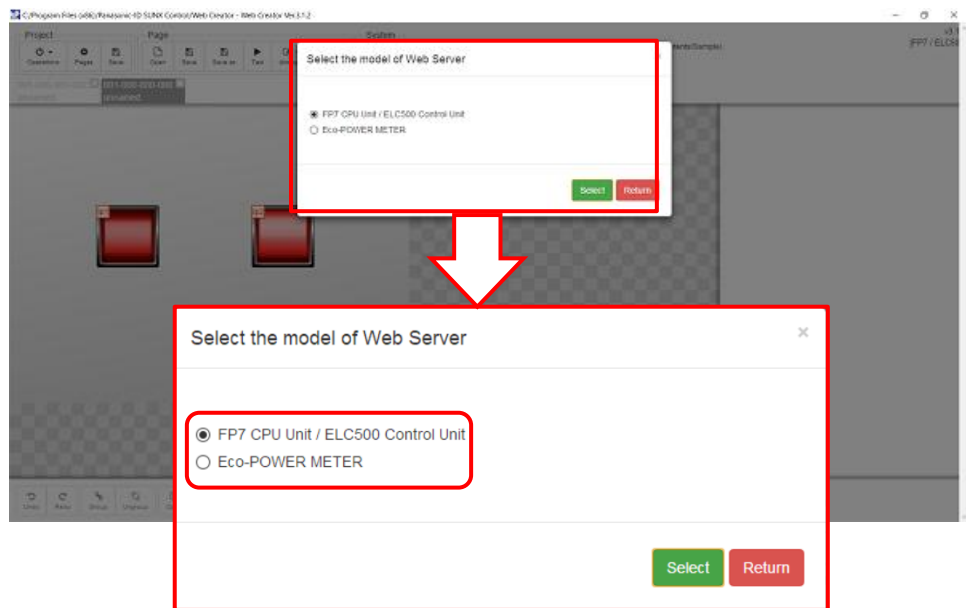

2. Specify an existing project folder.

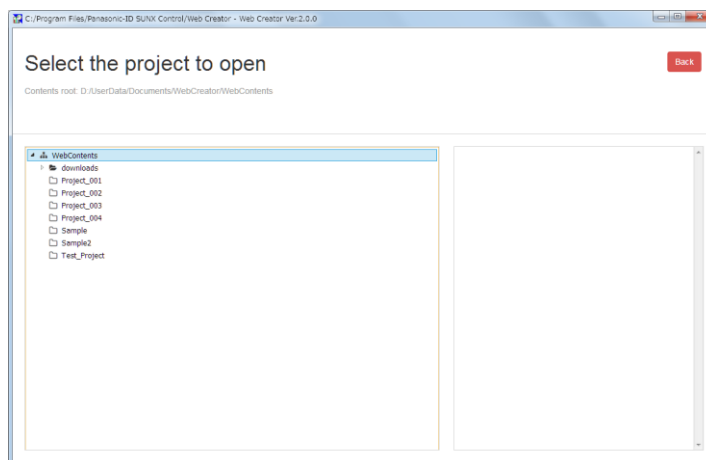

3. Clicking on the folder you want to open displays the "Open project" button. Click the button to open the project.

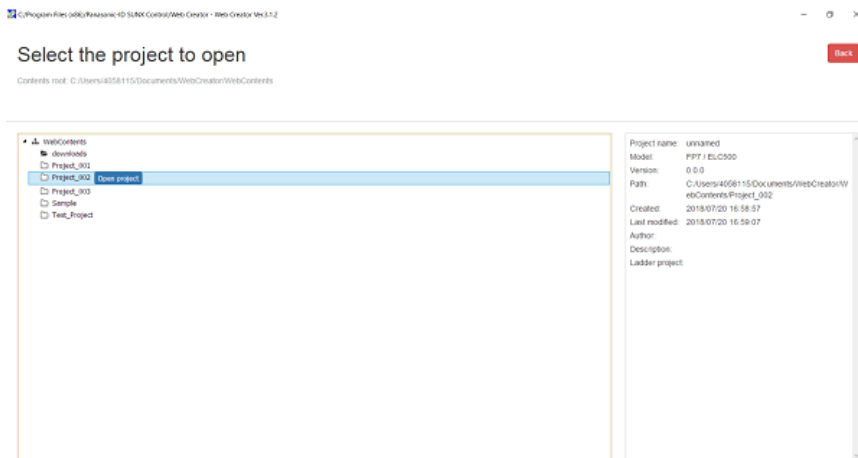

4. Once the project is opened, the screen moves to the project management screen.

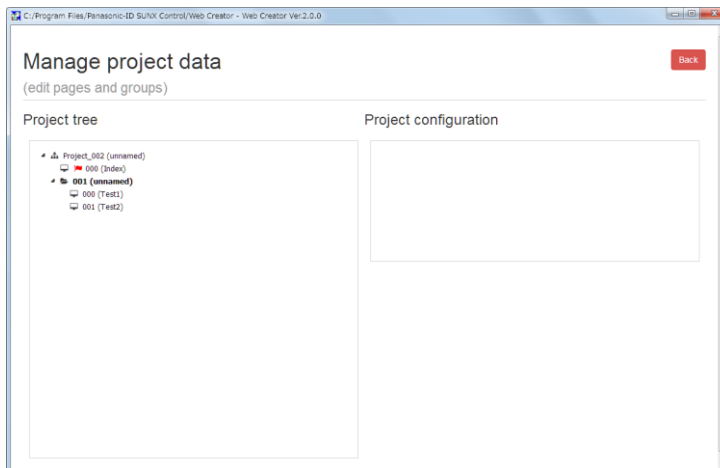

For opening an existing screen subsequently, open it from the project tree.
For creating groups or screens, carry out the creation from the project tree.
Refer to "3.4 Project Management".

3.4 Project Management

Select a project folder when starting the Web Creator.

3.4.1 Configuration of Project Data

The project data of Web Creator is composed of a project, groups and screens.

Example of project configuration

Project tree

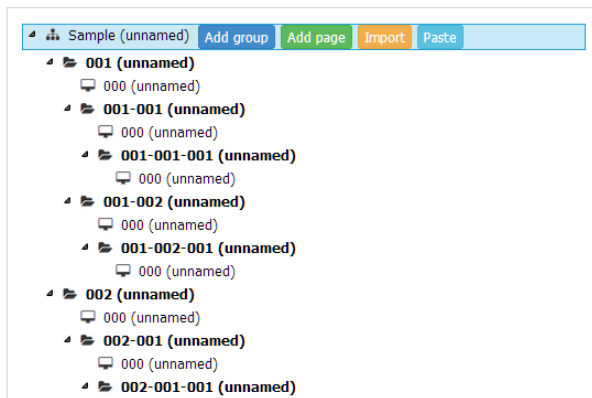

Up to 256 groups and 256 screens can be created for the whole project.

Configuration of screen number

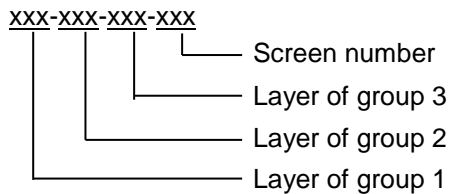

Screen numbers start from 000 by group.

Screen numbers of the screens that are created in the root of a project and do not belong to any group start from 000-000-000-00.

3.4.2 Project Setting

Configure the common setting for a project.



◆ PROCEDURE

1. Click "Pages" of the project menu.

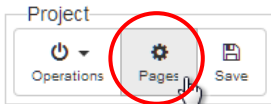

2. Open the project tree screen.

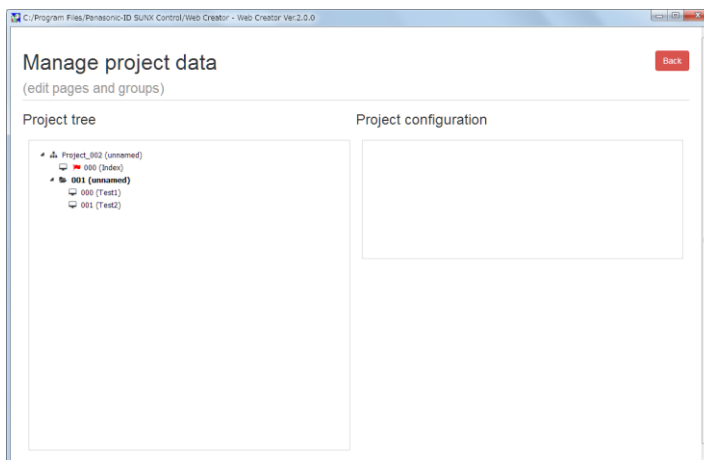

Click the project of the project tree.

3. Click the "Configure" button.

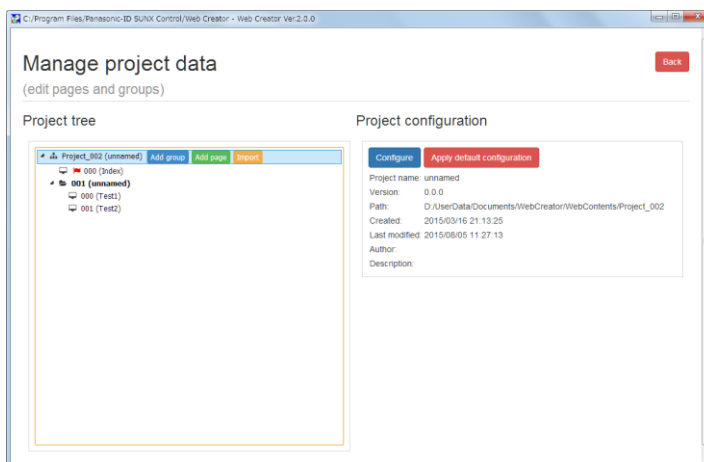

4. Enter the project name on the "Project" tab.

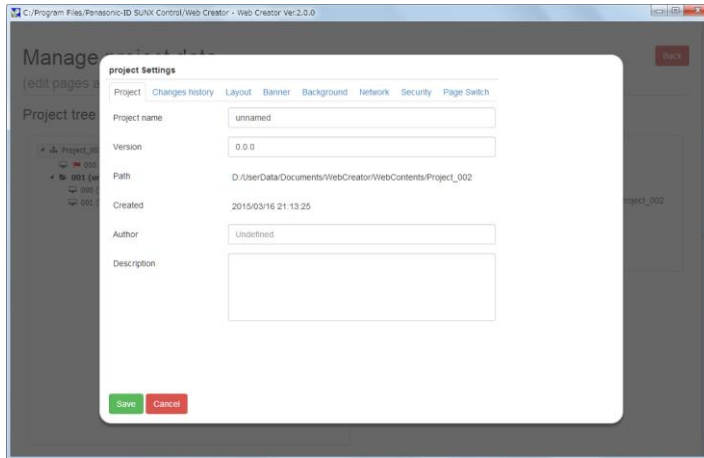

5. Configure the setting on the "Network" tab.

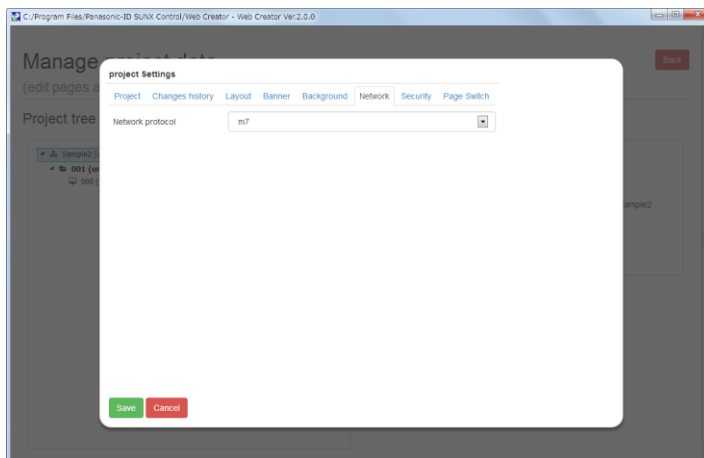

It is not necessary to set an IP address when a communication destination party refers to the FP7 /ELC500.

Its own IP address is automatically determined from the URL when connecting to the custom web.

When a communication destination party differs from the FP7 /ELC500, set a communication destination by the procedure described in "3.4.3 Creating Groups" or "3.4.4 Creating Screens".

The "Layout", "Background", "Network" and "Security" settings of the project setting are the common settings to the groups and screens under this project.

3.4.2.1 Link with Ladder Projects

Ladder projects used for created web contents can be registered. Registered ladder projects are output to an export destination when exporting a project.

For details of the export of projects, refer to "3.4.9 Exporting Projects".

This setting is available only for the project setting. This setting cannot be made from the group setting or screen setting.



◆ PROCEDURE

1. Click "Pages" of the project menu.

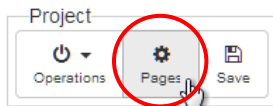

2. After selecting a project of the project tree, open the advanced setting screen for the project setting.

3. Select the "Project" tab.

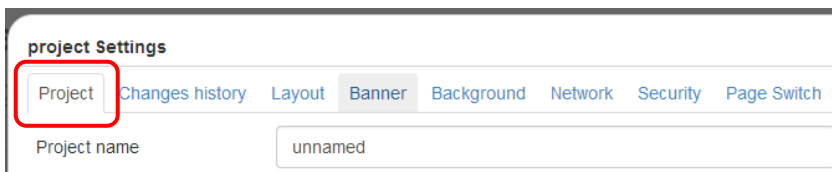

4. Select a ladder file.

There are three methods of selecting ladder files.

Selecting method 1: Set the ladder file to be linked from "Select file".

By this method, ladder files other than those in the drive in which the Web Creator has been installed cannot be selected.

For selecting ladder files in another drive, refer to the descriptions of the methods 2 and 3.



As the file reference screen opens, select a desired ladder file.

C:/Program Files/Panasonic-ID SUNX Control/Web Creator - Web Creator Ver.2.1.0

Please select a ladder project file.

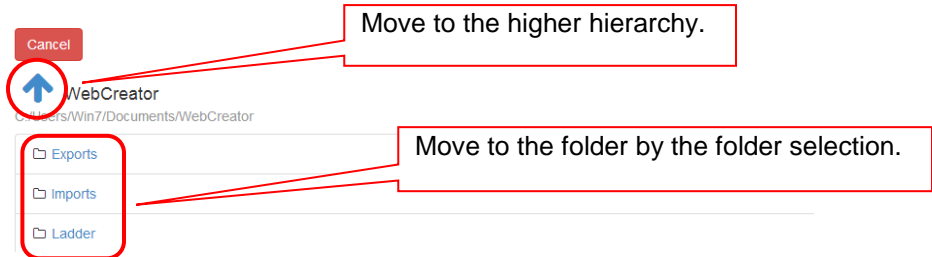

Selecting method 2: Acquire the address of a ladder file from the explorer screen.

Open the location of a ladder file to be linked.

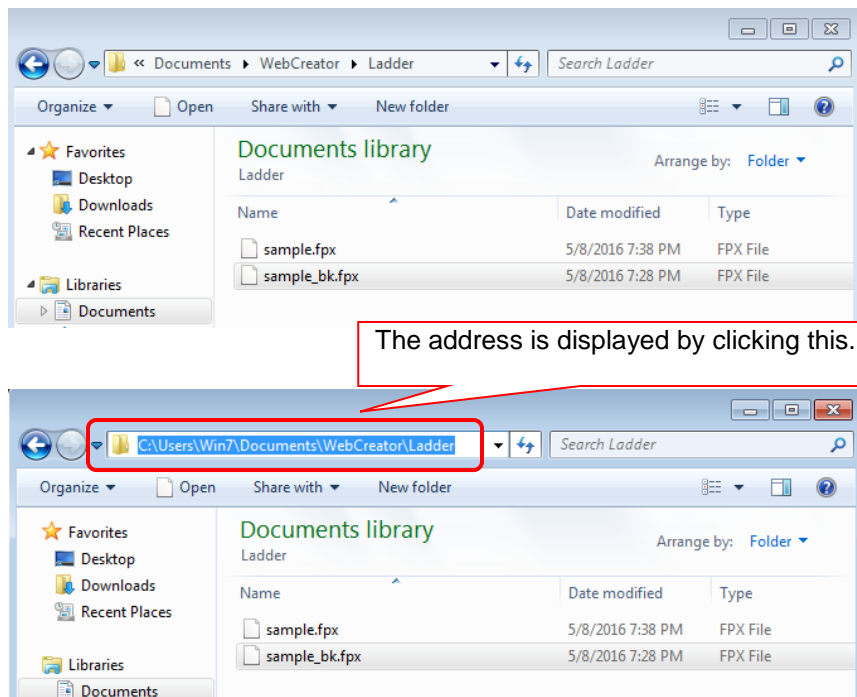

Copy the address of the ladder file to the ladder project address field of the advance setting screen by an operation such as right-clicking, and then press the file selection button.

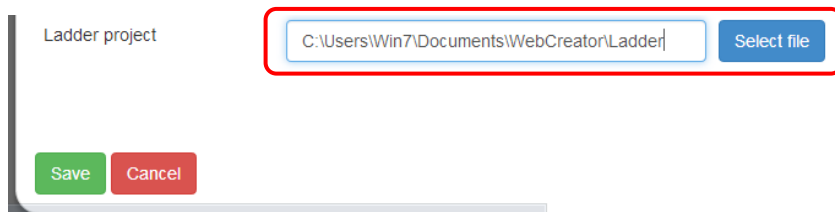

As the file reference screen opens, select a ladder file to be linked.

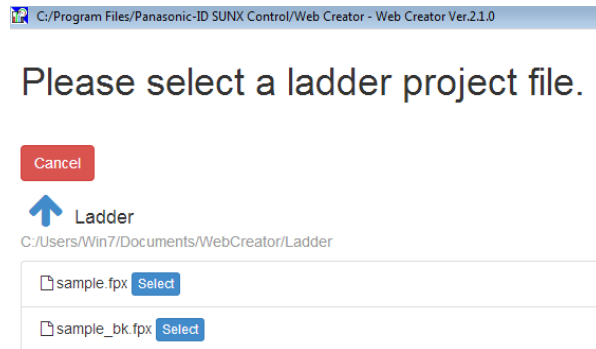

Selecting method 3: The address of a ladder file can be directly input in the address field of ladder project.

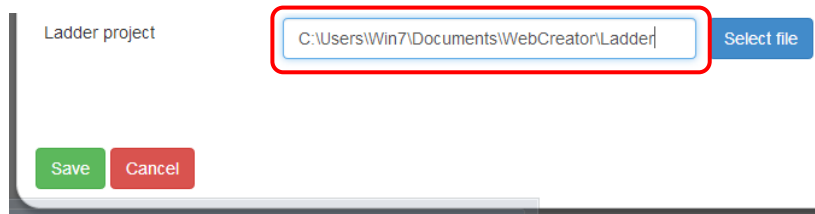

5. After selecting a ladder file by any of the above methods, pressing the save button completes the link with the ladder project.

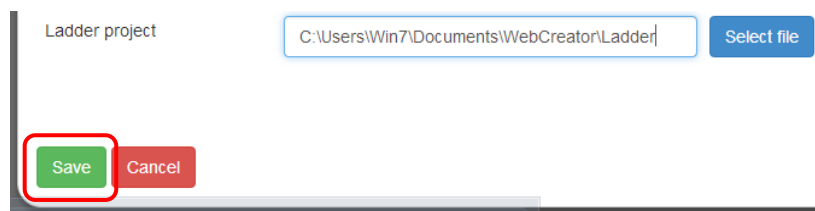

3.4.2.2 Display Setting of language Switching Menu

The setting whether to display or hide the language switching menu when monitoring the screen can be changed by changing the display setting of the language switching menu. (Up to Ver.2.1.0, the language switching menu is always displayed when a multilingual message has been registered.)

The language switching menu can be displayed at an arbitrary timing by the operation setting with items such as a switch.

For details of the language switching function, refer to "3.5.7.1.1 Multilingualization of Parts Display".

The setting priority is as shown below. For the common setting, a next higher priority setting is applied. (Low) Project setting < Screen group setting < Screen setting (High)



◆ PROCEDURE

1. Click "Pages" of the project menu.

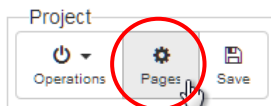

2. After selecting a project of the project tree, open the advanced setting screen for the project setting.

3. Select the "Layout" tab.

4. Change the setting of "Language menu visibility".

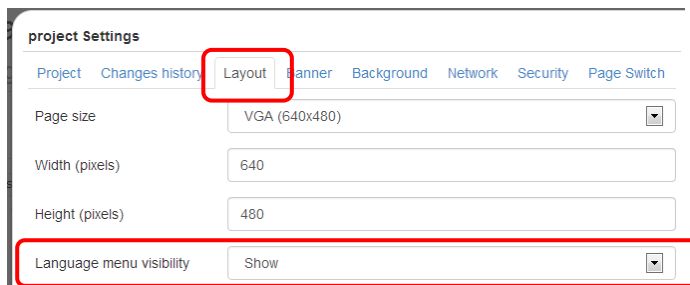

When setting "Hide", the language switching menu is not displayed even when multiple languages have been registered.

Example of motor screens

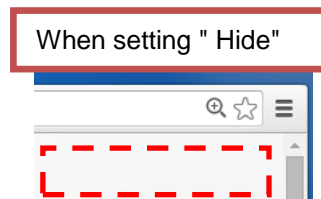
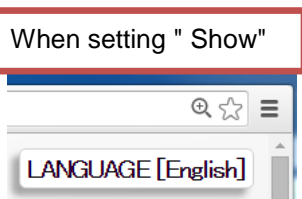

3.4.3 Creating Groups

Add groups to a project.

Groups can be added to up to three layers.

Up to 256 groups can be created in total for all layers.



◆ PROCEDURE

1. Click the project of the project tree.

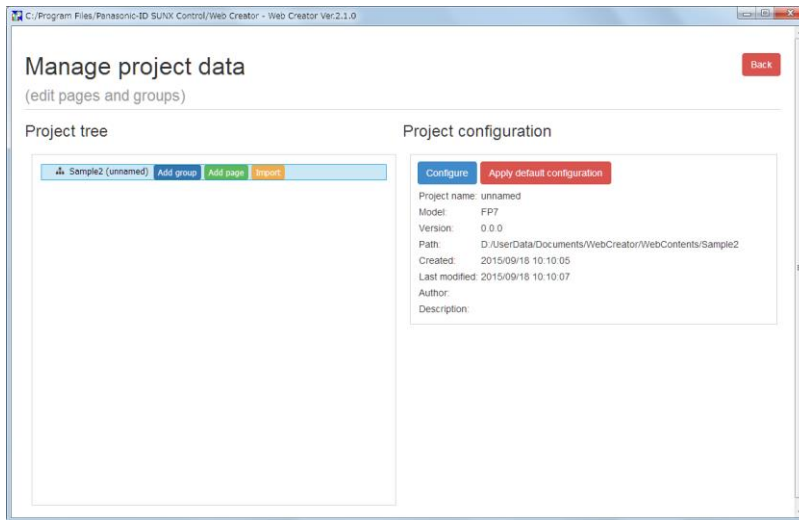

2. Click the "Add group" button.

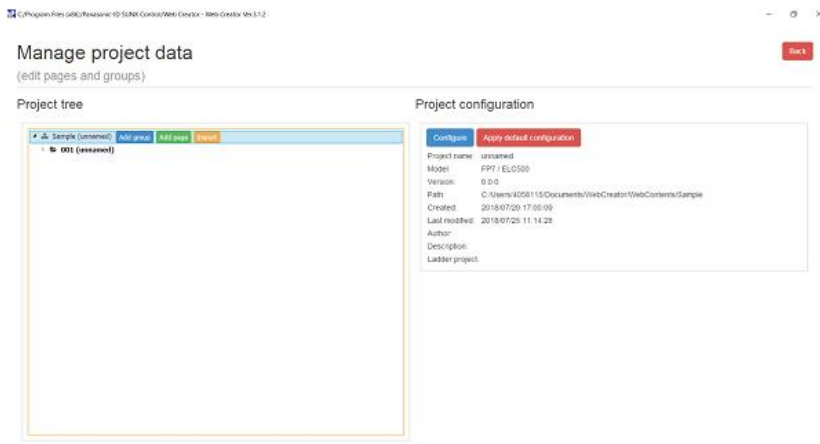

3. Select a created group, and click the "Configure" button to configure the setting of the group.

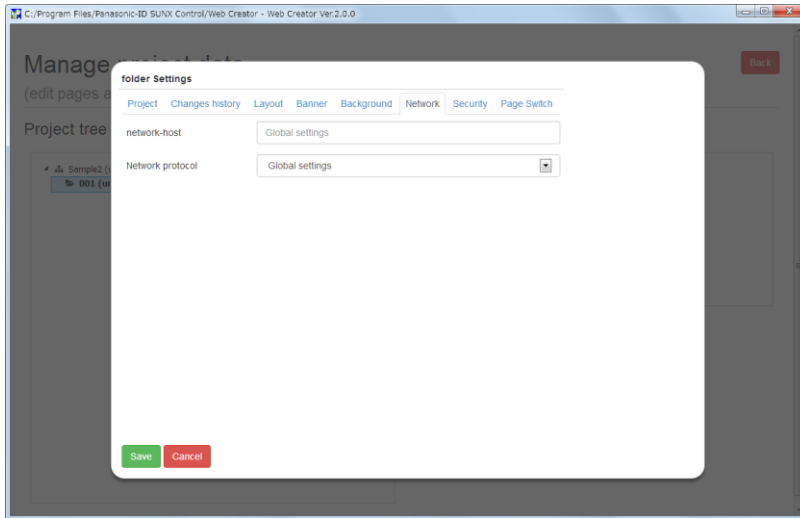

The "Layout", "Background", "Network" and "Security" settings of the group setting are the common settings to the screens under this group.

3.4.4 Creating Screens

Create a blank screen in the place right below the project or in a selected group.

Up to 256 screens can be created for each project.



◆ PROCEDURE

1. Click on a project or group of the project tree you want to create a screen.

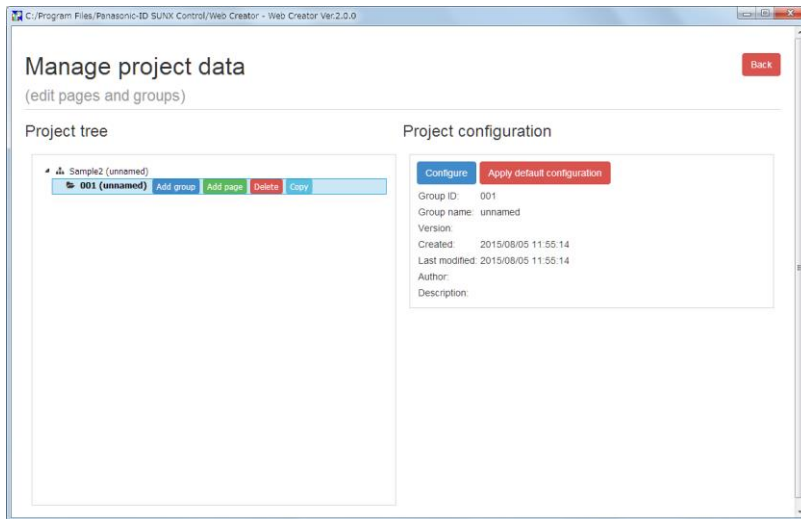

2. Click the "Add page" button.

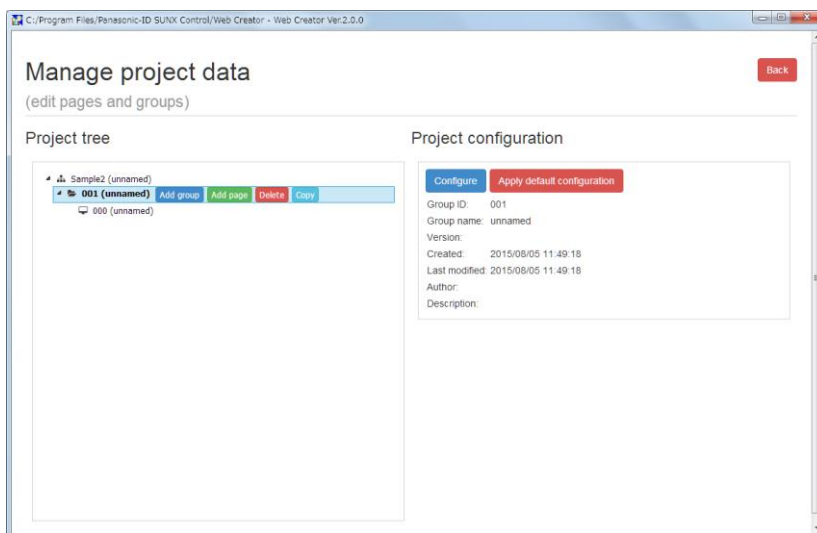

3. Select a created screen, and click the "Configure" button to configure the setting of the screen.

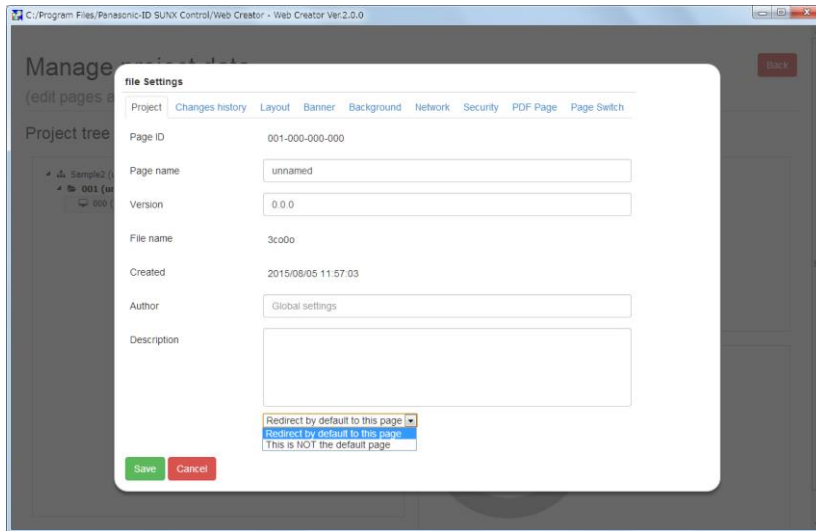

4. Select the created screen, and click the "Open page" button to proceed to the screen editing.

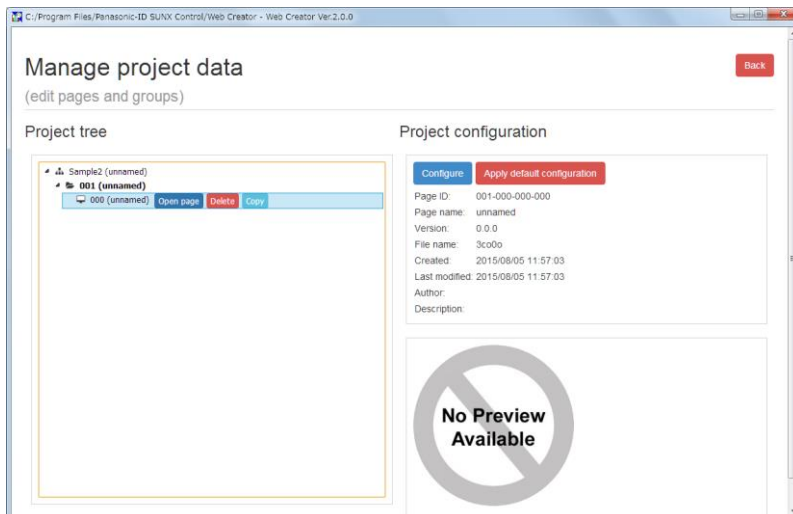

Selecting "Redirect by default to this page" in "Project" in the above "Configure" displays a  mark in the step 3.

The "Layout", "Background", "Network" and "Security" settings of the screen setting can be individually configured for each screen separately from the common settings of project and groups.

Note)

When the initial screen has not been set, nothing will be displayed on the screen even when accessing the URL of the web server.

The initial screen must be set.

3.4.5 Importing Other Project Screens

Screens created for other projects can be copied to a project currently created.



◆ PROCEDURE

1. Select a project on the project tree, and click the "Import" button.

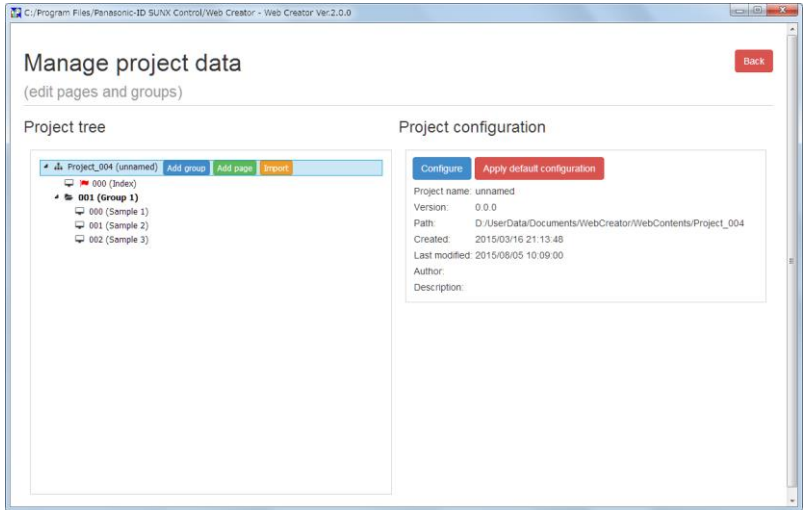

2. Select the project of the screen you want to import, and click the "Import" button.

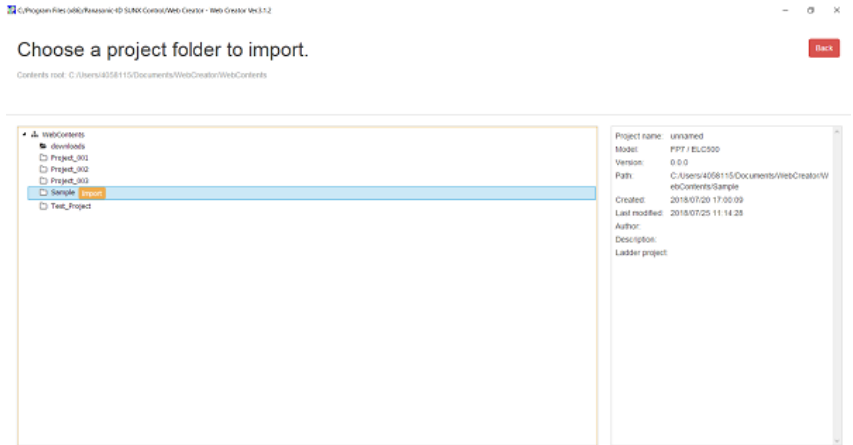

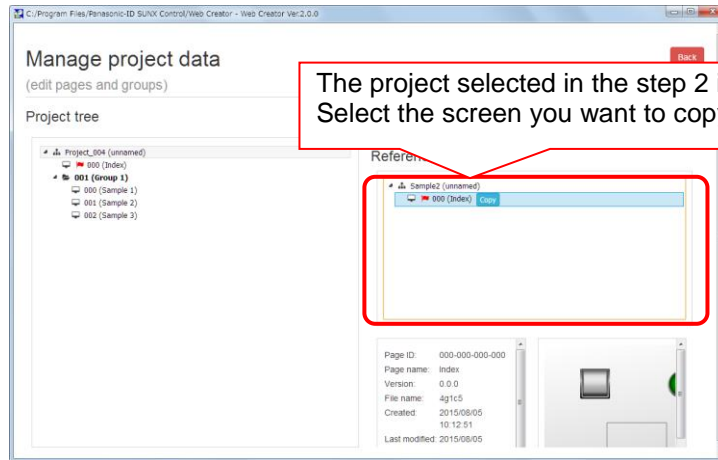
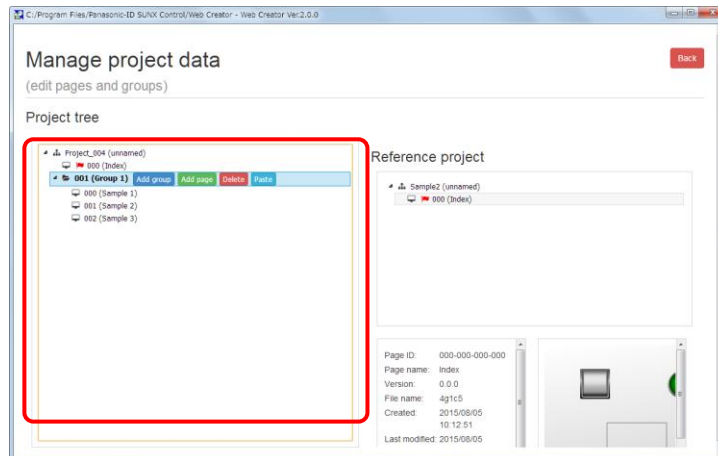
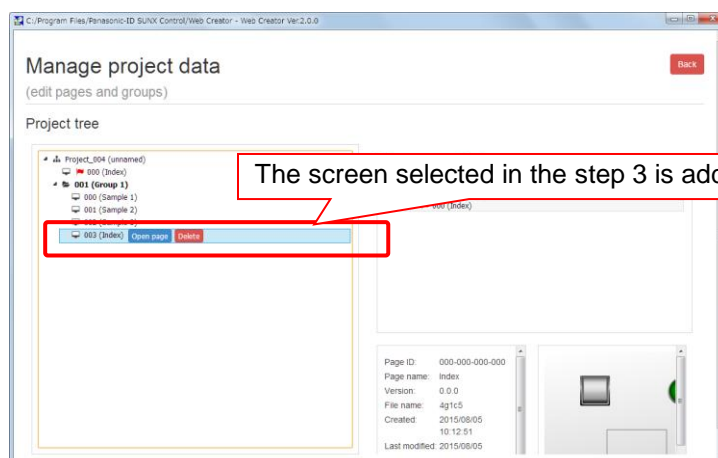
3. Select a screen or group to be imported, and click the "Copy" button.**4. Select a destination project or group.****5. Press the "Paste" button to complete the import.**

3.4.6 Upload

Transfer saved project data to the Web Server.



◆ PROCEDURE

1. Click "Upload" of the project menu.

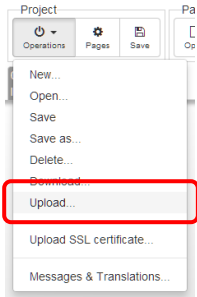

2. Confirm the IP address, user ID and password of the destination Web Server*, and click "Upload".

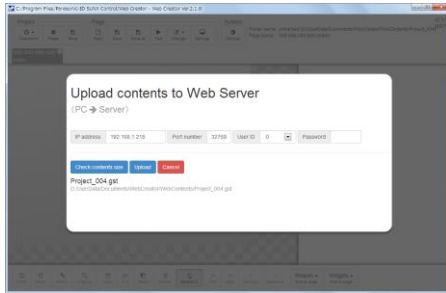

For the IP address of the upload destination, the IP address specified for the host for test, upload or download is shared.

The user ID and password varies by the security setting of FP7 / ELC500.

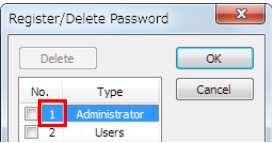
Security setting	User ID and Password
None	Connect as a master user. User ID: 0, Password: Not required
FPWIN GR7S security settings (FP7 only)	User ID: Number for administrator used when the password has been registered. (Figure below) Password: Administrator password used when the password has been registered. 
FPWIN Pro7 security settings	User ID: 1, Password: Password registered in Security Settings. (How to confirm) "Online" > "Security Settings"

* When the web server's model for the project of the created contents and the web server's model actually connected are different, the contents cannot be uploaded.

* When uploading contents to the Eco-POWER METER, use the following settings; Port number: 32769, User ID: 1, Password: SystemWeb.

■ When uploading data exceeding the content capacity

The following message is displayed when data exceeding the content capacity of the FP7 / ELC500 is uploaded.

In this case, change the data size to be within the content capacity of the FP7 / ELC500, and upload it again.

- For FP7 CPU unit Ver.4.10 or later (Ver.3.40 to 3.99) or EL500 control unit

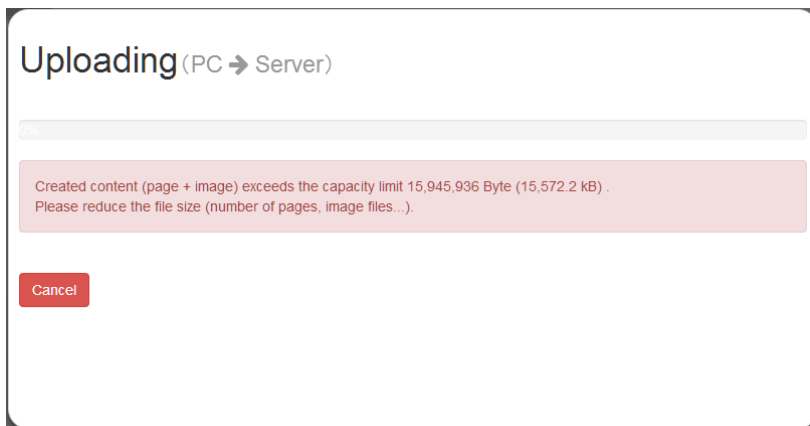

- When the version of the FP7 CP Unit is not the above versions or when Eco-POWER METER is used;

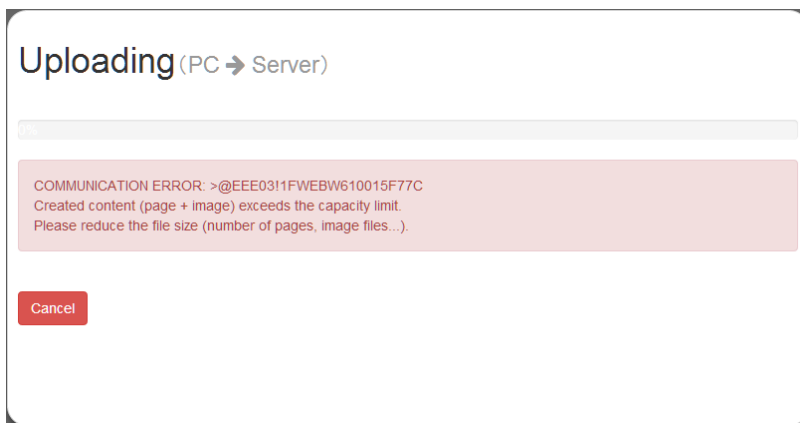

3.4.7 Download

Transfer project data to a PC from the Web Server.



◆ PROCEDURE

1. Click "Download" of the project menu.

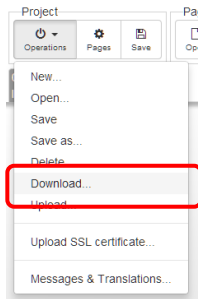

2. Confirm the IP address, user ID and password of the source Web Server*, and click "Download".

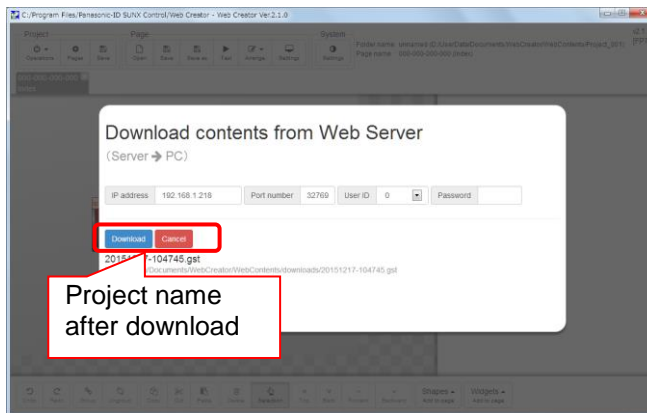

For the IP address of the download destination, the IP address specified for the host for test, upload or download is shared.

Downloaded project data is automatically saved in the "WebContents/downloads" folder or "WebContents_ECO/downloads" folder separately from the project currently edited.

The project name after saving is automatically created from the date and time information at the time of downloading the data.

After the completion of the download operation, the automatically downloaded project opens.

The user ID and password varies by the security setting of FP7 / ELC500.

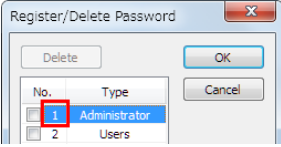
Security setting	User ID and Password
None	Connect as a master user. User ID: 0, Password: Not required
FPWIN GR7S security settings (FP7 only)	User ID: Number for administrator used when the password has been registered. (Figure below) Password: Administrator password used when the password has been registered.  (How to confirm) "Tools" > "PLC Security Settings" > "Register/Delete Password"
FPWIN Pro7 security settings	User ID: 1, Password: Password registered in Security Settings. (How to confirm) "Online" > "Security Settings"

* When the web server's model for a project currently being edited and the destination web server's model are different, the project cannot be downloaded.

Example) When creating a FP7 / ELC500 project, projects cannot be downloaded from other models than FP7 / ELC500.

* When downloading contents from the Eco-POWER METER, use the following settings; Port number: 32769, User ID: 1, Password: SystemWeb.

3.4.8 Importing Projects

Project data that has been already exported can be loaded by the project menu of Web Creator "Operations" – "Import...".

For performing this operation, store the project file to be imported in the "WebCreator\Imports" folder in advance.

When storing a project file, use the project data that is output by the export operation.



◆ PROCEDURE

1. **Store an exported project in the "WebCreator\Imports" folder in advance.**
For details of import folders, refer to "2.2 Folder Structure of Web Creator".
2. **Click "Import" of the project menu.**

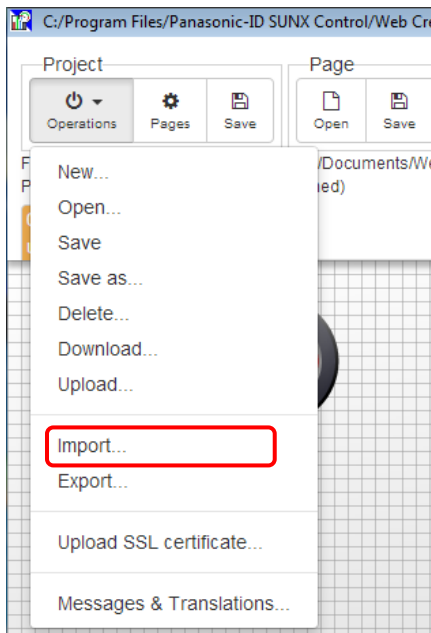

3. Select a project to be imported, and click the "Import" button.

C:/Program Files/Panasonic-ID SUNX Control/Web Creator - Web Creator Ver.2.1.0

Please select the folder to import

Contents root: C:/Users/Win7/Documents/WebCreator/Imports

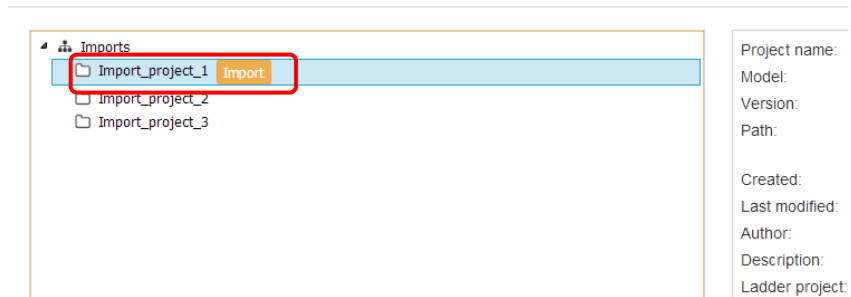

4. The import operation will be complete.

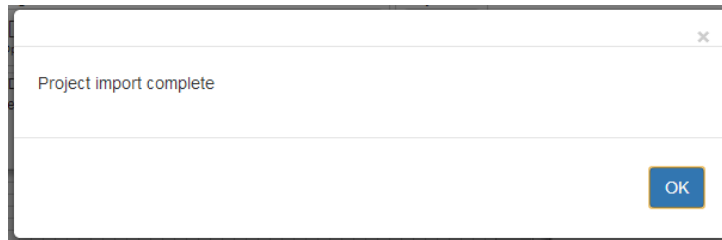

Various imported files are automatically stored in the following folder.

Imported data	Storage location
Project	For FP7 / ELC500 : WebCreator\WebContents
	Eco-POWER METER: WebCreator\WebContents_ECO
Various files such as images	Various folders under WebCreator\WebCommons
Ladder file	WebCreator\Ladder

If a project with the same name exists in the import destination, a message asking whether you want to overwrite the project is displayed.

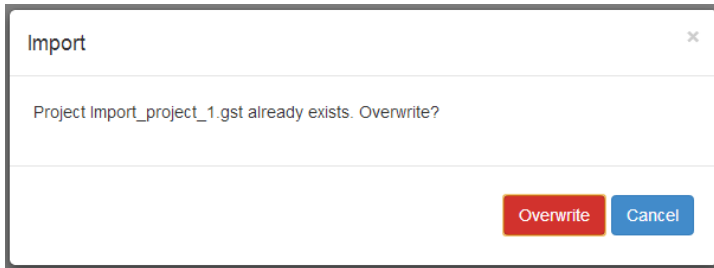

If a file with the same name exists in the import destination, the file with the same name in the import destination is backed up and then importing is executed.

When a file name with the same name is backed up, the following message is displayed.

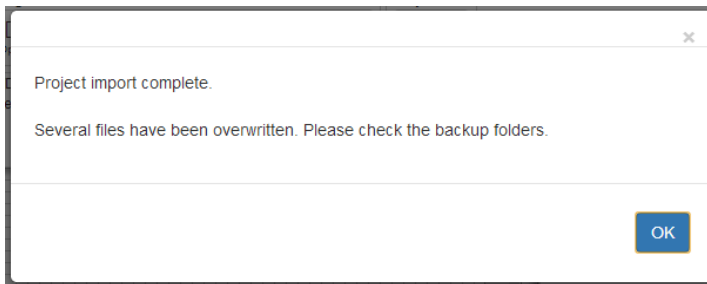

The storage locations of backup files are as follows.
For details of the folder structure, refer to the next page.

- Various files such as images
They are stored in the following folders under WebCreator\WebCommons.

Data type	Storage location of backup files
Audio file	audio_bk
Switch operation sound	beeps_bk
PDF file	pdf_bk
Image of a web part	img_bk
Background image	img\backgrounds_bk
Text font file	img\fonts_bk
Texture file	img\textures_bk
Moving image file	img\video_bk

- Ladder files

Data type	Storage location of backup files
Ladder file	WebCreator\Ladder_bk

The storage period of backup files is until the next import operation. Once a new import operation is performed, all the previous backup folders will be deleted.

Perform the operation considering the necessity of backed-up files.

As shown below, the folders in which backup files are stored are created in the same location as the original folders

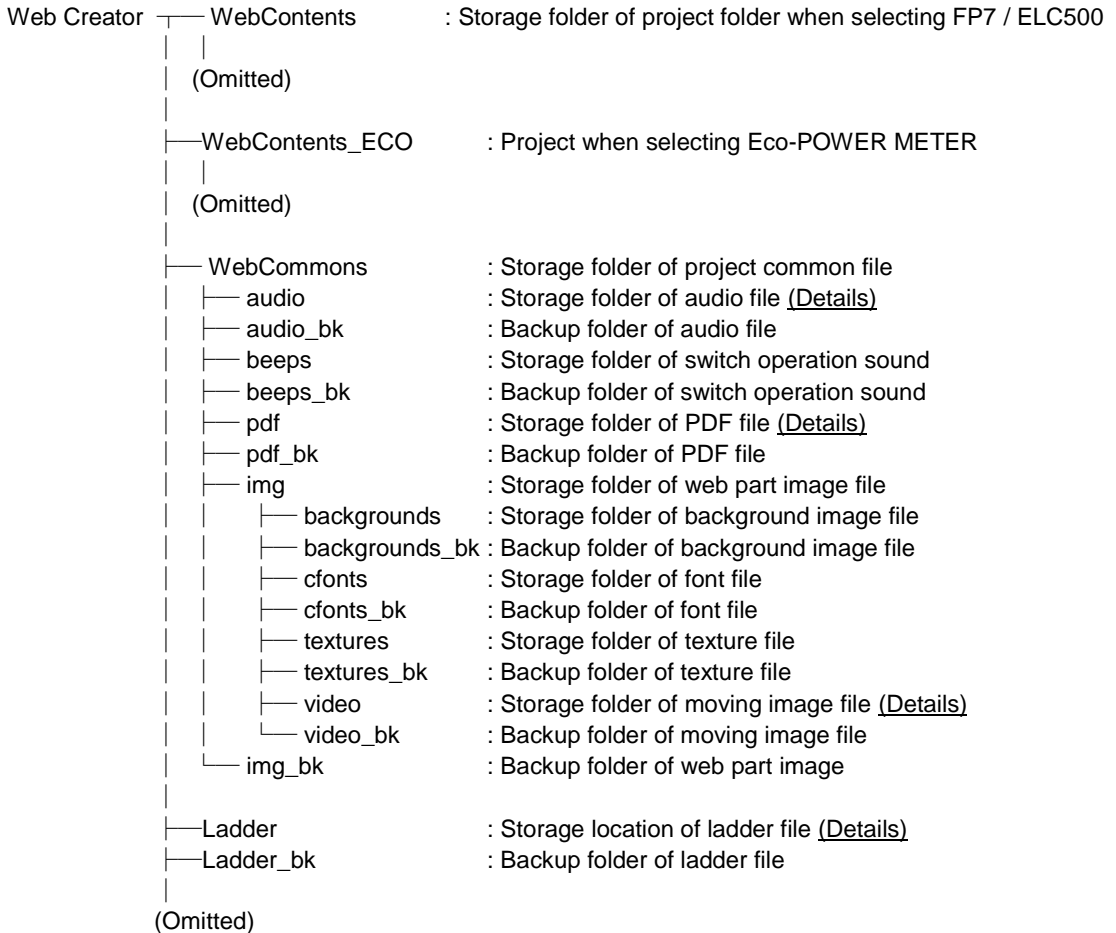

3.4.9 Exporting Projects

Project data currently being edited can be output to a specified folder by using the project menu of Web Creator "Operations" – "Export...". When outputting a project, various data such as image files used in the project stored in the WebCommons folder are output simultaneously.



◆ PROCEDURE

1. Open a project to be exported.
2. Click "Export" of the project menu.

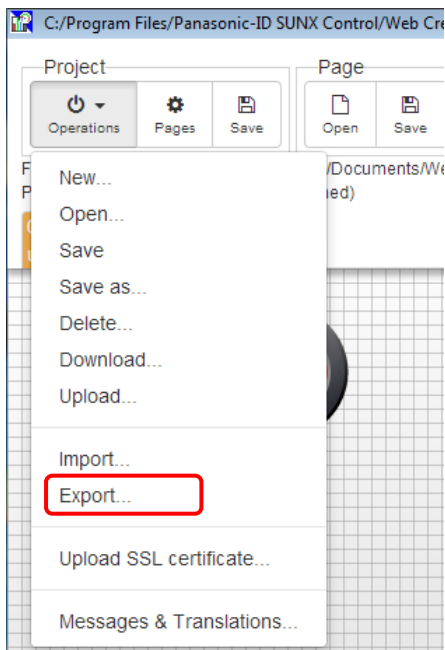

3. The message will be displayed and the export operation will be complete.

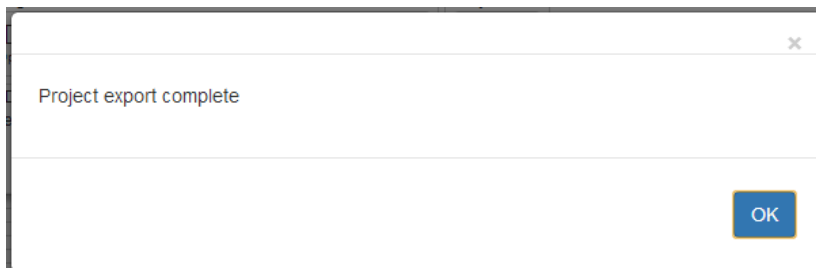

The exported project is stored in the "WebCreator\Exports" folder.
For details of export folders, refer to "2.2 Folder Structure of Web Creator".

For performing the import operation, store the folder that is output in this operation in the "WebCreator\Imports" folder.
For details, refer to "3.4.8 Importing Projects".

The export operation can be performed for multiple projects.
Exported projects are stored in separate folders by project name.
When a project with the same name already exists in the export destination, a serial number will be added to the end.



When projects with the same name are exported, serial numbers will be added to the end of each project name.

3.4.10 Multilingual Message Setting

Messages displayed on message parts, labels of other parts, or displayed characters are defined.

Ver.3.1.0 supports the following languages.

Abbr.	Language
da	Danish
de	German
es	Spanish
en	English
id	Indonesian
it	Italian
fi	Finnish
fr	French
ja	Japanese
ko	Korean
nl	Dutch
no	Norwegian
ru	Russian
vi	Vietnamese
zh	Chinese

Abbr.	Language
el	Greek
hi	Hindi
ar	Arabic
pt	Portuguese
ms	Malay
bn	Bengali
ur	Urdu
fa	Farsi
tl	Tagalog
th	Thai
tk	Turkish

Up to ten languages can be registered.

The language of the PC used when creating a project is registered as the language initially registered for the message setting.



◆ PROCEDURE

1. Click "Operations" > "Messages & Translations..." in the project menu.

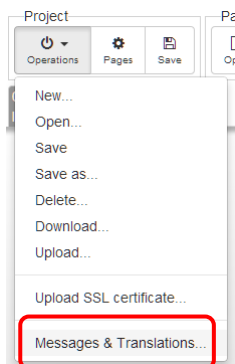

2. Click a message number, select a number that a message is registered, and enter a message to be registered in the frame at the lower part of the screen.

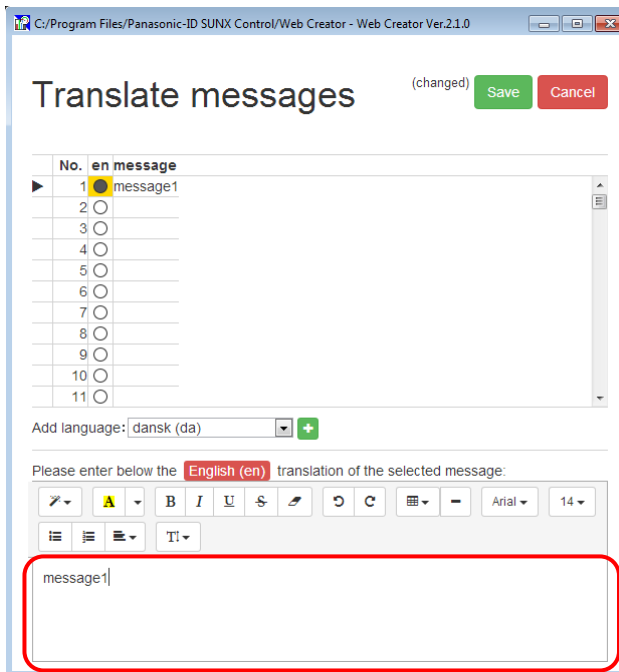

3. When registering Japanese following the above step, select "ja" from the "Add language" drop-down list in the middle of the screen, and click the right "+".

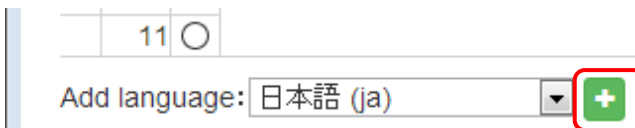

4. As well as the case of English, enter a message to be registered in Japanese within the frame at the lower part of the screen.

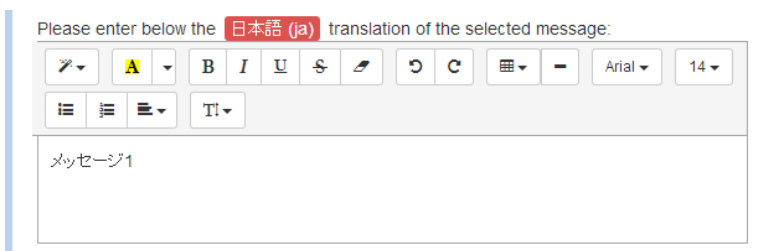

● is displayed in the column of the number/language that a message is registered.

○ is displayed in the column no message is registered.

5. For deleting an added language, click "X" of the language on the screen.

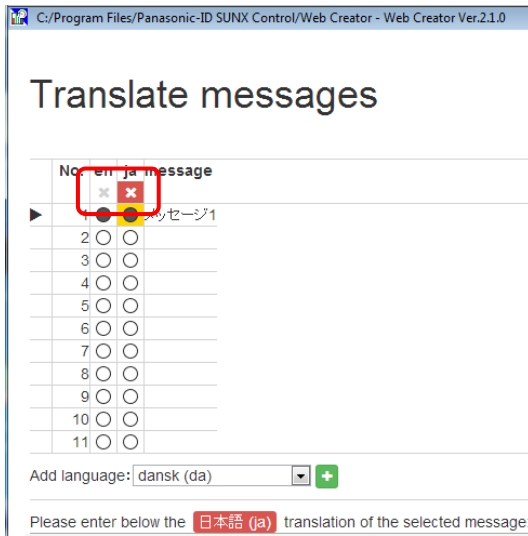

- * All the registered messages in the deleted language are cleared.

3.5 Screen Editing

3.5.1 Open

Open screen data created in a project.



◆ PROCEDURE

1. Click "Open" of the screen menu.

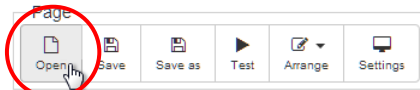

2. Select a screen to be edited on the project tree, and click the "Open page" button.

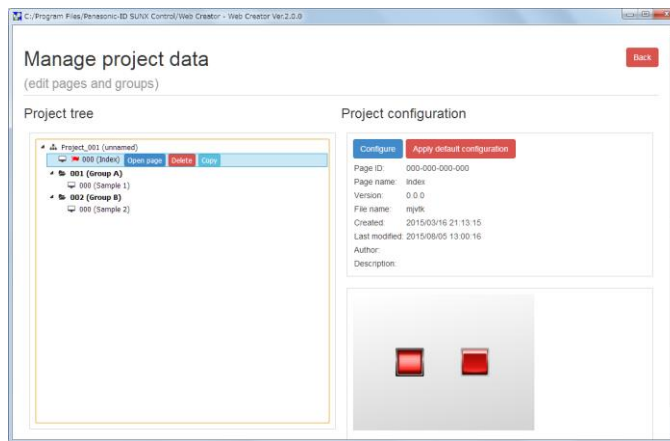

The  mark indicates the initial screen.

The preview of the screen is displayed in the lower right of the screen so that you can confirm the selected screen.

3. The edit screen for the selected screen opens.

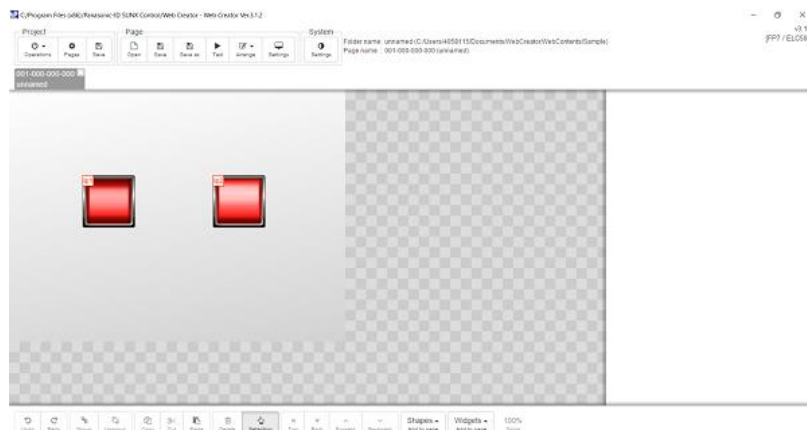

Subsequently, select another screen to be edited, and click the "Open page" button.

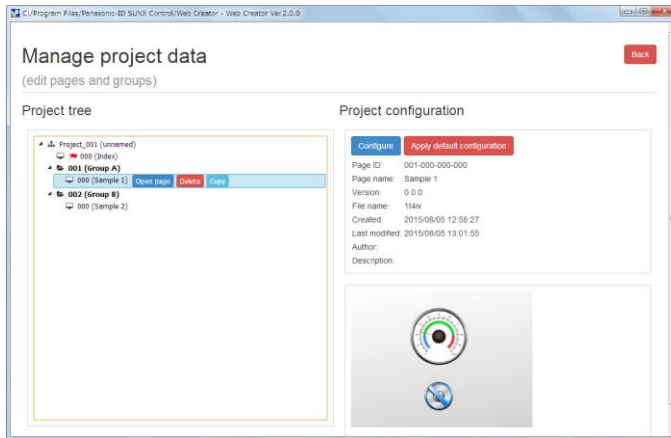

4. A tab is added by opening another screen data.

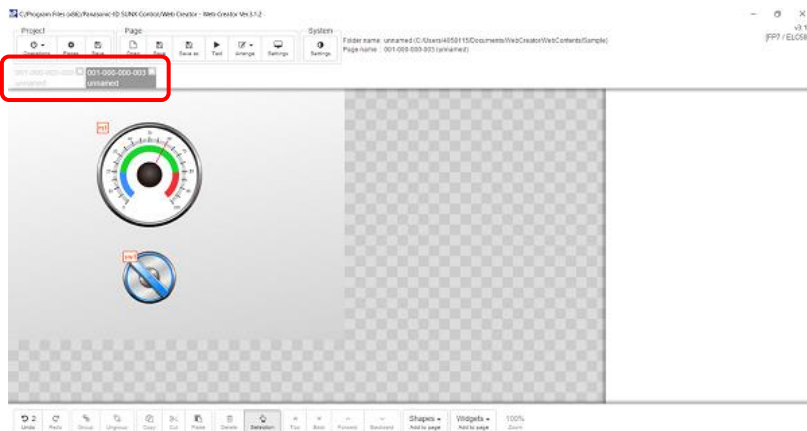

The screen can be switched by clicking the tabs.

5. Once the open screen data is edited (such as adding web parts), the tab color changes.

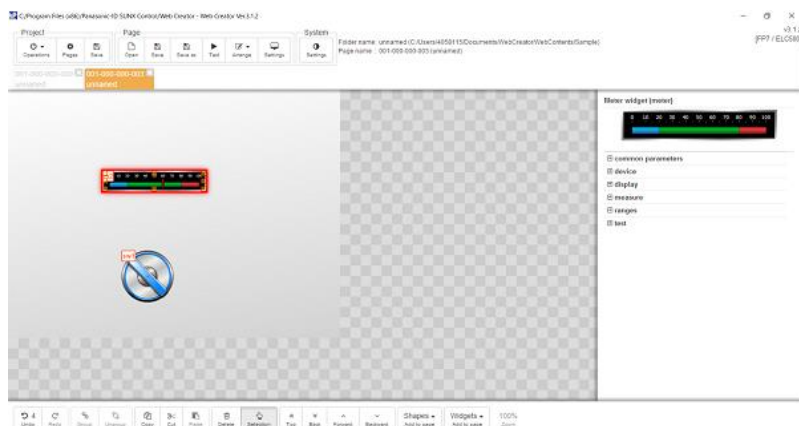

3.5.2 Screen Creation

Arrange parts on the screen, and set the properties of the arranged parts.

This section describes an example of procedures for arranging lamp and switch parts.



◆ PROCEDURE

1. Click "Widgets Add to page" from the toolbar at the bottom of the screen, and open the parts selection menu.

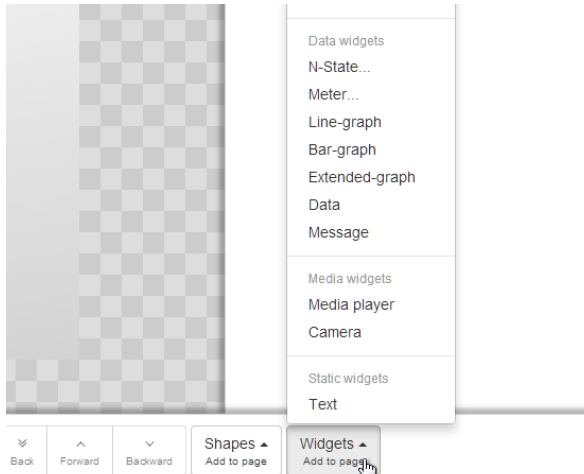

2. Clicking "Lamp" of the parts selection menu opens the list of lamp parts.

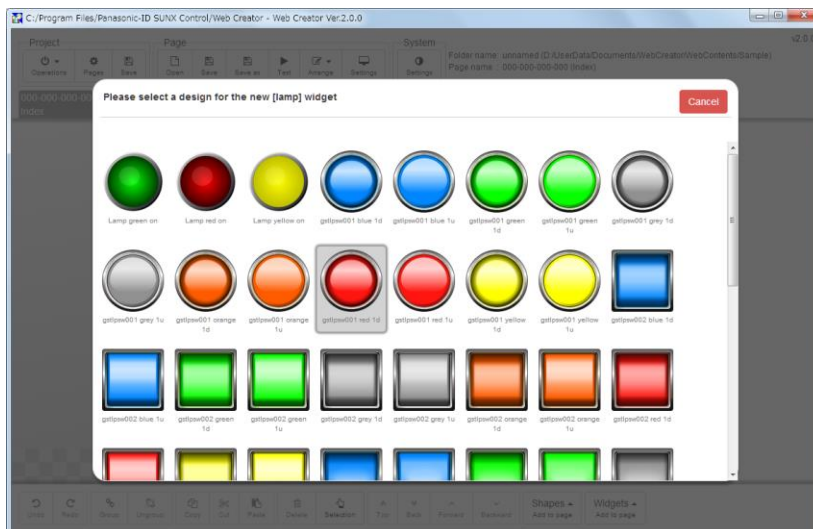

3. Clicking a lamp in the list of lamp parts returns to the edit screen. Click at an arbitrary position and arrange the part.

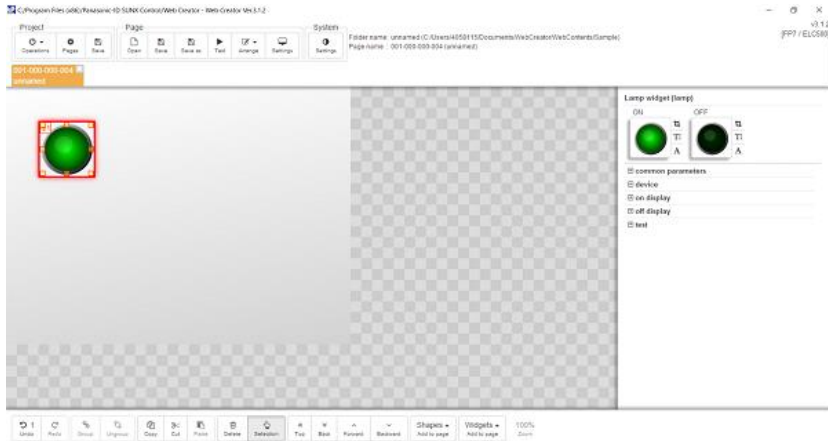

4. Once a part is arranged, the property is displayed in the right side part of the screen.

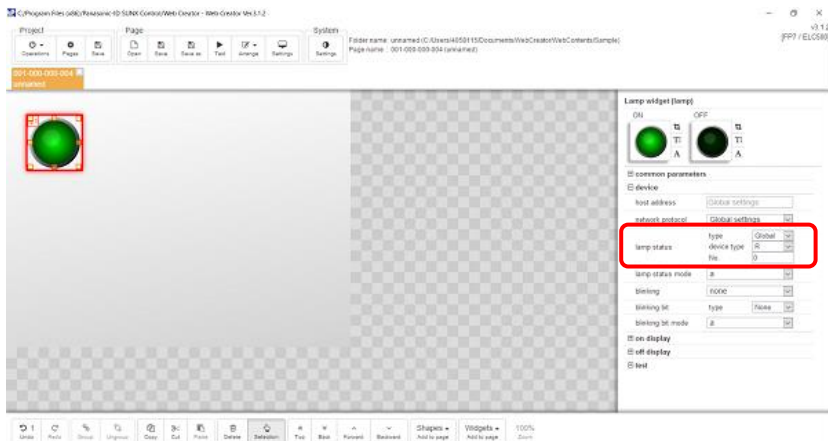

Specify the bit address of the FP7 / ELC500 for "lamp status" of "No."

5. Arrange a switch part by the same procedure, and set the property.

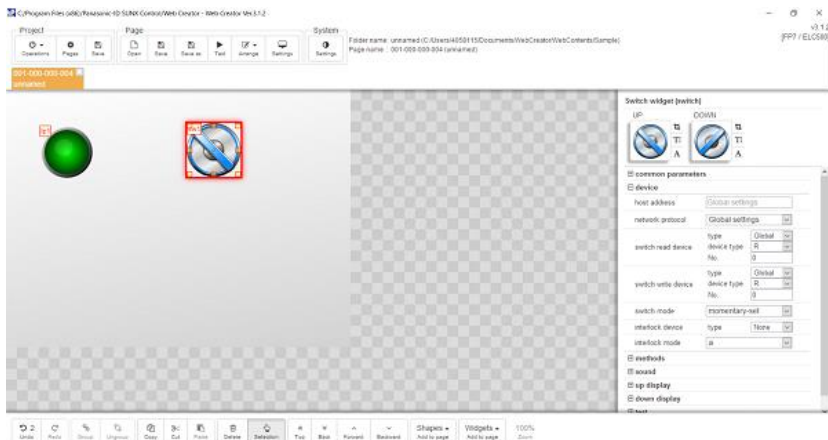

3.5.2.1 Enlarging or reducing a screen

The enlargement/reduction operation of the editing area can be performed by carrying out the following operation when creating a screen.

- (1) "Ctrl" key + "+" or "-"
- (2) "Shift" key + mouse wheel

The magnification factor can be adjusted in the range of 10% to 800%.

Magnification factor	Adjustment width
10% to 400%	10%
400% to 800%	25%

Normal (100%) display

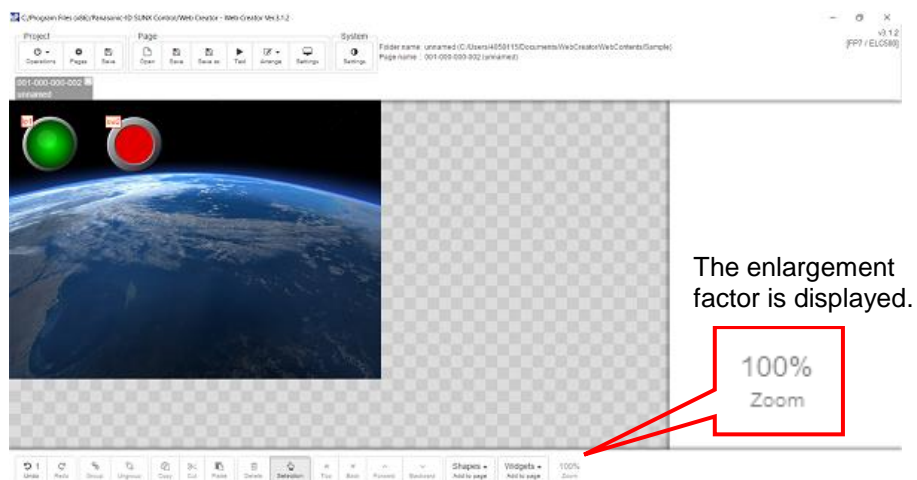

Maximum enlarged (800%) display

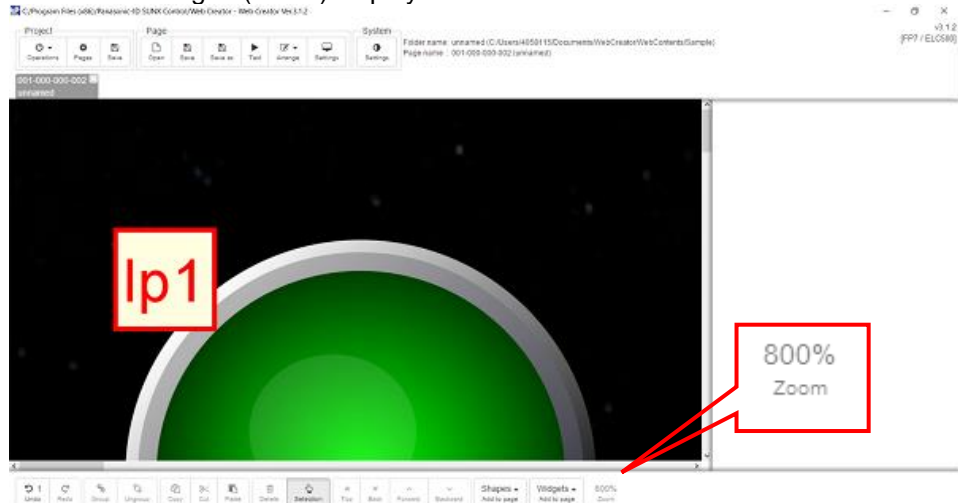

Maximum reduced (10%) display

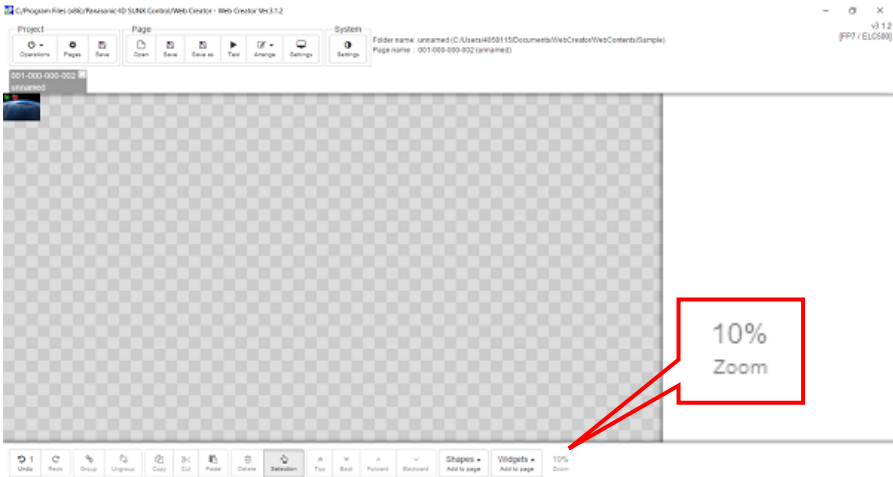

3.5.2.2 Copying parts or undoing

Copy and paste operations, and undo operation can be performed by the following operations using a keyboard or mouse.

Operation	Keyboard operation	Mouse (Right-click menu)
Copy	Ctrl + C	Select "Copy".
Paste	Ctrl + V	Select "Paste".
Undo	Ctrl + Z	Select "Undo".

As an example, the copy operation is described.

Copy a part by Ctrl + C or "Copy" from the right-click menu.

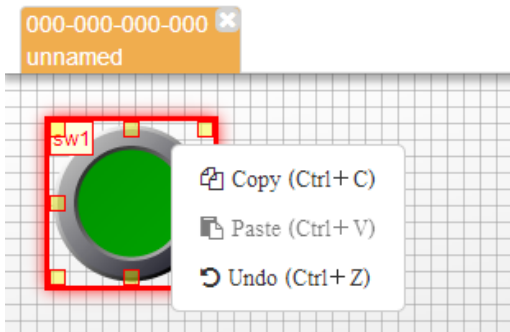

The copied part can be pasted by Ctrl + V or "Paste" from the right-click menu.

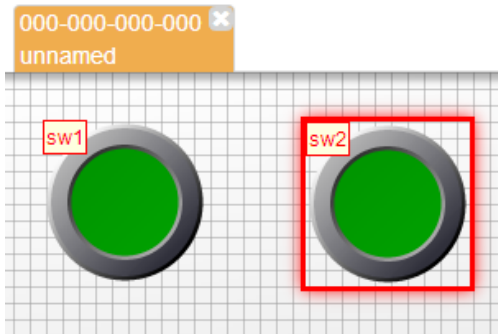

3.5.3 Presetting for Test

It is necessary to set the IP address of a connected Web Server before conducting a screen test.



◆ PROCEDURE

1. Click "Setting" of the system menu.

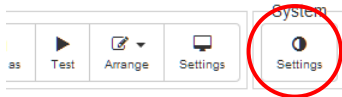

2. Set the IP address of a Web Server to be connected when conducting the test.

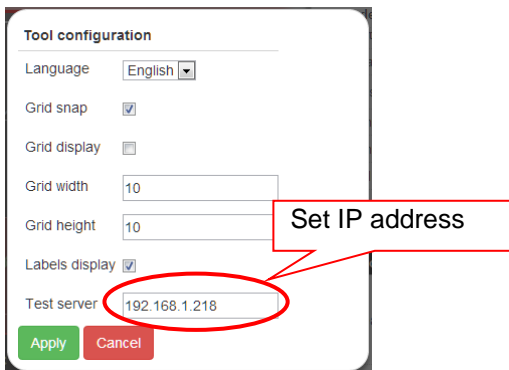

* The set IP address is used as the IP address of upload and download in common.

*When an IP address has been already set in the screen setting or group setting, its IP address is used for connection not the IP address of the host for testing.

3.5.4 Screen Test

The operation of a created screen can be confirmed while communicating with the FP7 / ELC500 before uploading the created screen to the FP7 / ELC500.



◆ PROCEDURE

1. Click "Test" of the screen menu.

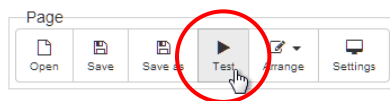

2. The test screen opens in a separate window of the browser.

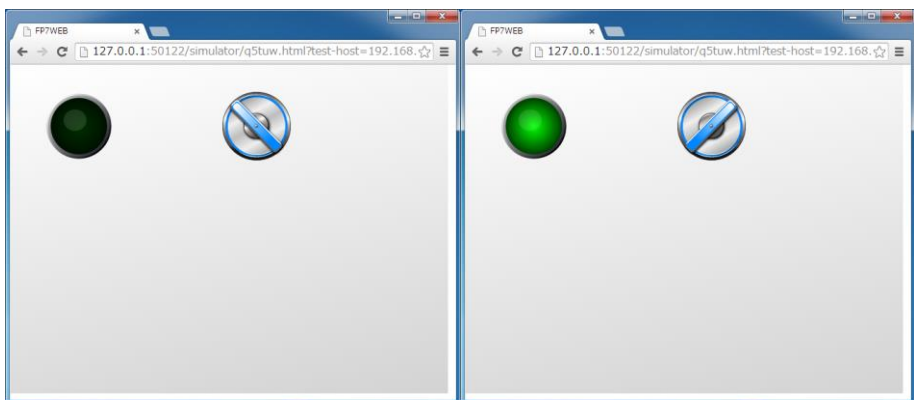

The on/off state of the specified bit is switched by clicking the switch part.

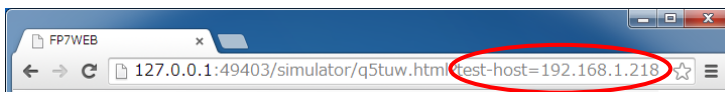

The connection destination information specified in "3.5.3 Presetting for Test" can be confirmed from the browser URL.

3.5.5 File Storage

Save a created screen.



◆ PROCEDURE

1. For overwrite save, click "Save" of the screen menu.

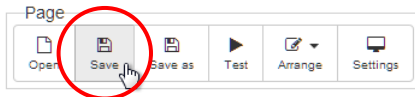

2. For saving with a new name, click "Save as" of the screen menu.

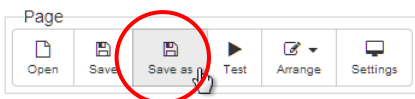

3. The screen for saving screen data opens.

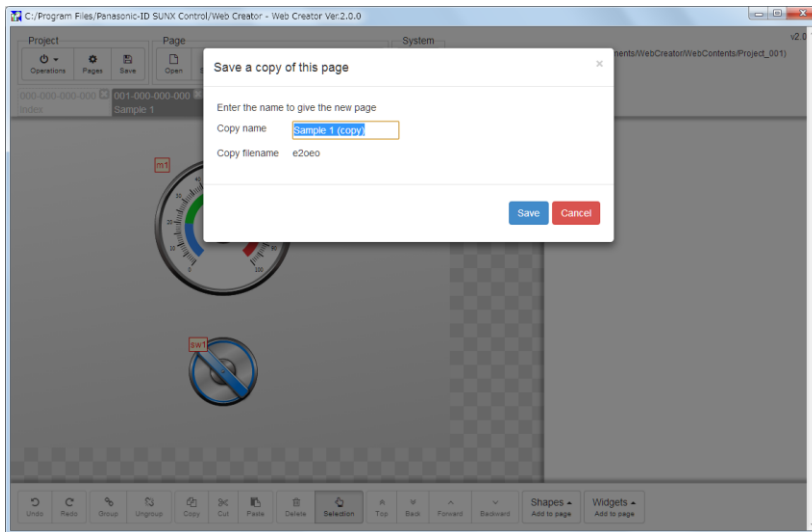

Specify a file name, and click "Save".

3.5.6 Screen Setting

Configure the screen setting.



◆ PROCEDURE

1. Click "Setting" of the screen menu.

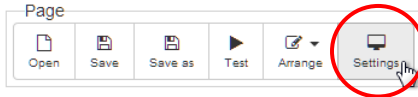

2. The screen setting window opens.

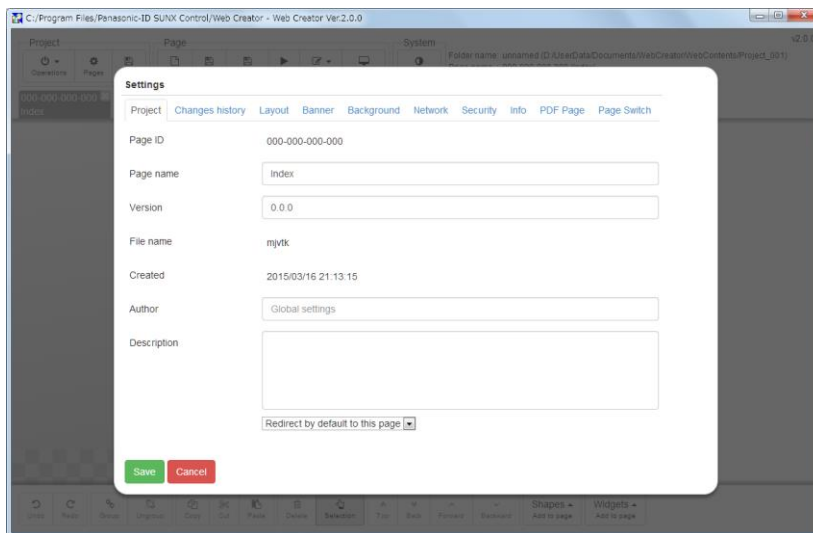

Configure the settings for screen name, size, screen background, communication setting, etc. Once the settings are reflected by clicking "Save", the screen returns to the edit screen.

3.5.7 Functions of Web Parts

This section describes the functions for each web part.

Usable web parts depend on the web server models selected in each project.
For details, refer to "3.3.1 Differences by Web Server Models".

3.5.7.1 Common Functions to Web Parts

This section describes the functions common to each web part.

3.5.7.1.1 Multilingualization of Parts Display

Web pages can be multilingualized by registering messages of each language in advance and specifying message numbers for parts.

This section describes the procedure of setting message numbers to parts.
For details of the method of registering messages, refer to "3.4.10 Multilingual Message Setting".



◆ PROCEDURE

3. Set "#xxx" (xxx: message number you want to display) in the position where you want to display a message for each part.

The screenshot shows the Web Creator interface. On the right, a 'Message definition' table lists message numbers and content in Japanese and English. Below it, a widget configuration panel shows the 'title' field set to '#1'.

番号	ja	en	メッセージ内容
1	●	●	ランプ緑
2	●	●	ランプ黄
3	●	●	ランプ赤
4	●	●	スイッチ青
5	●	●	テキストメッセージサンプル
6	●	●	グラフタイトル
7	●	●	グラフ凡例1
8	●	●	グラフ凡例2
9	●	●	グラフ凡例3

番号	ja	en	メッセージ内容
1	●	●	Lamp-G
2	●	●	Lamp-Y
3	●	●	Lamp-R
4	●	●	Switch-B
5	●	●	Text Message Sample
6	●	●	Graph-Title
7	●	●	Graph-Legend1
8	●	●	Graph-Legend2
9	●	●	Graph-Legend3

Widget configuration panel (on display):

- design: gslpsw001_green_1c
- title: #1
- font: MS Gothic
- font size: 32px
- placement: center
- text color: #1b1b1b
- text decoration: italic, bold, underline, overline, line-through

1. (Setting example)

Lamp, switch parts: Set in title.

Text parts: Set in text.

Extended graph: Set in title and label of data source.

* Messages can also be set for other parts than the above parts (such as dialog parts).

2. When the screen is displayed in a browser, a bar for switching the displayed language is shown in the upper right corner of the screen.



Once the language is switched, the setting state is kept when the screen is switched to another screen.

The selected language information is reset when the browser is closed.

3.5.7.1.2 Method of Specifying Character Size Larger Than 100 px

For specifying the font size larger than 100 px, set as below.

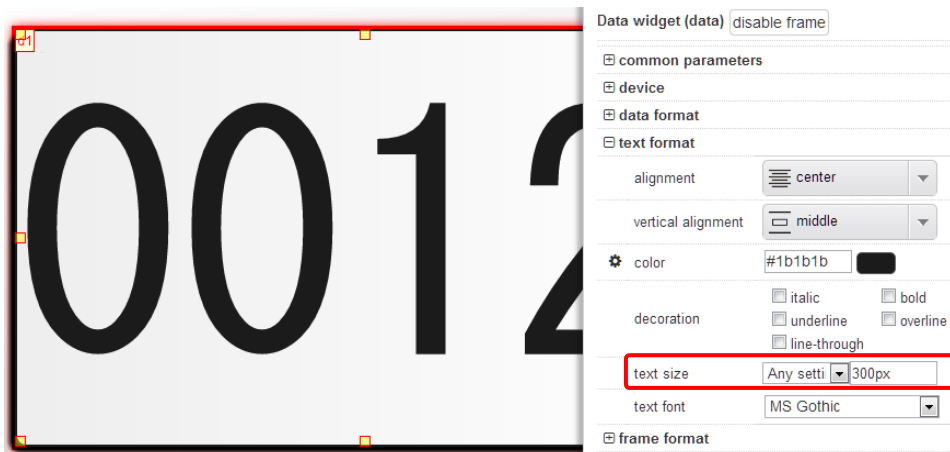

Item	Setting
Character Size	Select a character size from the list. For specifying a size larger than 100 px, select "Any setting" from the list.
Character size (Input)	When selecting "Any setting", a desired character size can be input. The maximum character size is 4000 px.

3.5.7.1.3 New Operations When Operating Parts

For the parts that click operation is available such as switch parts, events at the time of click operation can be registered.

The operations when operating parts can be registered for the following four parts.

Part name	Switch	Lamp switch	Dialog	Graphic
-----------	--------	-------------	--------	---------

Pressing the edit button of the setting "methods" opens the operation setting screen.

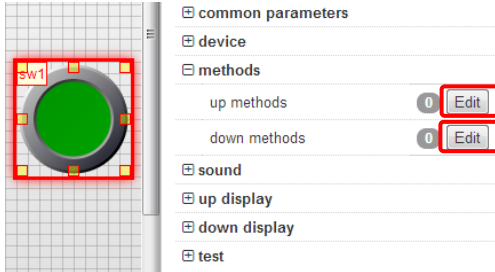

Register events at the time of click operation in the operation setting screen.

A maximum of ten events can be registered.

However, more than one events related to the switching pages cannot be registered.

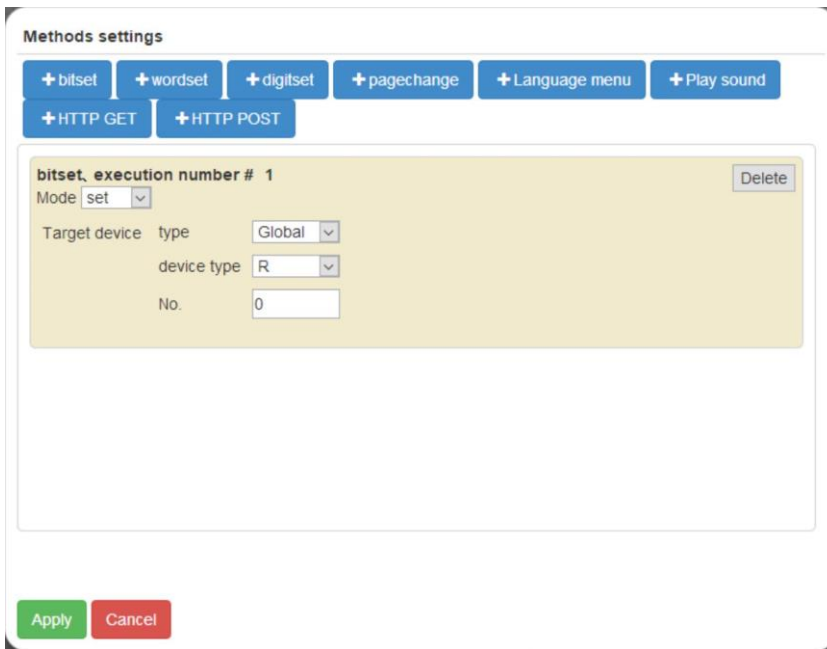

The registrable events are as follows.

Type	Setting	Operation
bitset	set	Turns on a bit device.
	reset	Turns off a bit device.
	invert	Reverses a bit device.
wordset	set	Set a specified value.
	add	Add a specified value.
	sub	Subtract a specified value.
	and	Sets the result of logical AND with a device acquisition value.
	or	Sets the result of logical OR with a device acquisition value.
	xor	Sets the result of exclusive OR with a device acquisition value.

Type	Setting	Operation
digitset	add	Adds 1 to a specified number of digits.
	sub	Subtracts 1 from a specified number of digits.
pagechange	previous page (-1)	Displays the previous page.
	next page (+1)	Displays the next page.
	move to a page	Displays a specified page number.
	move N pages backward	Displays the page N pages before the current page.
	move N pages forward	Displays the page N pages after the current page.
	move to a URL	Displays the page specified with URL

Type	Setting	Operation
Language menu	Show	Displays the language switching menu.
	Hide	Hides the language switching menu.
Play sound	Sound file	Reproduces the sound of a specified file. (Refer to the next page.)

More than one language switching operation or audio playback operation cannot be registered in the same operation.

About audio playback

The audio playback can be selected by the operation settings such as switches.

Audio files you want to reproduce should be stored in the "MyDocument\WebCreator\WebCommons\audio" folder in advance.

By setting audio files stored in the WebCommons folder in advance, audio files can be reproduced when operating switches.

If an audio file is reproduced under the reproduction of another audio file, the sound under reproduction will stop and the new audio file will be reproduced.

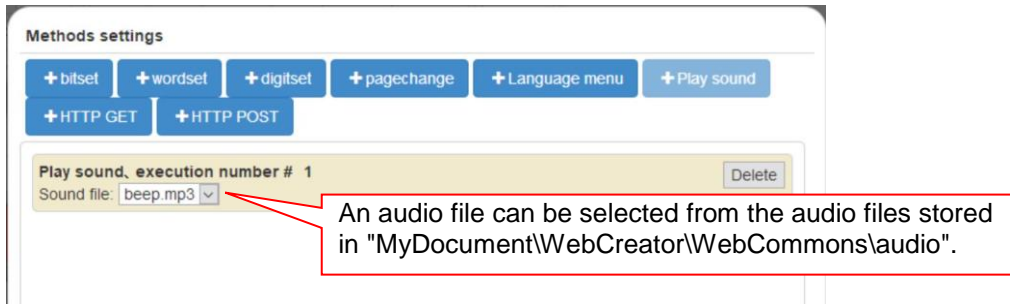

The formats of audio files that can be reproduced are as follows.

Available audio file formats: "AAC", "MP3", "OGG", "WAV"

File format	File extension
AAC	***.aac
MP3	***.mp3
OGG	***.ogg
WAVE	***.wav

For details of the storage locations of audio files, refer to "2.2 Folder Structure of Web Creator".

Type	Setting	Operation
HTTP GET	URL	The specified GET request is sent.
HTTP POST	URL	The specified POST request is sent.
	Paramete ***	The parameter to be sent by a POST request is specified.

Sending an HTTP request

An HTTP request can be selected by setting switch operation.

The method (GET or POST) and the connection method (http or https) can be specified.

GET request

+ HTTP GET

Setting screen

HTTP GET, execution number # 1 Delete

Enter below a complete HTTP URL.

You need to specify the following items:

- Protocol (http or https)
- Domain name or IP address
- Path and request parameters

Below is an example URL to make a camera turn to the left:

`http://192.168.0.10/cgi-bin/camctrl?pan=-1&tilt=0`

`http://192.168.1.6/cgi-bin/camctrl?pan=1&tilt=0`

POST request

+ HTTP POST**Setting screen****HTTP POST, execution number # 1**

Delete

Enter below a complete HTTP URL.

You need to specify the following items:

- Protocol (http or https)
- Domain name or IP address
- Path

Set the POST parameters in the box below.

- You can set one parameter per row.
- Each row should be in format 'name=value'.
- Example of parameter setting: a=23

3.5.7.2 Functions of Major Web Parts

This section describes the method of using the functions of each web part.

3.5.7.2.1 Slider Parts

The control by the slide operation is available.

■ Setting for slide operation method

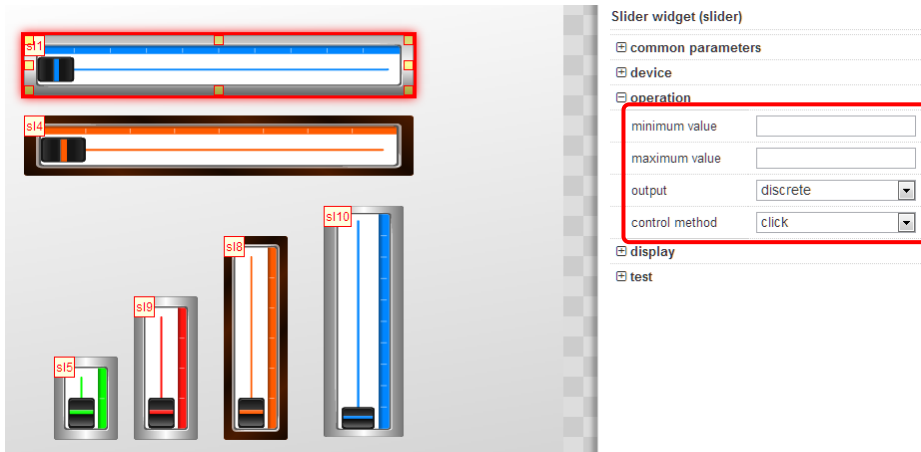

Setting	Description
minimum value	Output value when the slide is set to the minimum value.
maximum value	Output value when the slide is set to the maximum value.
output	discrete: The slide can be moved at certain graduated intervals. continuous: The slide can also be set between graduated intervals.
control method	click: The slide operation is performed only by a click operation. drag: The slide operation is performed by a click operation or drag operation.

■ Method of changing parts design

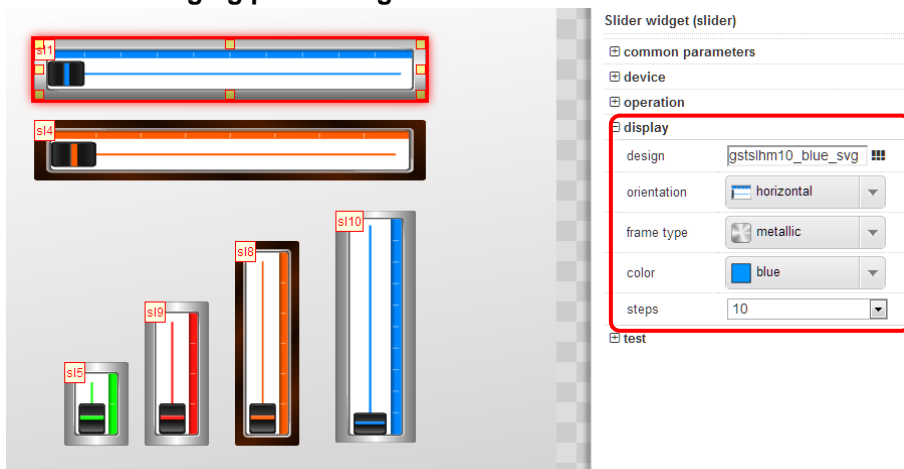

Setting	Description
design	Select a design of the part. * Arbitrary images cannot be specified.
orientation	Select "horizontal/vertical" for the slide direction.
frame type	Select "metallic/plastic" for the appearance of the frame.
color	Select a color of the part from the list.
steps	Specify the interval for the step operation. The number of scales of the slide part varies according to the number of steps.

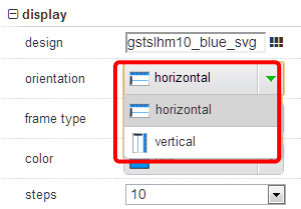

* Some setting items of each web part can be confirmed as images such as the direction and type of the frame.

3.5.7.2.2 Rotary Switch Parts

The control by rotary switches is available.

■ Setting for rotary switch operation method

Rotary widget (rotary)

- ☑ common parameters
- ☑ device
- ☑ operation
 - minimum value
 - maximum value
 - output discrete ▼
 - control method click ▼
- ☑ display
- ☑ test

Setting	Description
minimum value	Output value when the slide is set to the minimum value.
maximum value	Output value when the slide is set to the maximum value.
output	discrete: The slide can be moved at certain graduated intervals. continuous: The slide can also be set between graduated intervals.
control method	click: The operation is performed only by a click operation. drag: The operation is performed by a click operation or drag operation.

■ Method of changing parts design

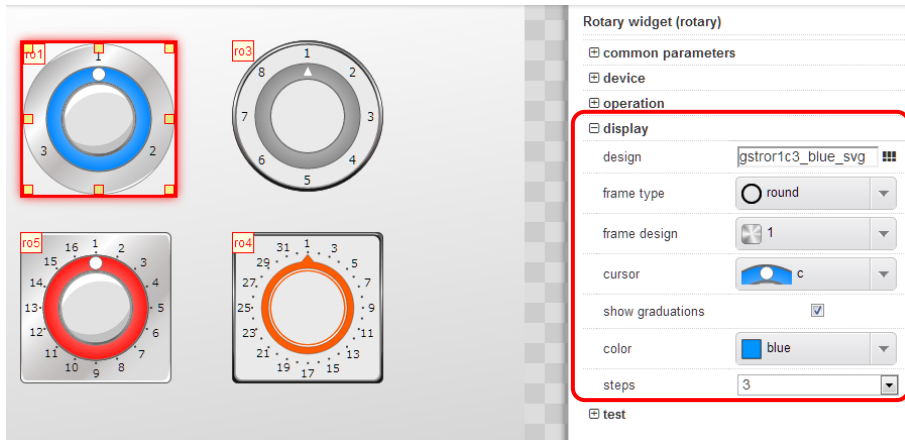

Setting	Description
design	Select a design of the part. * Arbitrary images cannot be specified.
orientation	Select " horizontal/vertical" for the slide direction.
frame type	Select " metallic/plastic " for the appearance of the frame.
color	Select a color of the part from the list.
steps	Specify the interval for the step operation. The number of scales of the slide part varies according to the number of steps.

* Some setting items of each web part can be confirmed as images after the setting such as the direction and type of the frame.

3.5.7.2.3 Dialog Parts

The dialog parts can be switched between displaying and hiding, and the controlled content can be set for each button of dialog parts individually.

■ Method of switching between displaying and hiding dialog part

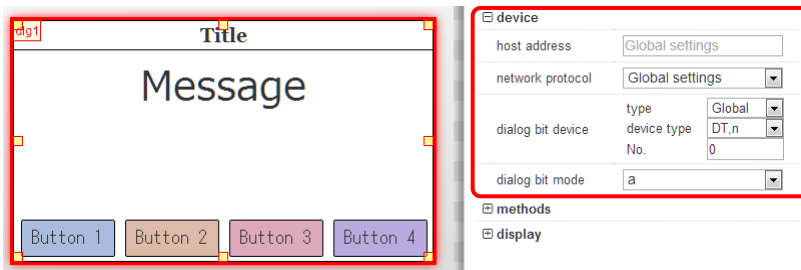

The dialog part is displayed when the set bit device turns ON (*1).

The part is not displayed when the bit device is OFF (*1).

*1: This operation is performed when "dialog bit mode" is "a".

When the mode is set to "b", the part is displayed when the bit device is OFF.

For changing the display contents of dialog parts, change the following settings.

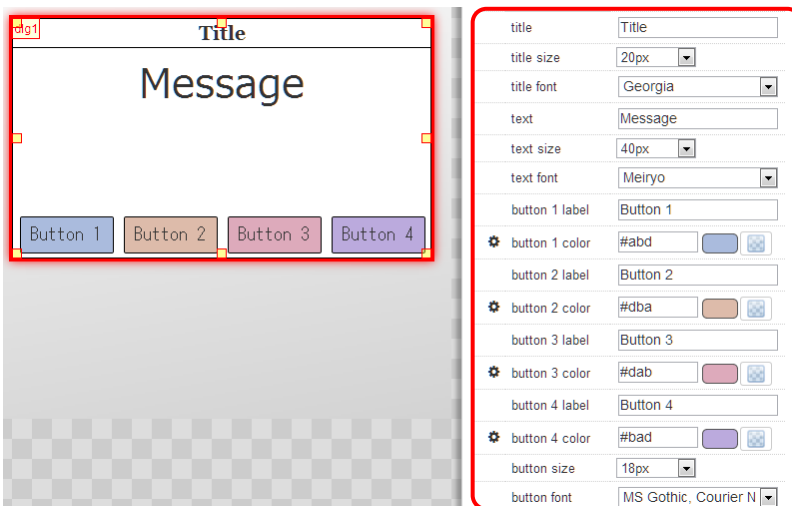

Setting	Description
title	Message displayed in the title bar of dialog part.
title size	Character size of "title".
title font	Character font of "title".
text	Body text of dialog part
text size	Character size of "text".
text font	Character font of "text".
button n label	Character string displayed in "button n". When this is not input (blank), the button n is not displayed.
button n color	Color of "button n".
button size	Character size of "button n".
button font	Character font of "button n".

■ **Button operation setting**

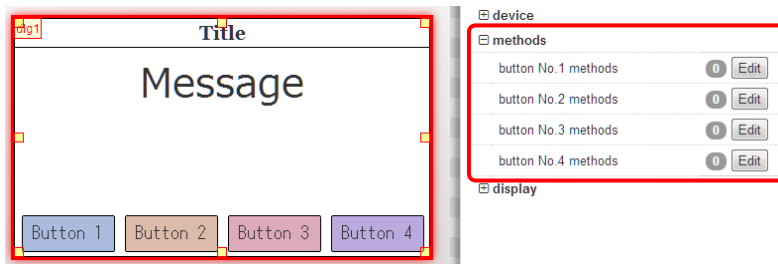

* The operation performed when each button is pressed can be set from each "Edit" of buttons 1 to 4.

3.5.7.2.4 Meter Parts

The range (low/middle/high) and color can be specified for some meter parts. Minimum and maximum hold values can also be set to be displayed.

* In the case of some meter parts, the following setting items may not be displayed.

Undisplayed meter parts do not support various functions.
For details, refer to "Meters that various functions are usable".

■ Range setting (low/middle/high)

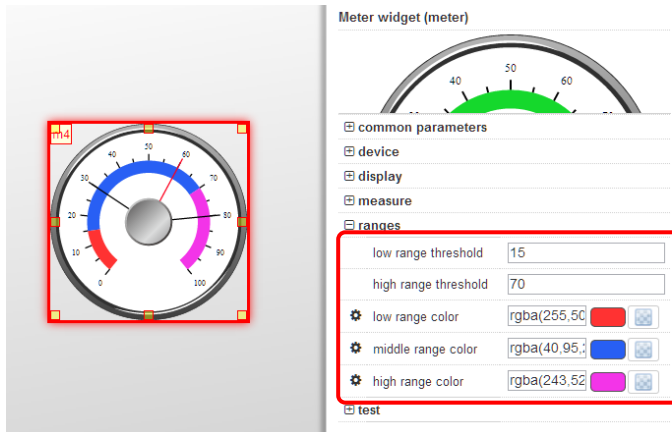

Setting	Description
low range threshold	Set the thresholds of low and middle ranges.
high range threshold	Set the thresholds of middle and high ranges.
low range color	Set the color of low range.
middle range color	Set the color of middle range.
high range color	Set the color of high range.



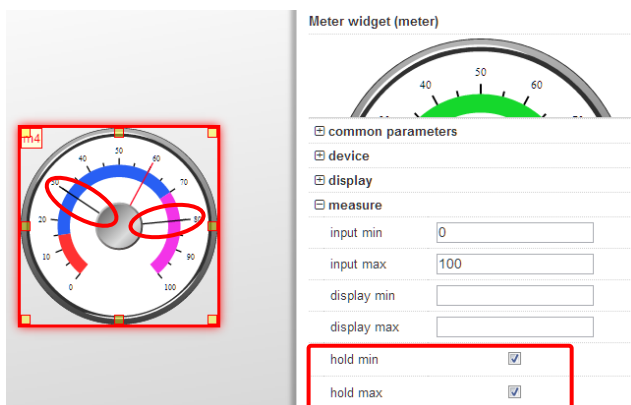



■ Display of hold values







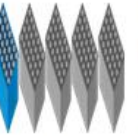



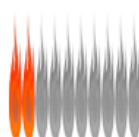

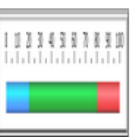

By setting the minimum hold value display and the maximum hold value display, the update of each hold value is displayed when the minimum or maximum value is updated.





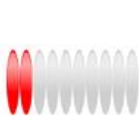

■ Meters that various functions are usable

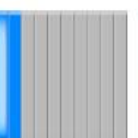
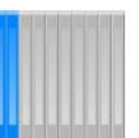





Usable functions for each meter are as follows.





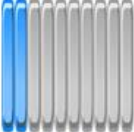

							
gstm001	gstm002	gstm003	gstm004	gstm005	gstm006	gstm007	
Part name	gstm001	gstm002	gstm003	gstm004	gstm005	gstm006	gstm007
Low/Middle/High	Available	—	Available	—	—	—	—
Hold value	Available	Available	Available	—	—	—	—

							
gstm008	gstm009	gstm010	gstm011	gstm012	gstm013	gstm014	
Part name	gstm008	gstm009	gstm010	gstm011	gstm012	gstm013	gstm014
Low/Middle/High	—	—	—	—	Available	Available	—
Hold value	—	—	—	Available	Available	Available	Available

							
gstm015	gstm016	gstm017	gstm018	gstm019	gstm020	gstm021	
Part name	gstm015	gstm016	gstm017	gstm018	gstm019	gstm020	gstm021
Low/Middle/High	—	—	—	Available	Available	—	—
Hold value	—	—	Available	Available	Available	—	—

							
gstm022	gstm023	gstm024	gstm025	gstm026	gstm027	gstm028	
Part name	gstm022	gstm023	gstm024	gstm025	gstm026	gstm027	gstm028
Low/Middle/High	—	Available	—	—	—	—	—
Hold value	—	Available	Available	—	—	—	—

							
Part name	gstrm029	gstrm030	gstrm031	gstrm032	gstrm001	gstrm002	gstrm003
Low/Middle/High	—	—	—	—	—	—	Available
Hold value	—	—	—	Available	—	—	Available

							
Part name	gstrm004	gstrm005	gstrm006	gstrm007	gstrm008	gstrm009	gstrm010
Low/Middle/High	Available	Available	—	—	—	Available	—
Hold value	Available	Available	Available	Available	Available	Available	Available

3.5.7.2.5 Extended Graph Parts (Improvement in Ver.3.1.0)

The following improvements have been made in Ver.3.1.0.

- "x axis time unit" can be set when specifying trend graphs. ([Details](#))
- The X-scale display when using batch graphs can be adjusted by the "X magnification" setting only. ([Details](#))

The following two graphs can be set; "sampling graph" which acquires data periodically and displays the graphs, and "array graph" which acquires data collectively at a specified time and displays the graphs.

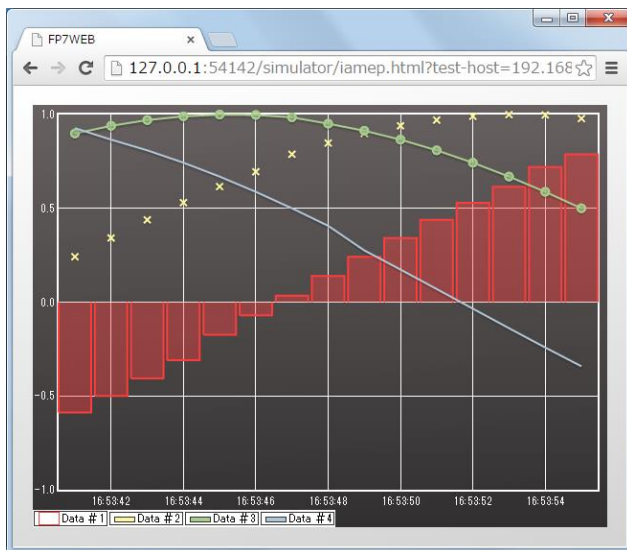

Overview of the functions that can be used for graphs

■ Functions common to sampling and array graphs

- A maximum of 32 bar graphs can be displayed simultaneously.
- A maximum of 10000 points of graphs can be displayed.
* It is not possible to display all of 10000 points in a graph.
The points actually displayed are limited to the number of dots on the screen that a graph occupies.
For displaying all 10000 points, activate the expansion control and reduce the image. The whole graph can be confirmed.
- An explanatory note can be set. It is selectable whether to display or hide it on monitoring.
- It is selectable to use the left or right axis for the scale for each graph separately.
- Besides a linear scale, a logarithmic scale can be specified.
- By displaying the expansion control on a graph, the display of the whole graph can be reduced or expanded with the control.
- Even when the displayed screen is not in the active state, its displayed content is updated in the background.

■ Peculiar function to array graph

- The graph display is not updated periodically. It is updated only when a specified device bit turns ON.

■ Number of displayed points of graph

When the number of displayed points is short, it can be increased by increasing the graph width.

To see further detailed points, use the enlargement control.

■ Change of update cycle

The update cycle of graphs can be changed by 0.1 seconds.
The update may not be performed by a specified update cycle.
In such case, graphs are updated with best effort.

Extended graph widget (xgraph)

common parameters

device

graph

mode

refresh period

max points

The update cycle can be changed in increments of 0.1 seconds by setting it to "Custom".

■ **Change of initial display position**

The initial display position of a graph when accessing contents can be changed.

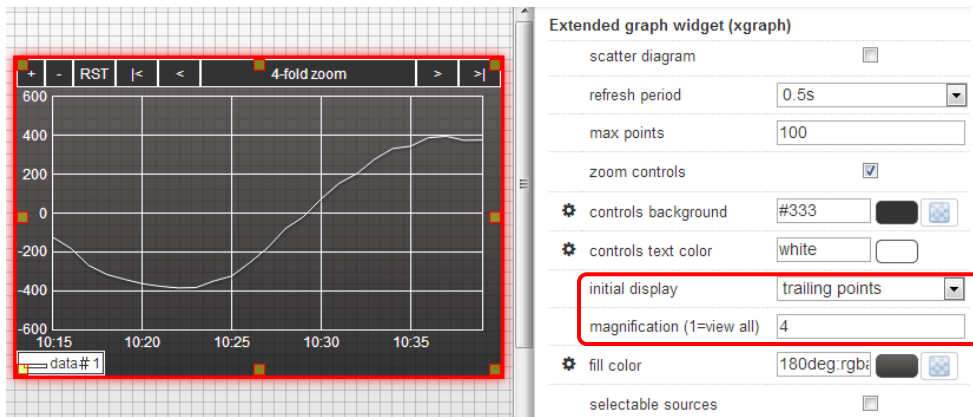

Setting	Description
initial dispaly	The initial display position can be selected from "all points", "first points", and "trailing points". The default is "all points".
magnification	This item is available when the "initial display" setting is set to "first points" or "trailing points". The default value of the display magnification of graphs can be changed.

The default graph displays of each setting are shown on the next page.

All graph data

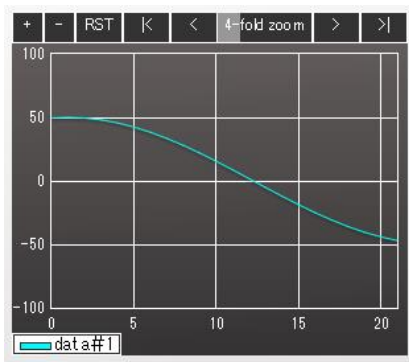
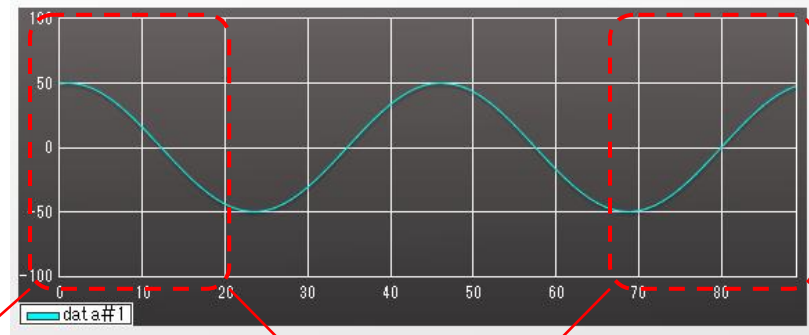

initial display: first points
magnification: 4

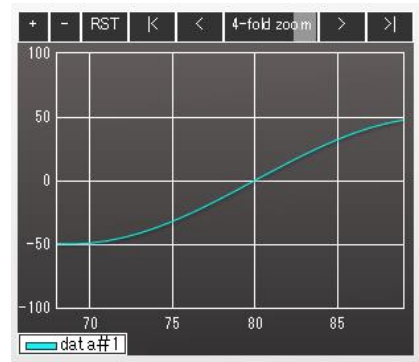

initial display: trailing points
magnification: 4

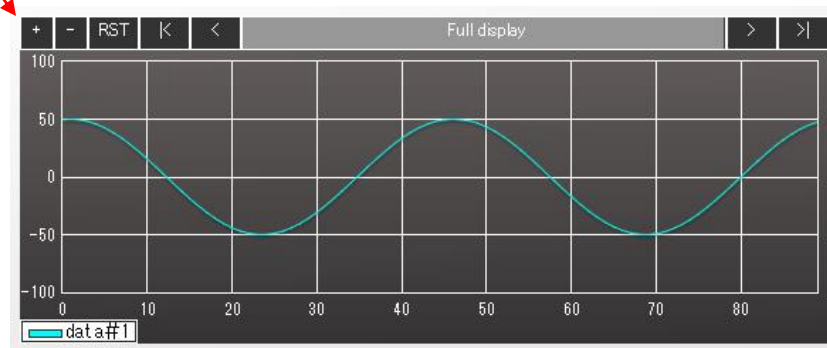

initial display: all points

Data for the number of display data is always drawn in line graphs. Therefore, even when the number of display data is larger than the graph width, the peak value can be confirmed.

■ **Array graph: Change of X axis**

- More detailed X-axis settings can be changed when specifying array graph.

Extended graph widget (xgraph)

- common parameters
- device
- graph
- legend
- xaxis
 - type: time
 - first value: 9:00
 - x text size: 12px
 - x text color: white
 - x tick color: white
 - x magnification: 1
 - x unit: am

Setting	Description
type	Select the content of X-axis scale from "number" or "time".
first value	Specify the start value of scale values displayed on the X axis.
X magnification	The display magnification of the X-axis scale can be specified. The value calculated by multiplying the "decimals" by the " X magnification " is displayed on the scale.
X unit	The unit of the X-axis scale can be specified.

Changes in Ver.3.1.0

Although the X-axis scale display was adjusted by the three settings "decimals", "increment" and "X magnification", "decimals" and "increment" were eliminated and the display can be adjusted only by "X magnification".

No. of display data: 100
X magnification: 1

X magnification: 5

X magnification: 0.01

Note)

When using an extended graph to which "decimals" and "increment " have been set in Ver.3.0.0, the X-axis scale is recalculated regarding "decimals" as "0" and "increment" as "1" in Ver.3.1.0.

When "decimals" and "increment" have been set, reset the x magnification based on the following table.

" decimals " and " increment " to "X magnification"

decimals	X data magnification
1	0.1
2	0.01
3	0.001
4	0.0001
5	0.00001
6	0.000001

increment	X data magnification
2	2
5	5
10	10
100	100
1000	1000

■ **Change of the time unit of X axis for trend graphs (Improvement in Ver.3.1.0)**

"x axis time unit" can be specified and fixed by setting the time unit of X axis.

The following figure shows an example when setting "x axis time unit" to 10 seconds.

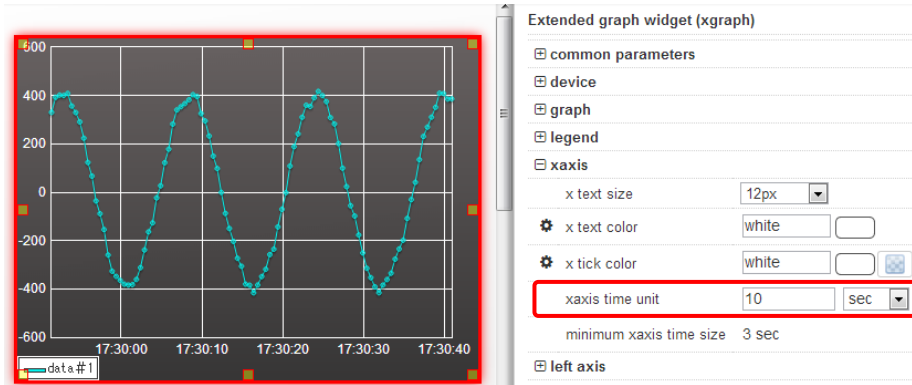

◆ **PROCEDURE**

- **Setting procedure of "x axis time unit"**

1. Click the "auto ▼" button, and select an arbitrary time unit.

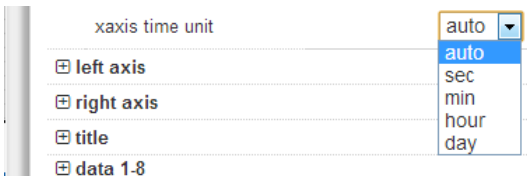

2. The input field is displayed on the left of "x axis time unit". The default value is for setting the scale width to be 50 pixels. Input a value larger than "minimum xaxis time size". "minimum xaxis time size" is a guide for the time to make the scale width be 25 pixels.

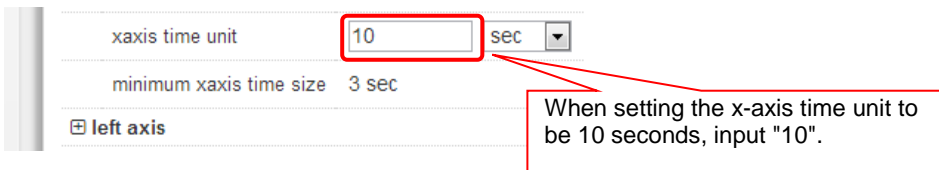

• Precaution when setting the x-axis time unit

The settable lower limit value for the x-axis time unit is calculated by the following formula.

$$\begin{aligned} \text{Whole time of a graph} \\ \text{(Time from end to end)} &= \text{"refresh period"} \times \text{"max points"} \\ \\ \text{Settable lower limit value for x-axis time unit (sec)} &= 25\text{px} \times \frac{\text{Whole time of a graph (sec)}}{\text{Graph width (px)}} \end{aligned}$$

As a result of changing the setting items in the above formula "refresh period", "max points" and the graph "width", if the scale width of the x-axis time unit becomes smaller than 25 pixels, it is automatically adjusted to the settable lower limit value for the x-axis time unit.

• Adjusting procedure of "x axis time unit"

For expanding the scale width or when the x-axis scales overlap

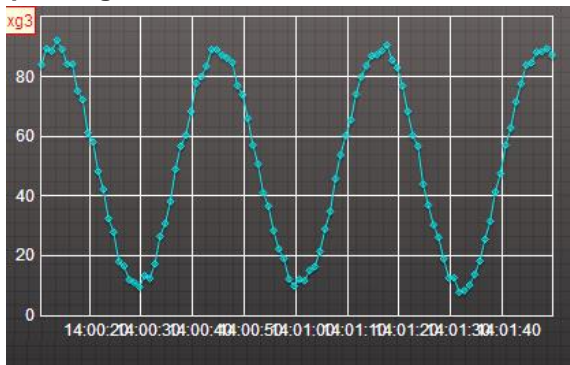

Use the following procedure for the adjustment.

- Expand the "width" of the common properties. (Expand the width of graph parts.)
- Shorten the "refresh period" of graph properties.
- Reduce the "max points" of graph properties.
- Increase the "x axis time unit" of x-axis properties.
- Reduce the "x text size" of the x-axis properties.

For reducing the scale width

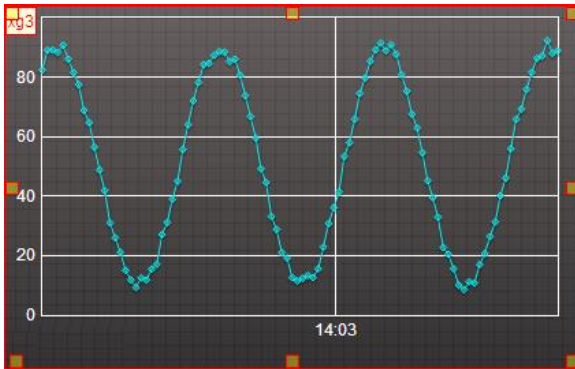

Use the following procedure for the adjustment.

- Reduce the "width" of the common properties. (Reduce the width of graph parts.)
- Increase the "refresh period" of graph properties.
- Increase the "max points" of graph properties.
- Reduce the "x axis time unit" of the x-axis properties.

■ Change of Y axis

- The data magnification and unit of the Y axis (Left/Right) can be specified as well as the X axis.
- Also, the display of the upper and lower limit values for graph data can be set.

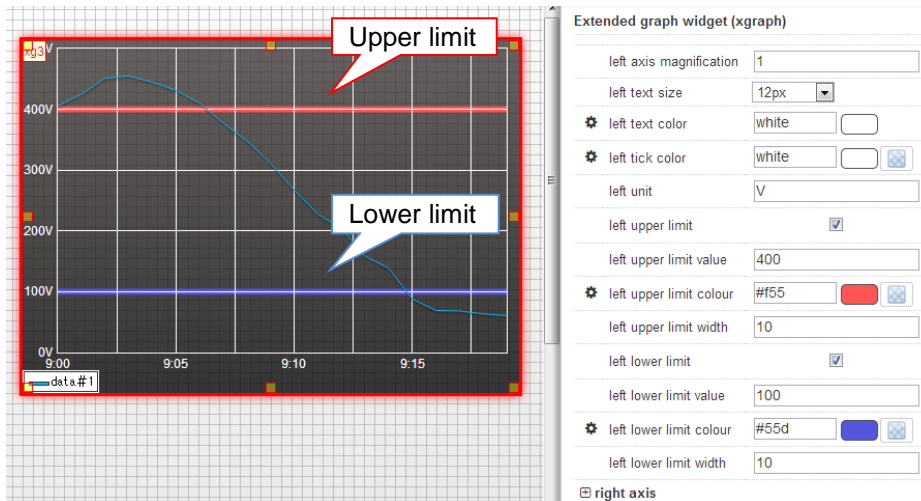

Setting	Description
(Left/Right) axis magnification	The display magnification of the Y-axis scale can be specified.
(Left/Right) unit	The unit of the Y-axis scale can be specified.
(Left/Right) upper limit	Check this box for displaying the upper limit value.
(Left/Right) upper limit value	Set the scale value for displaying the upper limit value.
(Left/Right) upper limit color	Set the color of the upper limit display.
(Left/Right) upper limit width	Set the thickness of the upper limit display. The thickness varies according to the specified value and the Y-axis scale.
(Left/Right) lower limit	Check this box for displaying the lower limit value.
(Left/Right) lower limit value	Set the scale value for displaying the lower limit value.
(Left/Right) lower limit color	Set the color of the lower limit display.
(Left/Right) lower limit width	Set the thickness of the lower limit display. The thickness varies according to the specified value and the Y-axis scale.

■ Change of control bar

The background color and the character color of the control bar can be changed.

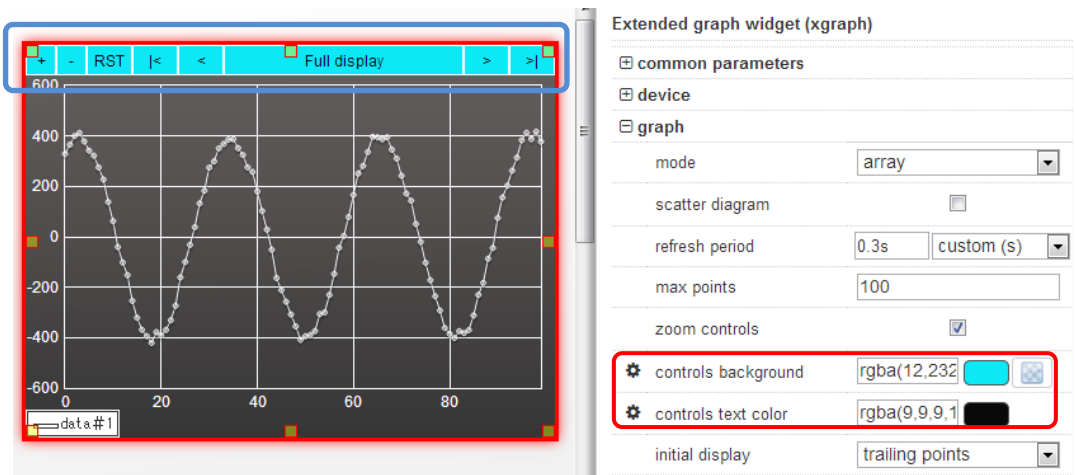

■ Change of legend

- The background color and the format of legends can be changed.

- The setting whether to display or hide legends can be changed.

When displaying legends, the display position can be set.

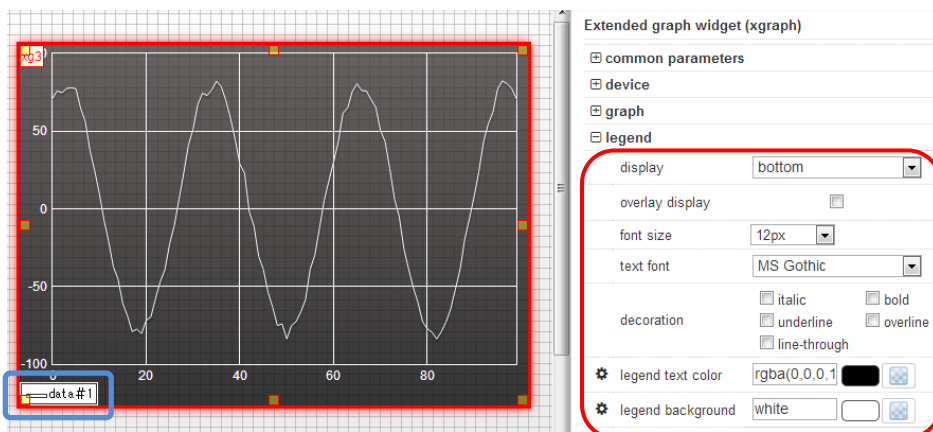

■ Display of scatter diagram

On array graphs, the display can be switched to the scatter diagram by enabling the "scatter diagram" setting.

By showing the display as a scatter diagram, the distribution and correlation of the second item (vertical and horizontal axes) can be grasped.

For displaying scatter diagrams, it is necessary to check the box of the scatter diagram display after specifying the operation mode "array".

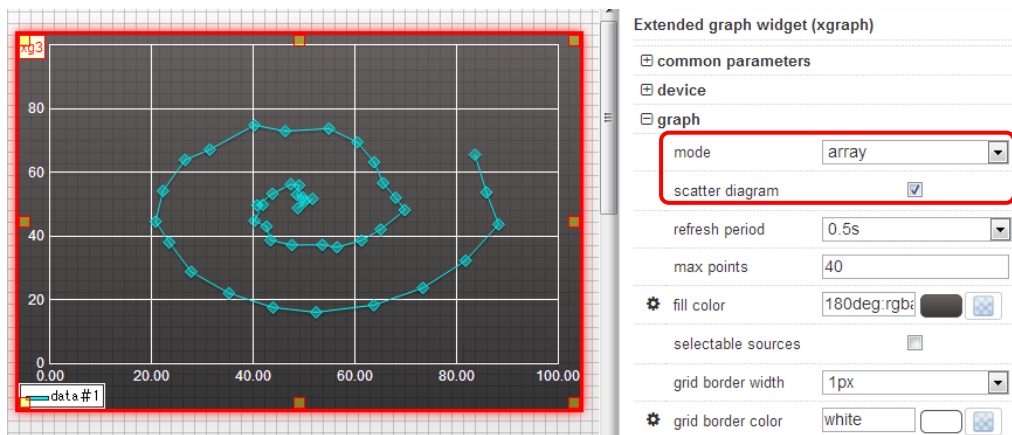

Example of the actual display of a scatter diagram

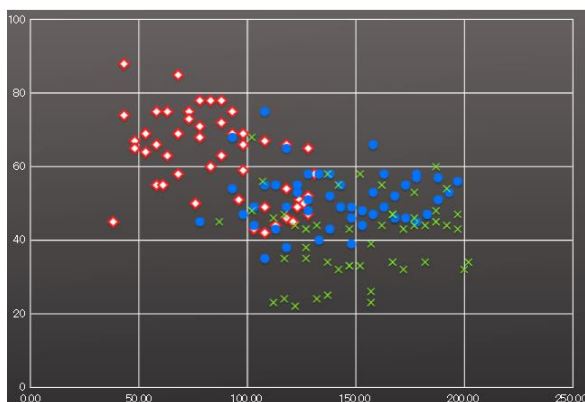

For the reference devices corresponding to the coordinates of scatter diagrams, refer to the next page.

Example)

When;

Monitor device = DT10

Data type = SS (1 word)

Number of displayed data =100,

the combination of the coordinates of scatter diagram is as follows.

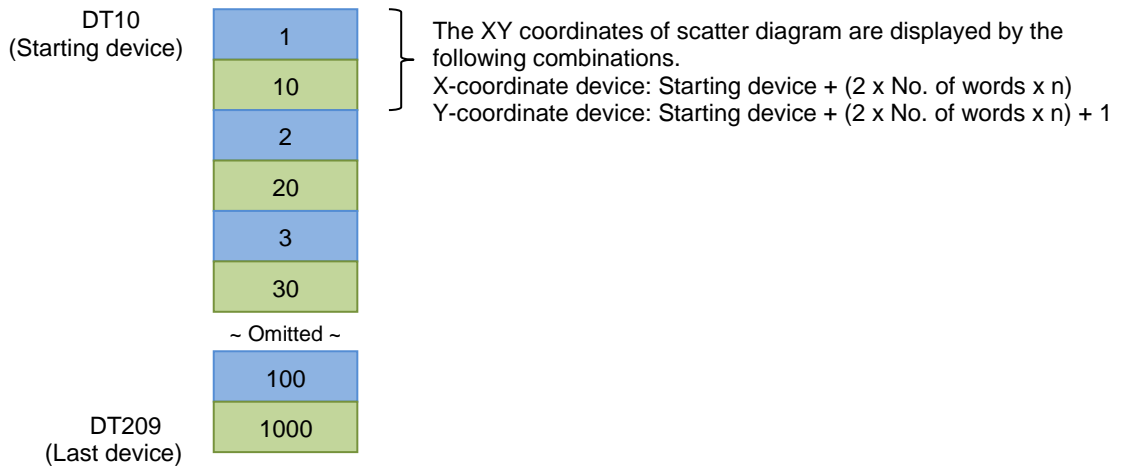

When data is like the above figure, the XY coordinates of the scatter diagram are (1, 10), (2, 20), (3, 30) ... (100, 1000).

3.5.7.2.6 Data Parts (Improvement in Ver.3.1.0)

The following improvements have been made in Ver.3.1.0.

- - Added Time 0 (BIN) to "format". ([Details](#))

Using data parts enables displaying values, character strings, date and time. When values or strings are displayed from data parts, the writing operation is also available. Writing operation is not available when date and time is displayed.

By setting a peak hold device when displaying a value, the minimum or maximum value of the displayed value can be output to the internal device.

The update cycle for the display contents of data parts can be specified by setting the display cycle.

■ Monitoring character string information with data parts

Character strings can be monitored as well as values.

● Setting method

Data widget (data) disable frame

common parameters

device

data format

format

max-length

prefix

suffix

text format

frame format

ranges

* "string 0" and "string 1" and "string 2" of the display/input method are different in the input/output format.

For details, refer to the following "Character string format".

● Operation image

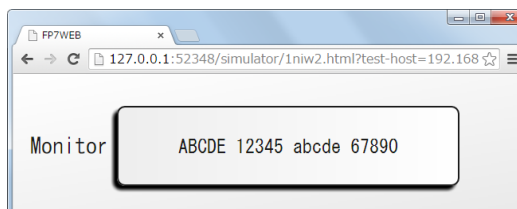

*The appearances of "string 0" and "string 1" and "string 2" are the same.

● **Character string format**

Notes concerning the input/output format of string 0

- When selecting "Add NULL", NULL(00H) is added to the end of an input value when inputting from a data part and output is performed.
The NULL(00H) added to the end of the input value is included in the number of input characters. The number of the input characters including NULL should be within the maximum number of characters.
- When the number of input characters is less than the maximum number of characters for outputting from a data part, space (20H) is entered after the input value.
- When displaying string for a data part, all the data of the maximum number of characters are displayed even when NULL(00H) data is included.

[Input/output format of string 0 (NULL is added)]

When "12345ABCD" is input, it is set in PLC as follows.

When a maximum of 100 characters (the maximum number of characters is set to 100) can be input;

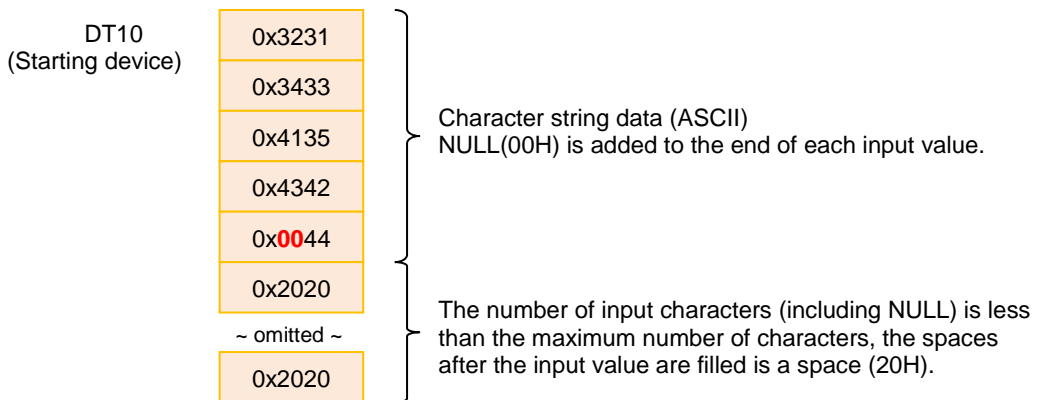

[Input/output format of string 0]

When "12345ABCD" is input, it is set in PLC as follows.

When a maximum of 100 characters (the maximum number of characters is set to 100) can be input;

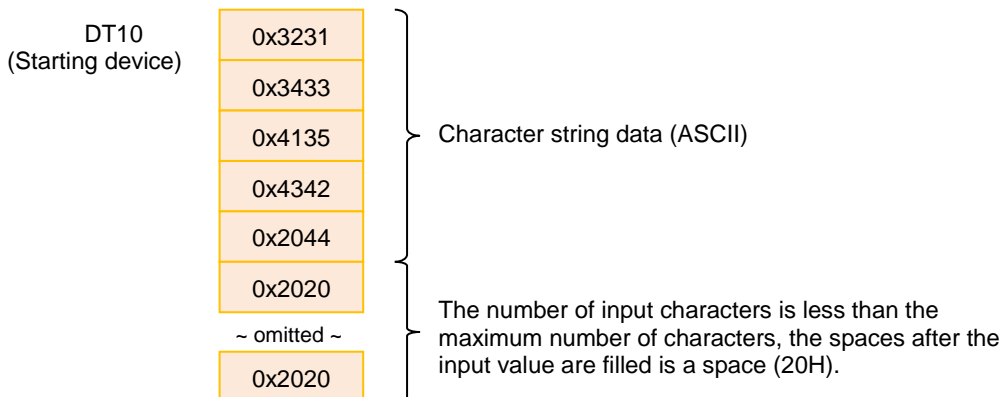

[Input/output format of string 1]

When "12345ABCDE" is input, it is set in PLC as follows.

When a maximum of 100 characters (max-length is set to 100) can be input;

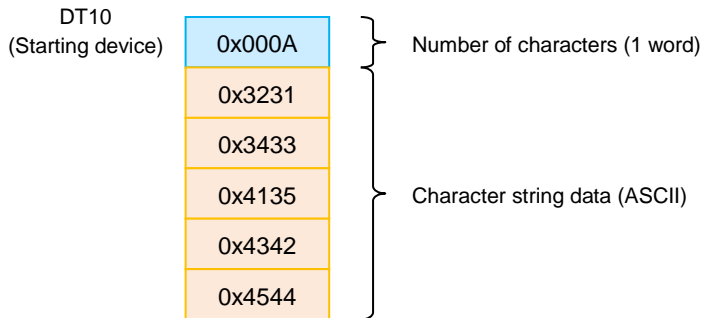
**[Input/output format of string 2]**

When "12345ABCDE" is input, it is set in PLC as follows.

When a maximum of 100 characters (max-length is set to 100) can be input;

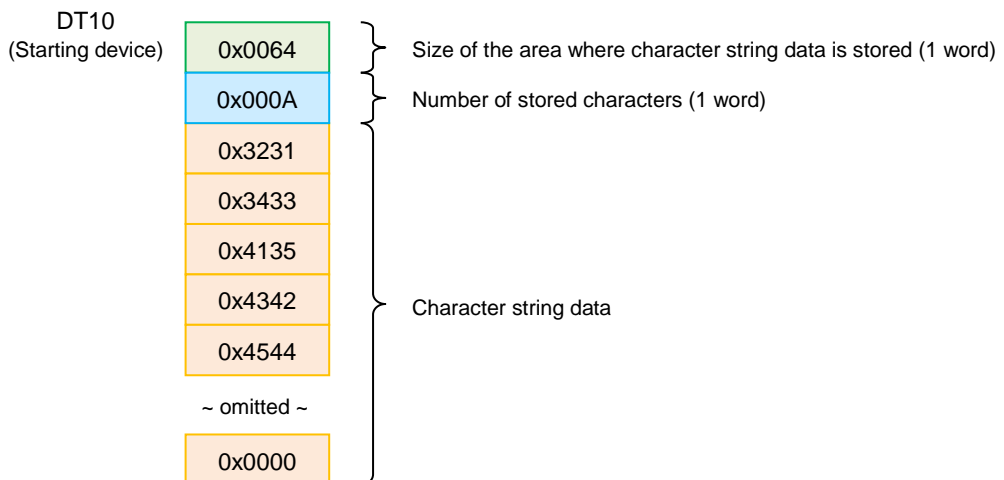

■ **Monitoring time information with data parts**

Data parts can display the time information stored in specified formats. The display method of time is selectable from multiple options. Once the time display setting is made, the input operation cannot be performed from data parts.

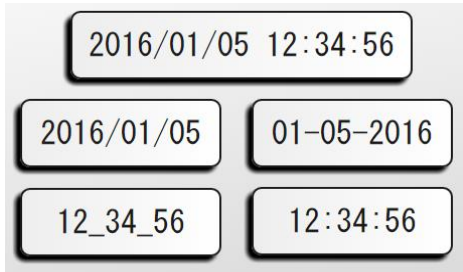

• **Time display format**

Notes concerning time display formats

The following three displays are available for time information, however, formats vary depending on the displayed contents.

Store data in the format which matches each display content.

1. Display of year, month and day (DATE)
2. Display of hour, minute and second (TIME)
3. Display of year, month, day, hour, minute and second (DATE & TIME).

[Input format of Time 0 (BIN)]

The input format of time (BIN) is composed of 6 words.
The format of each display content is as follows.

- (1) When displaying "2016/01/23" as year, month and day (DATE);

(1st word)	(2nd word)	(3rd word)	(4th word)	(5th word)	(6th word)
16	1	23	—	—	—
Year	Month	Day	Unused area		

- (2) When displaying "10:25:30" as hour, minute and second (TIME);

(1st word)	(2nd word)	(3rd word)	(4th word)	(5th word)	(6th word)
10	25	30	—	—	—
Hour	Minute	Second	Unused area		

- (3) When displaying "2016/01/23 10:25:30" as year, month, day, hour, minute and second (DATE & TIME);

(1st word)	(2nd word)	(3rd word)	(4th word)	(5th word)	(6th word)
16	1	23	10	25	30
Year	Month	Day	Hour	Minute	Second

[Input format of BCD-coded time]

The input format of time (BCD) is composed of 3 words.
The format of each display content is as follows.

- (1) When displaying "2016/01/23" as year, month and day (DATE);

(1st word)	(2nd word)	(3rd word)
0x1601	0x23**	0x****
Year, month	Day	"" is an unused area.

- (2) When displaying "10:25:30" as hour, minute and second (TIME);

(1st word)
0x1025
0x30**
0x****
Hour, minute
Second
"" is an unused area.

- (3) When displaying "2016/01/23 10:25:30" as year, month, day, hour, minute and second (DATE & TIME);

(1st word)	(2nd word)	(3rd word)
0x1601	0x2310	0x2530
Year, month	Day, hour	Minute, second

[Input format of ascii-coded time]

The input format of time (ASCII) is composed of 6 words.

The format of each display content is as follows.

- (1) When displaying "2016/01/23" as year, month and day (DATE).

(1st word)	(2nd word)	(3rd word)	(4th word)	(5th word)	(6th word)
0x3136	0x3031	0x3233	—	—	—
Year	Month	Day	Unused area		

- (2) When displaying "10:25:30" as hour, minute and second (TIME);

(1st word)	(2nd word)	(3rd word)	(4th word)	(5th word)	(6th word)
0x3130	0x3235	0x3330	—	—	—
Hour	Minute	Second	Unused area		

- (3) When displaying "2016/01/23 10:25:30" as year, month, day, hour, minute and second (DATE & TIME);

(1st word)	(2nd word)	(3rd word)	(4th word)	(5th word)	(6th word)
0x3136	0x3031	0x3233	0x3130	0x3235	0x3330
Year	Month	Day	Hour	Minute	Second

● Changing display contents by threshold values

Display contents can be changed according to acquired values by setting the upper and lower threshold values.

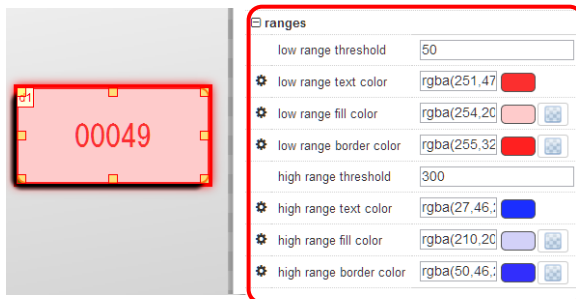

Setting	Description
low range threshold	Specify a threshold of low range. When an acquired value is less than the threshold value, the display changes to the content of low range.
low range text color	Set the font color when an acquired value is in the low range.
low range fill color	Set the background color when an acquired value is in the low range.
low range border color	Set the frame color when an acquired value is in the low range.
high range threshold	Specify a threshold of high range. When an acquired value is less than the threshold value, the display changes to the content of high range.
high range text color	Set the font color when an acquired value is in the high range.
high range fill color	Set the background color when an acquired value is in the high range.
high range border color	Set the frame color when an acquired value is in the high range.

■ Limitation of input range

When the input is performed to the range outside of a specified input range, writing to a PLC cannot be performed.

Setting	Description
input max value	Specify the upper limit value of input. When not specified (blank), a range in accordance with the type specified for data type is set automatically.
input min value	Specify the lower limit value of input. When not specified (blank), a range in accordance with the type specified for data type is set automatically.

3.5.7.2.7 Media Player Parts

Media Player Parts

By setting a moving image file to the part, a moving image can be played on browser.

Playing, pausing and stopping a moving image can also be controlled by a PLC.

Media player parts are not available for Eco-POWER METER.

■ Setting method

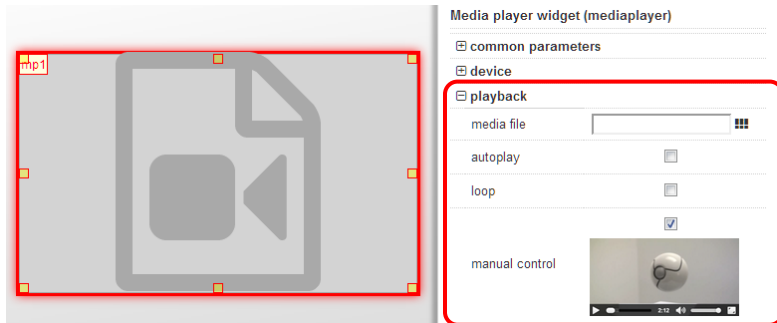

Setting	Description
media file	Specify a moving image file to be played.
autoplay	A moving image is automatically played when it is displayed on browser.
loop	A moving image is played repeatedly.
manual control	It enables to control the play of a moving image on the part.

* Save moving image files to be played in the following folder in advance.

For details, refer to "2.2 Folder Structure of Web Creator".

Storage location of moving image files: WebCreator\WebCommons\img\video

The available formats of moving image files are as follows.

File format	File extension
MP4	***.mp4
OGV	***.ogv
WebM	***.webm

■ Cooperation with PLC

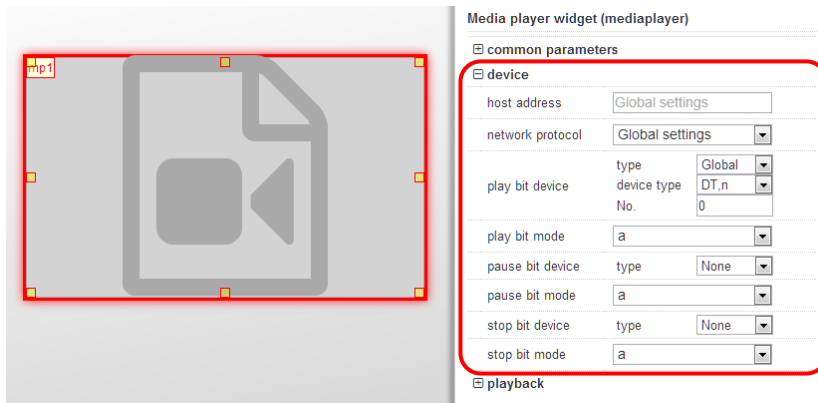

Media player widget (mediaplayer)

common parameters

device

host address Global settings

network protocol Global settings

play bit device type Global device type DT.n No. 0

play bit mode a

pause bit device type None

pause bit mode a

stop bit device type None

stop bit mode a

playback

Setting	Description
play bit device	Specify a bit device for controlling the playback of moving image files.
play bit mode	Set "a" or "b".
pause bit device	Specify a bit device for controlling the pause of moving image files.
pause bit mode	Set "a" or "b".
stop bit device	Specify a bit device for controlling the stop of moving image files.
stop bit mode	Set "a" or "b".

3.5.7.2.8 Level Graph Parts

Using level graph parts enables the graph displays by group. Up to three graphs can be displayed per one group, and up to 16 groups can be displayed.

When a graph is not displayed within a part, a scroll part appears automatically.

Level graph parts are not available for FP7 / ELC500.

* From the Web Creator Ver.3.0.0 or later, they are also available for FP7 / ELC500.

■ Operation of level graphs

Consecutive data is acquired from the starting device for each group and the graphs are displayed.

Example) When displaying three graphs for one group

Starting device of group 1: DT10 (US type)

Starting device of group 2: DT20 (US type)

Starting device of group 3: DT30 (US type)

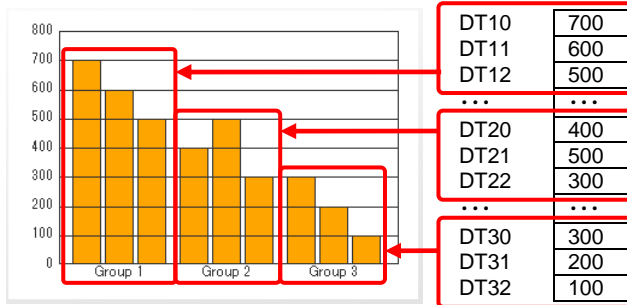

■ Graph setting

The number of groups to be displayed as graphs can be set. The number of displayed graphs in each group can be individually set in each group setting.

Setting item	Description
Device	
host address	Specify the address of a reference device of a part. When unspecified, the common setting is used.
network protocol	Specify a communication protocol.
Number of groups	Specify the number of groups displayed as graphs.

Setting item	Description
Group 1 to 16	
name	Specify the name of each group. The specified name is displayed on the horizontal axis of graphs.
number of points	Specify the number of graphs displayed in each group. Acquires the points of the specified number successively from the specified device.
device	Specify a starting device monitored continuously.

■ Graph display setting

The color of graphs and background can be specified in the graph setting.

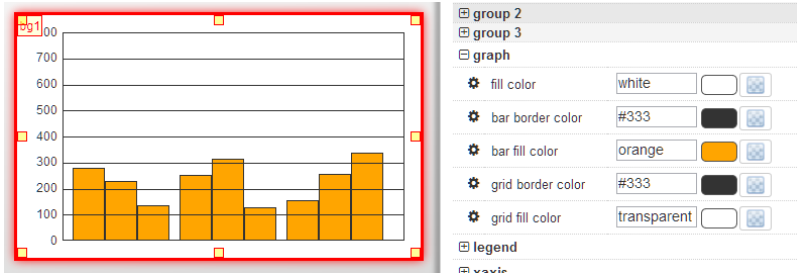

Setting item	Description
fill color	Specify the background color for the whole level graph.
bar border color	Specify the frame color of bar graphs in level graphs.
bar fill color	Specify the color of bar graphs in level graphs.
grid border color	Specify the frame color of level graphs.
grid fill color	Specify the background color in the graphs of level graphs.

■ Legend setting

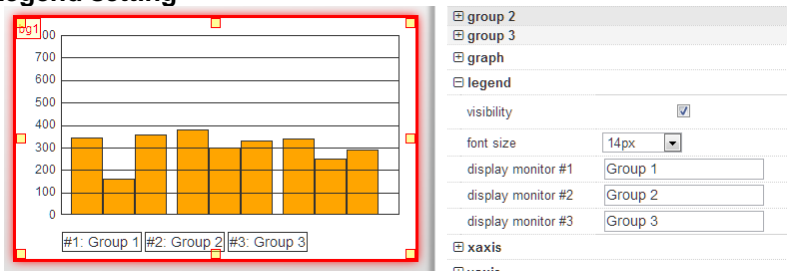

Setting item	Description
visibility	Specify whether legends are displayed or not. When checked, the contents specified in the display monitor #1 to #3 are displayed on the lower part of graphs as legends.
font size	Specify the character size of legends.
display monitor #1	Specify the character string displayed as legends.
display monitor #2	Specify the character string displayed as legends.
display monitor #3	Specify the character string displayed as legends.

■ **Display axis setting**

Specify the items such as the color of level graphs.

When graphs are not displayed within the display frame according to the setting, a scroll bar appears automatically.

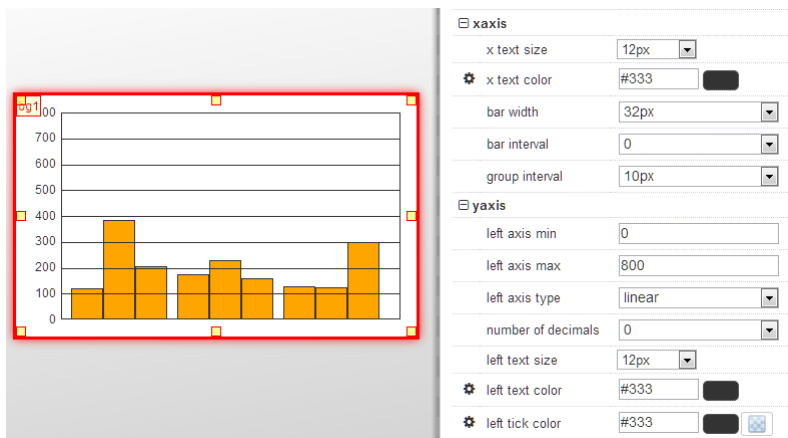

Setting item	Description
x axis	
x text size	Specify the size of the character strings displayed on the horizontal axis. This setting is used for the character size of the name specified for group n.
x text color	Specify the character color displayed on the horizontal axis.
bar width	Specify the width of a bar graph.
bar interval	Specify the display interval of graphs within a group.
group interval	Specify the display interval of graphs for each group.
y axis	
left axis min	Specify the minimum value of the vertical axis. When unspecified, the minimum value within display data is displayed as the minimum value of graphs.
left axis max	Specify the maximum value of the vertical axis. When unspecified, the maximum value within display data is displayed as the maximum value of graphs.
left axis type	Specify the graph interval setting from linear, log 10 or log n.
number of decimals	Displays the value calculated by multiplying an acquired value from a device by 100-n.
left text size	Specify the character size of the vertical axis.
left text color	Specify the character color of the vertical axis.
left tick color	Specify the scale color of the vertical axis.

■ Title setting

The title of graphs can be set. The title cannot be changed from the upper part of the graphs.

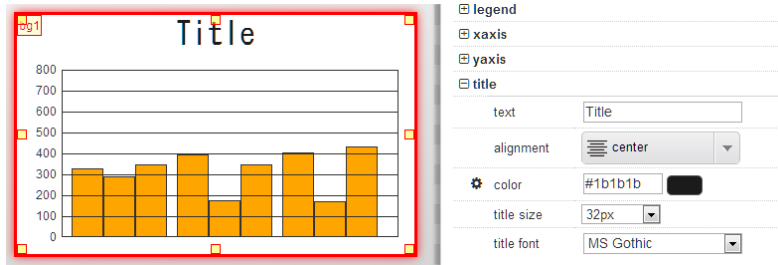

The image shows a bar chart with a title 'Title' at the top. The y-axis ranges from 0 to 800. The chart has 10 bars with varying heights. To the right of the chart is a settings panel for the title. The settings are as follows:

Setting item	Description
text	Title
alignment	center
color	#1b1b1b
title size	32px
title font	MS Gothic

Setting item	Description
text	Specify the title of graphs.
alignment	Specify the display position of the characters set as the title.
color	Specify the character color of the title.
title size	Specify the character size of the title.
title font	Specify the character font used for the title.

3.5.7.2.9 Integration Graph Parts

Under "Integration graph," a bar graph or pie chart can be visually presented.

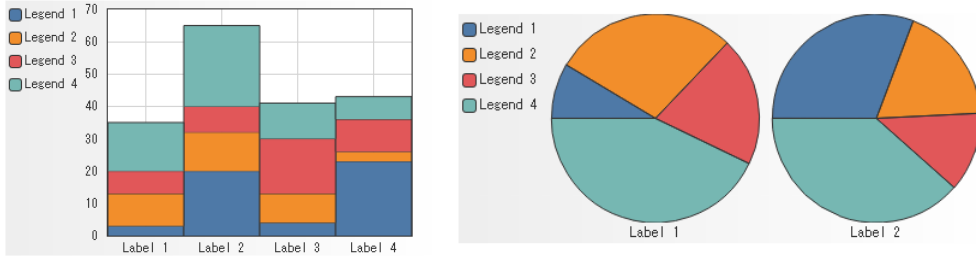

Align the cursor to the integration graph on the browser screen to display the details.

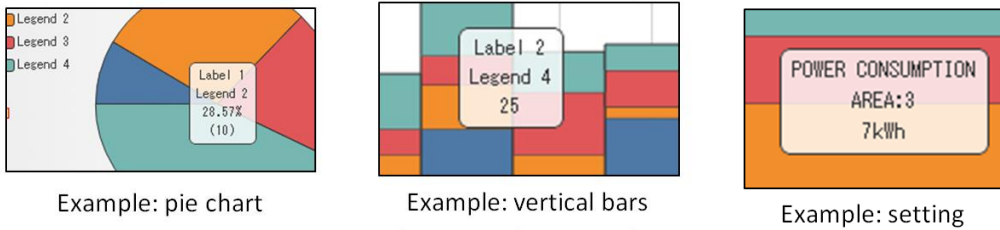

■ Setting

Under "Graph shape" in the graph tab, select a representative design for a new "Integration graph" part.

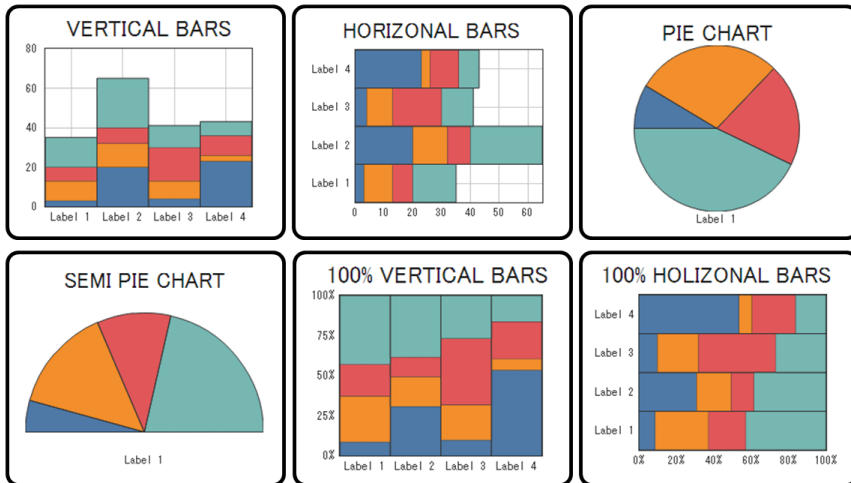

■ Setting a title

The title of the integration graph can be set.

The title set here is also applied to the label and legend under "Graph: detailed setting (devices/labels/elements)."

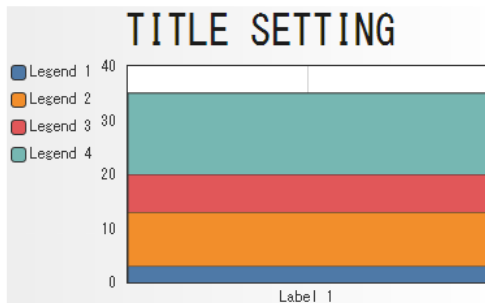

☰ title

text

alignment

⚙ color

title size

title font

decoration italic bold
 underline overline
 line-through

Setting item	Description
text	The title of the integration graph can be specified.
alignment	Specify the alignment of the title.
color	Specify the text color of the title.
title size	Specify the text size of the title.
title font	Specify the text font used for the title.
decoration	Specify the text style used for the title.

■ **Setting of graph display**

Set the display mode, grid fill color, etc. for the integration graph.

graph

graph type: vertical bars

refresh period: 1s

read trigger: type: Global, device type: R, No.: 0

graph count: 1

device count: 4

display mode: default

Detail settings (devices, labels, legend)

fill color: #eee.white

grid border width: 1px

grid border color: #333

grid fill color: #fff

AREA: 1 (blue)

AREA: 2 (orange)

AREA: 3 (red)

AREA: 4 (teal)

Setting item	Description
graph type	The shape of the integration graph can be selected from "Column graph," "Bar graph cumulation," "Pie chart," "Half pie chart," "Column graph 100%," and "Bar graph 100%."
refresh period	The refresh cycle for display content can be selected from below. Best effort / 0.5s / 1s / 2s/ 5s / 10s / 1 min
read trigger	The timing for data acquisition can be determined by the specified device.
graph count	Specify the number of displayed graphs. Max. 32
device count	Specify the number of device to register to graphs. Up to 8 x 32 = 256 devices can be registered.
display mode	The display mode for the integration graph can be selected from "Registration order," "Ascending order," and "Descending order." When the displayed graphs is set to 1, this item is indicated for setting. The default value is "Registration order."
detail settings (devices, labels, legend)	Press "Edit" button to set devices, labels and elements to be indicated on the integration graph.
fill color	Specify the grid fill color for the entire integration graph.
grid border width	Specify the grid border thickness inside the integration graph.
grid border color	Specify the grid border color for the integration graph.
grid fill color	Specify the grid fill color inside the integration graph.

■ How to perform detailed setting (devices / labels / elements)

display mode

Detail settings **Edit**
(devices, labels, legend)

fill color

Press the [Edit] button in "Detail Settings (devices, labels, legend)" to view the setting screen as below.

The setting screen varies by the type of integration graph.

Integration Graph Details

(device, label, legend)

DT8 (SS) x1	DT16 (SS) x1	DT24 (SS) x1	DT32 (SS) x1	DT256 (SS) x1	Legend 8
DT7 (SS) x1	DT15 (SS) x1	DT23 (SS) x1	DT31 (SS) x1	DT255 (SS) x1	Legend 7
DT2 (SS) x1	DT10 (SS) x1	DT18 (SS) x1	DT26 (SS) x1	DT250 (SS) x1	Legend 2
DT1 (SS) x1	DT9 (SS) x1	DT17 (SS) x1	DT25 (SS) x1	DT249 (SS) x1	Legend 1
Label Setting Label 1	Label Setting Label 2	Label Setting Label 3	Label Setting Label 4	Label Setting Label 32	

Column graph / (semi) pie chart; maximum display (32 displayed graphs, 8 registered devices)

Click each setting item to display the setting screen as below.

■ Device settings

Integration Graph Details

(device, label, legend)

DT3 (SS) x1	DT6 (SS) x1	Legend 3
DT2 (SS) x1	DT5 (SS) x1	Legend 2
DT1 (SS) x1	DT4 (SS) x1	Legend 1
Label Setting Label 1	Label Setting Label 2	

Device Setting

Data device type

device type

No.

data type

Data multiplier

Setting item	Description
Data device	Type of monitor device, model of device, number, and data type can be specified.
Data multiplier	The display amplification on the axis scale of the integration graph can be specified. This amplification setting is for the scale display value, and therefore does not affect the number of displayed data items.

■ Label settings

Integration Graph Details

(device, label, legend)

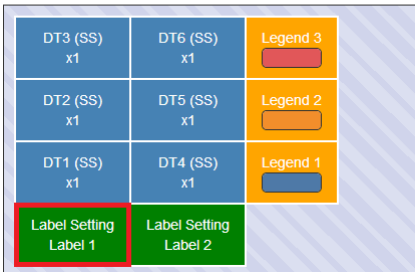

Label Setting

Label text

Setting item	Description
Label text	Specify the label name for the integration graph. When left blank, the selected label can be hidden.

■ Element settings

Integration Graph Details

(device, label, legend)

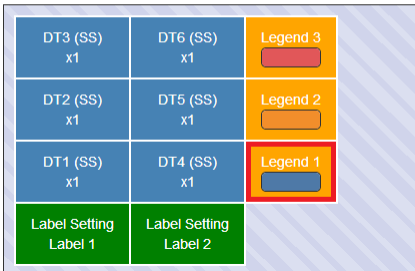

Legend Setting

Legend text

Legend color

Setting item	Description
Legend text	Specify the element name for the integration graph. When left blank, the selected element can be hidden.
Legend color	Specify the element color.

■ Setting the axes

Set the display color, etc. for the integration graph.

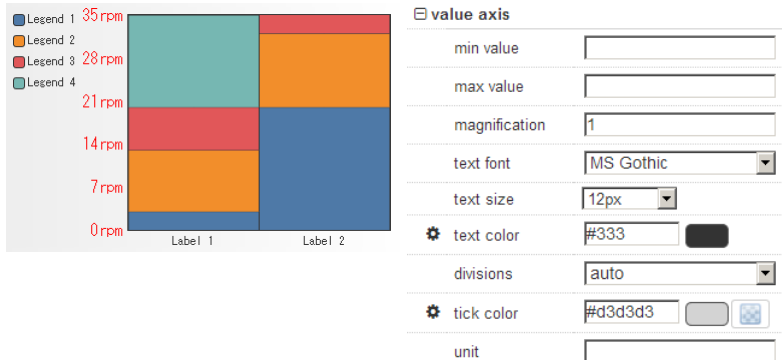

value axis

min value

max value

magnification

text font

text size

text color

divisions

tick color

unit

Setting item	Description
min value	Specify the min value for the axis. (Only valid when "Column / Bar graph" is selected)
max value	Specify the max value for the axis. (Only valid when "Column / Bar graph" is selected)
magnification	Specify the amplification for the axis. (Only valid when "Column / Bar graph" is selected)
text font	Specify the font for strings to be indicated on the axes.
text size	Specify the size for strings to be indicated on the axes.
text color	Specify the text color to be indicated on the axes.
divisions	Specify the number of divisions of the scale. It can be selected "Hide," "Auto-select," and "2 to 23." For selection from "2 to 23," the axis scale is indicated in accordance with the number of divisions, only when both the min and max values are specified. If either or both of the min and max values have yet to be specified, "Auto-select" supersedes the selection of "2 to 23."
tick color	Specify the axis tick color.
unit	Specify the axis unit.

3.5.7.2.10 SD Card Logging Graph Parts

This function reads data from the logging file saved in the SD card inside FP7, and displays a graph on the web browser.

■ Target model

Only the FP7 CPU unit with the Ethernet function (firmware Ver.4.47 or later)

The SD card logging graph parts can only be displayed on the web.

■ Operation of the SD card logging graph

1. Specify year, month, date and hour on the parts browser.
2. Press the [Refresh] button to read the data of the specified date from the SD card. Among the first value, total value, mean value and accumulated value, the data of the value specified in part arrangement is indicated on the browser as a column/bar or line graph. Up to eight graphs can be displayed. Mixed display of line and bar / column graphs for a single part is also possible.

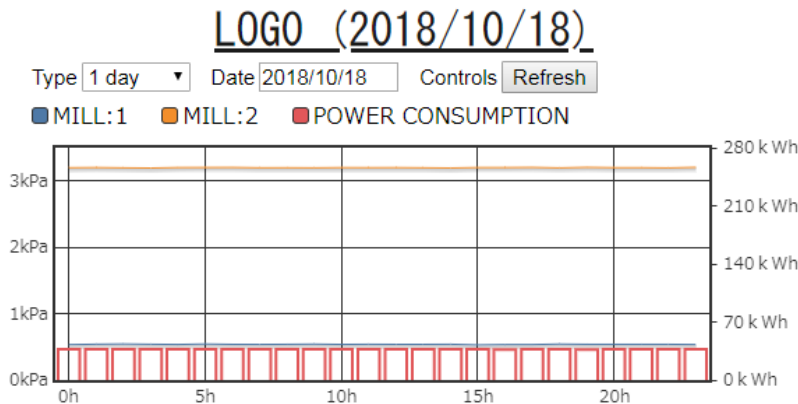

* If target data is missing, the graph is not displayed on the missing point.

■ Setting of displayed plots

Setting item	Description
Specify year	12-month display by month, starting from January; Up to 12-point display (scale: 1 to 12)
Specify month	Up to 31-day display by day, starting from the 1st; Up to 31-point display (scale: 1 to 30)
Specify date	24-hour display by hour, starting from 0 hour; Up to 24-point display (scale: 0 to 20)
Specify hour	60-minute display by minute, starting from 0 minute; Up to 60-point display (scale: 0 to 50)

■ Data and restrictions that can be graphically represented

- (1) Only files that are under logging generation management
 - Files that are not created through logging are excluded from the scope, even if contained in the LOG folder.
 - Files are also excluded from the scope if generation management has been cleared due to changes in logging conditions, etc. following file creation.
- (2) The type of logging trigger should be cycle or time.
- (3) The type of determination trigger should be time or record upper limit.
- (4) The logging data should not include ",", linefeed code, or NULL as STRING data.
- (5) Data format that cannot be aggregated: HEXnW, STRING, BIT
- (6) During data aggregation, reading and writing into the SD card are stopped (accumulation into the logging buffer is continued).

■ Setting items for the SD card logging graph part

Setting item	Description
Log settings	
Log number (LOGn)	0 to 15
Log filename	Specify the file name to be recorded in error indication.
Plot type	Select a plot period. It can be selected from "1 year," "1 month," "1 day," and "1 hour."
Plot type menu	The display plot type can be made changeable during web server execution.
Save data and plot type selection	It can be selected whether or not to save the date, time and plot type specified in the previous run on the browser.
Summary results	It can be selected whether or not to acquire the following upon the completion of log file reading. Files in the directory / aggregated files / files with errors
Controls position	The position of the refresh button can be selected from top, bottom, left and right.
Legend	The position of legend display can be selected.
Number of data columns	1 to 8
Timeout (s)	The timeout time for the aggregation process can be specified in the range from 0 to 999 seconds.

Setting item	Description
x axis	
x text size	x text size can be specified.
x text color	x text color can be specified.
x tick color	x tick color can be specified.
left axis	
left axis min	Specify the left axis min value.
left axis max	Specify the left axis max value.
left axis type	Specify the left axis type. It can be selected from "linear," "log10," and "log."
left axis divisions	Specify the number of divisions of the left scale. It can be selected "Hide," "Auto-select," and "2 to 23." For selection from "2 to 23," the axis scale is indicated in accordance with the number of divisions, only when both the min and max values are specified. If either or both of the min and max values have yet to be specified, "Auto-select" supersedes the selection of "2 to 23."
left axis magnification	Left data amplification can be specified.
left text size	Left text size can be specified.
left text color	Left text color can be specified.
left tick color	Left tick color can be specified.
left unit	Left unit can be specified.
right axis	
right axis min	Specify the min value for the right axis.
right axis max	Specify the max value for the right axis.
right axis type	Specify the right axis type. It can be selected from "linear," "log10," and "log."
right axis divisions	Specify the number of divisions of the right scale. It can be selected "Hide," "Auto-select," and "2 to 23." For selection from "2 to 23," the axis scale is indicated in accordance with the number of divisions, only when both the min and max values are specified. If either or both of the min and max values have yet to be specified, "Auto-select" supersedes the selection of "2 to 23."
right axis magnification	Right data amplification can be specified.
right text size	Right text size can be specified.
right text color	Right text color can be specified.
right tick color	Right tick color can be specified.
right unit	Right unit can be specified.

Setting item	Description
Log item	
Log data index	Specify the column in which the log file is stored in the range from 0 to 499.
Log data type	Specify the data format to be displayed on the graph. It can be selected from "First value," "Total value," "Mean value," and "Accumulated value."
label	Enter the string for the logging item.
yaxis	The axis for the logging item can be selected from "Left" and "Right."
display mode	The graph presentation can be selected from "Line," "Dot," "Line + dot," and "Bar/column."
line width	The line thickness for a line graph can be selected.
line color	The line color can be specified.
fill color	The fill color for a bar / column graph can be specified.
graph	
fill color	Background color can be specified.
grid border color	Grid border color can be specified.
grid fill color	Grid fill color can be specified.

■ List of errors

Code	Name	Description of error
01	Processing error	The refresh button was pressed before aggregation was completed.
02	Logging unregistered error	An unregistered log number was referred to.
03	Plot specification error	The data to be plotted is not present.
04	Aggregationitem error	An invalid data item number or invalid item count was set.
103	SD card not inserted, abnormality, or no log folder error	No SD card is inserted into FP7, or there is a abnormality in the SD card. Even though there is no problem in the SD card, an error is reported if there is the specified log folder is not present.
104	Excessive access to SD card error	There is excessive access to the SD card.
105	Aggregation timeout error	Refresh was not completed by the timeout time for aggregation timeout error.

3.5.7.2.11 Operation History

The operation history function stores the monitoring history of the FP7 internal device in the non-volatile memory of FP7, and displays it in the alarm history and Gantt chart part created by the Web Creator.

Use tool software (FPWIN GR7 or FPWIN Pro7) to make the configuration settings for FP7.

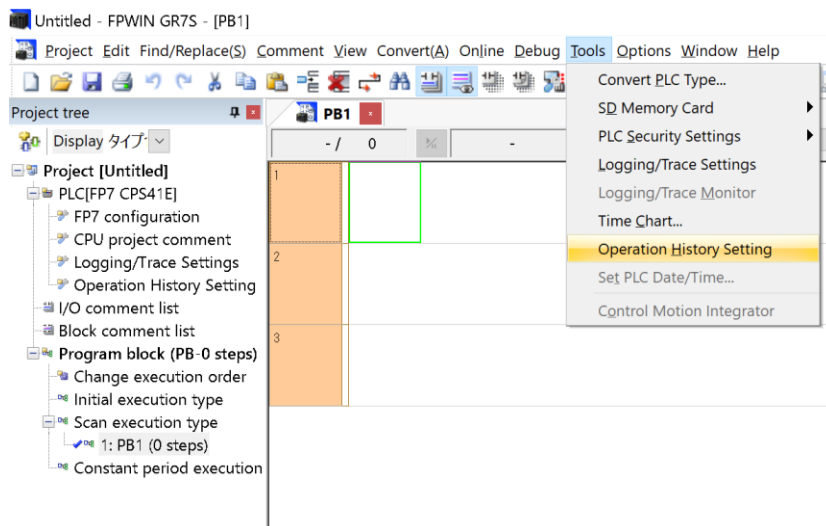

■ Target models

The operation history function is available only for the following FP7 CPU units with the Ethernet function.

AFP7CPS41E AFP7CPS41ES
AFP7CPS31E AFP7CPS31ES

■ Registration of configuration data

- The configuration data must be registered in FP7 to use the operation history function.
- The configuration data can be registered in PLC by the following three procedures.
 1. Download from the tool software
 2. When the power is ON during the SD card operation or when switching the mode from PROG to RUN
 3. When pressing the COPY switch

For the procedures 2 and 3, operation history files must be saved in the AUTO folder. To redefine an operation history buffer, stop the operation history function.

- Downloaded data is stored in the non-volatile memory in the PLC, and held until it is deleted or re-registered.

- The configuration data that is stored in the AUTO folder of an SD card by the tool software can also be automatically loaded and stored in the PLC when the power turns ON in the case of the SD card operation or when the mode is switched from PROG to RUN. [File name: ALMGNT.FP7]

Although it is transferred to and operated in the PLC internal RAM, the project data or operation history setting in the PLC internal ROM cannot be changed.



NOTE

Only the operation history setting file cannot be automatically loaded.

- The configuration data of operation history can also be loaded and stored by pressing the COPY switch after inserting the above-described SD card to the PLC.
The operation history setting file is copied to the PLC internal ROM and operated.



NOTE

When using the COPY switch, only the operation history setting file can be copied.

- Only one generation of the operation history configuration can be registered in the PLC.

■ **Precaution when downloading the operation history configuration data from PC or SD card**

Use the operation history setting created in a project to be executed.

The operation history setting created in a different project from the executed project may not be activated.

There is no problem when it is downloaded together with the project data, however, be careful when only the operation history setting is downloaded or copied from an SD card.

■ Setting items common to Alarm History and Gantt chart

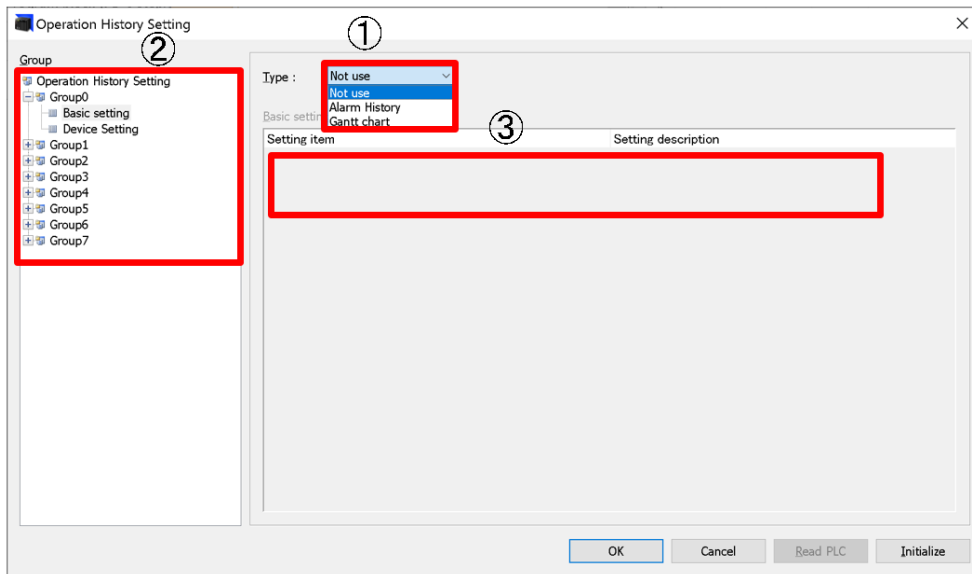

①	For the operation history function, select "Alarm History" or "Gantt chart".
②	Up to settings of eight groups for the alarm history and Gantt chart can be shared.
③	Up to 3000 histories can be recorded in 8 groups. They can be assigned freely to eight groups.

3.5.7.2.11.1 Alarm Function

The history can be recorded during the RUN only. It monitors the statuses of bit devices of the PLC and records them in the non-volatile memory within the FP7.

■ Start / Stop

It can be started/stopped in a group unit by the following three methods.
The histories at the time of the start/stop can also be saved.

• Configuration settings

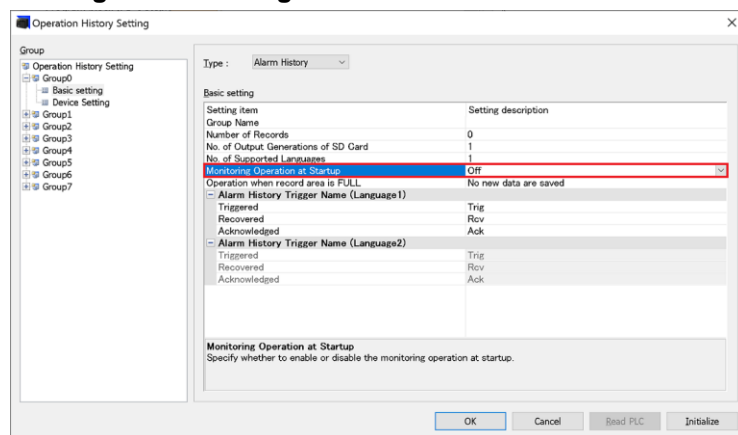

Setting item	Setting	Description
Monitoring Operation at Startup	Off	The monitoring operation is not automatically started when switching the mode to RUN.
	On	The monitoring operation is automatically started when switching the mode to RUN.

• Operation instructions

OPHST: Start the operation history function.
OPHED: Stop the operation history function.

• Command from a web browser

Display during stop

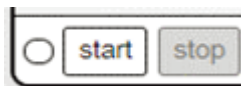

Display during start

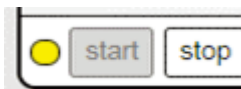

■ **Clearing histories**

Histories can be cleared in a group unit by the following three methods.

• **Operation instruction**

OPHCLR: Clear the operation history.

• **Command from a web browser**



■ **CSV output**

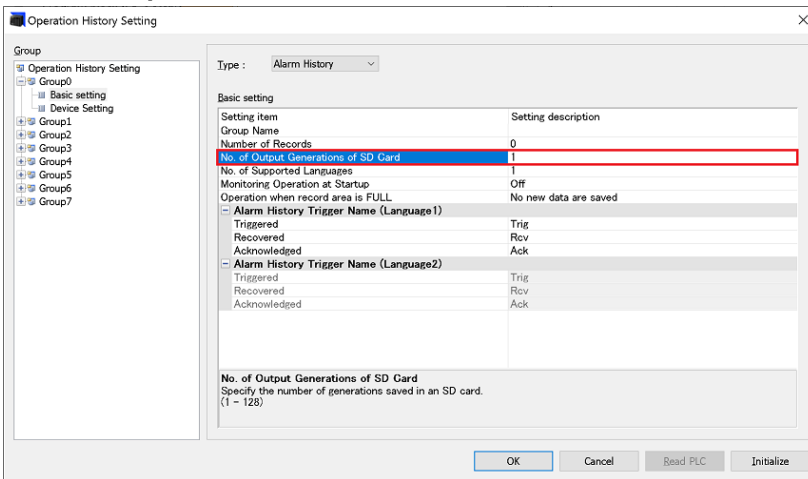

Setting item	Setting	Description
No. of Output Generations of SD Card	1 to 128	The number of generations of CSV to be output to an SD card is specified.

(Note): CSV files of the number of generations are created. When creating files more than the limit of the number of generations, the oldest file is deleted after the determination of the latest file.

CSV files can be saved by the following method.

- Recorded data of the alarm history is saved in an SD card in the CSV format for each group using the operation instruction.
OPHSAVE: Save the operation history in CSV.
- By pressing a CSV output button arranged on an alarm history part, CSV files can be saved on a device such as a PC on which a web browser is loaded. For outputting CSV files when the manual update is set, perform the CSV output after pressing the manual update button. Only the history data displayed on the screen is output in the CSV format.

■ Switching character strings

Up to two patterns of message character strings can be registered for FPWIN GR7 or FPWIN Pro7.

Registered character strings can be switched on a web part.

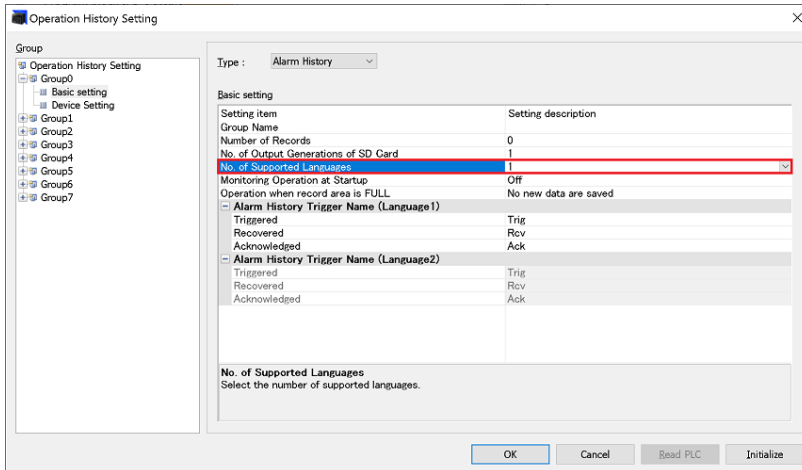

Setting item	Setting	Description
No. of Supported Languages	1 to 2	The number of supported languages is specified.

■ When memory is full

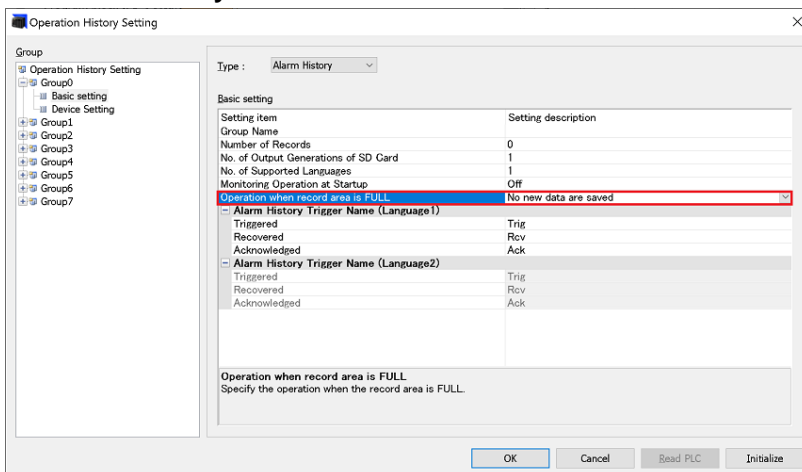

Setting item	Setting	Description
Operation when record area is FULL	No new data are saved	When the record area is full, the recording stops.
	Save new data, delete last data	When the record area is full, older data are sequentially overwritten and the recording continues.

Up to 512 bit devices can be registered per group.
Message character strings can be specified for each bit device. (Up to 32 bytes)

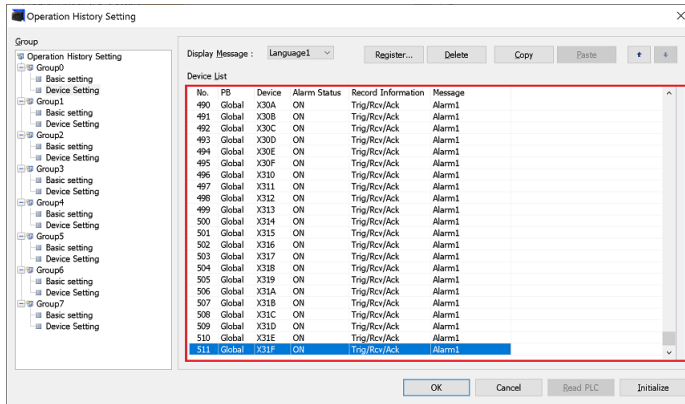

Only the data saved in the non-volatile memory within the FP7 can be displayed on alarm history parts. CSV file data cannot be displayed.

Output codes vary according to the output method as follows.

- CSV that is output by the operation instruction: ASCII or SHIFT-JIS
- CSV that is output on a browser: UTF-8

■ Monitoring

• Specifying devices

Individual devices can be registered as well as the Logging Settings. Consecutive devices can also be registered.

Example 1) No. of continuous registrations (Specify a starting device and the number of continuous registrations)

Alarm No.0	R0
Alarm No.1	R1
⋮	⋮
Alarm No.511	R511

Register devices ✕

Global devices OK

Local devices Cancel

Slot No.:

Device type:

No.: (0-2047F)

Data type:

Number of continuous registrations: (1-512)

Operation History Setting

Message (32 characters)

Language1:

Language2:

Alarm Status:

Record Information: Triggered

Recovered

Acknowledged

No.	PB	Device	Alarm Status	Record Information	Message
0	Global	R0	ON	Trig/Rcv/Ack	Alarm1
1	Global	R1	ON	Trig/Rcv/Ack	Alarm1
2	Global	R2	ON	Trig/Rcv/Ack	Alarm1
3	Global	R3	ON	Trig/Rcv/Ack	Alarm1
4	Global	R4	ON	Trig/Rcv/Ack	Alarm1
5	Global	R5	ON	Trig/Rcv/Ack	Alarm1
6	Global	R6	ON	Trig/Rcv/Ack	Alarm1
7	Global	R7	ON	Trig/Rcv/Ack	Alarm1
8	Global	R8	ON	Trig/Rcv/Ack	Alarm1
9	Global	R9	ON	Trig/Rcv/Ack	Alarm1
10	Global	R315	ON	Trig/Rcv/Ack	Alarm1
503	Global	R317	ON	Trig/Rcv/Ack	Alarm1
504	Global	R318	ON	Trig/Rcv/Ack	Alarm1
505	Global	R319	ON	Trig/Rcv/Ack	Alarm1
506	Global	R31A	ON	Trig/Rcv/Ack	Alarm1
507	Global	R31B	ON	Trig/Rcv/Ack	Alarm1
508	Global	R31C	ON	Trig/Rcv/Ack	Alarm1
509	Global	R31D	ON	Trig/Rcv/Ack	Alarm1
510	Global	R31E	ON	Trig/Rcv/Ack	Alarm1
511	Global	R31F	ON	Trig/Rcv/Ack	Alarm1

Example 2) Individual registration

Alarm No.0 R0
 Alarm No.1 X10
 ⋮
 Alarm No.511 Y100

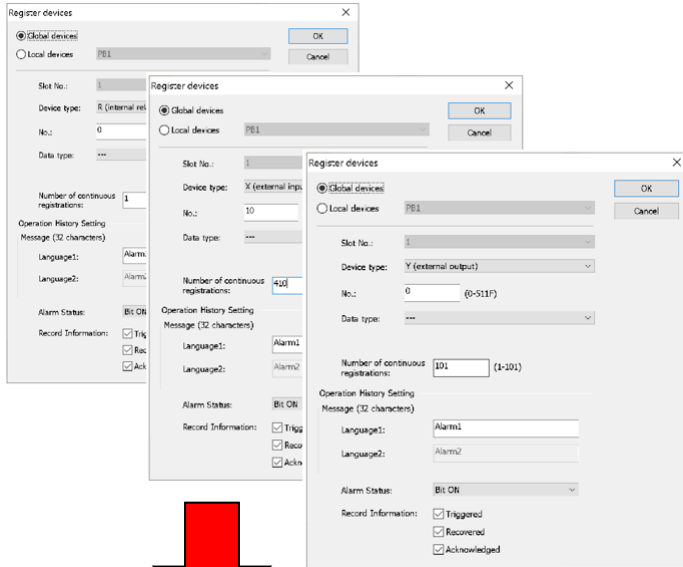

Device List

No.	PB	Device	Alarm Status	Record Information	Message
0	Global	R0	ON	Trig/Rcv/Ack	Alarm1
1	Global	X10	ON	Trig/Rcv/Ack	Alarm1
2	Global	X11	ON	Trig/Rcv/Ack	Alarm1
3	Global	X12	ON	Trig/Rcv/Ack	Alarm1
4	Global	X13	ON	Trig/Rcv/Ack	Alarm1
5	Global	X14	ON	Trig/Rcv/Ack	Alarm1
6	Global	X15	ON	Trig/Rcv/Ack	Alarm1
7	Global	X16	ON	Trig/Rcv/Ack	Alarm1
8	Global	X17	ON	Trig/Rcv/Ack	Alarm1
9	Global	X18	ON	Trig/Rcv/Ack	Alarm1
10	Global	X19	ON	Trig/Rcv/Ack	Alarm1
11	Global	X1A	ON	Trig/Rcv/Ack	Alarm1
12	Global	X1B	ON	Trig/Rcv/Ack	Alarm1
100	Global	Y59	ON	Trig/Rcv/Ack	Alarm1
501	Global	Y5A	ON	Trig/Rcv/Ack	Alarm1
502	Global	Y5B	ON	Trig/Rcv/Ack	Alarm1
503	Global	Y5C	ON	Trig/Rcv/Ack	Alarm1
504	Global	Y5D	ON	Trig/Rcv/Ack	Alarm1
505	Global	Y5E	ON	Trig/Rcv/Ack	Alarm1
506	Global	Y5F	ON	Trig/Rcv/Ack	Alarm1
507	Global	Y60	ON	Trig/Rcv/Ack	Alarm1
508	Global	Y61	ON	Trig/Rcv/Ack	Alarm1
509	Global	Y62	ON	Trig/Rcv/Ack	Alarm1
510	Global	Y63	ON	Trig/Rcv/Ack	Alarm1
511	Global	Y64	ON	Trig/Rcv/Ack	Alarm1

•Alarm status

Select the bit status to monitor.

When the bit is in the specified alarm status, "Trig" of the record information is recorded in the internal memory.

Monitored bit status	Description
ON	When the bit changes from OFF to ON, "Trig" is recorded.
	When the bit is ON when the power is turned ON, "Trig" is recorded.
OFF	When the bit changes from ON to OFF, "Trig" is recorded.
	When the bit is OFF when the power is turned ON, "Trig" is recorded.
OFF→ON	When the bit changes from OFF to ON, "Trig" is recorded.
	When the bit is ON when the power is turned ON, "Trig" is not recorded.
ON→OFF	When the bit changes from ON to OFF, "Trig" is recorded.
	When the bit is OFF when the power is turned ON, "Trig" is not recorded.

When the active alarm list is displayed, the operation varies according to the selection of the above alarm statuses as follows. (The status of the monitored bit is displayed in real time.)

- When selecting ON or OFF→ON, when the monitored bit is ON, the status is displayed in the active alarm list. When it is OFF, it is not displayed in the list.
- When selecting OFF or ON→OFF, when the monitored bit is OFF, the status is displayed in the active alarm list. When it is ON, it is not displayed in the list.

When the operation history monitoring stops, the FP7 returns information that active alarm is 0.

■ Record

•Recordable max. number

The maximum number of recordable statuses is 3000 for 8 groups. When 3000 records are used for 1 group, no alarm can be set for the other groups.

•Record information

Status of a recorded alarm

Trig	It shows a bit is in a specified alarm status.
Rcv	It shows the status of a bit changes from a specified alarm status to a non-alarm status.
Ack	It shows a confirmation operation was performed on the screen.

■ **Types of alarm parts**

Click "Widgets Add to page" from the tool bar at the bottom of the screen, open the parts selection menu, and select Alarm History.

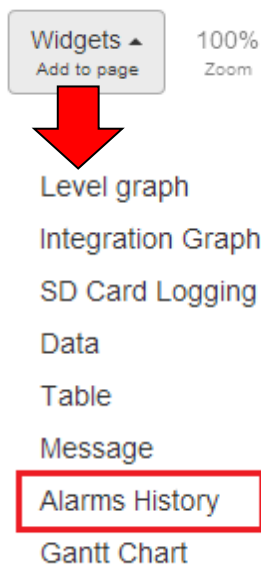

Select a representative design of a new "alarm" part.

(1) Time order

The alarm status of a PLC device is saved in the PLC internal memory, and data is displayed in chronological order.

CHRONOLOGICAL ORDER					
	Date	Time	Event	No	Message
<input type="checkbox"/>	2000/08/21	18:08:24	Trig	No.1	Alarm1
<input type="checkbox"/>	2000/08/21	18:08:25	Rcv	No.1	Alarm1
<input type="checkbox"/>	2000/08/21	18:08:26	Trig	No.2	Alarm1
<input type="checkbox"/>	2000/08/21	18:08:27	Trig	No.0	Alarm1
<input type="checkbox"/>	2000/08/21	18:08:30	Trig	No.3	Alarm1
<input type="checkbox"/>	2000/08/21	18:08:32	Rcv	No.0	Alarm1
<input type="checkbox"/>	2000/08/21	18:08:33	Rcv	No.3	Alarm1
<input type="checkbox"/>	2000/08/21	18:08:33	Rcv	No.2	Alarm1

start
 stop
 refresh
 ack
 delete
 csv
 clear
 ENG ▼

(2) Active alarm list

Alarm messages in a specified alarm status are displayed. The alarms currently occur can be confirmed.

PROGRESS ORDER	
No	Message
No.1	AlarmGI-01
No.2	AlarmGI-02
No.27	AlarmGI-27

start
 stop
 refresh
 clear
 ENG ▼

(3) Frequency order

The number of "Trig" in accumulated data is displayed for each alarm number in descending order of the number of "Trig".

The alarms that are currently output are counted. (The past alarms that are not output are not counted.)

FREQUENCY ORDER		
No	Message	Count
No.13	AlarmGI-13	1
No.3	AlarmGI-03	2
No.0	AlarmGI-00	2
No.1	AlarmGI-01	3
No.2	AlarmGI-02	3
No.23	AlarmGI-23	7

start
 stop
 refresh
 clear
 ENG ▼

■ **Setting method of alarm history part**

[Common settings]

horizontal position	<input type="text" value="207"/>
vertical position	<input type="text" value="116"/>
width	<input type="text" value="400"/>
height	<input type="text" value="240"/>
label	<input type="text" value="ah1"/>
security level	<input type="text" value="0"/>

Setting item	Options of values	Default	Description of setting item
horizontal position	Position from the top end of the screen	The first position where a part is arranged	Specify a position from the top end of the screen.
vertical position	Position from the left end of the screen	The first position where a part is arranged	Specify a position from the left end of the screen.
width	Width of a part.	400	Specify the width of a part.
height	Height of a part.	240	Specify the height of a part.
label	ahx	The value of x increases every time a part is arranged.	Specify a part name.
security level	0 to 15	0	Specify the security level of a part.

[Group settings]

host address	<input type="text" value="Global settings"/>
network protocol	<input type="text" value="Global settings"/>
group number	<input type="text" value="0"/>

Setting item	Options of values	Default	Description of setting item
host address	IP address	Global settings	Specify the IP address of the FP7 that data is acquired.
network protocol	Global settings/m7	Global settings	Specify a protocol for acquiring data.
group number	0 to 7	0	Specify a group number to be monitored for the alarm history.

[Alarm settings]

alarm details

1 Edit → Alarm Details

trg. text color: yellow
 trg. background color: red
 rcv. text color: black
 rcv. background color: orange
 ack. text color: black
 ack. background color: white

Setting item	Options of values	Default	Description of setting item
alarm details	Edit	Edit	Specify an operation setting for each alarm number. (0 to 511 can be set.)
text color	Color setting	No setting	Specify the color of characters displayed when an arbitrarily set operation occurs.
background color	Color setting	No setting	Specify the color of a background displayed when an arbitrarily set operation occurs.
Operation settings	Bit set/Word set/Digital set/Page switch/Audio playback/HTTP GET/HTTP POST	No setting	Set an operation when an arbitrary alarm number is ON.
trg. text color	Color setting/Transparent	yellow	Specify the color of characters displayed when a trigger condition is met.
trg. background color	Color setting/Transparent	red	Specify the color of a background displayed when a trigger condition is met.
rcv. text color	Color setting/Transparent	black	Specify the color of characters displayed when an alarm is recovered.
rcv. background color	Color setting/Transparent	orange	Specify the color of a background displayed when an alarm is recovered.
ack. text color	Color setting/Transparent	black	Specify the color of characters when an alarm is confirmed.
ack. background color	Color setting/Transparent	white	Specify the color of a background when an alarm is confirmed.

Alarm Details

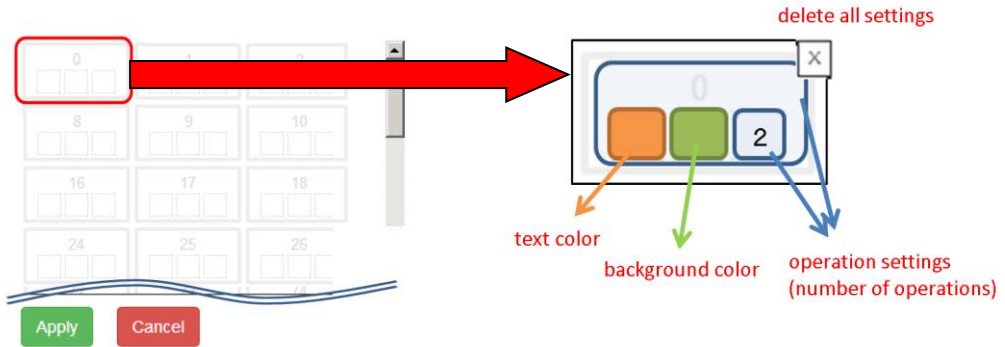

The font color, background color, and screen switching can be set for each alarm. The UI changes according to the settings as follows.

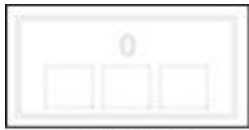

Unset

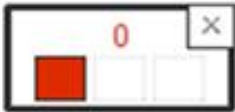

After text color setting



After background color setting



After operation setting



After text color & background color settings



After background color & operation settings

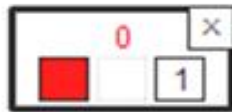

After text color & operation settings



After text color & background color & operation settings

Example of screen switching



◆ PROCEDURE

1. Specify a background color and a font color for a target alarm number.

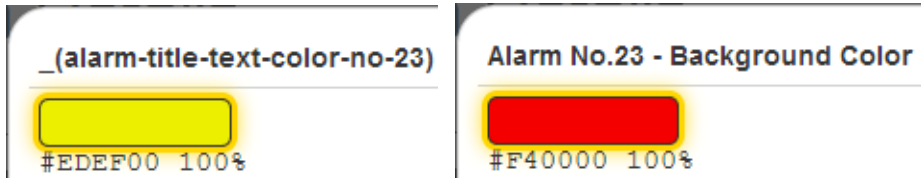

2. Specify an operation for a target alarm number.

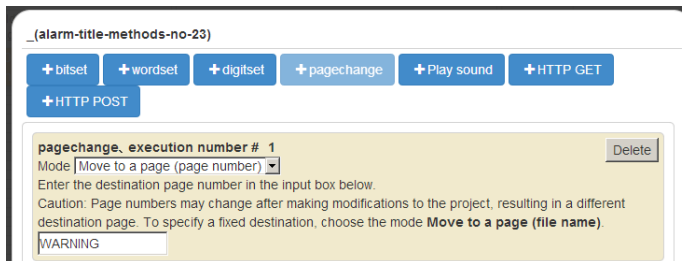

3. By pressing the target alarm number displayed when the operation is performed, the screen is switched or a specific device turns ON/OFF according to the operation setting specified in the step 2.

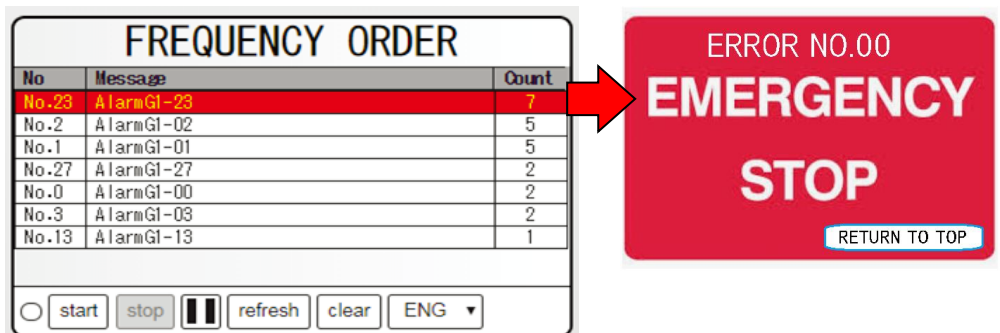

[Operation mode]

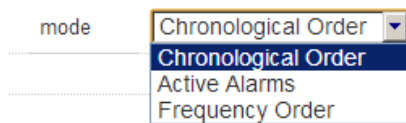

Setting item	Options of values	Default	Description of setting item
Mode	Chronological Order / Active Alarms / Frequency Order	Chronological Order	Specify the operation of the alarm history.

[Display order setting]

display order

Setting item	Options of values	Default	Description of setting item
display order	Ascending / Descending	Ascending	Specify the display order when alarms occur.

- Mode: Chronological Order
 - Ascending: Sorts the display in the ascending order of the time of occurrence. (A new alarm is added at the bottom.)
 - Descending: Sorts the display in the descending order of the time of occurrence. (A new alarm is added at the top.)
- Mode: Active Alarms
 - Ascending: Sorts the display in the ascending order of active alarm numbers.
 - Descending: Sorts the display in the descending order of active alarm numbers.
- Mode: Frequency Order
 - Ascending: Sorts the display in the ascending order of the number of times of occurrence.
 - Descending: Sorts the number of times of occurrence is in descending order.

[Language setting]

language count

language menu

initial language no.

language no.0

language no.1

Setting item	Options of values	Default	Description of setting item
language count	1/2	1	Specify the number of displayed languages. (Up to two languages can be registered.)
language menu	show/hide	show	Specify whether to show or hide the language change switch. (This is settable only when the number of displayed languages is two.)
initial language no.	0/1	0	Specify a language number that is displayed when the browser is started. (This is settable only when the number of displayed languages is two.)
language no. 0	Character input	Lang.#0	Input a displayed language.
language no. 1	Character input	Lang.#1	Input a displayed language. (This is settable only when the number of displayed languages is two.)

[Refresh mode]

refresh mode

Automatic

Manual

Setting item	Options of values	Default	Description of setting item
refresh mode	Automatic / Manual	Manual	Specify a timing to update alarm history parts. (In the case of Automatic, a button to control the update is added.)

Automatic: Detects the update of the alarm history automatically and acquires the history.

Manual: Acquires the history only when the Refresh button is pressed.

[Operation button]

text size

[start] visibility

[stop] visibility

[refresh] visibility

[ack.] visibility

[delete] visibility

[CSV] visibility

[clear history] visibility

Setting tem	Options of values	Default	Description of setting item
text size	Default (14px) / 8 to 100px	Default (14px)	Specify the character size of Operation button.
[start] visibility	Visible/Hidden	Visible	Specify whether to show or hide the start button. Operation: Starts the alarm history.
[stop] visibility	Visible/Hidden	Visible	Specify whether to show or hide the stop button. Operation: Stops the alarm history.
[refresh] visibility	Visible/Hidden	Visible	Specify whether to show or hide the refresh button. Operation: Refreshes the display of the alarm history.
[ack.] visibility	Visible/Hidden	Visible	Specify whether to show or hide the ack. button. Operation: Confirms the alarm history.
[delete] visibility	Visible/Hidden	Visible	Specify whether to show or hide the delete button. Operation: Deletes the alarm history.
[CSV] visibility	Visible/Hidden	Visible	Specify whether to show or hide the csv button. Operation: Outputs the alarm history to a CSV file.
[clear history] visibility	Visible/Hidden	Visible	Specify whether to show or hide the clear history button. Operation: Delete the alarm history of a displayed group.

[start] label	<input type="text" value="start"/>
[stop] label	<input type="text" value="stop"/>
[refresh] label	<input type="text" value="refresh"/>
[ack.] label	<input type="text" value="ack"/>
[delete] label	<input type="text" value="delete"/>
[CSV] label	<input type="text" value="csv"/>
[clear history] label	<input type="text" value="clear"/>

Setting item	Options of values	Default	Description of setting item
[start] label	Character input	start	Input a displayed name of the start button.
[stop] label	Character input	stop	Input a displayed name of the stop button.
[refresh] label	Character input	refresh	Input a displayed name of the refresh button.
[ack.] label	Character input	ack	Input a displayed name of the ack. button.
[delete] label	Character input	delete	Input a displayed name of the delete button.
[CSV] label	Character input	csv	Input a displayed name of the CSV button.
[clear history] label	Character input	clear	Input a displayed name of the clear history button.

[CSV settings]

The setting for the header of a CSV file to which the alarm history is output. They can be set for each language.

- The CSV setting #1 can be set when the number of the displayed languages is two.
- The initial values and settable items for #0 and #1 are the same.

date header #1	<input type="text" value="Date"/>
time header #1	<input type="text" value="Time"/>
event header #1	<input type="text" value="Event"/>
alarm no. header #1	<input type="text" value="No"/>
message header #1	<input type="text" value="Message"/>



Setting item	Options of values	Default	Description of setting item
date header #	Character input	Date	Input a displayed name of the date header.
time header #	Character input	Time	Input a displayed name of the time header.
event header #	Character input	Event	Input a displayed name of the event header.
alarm no. header #	Character input	No	Input a displayed name of the alarm no. header.
message header #	Character input	Message	Input a displayed name of the message header.



Date	Time	Event	Alarm No.	Message
2019/6/12	14:42:03	Ack_G1	Acknowledged	14 AlarmG1 -14
2019/6/12	14:41:59	Ack_G1	Acknowledged	12 AlarmG1 -12
2019/6/12	14:41:55	TrigG1		22 AlarmG1 -22
2019/6/12	14:41:54	TrigG1		23 AlarmG1 -23
2019/6/12	14:41:54	TrigG1		14 AlarmG1 -14
2019/6/12	14:41:52	TrigG1		12 AlarmG1 -12



[Frame format]

Frame can be deleted by pressing the "disable frame" button.

☐ frame format

⚙ fill color  

border style  

⚙ border color  

border radius 

border width 

Setting item	Options of values	Default	Description of setting item
fill color	Color setting/Transparent	white	Specify the background color of the area where a title of an alarm history part is input.
border style	none/solid/dashed/dotted/double/groove/ridge/inset/outset		Specify the style of the frame of an alarm history part.
border color	Color setting/Transparent	black	Specify the color of the frame of an alarm history part.
border radius	0 to 16/18/20/24/28/32/36/40/44/48/54/60/66/72/80/88/96/100px	10px	Specify the rounded corners of the frame of an alarm history part. The smaller the value is, the nearer the corner angle approaches a right angle.
border width	Hide/1 to 16/18/20/24/28/32/36/40/44/48/54/60/66/72/80/88/96/100px	2px	Specify the width of the frame of an alarm history part.

● Example of frame setting

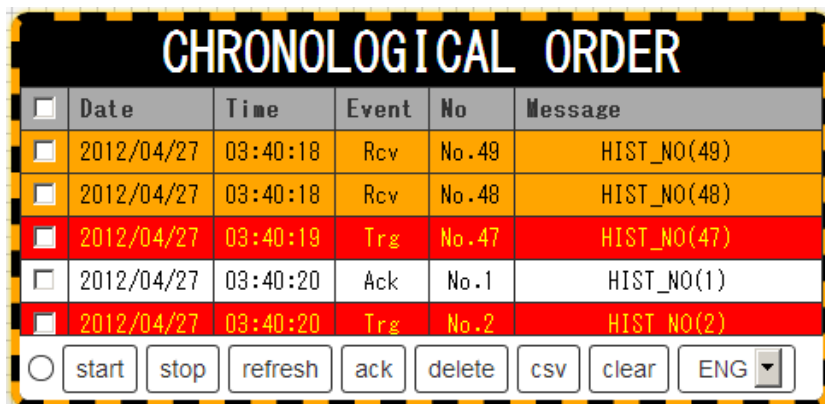

[Title]

text

alignment

color

title size

title font

Setting item	Options of values	Default	Description of setting item
text	Character input	No setting	Input a title of an alarm history part. (The input text is displayed on the upper part of the part.)
alignment	left/center/right/justify	center	Specify the position of the title.
color	Color setting	black	Specify the text color of the title.
title size	8 to 16/18/20/24/28/32/36/40/44/48/54/60/66/72/80/88/96/100px/ Set arbitrarily	32px	Specify the character size of the title.
title font	MS Gothic/Digital/Led/Pixels/Retro/ MS PGothic/Meiryō/Georgia/Palatino Linotype/Times New Roman/ Arial/Arial Black/Comis Sans MS/Impact/Lucida Sans Unicode/ Tahoma/Trebuchet MS/Verdana/ Courier New/Lucida Console	MS Gothic	Specify the character font of the title.

[Text format]

The text format for the column of an alarm history part is set.

alignment  center ▼

decoration italic bold

text size ▼

text font ▼

Setting item	Options of values	Default	Description of setting item
alignment	left/center/right/justify	center	Specify the position of the column.
decoration	italic/bold	No setting	Specify the style of the text of the column.
text size	8 to 16/18/20/24/28/32/36/40/44/48/ 54/60/66/72/80/88/96/100px/ Set arbitrarily	14px	Specify the character size of the column.
text font	MS Gothic/Digital/Led/Pixels/Retro/ MS PGothic/Meiryo/Georgia/ Palatino Linotype/Times New Roman/Arial/Arial Black/Comis Sans MS/Impact/Lucida Sans Unicode/Tahoma/Trebuchet MS/ Verdana/Courier New/Lucida Console	MS Gothic	Specify the character font of the column.

■ **Browser screen**



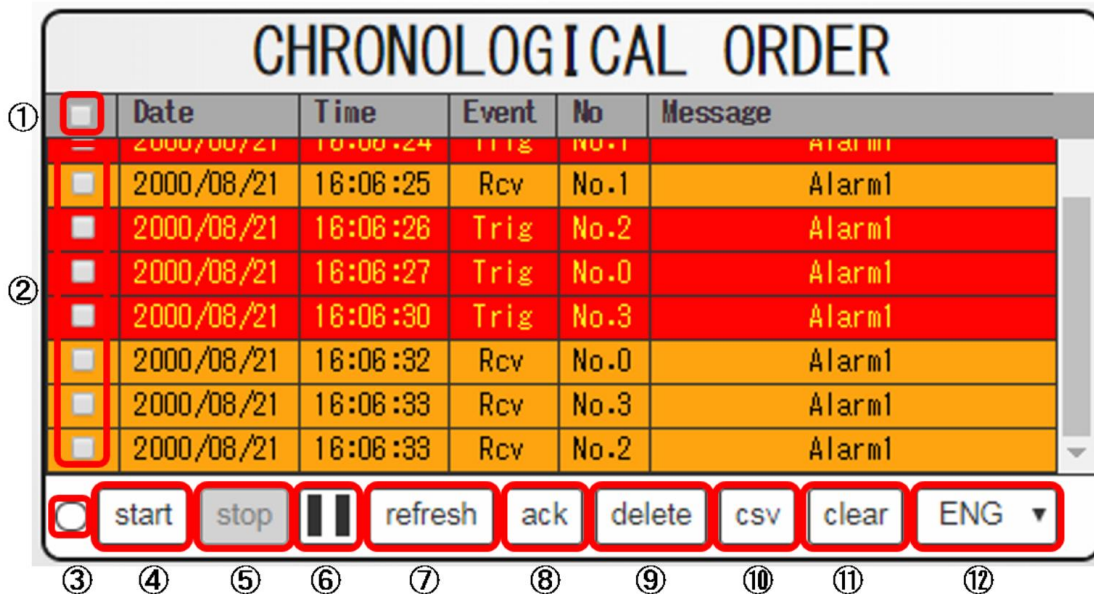



● **Time order**

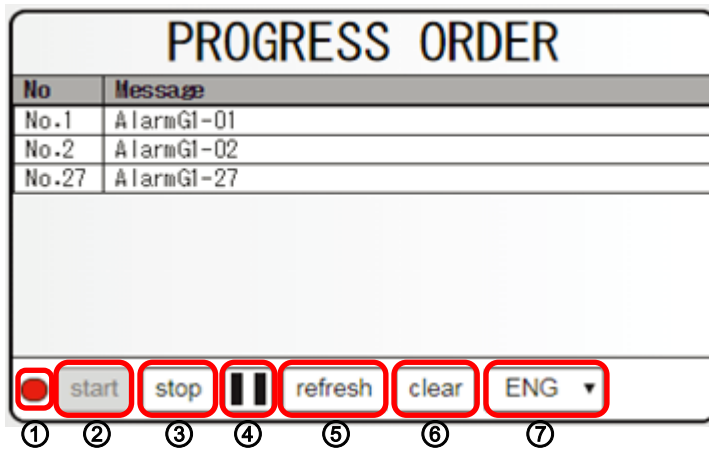

No.	Description			
①	Pressing this checkbox selects all checkboxes.			
②	When selecting a checkbox, only Ack and Delete are referred, and the acknowledgment or delete is performed for the checked item.			
③	It indicates the status of the start/stop of the alarm history.			
④	"start" starts the alarm history.			
⑤	"stop" stops the alarm history.			
⑥	It indicates the current update status when selecting the automatic update.			
	<table border="1"> <tr> <td></td> <td>Automatic update in progress</td> </tr> <tr> <td></td> <td>Automatic update stops</td> </tr> </table>		Automatic update in progress	
	Automatic update in progress			
	Automatic update stops			
⑦	"refresh" updates the display of the alarm history.			
⑧	"ack" sends the acknowledgment notice of the alarm history to FP7.			
⑨	"delete" deletes the alarm histories of the selected checkboxes.			
⑩	"csv" outputs the alarm history information to a csv file.			
⑪	"clear" deletes all alarm histories of the displayed group.			
⑫	The language can be changed during the execution of the alarm history.			

● Active alarm list



No.	Description			
①	It indicates the status of the start/stop of the alarm history.			
②	"start" starts the alarm history.			
③	"stop" stops the alarm history.			
④	It indicates the current update status when selecting the automatic update.			
	<table border="1"> <tr> <td></td> <td>Automatic update in progress</td> </tr> <tr> <td></td> <td>Automatic update stops</td> </tr> </table>		Automatic update in progress	
	Automatic update in progress			
	Automatic update stops			
⑤	"refresh" updates the display of the alarm history.			
⑥	"clear" deletes all alarm histories of the displayed group.			
⑦	The language can be changed during the execution of the alarm history.			

● Frequency order

FREQUENCY ORDER

No	Message	Count
No.13	AlarmG1-13	1
No.3	AlarmG1-03	2
No.0	AlarmG1-00	2
No.1	AlarmG1-01	3
No.2	AlarmG1-02	3
No.23	AlarmG1-23	7

start

stop

refresh

clear

ENG ▼

①
②
③
④
⑤
⑥
⑦

No.	Description			
①	It indicates the status of the start/stop of the alarm history.			
②	"start" starts the alarm history.			
③	"stop" stops the alarm history.			
④	It indicates the current update status when selecting the automatic update.			
	<table border="1" style="width: 100%; border-collapse: collapse;"> <tr> <td style="width: 30px; text-align: center;"></td> <td>Automatic update in progress</td> </tr> <tr> <td style="text-align: center;"></td> <td>Automatic update stops</td> </tr> </table>		Automatic update in progress	
	Automatic update in progress			
	Automatic update stops			
⑤	"refresh" updates the display of the alarm history.			
⑥	"clear" deletes all alarm histories of the displayed group.			
⑦	The language can be changed during the execution of the alarm history.			

■ List of errors

Code	Name	Description of error
41	Format error	Command in a different format was received.
42	Not-support error	The command not supported by the source or destination node was transmitted.
60	Parameter error	Specified parameter does not exist, or cannot be used.
61	Data error	There is an error in the contact, data area, data number, size, range or format specification.
63	PROG. error	Operation history parts cannot be operated in PROG.
71	Exclusive control error	Executed a command that cannot be processed simultaneously with the command already in process.
98	Operation history active error	Active operation history group exists.

3.5.7.2.11.2 Gantt Chart Function

The history can be recorded during the RUN only. It monitors the statuses of bit devices of the PLC and records them in the non-volatile memory within the FP7.

When even one of the bit devices registered in a group changes, the values and date information of all the registered monitoring devices are recorded.

■ Start / Stop

It can be started/stopped in a group unit by the following three methods. The histories at the time of the start/stop can also be saved.

• Configuration settings

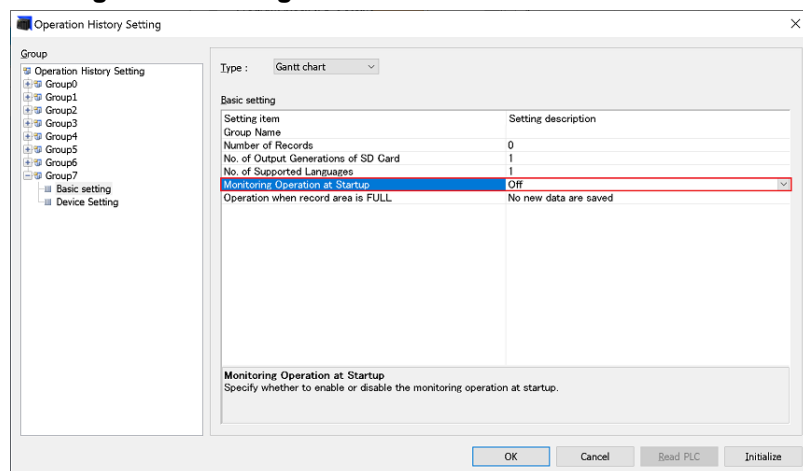

Setting item	Setting	Description
Monitoring Operation at Startup	Off	The monitoring operation is not automatically started when switching the mode to RUN.
	On	The monitoring operation is automatically started when switching the mode to RUN.

• Operation instructions

OPHST: Start the operation history function.

OPHED: Stop the operation history function.

• Command from a web browser

Display during stop



Display during start



■ **Clearing histories**

Histories can be cleared in a group unit by the following three methods.

• **Operation instruction**

OPHCLR: Clear the operation history.

• **Command from a web browser**



■ **CSV output**

Only the data saved in the non-volatile memory within the FP7 can be displayed on Gantt chart parts. CSV file data cannot be displayed.

- CSV that is output by the operation instruction: ASCII or SHIFT-JIS
- CSV that is output on a browser: UTF-8

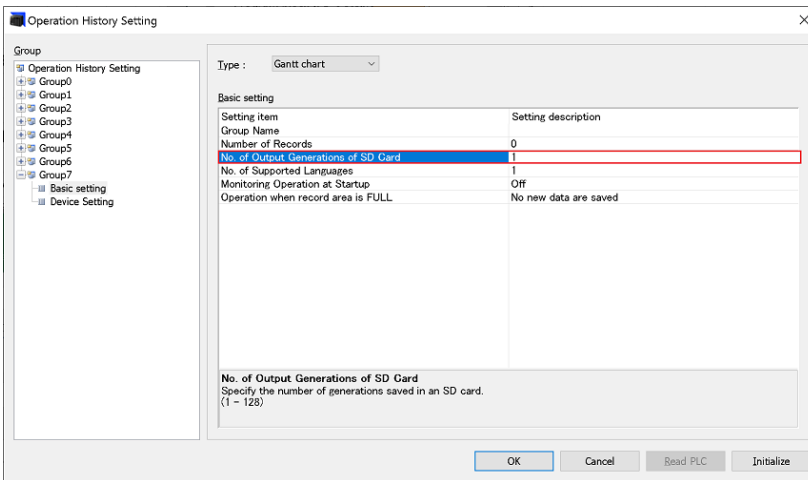

Setting item	Setting	Description
No. of Output Generations of SD Card	1 to 128	The number of generations of CSV to be output to an SD card is specified.

(Note): CSV files of the number of generations are created. When creating files more than the limit of the number of generations, the oldest file is deleted after the determination of the latest file.

CSV files can be saved by the following method.

- Recorded data of the Gantt chart is saved in an SD card in the CSV format for each group using the operation instruction.
OPHSAVE: Save the operation history in CSV.
- By pressing a CSV output button arranged on a Gantt chart part, CSV files can be saved on a device such as a PC on which a web browser is loaded. For outputting CSV files when the manual update is set, perform the CSV output after pressing the manual update button. Only the history data displayed on the screen is output in the CSV format.

■ Switching character strings

Up to two patterns of message character strings can be registered for FPWIN GR7 or FPWIN Pro7.

Registered character strings can be switched on a web part.

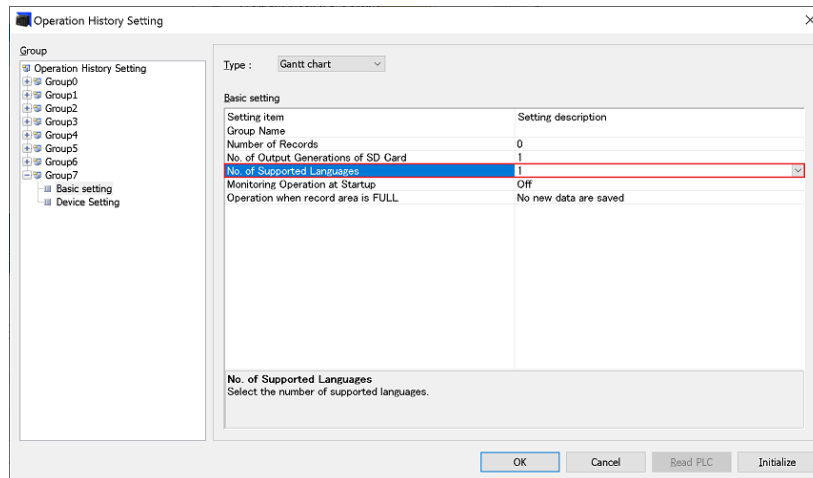

Setting item	Setting	Description
No. of Supported Languages	1 to 2	The number of supported languages is specified.

■ When Memory is Full

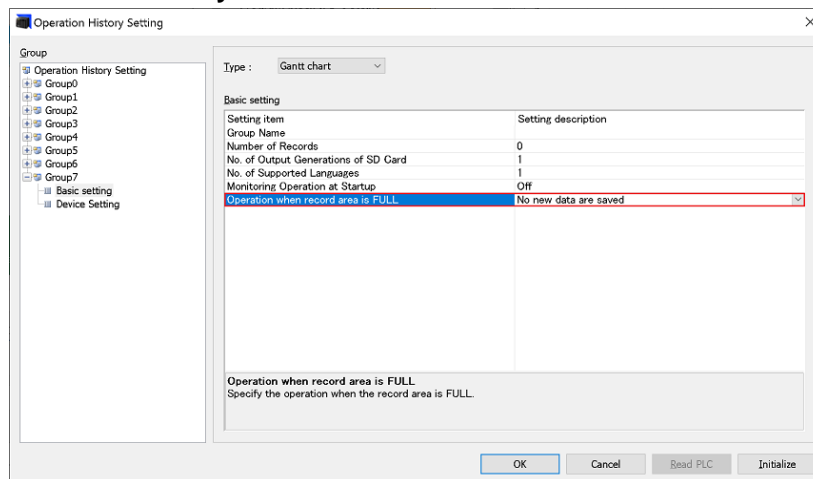

Setting item	Setting	Description
Operation when record area is FULL	No new data are saved	When the record area is full, the recording stops.
	Save new data, delete last data	When the record area is full, older data are sequentially overwritten and the recording continues.

Up to 16 bit devices can be registered per group.
Message character strings can be specified for each bit device. (Up to 32 bytes)

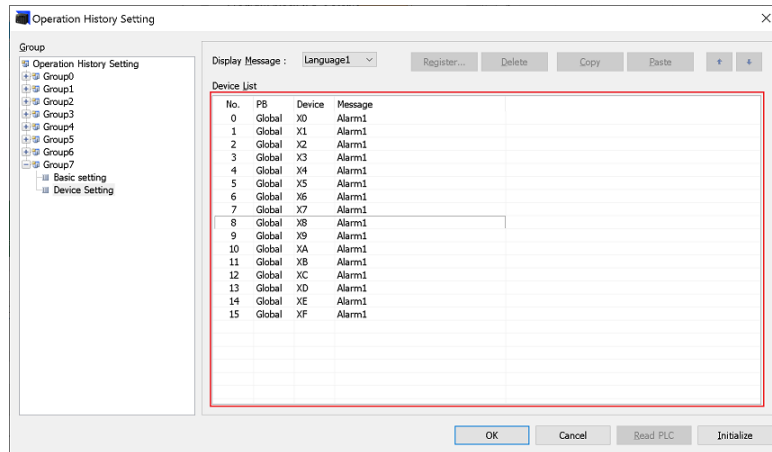

■ Gantt Chart display

Click "Widgets Add to page" from the tool bar at the bottom of the screen, open the parts selection menu, and select Gantt Chart.

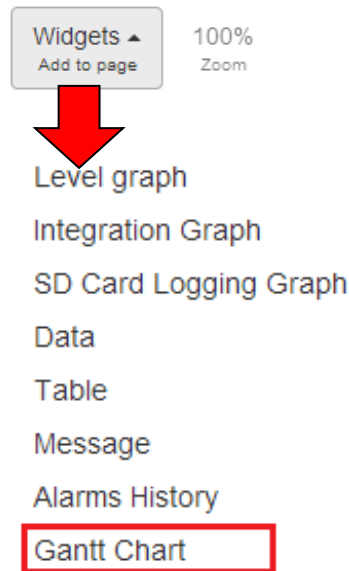

■ Example of display

• One-day view

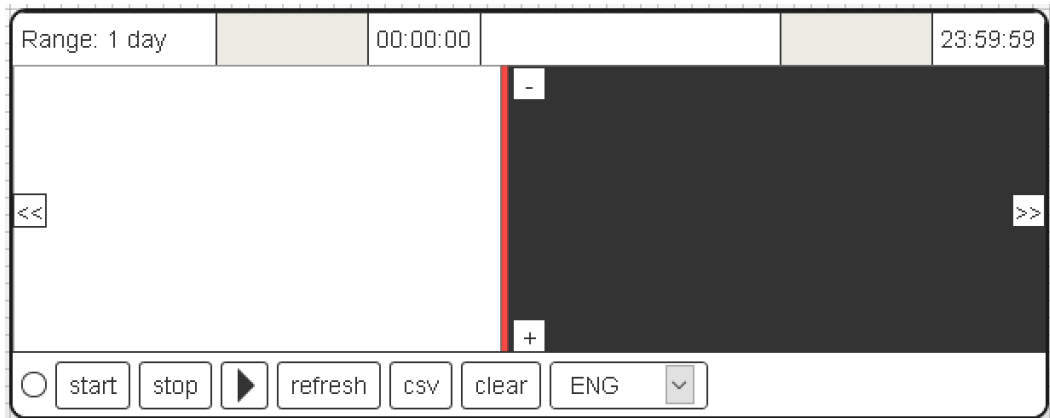

• One-month view

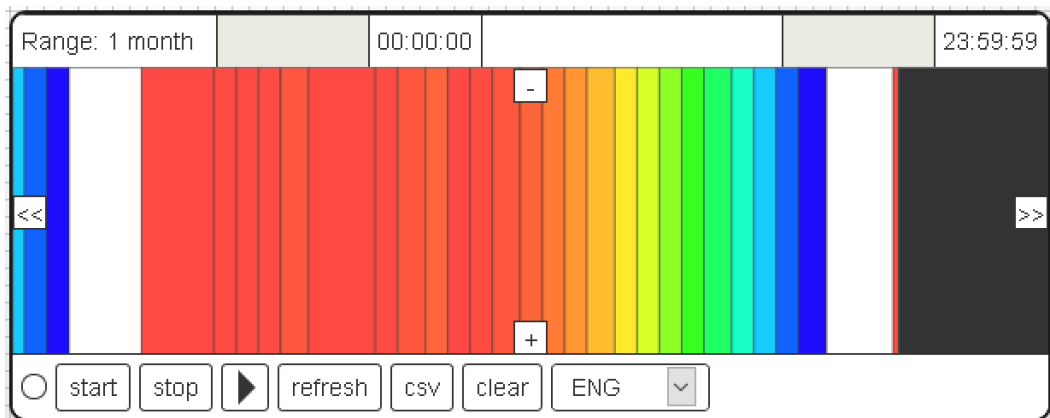

• One-year view



- The horizontal axis is time. One day, one month, and one year can be set. Each start and stop can be set for day, month, and year.
For day: Start time and end time
For month: Start date and end date
For year: Start month and end month
- Displayed date and time can be specified. If not specified, the range including the current time is displayed.
* The current time is acquired from the PLC not PC.
- When the current time is within the displayed time range, the display is up to the current time.
- The setting for the number of divisions of the scale of the time axis can be selected from Automatic and Manual. In the case of the manual setting, the number of divisions can be specified between 2 to 30.
- The record area for each group can be deleted.

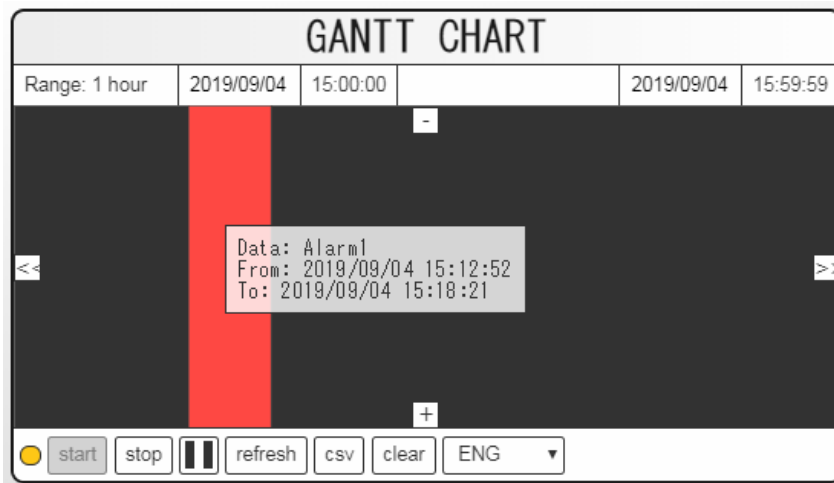



- Refreshing the display
A timing to refresh the display can be selected from "Automatic" and "Manual".
Automatic: Automatically refreshes the display of the Gantt chart history.
Manual: Refreshes the display of the Gantt chart history only when the refresh button is pressed.









■ Display colors of data

- The priority order of monitored devices for each group can be set. When multiple bits are ON, colors corresponding to the priority order of monitored devices are displayed. The priority order is from high to low in the order registered by FPWIN GR7 (0 to 15).
* A color when all target devices are OFF can also be set.

ex) As follow, the display colors are registred.

[priority 0]R0:Emergency stop 
 [priority 1]R1:Defection 
 [priority 2]R2:Working 

Progress→

R0	OFF	OFF	OFF	ON	OFF	ON	ON	ON
R1	OFF	OFF	ON	OFF	ON	ON	OFF	ON
R2	OFF	ON	OFF	OFF	ON	OFF	ON	ON
Chart Indicated								

- Depending on the number of displayable dots of a displayed device, one dot may contain several data.
In such case, colors vary according to the priority order of the registration of data. When a high-priority monitored device is ON, its color is preferentially displayed.
- Details are displayed by a tool tip so that colors and the corresponding data can be distinguished on the browser.
(The times when monitored data was occurred and recovered are also displayed.)

■ **Setting method of Gantt chart**

[Common settings]

horizontal position	<input type="text" value="50"/>
vertical position	<input type="text" value="30"/>
width	<input type="text" value="540"/>
height	<input type="text" value="300"/>
label	<input type="text" value="gt2"/>
security level	<input type="text" value="0"/>

Setting item	Options of values	Default	Description of setting item
horizontal position	Position from the top end of the screen	The first position where a part is arranged	Specify a position from the top end of the screen.
vertical position	Position from the left end of the screen	The first position where a part is arranged	Specify a position from the left end of the screen.
width	Width of a part.	400	Specify the width of a part.
height	Height of a part.	240	Specify the height of a part.
label	gtx	The value of x increases every time a part is arranged.	Specify a part name.
security level	0 to 15	0	Specify the security level of a part.

[Group settings]

host address	<input type="text" value="Global settings"/>
network protocol	<input type="text" value="Global settings"/>
group number	<input type="text" value="7"/>

Setting item	Options of values	Default	Description of setting item
host address	IP address	Global settings	Specify the IP address of the FP7 that data is acquired.
network protocol	Global settings/m7	Global settings	Specify a protocol for acquiring data.
group number	0 to 7	0	Specify a group number to be monitored for the Gantt chart.

[Display settings]

display range	1 day
first hour	0
last hour	23
divisions	auto
nb. devices	16

Setting item		Options of values	Default	Description of setting item
display range		1 day/1 month/ 1 year	1 day	Set the range to be displayed in the Gantt chart.
first hour	1 day	0 to 23	0	It can be set only when the display range is set to "1 day".
	1 month	1 to 31	1	It can be set only when the display range is set to "1 month".
	1 year	1 to 12	1	It can be set only when the display range is set to "1 year".
last hour	1 day	0 to 23	23	It can be set only when the display range is set to "1 day".
	1 month	1 to 31	31	It can be set only when the display range is set to "1 month".
	1 year	1 to 12	12	It can be set only when the display range is set to "1 year".
divisions		none/auto/ 2 to 30	auto	Set the number of time divided to be displayed in the Gantt chart.
nb. devices		1 to 16	16	Set the number of devices to be monitored in the Gantt chart.

● Settings related to whole displays

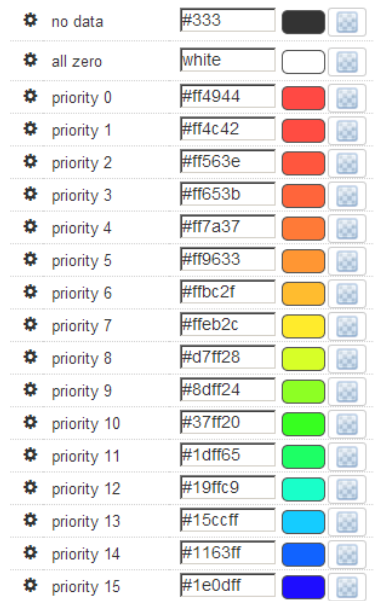

Setting item	Options of values	Default	Description of setting item
no data	Color selection/Transparent	black	Set a color for the case where no data exists in a target device.
all zero	Color selection/Transparent	white	Set a color for the case where all bits are OFF.
priority 0	Color selection/Transparent	dark red	Set colors for priority devices. The smaller the number is, the higher the priority becomes.
priority 1		red	
priority 2		pink	
priority 3		dark pink	
priority 4		dark orange	
priority 5		orange	
priority 6		golden yellow	
priority 7		yellow	
priority 8		greenish yellow	
priority 9		light green	
priority 10		green	
priority 11		dark green	
priority 12		blue green	
priority 13		light blue	
priority 14		blue	
priority 15		purple	

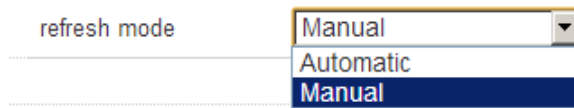
[Refresh mode]

Setting item	Options of values	Default	Description of setting item
refresh mode	Automatic/ Manual	Manual	Specify a timing to update Gantt chart parts. (In the case of Automatic, a button to control the update is added.)

Automatic: Detects the update of the history of Gantt chart automatically and acquires the history.

Manual: Acquires the history only when the refresh button is pressed.

[Details display]

The settings for the area displaying the details of the history of the Gantt chart are specified. The details display is shown by tapping the area of the screen or pointing a cursor to it.

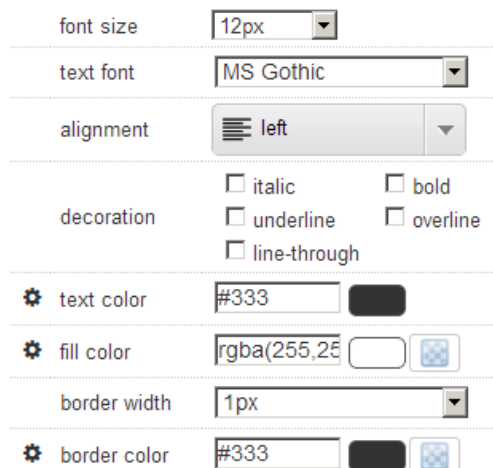

Setting item	Options of values	Default	Description of setting item
font size	8 to 16/18/20/24/28/32/36/40/44/48/ 54/60/66/72/80/88/96/100px/ Set arbitrarily	12px	Set a text size.
text font	MS Gothic/Digital/Led/Pixels/Retro/ MS PGothic/Meiryo/Georgia/ Palatino Linotype/Times New Roman/Arial/Arial Black/Comis Sans MS/Impact/Lucida Sans Unicode/Tahoma/Trebuchet MS/ Verdana/Courier New/Lucida Console	MS Gothic	Set a text font.
alignment	left/center/right/justify	center	Set a layout.
decoration	italic/bold/underline/overline/line- through	No setting	Set text decorations.

Setting item	Options of values	Default	Description of setting item
text color	Color setting	black	Set a text color.
fill color	Color setting/Transparent	white	Set a background color.
border width	Hide/1 to 16/18/20/24/28/32/36/40/44/48/54/60/66/72/80/88/96/100px	1px	Set the width of a border.
border color	Color setting/Transparent	black	Set the color of a border.

[Language setting]

language count

language menu

initial language no.

language no. 0

language no. 1

Setting item	Options of values	Default	Description of setting item
language count	1/2	1	Specify the number of displayed languages. (Up to two languages can be registered.)
language menu	Show/hide	show	Specify whether to show or hide the language change switch. (This is settable only when the number of displayed languages is two.)
initial language no.	0/1	0	Specify a language number displayed in the default state. (This is settable only when the number of displayed languages is two.)
language no. 0	Character input	Lang.#0	Input a displayed language.
language no. 1	Character input	Lang.#1	Input a displayed language. (This is settable only when the number of displayed languages is two.)

[Operation button]

text size	Default (14px) ▾
[start] visibility	Visible ▾
[stop] visibility	Visible ▾
[refresh] visibility	Visible ▾
[CSV] visibility	Visible ▾
[clear history] visibility	Visible ▾

Setting item	Options of values	Default	Description of setting item
text size	Default (14px) / 8 to 100px	Default (14px)	Specify the character size of Operation button.
[start] visibility	Visible/Hidden	Visible	Specify whether to show or hide the start button. Operation: Starts monitoring the Gantt chart.
[stop] visibility	Visible/Hidden	Visible	Specify whether to show or hide the stop button. Operation: Stops monitoring the Gantt chart.
[refresh] visibility	Visible/Hidden	Visible	Specify whether to show or hide the refresh button. Operation: Updates the display of the Gantt chart.
[CSV] visibility	Visible/Hidden	Visible	Specify whether to show or hide the CSV button. Operation: Outputs the Gantt chart to a CSV file.
[clear history] visibility	Visible/Hidden	Visible	Specify whether to show or hide the clear history button. Operation: Deletes the Gantt chart of a displayed group.

[start] label	start
[stop] label	stop
[refresh] label	refresh
[CSV] label	csv
[clear history] label	clear

Setting item	Options of values	Default	Description of setting item
[start] label	Character input	start	Input a displayed name of the start button.
[stop] label	Character input	stop	Input a displayed name of the stop button.
[refresh] label	Character input	refresh	Input a displayed name of the refresh button.
[CSV] label	Character input	csv	Input a displayed name of the csv button.
[clear history] label	Character input	clear	Input a displayed name of the clear history button.

[CSV settings]

The setting for the header of a CSV file to which the Gantt chart is output. They can be set for each language.

- The CSV setting #1 can be set when the number of the displayed languages is two.
- The initial values and settable items for #0 and #1 are the same.

date header #0

time header #0

Setting item	Options of values	Default	Description of setting item
date header #	Character input	Date	Input a displayed name of the date header.
time header #	Character input	Time	Input a displayed name of the time header.

Date	Time	Event	Alarm1	Alarm2	Alarm3
2000/7/22	5:22:45		1	1	0
2000/7/22	5:22:49		1	1	1
2000/7/22	5:22:51		0	1	1
2000/7/22	5:22:52		1	1	1
2000/7/22	5:23:03		1	1	1
2000/7/22	5:23:45		1	1	1
2000/7/22	5:37:19		1	1	1
2000/7/22	5:37:30		0	1	1
2000/7/22	5:37:34		0	0	1
2000/7/22	5:37:35		0	0	0
2000/7/22	5:38:24		0	0	0
2000/7/22	5:41:08		1	0	0
2000/7/22	5:46:00		0	0	0

[Frame format]

Frame can be deleted by pressing the "disable frame" button.

frame format

fill color

border style

border color

border radius

border width

Setting item	Options of values	Default	Description of setting item
fill color	Color setting/Transparent	white	Specify the background color of the area where a title of a Gantt chart part is input.
border style	none/solid/dashed/dotted/double/groove/ridge/inset/outset		Specify the style of the frame of a Gantt chart part.
border color	Color setting/Transparent	black	Specify the color of the frame of a Gantt chart part.
border radius	0 to 16/18/20/24/28/32/36/40/44/48/54/60/66/72/80/88/96/100px	10px	Specify the rounded corners of the frame of a Gantt chart part. The smaller the value is, the nearer the corner angle approaches a right angle.
border width	Hide/1 to 16/18/20/24/28/32/36/40/44/48/54/60/66/72/80/88/96/100px	2px	Specify the width of the frame of a Gantt chart part.



[Title]

text	<input type="text" value="ALARM CHART"/>
alignment	<input type="button" value="center"/>
color	<input type="text" value="#1b1b1b"/> <input type="color" value="black"/>
title size	<input type="text" value="32px"/>
title font	<input type="text" value="MS Gothic"/>

Setting item	Options of values	Default	Description of setting item
text	Character input	No setting	Input a title of a Gantt chart part. (The text input is displayed on the upper part of the part.)
alignment	left/center/right/justify	center	Specify the position of the title.
color	Color setting	black	Specify the text color of the title.
title size	8 to 16/18/20/24/28/32/36/40/44/48/ 54/60/66/72/80/88/96/100px/ Set arbitrarily	32px	Specify the character size of the title.
title font	MS Gothic/Digital/Led/Pixels/Retro/ MS PGothic/Meiryo/Georgia/Palatino Linotype/Times New Roman/ Arial/Arial Black/Comis Sans MS/Impact/Lucida Sans Unicode/ Tahoma/Trebuchet MS/Verdana/ Courier New/Lucida Console	MS Gothic	Specify the character font of the title.

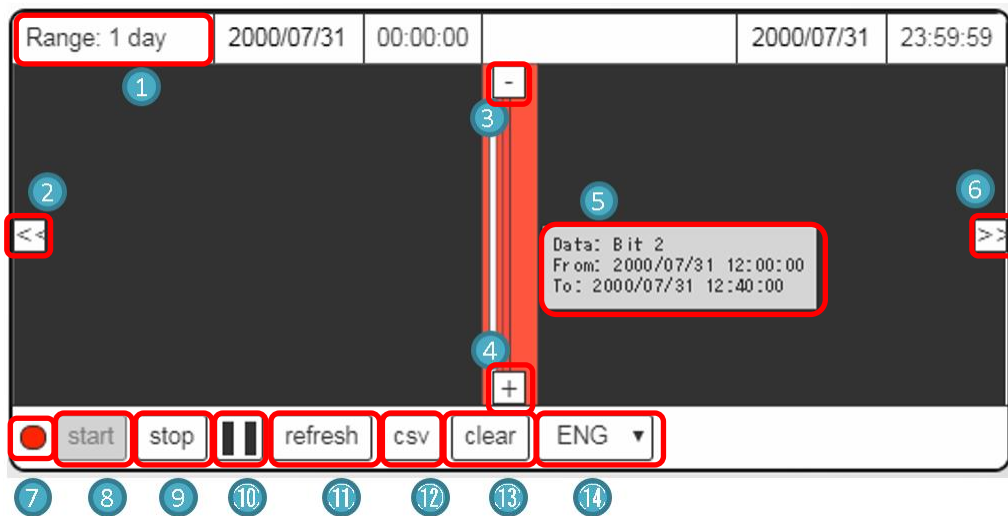
■ Browser screen



No.	Description
①	Indicates the current display range. When the current time is within the displayed time range, the display is up to the current time.
②	Refers to the previous range. Example) When the Gantt chart of March is displayed, it is changed to the display of February.
③	Zooms out the display range. The display range is switched in the order of 5 minutes, 1 hour, 1 day, 1 month, and 1 year.
④	Zooms in the display range. The display range is switched in the order of 1 year, 1 month, 1 day, 1 hour, and 5 minutes.
⑤	The detail of data is displayed by tapping (pointing a cursor) on the area.
⑥	Refers to the next range. Example) When the Gantt chart of March is displayed, it is changed to the display of April.
⑦	It indicates the status of the start/stop of the Gantt chart.
⑧	"start" starts the Gantt chart.
⑨	"stop" stops the Gantt chart.
⑩	It indicates the current update status when selecting the automatic update.
	 Automatic update in progress
	 Automatic update stops
⑪	"refresh" updates the display of the Gantt chart.
⑫	"csv" outputs the Gantt chart information to a csv file.
⑬	"clear" deletes all Gantt charts of the displayed group.
⑭	The language can be changed during the execution of the Gantt chart.

■ List of errors

Code	Name	Description of error
41	Format error	Command in a different format was received.
42	Not-support error	The command not supported by the source or destination node was transmitted.
60	Parameter error	Specified parameter does not exist, or cannot be used.
61	Data error	There is an error in the contact, data area, data number, size, range or format specification.
63	PROG. error	Operation history parts cannot be operated in PROG.
71	Exclusive control error	Executed a command that cannot be processed simultaneously with the command already in process.
98	Operation history active error	Active operation history group exists.

3.5.7.2.12 Camera Parts

Camera parts can be used in cooperation with a network camera manufactured by Panasonic. The part can be moved to the preset position registered for a network camera according to the command of PLC as well as the manual operation from the part.

■ Cooperation method with network camera

The following setting is required for linking a network camera and a camera part.

Note)

Recommended browsers for using camera parts are Google Chrome, Fire Fox, Opera, and Safari.

When using Internet Explorer, the automatic login to a network camera is not available.

As the web screen of the network camera is displayed, log in from that screen.

Use the latest version of software for the network camera.

- Setting for the connection with network camera

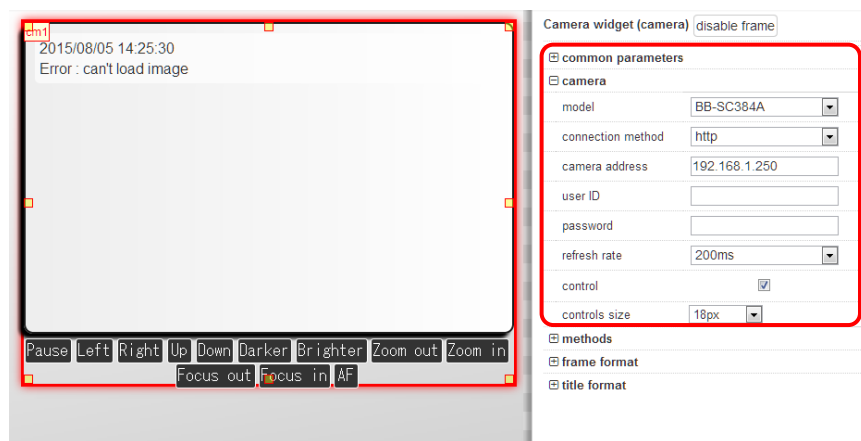

Setting item	Description
model	Select a target camera type.
connection method	Select http or https for the connection method.
camera address	Specify the IP address of the camera.
user ID	Specify the user ID set in the camera.
password	Specify the password of user ID.
refresh rate	Specify the update cycle of camera images. A minimum of 50 ms can be set.
control	Specify whether to display or not display a button for operating the camera.
controls size	Specify the size of the operation button.

The supported models for network camera parts are as follows.

Network cameras manufactured by Panasonic

BB - SP104W / ST162A / SC384A / SW174WA / SW175A / SW172A

WV - SF135 / SF138 / SW155 / SW158

■ Cooperation method with PLC and network camera

Registering operations enables the operations in cooperation with PLC.

The camera can be moved to the preset position according to reference bits.

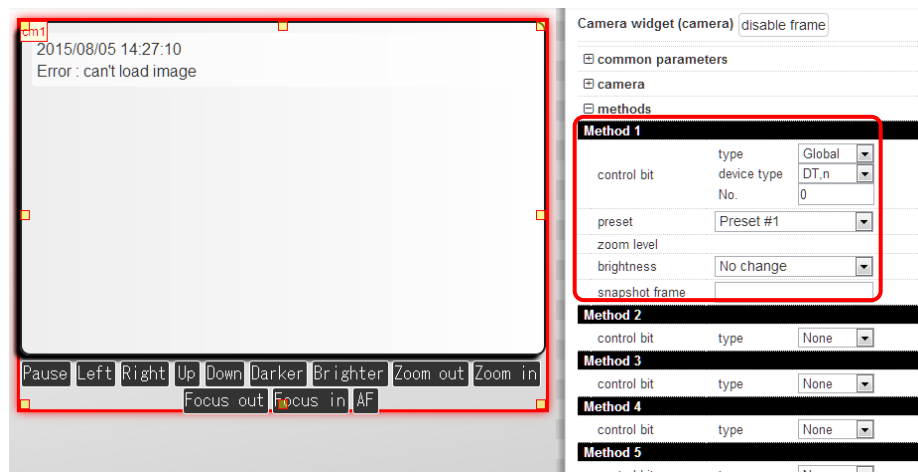

Setting item	Description
control bit	Specify a device to be a trigger.
preset	Specify the preset position set in the camera. The view point of the camera can be changed by specifying the preset position. *: This setting is not available for some models.
zoom level	For using the magnification specified for the preset position of the camera, select "No change". For using a different magnification from that of the preset position, specify a magnification. *1: Magnification varies depending on the model and settings of the camera. *2: This setting is not available for some models.
brightness	For using the brightness specified for the preset position of the camera, select "No change". For using a different brightness from that of the preset position, specify brightness.
snapshot frame	The content of a current camera image is reflected to a specified graphical part. Specify the label name of graphical part. *: It takes a little time to reflect the content to a graphical part.

* For details of the method of registering the preset position, refer to each manual of the network camera you use.

■ Available functions for each model

Usable functions for each model are as follows.

Model	BB-SP104W	BB-ST162A (SW174WA , SW175A , SW172A)	BB-SC384A	WV-SF135 (SW155)	WV-SF138 (SW158)
Preset specification	—	Available	Available	—	—
Magnification	Available	Available	—	Available	Available
Brightness	Available	Available	Available	Available	Available

■ How to select models

The Web Creator supports various models, however, typical model numbers should be selected when selecting a model.

The model numbers corresponding to typical model numbers are as follows.

Typical model number	Corresponding model number
BB-ST162A	BB - ST162A, SW174WA, SW175A, SW172A
BB-SC384A	BB - SC384A
BB-SP104W	BB - SP104W
WV-SF135	WV - SF135, SW155
WV-SF138	WV - SF138, SW158

● Operation image

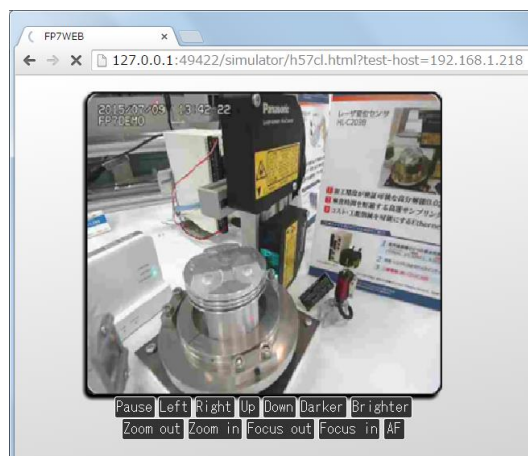

3.5.7.2.13 General-use Camera Parts

General-use camera parts can be linked with Panasonic network cameras that support CGI commands. They can also access specified URLs.

■ Setting items for general-use camera parts

Item	Description
Connection method	Select http or https for the connection method.
Camera address	Specify the IP address of the camera.
User ID	Specify the user ID set in the camera.
Password	Specify the password of user ID.
Parameter name	The parameter name can be specified. The default value is "page."
Refresh rate	Specify the refresh cycle of camera images. No refresh / best effort / 50ms / 100ms / 200ms / 500ms / 1s / 2s / 5s / 10s

■ Examples of connection with Panasonic network cameras

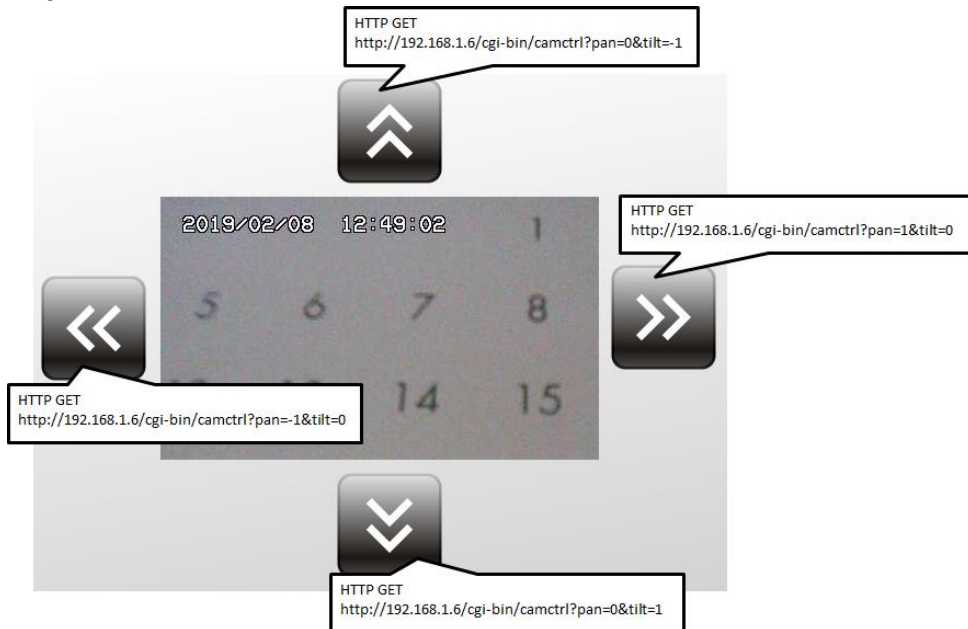

Examples of setting for general-use camera parts

Item	Description
Connection method	http
Camera address	192.168.1.6/cgi-bin/camera?resolution=640
User ID	(Blank)
Password	(Blank)
Parameter name	Page
Refresh rate	Best Effort

3.5.7.2.14 Text Parts

Text parts can be entered directly from parts.

Multiple lines can also be displayed.

■ **Direct input method on parts**

Double-clicking a text part after selecting it enables the direct input.

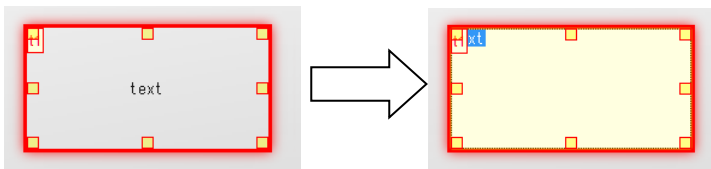

Purpose	Operation method
Determination of input	The input content is determined by operating the Enter key or Esc key, or selecting an area outside of the part.

Remarks) It is possible to start a new line in the middle of line by inputting "\n".

This can be specified by both the direct input to text parts and the setting item "text".

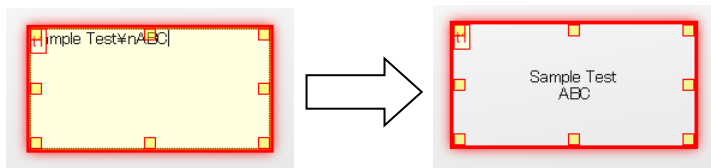

3.5.7.2.15 Table Parts

By setting a specified area in a table as a monitor area using a table part, data can be displayed in tabular form.

■ Procedure of table creation

- After arranging table parts, the numbers of rows and columns are set. The maximum number of cells in a table is 2048. When setting it to be larger than 2048, the numbers of rows and columns are automatically corrected to make the number of cells be within 2048.

Table widget (table)

common parameters

table

number of rows

number of columns

- Change the mode to the edit mode by double-clicking the table part. Once the mode is changed to the edit mode, the row and column numbers are displayed.

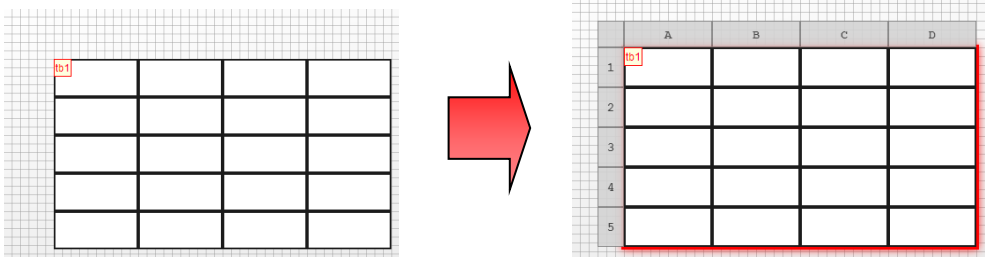

- Set the cell area for displaying data for the monitor area.

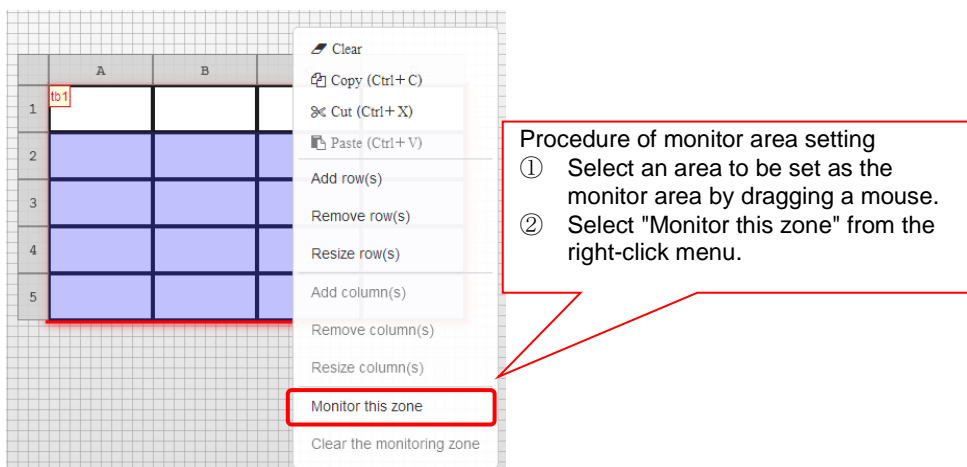

Cells other than the monitor area can display characters and messages as text areas.

■ Reference device of monitor area

Devices can be set for each column.

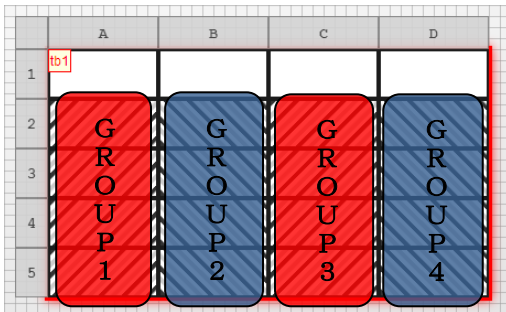

The reference address of each row increases sequentially by "Number of words of data type x Subsequent device".

When the data type is "SS" (1 word) and the subsequent device is "5", the reference devices are as follows.

First line (1st line)	DT0
	DT5
	DT10
	DT15
	DT20
	DT25
	~ Omitted ~
Last line (n+1st line)	DT 5 × n

device

host address

network protocol

read device

type	Global
device type	DT
No.	0
data type	SS

read index device

type	None
------	------

read device step

■ Functions of cells in monitor area

- The following functions are available as well as data parts.
 1. Values, character strings, date and time can be displayed.
 2. The writing operation is also available for value and character string displays.
 3. By setting a peak hold device when displaying a value, the minimum or maximum value of the displayed value can be output to the internal device.
 4. The update cycle for display contents can be specified by setting the display cycle.
- When "Messages & Translations..." has been set, registered messages can be displayed as well as message parts.

■ Editing operation of table parts

In the edit mode of table parts, operations such as inserting or deleting rows and columns, resize, copying cells are available.

1. Right-click the cell where you want to insert an object for performing these operations using the right-click menu.
2. Operations can also be performed by the shortcut key input of a keyboard.

Available operations by the right-click menu

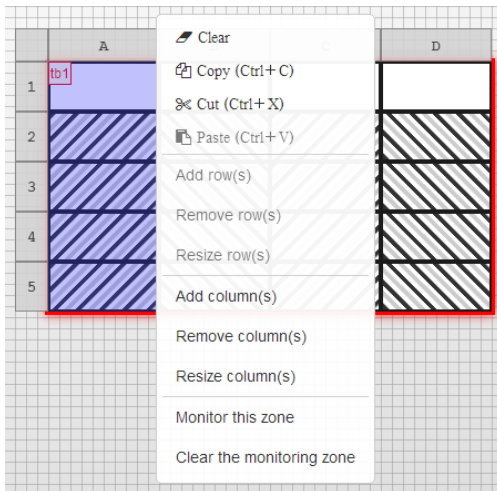

Available operations from a keyboard

Operation	Keyboard operation
Copying cells	Ctrl + C
Pasting cells	Ctrl + V
Cutting cells	Ctrl + X
Clearing text of cells	Delete

- The operation "Clear" initializes the settings of character format or borders besides clearing text in a selected range.
※Please use the Delete key if you want to clear the text only.
- In the "Clear the monitoring zone" operation, the monitor area specified in "Monitor this zone" is cancelled.
- The following methods are available for changing the height of rows or width of columns.
 1. You can change the size of a border by dragging it.
 2. The "Resize row(s)" or "Resize column(s)" can be specified by the right-click menu. Up to 1000 pixels can be specified for a row height and a column width.

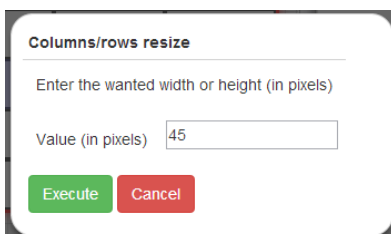

The current sizes are displayed as the initial values.
Press the execution button after inputting desired sizes.

■ Formatting of cells

- The borders and character format can be set for each cell in a table.
- The setting of outer frame can be changed collectively by changing the style and color of any of top, right, bottom and left borders and the frame width after checking the box for the outer frame array setting.
- The border style is selectable from "none", "solid", "dashed", "dotted" and "double".
- When selecting "double" for the border style, the minimum border width is 2 pixels. Even when setting it to 1 pixel, the appearance of the border does not change from 2 pixels.

frame format

outer border

border top style solid

border right style solid

border bottom style solid

border left style solid

border inner style solid

border top color #1b1b1b

border right color #1b1b1b

border bottom color #1b1b1b

border left color #1b1b1b

border inner color #1b1b1b

border top width 2px

border right width 2px

border bottom width 2px

border left width 2px

border inner width 2px

fill color #fff

Check the box of "outer border".

When the box of " outer border" is checked, the changes of the settings of top, right, bottom and left are linked. For setting each border separately, uncheck this box.

3.5.7.2.16 Shapes Parts

Not only graphics but also the lamp and switch functions can be set for shapes parts.

■ Setting of lamp and switch functions

The lamp and switch functions become usable by specifying devices for using the lamp and switch functions.

The screenshot shows the 'Shape widget (shape)' settings panel. On the left, four shapes are displayed: a square (s2), an upward arrow (s4), a leftward arrow (s3), and a downward arrow (s5). The settings panel is divided into two sections, both highlighted with red boxes and callouts:

- Settings related to the lamp function:** This section includes 'lamp status' (type: Global, device type: DT_n, No.: 0), 'lamp status mode' (a), 'blinking' (none), 'blinking bit' (type: None), and 'blinking bit mode' (a).
- Settings related to the switch function:** This section includes 'switch write device' (type: Global, device type: DT_n, No.: 0), 'switch mode' (momentary-set), 'interlock device' (type: None), and 'interlock mode' (a).

* For using parts as shapes parts, set each device setting to "None".

When setting the lamp function, the setting for changing the display by turning ON/OFF a reference bit is possible by changing the following setting.

The screenshot shows the 'Shape widget (shape)' settings panel with the 'on display' and 'off display' sections highlighted in red boxes and callouts:

- Display setting when bit is ON:** This section includes 'fill color' (#eee:red), 'line color' (#1b1b1b), and 'line width' (2px).
- Display setting when bit is OFF:** This section includes 'fill color' (#eee:white), 'line color' (#1b1b1b), and 'line width' (2px).

* For using parts as shapes parts, change the setting of "off display" when changing the design.

* A transparent switch can be created by setting all the color settings to be transparent for both the on and off states.

For details of the setting method of transparent parts, refer to the next page.

■ Transparency setting

Besides the shapes parts, the transparency setting is available in the color setting for various web parts except some parts.

For details of the parts and items for which the transparency setting is available, refer to "Parts for which the transparency setting is available" on the next page.

* The transparency setting is unavailable for the following web parts.

Slider parts, rotary switch parts, media player parts, and meter parts (meter parts that the low/middle/high range functions are not enabled)

• Method of making a part transparent (1)

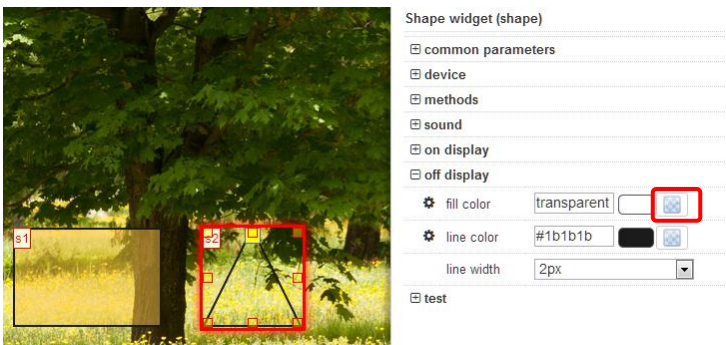

The part is made transparent by operating the "Transparent" button.

• Method of making a part transparent (2)

When setting transparency from the dialog of the color selection, it is possible to specify arbitrary transparency.

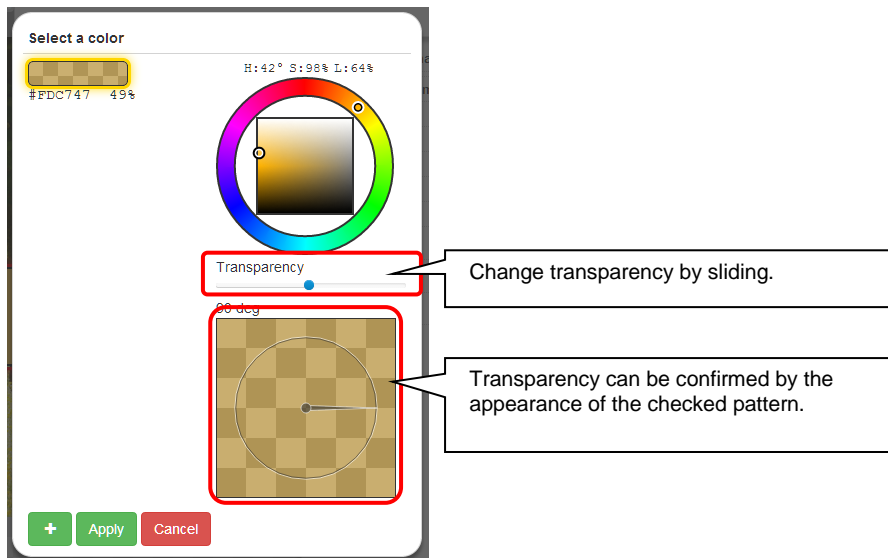

■ **Parts for which the transparency setting is available**

The parts for which the transparency setting available and settable items are as follows.

Parts	Items for which the transparency setting is available					
Dialog	Button color	-	-	-	-	-
Meter	Low range color	Middle range color	High range color	-	-	-
Line graph	Line color	Background color	Font color	-	-	-
Bar graph	Line color	Background color	Font color	-	-	-
Extended graph	Graph background color	Graph frame color	Background color	Scale color	Line color	Fill color
Data	Background color	Frame line	Shadow color	-	-	-
Message	Background color	Frame line	Shadow color	-	-	-
Camera	Background color	Frame line	Shadow color	-	-	-
Graphic	Line color	Fill color	-	-	-	-

3.5.8 Functions of Web Creator

This section describes various functions of Web Creator.

The usable functions of Web Creator vary depending on the web server model selected in each project.

For details, refer to "3.3.1 Differences by Web Server Models".

3.5.8.1 Server Certificate Setting

SSL communication can be performed by setting a server certificate in the PLC.

The setting method is as follows.

The SSL communication server certificate setting is not available for Eco-POWER METER.

3.5.8.1.1 Setting Server Certificate in PLC

Set a server certificate in the FP7 /ELC500. Once a server certificate is set, note that even an FTP server is connected via SSL communication.

■ **Items that should be prepared**

- Server.cer (server certificate file)
- any.key (Secret key file)

*1: The files should be created with the above file names.

*2: For the above certificate, always prepare it in a pair.

If a certificate is incorrect, it cannot be set.

Reference) Besides server certificates prepared by certificate authorities, self certificate created by free software such as a certificate creation tool can also be used.

Free certificate creation software: Such as electronic certificate creation software "k9pca"

■ **Storage location of certificate**

Create a "ssl" folder under the project folder, and store the certificate file in it.

(my document)

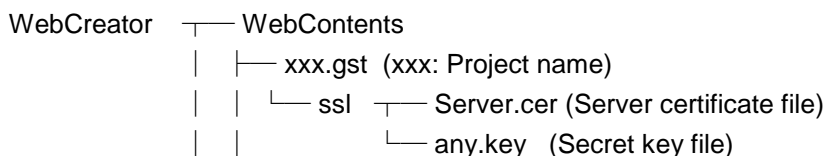

**PROCEDURE**

1. Click "Operations" > "Upload SSL certificate..." in the project menu.

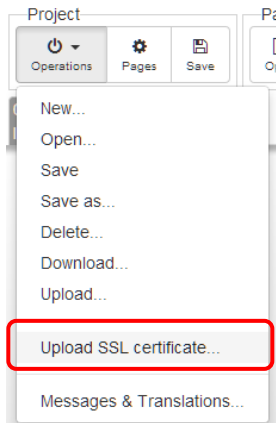

2. Select "Register" in Operation, and confirm the IP address, user ID and password* of the FP7 / ELC500 of upload destination, and click "Apply".

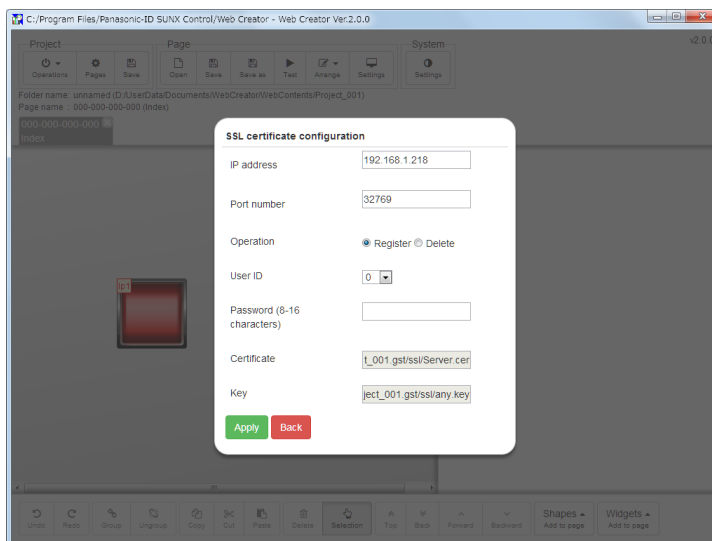

For the IP address of the upload destination, the IP address specified for the host for test, upload or download is shared.

The user ID and password varies by the security setting of FP7 / ELC500.

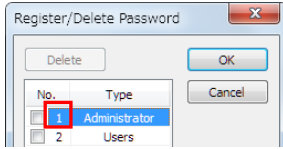
Security setting	User ID and Password
None	Connect as a master user. User ID: 0, Password: Not required
FPWIN GR7S security settings (FP7 only)	User ID: Number for administrator used when the password has been registered. (Figure below) Password: Administrator password used when the password has been registered.  (How to confirm) "Tools" > "PLC Security Settings" > "Register/Delete Password"
FPWIN Pro7 security settings	User ID: 1, Password: Password registered in Security Settings. (How to confirm) "Online" > "Security Settings"

3. When the exit screen is displayed, click "OK".

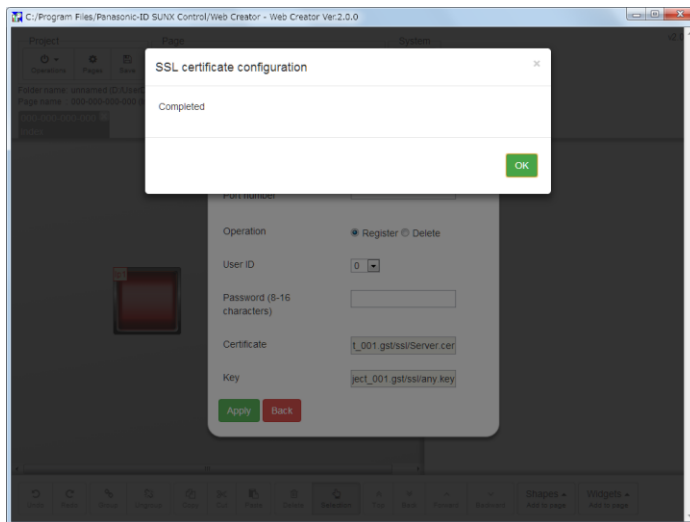

4. Restart the FP7 / ELC500.

Restart the PLC for enabling the setting.

5. Confirm the SSL communication is valid by accessing from the browser.

Access the following URL from the browser, and confirm that a content screen is not displayed.

(xxx: the IP address of the FP7 / ELC500 on which the certificate is registered)

FP7	http://xxx.xxx.xxx.xxx/sys/
ELC500	http://xxx.xxxx.xxx.xxx/cu/index.html

* For accessing the PLC on which the SSL setting is conducted, install a root certificate in the PC you used in advance.

For details of the installation instructions, refer to "3.5.8.1.3 Registering Root Certificate in PC".

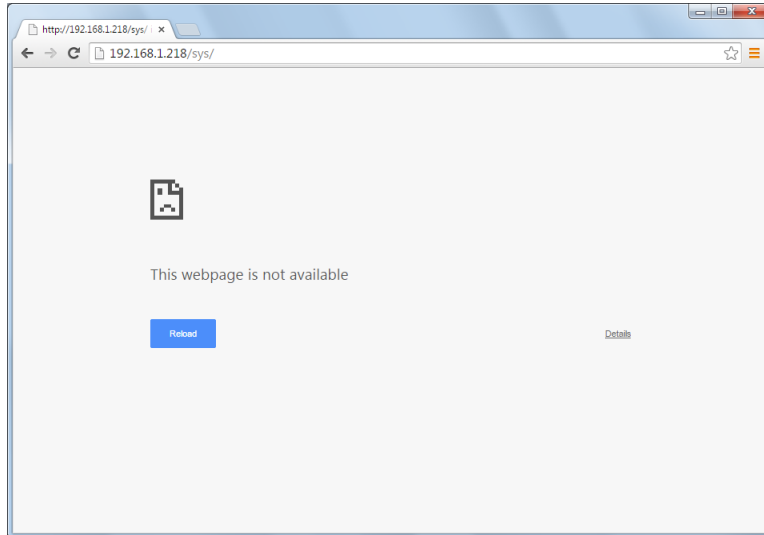

Access the following URL from the browser, and confirm that a content screen is displayed and a key mark is shown in the address bar.

(xxx: the IP address of the FP7 / ELC500 on which the certificate is registered)

FP7	https://xxx.xxx.xxx.xxx/sys/
ELC500	https://xxx.xxxx.xxx.xxx/cu/index.html

(The way of displaying the key mark varies according to a browser you use.)

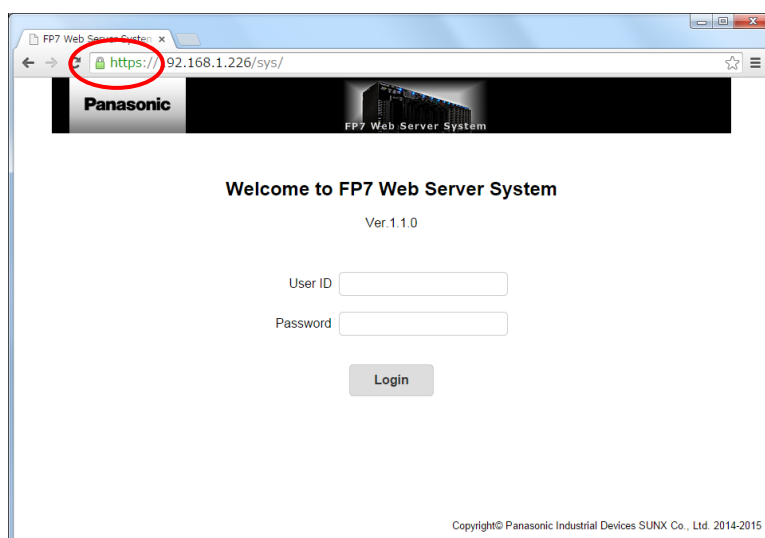

3.5.8.1.2 Deleting Server Certificate Information from PLC

Delete the server certificate in the FP7 / ELC500.



◆ PROCEDURE

1. Click "Operations" > "Upload SSL certificate..." in the project menu.

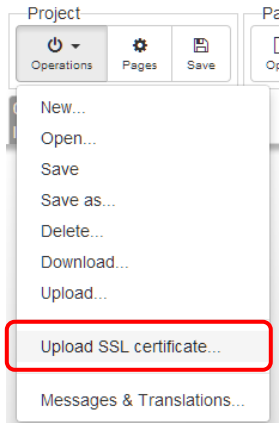

2. Select "Delete" in Operation, and confirm the IP address, user ID and password* of the upload destination FP7 / ELC500, and click "Apply".

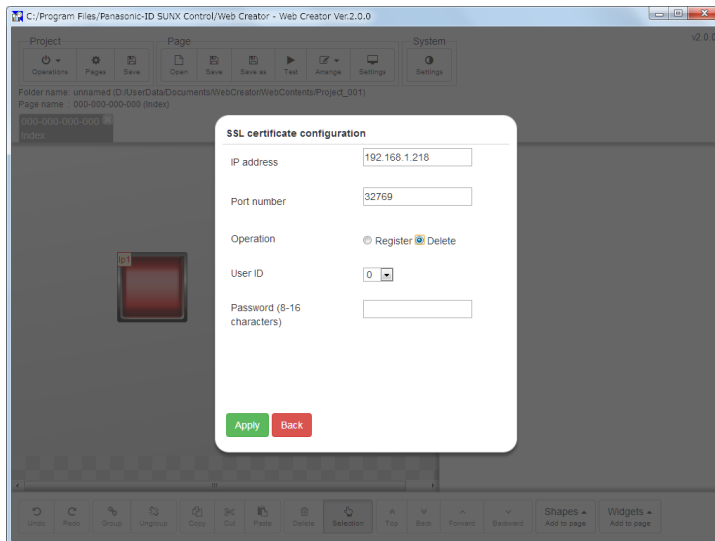

For the IP address of the upload destination, the IP address specified for the host for test, upload or download is shared.

The user ID and password varies by the security setting of FP7 / ELC500.

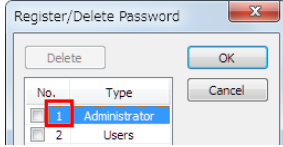
Security setting	User ID and Password
None	Connect as a master user. User ID: 0, Password: Not required
FPWIN GR7S security settings (FP7 only)	User ID: Number for administrator used when the password has been registered. (Figure below) Password: Administrator password used when the password has been registered.  (How to confirm) "Tools" > "PLC Security Settings" > "Register/Delete Password"
FPWIN Pro7 security settings	User ID: 1, Password: Password registered in Security Settings. (How to confirm) "Online" > "Security Settings"

3. When the exit screen is displayed, click "OK".

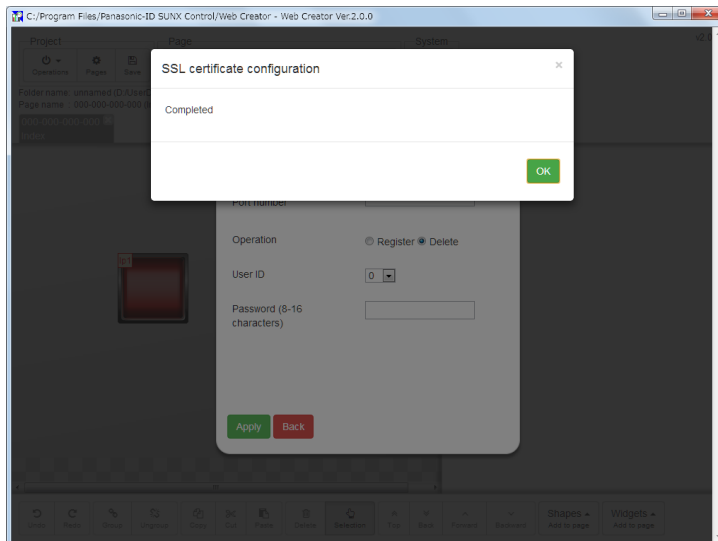

4. Restart the FP7 / ELC500.

Restart the PLC for enabling the setting.

5. Confirm the SSL communication is invalid by accessing from the browser.

Access the following URL from the browser, and confirm that a content screen is displayed and a key mark is not shown in the address bar.

(xxx: the IP address of the FP7 / ELC500 on which the certificate is registered)

FP7	http://xxx.xxx.xxx.xxx/sys/
ELC500	http://xxx.xxxx.xxx.xxx/cu/index.html

(The way of displaying the key mark varies according to a browser you use.)

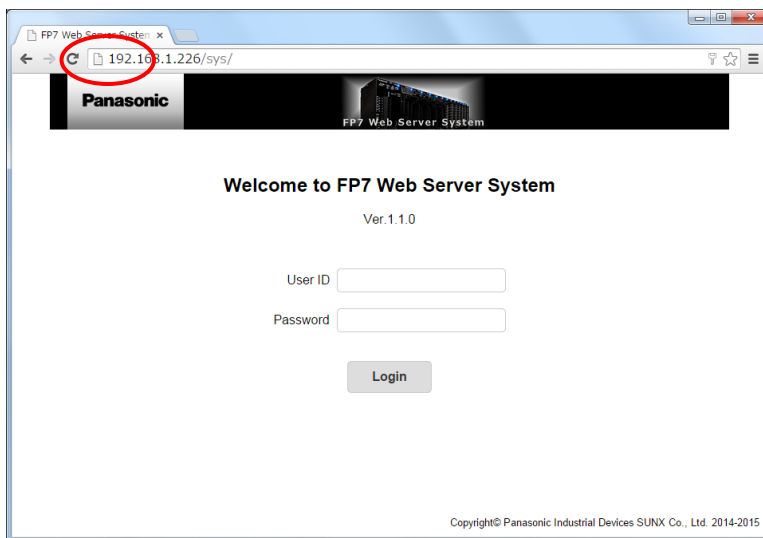

3.5.8.1.3 Registering Root Certificate in PC

For accessing contents in a PLC in which a server certificate has been registered, a root certificate should be registered in the PLC in advance.

When a root certificate is not registered, a content screen is not displayed even when accessing the PLC.



◆ PROCEDURE

■ Items that should be prepared

- Root certificate

* Prepare a root certificate that is issued by the publisher of the server certificate registered in the connected PLC.

* If server certificates issued by different publishers have been registered in multiple PLCs, prepare root certificates corresponding to each publisher.

■ Installation of root certificate

1. Select "Install Certificate" from the right-click menu of a root certificate.

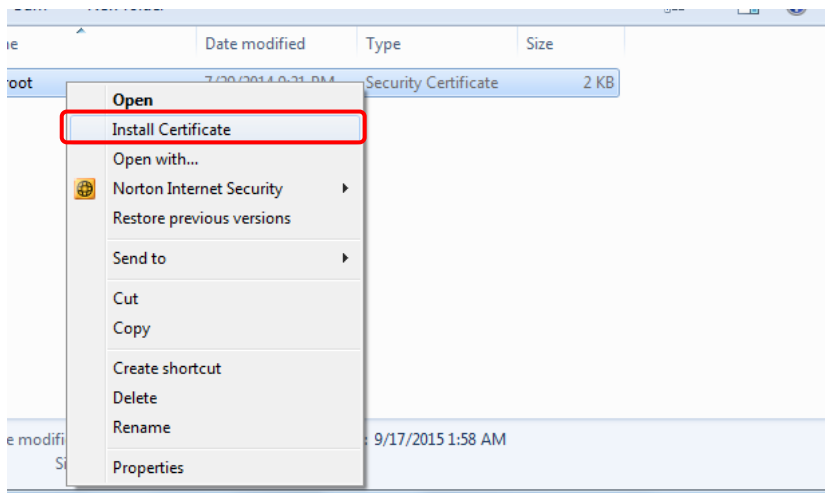

2. Select "Next" in the wizard.

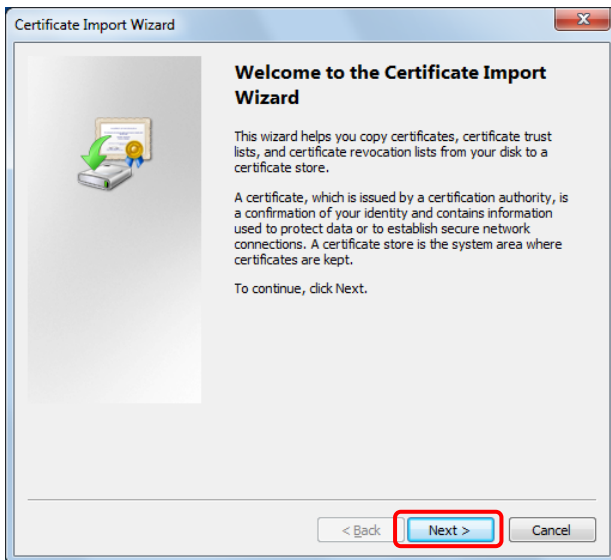

3. Select "Trusted Root Certification Authorities" from "Place all certificates in the following store".

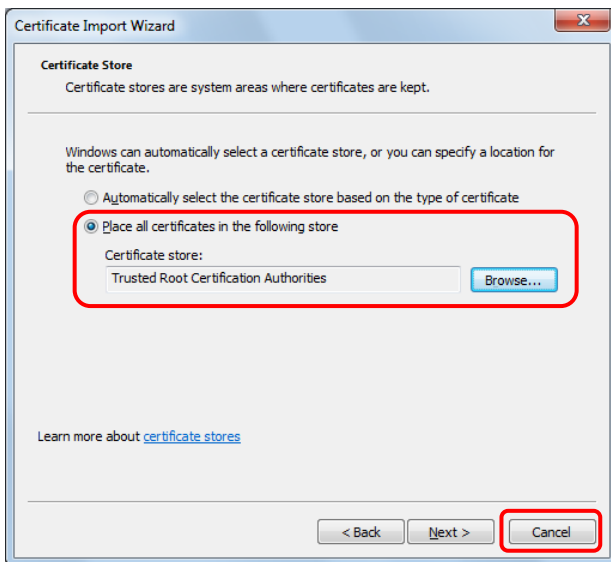

Select "Next" after selecting "Trusted Root Certification Authorities".

4. Confirm that "Trusted Root Certification Authorities" is selected, and select "Finish".

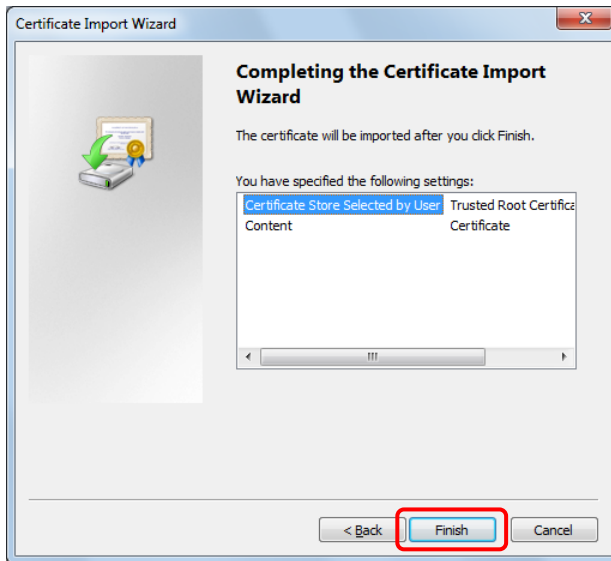

5. The installation of the certificate is complete.

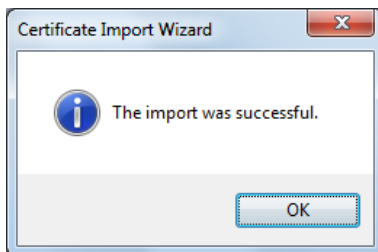

3.5.8.2 Security Setting

If the security setting is made, a password should be entered for displaying the screen.

Sixteen stages of security levels can be set, and web parts can be displayed according to the security level for login.



◆ PROCEDURE

■ Password setting for each security level

1. Open the advanced setting screen.

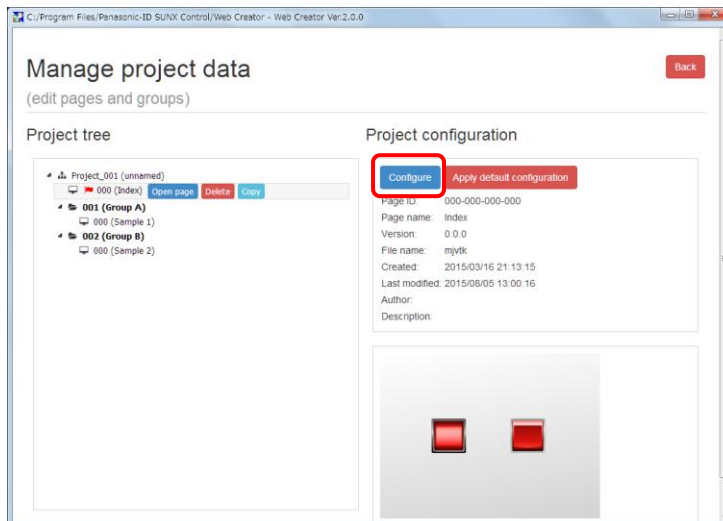

A project and groups can be set for each screen.

2. Select the "Security" tab.

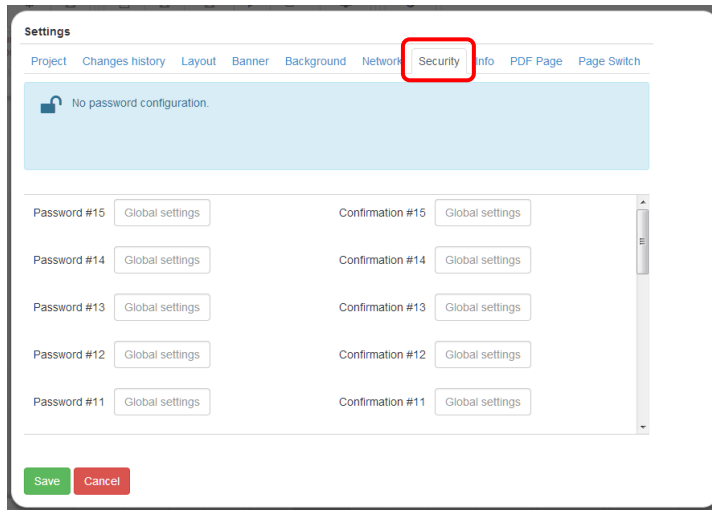

The screenshot shows the 'Settings' page with the 'Security' tab selected and highlighted by a red box. The page displays a message: 'No password configuration.' Below this, there are two columns of password settings, each with a 'Global settings' button. The columns are labeled 'Password #15' through 'Password #11' and 'Confirmation #15' through 'Confirmation #11'. At the bottom, there are 'Save' and 'Cancel' buttons.

3. Set a password for each security level.

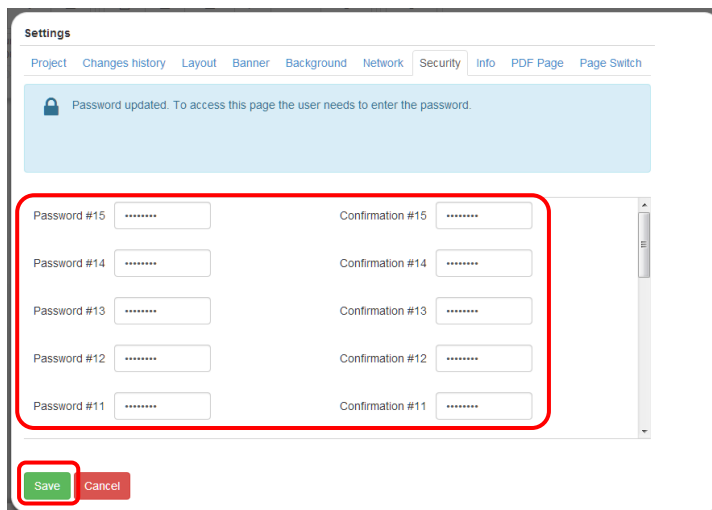

The screenshot shows the 'Settings' page with the 'Security' tab selected. A message at the top states: 'Password updated. To access this page the user needs to enter the password.' Below this, the password input fields for each security level are filled with dots. A red box highlights the entire password input area. At the bottom, the 'Save' button is highlighted with a red box, and the 'Cancel' button is also visible.

A password should be set for each security level.

Sixteen stages of security levels, 0 (low) to 15 (high) can be set.

* For deleting a password that has been set, leave the password input field blank for the setting.

■ Method of setting the security level of web parts

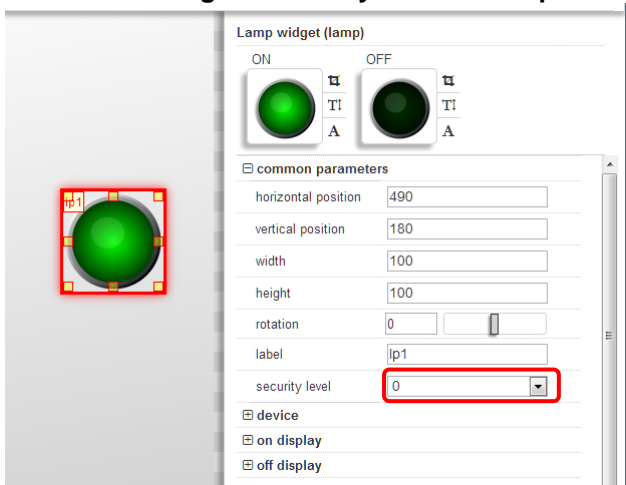

Security levels can be set for each web part.

If you log in with a security level lower than the corresponding security level, the part is not displayed.

Example of operation with the security setting

[Login screen]

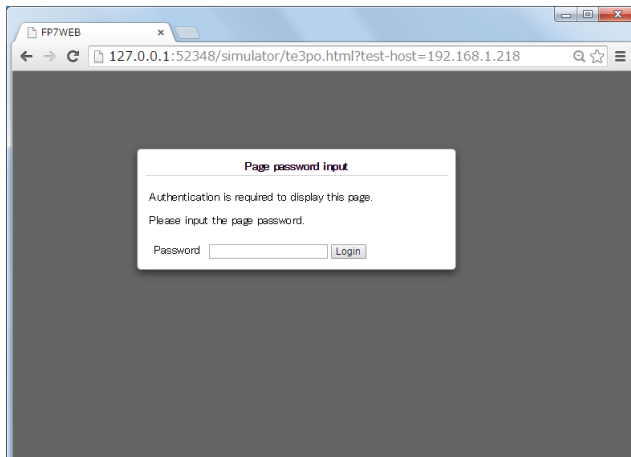

When displaying a screen for which a password has been set, the following screen is displayed.

Enter the registered password.

If the login attempt failed, the content screen is not displayed.

[Login result]

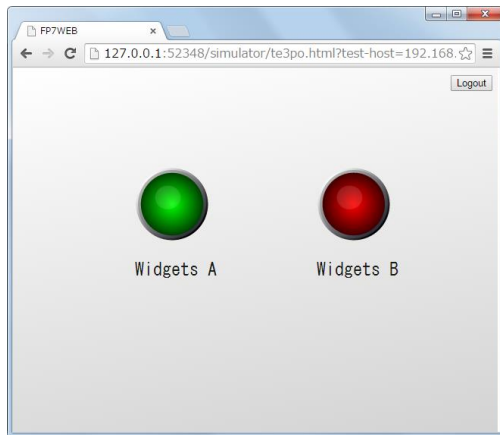

Login with a password higher than the security level

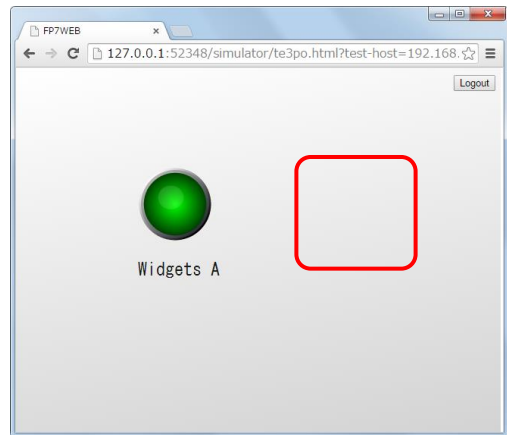

Login with a password lower than the security level

When the security has been set for multiple screens, and if the security settings for screens A and B are the same, the other screens can be displayed without login as the logged-in password information is transferred.

When the password settings for screens A and B are different, the login screen is displayed for opening other screens.

[Logout]

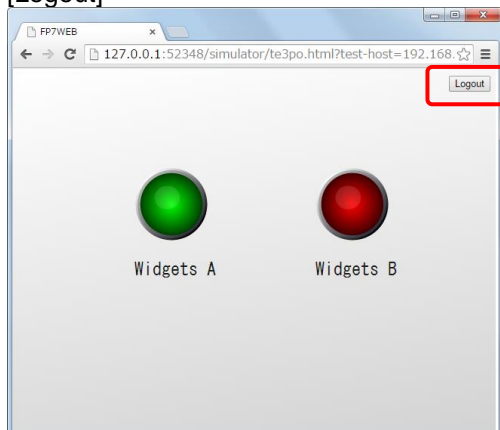

Once logged out, the screen returns to the initial screen.

* The initial screen is indicated with  mark on the project tree.

When the initial screen has not been set, nothing is displayed on the screen when logged out. The initial screen must be set.

3.5.8.3 Banner Setting

A banner can be displayed in each web screen.



◆ PROCEDURE

1. Open the advanced setting screen.

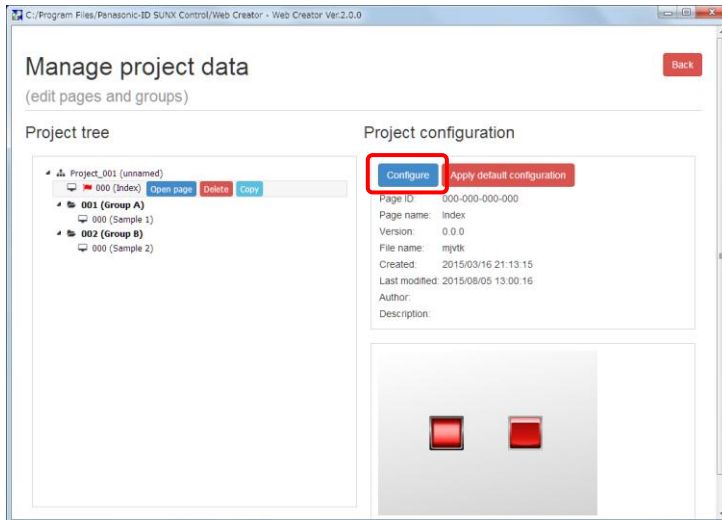

A project and groups can be set for each screen.

2. Select the "Banner" tab.

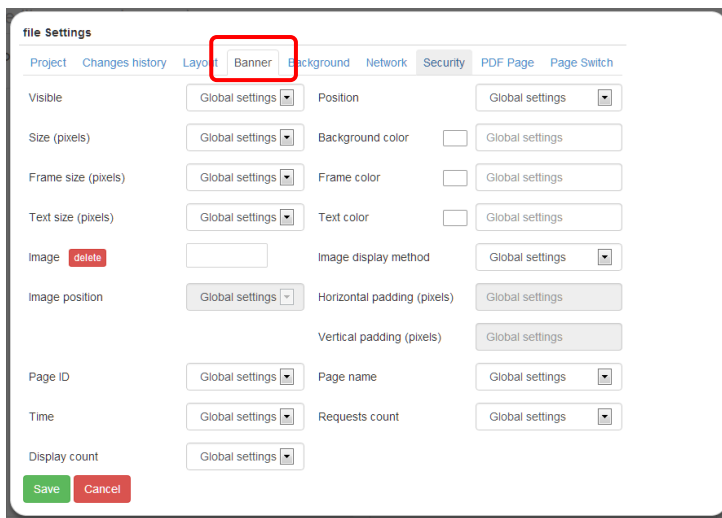

3. Set the items for a banner.

file Settings

Project Changes history Layout **Banner** Background Network Security PDF Page Page Switch

Visible	<input type="text" value="Visible"/>	Position	<input type="text" value="up"/>
Size (pixels)	<input type="text" value="75px"/>	Background color	<input type="text" value="rgba(195,124,245,1.00)"/>
Frame size (pixels)	<input type="text" value="2px"/>	Frame color	<input type="text" value="rgba(0,0,0,1.00)"/>
Text size (pixels)	<input type="text" value="14px"/>	Text color	<input type="text" value="rgba(255,255,255,1.00)"/>
Image	<input type="button" value="delete"/> 	Image display method	<input type="text" value="CONTAIN"/>
Image position	<input type="text" value="left"/>	Horizontal padding (pixels)	<input type="text" value="20"/>
		Vertical padding (pixels)	<input type="text" value="0"/>
Page ID	<input type="text" value="Visible"/>	Page name	<input type="text" value="Visible"/>
Time	<input type="text" value="Visible"/>	Requests count	<input type="text" value="Hidden"/>
Display count	<input type="text" value="Hidden"/>		

The setting items are as follows.

Setting item	Description
Visible	Display/hide a banner.
Position	Display position of a banner
Size (pixels)	Size of a banner. When the display position is "Up" and "Down", it is the vertical width. When it is "Left" and "Right", it is the horizontal width.
Background color	Background color of a banner
Frame size (pixels)	Line thickness of a banner
Frame color	Frame color of a banner
Text size (pixels)	Character size displayed in a banner.
Text color	Character color displayed in a banner.
Image	Image displayed in a banner
Image display method	<p>The display method of an image is as follows.</p> <p>Hidden: No image is displayed.</p> <p>FILL: An image is magnified so as to match with the banner area.</p> <p>CONTAIN: An image is magnified so as to be contained in the banner area.</p> <p>COVER: An image is magnified so as to cover the banner area.</p> <p>*1: When magnifying an image using "FILL", the aspect ratio of the magnified image does not match that of the original image.</p> <p>*2: When magnifying an image using "CONTAINER" or "COVER", the image is magnified so as to have the same aspect ratio as that of the original image.</p>
Image position	Display position of an image
Horizontal padding (pixels)	An image is displayed by shifting by a specified number of pixels.
Vertical padding (pixels)	An image is displayed by shifting by a specified number of pixels.
Page ID	A screen number is displayed in a banner.
Page name	<p>A screen name is displayed in a banner.</p> <p>The contents specified for the screen name of the advanced setting "Project" of each screen is displayed.</p>
Time	<p>Time information is displayed in a banner.</p> <p>*The time information of OS is displayed.</p>
Requests count	The cumulative number of communications and the number of communications per second are displayed.
Display count	The cumulative number of display times and the number of display times per second are displayed.

* For displaying an arbitrary image, it should be saved in "WebCreator\WebCommons\img". For details, refer to "2.2 Folder Structure of Web Creator".

Reference) When actually displaying the setting of the procedure 3.

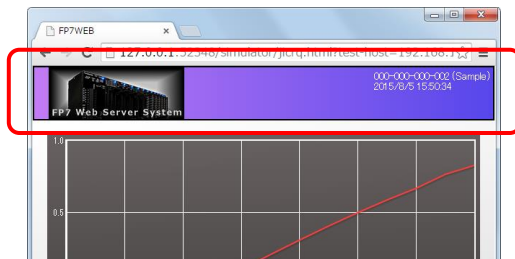

3.5.8.4 PDF Screen Setting

PDF data can be displayed when displaying a screen by specifying a PDF file as a screen.



◆ PROCEDURE

1. Store a PDF file you want to display in a predetermined folder.

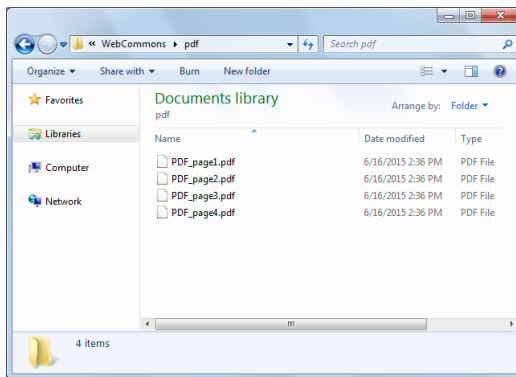

Store PDF files in "WebCreator\WebCommons\pdf".

For details, refer to "2.2 Folder Structure of Web Creator".

2. Open the advanced setting screen of the page on which the PDF is displayed.

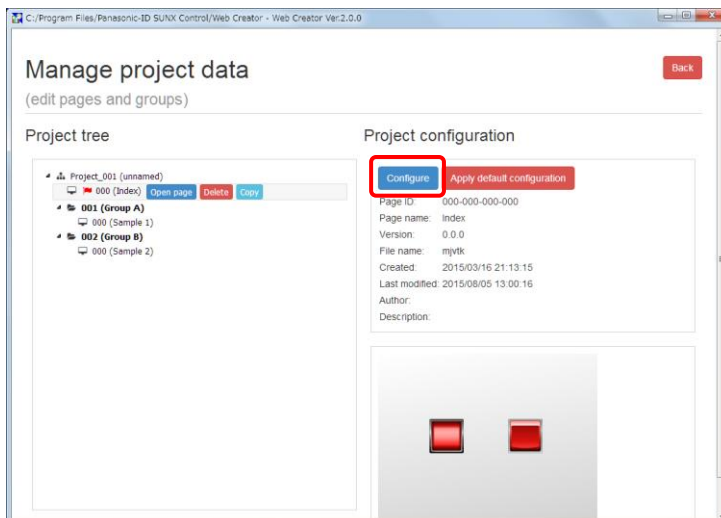

This setting is made for each screen separately.

This setting cannot be made for projects and groups.

Do not arrange web parts in the screen that this setting is made.

3. Select the "PDF Page" tab.

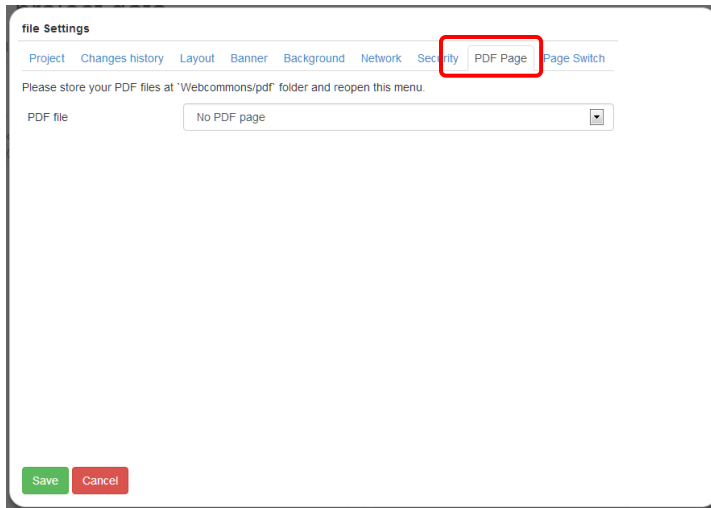

*: For canceling the PDF page, select "No PDF page", and save. After the setting is complete, the icon in the screen changes to the normal icon.

4. Select a PDF file you want to display, and save the setting.

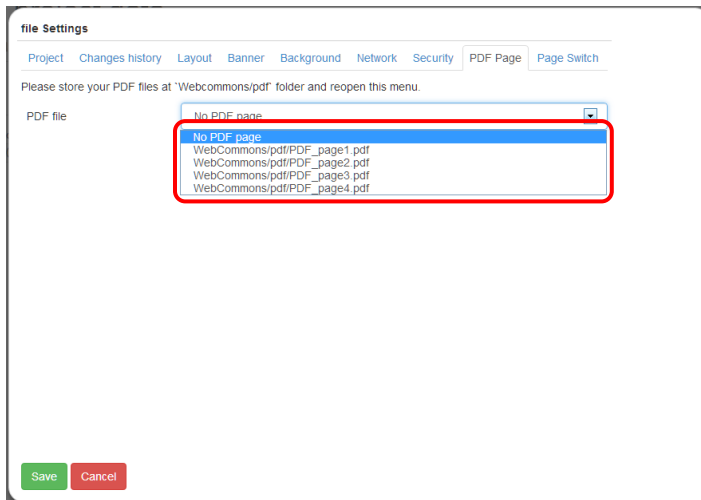

*: Once the PDF screen setting is complete, the icon changes to that of PDF file.

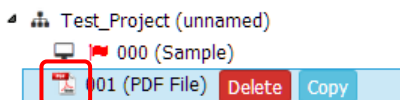

A page set in the PDF screen is displayed as follows.

* The operation differs according to the browser used.

Google Chrome, Opera, Fire Fox: The file is downloaded.

Internet Explorer: The PDF screen is displayed on the browser.

When using Google Chrome, Opera, or Fire Fox, the PDF screen can be displayed by selecting the downloaded PDF screen.

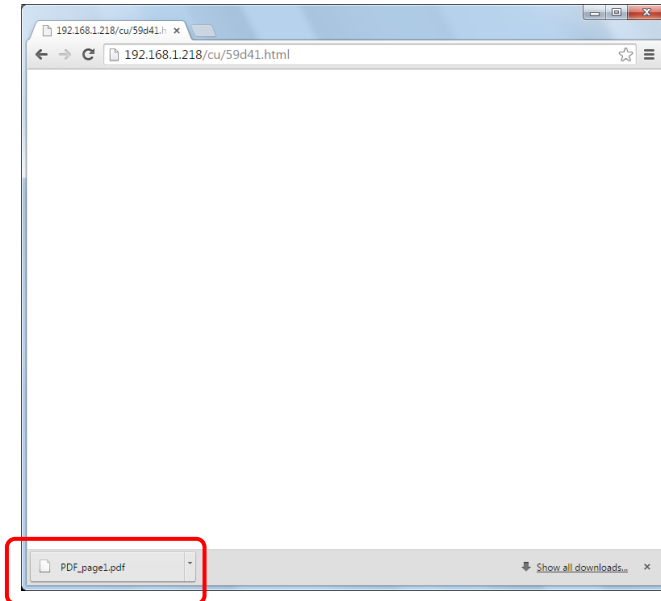

When using Google Chrome, the file can be displayed by selecting the downloaded file from the bar at the bottom of the browser.

For returning from the display screen, use the Back button on the browser.

The displayed PDF screen can be printed or stored in a PC or tablet.

The screen number can be notified to the PLC and the screen can be switched from the PLC when displaying the PDF screen.

For Google Chrome, a file downloaded to a PC from the browser can be referred by the following operation.

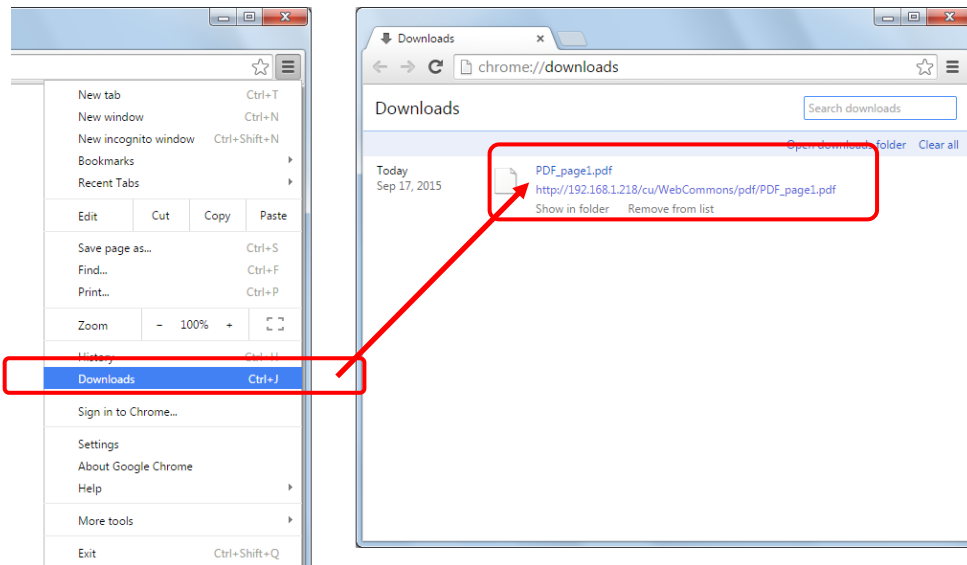

Select "Downloads" from the menu, and select a file you want to refer from the list of downloaded files.



When using Internet Explorer, as a PDF file is displayed on the browser, it should be saved manually for saving it in the PC.

For saving the currently displayed PDF file from Internet Explorer, select "Save as..." from the "File" menu.

3.5.8.5 Page Switch Setting

Pages displayed on a browser can be controlled from the PLC by setting triggers.

The page switch function is not available for Eco-POWER METER.



◆ PROCEDURE

1. Display the advanced setting screen.

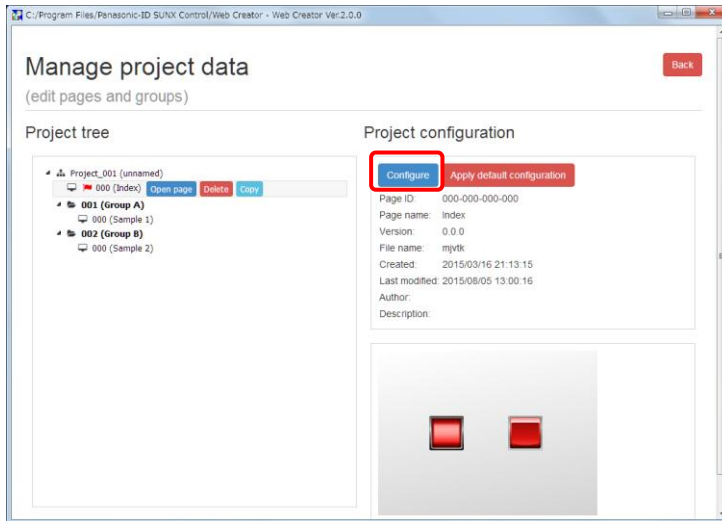

This setting can be made for each project, group, and screen.

2. Select the "Page Switch" tab.

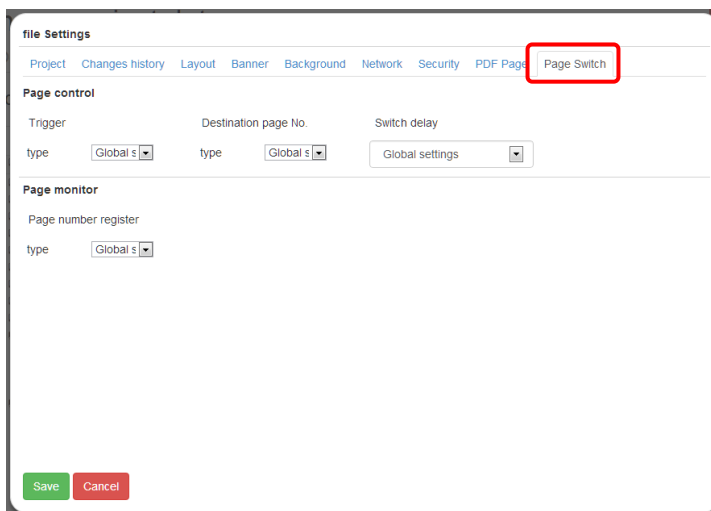

3. Make the page switch setting.

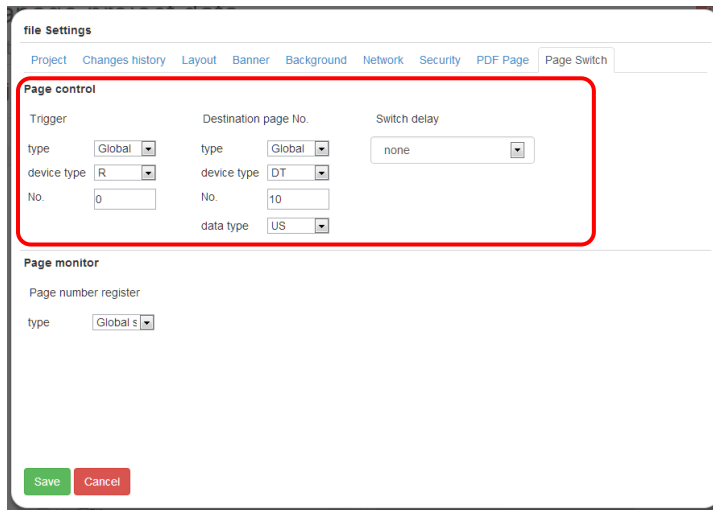

Setting item	Description
Trigger	The screen is switched when the specified trigger turns ON.
Destination page No.	Specify the starting device where a destination screen number is stored.
Switch delay	Time until the screen is switched after the trigger turns ON.

■ Data format of screen number

For specifying a screen number, store it in the device as follows.

[Destination screen number]

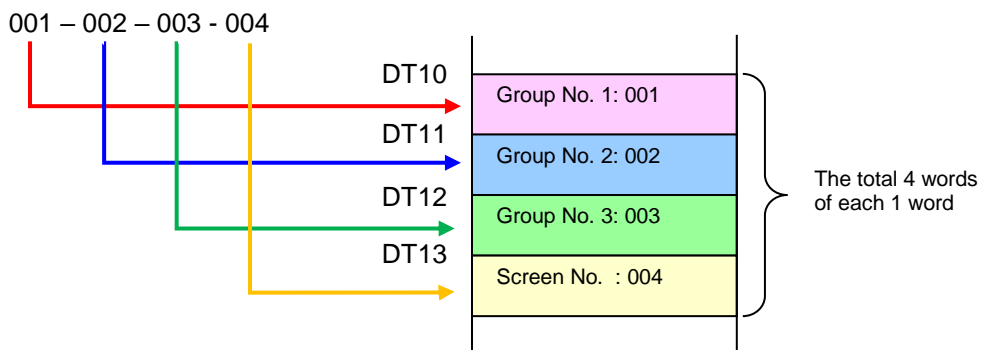

■ Method of confirming screen numbers

Screen numbers can be confirmed by the following procedure.

● Confirming from the edit screen

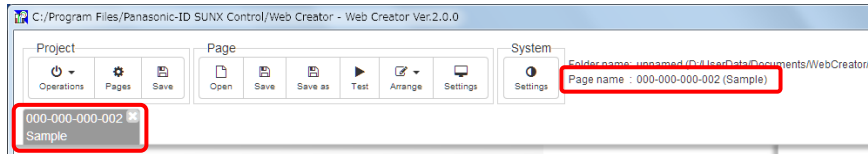

● Confirming from the management screen

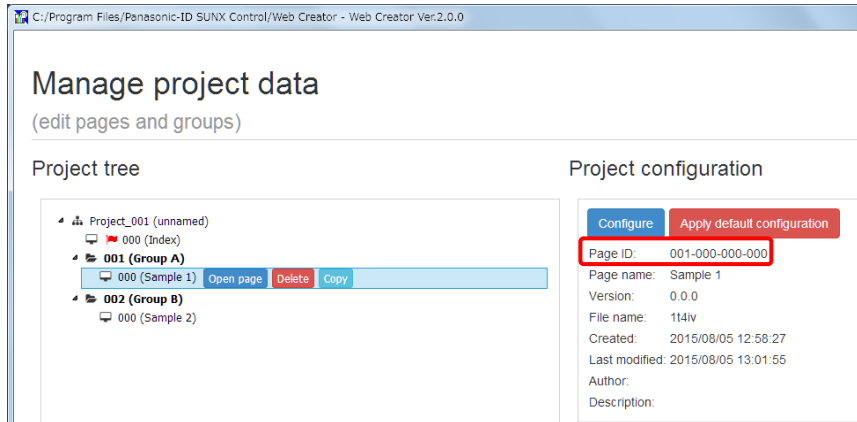

3.5.8.6 Screen Number Notification Setting

This setting enables to notify the screen number currently displayed to the PLC.

The screen number notification function is not available for Eco-POWER METER.



◆ PROCEDURE

1. Display the advanced setting screen.

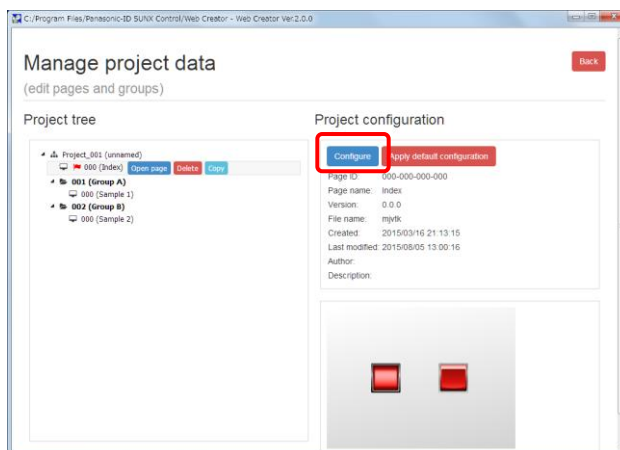

This setting can be made for each project, group, and screen.

2. Select the "Page Switch" tab.

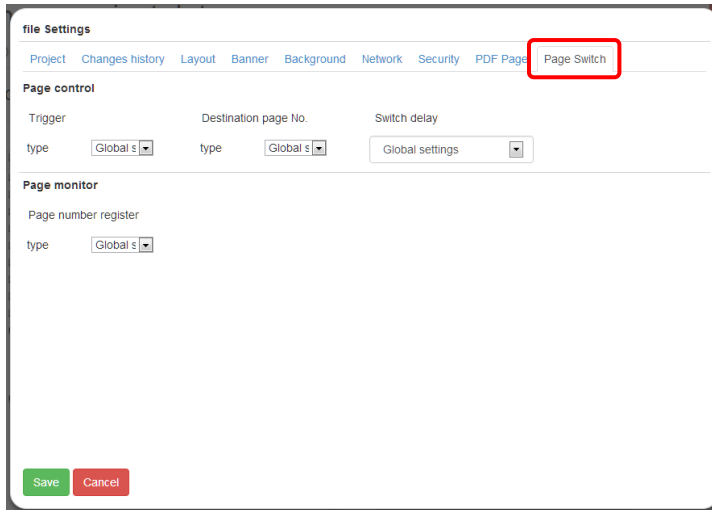

3. Make the screen notification setting.

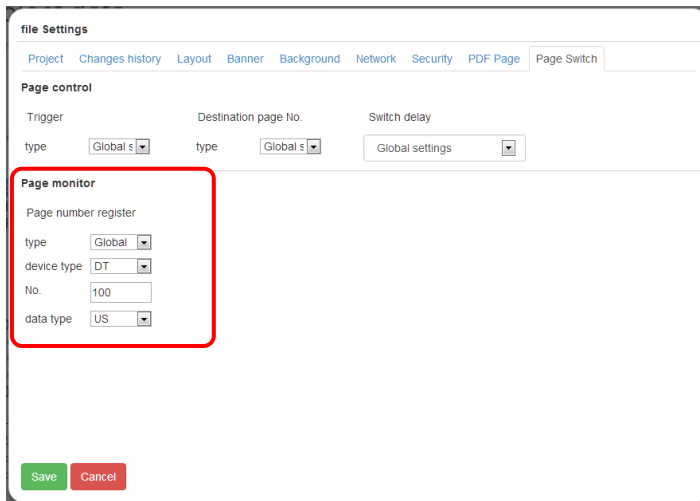

For the output of screen numbers, refer to "Data format of screen number" in "3.5.8.5 Page Switch Setting".

The screen number is notified after the display of the screen changes.

3.5.8.7 Fine Adjustment Function of Part Arrangement

The arrangement of parts can be finely adjusted using the cursor keys of a keyboard ($\uparrow/\downarrow/\leftarrow/\rightarrow$) besides dragging a mouse.

These keys can be operated together with the Shift key.

Cursor keys: Moves one pixel.

Shift + Cursor keys: Moves ten pixels.

3.5.8.8 Function for Confirming Content Size

The content size of a currently edited project can be confirmed.



◆ PROCEDURE

1. Select "Upload".

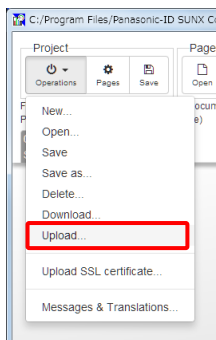

2. Press the "Check contents size" button.



3. Confirm the content capacity.



3.5.8.9 Multi-language Switching Function of Web Creator

The display language of the Web Creator is determined by the language of OS at the time of startup.

The display language is switched according to the language of OS as follows.

- Other languages: English display
- Japanese OS: Japanese display

Once the setting is changed, the selected language is also used from the next startup.



◆ PROCEDURE

1. Display the "Setting" screen.

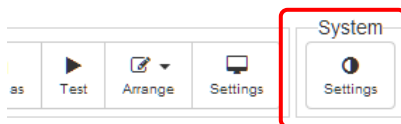

2. Select a language you want to display.

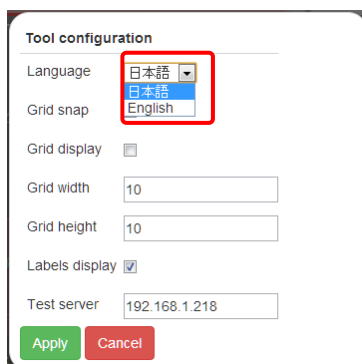

3. Select " Apply".

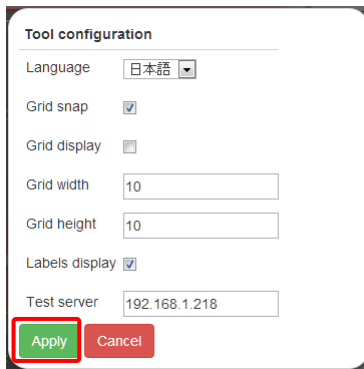

The screenshot shows a 'Tool configuration' dialog box with the following settings:

- Language: 日本語 (dropdown menu)
- Grid snap:
- Grid display:
- Grid width: 10 (text input)
- Grid height: 10 (text input)
- Labels display:
- Test server: 192.168.1.218 (text input)

At the bottom, there are two buttons: 'Apply' (highlighted with a red box) and 'Cancel'.

* Once the setting is changed, the screen changes to the start screen.

When there is an unsaved edit screen, it is confirmed whether it is saved or not.

3.5.8.10 Monitor Function

The monitor function is activated even when the content screen is not inactive.

Inactive means the states that the browser is minimized or the screen is not focused.



NOTE

- **In the Web Creator of a version older than Ver.2.0.0, the monitor function stops when the content screen is inactive. Once it becomes active again, the monitor function restarts.**

3.5.8.11 Automatic Enlargement of Attached Images

For some parts such as lamp parts and switch parts, original images prepared by a user can also be displayed besides images preliminarily prepared.

For using original images, store the images you want to use in the "WebCreator\WebCommons\img" folder in advance.

For details, refer to "2.2 Folder Structure of Web Creator".

Select the setting "design" to open the design selection screen.

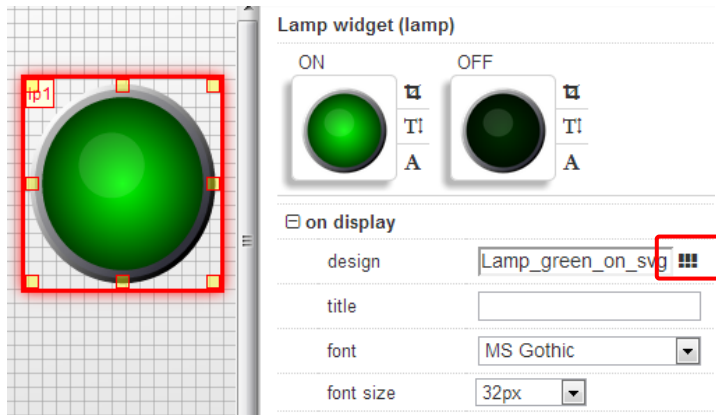

For selecting an original image, select an image file and then select an image to be replaced.

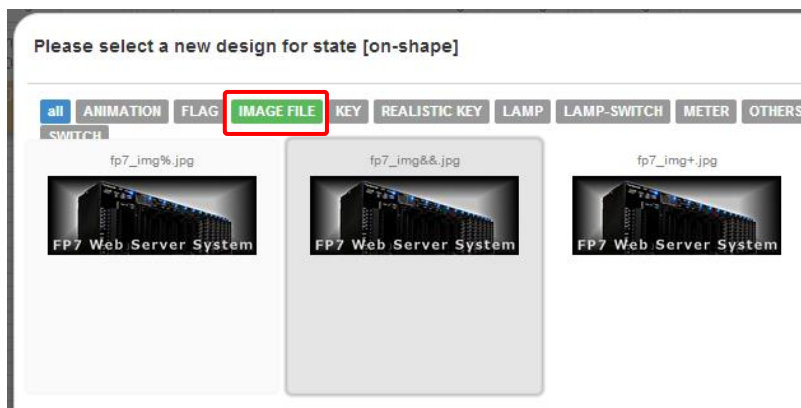

The design of the part will be replaced with the original image.

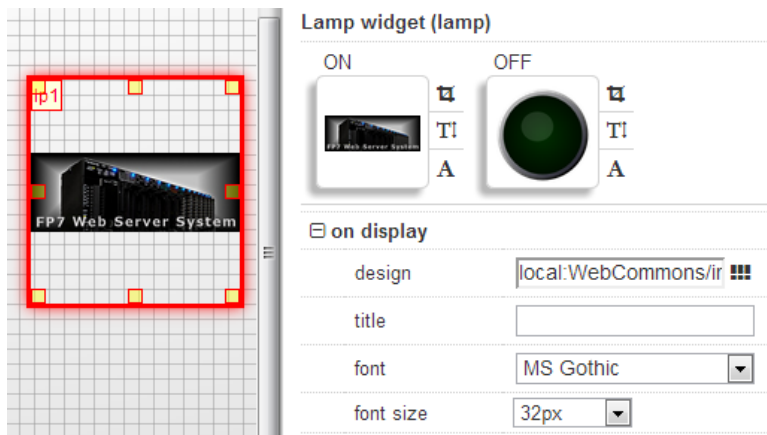

Images displayed on parts are enlarged or reduced according to each part size.

The aspect ratio of each image will be maintained even when the longitudinal and lateral sizes of the part is changed.

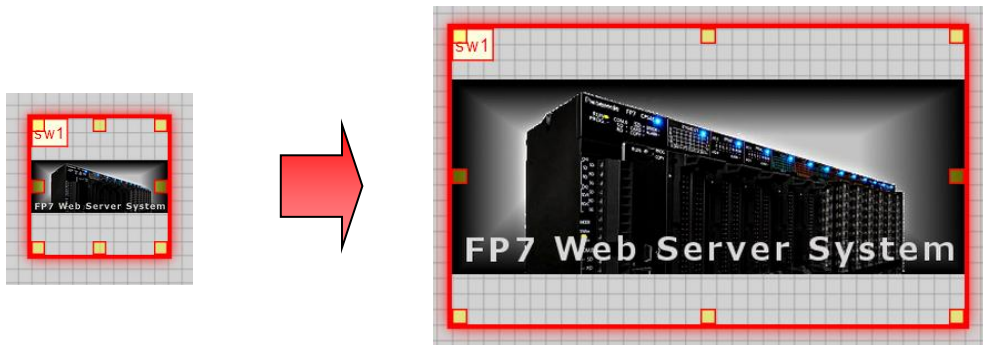

3.6 Execution Method

For executing a transferred screen, input the IP address on a browser.

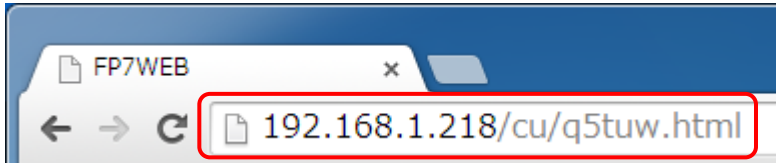

The transferred screen opens.

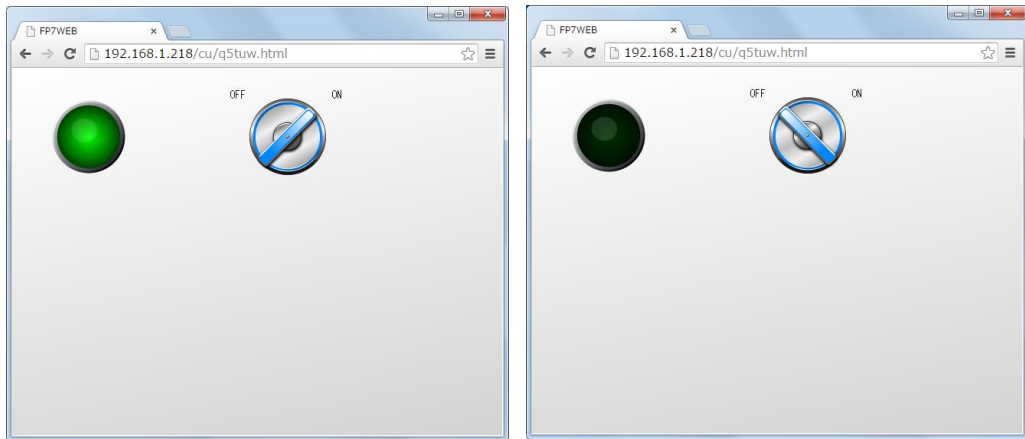

From the Web Creator Ver.2.0, the monitor function is enabled even when the browser is inactive.

3.7 Method of Closing Web Creator

For closing the Web Creator, press the "X" button in the top right corner of the screen.

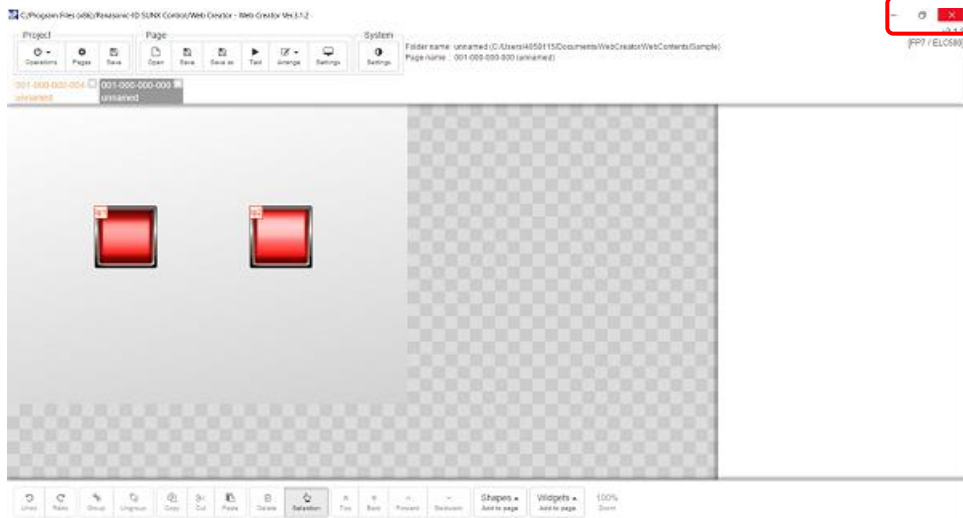

3.8 Types of Web Parts and Descriptions of Properties

This section describes the types of usable web parts and the properties.

■ Types of parts

No.	Types of parts	Description
1)	Lamp	Part whose color changes according to the ON/OFF state of a bit device.
2)	Lamp-switch	Part in which lamp and switch functions are combined.
3)	Switch	Part which turns ON/OFF a bit device.
4)	Slider	Part which operates word device values by the slide operation.
5)	Rotary-switch	Part which operates word device values by the position operation.
6)	Dialog	Part which displays a message window and switch on the screen. The message window can be displayed or hidden by turning ON/OFF the bit device.
7)	N-State	Multiple status displays are switched by word device values.
8)	Meter	A word device value is displayed with a meter.
9)	Line-graph	Displays a line graph.
10)	Bar-graph	Displays a bar graph.
11)	Extended-graph	This part in which the functions of line graph and bar graph are combined. A maximum of 32 graph displays are possible.
12)	Data	Part which displays or writes word device values.
13)	Message	Part which displays a message corresponding to a message number stored in a word device. For details of the setting method of message, refer to "3.4.10 Multilingual Message Setting".
14)	Media player	Part which reproduces a moving image file.(Exclusive parts for FP7 / ELC500)
15)	Level graph	Parts which displays graphs of multiple groups. (Exclusive parts for Eco-POWER METER)
16)	Camera	Part which can be used with a corresponding network camera manufactured by Panasonic. Camera images are displayed and the view point of the camera can be changed.
17)	Text	Part which displays a fixed character string on the screen.
18)	Table	Part which displays/writes devices in tabular form.
19)	Shapes	Part which displays an arbitrary graphic. The functions of switch and lamp parts can also be used by specifying bit devices.

■ Properties of lamp parts

Property	Description
commonparameters	Common parameters
horizontal position	X coordinate of the upper left corner of a part.
vertical position	Y coordinate of the upper left corner of a part.
width	Width of a part.
height	Height of a part.
rotation	Rotation angle of a part.
label	Item name.
security level	The security level of a parts is set from 0 (low) to 15 (high).
device	Device allocation setting
hostaddress	Destination FP7 / ELC500
networkprotocol	m7 (Fixed)
lamp status	Bit device to be referred
lamp status mode	a-contact / b-contact
blinking	Blink or not blink
blinking bit	Bit device to be referred for blinking.
blinking bit mode	a-contact / b-contact
host address	a-contact / b-contact
ondisplay	Display setting when a lamp is on.
design	Image displayed when the lamp status is ON.
title	Character string displayed when the lamp status is ON.
font	Font of the character string displayed when the lamp status is ON.
font size	Size of the character string displayed when the lamp status is ON.
placement	Position of the character string displayed when the lamp status is ON.
text color	Color of the character string displayed when the lamp status is ON.
text decoration	Modification of the character string displayed when the lamp status is ON.
offdisplay	Display setting when a lamp is off.
design	Refer to the descriptions of the ON state.
title	
font	
font size	
placement	
text color	
text decoration	
test	Display confirmation setting when editing a screen.
turn on	Turns ON/OFF a lamp.

■ Properties of lamp-switch parts

Property	Description
common parameters	Refer to the descriptions of lamp parts.
device	Device allocation setting
host address	Refer to the descriptions of lamp parts.
network protocol	
switch read device	Bit device for referring to the status of a switch.
switch write device	Bit device for writing the status of a switch.
switch mode	Set/Reset/Momentary-set/Invert
interlock device	Bit device for referring to the valid or invalid state of switch operation.
interlock mode	a-contact / b-contact
lamp status	Refer to the descriptions of lamp parts.
lamp status mode	
blinking	
blinking bit	
blinking bit mode	
methods	Operation settings for operating buttons.
on-up methods	Operation that the lamp on button is returned.
on-down methods	Operation that the lamp on button is pressed.
off-up methods	Operation that the lamp off button is returned.
off-down methods	Operation that the lamp off button is pressed.
sound	Operation sound settings
up beep	Sound when a button is returned.
down beep	Sound when a button is pressed.
on/up display	Display settings when the lamp on button is returned.
design	Image
title	Character string
font	Font of the character string
font size	Size of the character string
placement	Display position of the character string
text color	Color of the character string
text decoration	Modifications of the character string
on/down display	Display settings when the lamp on button is pressed.
design	Refer to on/down display.
title	
font	
font size	

■ Properties of lamp-switch parts (continued)

Property	Description
placement	Refer to on/down display
text color	
text decoration	
off/up display	Display settings when the lamp off button is returned.
design	Refer to on/down display
title	
font	
font size	
placement	
text color	
text decoration	
off/down display	Image when the lamp off button is pressed
design	Refer to on/down display
title	
font	
font size	
placement	
text color	
text decoration	
test	Display confirmation setting when editing a screen.
turn on	Turns ON/OFF a lamp.
release	Turns ON/OFF a switch.

■ Properties of switch parts

Property	Description
common parameters	Refer to the descriptions of lamp parts.
device	Refer to the descriptions of lamp-switch parts.
methods	Operation settings for operating switches.
up methods	Operation when the button is returned/up (on the left).
down methods	Operation when the button is pressed/down (on the right).
sound	Refer to the descriptions of lamp-switch parts.
up beep	Refer to the descriptions of lamp-switch parts.
down beep	Refer to the descriptions of lamp-switch parts.

■ **Properties of switch parts (continued)**

Property	Description
up display	Display setting when a lamp is on.
design	Image displayed when the switch read device is ON.
title	Character string displayed when the switch read device is ON.
font	Font of the character string displayed when the switch read device is ON.
text size	Size of the character string displayed when the switch read device is ON.
placement	Position of the character string displayed when the switch read device is ON.
text color	Color of the character string displayed when the switch read device is ON.
text decoration	Modification of the character string displayed when the switch read device is ON.
down display	Display setting when a lamp is off.
design	Refer to the descriptions of the state when a lamp is UP.
title	
....	
text color	
text decoration	
test	Display confirmation setting when editing a screen.
release	Turns ON/OFF a switch.

■ **Properties of slider parts**

Property	Description
common parameters	Refer to the descriptions of lamp parts.
device	Refer to the descriptions of data parts.
operation	Settings related to the operation of parts.
minimum value	Output value to devices when the slider is set to minimum.
maximum value	Output value to devices when the slider is set to maximum.
output	discrete: The slide can be moved at certain graduated intervals. continuous: The slide can also be set between graduated intervals.
control method	click: The slide operation is performed only by a click operation. drag: The slide operation is performed by a click operation or drag operation.
display	Settings related to the display of parts.
design	Design of a part
orientation	Sliding direction
frame type	Appearance design of a part
color	Color of a part
steps	Number of memories of a part
test	Display confirmation setting when editing a screen.
value	Display value

■ Properties of rotary switch parts

Property	Description
common parameters	Refer to the descriptions of lamp parts.
device	Refer to the descriptions of data parts.
operation	Refer to the descriptions of slider parts.
display	Settings related to the display of parts.
design	Design of a part
frame type	Shape of a part
frame design	Appearance of a part
cursor	Shape of a cursor
show graduations	Display setting of values
color	Color of a part
steps	Number of memories of a part
test	Display confirmation setting when editing a screen.
value	Turns ON/OFF a switch.

■ Properties of dialog parts

Property	Description
common parameters	Refer to the descriptions of lamp parts.
device	Device allocation setting
host address	Refer to the descriptions of lamp parts.
network protocol	
dialog bit device	Readout destination bit device
dialog bit mode	a-contact / b-contact
methods	Button operation of a dialog
button No.1 methods	Method to be executed when button No.1 is pressed.
button No.2 methods	Method to be executed when button No.2 is pressed.
button No.3 methods	Method to be executed when button No.3 is pressed.
button No.4 methods	Method to be executed when button No.4 is pressed.
display	Display setting of a dialog
title	Title of a dialog
title size	Character size of a title
title font	Character font of a title
text	Main text of a dialog
text size	Character size of a title
text font	Character font of a title

■ **Properties of dialog parts (continued)**

Property	Description
display	Display setting of a dialog
button 1 label	Character string displayed in " button 1".
button 1 color	Color of button 1
button 2 label	Character string displayed in " button 2".
button 2 color	Color of button 2
button 3 label	Character string displayed in " button 3".
button 3 color	Color of button 3
button 4 label	Character string displayed in " button 4".
button 4 color	Color of button 4
button size	Character size displayed in a dialog.
button font	Font of characters

■ **Properties of N-state parts**

Property	Description
common parameters	Refer to the descriptions of lamp parts.
device	Device allocation setting
host address	Refer to the descriptions of lamp parts.
network protocol	
state device	Word address for referring to the state
animation	Display switch setting by status
design for state #0	Shape displayed when the state device value is 0.
...
design for state #15	Shape displayed when the state device value is 15.
display	Display settings
title	Title character string of a part
title font	Font of title characters
title size	Size of title characters
placement	Display position of title character string
color	Color of title characters
decoration	Modification of title character string
test	Display confirmation setting when editing a screen.
state	Status display

■ Properties of meter parts

Property	Description
common parameters	Refer to the descriptions of lamp parts.
device	Device allocation setting
host address	Refer to the descriptions of lamp parts.
network protocol	
measure device	Word device to be referred
display	Display settings
design	Image of a meter
measure	Scaling settings of a meter
input min	Minimum value of input data
input max	Maximum value of input data
display min	Minimum value of display data
display max	Maximum value of display data
hold min	Setting for displaying/hiding hold values on the meter
hold max	Setting for displaying/hiding hold values on the meter
ranges	Settings of low, middle and high ranges of a meter
low range threshold	Threshold of low range
high range threshold	Threshold of high range
low range color	Color of the low range area
middle range color	Color of the middle range area
high range color	Color of the high range area
test	Display confirmation setting when editing a screen.
value	Display value

■ Properties of line/bar graph parts

Property	Description
common parameters	Refer to the descriptions of lamp parts.
device	Device allocation setting
host address	Refer to the descriptions of lamp parts.
network protocol	
read device	Reference word device of series 1
line color	Line/bar color of series 1
read device	Reference word device of series 2
line color	Line/bar color of series 2
read device	Reference word device of series 3
line color	Line/bar color of series 3

■ **Properties of line/bar graph parts (continued)**

Property	Description
device	Device allocation setting
read device	Reference word device of series 4
line color	Line/bar color of series 4
graph	Graph settings
mode	Graph type
refresh period	Update cycle
max points	Max. number of points
ymin	Minimum value of Y axis
ymax	Maximum value of Y axis
border width	Width of a graph border
border color	Color of a graph frame
fill color	Background color of a graph
line width	Line width of a line graph (This is not set for bar graphs.)
legend	Display position of a legend
style	Display setting of a graph
tick	X-axis scale settings
interval	Scale interval
color	Color of an axis label
size	Size of an axis label
title	Title setting of a graph
text	Title character string
alignment	Title arrangement
color	Title color
title size	Title size
title font	Title font

■ Properties of extended graph parts

Property	Description
common parameters	Refer to the descriptions of lamp parts.
device	Device allocation setting
host address	Refer to the descriptions of lamp parts.
network protocol	
graph	Graph settings
mode	Graph type
scatter diagram	Selection of scatter diagram (Operation mode: Displayed only when selecting array)
refresh period	Update cycle
max points	Max. number of points
Zoom controls	Display of the control for magnifying/reducing graphs
Controls background	Background color of the zoom control
Controls text color	Character color of the zoom control
initial display	Initial display position of a graph (Operation mode: Displayed only when selecting array)
Magnification (1=all view)	Display magnification of an initial display position
fill color	Background color of a graph
selectable sources	This is used to set to enable/disable the switch between displaying and hiding graphs.
grid border color	Color of a graph frame
grid fill color	Background color of a graph
legend	Legend settings
display position	Display position of a legend
overlay display	Unchecked: Legends are always displayed, Checked: Legends are displayed by clicking a graph.
font size	Character size of a legend
text font	Font of a legend
decoration	Modification of a legend
legend text color	Character color of a legend
legend background	Background color of a legend
xaxis	Horizontal axis settings of a graph
* This can be specified only when array graph has been set	
type	Select Value or Time for the display method of scales.
first value	Start value of the scale
X magnification	Conversion magnification of scale values
X unit	Scale unit

■ Properties of extended graph parts

Property	Description
x text size	Character size
x text color	Character color
x tick color	Scale line color
xaxis time unit	x-axis time unit
yaxis	Vertical axis settings of a graph
left axis min	Minimum value of the left axis (When this is blank, it is automatically set.)
left axis max	Maximum value of the left axis (When this is blank, it is automatically set.)
left axis type	Graph interval setting (linear / log10 / log n)
left text size	Character size of the left axis
left text color	Character color of the left axis
left tick color	Scale line color of the left axis
left upper limit	Unit of the left axis
left upper limit value	Checked: The upper limit value of the left axis is displayed on a graph.
left upper limit color	Color of the upper limit value of the left axis
left upper limit width	Width of the upper limit line of the left axis
left lower limit value	Checked: The lower limit value of the left axis is displayed on a graph.
left lower limit color	Color of the lower limit value of the left axis
left lower limit width	Width of the lower limit line of the left axis
right axis min	Minimum value of the right axis (When this is blank, it is automatically set.)
right axis max	Maximum value of the right axis (When this is blank, it is automatically set.)
right axis type	Graph interval setting (linear / log10 / log n)
right text size	Character size of the right axis
right text color	Character color of the right axis
right tick color	Scale line color of the right axis
right upper limit	Unit of the right axis
right upper limit value	Checked: The upper limit value of the right axis is displayed on a graph.
right upper limit color	Color of the upper limit value of the right axis
right upper limit width	Width of the upper limit line of the right axis
right lower limit value	Checked: The lower limit value of the right axis is displayed on a graph.
right lower limit color	Color of the lower limit value of the right axis
right lower limit width	Width of the lower limit line of the right axis

Properties of extended graph parts (continued)

Property	Description
title	Refer to the descriptions of line/bar graph parts.
Data source #1 to 8	Data settings for a graph
read device	Monitored worde device
label	Name displayed with a legend
initial visibility	Switches between displaying and hiding data.
interpolation	Enables/disables the interpolation display of data.
yaxis	Selection of data vertical axis (left/right)
display mode	Display type of data (line/symbol/bar/line+symbol)
line	Line width of data
line width	Line color of data
line color	Line color of data
fill color	Point or bar color of data
symbol	Point shape of data
symbol size	Point size of data
Data source #9 to 16	Refer to the descriptions of data #1 to 8.
Data source #17 to 24	Refer to the descriptions of data #1 to 8.
Data source #25 to 32	Refer to the descriptions of data #1 to 8.

■ Properties of data parts

Property	Description
common parameters	Refer to the descriptions of lamp parts.
device	Device allocation setting
host address	Refer to the descriptions of lamp parts.
network protocol	
read device	Readout destination word device
write device	Write destination word device
write index device	Write destination word device for index modification
enable bit device	Bit device for referring to the valid state of operation
enable mode	a-contact / b-contact
notification device	Destination bit device of notice of changes by input
reset notification	Output method of notice of changes
peak hold	Peak hold device setting
min value	Destination internal device for updating minimum values.
max value	Destination internal device for updating maximum values.
data format	Number format setting
refresh period	Update cycle of display values.
format	Select binary,octal,hexadecimal.
number of digits	Number of digits
zero padding	Pad or not pad upper digits with zeroes.
prefix	Character string added before display values
suffix	Character string added after display values
format	Select decimal.
number of digits	Number of digits
number of decimals	Decimal display digit
zero padding	Pad or not pad upper digits with zeroes.
show plus sign	Display or not display a + sign.
prefix	Character string added before display values
suffix	Character string added after display values
format	Select string 0 / string 1 / string 2.
max-length	Maximum number of input characters (Size of a character string area when specifying string 2)
null terminated	Without check: Not add NULL at the time of input, Checked: Add NULL at the time of input * This can be specified only when String 0 has been set.
prefix	Character string added before display values
suffix	Character string added after display values

■ Properties of data parts (continued)

Property	Description
data format	Number format setting
format	Select Time (BCD) or Time (ASCII).
display format	Select DATE, TIME or DATE&TIME.
date format	Select a display format of year, month and day. (Selectable in the case of DATE or DATE&TIME)
time format	Select a display format of hour, minute and second. (Selectable in the case of DATE or DATE&TIME)
prefix	Character string added before display values
suffix	Character string added after display values
text format	Text settings
alignment	Horizontal direction display position of character strings
vertical alignment	Vertical direction display position of character strings
color	Color of the character string
decoration	Modification of the character string
text size	Size of the character string
text font	Font of the character string
frame format	Frame settings
fill color	Background color
border style	Border type
border color	Border color
border radius	Rounds the corners of a frame.
border width	Width of a border
shadow pos	Shadow position of a border
shadow dist	Spread of shadow
shadow blur dist	Spread of blur
shadow color	Shadow color
shadow inset	Shadow of concave
ranges	Threshold values of upper and lower limits and display settings
low range threshold	Specify a threshold of low range.
low range text color	Set the font color when an acquired value is in the low range.
low range fill color	Set the background color when an acquired value is in the low range.
low range border color	Set the frame color when an acquired value is in the low range.
high range threshold	Specify a threshold of high range.
high range text color	Set the font color when an acquired value is in the high range.
high range fill color	Set the background color when an acquired value is in the high range.
high range border color	Set the frame color when an acquired value is in the high range.
test	Display confirmation setting when editing a screen.
value	Display value

■ **Properties of data parts (continued)**

Property	Description
input range	Range of input data
input max value	Upper limit value of input data
input min value	Lower limit value of input data

■ Properties of message parts

Property	Description
common parameters	Refer to the descriptions of lamp parts.
device	Device allocation setting
host address	Refer to the descriptions of lamp parts.
network protocol	
block id device	Acquisition destination word device of a message definition number
text format	Refer to the descriptions of data parts.
scroll	Scroll settings of character strings
direction	Scroll direction
delay	Scroll interval
duration	Scroll time
duplicated	Repeat of scroll
pause on mouseover	Pause by mouse
frame format	Refer to the descriptions of data parts.
test	Display confirmation setting when editing a screen.
message	Displayed character string

■ Properties of media player parts

Property	Description
common parameters	Refer to the descriptions of lamp parts.
device	Device allocation setting
host address	Refer to the descriptions of lamp parts.
network protocol	
play bit device	Bit device for starting reproduction
play bit mode	a-contact / b-contact
pause bit device	Bit device for pausing reproduction
pause bit mode	a-contact / b-contact
stop bit device	Bit device for stopping reproduction
stop bit mode	a-contact / b-contact
playback	Control setting of play
media file	Moving image file to be played
autoplay	Play/stop for the initial display
loop	Repeat of play
manual control	Display/hide the control panel for play.

■ Properties of level graph parts

Property	Description
common parameters	Refer to the descriptions of lamp parts.
device	Device allocation setting
host address	Refer to the descriptions of lamp parts.
network protocol	
Number of groups	Setting for the number of groups in a graph.
group 1 to 16	Individual setting for each group.
name	Graph name displayed on the horizontal axis.
number of points	Displays the data for the number of monitoring points in a group.
device	Starting device of continuous monitoring..
graph	Display setting of a graph
fill color	Background color of level graph parts.
bar border color	Frame color of bar graphs.
bar fill color	Filling color of bar graphs.
grid border color	Frame color of displaying graphs.
grid fill color	Background color within the frame of displaying graphs.
legend	Legend setting
visibility	Without check: Hide legends, Checked: Always display legends.
font size	Character size of legends.
display monitor #1	Character string of legend #1.
display monitor #2	Character string of legend #2.
display monitor #3	Character string of legend #3.
xaxis	Horizontal axis setting of a graph
x text size	String size displayed on the horizontal axis.
x text color	String color displayed on the horizontal axis.
bar width	Width of a bar graph.
bar interval	Graph display interval in a group.
group interval	Graph display interval between groups.
yaxis	Vertical axis setting of a graph
left axis min	Minimum value of the left axis (When this is blank, it is automatically set.)
left axis max	Maximum value of the left axis (When this is blank, it is automatically set.)
left axis type	Graph interval setting (linear / log10 / log n)
number of decimals	Display value setting by multiplying by 10(0-n).
left text size	Character size of the left axis
left text color	Character color of the left axis
left tick color	Scale line color of the left axis
title	Title setting of a graph
text	Title character string
alignment	Title arrangement
color	Title color
title size	Title size
title font	Title font

■ Properties of camera parts

Property	Description
disable frame	Switching of the display frame of camera parts
common parameters	Refer to the descriptions of lamp parts.
camera	Camera settings
model	Camera model setting
connection method	http/https
camera address	IP address of a camera
user ID	User ID of a camera
password	Password of a camera
refresh rate	Image update cycle of a camera
control	Display/hide the control panel for camera.
controls size	Operation button size of a camera
Method 1 to 8	Camera operation setting
control bit	Bit device for starting operation
preset	Capturing direction setting
zoom level	zoom-up setting
brightness	Image brightness setting
snapshot frame	Label of a shape part saved
frame format	Refer to the descriptions of data parts.
title format	Title settings of a camera
title	Title character string
title font	Title font
title size	Title size
placement	Title arrangement
color	Title color
decoration	Title character modification

■ **Properties of text parts**

Property	Description
common parameters	Refer to the descriptions of lamp parts.
text format	Refer to the descriptions of data parts.
text	Character string
alignment	Refer to the descriptions of data parts.
vertical alignment	
color	
decoration	
text size	
text font	
scroll	Refer to the descriptions of message parts.

■ **Properties of table parts**

Property	Description
common parameters	Refer to the descriptions of lamp parts.
table	Appearance of a table
number of rows	Number of lines of a table
number of columns	Number of columns of a table
device	Appearance of a table
host address	Refer to the descriptions of lamp parts.
network protocol	
* This can be specified only monitoring cell	
read device	Readout destination word device of the starting cell of monitor column group
read index device	Readout destination word device for index modification of whole monitor column group
read device step	Specification of an increment address between cells in monitor column group
read mode	Timing of reading devices (Repeat, Only once when trigger occurs)
read timing	Bit device to be a read trigger
write device	Write destination word device of the starting cell of monitor column group
write index device	Write destination word device for index modification of whole monitor column group
write device step	Specification of an increment address between cells in monitor column group
enable bit device	Bit device for referring to the valid state of operation
enable mode	a-contact / b-contact
notification device	Destination bit device of the notice of changes by input
reset notification	Output method of the notice of changes

■ **Properties of table parts (continued)**

Property	Description
peak hold	Refer to the descriptions of data parts.
data format	Refer to the descriptions of data parts.
text format	Refer to the descriptions of data parts.
ranges	Cell frame setting
outer border	Checked: The top, right, bottom and left frames are collectively changed arbitrarily.
border top style	Modification of cell's top border
border right style	Modification of cell's right border
border bottom style	Modification of cell's bottom border
border left style	Modification of cell's left border
border inner style	Modification of the inside line of cell range
border top color	Color of cell's top border
border right color	Color of cell's right border
border bottom color	Color of cell's bottom border
border left color	Color of cell's left border
border inner color	Color of the inside line of cell range
border top width	Width of cell's top border
border right width	Width of cell's right border
border bottom width	Width of cell's bottom border
border left width	Width of cell's left border
border inner width	Width of the inside line of cell range
fill color	Background color of cells
ranges	Thresholds of low and high ranges and the display setting
low range threshold	Threshold of low range
low range text color	Character color when an acquired value is in the low range
low range fill color	Background color when an acquired value is in the low range
low range border color	Frame color when an acquired value is in the low range
high range threshold	Threshold of high range
high range text color	Character color when an acquired value is in the high range
high range fill color	Background color when an acquired value is in the high range
high range border color	Frame color when an acquired value is in the high range

■ Properties of shapes parts

Property	Description
common parameters	Common parameters
horizontal position	X coordinate of the upper left corner of a part.
vertical position	Y coordinate of the upper left corner of a part.
width	Width of a part.
height	Height of a part.
rotation	Rotation angle of a part (This is not set for linear shapes.)
label	Item name
security level	The security level of a parts is set from 0 (low) to 15 (high).
device	Device allocation setting
host address	Refer to the descriptions of lamp parts.
network protocol	
lamp status	
lamp status mode	
blinking	
blinking bit	
blinking bit mode	
switch write device	Refer to the descriptions of switch parts.
switch mode	
interlock device	
interlock mode	

■ Properties of shapes parts (continued)

Property	Description
methods	Operation setting when operating shapes
on methods	Operation when a button is pressed
off methods	Operation when a button is returned
sound	Refer to the descriptions of lamp switch parts.
on display	Display setting when a lamp is on.
fill color	Color displayed when the lamp status is ON.
line color	Color of the line displayed when the lamp status is ON.
line width	Thickness of the line displayed when the lamp status is ON.
off display	Display setting when a lamp is off. Refer to the descriptions of the display of the on state.
test	Display confirmation setting when editing a screen.
turn on	Turns ON/OFF a lamp.

4

FP7 System Web Function

4.1 Overview of FP7 System Web

■ What is FP7 System Web?

The FP7 system web is a content prepared for the FP7 CPU unit as standard.

The basic information and operation state of FP7 can be monitored on a browser by using this function.

■ Screen configuration

Screen configuration of FP7 system web

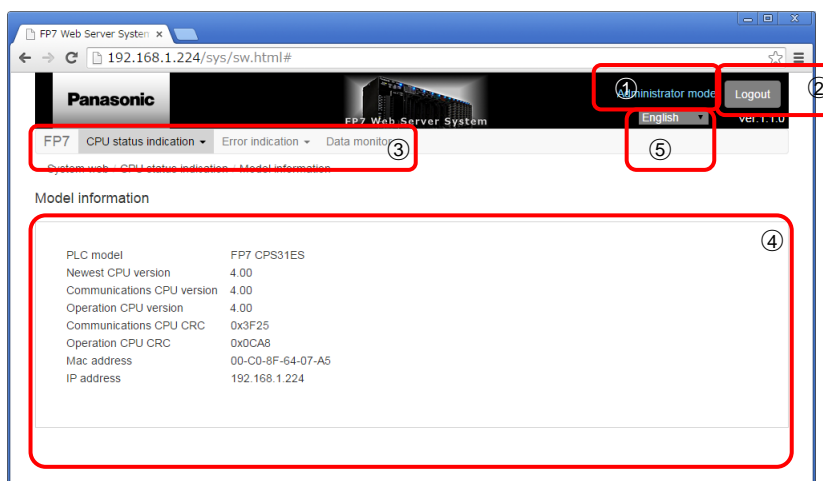

- ① Administrator mode : Displays the logged-in user level.
 - 1) For administrator: Administrator mode (Blue)
 - 2) For user : No indication
- ② Logout : Returns to the login screen.
- ③ System menu : The menu for selecting functions.
 - 1) FP7 : Links to our product (FP7) site.
<https://industrial.panasonic.com/ac/e/fasys/plc/plc/fp7/>
 - 2) CPU status indication : Displays the FP7 model information, operation state and system monitor area.
 - 3) Error indication : Displays unit errors and error alarm relays.
 - 4) Data monitor : Monitors the data of a specified device.
- ④ Drawing area : Displays the screen of a selected function.
- ⑤ Change language : Switches the language between Japanese and English.

4.2 Login Screen

It is necessary to log in the FP7 web server before starting the FP7 system web screen.

Enter a user ID and password on the login screen.

*** When the FP7 unit is password-protected, you can only log in with a registered ID and password.**

1. Enter "User ID" and "Password" on the start-up screen and click the Login button.



When entering User ID or Password failed, the following message is displayed.

Until the third try	User ID or Password is invalid.
From the fourth try	FP7 was locked because it had failed in log in three times. Please reboot FP7. (The system is restored when the unit is rebooted or one hour elapses.)



KEY POINTS

The user ID and password to log in the FP7 system web varies by the security setting of FP7 CPU unit.

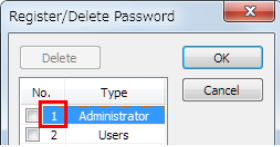
Security setting	User ID and Password
None	Connect as a master user. User ID: 0, Password: Not required
FPWIN GR7S security settings (FP7 only)	User ID: Number for administrator used when the password has been registered. (Figure below) Password: Administrator password used when the password has been registered.  (How to confirm) "Tools" > "PLC Security Settings" > "Register/Delete Password"
FPWIN Pro7 security settings	User ID: 1, Password: Password registered in Security Settings. (How to confirm) "Online" > "Security Settings"



NOTES

It is recommended not to save input information on User ID and Password in browsers for security reasons. If they are already saved, it is recommended to delete them. For information on the deletion method, see each browser setting you use.

4.3 CPU status indication > Model information Screen

Displays the information on the FP7 CPU model.

■ Model information screen

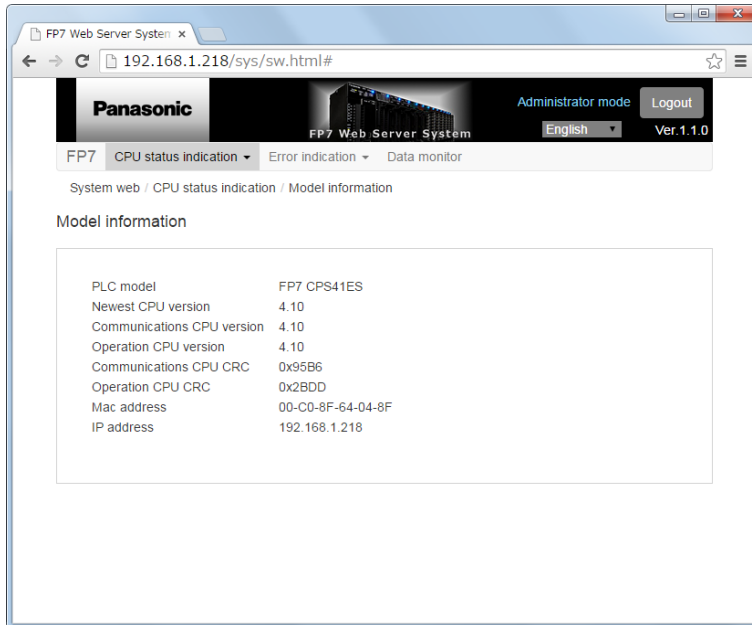

● Model information

- 1) PLC model : Displays the model name (FP7 CPSxxx).
- 2) Newest CPU version : Displays the latest CPU version.
- 3) Communications CPU version: Displays the communication CPU version.
- 4) Operation CPU version : Displays the operation CPU version.
- 5) Communications CPU CRC : Displays the communication CRC in hexadecimal.
- 6) Operation CPU CRC : Displays the operation CRC in hexadecimal.
- 7) Mac address : Displays the MAC address.
- 8) IP address : Displays the IP address.

4.4 CPU status indication > Operation state Screen

Displays the operating condition of the FP7 CPU unit.

Common function to each screen

Monitor executing/stopped button:

In the case of Monitor executing: Updates and displays data at the interval of one second.

In the case of Monitor stopped: Stops the update processing.

PLCDateTime: The PLD date is displayed by yy/mm/dd (day of the week) and hh:mm:ss.

■ When selecting "Basic information"

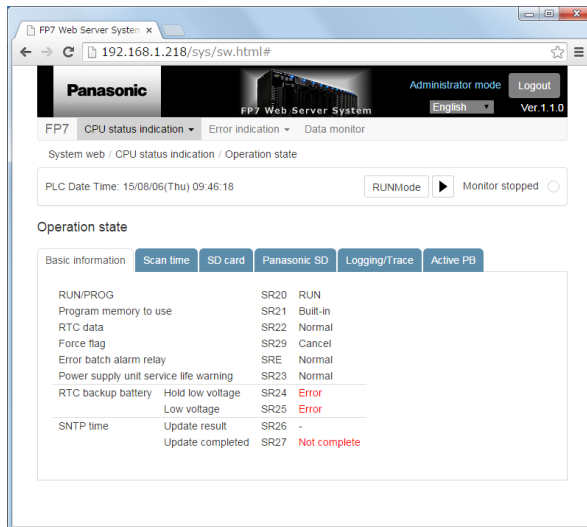

● Basic information

When the display content is "Error", "Force", or "Not complete", it is displayed in red.

- 1) RUN/PROG : Displays the status, running or program mode (RUN/PROG).
- 2) Program memory to use : Displays the operating program memory (Built-in/SD).
- 3) RTC data : Displays the RTC data (Normal / Error).
- 4) Force flag : Displays the Force flag (Cancel / Force).
- 5) Error batch alarm relay : Displays the Error batch alarm relay (Normal / Error).
- 6) Power supply unit service life warning : Displays the Power supply unit service life warning (Normal / Error).
- 7-1) RTC backup battery : Displays the battery voltage drop hold (Normal / Error).
- 7-2) RTC backup battery : Displays the battery voltage drop real (Normal / Error).
- 8-1) SNTP time : Displays the update result (Normal / Error).
- 8-2) SNTP time : Displays the update completion (complete / Not complete).

■ When selecting the "Scan time" tab

The screenshot shows a web browser window titled 'FP7 Web Server System' with the URL '192.168.1.218/sys/sw.html#'. The page header includes the Panasonic logo, 'Administrator mode', 'Logout', 'English', and 'Ver.1.1.0'. The main navigation menu contains 'FP7', 'CPU status indication', 'Error indication', and 'Data monitor'. The breadcrumb trail is 'System web / CPU status indication / Operation state'. The 'PLC Date Time' is '15/08/06(Thu) 09:57:33'. There are 'RUNMode' and 'Monitor stopped' buttons. Under 'Operation state', several tabs are visible: 'Basic information', 'Scan time', 'SD card', 'Panasonic SD', 'Logging/Trace', and 'Active PB'. The 'Scan time' tab is active and displays a table with the following data:

		Scan time
Current value	SD22	40 μ s
Minimum value	SD23	30 μ s
Maximum value	SD24	170 μ s

● Scan time

- 1) Current value : Displays Scan time: Current value (in μ s).
- 2) Minimum value : Displays Scan time: Current value (in μ s).
- 3) Maximum value : Displays Scan time: Current value (in μ s).

■ When selecting the "SD card" tab

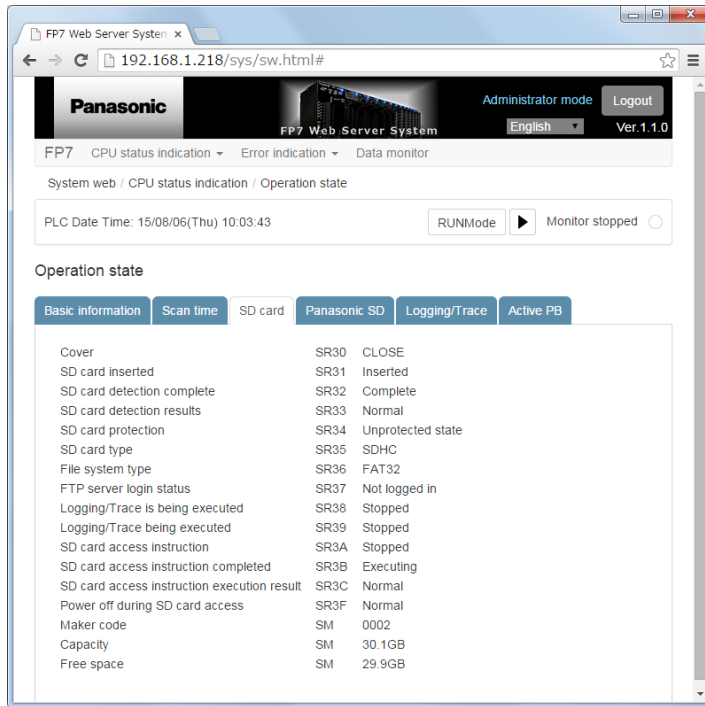

● SD card

When an SD card is "Not inserted", "-" is always displayed after the completion of the recognition of an SD card.

When the recognition of an SD card is "Not complete", "-" is always displayed after the recognition result of an SD card.

- 1) Cover: Displays the cover state (OPEN/CLOSE).
- 2) SD card inserted: Displays the mounting state (inserted/Not inserted).
- 3) SD card detection complete: Displays the recognition state (complete/Not complete)
- 4) SD card detection results: Displays the recognition result (Normal/Error). (Only Error is displayed in red.)
Only when the result is error, the result code is displayed in red hexadecimal.
- 5) SD card protection: Displays the protected/unprotected state (Unprotected state / Protected state).
- 6) SD card type: Displays the card type (SD/SDHC).
- 7) File system type: Displays the file type (FAT16/FAT32).
- 8) FTP server login status: Displays the login state (Not logged in/Logged in).
- 9) Logging/Trace is being executed: Displays the execution state (Executing /Stopped).
- 10) Logging/Trace Displays the startup state (Executing / Stopped).

being :executed

11) SD card access
instruction:

Displays the instruction state (Executing/Stopped).

12) SD card access instruction
completed:

Displays the instruction execution state (Complete/Not complete).

13) SD card access instruction
execution result:

Displays the instruction execution result (Normal / Error).
Only
Error is displayed in red.)
Only when the result is error, the result code is displayed in red hexadecimal.

14) Power off during SD card
access:

Displays the occurrence state (Normal/Occurred).

15) Maker code:

Displays the Maker code number.

16) Capacity:

Displays the capacity of the SD card (X.XGB).

17) Free space:

Only for FAT32 SD card, displays the empty capacity (X.XGB).

■ When selecting the "PanasonicSD" tab

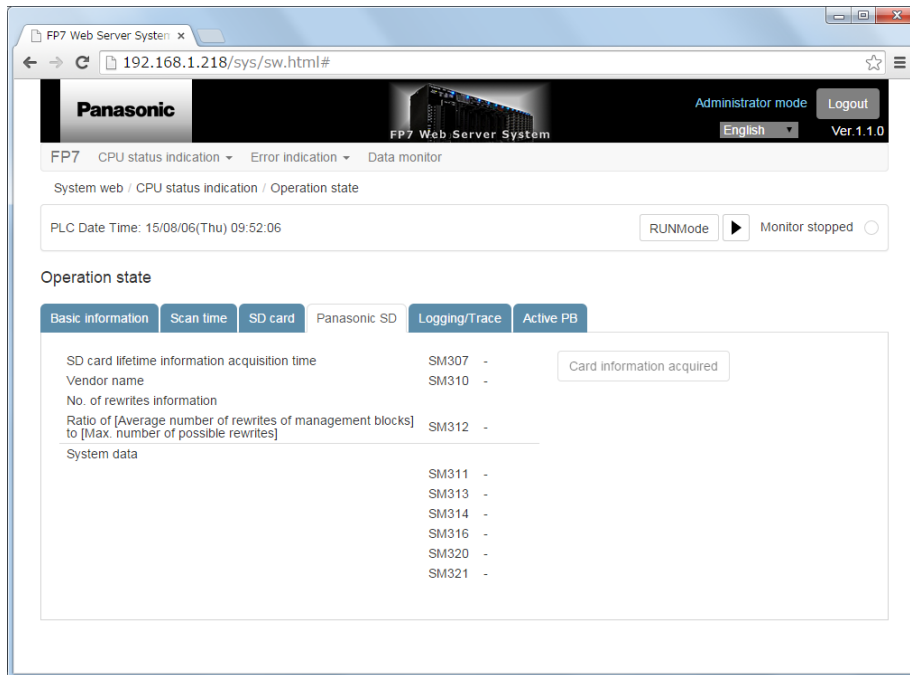

● **PanasonicSD**

The following SD cards made by Panasonic are supported.

SLC type: FX series, EX series

MLC type: JD series, GD series, PC series

When a supported SD card made by Panasonic is not mounted, "-" is displayed.

Card information acquired

This button is operable only when a supported Panasonic SD card is mounted.

Pressing this button redisplay the latest SD card information after its acquisition.

- 1) SD card lifetime information acquisition time: Displays the time that the lifetime information on the SD card is acquired (year, month, day, hour, minute, second).
- 2) Vendor name: It is displayed only for "Panasonic".
- 3) No. of rewrites information: Displays the number of times that the SD card was rewritten (%).
- 4) System data: Displays the system data of the SD card.

■ When selecting the "Logging/Trace" tab

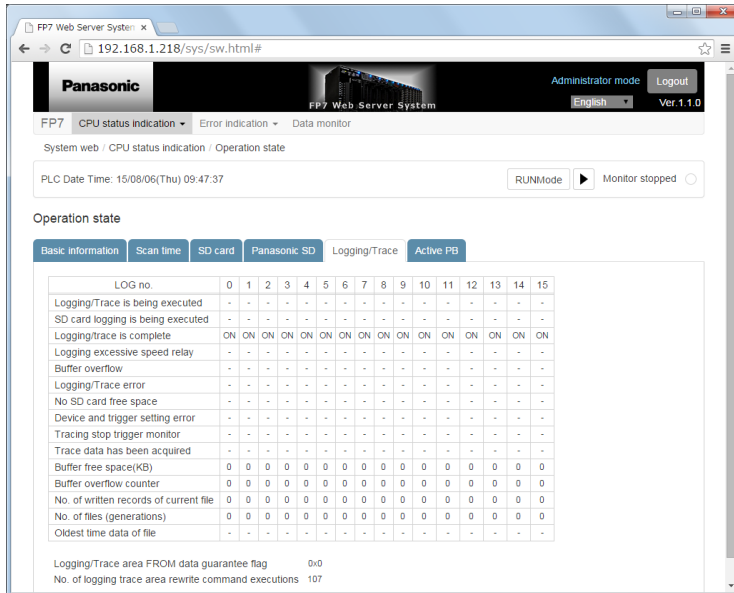

● Logging/Trace

Displays the following items 1) to 17) for each LOG number (0 to 15).

- | | |
|---|--|
| 1) Logging/Trace is being executed: | Displays if Logging/Trace is executed or not (- / ON). |
| 2) SD card logging is being executed: | Displays if logging is being executed is executed or not (- / ON). |
| 3) Logging/Trace is complete: | Displays if Logging/Trace is complete or not (- / ON). |
| 4) Logging excessive speed relay: | Displays if Logging excessive speed relay is executed or not (- / ON). |
| 5) Buffer overflow: | Displays if Buffer overflow is ON or not (- / ON). |
| 6) Logging/Trace error: | Displays if Logging/Trace error occurs or not (- / ON). |
| 7) No SD card free space: | Displays if No SD card free space error occurs or not. |
| 8) Device and trigger setting error: | Displays if Device and trigger setting error occurs or not (- / ON). |
| 9) Tracing stop trigger monitor: | Displays if Tracing stop trigger monitor is enabled or not (- / ON). |
| 10) Trace data has been acquired: | Displays Trace data has been acquired (- / ON). |
| 11) Buffer free space(KB): | Displays the Buffer free space (in KB). |
| 13) Buffer overflow counter: | Displays the number of counters of Buffer overflow. |
| 14) No. of written records of current file: | Displays the No. of written records of current file. |
| 15) No. of files (generations): | Displays the No. of files (generations). |

- 16) Oldest time data of file: Displays the Oldest time data of file (yy/mm/dd hh:mm:ss).
- 17) Logging/Trace area
FROM data guarantee flag: Displays the FROM data guarantee flag.
- 18) No. of logging trace area
rewrite command executions: Displays the number of rewrite command executions.

■ When selecting the "Active PB" tab

FP7 Web Server System Administrator mode Ver.1.1.0

FP7 CPU status indication Error indication Data monitor

System web / CPU status indication / Operation state

PLC Date Time: 15/08/06(Thu) 09:45:27 RUNMode Monitor stopped

Operation state

Basic information Scan time SD card Panasonic SD Logging/Trace Active PB

No. of registered PBs:2	PB	0	1	2	3	4	5	6	7	8	9
	000		●	●	-	-	-	-	-	-	-
<input checked="" type="radio"/> PB001 - PB099	010	-	-	-	-	-	-	-	-	-	-
<input type="radio"/> PB100 - PB199	020	-	-	-	-	-	-	-	-	-	-
<input type="radio"/> PB200 - PB299	030	-	-	-	-	-	-	-	-	-	-
<input type="radio"/> PB300 - PB399	040	-	-	-	-	-	-	-	-	-	-
<input type="radio"/> PB400 - PB499	050	-	-	-	-	-	-	-	-	-	-
	060	-	-	-	-	-	-	-	-	-	-
	070	-	-	-	-	-	-	-	-	-	-
	080	-	-	-	-	-	-	-	-	-	-
	090	-	-	-	-	-	-	-	-	-	-

● : Executing
■ : Stopped
- : Not registered

● Active PB

Common specifications in the Active PB card tab

Displays ● : Executing, ■ : Stopped, 「-」 : Not registered.

PB0 is not used. (Displayed in light gray)

Radio button for switching the registered PB display

The selected PB range is displayed.

PB001-099: Displays the range of PB001 to PB099.

PB100-199: Displays the range of PB100 to PB199.

PB200-299: Displays the range of PB200 to PB299.

PB300-399: Displays the range of PB300 to PB399.

PB400-499: Displays the range of PB400 to PB499.

4.5 CPU status indication > Project header Screen

Displays the project comment header area of the FP7.

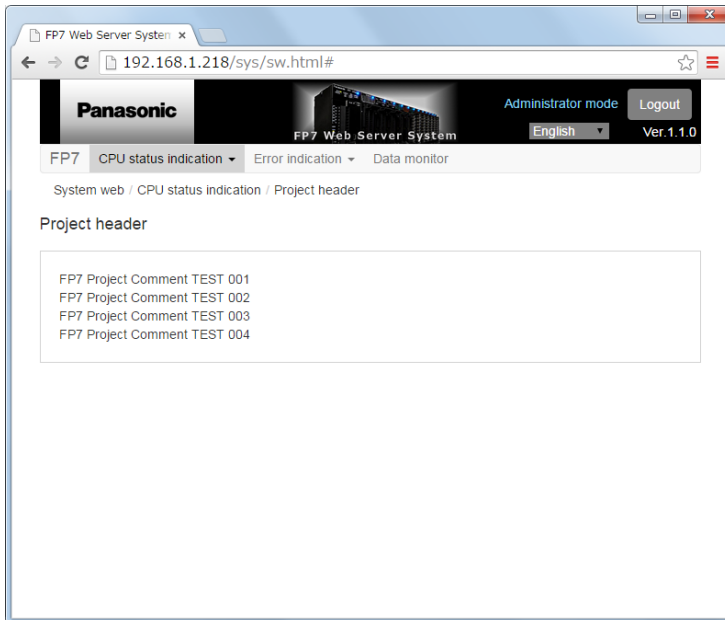

● Project header

Displays the CPU project comment set in the FP7.

4.6 CPU status indication > System monitor area Screen

Displays the system monitor area of the FP7.

Common function to each screen: Monitor executing/stopped button:

In the case of Monitor executing: Updates and displays data at the interval of one second.

In the case of Monitor stopped: Stops the update processing.

■ When selecting the "Use History"

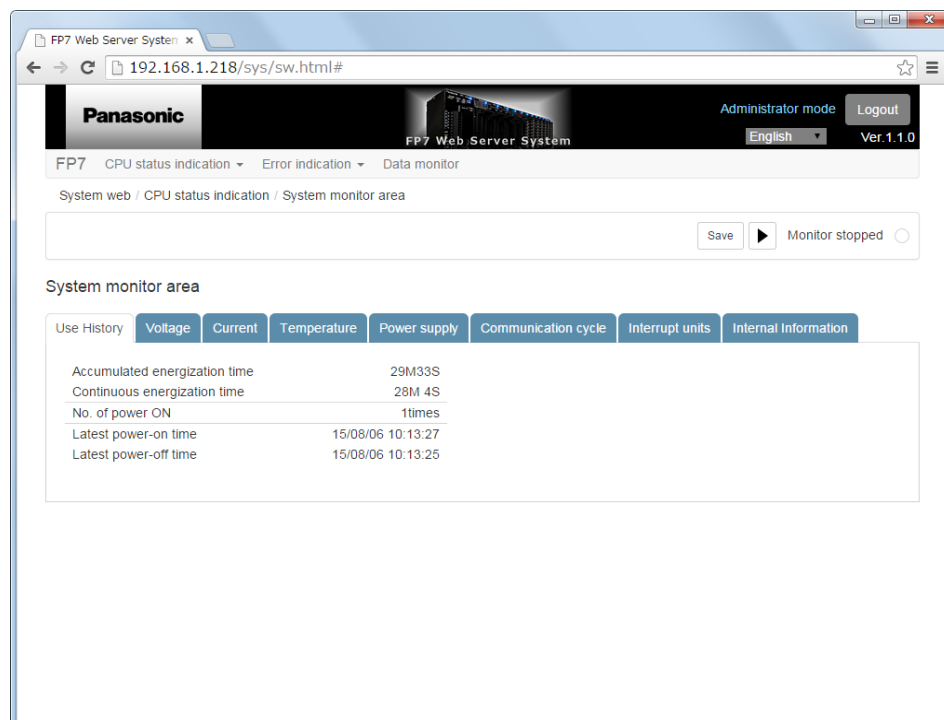

● Use History

- 1) Accumulated energization time: Displays the accumulated time (day, hour, minute, second).
- 2) Continuous energization time: Displays the energization time (day, hour, minute, second).
- 3) No. of power ON: Displays the No. of power ON.
- 4) Latest power-on time: Displays the Latest power-on time (yy/mm/dd hh:mm:ss).
- 5) Latest power-off time: Displays the Latest power-off time (yy/mm/dd hh:mm:ss).

■ When selecting the "Voltage" tab

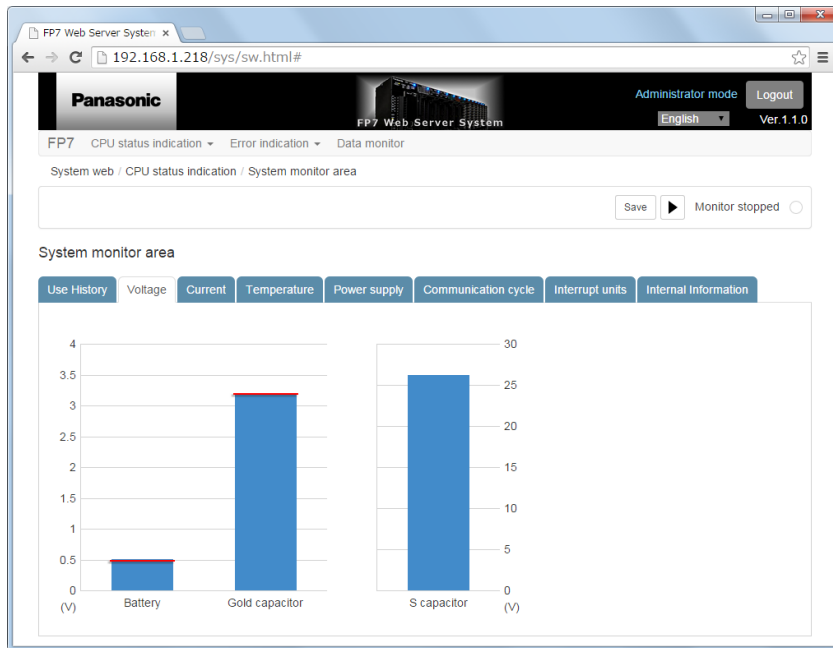

● Voltage

Common specifications in the Voltage tab

Displays voltage level drop hold values as graphs in red. (Unit: V)

Click the vertical area of a target graph for displaying numerical information.

Numerical information is displayed in the center of the screen. For deleting the display, click the area again.

Battery		
Voltage monitor :		3.276 V
Voltage level drop hold value :		0.183 V
Voltage level drop time :		12/06/02 00:28:50

- | | |
|--|--|
| 1) Bt vol current monitor: | Displays the battery voltage. |
| 2) Bt vol level drop hold value: | Displays the level drop hold value. |
| 3) Bt vol level drop time: | Displays the drop time (yy/mm/dd hh:mm:ss). |
| 4) Gold capacitor Voltage monitor: | Displays the gold capacitor voltage. |
| 5) Gold capacitor Voltage level drop hold value: | Displays the level drop hold value. |
| 6) Gold capacitor Voltage monitor: | Displays the drop time (yy/mm/dd hh:mm:ss). |
| 7) S capacitor voltage value: | Displays the S capacitor voltage value. |
| 8) S capacitor voltage error: | Displays the S capacitor voltage abnormal value. |
| 9) S capacitor voltage error detection time: | Displays the error detection time (yy/mm/dd hh:mm:ss). |

■ When selecting the "Current" tab

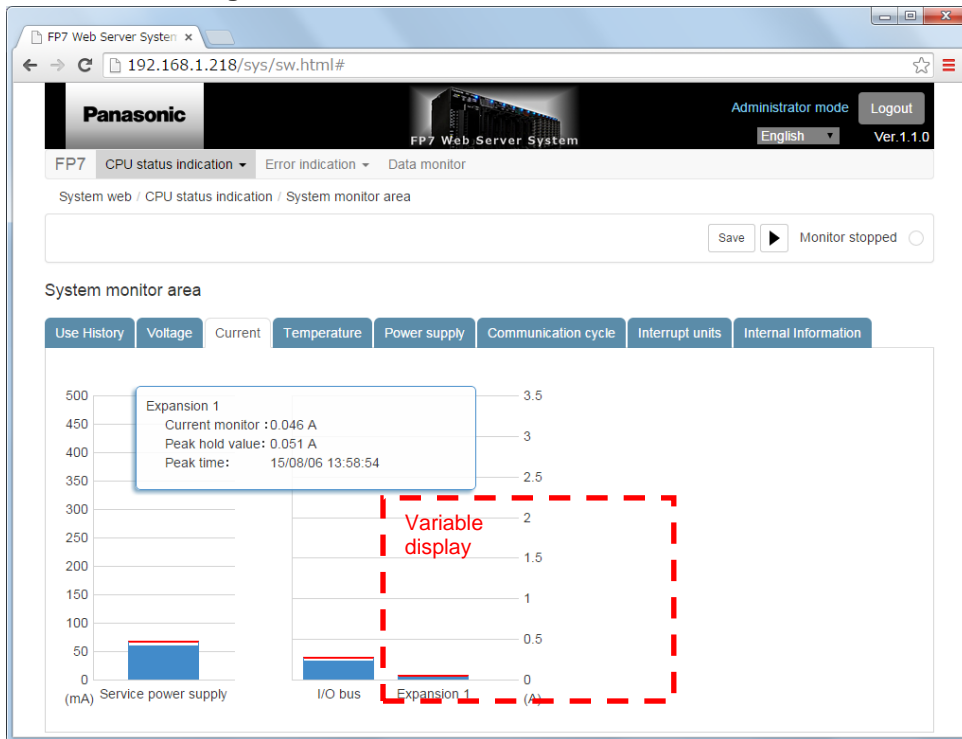

● Current

Common specifications in the Current tab

Displays current peak hold values as graphs in red.
(Unit: mA for service power supply, A for others)

Click the vertical area of a target graph for displaying numerical information.

Numerical information is displayed in the center of the screen. For deleting the display, click the area again.

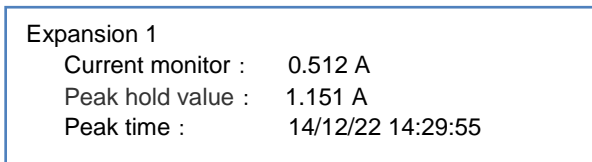

The current graphs for expansion units (1 to 3) are displayed for the number of connected expansion units. When no expansion unit is connected, the graph is not displayed.

- | | |
|--|---|
| 1) Service power supply current monitor: | Displays the service current (Unit: mA). |
| 2) Service power supply peak hold: | Displays the peak hold value. |
| 3) Service power supply peak time: | Displays the peak time (yy/mm/dd hh:mm:ss). |
| 4) I/O bus current monitor: | Displays the I/O bus current (Unit: A). |

- 5) I/O bus peak hold: Displays the peak hold value.
- 6) I/O bus peak occurrence time: Displays the peak time (yy/mm/dd hh:mm:ss).
- 7) Expansion 1 to 3 current monitor: Displays the currents of expansion units 1 to 3 (Unit: A).
- 8) Expansion 1 to 3 current peak hold: Displays the peak hold values of expansion units 1 to 3.
- 9) Expansion 1 to 3 peak time: Displays the peak time of expansion units 1 to 3 (yy/mm/dd hh:mm:ss).

■ When selecting the "Temperature" tab

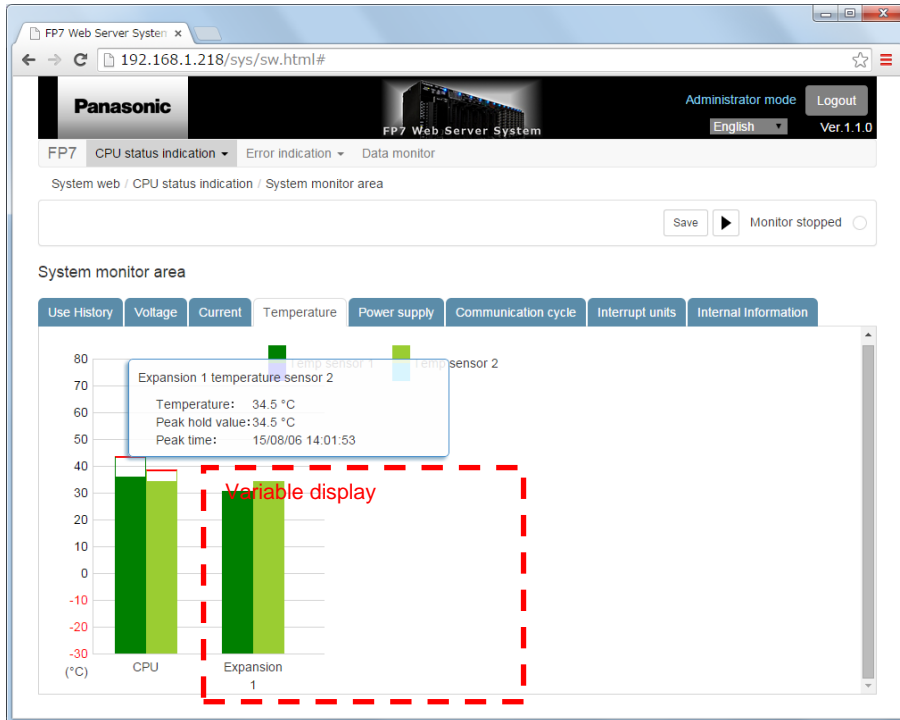

● Temperature

Common specifications in the Temperature tab

Displays temperature peak hold values as graphs in red. (Unit: °C)

Click the vertical area of a target graph for displaying numerical information.

Numerical information is displayed in the center of the screen. For deleting the display, click the area again.

Expansion 1 temperature sensor 1	
Temperature :	26.9 °C
Peak hold value :	41.4 °C
Peak time :	12/06/02 00:28:50

The temperature graphs for expansion units (1 to 3) are displayed for the number of connected expansion units. When no expansion unit is connected, the graph is not displayed.

- | | |
|---|---|
| 1) CPU temperature sensor 1: | Displays the temperature sensor 1 (Unit: °C). |
| 2) CPU temperature sensor 1 peak hold: | Displays the peak hold value. |
| 3) CPU temperature sensor 1 peak occurrence time: | Displays the peak time (yy/mm/dd hh:mm:ss). |
| 4) CPU temperature sensor 2: | Displays the temperature sensor 2 (Unit: °C). |
| 5) CPU temperature sensor 2 peak hold: | Displays the peak hold value. |

- | | |
|---|---|
| 6) CPU temperature sensor 2 peak occurrence time: | Displays the peak time (yy/mm/dd hh:mm:ss). |
| 7) Expansion 1 to 3 temperature sensor 1: | Displays the temperature sensor 1 (Unit: °C). |
| 8) Expansion 1 to 3 temperature sensor 1 peak hold: | Displays the peak hold value. |
| 9) Expansion 1 to 3 temperature sensor 1 peak occurrence time: | Displays the peak time (yy/mm/dd hh:mm:ss). |
| 10) Expansion 1 to 3 temperature sensor 2: | Displays the temperature sensor 2 (Unit: °C). |
| 11) Expansion 1 to 3 temperature sensor 2 peak hold: | Displays the peak hold value. |
| 12) Expansion 1 to 3 temperature sensor 2 peak occurrence time: | Displays the peak time (yy/mm/dd hh:mm:ss). |

■ When selecting the "Power supply" tab

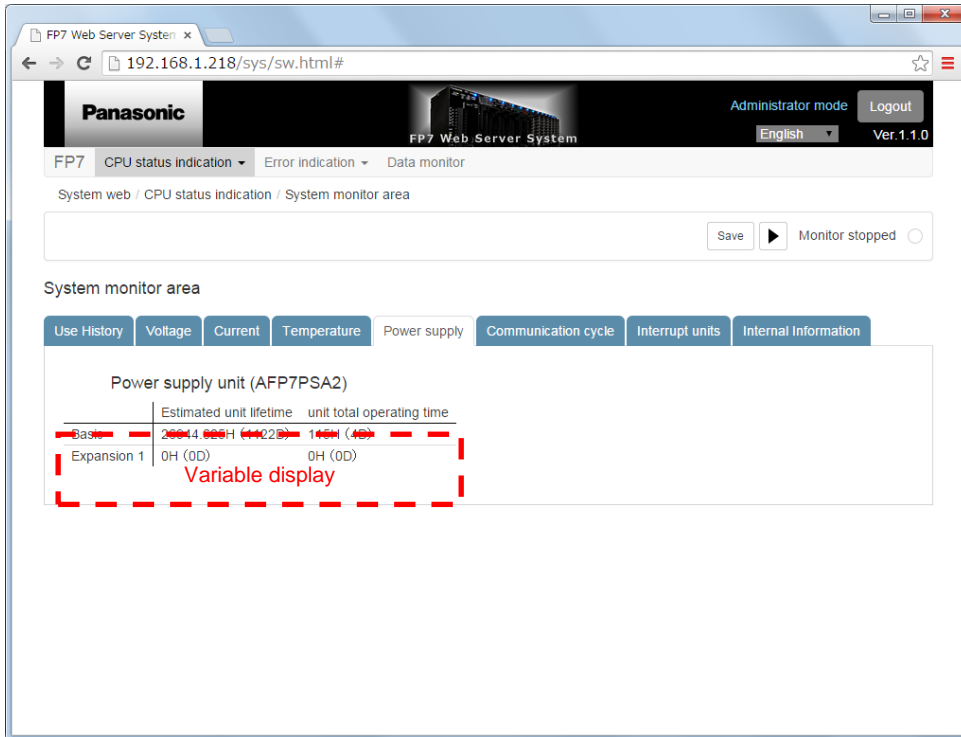

● Power supply

Common specifications in the Power supply tab

The estimated lifetime and total operation time of the power supply unit (AFP7PSA2) attached to expansion units (1 to 3) is displayed for each connected expansion units.

(For inapplicable power supply units, or when the power supply unit is not attached, 0 hour is displayed.)

When no expansion unit is not attached, these items are not displayed.

- | | |
|---|---|
| 1) CPU power supply unit lifetime data: | Displays the lifetime data (hour/day). |
| 2) CPU power supply unit total operating time: | Displays the operation time (hour/day). |
| 3) Expansion 1 to 3 power supply unit lifetime data: | Displays the lifetime data (hour/day). |
| 4) Expansion 1 to 3 power supply unit total operating time: | Displays the operation time (hour/day). |

■ When selecting the "Communication cycle" tab

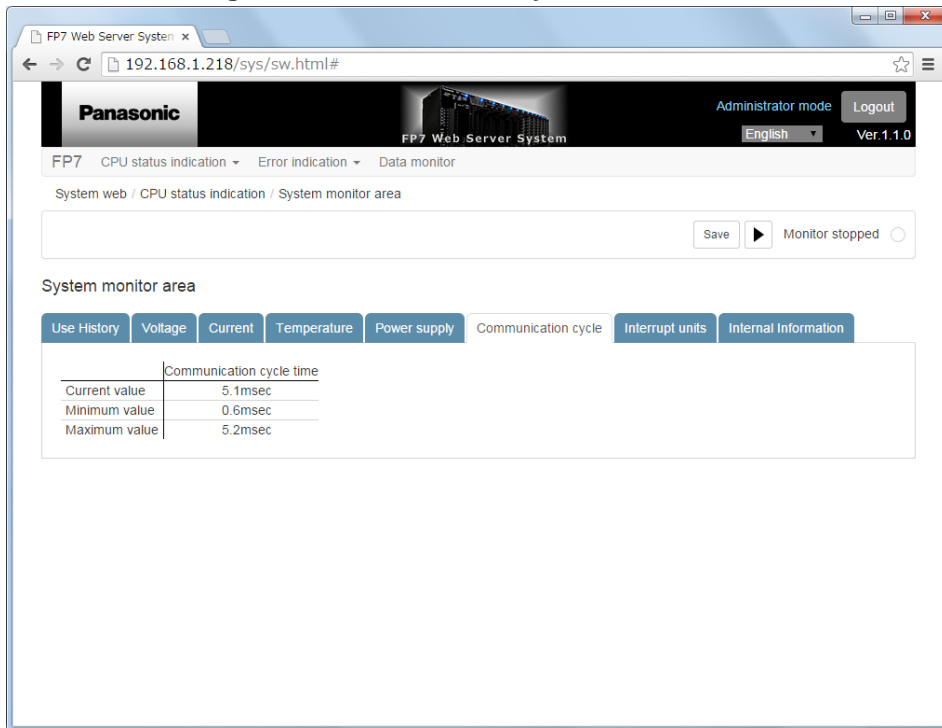

● Communication cycle

- 1) Communication cycle time current value: Displays the current value of communication cycle time (in 0.1 msec unit).
- 2) Communication cycle time minimum value: Displays the minimum value of communication cycle time (in 0.1 msec unit).
- 3) Communication cycle time maximum value: Displays the maximum value of communication cycle time (in 0.1 msec unit).

■ When selecting the "Interrupt units" tab

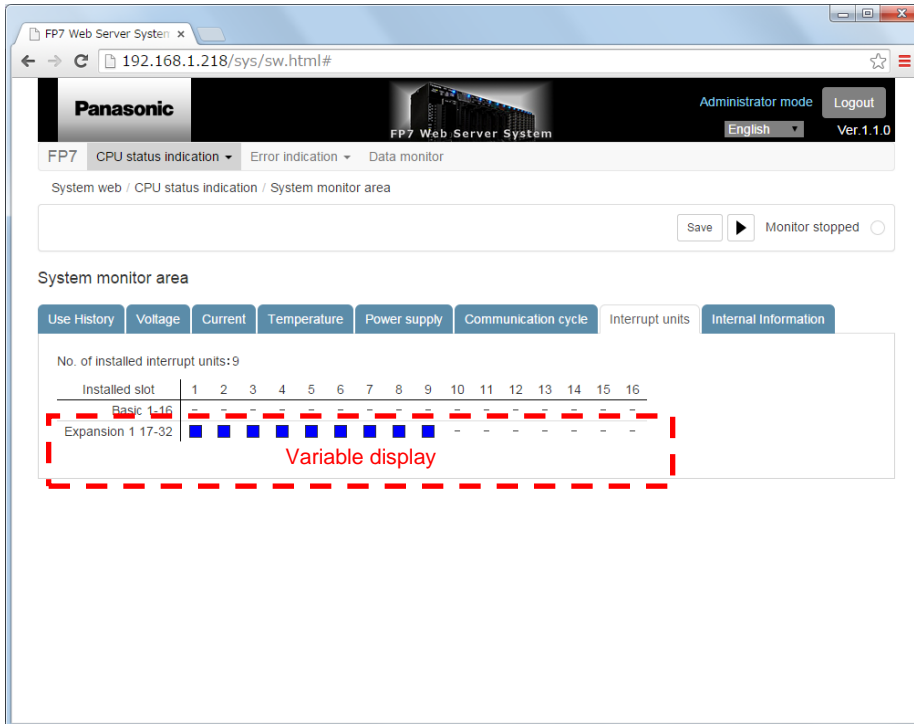

● Interrupt units

Common specifications in the Interrupt units tab

The connection information on interrupt units attached to expansion units (1 to 3) is displayed for each connected expansion units.

When no expansion unit is not attached, these items are not displayed.

Interrupt units are displayed as "■", and other units are displayed as "-".

- | | |
|-----------------------|--|
| 1) Basic 1-16: | Displays the interrupt units of the CPU unit. |
| 2) Expansion 1 17-32: | This is displayed only when the expansion unit 1 is installed. |
| 3) Expansion 2 33-48: | This is displayed only when the expansion unit 2 is installed. |
| 4) Expansion 3 49-64: | This is displayed only when the expansion unit 3 is installed. |

■ When selecting the "Internal Information" tab

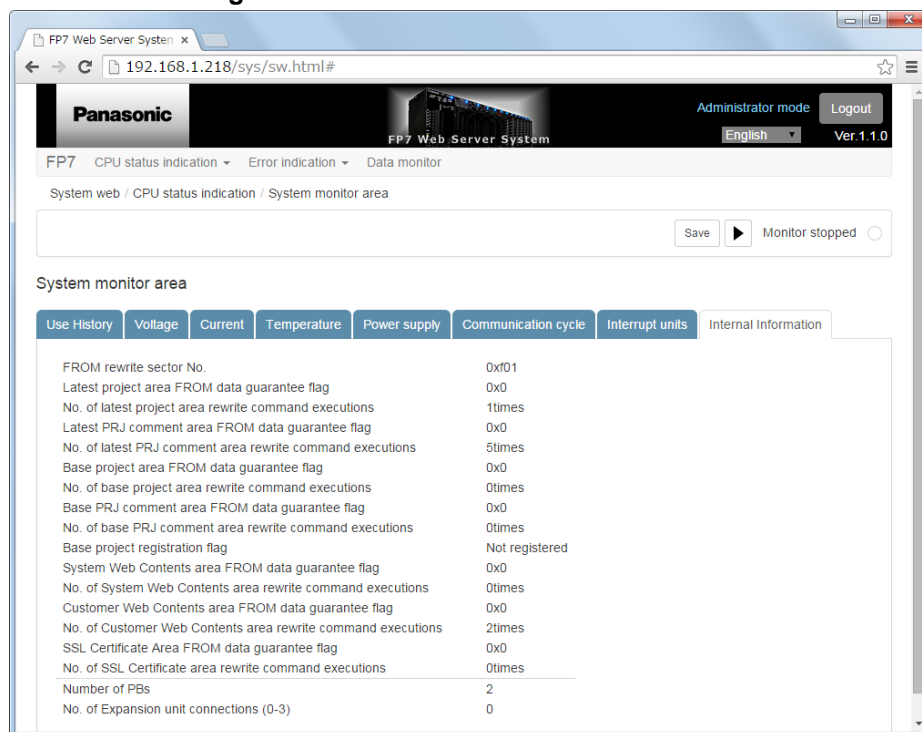

● Internal Information

It shows the following internal information.

- 1) FROM rewrite sector No.
- 2) Latest project area FROM data guarantee flag
- 3) No. of latest project area rewrite command executions
- 4) Latest PRJ comment area FROM data guarantee flag
- 5) No. of latest PRJ comment area rewrite command executions
- 6) Base project area FROM data guarantee flag
- 7) No. of base project area rewrite command executions
- 8) Base PRJ comment area FROM data guarantee flag
- 9) No. of base PRJ comment area rewrite command executions
- 10) Base project registration flag
- 11) System Web Contents area FROM data guarantee flag
- 12) No. of System Web Contents area rewrite command executions
- 13) Customer Web Contents area FROM data guarantee flag
- 14) No. of Customer Web Contents area rewrite command executions
- 15) SSL Certificate Area FROM data guarantee flag
- 16) No. of SSL Certificate area rewrite command executions
- 17) Number of PBs
- 18) No. of Expansion unit connections (0-3)

4.7 CPU status indication / System history Screen

Displays the system history of the FP7.

Common function to each screen: Monitor executing/stopped button:

In the case of Monitor executing: Performs update processing only once.

It returns to the monitoring-stopped state after updating data.

In the case of Monitor stopped: Stops update processing.

"Clear" button

Clears the system history information, and redispays the list.

"Save" button

Saves the displayed system history information. (CSV format)

■ When selecting the "Event" tab

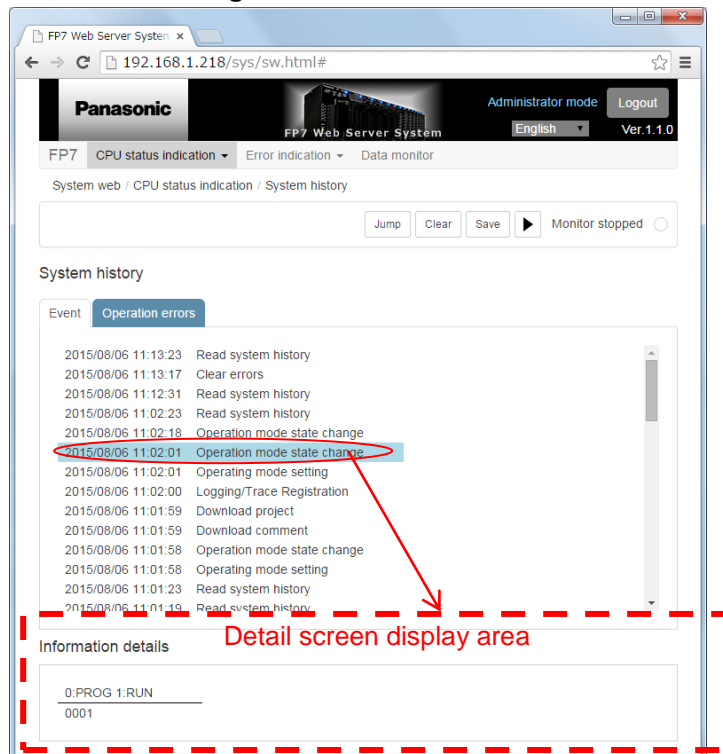

● System history (Event)

It shows the following event history.

- 1) Date and time that an even occurs
- 2) Event name

Clicking the list display shows the detailed information on the event.

"Jump" button

Jumps to the recent event occurred after a specified date and time in the system history.

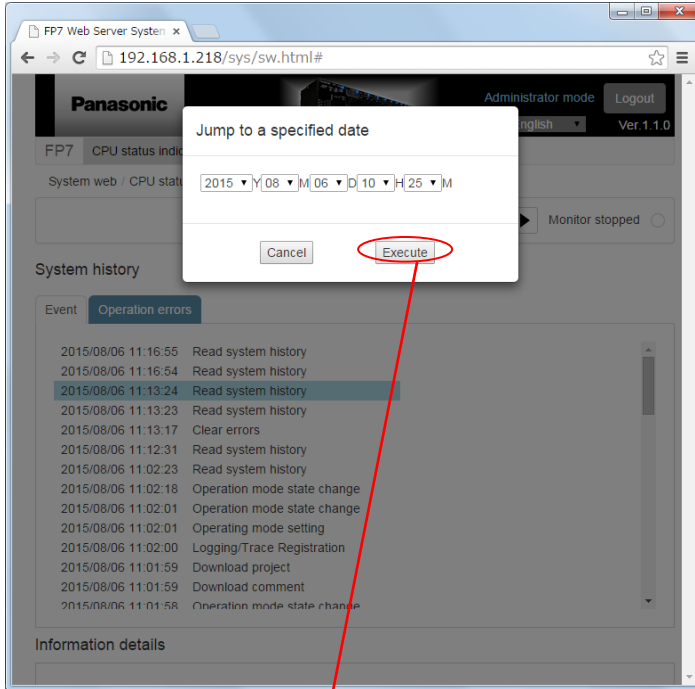

After clicking "Execute"

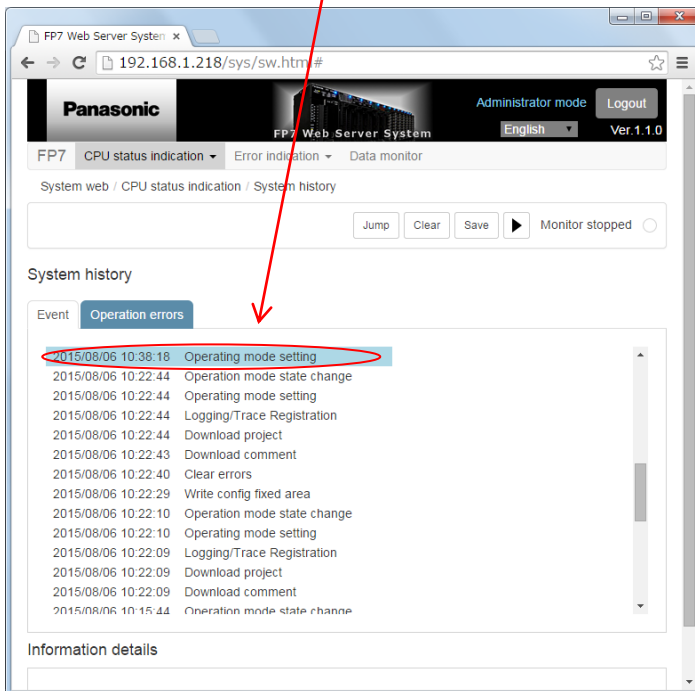

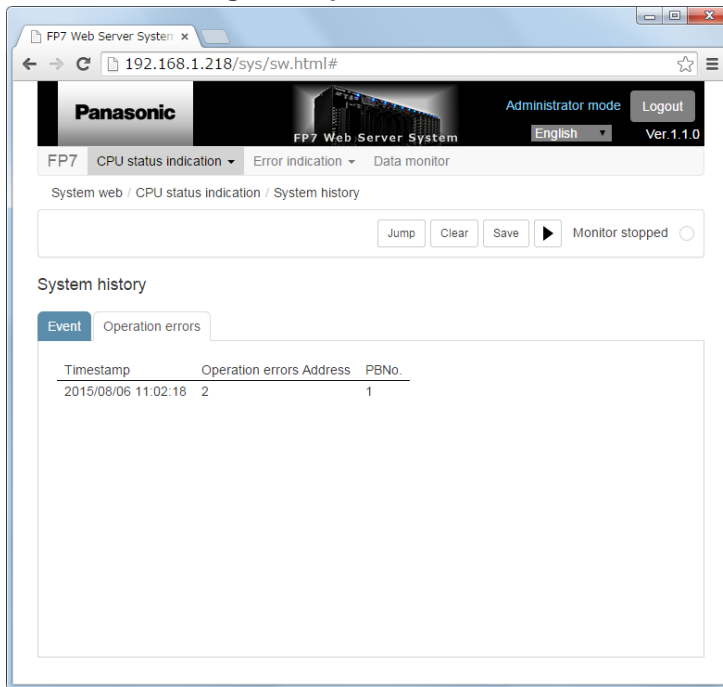
■ When selecting the "Operation errors" tab**● System history (Operation errors)**

It shows the following event history.

- 1) Timestamp Date and time that an even occurs
- 2) Operation errors Address
- 3) PB No.

4.8 CPU status indication / EtherNet/IP monitor

Displays the EtherNet/IP monitor of the FP7.

Common function to each screen

"Save" button

Saves the displayed EtherNet/IP monitor information. (CSV format)

■ When selecting "Node information" tab

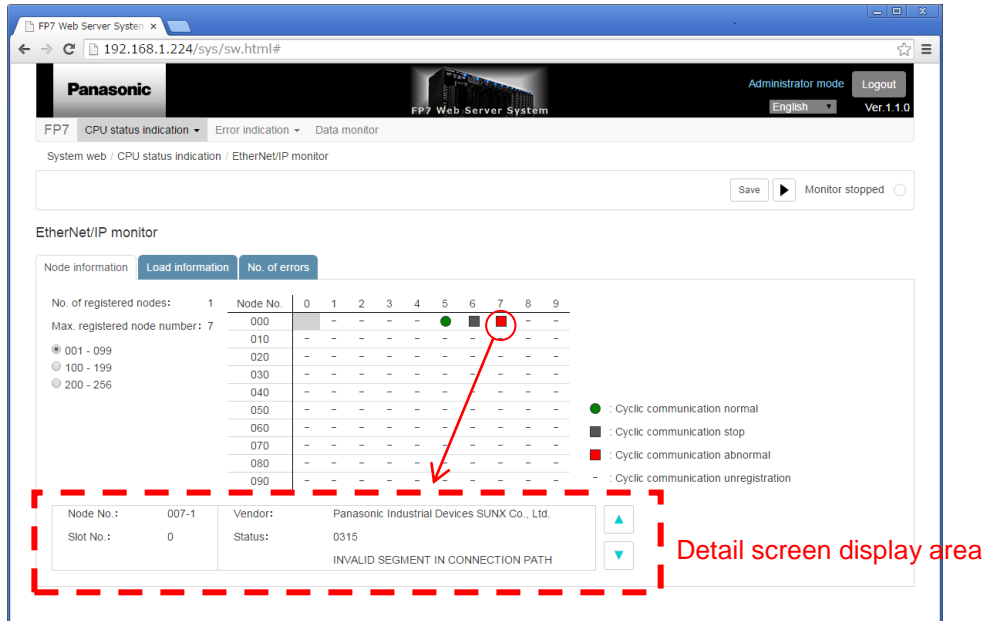

● Node information (EtherNet/IP operation status monitor)

It shows the following information.

- 1) No. of registered nodes: (0 to 256)
- 2) Max. registered node number: (0 to 256)
- 3) Operation state: (Cyclic communication: ●normal / ■stop / ■abnormal / —unregistration)

Clicking the list display shows detail information (the following items) in the lower part of the screen.

Node No. , Slot No. , Vendor , Status: Code, contents

When more than one error occurs within one node, the display is switched with "▲" and "▼" buttons.

The list display is switched by selecting a node range (No. 001-099, 100-199, or 200-256).

● Monitor executing/stopped button

Update processing is performed only once. It returns to the monitoring-stopped state after updating data.

■ When selecting the "Load information" tab



● Load information (EtherNet/IP operation status monitor)

It shows the following information.

Cyclic communication No. of received packets (per second)

Cyclic communication No. of transmitted packets (per second)

Communication other than the cyclic (per second)

No. of received packets

No. of transmitted packets

No. of receive buffer overflows

No. of received error packets

No. of failed transmitted packets

It shows the following information graphically.

- No. of received packets (per second): ● Cyclic / ● Others

- No. of transmitted packets (per second): ● Cyclic / ● Others

Horizontal axis: Scaled at the interval of one second. Shifted to the left after displaying the whole graph.

Vertical axis: Automatically adjusted according to the number of packets.

* The graph is reset by switching the tab or starting monitoring.

● **Monitor executing/stopped button**

In the case of Monitor executing: Updates and displays data at the interval of one second.

In the case of Monitor stopped: Stops update processing.

■ **When selecting the "No. of errors" tab**

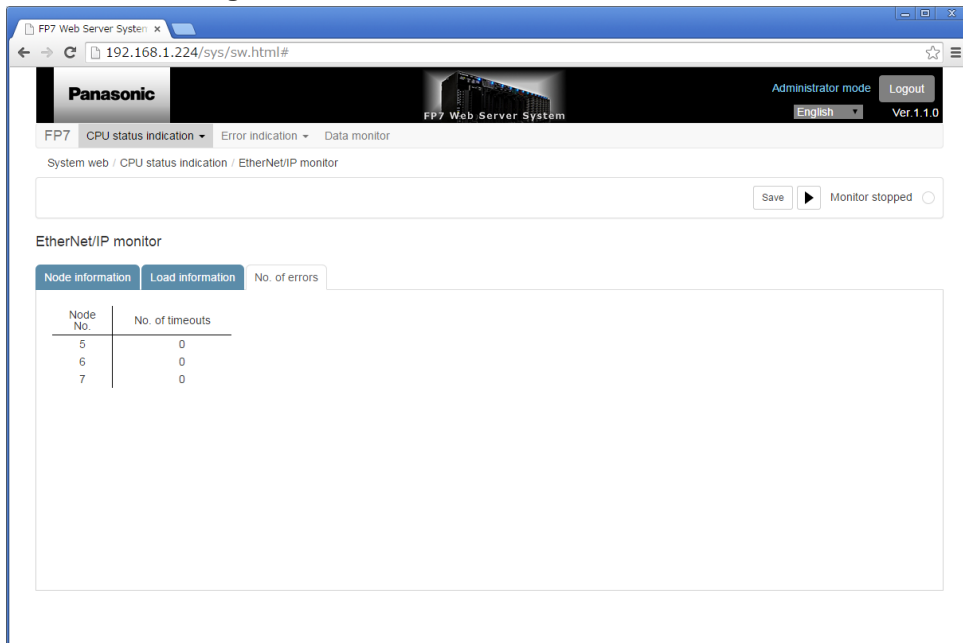

● **No. of errors (EtherNet/IP operation status monitor)**

It shows the following information.

- 1) Node No..
- 2) No. of timeouts

* The number of communication errors is displayed for each node. The display varies according to the number of registered nodes.

● **Monitor executing/stopped button**

Update processing is performed only once. It returns to the monitoring-stopped state after updating data.

4.9 Error indication > Unit error Screen

Displays unit errors of the FP7.

Common functions in the error indication tab

Monitor executing/stopped button:

In the case of Monitor executing: Updates and displays data at the interval of one second.

In the case of Monitor stopped: Stops update processing.

■ Unit error screen

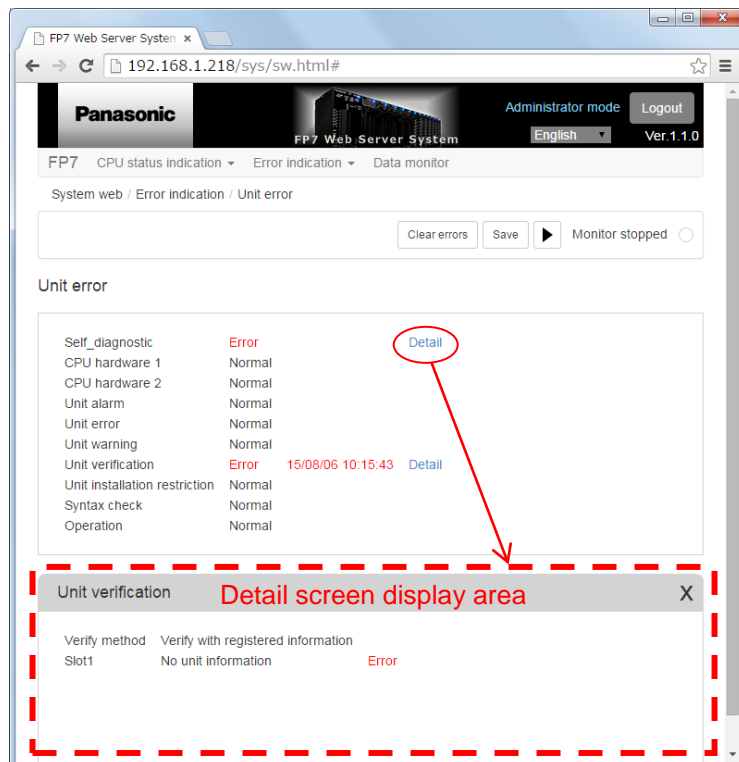

Common specifications of Unit error

For "Error" or "Occurred";

Warnings are displayed in blue, and others are displayed in red.

Displays the first occurrence time (yy/mm/dd hh:mm:ss).

* Excluding "Self-diagnostic, and Unit installation restriction"

Click the "[Detail](#)" link to display the detail of the error.

"Clear errors" button

Clears unit errors, and redispalyes the list.

"Save" button

Saves the displayed unit error data. (CSV format)

- 1) Self_diagnostic: Displays the Self_diagnostic state (Normal/Error).
- 2) CPU hardware 1: Displays the CPU hardware 1 state (Normal/ Error).
- 3) CPU hardware 2: Displays the CPU hardware 2state (Normal/ Error).
- 4) Unit alarm: Displays the Unit alarm state (Normal/ Error).
- 5) Unit error: Displays the Unit error state (Normal/ Error).
- 6) Unit warning: Displays the Unit warning state (Normal/ Error).
- 7) Unit verification: Displays the Unit verification state (Normal/ Error).
- 8) Unit installation restriction: Displays the Unit installation restriction state (Normal/ Error).
- 9) Syntax check: Displays the Syntax check state (Normal/ Error).
- 10) Operation: Displays the Operation state (Normal/ Error).

4.10 Error indication > Error alarm relay Screen

Displays the list of error alarm relays of the FP7.

● Error alarm relay screen

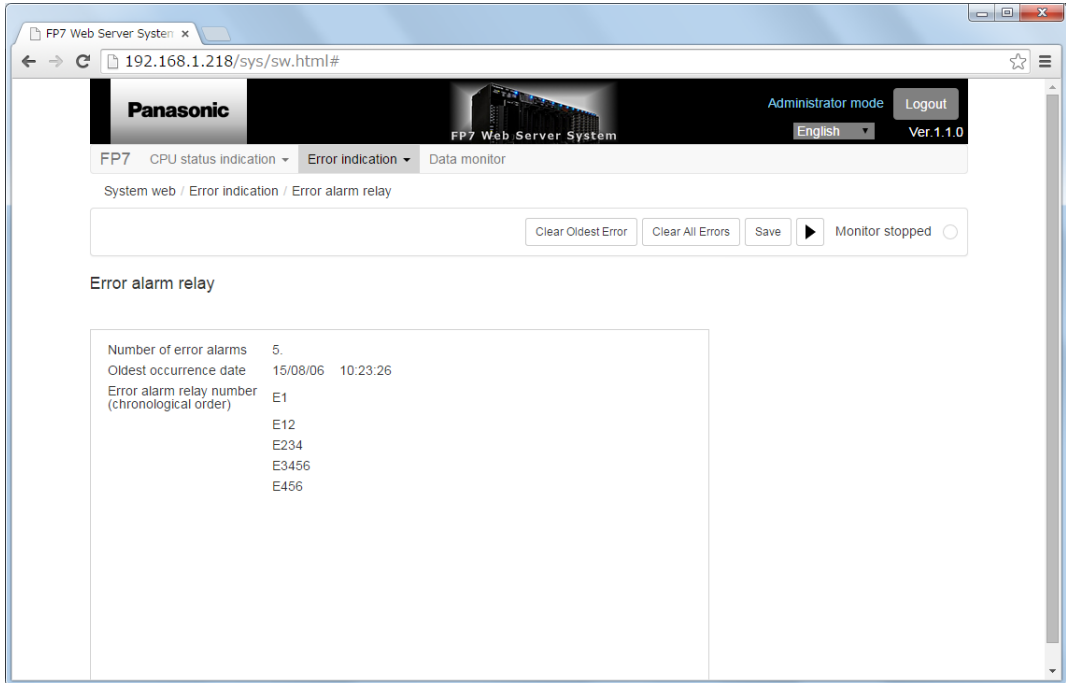

Dedicated functions of Error alarm relay

"Clear All Errors" button

Clears all error alarm relays, and redisplay the list.

"Clear Oldest Error" button

Clears the oldest error alarm relay, and redisplay the list.

"Save" button

Saves the displayed error alarm relay data in CSV format.

- 1) Number of error alarms: Displays the number of error alarms (max. 19 alarms).
- 2) Oldest occurrence date: Time of the first error alarm relay turned ON.
Displays (yy/mm/dd hh:mm:ss).
- 3) Error alarm relay number (Occurrence order): Displays the error alarm relay number turned ON.
(First, second, third, ..., eighteenth, nineteenth)

4.11 Data monitor Screen

Displays the list of monitored device information of the FP7.

■ Data monitor screen

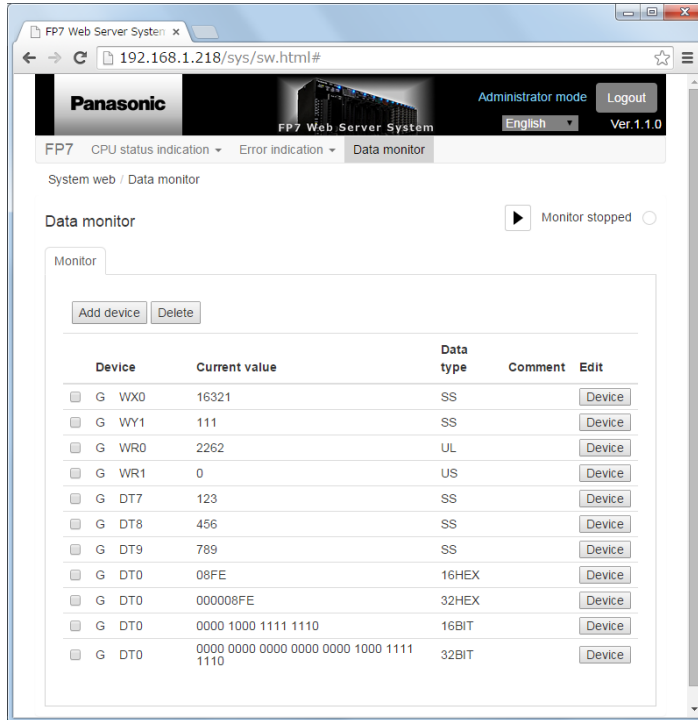

● Dedicated functions of Data monitor

"Monitor executing/stopped" button

In the case of Monitor executing: Updates and displays data in a best-effort way.

In the case of Monitor stopped: Stops update processing.

"Add device" button

Pops up the window for adding a device.

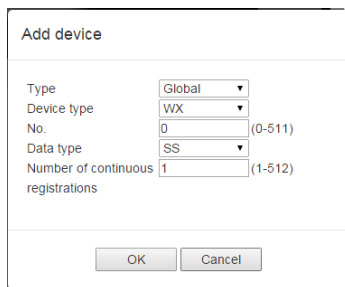

"Delete" button

Deletes the line of the device checked in the check box from the list.

"Device" button

Pops up the window for editing a device.

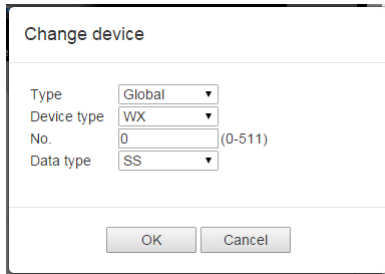

Change device

Type Global ▼
Device type WX ▼
No. 0 (0-511)
Data type SS ▼

OK Cancel

Selectable device types are as follows.

Device type: WX, WY, WR, WL, WS, TS, TE, CS, CE, SD, DT, LD

Selectable data types are as follows.

Data type: SS, US, SL, UL, 16HEX, 32HEX

- 1) Device: Displays the selected device.
G: Global device
SLT12: Unit device (slot 12) *
PB1: Local device (PT1) *
*** Only global device (data) can be selected.**
- 2) Current value: Current value of the selected device.
Displays the update while monitoring is being executed.
- 3) Data type: Displays the specified data type.
- 4) Comment: Displays the device comment.
*** There is no comment display function.**
- 5) Edit: Displays the button for editing devices for each monitor data.

Record of changes

Manual No.	Date	Record of Changes
-	Sep. 2015	Edition corresponding to Web Creator Ver. 2.0.0
-	Dec. 2015	Edition corresponding to Web Creator Ver. 2.1.0
-	Jun. 2016	Edition corresponding to Web Creator Ver. 3.1.0
WUME-FP7WEB-01	Aug. 2018	Edition corresponding to Web Creator Ver. 3.2.0 - Added the description of a new product (ELC500)
WUME-FP7WEB-02	Feb. 2019	Edition corresponding to Web Creator Ver. 3.3.0 - Added the description of parts "3.5.7.2.9 Integration Graph Parts" "3.5.7.2.10 SD Card Logging Graph" "3.5.7.2.12 General-purpose Camera Parts"
WUME-FP7WEB-03	Sep. 2019	Edition corresponding to Web Creator Ver. 3.4.0 - Added the description of parts "3.5.7.2.11 Operation History"
WUME-FP7WEB-04	May 2020	Edition corresponding to Web Creator Ver. 3.4.2 - Changed parts. Operation button under "3.5.7.2.11.1 Alarm Function" Operation button under "3.5.7.2.11.2 Gantt Chart Function" - Added error codes. "3.5.7.2.11.1 Alarm Function" "3.5.7.2.11.2 Gantt Chart Function"

Please contact

Panasonic Corporation

Panasonic Industrial Devices SUNX Co., Ltd.
<https://panasonic.net/id/pidsx/global>

Please visit our website for inquiries and about our sales network.

© Panasonic Industrial Devices SUNX Co., Ltd. 2020
May, 2020 PRINTED IN JAPAN WUME-FP7WEB-04