

Programmable controller

FP7 CPU Unit

User's Manual

Hardware

(MEMO)

Introduction

Thank you for buying a Panasonic product. Before you use the product, please carefully read the installation instructions and the users manual, and understand their contents in detail to use the product properly.

Types of Manual

- There are different types of user's manual for the FP7 series, as listed below. Please refer to a relevant manual for the unit and purpose of your use.
- The manuals can be downloaded from the Panasonic website:<https://industry.panasonic.com/global/en/downloads/?tab=manual>.

Unit name or purpose of use	Manual name	Manual code
FP7 Power Supply Unit	FP7 CPU Unit User's Manual (Hardware)	WUME-FP7CPUH
FP7 CPU Unit	FP7 CPU Unit Command Reference Manual	WUME-FP7CUPGR
	FP7 CPU Unit User's Manual (Logging Trace Function)	WUME-FP7CPULOG
	FP7 CPU Unit User's Manual (Security Function)	WUME-FP7CPUSEC
	Instructions for Built-in LAN Port	FP7 CPU Unit User's Manual (LAN Port Communication)
FP7 CPU Unit User's Manual (Ethernet Expansion Function)		WUME-FP7CPUETEX
FP7 CPU Unit User's Manual (EtherNet/IP Communication)		WUME-FP7CPUeIP
Web Server Function Manual		WUME-FP7WEB
Instructions for Built-in COM Port	FP7 Series User's Manual (SCU Communication)	WUME-FP7COM
FP7 Extension Cassette (Communication) (RS-232C / RS485 type)		
FP7 Extension Cassette (Communication) (Ethernet Type)	FP7 Series User's Manual (Communication Cassette Ethernet Type)	WUME-FP7CCET
FP7 Extension (Function) Cassette Analog Cassette	FP7 Analog Cassette User's Manual	WUME-FP7FCA
FP7 Digital Input / Output Unit	FP7 Digital Input / Output Unit User's Manual	WUME-FP7DIO
FP7 Analog Input Unit	FP7 Analog Input Unit User's Manual	WUME-FP7AIH
FP7 Analog Output Unit	FP7 Analog Output Unit User's Manual	WUME-FP7AOH
FP7 Thermocouple Multi-analog Input Unit	FP7 Thermocouple Multi-analog Input Unit FP7 RTD Input Unit	WUME-FP7TCRTD
FP7 RTD Input Unit	User's Manual	
FP7 Multi Input / Output Unit	FP7 Multi Input / Output Unit User's Manual	WUME-FP7MXY
FP7 High-speed counter unit	FP7 High-speed Counter Unit User's Manual	WUME-FP7HSC

Unit name or purpose of use	Manual name	Manual code
FP7 Pulse Output Unit	FP7 Pulse Output Unit User's Manual	WUME-FP7PG
FP7 Positioning Unit	FP7 Positioning Unit User's Manual	WUME-FP7POSP
FP7 Serial Communication Unit	FP7 Series User's Manual (SCU Communication)	WUME-FP7COM
FP7 Multi-wire Link Unit	FP7 Multi-wire Link Unit User's Manual	WUME-FP7MW
FP7 Motion Control Unit	FP7 Motion Control Unit User's Manual	WUME-FP7MCEC
PHLS System	PHLS System User's Manual	WUME-PHLS
Programming Software FPWIN GR7	FPWIN GR7 Introduction Guidance	WUME-FPWINGR7

Safety Precautions

- In order to prevent injuries and accidents, always adhere to the following.
- Always read this manual thoroughly before performing installation, operation, maintenance, and inspection, and use the device correctly.
- Ensure you are familiar with all device knowledge, safety information, and other precautions before use.
- In this manual, safety precaution levels are classified into "warnings" and "cautions".

WARNING

Cases where dangerous situations are expected to arise whereby the user could die or suffer serious injury if handled incorrectly

- Implement safety measures externally from this product so that the entire system can operate safely even if a failure occurs due to a fault in this product or some external factor.
- Do not use in an environment containing flammable gases.
Doing so could cause explosions.
- Do not dispose of this product by placing it in fire.
This could cause rupture of batteries, electronic components, etc.
- Do not apply force, electrical charge, fire or heat to the lithium batteries.
It may lead to ignition and/or rupture.

CAUTION

Cases where dangerous situations are expected to arise whereby the user could suffer injury or physical damage could occur if handled incorrectly

- In order to prevent the product from generating abnormal heat or emitting smoke, use the product with some margin to the guaranteed characteristics and performance values.
- Do not disassemble or modify the product.
Doing so could cause abnormal heat generation or smoke.
- Do not touch electrical terminals while the power is on.
There is a risk of electrical shock.
- Construct external emergency stop and interlock circuits.
- Securely connect wires and connectors.
Poor connections can cause abnormal heat generation or smoke.
- Do not perform work (connection, disconnection, etc.) while the power is on.
There is a risk of electrical shock.
- If methods other than those specified by our company are used when operating this product, the protection functions of the unit may be lost.
- This product was developed and manufactured for use in industrial environments.

Copyright and Trademarks





- **Panasonic Industry Co., Ltd.** owns the copyright of this manual.
- Unauthorized copying of this document is strictly prohibited.
- Windows is a registered trademark of the USA Microsoft Corporation in the USA and in other nations.
- Ethernet is a registered trademark of Fuji Xerox Co., Ltd. and the Xerox Corporation in the USA.
- This product includes the following open-source software. Please refer to "Open Source Software Licenses" for information regarding open-source software (OSS).
- Other company and product names are trademarks or registered trademarks of their respective companies.

Handling Precautions

- **In this manual, the following symbols are used to indicate safety information that must be observed.**



Indicates an action that is prohibited or a matter that requires caution.

	Indicates an action that must be taken.
 Info.	Indicates supplemental information.
 Note	Indicates details about the subject in question or information useful to remember.
 Procedure	Indicates operation procedures.

FP7 Connector Compatibility

The connectors of old and new model FP7CPU units and add-on cassettes (hereinafter "cassettes") are shaped differently. Please use old model cassettes with old model units and new model cassettes with new model units as shown in the table below.

■ Old Model

Type	Old Product No.
CPU unit	AFP7CPS41ES, AFP7CPS41E, AFP7CPS31ES, AFP7CPS31E, AFP7CPS31S, AFP7CPS31, AFP7CPS21
Serial Communication Unit	AFP7NSC
Cassette	AFP7CCS1, AFP7CCS2, AFP7CCM1, AFP7CCM2, AFP7CCS1M1, AFP7CCET1, AFP7FCA21, AFP7FCAD2, AFP7FCTC2

■ New Model

Type	New Product No.
CPU unit	AFP7CPS4RES, AFP7CPS4RE, AFP7CPS3RES, AFP7CPS3RE, AFP7CPS3RS, AFP7CPS3R, AFP7CPS2R
Serial Communication Unit	AFP7NSCR
Cassette	AFP7CCRS1, AFP7CCRS2, AFP7CCRM1, AFP7CCRM2, AFP7CCRS1M1, AFP7CCRET1, AFP7FCRA21, AFP7FCRAD2, AFP7FCRTC2

Note

- Each FP7 unit can be connected to the CPU unit of a new or old model.
- Firmware version upgrades for the CPU unit are available for both new and old models.
- When attaching expansion cassettes to the FP7CPU unit, please use only old models, or only new models. Trying to attach a combination of old models and new models may cause damage.

Selection of CPU Units

Note the following points when selecting a CPU unit.

■ Specification changes of CPU unit

- The firmware version of CPU units has been changed in accordance with the extension of the specifications. Specify units with new model numbers.

Program capacity	Ethernet function	Existing model number (Ver. 1)		New model number (Ver. 2/Ver. 3)	
		With Encryption function		No Encryption function	With Encryption function
196K steps	Available	AFP7CPS4E	→	AFP7CPS4RE	AFP7CPS4RES
120K steps	Available	AFP7CPS3E	→	AFP7CPS3RE	AFP7CPS3RES
	Not available	AFP7CPS3	→	AFP7CPS3R	AFP7CPS3RS

- The CPU units Ver.2 and Ver.3 are upward compatible with the conventional Ver.1.
- For using CPU units Ver.2, Ver.2.0 or later version of FPWIN GR7 is required.
- For using CPU units Ver.3, Ver.2.4 or later version of FPWIN GR7 is required.
- For using the projects (programs, comments and configuration data) created for the conventional CPUs Ver.1, the projects must be converted to the projects for CPU units Ver.2 or Ver.3 using the "Convert PLC Type" function of the tool software.
- For information on the CPU versions and FPWIN GR7 version that can be used with each unit and extension cassettes, refer to "1.2.6 Unit to be Used and Applicable Versions".
- The layout of the operation monitor LEDs on Ver.1 of the CPU unit is different from that on Ver.2 or later.

■ Regulations on Encryption function in China

- Some CPU units have the encryption function which encrypts a part or all parts of programs in projects.
- In China, the types equipped with the encryption function cannot be used as they are subject to "Regulation of Commercial Encryption Codes". For using machines or systems incorporating FP7 series in China, or exporting and importing them, select the types without the encryption function.

Open Source Software License

This product includes the following Open source software.

- Copyright (c) April 29, 1997 Kalle Kaukonen.
- Copyright (C) 1995-1998 Eric Young (eay@cryptsoft.com)
- Copyright (C) 1995, 1996, 1997, and 1998 WIDE Project
- Copyright (C) 1995-1997 Eric Young (eay@mincom.oz.au)
- Copyright (C) 1997 Hideo "Sir MANMOS" Morishita
- Copyright (C) 1995-1996 Eric Young (eay@mincom.oz.au)
- Copyright (C) 1991-2, RSA Data Security, Inc. Created 1991
- Copyright (C) 1990, RSA Data Security, Inc.
- Copyright (c) 2001 Markus Friedl.
- Copyright (c) 2002 by Niels Ferguson.
- Copyright (c) 1992, 1993 The Regents of the University of California.
- Copyright (C) 1995-2017 Jean-loup Gailly and Mark Adler
- Copyright (C) 1995-1998 Eric Young (eay@cryptsoft.com)
- Copyright (C) 1995-1998 Eric Young (eay@cryptsoft.com)
- Copyright (C) 1995, 1996, 1997, and 1998 WIDE Project.
- Copyright (c) 1982, 1986, 1991, 1993, 1994 The Regents of the University of California.
- Copyright 2005, 2014 jQuery Foundation, Inc. and other contributors
- Copyright 2013 Twitter Inc.
- Copyright (c) 2011-2022 Twitter, Inc.
- Copyright (c) 2011-2022 The Bootstrap Authors

- Copyright (c) 2009-2013 Chris Leonello
- Copyright (c) 2009 - 2010 Faruk Ates
- Copyright (c) 2010 Scott Prahl
- Copyright (c) 1990, 1993 The Regents of the University of California.

These are distributed with an expectation that they are useful by themselves, but Panasonic makes no warranty, including implied warranty of MERCHANTABILITY or FITNESS FOR SPECIAL PURPOSE. For details, refer to the following License Terms of Conditions.

<p>Copyright (c) April 29, 1997 Kalle Kaukonen. All Rights Reserved. draft-kaukonen-cipher-arcfour-03.txt Redistribution and use in source and binary forms, with or without modification, are permitted provided that this copyright notice and disclaimer are retained.</p> <p>THIS SOFTWARE IS PROVIDED BY KALLE KAUKONEN AND CONTRIBUTORS ``AS IS'' AND ANY EXPRESS OR IMPLIED WARRANTIES, INCLUDING, BUT NOT LIMITED TO, THE IMPLIED WARRANTIES OF MERCHANTABILITY AND FITNESS FOR A PARTICULAR PURPOSE ARE DISCLAIMED. IN NO EVENT SHALL KALLE KAUKONEN OR CONTRIBUTORS BE LIABLE FOR ANY DIRECT, INDIRECT, INCIDENTAL, SPECIAL, EXEMPLARY, OR CONSEQUENTIAL DAMAGES (INCLUDING, BUT NOT LIMITED TO, PROCUREMENT OF SUBSTITUTE GOODS OR SERVICES; LOSS OF USE, DATA, OR PROFITS; OR BUSINESS INTERRUPTION) HOWEVER CAUSED AND ON ANY THEORY OF LIABILITY, WHETHER IN CONTRACT, STRICT LIABILITY, OR TORT (INCLUDING NEGLIGENCE OR OTHERWISE) ARISING IN ANY WAY OUT OF THE USE OF THIS SOFTWARE, EVEN IF ADVISED OF THE POSSIBILITY OF SUCH DAMAGE.</p>
<p>Copyright (C) 1995-1998 Eric Young (eay@cryptsoft.com) All rights reserved. This package is an SSL implementation written by Eric Young (eay@cryptsoft.com). The implementation was written so as to conform with Netscapes SSL. This library is free for commercial and non-commercial use as long as the following conditions are adhered to. The following conditions apply to all code found in this distribution, be it the RC4, RSA, lhash, DES, etc., code; not just the SSL code. The SSL documentation included with this distribution is covered by the same copyright terms except that the holder is Tim Hudson (tjh@cryptsoft.com). Copyright remains Eric Young's, and as such any Copyright notices in the code are not to be removed. If this package is used in a product, Eric Young should be given attribution as the author of the parts of the library used. This can be in the form of a textual message at program startup or in documentation (online or textual) provided with the package. Redistribution and use in source and binary forms, with or without modification, are permitted provided that the following conditions are met:</p> <ol style="list-style-type: none"> 1. Redistributions of source code must retain the copyright notice, this list of conditions and the following disclaimer. 2. Redistributions in binary form must reproduce the above copyright notice, this list of conditions and the following disclaimer in the documentation and/or other materials provided with the distribution. 3. All advertising materials mentioning features or use of this software must display the following acknowledgement:

"This product includes cryptographic software written by Eric Young (eay@cryptsoft.com)"

The word 'cryptographic' can be left out if the routines from the library being used are not cryptographic related :-).

4. If you include any Windows specific code (or a derivative thereof) from the apps directory (application code) you must include an acknowledgement:

"This product includes software written by Tim Hudson (tjh@cryptsoft.com)"

THIS SOFTWARE IS PROVIDED BY ERIC YOUNG "AS IS" AND ANY EXPRESS OR IMPLIED WARRANTIES, INCLUDING, BUT NOT LIMITED TO, THE IMPLIED WARRANTIES OF MERCHANTABILITY AND FITNESS FOR A PARTICULAR PURPOSE ARE DISCLAIMED. IN NO EVENT SHALL THE AUTHOR OR CONTRIBUTORS BE LIABLE FOR ANY DIRECT, INDIRECT, INCIDENTAL, SPECIAL, EXEMPLARY, OR CONSEQUENTIAL DAMAGES (INCLUDING, BUT NOT LIMITED TO, PROCUREMENT OF SUBSTITUTE GOODS OR SERVICES; LOSS OF USE, DATA, OR PROFITS; OR BUSINESS INTERRUPTION) HOWEVER CAUSED AND ON ANY THEORY OF LIABILITY, WHETHER IN CONTRACT, STRICT LIABILITY, OR TORT (INCLUDING NEGLIGENCE OR OTHERWISE) ARISING IN ANY WAY OUT OF THE USE OF THIS SOFTWARE, EVEN IF ADVISED OF THE POSSIBILITY OF SUCH DAMAGE.

The licence and distribution terms for any publically available version or derivative of this code cannot be changed. i.e. this code cannot simply be copied and put under another distribution licence [including the GNU Public Licence.]

Copyright (C) 1995, 1996, 1997, and 1998 WIDE Project.

All rights reserved.

Redistribution and use in source and binary forms, with or without modification, are permitted provided that the following conditions are met:

1. Redistributions of source code must retain the above copyright notice, this list of conditions and the following disclaimer.
2. Redistributions in binary form must reproduce the above copyright notice, this list of conditions and the following disclaimer in the documentation and/or other materials provided with the distribution.
3. Neither the name of the project nor the names of its contributors may be used to endorse or promote products derived from this software without specific prior written permission.

THIS SOFTWARE IS PROVIDED BY THE PROJECT AND CONTRIBUTORS "AS IS" AND ANY EXPRESS OR IMPLIED WARRANTIES, INCLUDING, BUT NOT LIMITED TO, THE IMPLIED WARRANTIES OF MERCHANTABILITY AND FITNESS FOR A PARTICULAR PURPOSE ARE DISCLAIMED. IN NO EVENT SHALL THE PROJECT OR CONTRIBUTORS BE LIABLE FOR ANY DIRECT, INDIRECT, INCIDENTAL, SPECIAL, EXEMPLARY, OR CONSEQUENTIAL DAMAGES (INCLUDING, BUT NOT LIMITED TO, PROCUREMENT OF SUBSTITUTE GOODS OR SERVICES; LOSS OF USE, DATA, OR PROFITS; OR BUSINESS INTERRUPTION) HOWEVER CAUSED AND ON ANY THEORY OF LIABILITY, WHETHER IN CONTRACT, STRICT LIABILITY, OR TORT (INCLUDING NEGLIGENCE OR OTHERWISE) ARISING IN ANY WAY OUT OF THE USE OF THIS SOFTWARE, EVEN IF ADVISED OF THE POSSIBILITY OF SUCH DAMAGE.

Copyright (C) 1995-1997 Eric Young (eay@mincom.oz.au)

All rights reserved.

This package is an SSL implementation written by Eric Young (eay@mincom.oz.au).

The implementation was written so as to conform with Netscapes SSL.

This library is free for commercial and non-commercial use as long as the following conditions are adhered to. The following conditions apply to all code found in this distribution, be it the RC4, RSA, lhash, DES, etc., code; not just the SSL code. The SSL documentation included with this distribution is covered by the same copyright terms except that the holder is Tim Hudson (tjh@mincom.oz.au).

Copyright remains Eric Young's, and as such any Copyright notices in the code are not to be removed.

If this package is used in a product, Eric Young should be given attribution as the author of the parts of the library used.

This can be in the form of a textual message at program startup or in documentation (online or textual) provided with the package.

Redistribution and use in source and binary forms, with or without modification, are permitted provided that the following conditions are met:

1. Redistributions of source code must retain the copyright notice, this list of conditions and the following disclaimer.
2. Redistributions in binary form must reproduce the above copyright notice, this list of conditions and the following disclaimer in the documentation and/or other materials provided with the distribution.
3. All advertising materials mentioning features or use of this software must display the following acknowledgement:

"This product includes cryptographic software written by Eric Young (eay@mincom.oz.au)"

The word 'cryptographic' can be left out if the routines from the library being used are not cryptographic related :-).

4. If you include any Windows specific code (or a derivative thereof) from the apps directory (application code) you must include an acknowledgement:

"This product includes software written by Tim Hudson (tjh@mincom.oz.au)"

THIS SOFTWARE IS PROVIDED BY ERIC YOUNG "AS IS" AND ANY EXPRESS OR IMPLIED WARRANTIES, INCLUDING, BUT NOT LIMITED TO, THE IMPLIED WARRANTIES OF MERCHANTABILITY AND FITNESS FOR A PARTICULAR PURPOSE ARE DISCLAIMED. IN NO EVENT SHALL THE AUTHOR OR CONTRIBUTORS BE LIABLE FOR ANY DIRECT, INDIRECT, INCIDENTAL, SPECIAL, EXEMPLARY, OR CONSEQUENTIAL DAMAGES (INCLUDING, BUT NOT LIMITED TO, PROCUREMENT OF SUBSTITUTE GOODS OR SERVICES; LOSS OF USE, DATA, OR PROFITS; OR BUSINESS INTERRUPTION) HOWEVER CAUSED AND ON ANY THEORY OF LIABILITY, WHETHER IN CONTRACT, STRICT LIABILITY, OR TORT (INCLUDING NEGLIGENCE OR OTHERWISE) ARISING IN ANY WAY OUT OF THE USE OF THIS SOFTWARE, EVEN IF ADVISED OF THE POSSIBILITY OF SUCH DAMAGE.

The licence and distribution terms for any publically available version or derivative of this code cannot be changed. i.e. this code cannot simply be copied and put under another distribution licence

[including the GNU Public Licence.]

Copyright (C) 1997 Hideo "Sir MANMOS" Morishita

All rights reserved.

Redistribution and use in source and binary forms, with or without modification, are permitted provided that the following conditions are met:

1. Redistributions of source code must retain the above copyright notice, this list of conditions and the following disclaimer.
2. Redistributions in binary form must reproduce the above copyright notice, this list of conditions and the following disclaimer in the

documentation and/or other materials provided with the distribution.
THIS SOFTWARE IS PROVIDED BY Hideo "Sir MaNMOS" Morishita "AS IS" AND ANY EXPRESS OR IMPLIED WARRANTIES, INCLUDING, BUT NOT LIMITED TO, THE IMPLIED WARRANTIES OF MERCHANTABILITY AND FITNESS FOR A PARTICULAR PURPOSE ARE DISCLAIMED. IN NO EVENT SHALL Hideo "Sir MaNMOS" Morishita BE LIABLE FOR ANY DIRECT, INDIRECT, INCIDENTAL, SPECIAL, EXEMPLARY, OR CONSEQUENTIAL DAMAGES (INCLUDING, BUT NOT LIMITED TO, PROCUREMENT OF SUBSTITUTE GOODS OR SERVICES; LOSS OF USE, DATA, OR PROFITS; OR BUSINESS INTERRUPTION) HOWEVER CAUSED AND ON ANY THEORY OF LIABILITY, WHETHER IN CONTRACT, STRICT LIABILITY, OR TORT (INCLUDING NEGLIGENCE OR OTHERWISE) ARISING IN ANY WAY OUT OF THE USE OF THIS SOFTWARE, EVEN IF ADVISED OF THE POSSIBILITY OF SUCH DAMAGE.

Copyright (C) 1995-1996 Eric Young (eay@mincom.oz.au)
All rights reserved.

This file is part of an SSL implementation written
by Eric Young (eay@mincom.oz.au).

The implementation was written so as to conform with Netscapes SSL specification. This library and applications are
FREE FOR COMMERCIAL AND NON-COMMERCIAL USE
as long as the following conditions are adhered to.

Copyright remains Eric Young's, and as such any Copyright notices in the code are not to be removed. If this code is used in a product, Eric Young should be given attribution as the author of the parts used.

This can be in the form of a textual message at program startup or in documentation (online or textual) provided with the package.

Redistribution and use in source and binary forms, with or without modification, are permitted provided that the following conditions are met:

1. Redistributions of source code must retain the copyright notice, this list of conditions and the following disclaimer.
2. Redistributions in binary form must reproduce the above copyright notice, this list of conditions and the following disclaimer in the documentation and/or other materials provided with the distribution.
3. All advertising materials mentioning features or use of this software must display the following acknowledgement:

This product includes software developed by Eric Young (eay@mincom.oz.au)

THIS SOFTWARE IS PROVIDED BY ERIC YOUNG "AS IS" AND ANY EXPRESS OR IMPLIED WARRANTIES, INCLUDING, BUT NOT LIMITED TO, THE IMPLIED WARRANTIES OF MERCHANTABILITY AND FITNESS FOR A PARTICULAR PURPOSE ARE DISCLAIMED. IN NO EVENT SHALL THE AUTHOR OR CONTRIBUTORS BE LIABLE FOR ANY DIRECT, INDIRECT, INCIDENTAL, SPECIAL, EXEMPLARY, OR CONSEQUENTIAL DAMAGES (INCLUDING, BUT NOT LIMITED TO, PROCUREMENT OF SUBSTITUTE GOODS OR SERVICES; LOSS OF USE, DATA, OR PROFITS; OR BUSINESS INTERRUPTION) HOWEVER CAUSED AND ON ANY THEORY OF LIABILITY, WHETHER IN CONTRACT, STRICT LIABILITY, OR TORT (INCLUDING NEGLIGENCE OR OTHERWISE) ARISING IN ANY WAY OUT OF THE USE OF THIS SOFTWARE, EVEN IF ADVISED OF THE POSSIBILITY OF SUCH DAMAGE.

The licence and distribution terms for any publically available version or derivative of this code cannot be changed. i.e. this code cannot simply be copied and put under another distribution licence
[including the GNU Public Licence.]

Copyright (C) 1991-2, RSA Data Security, Inc. Created 1991. All rights reserved.
License to copy and use this software is granted provided that it

<p>is identified as the "RSA Data Security, Inc. MD4 Message-Digest Algorithm" in all material mentioning or referencing this software or this function.</p> <p>License is also granted to make and use derivative works provided that such works are identified as "derived from the RSA Data Security, Inc. MD4 Message-Digest Algorithm" in all material mentioning or referencing the derived work.</p> <p>RSA Data Security, Inc. makes no representations concerning either the merchantability of this software or the suitability of this software for any particular purpose. It is provided "as is" without express or implied warranty of any kind.</p> <p>These notices must be retained in any copies of any part of this documentation and/or software.</p>
<p>Copyright (C) 1990, RSA Data Security, Inc. All rights reserved.</p> <p>License to copy and use this software is granted provided that it is identified as the "RSA Data Security, Inc. MD5 Message-Digest Algorithm" in all material mentioning or referencing this software or this function.</p> <p>License is also granted to make and use derivative works provided that such works are identified as "derived from the RSA Data Security, Inc. MD5 Message-Digest Algorithm" in all material mentioning or referencing the derived work.</p> <p>RSA Data Security, Inc. makes no representations concerning either the merchantability of this software or the suitability of this software for any particular purpose. It is provided "as is" without express or implied warranty of any kind.</p> <p>These notices must be retained in any copies of any part of this documentation and/or software.</p>
<p>Copyright (c) 2001 Markus Friedl. All rights reserved.</p> <p>Redistribution and use in source and binary forms, with or without modification, are permitted provided that the following conditions are met:</p> <ol style="list-style-type: none"> 1. Redistributions of source code must retain the above copyright notice, this list of conditions and the following disclaimer. 2. Redistributions in binary form must reproduce the above copyright notice, this list of conditions and the following disclaimer in the documentation and/or other materials provided with the distribution. <p>THIS SOFTWARE IS PROVIDED BY THE AUTHOR "AS IS" AND ANY EXPRESS OR IMPLIED WARRANTIES, INCLUDING, BUT NOT LIMITED TO, THE IMPLIED WARRANTIES OF MERCHANTABILITY AND FITNESS FOR A PARTICULAR PURPOSE ARE DISCLAIMED. IN NO EVENT SHALL THE AUTHOR BE LIABLE FOR ANY DIRECT, INDIRECT, INCIDENTAL, SPECIAL, EXEMPLARY, OR CONSEQUENTIAL DAMAGES (INCLUDING, BUT NOT LIMITED TO, PROCUREMENT OF SUBSTITUTE GOODS OR SERVICES; LOSS OF USE, DATA, OR PROFITS; OR BUSINESS INTERRUPTION) HOWEVER CAUSED AND ON ANY THEORY OF LIABILITY, WHETHER IN CONTRACT, STRICT LIABILITY, OR TORT (INCLUDING NEGLIGENCE OR OTHERWISE) ARISING IN ANY WAY OUT OF THE USE OF THIS SOFTWARE, EVEN IF ADVISED OF THE POSSIBILITY OF SUCH DAMAGE.</p>
<p>Copyright (c) 2002 by Niels Ferguson.</p> <p>The author hereby grants a perpetual license to everybody to use this code for any purpose as long as the copyright message is included in the source code of this or any derived work.</p> <p>Yes, this means that you, your company, your club, and anyone else can</p>

use this code anywhere you want. You can change it and distribute it under the GPL, include it in your commercial product without releasing the source code, put it on the web, etc. The only thing you cannot do is remove my copyright message, or distribute any source code based on this implementation that does not include my copyright message.

I appreciate a mention in the documentation or credits, but I understand if that is difficult to do. I also appreciate it if you tell me where and why you used my code.

DISCLAIMER: As I'm giving away my work for free, I'm of course not going to accept any liability of any form. This code, or the Twofish cipher, might very well be flawed; you have been warned. This software is provided as-is, without any kind of warranty or guarantee. And that is really all you can expect when you download code for free from the Internet.

Copyright (c) 1992, 1993

The Regents of the University of California. All rights reserved.

Redistribution and use in source and binary forms, with or without modification, are permitted provided that the following conditions are met:

1. Redistributions of source code must retain the above copyright notice, this list of conditions and the following disclaimer.
2. Redistributions in binary form must reproduce the above copyright notice, this list of conditions and the following disclaimer in the documentation and/or other materials provided with the distribution.
3. All advertising materials mentioning features or use of this software must display the following acknowledgement:

This product includes software developed by the University of California, Berkeley and its contributors.

4. Neither the name of the University nor the names of its contributors may be used to endorse or promote products derived from this software without specific prior written permission.

THIS SOFTWARE IS PROVIDED BY THE REGENTS AND CONTRIBUTORS "AS IS" AND ANY EXPRESS OR IMPLIED WARRANTIES, INCLUDING, BUT NOT LIMITED TO, THE IMPLIED WARRANTIES OF MERCHANTABILITY AND FITNESS FOR A PARTICULAR PURPOSE ARE DISCLAIMED. IN NO EVENT SHALL THE REGENTS OR CONTRIBUTORS BE LIABLE FOR ANY DIRECT, INDIRECT, INCIDENTAL, SPECIAL, EXEMPLARY, OR CONSEQUENTIAL DAMAGES (INCLUDING, BUT NOT LIMITED TO, PROCUREMENT OF SUBSTITUTE GOODS OR SERVICES; LOSS OF USE, DATA, OR PROFITS; OR BUSINESS INTERRUPTION) HOWEVER CAUSED AND ON ANY THEORY OF LIABILITY, WHETHER IN CONTRACT, STRICT LIABILITY, OR TORT (INCLUDING NEGLIGENCE OR OTHERWISE) ARISING IN ANY WAY OUT OF THE USE OF THIS SOFTWARE, EVEN IF ADVISED OF THE POSSIBILITY OF SUCH DAMAGE.

zlib.h -- interface of the 'zlib' general purpose compression library
version 1.2.11, January 15th, 2017

Copyright (C) 1995-2017 Jean-loup Gailly and Mark Adler

This software is provided 'as-is', without any express or implied warranty. In no event will the authors be held liable for any damages arising from the use of this software.

Permission is granted to anyone to use this software for any purpose, including commercial applications, and to alter it and redistribute it freely, subject to the following restrictions:

1. The origin of this software must not be misrepresented; you must not claim that you wrote the original software. If you use this software

in a product, an acknowledgment in the product documentation would be appreciated but is not required.

2. Altered source versions must be plainly marked as such, and must not be misrepresented as being the original software.

3. This notice may not be removed or altered from any source distribution.

Jean-loup Gailly Mark Adler

jloup@gzip.orgmadler@alumni.caltech.edu

Copyright (C) 1995-1998 Eric Young (eay@cryptsoft.com)

All rights reserved.

This package is an SSL implementation written

by Eric Young (eay@cryptsoft.com).

The implementation was written so as to conform with Netscapes SSL.

This library is free for commercial and non-commercial use as long as

the following conditions are adhered to. The following conditions

apply to all code found in this distribution, be it the RC4, tRSA,

lhash, DES, etc., code; not just the SSL code. The SSL documentation

included with this distribution is covered by the same copyright terms

except that the holder is Tim Hudson (tjh@cryptsoft.com).

Copyright remains Eric Young's, and as such any Copyright notices in

the code are not to be removed.

If this package is used in a product, Eric Young should be given attribution as the author of the parts of the library used.

This can be in the form of a textual message at program startup or

in documentation (online or textual) provided with the package.

Redistribution and use in source and binary forms, with or without

modification, are permitted provided that the following conditions

are met:

1. Redistributions of source code must retain the copyright

notice, this list of conditions and the following disclaimer.

2. Redistributions in binary form must reproduce the above copyright

notice, this list of conditions and the following disclaimer in the

documentation and/or other materials provided with the distribution.

3. All advertising materials mentioning features or use of this software

must display the following acknowledgement:

"This product includes cryptographic software written by

Eric Young (eay@cryptsoft.com)"

The word 'cryptographic' can be left out if the routines from the library

being used are not cryptographic related :-).

4. If you include any Windows specific code (or a derivative thereof) from

the apps directory (application code) you must include an acknowledgement:

"This product includes software written by Tim Hudson (tjh@cryptsoft.com)"

THIS SOFTWARE IS PROVIDED BY ERIC YOUNG "AS IS" AND

ANY EXPRESS OR IMPLIED WARRANTIES, INCLUDING, BUT NOT LIMITED TO, THE

IMPLIED WARRANTIES OF MERCHANTABILITY AND FITNESS FOR A PARTICULAR PURPOSE

ARE DISCLAIMED. IN NO EVENT SHALL THE AUTHOR OR CONTRIBUTORS BE LIABLE

FOR ANY DIRECT, INDIRECT, INCIDENTAL, SPECIAL, EXEMPLARY, OR CONSEQUENTIAL

DAMAGES (INCLUDING, BUT NOT LIMITED TO, PROCUREMENT OF SUBSTITUTE GOODS

OR SERVICES; LOSS OF USE, DATA, OR PROFITS; OR BUSINESS INTERRUPTION)

HOWEVER CAUSED AND ON ANY THEORY OF LIABILITY, WHETHER IN CONTRACT, STRICT

LIABILITY, OR TORT (INCLUDING NEGLIGENCE OR OTHERWISE) ARISING IN ANY WAY

OUT OF THE USE OF THIS SOFTWARE, EVEN IF ADVISED OF THE POSSIBILITY OF

SUCH DAMAGE.

The licence and distribution terms for any publicly available version or

derivative of this code cannot be changed. i.e. this code cannot simply be copied and put under another distribution licence [including the GNU Public Licence.]

Copyright (C) 1995-1998 Eric Young (eay@cryptsoft.com)

All rights reserved.

This package is an SSL implementation written by Eric Young (eay@cryptsoft.com).

The implementation was written so as to conform with Netscapes SSL.

This library is tm_kernel_free for commercial and non-commercial use as long as the following conditions are adhered to. The following conditions apply to all code found in this distribution, be it the RC4, RSA, lhash, DES, etc., code; not just the SSL code. The SSL documentation included with this distribution is covered by the same copyright terms except that the holder is Tim Hudson (tjh@cryptsoft.com).

Copyright remains Eric Young's, and as such any Copyright notices in the code are not to be removed.

If this package is used in a product, Eric Young should be given attribution as the author of the parts of the library used.

This can be in the form of a textual message at program startup or in documentation (online or textual) provided with the package.

Redistribution and use in source and binary forms, with or without modification, are permitted provided that the following conditions are met:

1. Redistributions of source code must retain the copyright notice, this list of conditions and the following disclaimer.
2. Redistributions in binary form must reproduce the above copyright notice, this list of conditions and the following disclaimer in the documentation and/or other materials provided with the distribution.
3. All advertising materials mentioning features or use of this software must display the following acknowledgement:

"This product includes cryptographic software written by Eric Young (eay@cryptsoft.com)"

The word 'cryptographic' can be left out if the routines from the library being used are not cryptographic related :-).

4. If you include any Windows specific code (or a derivative thereof) from the apps directory (application code) you must include an acknowledgement:

"This product includes software written by Tim Hudson (tjh@cryptsoft.com)"

THIS SOFTWARE IS PROVIDED BY ERIC YOUNG "AS IS" AND ANY EXPRESS OR IMPLIED WARRANTIES, INCLUDING, BUT NOT LIMITED TO, THE IMPLIED WARRANTIES OF MERCHANTABILITY AND FITNESS FOR A PARTICULAR PURPOSE ARE DISCLAIMED. IN NO EVENT SHALL THE AUTHOR OR CONTRIBUTORS BE LIABLE FOR ANY DIRECT, INDIRECT, INCIDENTAL, SPECIAL, EXEMPLARY, OR CONSEQUENTIAL DAMAGES (INCLUDING, BUT NOT LIMITED TO, PROCUREMENT OF SUBSTITUTE GOODS OR SERVICES; LOSS OF USE, DATA, OR PROFITS; OR BUSINESS INTERRUPTION) HOWEVER CAUSED AND ON ANY THEORY OF LIABILITY, WHETHER IN CONTRACT, STRICT LIABILITY, OR TORT (INCLUDING NEGLIGENCE OR OTHERWISE) ARISING IN ANY WAY OUT OF THE USE OF THIS SOFTWARE, EVEN IF ADVISED OF THE POSSIBILITY OF SUCH DAMAGE.

The licence and distribution terms for any publically available version or derivative of this code cannot be changed. i.e. this code cannot simply be copied and put under another distribution licence

[including the GNU Public Licence.]

Copyright (C) 1995, 1996, 1997, and 1998 WIDE Project.

All rights reserved.

Redistribution and use in source and binary forms, with or without modification, are permitted provided that the following conditions are met:

1. Redistributions of source code must retain the above copyright notice, this list of conditions and the following disclaimer.
2. Redistributions in binary form must reproduce the above copyright notice, this list of conditions and the following disclaimer in the documentation and/or other materials provided with the distribution.
3. Neither the name of the project nor the names of its contributors may be used to endorse or promote products derived from this software without specific prior written permission.

THIS SOFTWARE IS PROVIDED BY THE PROJECT AND CONTRIBUTORS "AS IS" AND ANY EXPRESS OR IMPLIED WARRANTIES, INCLUDING, BUT NOT LIMITED TO, THE IMPLIED WARRANTIES OF MERCHANTABILITY AND FITNESS FOR A PARTICULAR PURPOSE ARE DISCLAIMED. IN NO EVENT SHALL THE PROJECT OR CONTRIBUTORS BE LIABLE FOR ANY DIRECT, INDIRECT, INCIDENTAL, SPECIAL, EXEMPLARY, OR CONSEQUENTIAL DAMAGES (INCLUDING, BUT NOT LIMITED TO, PROCUREMENT OF SUBSTITUTE GOODS OR SERVICES; LOSS OF USE, DATA, OR PROFITS; OR BUSINESS INTERRUPTION) HOWEVER CAUSED AND ON ANY THEORY OF LIABILITY, WHETHER IN CONTRACT, STRICT LIABILITY, OR TORT (INCLUDING NEGLIGENCE OR OTHERWISE) ARISING IN ANY WAY OUT OF THE USE OF THIS SOFTWARE, EVEN IF ADVISED OF THE POSSIBILITY OF SUCH DAMAGE.

Copyright (c) 1982, 1986, 1991, 1993, 1994

The Regents of the University of California. All rights reserved.

(c) UNIX System Laboratories, Inc.

All or some portions of this file are derived from material licensed to the University of California by American Telephone and Telegraph Co. or Unix System Laboratories, Inc. and are reproduced herein with the permission of UNIX System Laboratories, Inc.

Redistribution and use in source and binary forms, with or without modification, are permitted provided that the following conditions are met:

1. Redistributions of source code must retain the above copyright notice, this list of conditions and the following disclaimer.
2. Redistributions in binary form must reproduce the above copyright notice, this list of conditions and the following disclaimer in the documentation and/or other materials provided with the distribution.
3. All advertising materials mentioning features or use of this software must display the following acknowledgement:

This product includes software developed by the University of California, Berkeley and its contributors.

4. Neither the name of the University nor the names of its contributors may be used to endorse or promote products derived from this software without specific prior written permission.

THIS SOFTWARE IS PROVIDED BY THE REGENTS AND CONTRIBUTORS "AS IS" AND ANY EXPRESS OR IMPLIED WARRANTIES, INCLUDING, BUT NOT LIMITED TO, THE IMPLIED WARRANTIES OF MERCHANTABILITY AND FITNESS FOR A PARTICULAR PURPOSE ARE DISCLAIMED. IN NO EVENT SHALL THE REGENTS OR CONTRIBUTORS BE LIABLE FOR ANY DIRECT, INDIRECT, INCIDENTAL, SPECIAL, EXEMPLARY, OR CONSEQUENTIAL DAMAGES (INCLUDING, BUT NOT LIMITED TO, PROCUREMENT OF SUBSTITUTE GOODS

OR SERVICES; LOSS OF USE, DATA, OR PROFITS; OR BUSINESS INTERRUPTION) HOWEVER CAUSED AND ON ANY THEORY OF LIABILITY, WHETHER IN CONTRACT, STRICT LIABILITY, OR TORT (INCLUDING NEGLIGENCE OR OTHERWISE) ARISING IN ANY WAY OUT OF THE USE OF THIS SOFTWARE, EVEN IF ADVISED OF THE POSSIBILITY OF SUCH DAMAGE.

Copyright OpenJS Foundation and other contributors, <https://openjsf.org/>

Permission is hereby granted, free of charge, to any person obtaining a copy of this software and associated documentation files (the "Software"), to deal in the Software without restriction, including without limitation the rights to use, copy, modify, merge, publish, distribute, sublicense, and/or sell copies of the Software, and to permit persons to whom the Software is furnished to do so, subject to the following conditions:

The above copyright notice and this permission notice shall be included in all copies or substantial portions of the Software.

THE SOFTWARE IS PROVIDED "AS IS", WITHOUT WARRANTY OF ANY KIND, EXPRESS OR IMPLIED, INCLUDING BUT NOT LIMITED TO THE WARRANTIES OF MERCHANTABILITY, FITNESS FOR A PARTICULAR PURPOSE AND NONINFRINGEMENT. IN NO EVENT SHALL THE AUTHORS OR COPYRIGHT HOLDERS BE LIABLE FOR ANY CLAIM, DAMAGES OR OTHER LIABILITY, WHETHER IN AN ACTION OF CONTRACT, TORT OR OTHERWISE, ARISING FROM, OUT OF OR IN CONNECTION WITH THE SOFTWARE OR THE USE OR OTHER DEALINGS IN THE SOFTWARE.

bootstrap.js v3.0.0 by @fat and @mdo

Copyright 2013 Twitter Inc.

<http://www.apache.org/licenses/LICENSE-2.0>

Apache License

Version 2.0, January 2004

<http://www.apache.org/licenses/>

TERMS AND CONDITIONS FOR USE, REPRODUCTION, AND DISTRIBUTION

1. Definitions.

"License" shall mean the terms and conditions for use, reproduction, and distribution as defined by Sections 1 through 9 of this document.

"Licensor" shall mean the copyright owner or entity authorized by the copyright owner that is granting the License.

"Legal Entity" shall mean the union of the acting entity and all other entities that control, are controlled by, or are under common control with that entity. For the purposes of this definition,

"control" means (i) the power, direct or indirect, to cause the direction or management of such entity, whether by contract or otherwise, or (ii) ownership of fifty percent (50%) or more of the outstanding shares, or (iii) beneficial ownership of such entity.

"You" (or "Your") shall mean an individual or Legal Entity exercising permissions granted by this License.

"Source" form shall mean the preferred form for making modifications, including but not limited to software source code, documentation source, and configuration files.

"Object" form shall mean any form resulting from mechanical transformation or translation of a Source form, including but not limited to compiled object code, generated documentation, and conversions to other media types.

"Work" shall mean the work of authorship, whether in Source or Object form, made available under the License, as indicated by a copyright notice that is included in or attached to the work

(an example is provided in the Appendix below).

"Derivative Works" shall mean any work, whether in Source or Object form, that is based on (or derived from) the Work and for which the editorial revisions, annotations, elaborations, or other modifications represent, as a whole, an original work of authorship. For the purposes of this License, Derivative Works shall not include works that remain separable from, or merely link (or bind by name) to the interfaces of, the Work and Derivative Works thereof.

"Contribution" shall mean any work of authorship, including the original version of the Work and any modifications or additions to that Work or Derivative Works thereof, that is intentionally submitted to Licensor for inclusion in the Work by the copyright owner or by an individual or Legal Entity authorized to submit on behalf of the copyright owner. For the purposes of this definition, "submitted" means any form of electronic, verbal, or written communication sent to the Licensor or its representatives, including but not limited to communication on electronic mailing lists, source code control systems, and issue tracking systems that are managed by, or on behalf of, the Licensor for the purpose of discussing and improving the Work, but excluding communication that is conspicuously marked or otherwise designated in writing by the copyright owner as "Not a Contribution."

"Contributor" shall mean Licensor and any individual or Legal Entity on behalf of whom a Contribution has been received by Licensor and subsequently incorporated within the Work.

2. Grant of Copyright License. Subject to the terms and conditions of this License, each Contributor hereby grants to You a perpetual, worldwide, non-exclusive, no-charge, royalty-free, irrevocable copyright license to reproduce, prepare Derivative Works of, publicly display, publicly perform, sublicense, and distribute the Work and such Derivative Works in Source or Object form.

3. Grant of Patent License. Subject to the terms and conditions of this License, each Contributor hereby grants to You a perpetual, worldwide, non-exclusive, no-charge, royalty-free, irrevocable (except as stated in this section) patent license to make, have made, use, offer to sell, sell, import, and otherwise transfer the Work, where such license applies only to those patent claims licensable by such Contributor that are necessarily infringed by their Contribution(s) alone or by combination of their Contribution(s) with the Work to which such Contribution(s) was submitted. If You institute patent litigation against any entity (including a cross-claim or counterclaim in a lawsuit) alleging that the Work or a Contribution incorporated within the Work constitutes direct or contributory patent infringement, then any patent licenses granted to You under this License for that Work shall terminate as of the date such litigation is filed.

4. Redistribution. You may reproduce and distribute copies of the Work or Derivative Works thereof in any medium, with or without modifications, and in Source or Object form, provided that You meet the following conditions:

- (a) You must give any other recipients of the Work or Derivative Works a copy of this License; and
- (b) You must cause any modified files to carry prominent notices stating that You changed the files; and

(c) You must retain, in the Source form of any Derivative Works that You distribute, all copyright, patent, trademark, and attribution notices from the Source form of the Work, excluding those notices that do not pertain to any part of the Derivative Works; and

(d) If the Work includes a "NOTICE" text file as part of its distribution, then any Derivative Works that You distribute must include a readable copy of the attribution notices contained within such NOTICE file, excluding those notices that do not pertain to any part of the Derivative Works, in at least one of the following places: within a NOTICE text file distributed as part of the Derivative Works; within the Source form or documentation, if provided along with the Derivative Works; or, within a display generated by the Derivative Works, if and wherever such third-party notices normally appear. The contents of the NOTICE file are for informational purposes only and do not modify the License. You may add Your own attribution notices within Derivative Works that You distribute, alongside or as an addendum to the NOTICE text from the Work, provided that such additional attribution notices cannot be construed as modifying the License.

You may add Your own copyright statement to Your modifications and may provide additional or different license terms and conditions for use, reproduction, or distribution of Your modifications, or for any such Derivative Works as a whole, provided Your use, reproduction, and distribution of the Work otherwise complies with the conditions stated in this License.

5. Submission of Contributions. Unless You explicitly state otherwise, any Contribution intentionally submitted for inclusion in the Work by You to the Licensor shall be under the terms and conditions of this License, without any additional terms or conditions.

Notwithstanding the above, nothing herein shall supersede or modify the terms of any separate license agreement you may have executed with Licensor regarding such Contributions.

6. Trademarks. This License does not grant permission to use the trade names, trademarks, service marks, or product names of the Licensor, except as required for reasonable and customary use in describing the origin of the Work and reproducing the content of the NOTICE file.

7. Disclaimer of Warranty. Unless required by applicable law or agreed to in writing, Licensor provides the Work (and each Contributor provides its Contributions) on an "AS IS" BASIS, WITHOUT WARRANTIES OR CONDITIONS OF ANY KIND, either express or implied, including, without limitation, any warranties or conditions of TITLE, NON-INFRINGEMENT, MERCHANTABILITY, or FITNESS FOR A PARTICULAR PURPOSE. You are solely responsible for determining the appropriateness of using or redistributing the Work and assume any risks associated with Your exercise of permissions under this License.

8. Limitation of Liability. In no event and under no legal theory, whether in tort (including negligence), contract, or otherwise, unless required by applicable law (such as deliberate and grossly negligent acts) or agreed to in writing, shall any Contributor be liable to You for damages, including any direct, indirect, special, incidental, or consequential damages of any character arising as a

result of this License or out of the use or inability to use the Work (including but not limited to damages for loss of goodwill, work stoppage, computer failure or malfunction, or any and all other commercial damages or losses), even if such Contributor has been advised of the possibility of such damages.

9. Accepting Warranty or Additional Liability. While redistributing the Work or Derivative Works thereof, You may choose to offer, and charge a fee for, acceptance of support, warranty, indemnity, or other liability obligations and/or rights consistent with this License. However, in accepting such obligations, You may act only on Your own behalf and on Your sole responsibility, not on behalf of any other Contributor, and only if You agree to indemnify, defend, and hold each Contributor harmless for any liability incurred by, or claims asserted against, such Contributor by reason of your accepting any such warranty or additional liability.

The MIT License (MIT)

Copyright (c) 2011-2022 Twitter, Inc.

Copyright (c) 2011-2022 The Bootstrap Authors

Permission is hereby granted, free of charge, to any person obtaining a copy of this software and associated documentation files (the "Software"), to deal in the Software without restriction, including without limitation the rights to use, copy, modify, merge, publish, distribute, sublicense, and/or sell copies of the Software, and to permit persons to whom the Software is furnished to do so, subject to the following conditions:

The above copyright notice and this permission notice shall be included in all copies or substantial portions of the Software.

THE SOFTWARE IS PROVIDED "AS IS", WITHOUT WARRANTY OF ANY KIND, EXPRESS OR IMPLIED, INCLUDING BUT NOT LIMITED TO THE WARRANTIES OF MERCHANTABILITY, FITNESS FOR A PARTICULAR PURPOSE AND NONINFRINGEMENT. IN NO EVENT SHALL THE AUTHORS OR COPYRIGHT HOLDERS BE LIABLE FOR ANY CLAIM, DAMAGES OR OTHER LIABILITY, WHETHER IN AN ACTION OF CONTRACT, TORT OR OTHERWISE, ARISING FROM, OUT OF OR IN CONNECTION WITH THE SOFTWARE OR THE USE OR OTHER DEALINGS IN THE SOFTWARE.

Title: MIT License

Copyright (c) 2009-2013 Chris Leonello

Permission is hereby granted, free of charge, to any person obtaining a copy of this software and associated documentation files (the "Software"), to deal in the Software without restriction, including without limitation the rights to use, copy, modify, merge, publish, distribute, sublicense, and/or sell copies of the Software, and to permit persons to whom the Software is furnished to do so, subject to the following conditions:

The above copyright notice and this permission notice shall be included in all copies or substantial portions of the Software.

THE SOFTWARE IS PROVIDED "AS IS", WITHOUT WARRANTY OF ANY KIND, EXPRESS OR IMPLIED, INCLUDING BUT NOT LIMITED TO THE WARRANTIES OF MERCHANTABILITY, FITNESS FOR A PARTICULAR PURPOSE AND NONINFRINGEMENT. IN NO EVENT SHALL THE AUTHORS OR COPYRIGHT HOLDERS BE LIABLE FOR ANY CLAIM, DAMAGES OR OTHER LIABILITY, WHETHER IN AN ACTION OF CONTRACT, TORT OR OTHERWISE, ARISING FROM, OUT OF OR IN CONNECTION WITH THE SOFTWARE OR THE USE OR OTHER DEALINGS IN THE SOFTWARE.

Object with extended date parsing and formatting capabilities.

This library borrows many concepts and ideas from the Date Instance

Methods by Ken Snyder along with some parts of Ken's actual code Ken's original Date Instance Methods and copyright notice:

Ken Snyder (ken d snyder at gmail dot com)

2008/9/10

version 2.0.2 (<http://kendsnyder.com/sandbox/date/>)

Creative Commons Attribution License 3.0 (<http://creativecommons.org/licenses/by/3.0/>)

Copyright (c) 1990, 1993

The Regents of the University of California. All rights reserved.

Redistribution and use in source and binary forms, with or without modification, are permitted provided that the following conditions are met:

1. Redistributions of source code must retain the above copyright notice, this list of conditions and the following disclaimer.
2. Redistributions in binary form must reproduce the above copyright notice, this list of conditions and the following disclaimer in the documentation and/or other materials provided with the distribution.
3. All advertising materials mentioning features or use of this software must display the following acknowledgement:

This product includes software developed by the University of California, Berkeley and its contributors.

4. Neither the name of the University nor the names of its contributors may be used to endorse or promote products derived from this software without specific prior written permission.

THIS SOFTWARE IS PROVIDED BY THE REGENTS AND CONTRIBUTORS "AS IS" AND ANY EXPRESS OR IMPLIED WARRANTIES, INCLUDING, BUT NOT LIMITED TO, THE IMPLIED WARRANTIES OF MERCHANTABILITY AND FITNESS FOR A PARTICULAR PURPOSE ARE DISCLAIMED. IN NO EVENT SHALL THE REGENTS OR CONTRIBUTORS BE LIABLE FOR ANY DIRECT, INDIRECT, INCIDENTAL, SPECIAL, EXEMPLARY, OR CONSEQUENTIAL DAMAGES (INCLUDING, BUT NOT LIMITED TO, PROCUREMENT OF SUBSTITUTE GOODS OR SERVICES; LOSS OF USE, DATA, OR PROFITS; OR BUSINESS INTERRUPTION) HOWEVER CAUSED AND ON ANY THEORY OF LIABILITY, WHETHER IN CONTRACT, STRICT LIABILITY, OR TORT (INCLUDING NEGLIGENCE OR OTHERWISE) ARISING IN ANY WAY OUT OF THE USE OF THIS SOFTWARE, EVEN IF ADVISED OF THE POSSIBILITY OF SUCH DAMAGE.

(MEMO)

Table of Contents

1 Overview	1-1
1.1 System Configuration.....	1-2
1.1.1 List of Units	1-2
1.2 Restrictions on Combinations of Units	1-4
1.2.1 CPU Unit Type	1-4
1.2.2 Common Restrictions on Each Unit	1-5
1.2.3 Restrictions on the Number of Installed Units.....	1-5
1.2.4 Restrictions on the Combination of Extension Cassettes	1-5
1.2.5 Restrictions on Communication Functions to be Used	1-6
1.2.6 Unit to be Used and Applicable Versions.....	1-6
1.3 Restrictions on Using Expansion Unit.....	1-8
1.3.1 Configuration When Using Expansion Unit.....	1-8
1.3.2 Restrictions on Combinations of Units	1-9
1.3.3 Installation Position of Units and Access Time	1-10
1.3.4 Restrictions on Configuration Capacity.....	1-10
1.4 Selection of Power Supply and Restrictions on Combination	1-12
1.4.1 Power Supply for Internal Circuit	1-12
1.4.2 List of Power Supply Unit's Current Consumption for Internal Circuit.....	1-14
1.4.3 Power Supply for External Circuit	1-16
1.5 Programming Tools.....	1-18
2 Names and functions of parts	2-1
2.1 CPU Unit (CPS4R*/CPS3R*).....	2-2
2.2 CPU Unit (CPS2R).....	2-5
2.3 Power Supply Unit	2-7
2.4 Expansion Master Unit / Expansion Slave Unit	2-8
3 I/O Number Allocation	3-1
3.1 Basics of I/O Allocation.....	3-2
3.1.1 How to Count the I/O Numbers	3-2
3.1.2 Concept of I/O Number Allocation	3-2
3.1.3 List of Occupied I/O Points for Each Unit.....	3-3
3.2 Optional Allocation Using FPWIN GR7	3-6
3.2.1 Registration of a Unit to be Used and the Starting Word Number ...	3-6
3.2.2 Optional Settings in the "Unit Selection" Dialog Box	3-8
3.2.3 Settings When Using Expansion Unit	3-8
3.3 Mount Allocation Using FPWIN GR7	3-10
3.3.1 Mount Registration of a Unit to be Used and the Starting Word Number	3-10
3.3.2 Changing the Starting Word Number	3-10
3.4 I/O Map Registration	3-12
3.4.1 I/O Map Registration	3-12
3.4.2 I/O Map Clearance.....	3-12

4	Installation and Wiring	4-1
4.1	Installation	4-2
4.1.1	Installation Environment and Space	4-2
4.1.2	Attaching Units	4-4
4.1.3	DIN Rail Attachment	4-6
4.2	Wiring the Power Supply	4-9
4.2.1	Common Precautions	4-9
4.2.2	Wiring for Power Supply Units	4-9
4.2.3	Wiring for the Power Supply Part of the CPU Unit	4-10
4.2.4	Wiring of Power Supply Part of Expansion Slave Unit	4-11
4.2.5	Grounding	4-11
4.3	Wiring of Expansion Cable	4-13
4.3.1	Expansion Cable Type	4-13
4.3.2	Connection of Function Earth Wire	4-13
4.3.3	Connecting Position and Direction of Expansion Cables	4-13
4.4	Safety Measures	4-15
4.4.1	Safety Circuit	4-15
4.4.2	Momentary Power Drop	4-15
4.4.3	Alarm Output	4-16
5	Operation	5-1
5.1	Before Powering On	5-2
5.1.1	Check Points	5-2
5.1.2	Procedures before Starting Operation	5-2
5.2	RAM/ROM Operation	5-4
5.2.1	Transmission of the Project	5-4
5.2.2	Operations following Powering On	5-5
5.2.3	Data Hold During Power Failure	5-5
5.2.4	Online Editing	5-6
5.3	Backing Up the Project	5-7
5.3.1	Transmission from the Execution Memory RAM to the Backup Memory ROM2	5-7
5.3.2	Transmission from the Backup Memory ROM2 to the Execution Memory RAM/ROM1	5-8
5.3.3	Operations following Powering On/Off	5-8
5.4	SD Memory Card Operation	5-9
5.4.1	Preparing SD Memory Cards	5-9
5.4.2	How to Insert an SD Memory Card	5-9
5.4.3	Saving an Execution File for SD Memory Card Operation	5-10
5.4.4	Operation by an SD Memory Card	5-11
5.4.5	Transmission from an SD Memory Card to the Execution Memory	5-12
5.4.6	Precautions Concerning SD Memory Card Operation	5-14
5.5	Operation When Using Expansion Master Unit/Slave Unit	5-15
5.5.1	Operation When Power Supply Turns ON/OFF	5-15
5.5.2	Insertion and Removal of Expansion Cable	5-15
6	Troubleshooting	6-1
6.1	Self-diagnosis function	6-2
6.1.1	CPU Unit's Operation Monitor LED	6-2

6.1.2	Operation at the Time of Error	6-2
6.2	What to Do If an Error Occurs.....	6-4
6.2.1	ERROR LED Flashes on the CPU Unit	6-4
6.2.2	PROG Mode Does Not Change to RUN	6-4
6.2.3	ALARM LED Turns ON on the CPU Unit	6-5
6.2.4	POWER LED Does Not Turn ON on the Power Supply Unit	6-5
6.2.5	A Protect Error Message Appears	6-6
6.2.6	If Expected Output Is Not Available	6-6
6.2.7	ERR LED Turns ON on the Expansion Unit.....	6-7
7	Maintenance and Inspection	7-1
7.1	Handling of Backup Battery	7-2
7.1.1	Functions of Backup Battery	7-2
7.1.2	Replacement of Backup Battery	7-2
7.1.3	Lifetime and Replacement Interval of Backup Battery	7-4
7.2	Inspection.....	7-5
8	Rated voltage	8-1
8.1	CPU Unit Specifications.....	8-2
8.1.1	General Specifications	8-2
8.1.2	Performance Specifications	8-4
8.1.3	CPU Unit Communication Specifications	8-6
8.1.4	Operation Memory Area.....	8-8
8.1.5	List of System Relays	8-10
8.1.6	List of System Data Registers.....	8-17
8.1.7	List of Error/Warning Codes	8-24
8.2	Power Supply Unit Specifications	8-31
8.2.1	General Specifications	8-31
8.2.2	Performance Specifications	8-31
8.2.3	Alarm Output Specifications.....	8-32
8.3	Dimensions	8-33
8.3.1	Power Supply Unit	8-33
8.3.2	CPU Unit (CPS4R*/CPS3R*).....	8-34
8.3.3	CPU Unit (CPS2R).....	8-35
8.3.4	Terminal Block Type Unit (1).....	8-35
8.3.5	Terminal Block Type Unit (2).....	8-36
8.3.6	Connector Type Unit	8-37
8.3.7	Serial Communication Unit	8-38
8.3.8	Multi-wire Link Unit.....	8-39
8.3.9	PHLS Master Unit	8-40
8.3.10	End Unit	8-40
8.3.11	Figures of Unit Combination.....	8-41

(MEMO)

1 Overview

1.1 System Configuration.....	1-2
1.1.1 List of Units	1-2
1.2 Restrictions on Combinations of Units	1-4
1.2.1 CPU Unit Type	1-4
1.2.2 Common Restrictions on Each Unit	1-5
1.2.3 Restrictions on the Number of Installed Units	1-5
1.2.4 Restrictions on the Combination of Extension Cassettes	1-5
1.2.5 Restrictions on Communication Functions to be Used	1-6
1.2.6 Unit to be Used and Applicable Versions	1-6
1.3 Restrictions on Using Expansion Unit.....	1-8
1.3.1 Configuration When Using Expansion Unit.....	1-8
1.3.2 Restrictions on Combinations of Units	1-9
1.3.3 Installation Position of Units and Access Time	1-10
1.3.4 Restrictions on Configuration Capacity.....	1-10
1.4 Selection of Power Supply and Restrictions on Combination	1-12
1.4.1 Power Supply for Internal Circuit	1-12
1.4.2 List of Power Supply Unit's Current Consumption for Internal Circuit.....	1-14
1.4.3 Power Supply for External Circuit	1-16
1.5 Programming Tools	1-18

1.1 System Configuration

1.1 System Configuration

1.1.1 List of Units

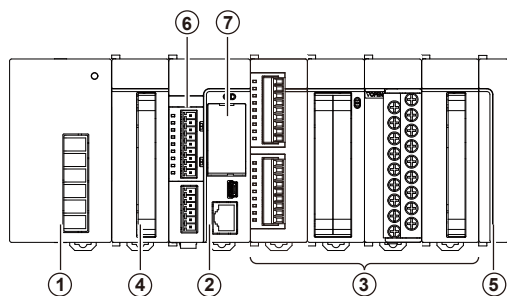

① Power Supply Unit

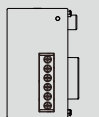

Model number	Remarks
AFP7PSA1	100 to 240V AC, 24W

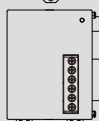

Model number	Remarks
AFP7PSA2	100 to 240V AC, 43W

② CPU Unit



Model number	Remarks
AFP7CPS4RE	196k steps With Ethernet function
AFP7CPS3RE	120k steps With Ethernet function
AFP7CPS4RES	196k steps With Ethernet function With Encryption function
AFP7CPS3RES	120k steps With Ethernet function With Encryption function

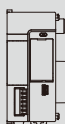

Model number	Remarks
AFP7CPS3R	120k steps Without Ethernet function
AFP7CPS3RS	120k steps Without Ethernet function With Encryption function

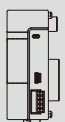

Model number	Remarks
AFP7CPS2R	64k steps Without Ethernet function

③ Digital I/O Units



Model number	Remarks
AFP7X16DW	Input 16-point, 12 to 24VDC
AFP7Y16R	Output 16-point, Relay
AFP7Y16T	Output 16-point, Sink type
AFP7Y16P	Output 16-point, Source type



Model number	Remarks
AFP7X32D2	Input 32-point, 24V DC
AFP7Y32T	Output 32-point, Sink type
AFP7Y32P	Output 32-point, Source type



Model number	Remarks
AFP7X64D2	Input 64-point, 24V DC
AFP7Y64T	Output 64-point, Sink type
AFP7Y64P	Output 64-point, Source type
AFP7XY64D2T	Input 32-point, 24V DC Output 32-point, Sink type
AFP7XY64D2P	Input 32-point, 24V DC Output 32-point, Source type

③ Analog I/O Units



Model number	Remarks
AFP7AD4H	Input 4ch
AFP7AD8	Input 8ch
AFP7DA4H	Output 4ch



Model number	Remarks
AFP7TC8	Thermocouple, Input 8ch
AFP7RTD8	RTD, Input 8ch

③ High-speed Counter Unit



Model number	Remarks
AFP7HSC2T	2ch



Model number	Remarks
AFP7HSC4T	4ch

Note: For information regarding older CPU models, refer to WUME-FP7CPUH-10.

③ Pulse Output Unit

Model number	Remarks
AFP7PG02T	2-axis, Pulse train, 500 kpps Open collector output
AFP7PG02L	2-axis, Pulse train, 4 Mpps Line driver output
品番	Remarks
AFP7PG04T	4-axis, Pulse train, 500 kpps Open collector output
AFP7PG04L	4-axis, Pulse train, 4 Mpps Line driver output

③ Positioning Unit

Model number	Remarks
AFP7PP02T	2-axis, Pulse train, 500 kpps Open collector output
AFP7PP02L	2-axis, Pulse train, 4 Mpps Line driver output
Model number	Remarks
AFP7PP04T	4-axis, Pulse train, 500 kpps Open collector output
AFP7PP04L	4-axis, Pulse train, 4 Mpps Line driver output

③ Serial Communication Unit

Model number	Remarks
AFP7NSCR	Two cassettes can be selected from AFP7CCRS1 , AFP7CCRS2 , AFP7CCRM1 , AFP7CCRM2 , or AFP7CCRS1M1 , and combined.

③ Multi-wire Link Unit

Model number	Remarks
AFP7MW	Unit for connecting the FP7 series to MEWNET-W, MEWNET-W2 or MEWNET-F.

④ Expansion Unit

Model number	Remarks
AFP7EXPM	Master unit
Model number	仕様
AFP7EXPS	Slave unit

⑤ End Unit

Mounted to the right of the last unit
Attached to the CPU Unit/Expansion Slave Unit

⑥ Expansion Unit (Optional)

●Function Cassette

Model number	Remarks
AFP7CCRS1	RS-232C× 1ch
AFP7CCRS2	RS-232C× 2ch
AFP7CCRM1	RS-422/RS-485× 1ch
AFP7CCRM2	RS-422/RS-485× 2ch
AFP7CCRS1M1	RS-232C× 1ch RS-485× 1ch

Model number	Remarks
AFP7CCRET1	Ethernet× 1ch

⑥ Expansion Unit (Optional)

●Function Cassette

Model number	Remarks
AFP7FCRA21	Analog input x 2 channels Analog output x 1channel
AFP7FCRAD2	Analog input x 2 channels
AFP7FCRTC2	Thermocouple input x 2 channels

⑦ CPU Unit mounting options

●Backup battery

Model number	Remarks
AFPX-BATT	Required only when using the calendar timer

●SD memory card

Project backup
SD memory card operation
For storing logging data

(Note 1) For details of expansion cables, refer to "4.3 Wiring of Expansion Cable".

1.2 Restrictions on Combinations of Units

1.2 Restrictions on Combinations of Units

1.2.1 CPU Unit Type

Usable functions and combinations of units are limited according to types of CPU units as follows.

Description		Supported function			
CPU type		CPS4RE	CPS3RE	CPS3R	CPS2R
	Security enhancement type	CPS4RES	CPS3RES	CPS3RS	No corresponding model
Program capacity (step) ^(Note 1)		196k (51k to 234k)	120k (32k to 121k)	120k (32k to 121k)	64k (32k / 64k)
Data register (words) ^(Note 1)		262k (999k to 65k)	131k (589k to 131k)	131k (589k to 131k)	131k (262k / 131k)
	Hold area	Max. 262k	Max. 262k	Max. 262k	Max. 131k
Maximum number of PBs ^(Note 1)		392 (468 to 103)	243 (243 to 64)	243 (243 to 64)	128 (128 / 64)
Ethernet function		Built-in	Built-in	Not available	Not available
SD memory card		Attachable			Not attachable
Logging		Available when SD memory card is mounted.			Not available
Trace		Available			Available
Standard COM port	Terminal block	6P			5P
	COM0 port	On			On
	Terminal block for GT power supply	Either 5 V or 24 V can be used.			Only 5 V
Combination of units	Power Supply Unit	Available			Not available
	Expansion master Expansion slave	Available			Not available
	Other units Extension Cassette	Available			
Battery		Option (for calendar timer)			Not attachable
Calendar timer		Available (when a battery is installed) ^(Note 2)			Available ^(Note 2)
Size of CPU unit alone (Width)		40 mm			34 mm

(Note 1) The program capacity, data registers and maximum number of program blocks (PBs) vary according to the memory configuration settings. The values in the above table are default values, and values in parentheses are fluctuation ranges. Select from each setting patterns; Five for CPS4R*, Four for CPS3R*, Two for CPS2R.

(Note 2) Calendar timer values can continue operation by charging the built-in capacitor from supplied power for 30 minutes or more, even when no battery is used. (For CPS4R*/CPS3R*, approx. one week. For CPS2R, approx. two weeks.)

1.2.2 Common Restrictions on Each Unit

- You can use FP7 series combining the CPU unit with optional input/output units and intelligent units. Up to 16 input/output units and intelligent units can be connected.
- Make sure to connect an end unit to the end of the system.
- You can either connect a power supply unit for system driving power, or directly supply power from an external 24 V DC power supply to the CPU unit. See "[1.4 Selection of Power Supply and Restrictions on Combination](#)" for restrictions on combination.
- For using an SD memory card, it is recommended to select a connector-type unit as a unit installed to the right of the CPU unit in order to prevent interference with the wirings of the unit.

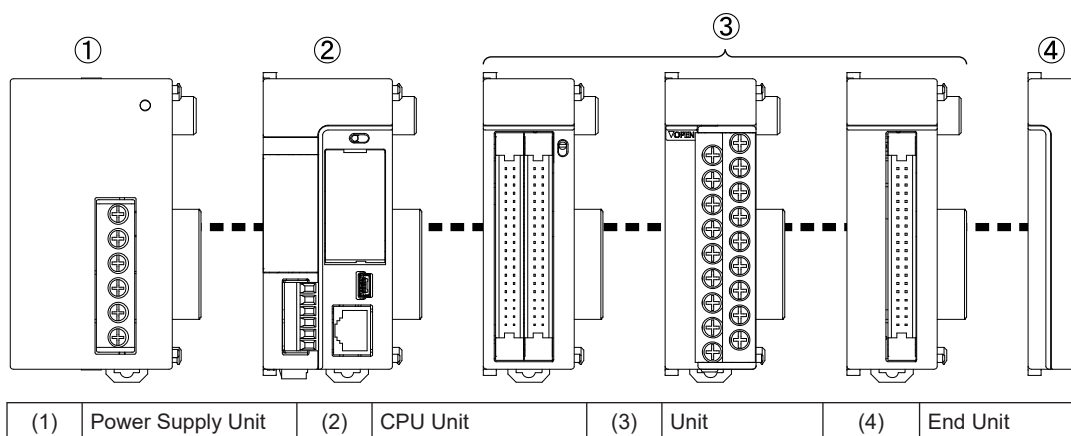

1.2.3 Restrictions on the Number of Installed Units

There are following restrictions depending on units to be used.

Unit Type	Number of installed units	Remarks
Power Supply Unit, CPU Unit	Max. 1 unit	
Serial Communication Unit	Max. 8 units	

1.2.4 Restrictions on the Combination of Extension Cassettes

There are following restrictions depending on units and cassettes to be used.

Unit Type	Number of attachable cassettes	Attachable extension cassettes		
		Communication cassette AFP7CCRS*/AFP7CCRM*	Communication cassette AFP7CCRET1	Function cassette AFP7FCR*
CPU Unit	1 unit	•	•	•
Serial Communication Unit	2 unit Per unit	•	Not attachable	Not attachable

1.2 Restrictions on Combinations of Units

1.2.5 Restrictions on Communication Functions to be Used

There are the following restrictions on functions to be used when using the SCU or ET-LAN that is built in the CPU unit, or the serial communication unit (SCU).

Function to be used	Restrictions
PLC link function	Up to two communication ports can be used. For using two ports, allocate different link areas to them. <ul style="list-style-type: none"> • SCU built-in the CPU unit (COM.1 port) • Serial communication unit (COM.1 port)
MEWTOCOL-COM master MODBUS-RTU master	A maximum of 16 communication ports and the number of connections in combination can be used simultaneously. <ul style="list-style-type: none"> • SCU built-in the CPU unit (COM.1 port to COM. 2 port) • Serial communication unit (COM.1 port to COM.4 port) • ET-LAN built-in the CPU unit (User connections 1 to 16)
MEWTOCOL-COM slave MEWTOCOL7-COM slave MODBUS-RTU slave	A maximum of 15 communication ports and the number of connections in combination can be used simultaneously. <ul style="list-style-type: none"> • SCU built-in the CPU unit (COM.1 port to COM. 2 port) • Serial communication unit (COM.1 port to COM.4 port) • CPU with built-in ET-LAN (System connections 1 to 4 / User connections 1 to 16)
General-purpose communication	There is no restriction.

1.2.6 Unit to be Used and Applicable Versions

For using each unit, the following versions of CPU unit and FPWINGR7 are required.

■ CPU Unit and FPWIN GR7

Unit type		Applicable version		Remarks
		CPU unit	FPWINGR7	
CPU unit	CPS4R*/CPS3R*	Ver.1	Ver. 1.0 or later	
		Ver. 2 or later	Ver. 2.0 or later	
		Ver. 3.0 or later	Ver. 2.4 or later	
		Ver. 3.2 or later	Ver. 2.5 or later	
	CPS2R	Ver. 1.0 or later	Ver. 2.7 or later	

(Note 1) For CPU units (CPS4R*/CPS3R*) that are Ver. 2 or later, the firmware of the CPU units can be upgraded with the"FP7 CPU Unit Upgrade Tool". For details, see our web site.

(Note 2) FPWIN GR7 can be upgraded with the"FPWIN GR7 Difference File". For details, see our web site.

■ Intelligent Unit

Unit type	Applicable version			Remarks
	CPU unit		FPWINGR7	
	CPS4R*/CPS3R*	CPS2R		
FP7 High-speed counter Unit	Ver. 1.2 or later	Ver. 1.0 or later	Ver. 1.2 or later	(Note 1)
FP7 Serial Communication Unit	Ver. 1.2 or later	Ver. 1.0 or later	Ver. 1.3 or later	
FP7 Communication Cassette (Ethernet type)	Ver. 1.3 or later	Ver. 1.0 or later	Ver. 1.0 or later	(Note 2)
FP7 Analog I/O Cassette, Analog Input Cassette, Thermocouple Input Cassette	Ver. 2.0 or later	Ver. 1.0 or later	Ver. 2.0 or later	
FP7 Pulse Output Unit	Ver. 2.0 or later	Ver. 1.0 or later	Ver. 2.0 or later	
Thermocouple Multi-Analog Input Unit Resistance Temperature Detector (RTD) Input Unit	Ver. 2.0 or later	Ver. 1.0 or later	Ver. 2.3 or later	
FP7 Analog Input Unit (AFP7AD8)	Ver. 3.1 or later	Ver. 1.0 or later	Ver. 2.4 or later	
FP7 Expansion Master Unit FP7 Expansion Slave Unit	Ver.3.1 or later	-	Ver.2.4 or later	
Multi-wire Link Unit	Ver.4.4 or later	Ver.1.4 or later	Ver.2.17 or later	

(Note 1) For using the high-speed counter unit and the positioning unit in combination, and for using the interrupt function with the high-speed counter unit, the positioning unit Ver. 1.1 or later is required.

(Note 2) Configurator WD should be Ver. 1.7 or later.

1.3 Restrictions on Using Expansion Unit

1.3 Restrictions on Using Expansion Unit

1.3.1 Configuration When Using Expansion Unit

- In the FP7 series, blocks in which units are combined with the expansion master unit and expansion slave units can be added.
- From 0 to 16 I/O units and intelligent units can be combined in one block.
- Up to three expansion blocks can be connected to one CPU unit.

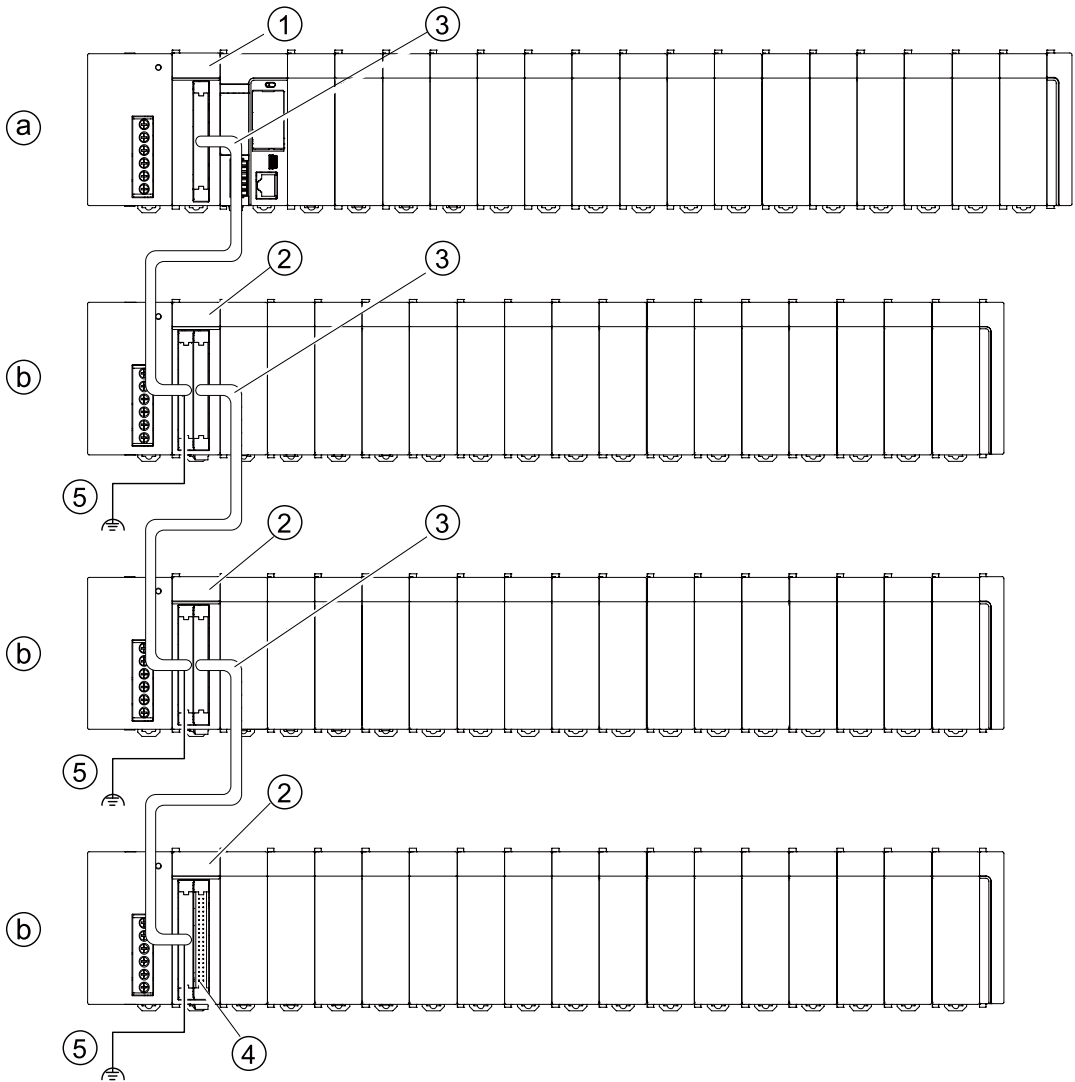

(a)	Base block	(1)	Expansion master unit	(3)	Expansion cable	
(b)	Expansion block	(2)	Expansion Slave Unit	(4)	Dummy connector	(5) Earth wire of expansion cable

1.3.2 Restrictions on Combinations of Units

■ Combinations of base block

- Install the expansion master unit AFP7EXPM on the left-hand side of the CPU unit.
- Install the power supply unit on the left-hand side of the expansion master unit AFP7EXPM as necessary.

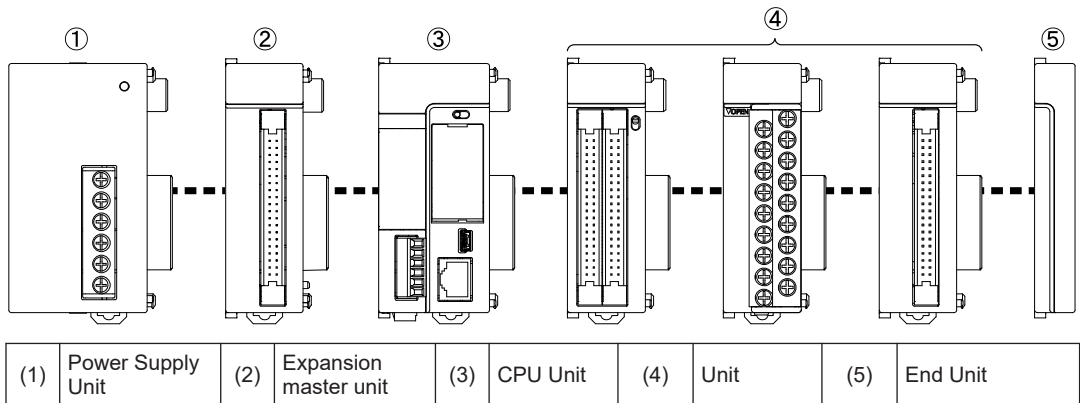

■ Combinations of expansion block

- Install the expansion slave unit AFP7EXPS on the left-hand side of the CPU unit.
- Install the power supply unit on the left-hand side of the expansion master unit AFP7EXPM if used.

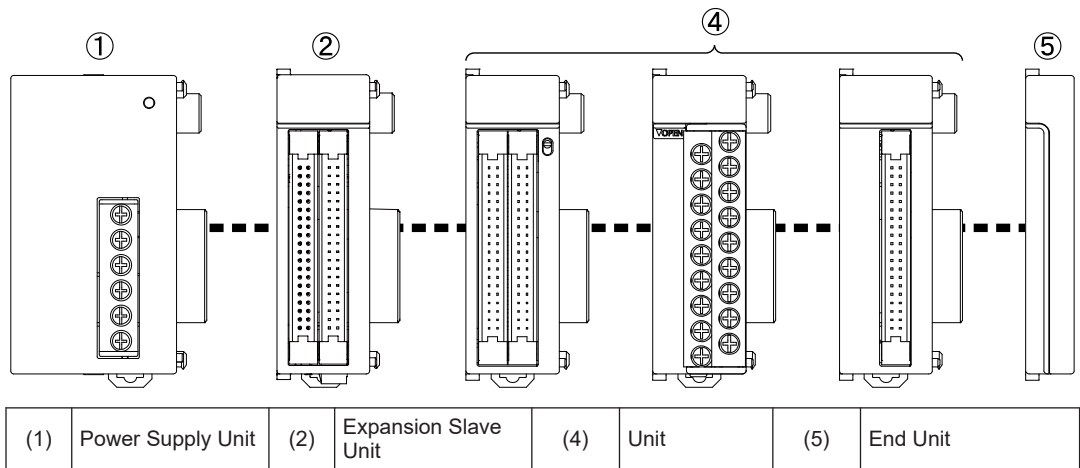

■ Base block and expansion block common restrictions

- Make sure to connect an end unit to the right of the end unit.
- As a power supply for driving the system, you can either connect the power supply unit used at 100 V/230 V AC, or directly supply 24 V DC power to the CPU unit and expansion slave units. For the restrictions on combinations, refer to "1.4 Selection of Power Supply and Restrictions on Combination".

1.3 Restrictions on Using Expansion Unit

1.3.3 Installation Position of Units and Access Time

■ Restrictions on installation position of units

- There is no restriction on the installation position of each unit in FP7 series. However, the access time to the units installed in the expansion block is longer than that to the units installed in the base block as shown in the table below, and it affects the scan time.
- When large-volume data access is assumed with a communication system unit, a unit in which interrupt occurs or user programs, it is recommended to install the target units in the base block. It enables to decrease the scan time relatively.

■ Difference in access time between installation positions of units

Installation position	Access time		Remarks
	Time per word	Ratio to base block	
Base block	0.47 μ s/word	1 time	
Expansion block (Short distance mode)	2.5 μ s/word	5.3 times	The total length of expansion cables is 9 m or less. The LED "SP0" on the expansion master unit turns on.
Expansion block (Long distance mode)	4.1 μ s/word	8.7 times	The total length of expansion cables is 10 m to 30 m. The LED "SP1" on the expansion master unit turns on.

(Note 1) The values in the above table indicate each time the CPU unit accesses the units installed in each block via bus in I/O refresh processing or operation processing. The scan time with operation processing time and base time added can be confirmed in the "status display" dialog box of the tool software.

1.3.4 Restrictions on Configuration Capacity

■ Unit configuration capacity

- If units in which a lot of configuration data are set such as a positioning unit are used in the expansion block a lot, the configuration capacity may exceed the capacity that the CPU unit can handle.
- Check the configuration capacity in the "I/O map setting" dialog box of the tool software in advance.
- The configuration capacity varies according to the functions and settings used in each unit. Also, the maximum registration capacity to be assigned depends on the number of installed expansion units.

i Info.

- The configuration capacity can be checked on the "I/O map setting" dialog box in FPWIN GR7 Ver. 2.4 or later.

I/O map

Select Power Supply Unit/Expansion Unit

Power Supply Unit: 24V DC

Expansion unit: AFP7EXPM (Master Short distance)

Expansion unit startup wait time: 5 Seconds (5 - 1800)

Max. consumption: 3.0 A

Total: 0.6 A

Remaining: 2.4 A

Unit maximum registered capacity: 2.20 MB

Remaining registered capacity: 2.20 MB

Slot N.	Product No.	Unit used	He..	Input	Out..	Ver..	Refre..	Time..	Consu..	Cassette	Programma...
<input type="checkbox"/>	0	AFP7CPS4RES/41ES	FP7 CPU unit	0	10	10	Valid	Valid	200mA	Not registered	Not registere
<input type="checkbox"/>	1	AFP7X64D2	Input unit (DC typ.	10	4	0	Valid	Valid	0	35mA	
<input type="checkbox"/>	2	AFP7Y64T	Output unit (sink t.	14	0	4	Valid	Valid		75mA	
<input type="checkbox"/>	3	AFP7AD4H	Analog input unit (18	8	8	Valid	Valid		100mA	
<input type="checkbox"/>	4	AFP7RTD8	RTD input unit	26	16	8	Valid	Valid		65mA	
<input checked="" type="checkbox"/>	5										
<input type="checkbox"/>	6										
<input type="checkbox"/>	7										
<input type="checkbox"/>	8										
<input type="checkbox"/>	9										
<input type="checkbox"/>	10										
<input type="checkbox"/>	11										
<input type="checkbox"/>	12										
<input type="checkbox"/>	13										
<input type="checkbox"/>	14										
<input type="checkbox"/>	15										
<input type="checkbox"/>	16										

Save Setting Read Setting(O) OK Cancel Read PLC Mount Initialize

1.4 Selection of Power Supply and Restrictions on Combination

1.4 Selection of Power Supply and Restrictions on Combination

1.4.1 Power Supply for Internal Circuit

■ Restrictions on combination of power supply for internal circuit and units

- Power for internal circuit is supplied from a power supply terminal of the power supply unit or the CPU unit, or a power supply terminal of the expansion slave unit.
- Select units within the respective restrictions indicated below.

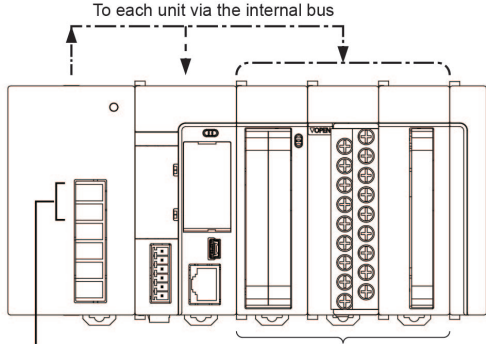
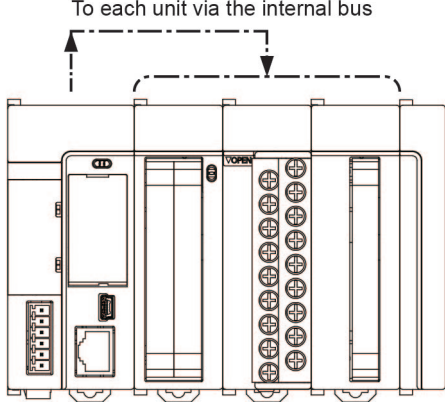
When a power supply unit is used	When no power supply unit is used
 <p data-bbox="153 1000 659 1039">To each unit via the internal bus</p> <p data-bbox="153 1000 659 1039">Supplied from an external power supply 100-240V AC</p> <p data-bbox="450 1000 659 1039">I/O unit High-performance unit</p>	 <p data-bbox="806 595 1112 620">To each unit via the internal bus</p> <p data-bbox="724 1045 1140 1097">Supplied from an external power supply 100-240V AC</p> <p data-bbox="930 1025 1140 1058">I/O unit High-performance unit</p>
<p data-bbox="153 1116 659 1213">Select units so that the sum of internal current consumptions of connected input/output units and intelligent units does not exceed the capacity of the power supply unit.</p>	<p data-bbox="690 1116 1199 1213">Select units so that the sum of internal current consumptions of connected input/output units and intelligent units does not exceed max. 2 A or 3 A. (Note 1)</p>

(Note 1) The allowable current without the power supply unit varies according to the model numbers of CPU unit. Refer to the following pages.

(Note 2) The allowable current of the expansion slave unit without the power supply unit is max. 3 A.

■ Selection of a 24V DC power supply

- Select a power supply larger than the capacity of the unit. In the minimum configuration, select a power supply of 24 W or larger.
- In order to protect the unit against abnormal voltage from the power supply line, the power supply should be an insulated type, and should be enclosed within a protective circuit.
- If using a power supply device without an internal protective circuit, always make sure power is supplied to the unit through a protective element such as a fuse.

1.4 Selection of Power Supply and Restrictions on Combination

■ Allowable current (24 V) of CPU unit when power is directly supplied

Product name		Product no.	Allowable maximum current
CPU Unit	CPS4R*/CPS3R*	AFP7CPS4RE/AFP7CPS3RE/AFP7CPS3R AFP7CPS4RES/AFP7CPS3RES/AFP7CPS3RS	3A ^(Note 1)
	CPS2R	AFP7CPS2R	3A ^(Note 1)
Expansion Slave Unit		AFP7EXPS	3A ^(Note 1)

(Note 1) If the unit is used in an ambient temperature of over 50°C, the consumption current of the unit should be within the following range.

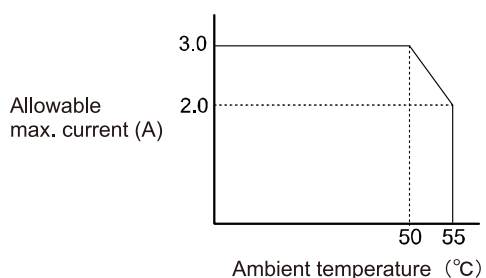

■ Output current of power supply units (24V)

Product name	Product no.	Rated output current
Power Supply Unit	100 to 240V AC, 24W	AFP7PSA1 1A
	100 to 240V AC, 3W	AFP7PSA2 1.8A

Note

- When a power supply unit is used, do not connect a DC power supply to the CPU unit. It is the same for an expansion slave unit.
- A power supply unit and expansion slave units cannot be connected to the CPU unit CPS2R.

1.4 Selection of Power Supply and Restrictions on Combination

i Info.

- The current consumption can be checked on the "I/O map setting" dialog box in FPCWIN GR7 Ver. 2.3 or later.

The screenshot shows the 'I/O map' dialog box. At the top, it displays power supply settings: 'Power Supply Unit: 24V DC', 'Expansion unit: Not used', and 'Expansion unit startup wait time: 5 Seconds (5 - 1800)'. A summary box on the right shows: 'Max. consumption: 3.0 A', 'Total: 1.0 A', and 'Remaining: 2.0 A'. Below this is a table with columns: Slot No., Product No., Unit used, He..., Input, Out..., Ver..., Refr..., Time..., Consu..., Cassette, and Program... The table lists various units like CPU units, I/O units, and cassettes with their respective current consumption values.

Slot No.	Product No.	Unit used	He...	Input	Out...	Ver...	Refr...	Time...	Consu...	Cassette	Program...
<input type="checkbox"/>	0	AFP7CPS4RE/41E	FP7 CPU unit	0	10	10	Valid	Valid	290mA	AFP7CCRS1/CCS1	AIG03MQ03D.
<input type="checkbox"/>	1	AFP7X64D2	Input unit (DC typ.)	10	4	0	Valid	Valid	35mA		
<input type="checkbox"/>	2	AFP7Y64T	Output unit (sink t.)	14	0	4	Valid	Valid	75mA		
<input type="checkbox"/>	3	AFP7AD4H	Analog input unit (18	8	8	Valid	Valid	100mA		
<input type="checkbox"/>	4	AFP7TCS	Thermocouple mul.	26	16	8	Valid	Valid	80mA		
<input type="checkbox"/>	5	AFP7HSC2T	High-speed count.	42	8	4	Valid	Valid	65mA		
<input type="checkbox"/>	6	AFP7PG04L	Pulse output line	50	4	4	Valid	Valid	65mA		
<input type="checkbox"/>	7	AFP7PP04L	Positioning line dri.	54	12	12	Valid	Valid	65mA		
<input type="checkbox"/>	8	AFP7NSCR/NSC	SCU	66	2	2	Valid	Valid	110mA	AFP7CCRM1/CCM1	
<input type="checkbox"/>	9	AFP7PHLSM	PHLS master unit	68	63	63	Valid	Valid	85mA		
<input checked="" type="checkbox"/>	10										
<input type="checkbox"/>	11										
<input type="checkbox"/>	12										
<input type="checkbox"/>	13										
<input type="checkbox"/>	14										
<input type="checkbox"/>	15										
<input type="checkbox"/>	16										

1.4.2 List of Power Supply Unit's Current Consumption for Internal Circuit

■ Unit's current consumption table (24V)

Product name		Product no.	Current consumption (mA)
CPU Unit	196k steps, Built-in Ethernet function	AFP7CPS4RE AFP7CPS4RES	200 mA or less
	120k steps, Built-in Ethernet function	AFP7CPS3RE AFP7CPS3RES	200 mA or less
	120k steps, No Ethernet function	AFP7CPS3 AFP7CPS3R AFP7CPS3RS	200 mA or less
	64k steps, No Ethernet function	AFP7CPS2R	150 mA or less
Extension Cassette (Communication Cassette) (Note 1)(Note 2) When attached to a CPU unit	RS-232C x 1ch	AFP7CCRS1	35 mA or less
	RS-232C x 2ch	AFP7CCRS2	60 mA or less
	RS-422 / 485 x 1ch	AFP7CCRM1	60 mA or less
	RS-422 / 485 x 2h	AFP7CCRM2	90 mA or less
	RS-232C x 1ch RS-485 x 1ch	AFP7CCRS1M1	70 mA or less

1.4 Selection of Power Supply and Restrictions on Combination

Product name		Product no.	Current consumption (mA)	
	Ethernet	AFP7CCRET1	35 mA or less	
	Extension Cassette (Function Cassette)	Analog I/O cassette	AFP7FCRA21	75 mA or less
		Analog input cassette	AFP7FCRAD2	40 mA or less
		Thermocouple input cassette	AFP7FCRTC2	45 mA or less
Input Unit	DC Input	16-point terminal block, 5 to 24 V DC	AFP7X16DW	25 mA or less
		32-point MIL connector, 24 V DC	AFP7X32D2	30 mA or less
		64-point MIL connector, 24 V DC	AFP7X64D2	35 mA or less
Output Unit	Relay Output	16-point terminal block	AFP7Y16R	180 mA or less
	Transistor Output	16-point terminal block, sink type	AFP7Y16T	35 mA or less
		32-point MIL connector, sink type	AFP7Y32T	50 mA or less
		64-point MIL connector, sink type	AFP7Y64T	75 mA or less
		16-point terminal block, source type	AFP7Y16P	35 mA or less
		32-point MIL connector, source type	AFP7Y32P	50 mA or less
64-point MIL connector, source type	AFP7Y64P	75 mA or less		
I/O Mixed Unit	Input: 32 points/Output: 32 points MIL connector, sink type		AFP7XY64D2T	55 mA or less
	Input: 32 points/Output: 32 points MIL connector, source type		AFP7XY64D2P	55 mA or less
Analog Input Unit	4ch		AFP7AD4H	100 mA or less
	8ch		AFP7AD8	85 mA or less
Analog Output Unit	4ch		AFP7DA4H	250 mA or less
Thermocouple Multi-Analog Input Unit			AFP7TC8	80 mA or less
Resistance Temperature Detector (RTD) Input Unit			AFP7RTD8	65 mA or less
High-speed Counter Unit	2-ch type		AFP7HSC2T	65 mA or less
	4-ch type		AFP7HSC4T	65 mA or less
Pulse Output Unit	2-axis, open collector output		AFP7PG02T	65 mA or less
	4-axis, open collector output		AFP7PG04T	65 mA or less
	2-axis, line driver output		AFP7PG02L	65 mA or less
	4-axis, line driver output		AFP7PG04L	65 mA or less
Positioning Unit	2-axis, open collector output		AFP7PP02T	120 mA or less
	4-axis, open collector output		AFP7PP04T	120 mA or less
	2-axis, line driver output		AFP7PP02L	120 mA or less
	4-axis, line driver output		AFP7PP04L	120 mA or less
Serial Communication Unit			AFP7NSCR	50 mA or less
Multi-wire Link Unit			AFP7MW	100 mA or less
	Extension Cassette	RS-232C x 1ch	AFP7CCRS1	20 mA or less
		RS-232C x 2ch	AFP7CCRS2	40 mA or less

1.4 Selection of Power Supply and Restrictions on Combination

Product name		Product no.	Current consumption (mA)
(Communication Cassette) (Note 1)(Note 2) When attaching to Serial Communication Unit	RS-422 / 485 x 1ch	AFP7CCRM1	30 mA or less
	RS-422 / 485 x 2h	AFP7CCRM2	60 mA or less
	RS-232C x 1ch RS-485 x 1ch	AFP7CCRS1M1	50 mA or less
PHLS Master Unit		AFP7RMTM	85 mA or less
Programmable display GT series (5V DC type)(Note 3)		-	100 mA or less
Expansion Master Unit(Note 4)		AFP7EXPM	120 mA or less
Expansion Slave Unit(Note 4)		AFP7EXPS	100 mA or less

(Note 1) The current consumption listed under Extension Cassette indicates the increased amount of the CPU's current consumption when each extension cassette is added.

(Note 2) The current consumption of the extension cassette (communication cassette) varies according to the unit to which the cassette is attached (CPU or serial communication unit).

(Note 3) The current consumption indicated under Display indicates the increased amount of the CPU's current consumption following connection of a GT series display (5V power supply type) to the GT power supply terminal of the CPU unit. For GT series displays (24V power supply type), please see their respective hardware specifications.

(Note 4) The current consumption of the expansion master unit and the expansion slave unit fluctuates depending on the expansion cable used.

1.4.3 Power Supply for External Circuit

The 24 VDC power supply used as the input power supply of the input units and the output circuit driving power of the output units are supplied from the external terminal of each unit.

■ Unit's current consumption table (24V)

Product name		Model name	Current consumption (mA)	
Input unit(Note 1)	DC input	16-point terminal block, 5 to 24 V DC	AFP7X16DW	6 mA per point
		32-point MIL connector, 24V DC	AFP7X32D2	2.7 mA per point
		64-point MIL connector, 24V DC	AFP7X64D2	2.7 mA per point
Output unit	Relay output	16-point terminal block	AFP7Y16R	-
		Transistor output	16-point terminal block, sink type	AFP7Y16T
	32-point MIL connector, sink type		AFP7Y32T	110 mA or less
	64-point MIL connector, sink type		AFP7Y64T	140 mA or less
	Transistor output	16-point terminal block, source type	AFP7Y16P	70 mA or less
32-point MIL connector, source type		AFP7Y32P	130 mA or less	

1.4 Selection of Power Supply and Restrictions on Combination

Product name		Model name	Current consumption (mA)
	64-point MIL connector, source type	AFP7Y64P	180 mA or less
I/O Mixed Unit	Input 32-point / output 32-point MIL connector, sink type	AFP7XY64D2T	Input 2.7 mA per point Output 70 mA
	Input 32-point / output 32-point MIL connector, source type	AFP7XY64D2P	Input 3.4 mA per point Output 90 mA

(Note 1) Figures for input unit indicate current that flows into the internal circuit. Figures for other units indicate current values required for driving the internal circuit. This value does not include the load current of the output unit.

(Note 2) For current consumption of a 24 V power supply used for the I/O circuits of high-speed counter unit, pulse output unit and positioning unit, please see the User's Manual of each unit.

1.5 Programming Tools

■ Required tools

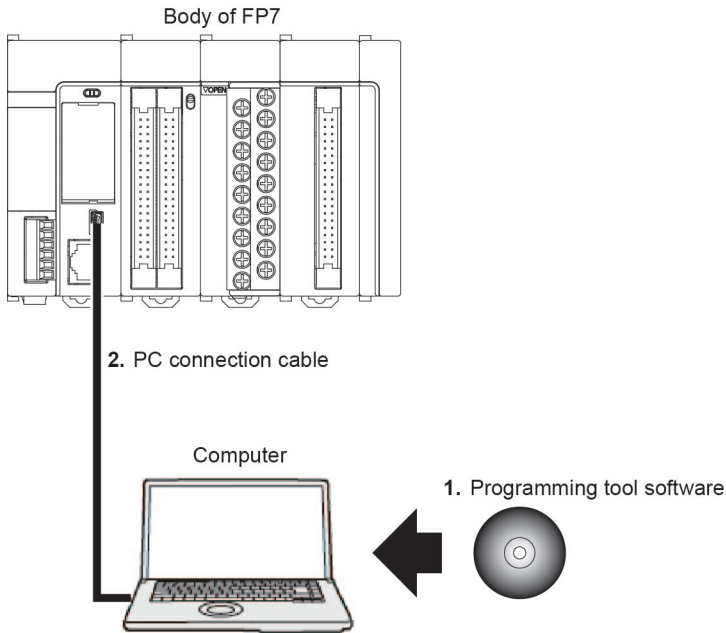

1. Tool software FPWIN GR7

- Dedicated to the FP7 series
- Used for program editing, debugging and documentation.

2. PC connection cable

- Use a commercial cable.

Cable type	Length
USB 2.0 cable (A:miniB)	Max. 5 m

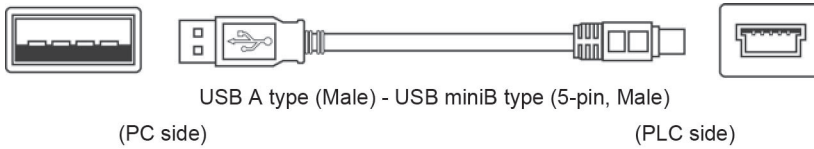

2 Names and functions of parts

2.1 CPU Unit (CPS4R*/CPS3R*).....	2-2
2.2 CPU Unit (CPS2R).....	2-5
2.3 Power Supply Unit	2-7
2.4 Expansion Master Unit / Expansion Slave Unit	2-8

2.1 CPU Unit (CPS4R*/CPS3R*)

2.1 CPU Unit (CPS4R*/CPS3R*)

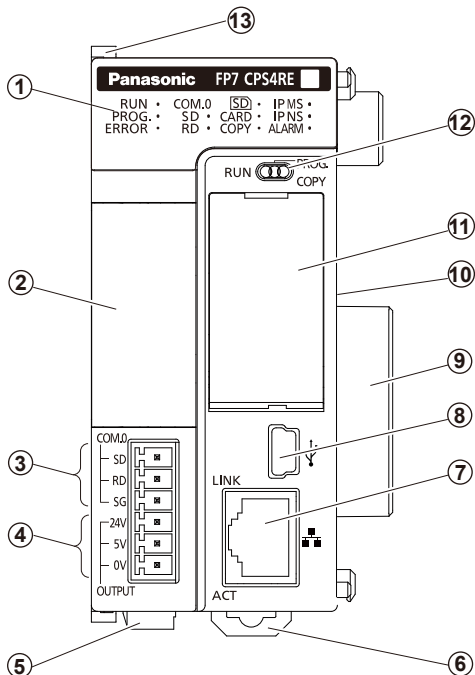

CPS4RE/CPS3RE/CPS3R
CPS4RES/CPS3RES/CPS3RS

■ Names and functions of parts

(1) Operation monitor LED

LED name	LED color	Data to Display
-	Blue	Lit when the CPU unit is turned ON.
RUN	Green	Lit when the CPU unit is in RUN mode. Lit when the forced /O function is executed.
PROG.	Green	Lit when the CPU unit is in PROG mode.
COM.0	SD	Lit when data is sent from the COM0 port.
	RD	Lit when data is received from the COM0 port.
SD	Green	Flashes while accessing an SD memory card. Also flashes while logging data into the unit memory with the logging function.
CARD	Green	Turns on while operation by the SD memory card is selected.
COPY	Green	Lit when copying data.
ERROR	Red	Flashes when an error is detected by self-diagnosis.
ALARM	Red	This lights if a hardware error occurs, or operation slows because of the program, and the watchdog timer is activated.

(Note 1) The layout of the operation monitor LEDs in Ver.1 of the CPU unit is different from that in Ver.2 or later.

(2) Extension cassette (optional)

Attach an optional extension cassette (communication cassette or function cassette).

(3) COM0 port terminal

Three-wire RS-232C port.

(4) GT power supply terminal

For our programmable display "GT series", either 5V DC output or 24V DC output can be used.

(3)(4) Terminal layout

- AFP7CPS4R*
- AFP7CPS3R*

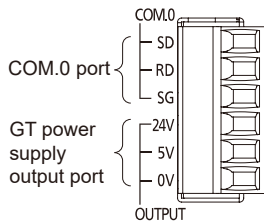

(Note 1) Each terminal of the COM.0 port is insulated from the internal circuit. The SG terminal (COM.0 port) and the 0V terminal (GT power supply output) are also insulated from each other.

Power supply connector

Used for connecting to an external power supply (24 V DC). When a power supply unit is used, do not connect this.

(6) DIN hook

Used for fixing the unit on the DIN rail.

(7) LAN port (CPS4RE, CPS4RES, CPS3RE, CPS3RES)

Port for connection to Ethernet LAN

(8) USB port

Used for connecting with a PC on which tool software is used.

(9) Unit connector

Used for connecting an I/O unit or intelligent unit. An end unit is fitted when the unit is shipped.

(10) Dip switch (CPS4RE, CPS4RES)

Do not change the setting. The switches are all set to OFF at the factory.

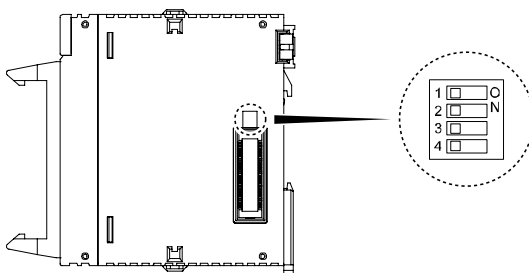

(11) Card cover

2.1 CPU Unit (CPS4R*/CPS3R*)

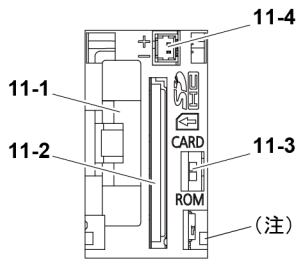

Number	Name	Functions
11-1	Battery holder	Attach a battery.
11-2	SD memory card slot	Insert an SD memory card.
11-3	Card operation switch	Select between ROM operation or SD operation. By selecting SD operation, provisional operation from the SD memory card becomes possible.
11-4	Power supply connector	Connect to a power supply connector

(Note 1) Do not apply an excessive force to the card cover when opening or closing it or when the cover is left open. Otherwise, the cover attachment part will be deformed to cause malfunction in the cover recognition switch mounted inside the product.

(12) Mode switch

Switch position	Operation mode
RUN (left)	Sets to RUN mode. The program is executed and operation begins.
PROG. (middle)	Sets to PROG mode.
COPY (right, momentary)	When the switch is set to COPY, a project stored in the internal RAM / ROM1 is transmitted to ROM2 as a backup project.

(Note 1) Whether the switch is set to RUN or PROG., the mode can be switched through remote operation from the tool software. When power is turned on again, it operates in the mode set on the switch.

(13) Fixing hook

Used for fixing a power supply unit to the CPU unit.

2.2 CPU Unit (CPS2R)

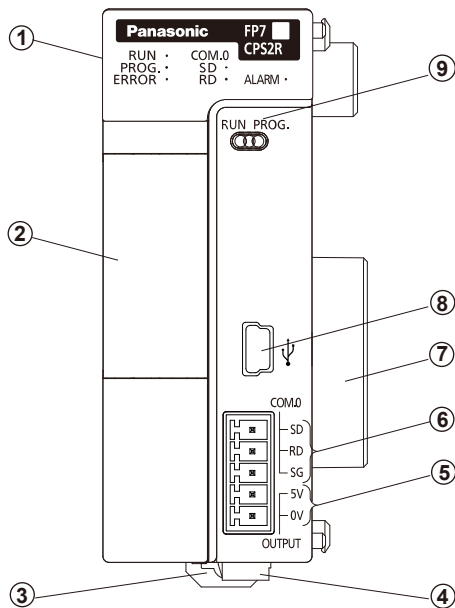

CPS2R

■ Names and functions of parts

(1) Operation monitor LED

LED name	LED color	Data to Display
-	Blue	Lit when the CPU unit is turned ON.
RUN	Green	Lit when the CPU unit is in RUN mode. Lit when the forced /O function is executed.
PROG.	Green	Lit when the CPU unit is in PROG mode.
ERROR	Red	Flashes when an error is detected by self-diagnosis.
COM.0	SD	Lit when data is sent from the COM0 port.
	RD	Lit when data is received from the COM0 port.
COPY	Green	Lit when copying data.
ALARM	Red	This lights if a hardware error occurs, or operation slows because of the program, and the watchdog timer is activated.

(2) Extension cassette (optional)

Attach an optional extension cassette (communication cassette or function cassette).

(3) DIN hook

Used for fixing the unit on the DIN rail.

(4) Power supply connector

Used for connecting to an external power supply (24 V DC).

(5) GT power supply terminal

For our programming display "GT series", 5V DC output can be used.

2.2 CPU Unit (CPS2R)

(6) COM0 port terminal

Three-wire RS-232C port.

(5) (6) Terminal layout

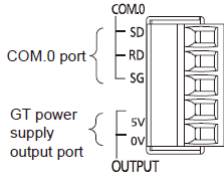

(Note 1) Each terminal of the COM.0 port is insulated from the internal circuit. The SG terminal (COM.0 port) and the 0V terminal (GT power supply output) are also insulated from each other.

(7) Unit connector

Used for connecting an I/O unit or intelligent unit. An end unit is fitted when the unit is shipped.

(8) USB port

Used for connecting with a PC on which tool software is used.

(9) Mode switch

Switch position	Operation mode
RUN (left)	Sets to RUN mode. The program is executed and operation begins.
PROG. (right)	Sets to PROG mode.

(Note 1) Whether the switch is set to RUN or PROG., the mode can be switched through remote operation from the tool software. When power is turned on again, it operates in the mode set on the switch.

2.3 Power Supply Unit

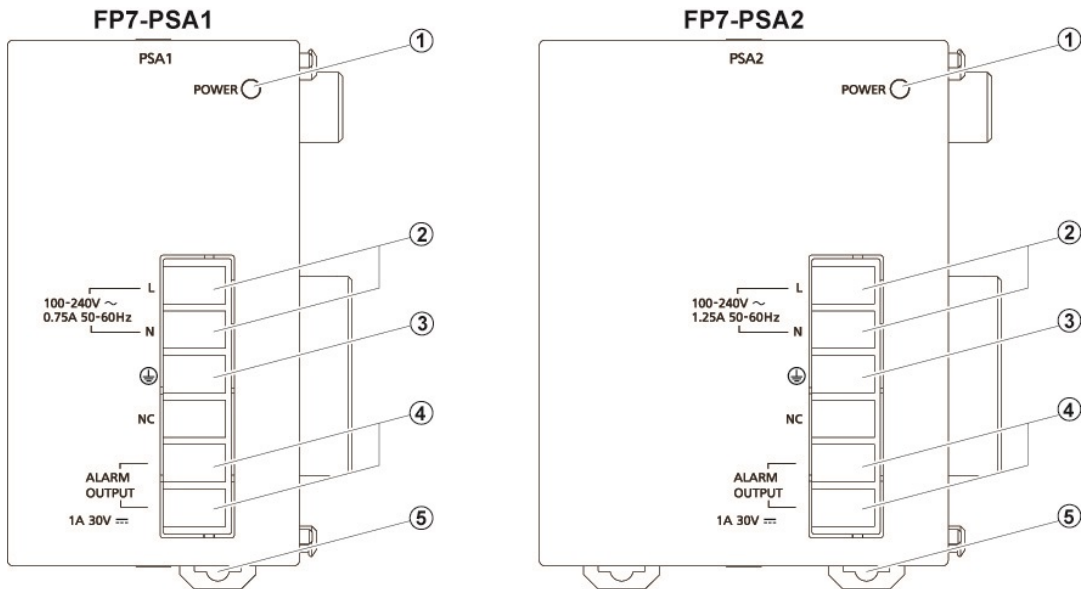

■ Names and functions of parts

(1) POWER LED (blue)

Turns on when power supply is turned on.

(2) Power supply terminals

Terminal block for power supply wiring. A solderless terminal for M3 can be used.

(3) Earth terminals

The unit should be grounded at a grounding resistance of 100 Ω or less to prevent noise and electric shock.

(4) Alarm contact output terminal

Closed when power supply is ON. If the watchdog timer is operated due to a hardware error or a program error, turning the relay contact into an open status.

(5) DIN rail attachment lever

Used for fixing the unit on the DIN rail.

2.4 Expansion Master Unit / Expansion Slave Unit

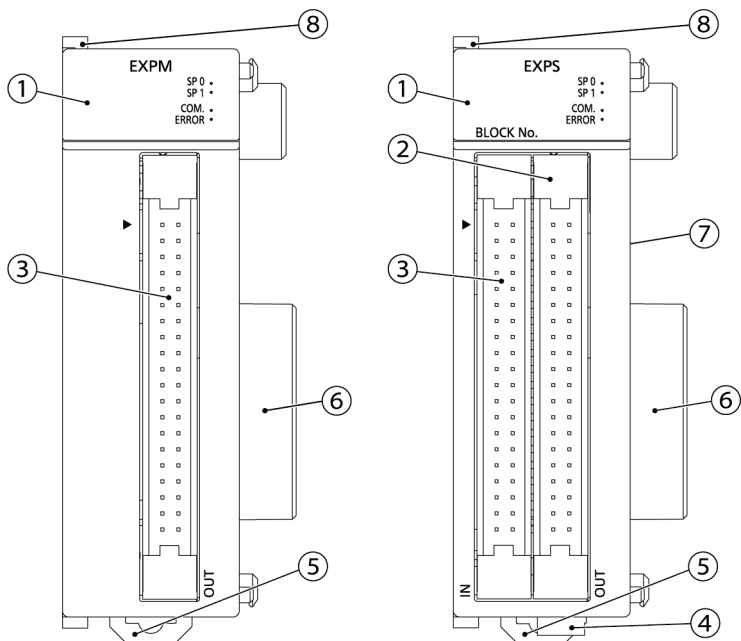

■ Names and functions of parts

(1) Operation monitor LED

LED name	LED color	Data to Display
SP0	Green	Turns on when the total length of standard expansion cables for combined units is 9 m or less.
SP1	Green	Turns on when the total length of standard expansion cables for combined units is 10 m or more.
COM.	Green	Blinks while communication between the expansion master unit and slave units is performed.
ERROR	Red	Turns on when an error occurs in the expansion system. <ul style="list-style-type: none"> • Error in communication between the expansion master unit and slave units (such as communication cable unconnection or disconnection). • Power supply error in expansion block • Error in the I/O unit or intelligent unit installed in the expansion block. • The end unit in the expansion block is not installed.
BLOCK No.	Green	(For the expansion master unit) The displayed L-shaped LED rotates during the initialization processing between the expansion master unit and the expansion slave unit. It turns off on the completion of the initialization.
		(For the expansion slave unit) The connected position numbers 1 to 3 of expansion block are displayed with the LED. A 4x5 dot LED is used. When an error occurs in the initialization processing or the connection of expansion block, "0" is displayed.

(2) OUT connector

2.4 Expansion Master Unit / Expansion Slave Unit

Used for connecting to the IN connector of the expansion slave unit in the next block with an exclusive expansion cable.

(3) IN connector

Used for connecting to the OUT connector of the expansion slave unit in the previous block with an exclusive expansion cable.

(4) Power supply connector (AFP7EXPS only)

Used for connecting to an external power supply (24 V DC). When a power supply unit is used, do not connect this.

(5) DIN hook

Used for fixing the unit on the DIN rail.

(6) Unit connector

Used for connecting the internal circuit of an I/O unit or intelligent unit. The end unit is attached with shipment.

(7) Dip switch

Do not change the setting. The switches are all set to OFF at the factory.

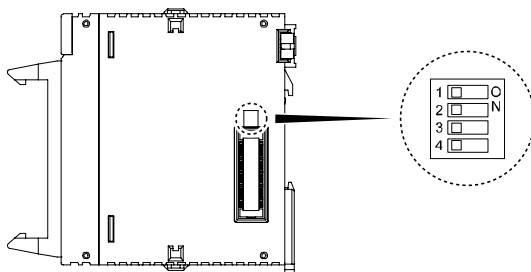

(8) Fixing hook

Used for fixing a power supply unit

(MEMO)

3 I/O Number Allocation

3.1 Basics of I/O Allocation	3-2
3.1.1 How to Count the I/O Numbers	3-2
3.1.2 Concept of I/O Number Allocation	3-2
3.1.3 List of Occupied I/O Points for Each Unit.....	3-3
3.2 Optional Allocation Using FPWIN GR7	3-6
3.2.1 Registration of a Unit to be Used and the Starting Word Number ...	3-6
3.2.2 Optional Settings in the “Unit Selection” Dialog Box.....	3-8
3.2.3 Settings When Using Expansion Unit	3-8
3.3 Mount Allocation Using FPWIN GR7	3-10
3.3.1 Mount Registration of a Unit to be Used and the Starting Word Number	3-10
3.3.2 Changing the Starting Word Number	3-10
3.4 I/O Map Registration	3-12
3.4.1 I/O Map Registration	3-12
3.4.2 I/O Map Clearance.....	3-12

3.1 Basics of I/O Allocation

3.1 Basics of I/O Allocation

3.1.1 How to Count the I/O Numbers

■ Counting and expression of the I/O numbers

Since I/O numbers are handled in units of 16 points, they are expressed as a combination of a device type code and the lowest-digit of a decimal or hexadecimal number.

E.g. In the case of an external input, X0 to X9 and XA to XF are used.



3.1.2 Concept of I/O Number Allocation

■ Examples of I/O Number Allocation

I/O numbers are determined by the status of unit attachment and the occupied I/O points allocated to respective units.

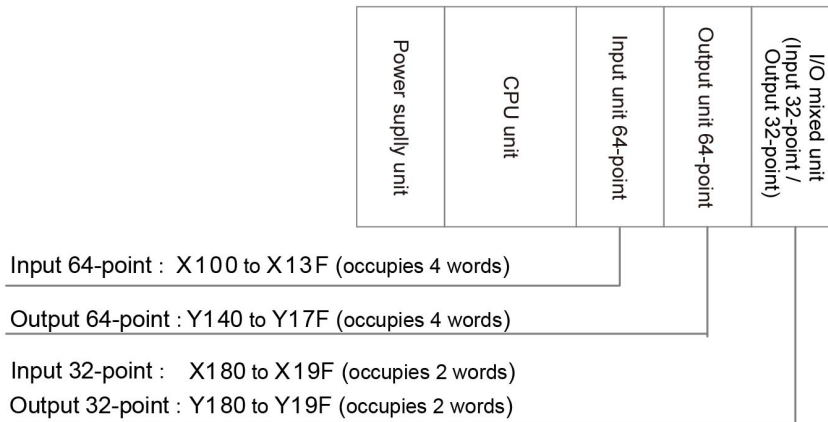

■ Starting word numbers of input/output units and intelligent units

- By default, the starting word number for the unit attached next to the CPU unit is set at "10", and the I/O numbers start with X100 or Y100.
- The starting word number for each unit can be freely changed in the "FP7 Configuration" menu of the tool software FPWIN GR7.

■ How to count I/O numbers for units that have both inputs and outputs

In the case of a unit that has both inputs and outputs (e.g. mixed input/output units, intelligent units), input numbers and output numbers start with the same value.

E.g. If input numbers for a mixed input/output unit are X100 to X11F, the unit's output numbers are set at Y100 to Y11F.

■ I/O numbers allocated to the CPU unit

A fixed area is allocated to the COM port and the ET-LAN port.

i Info.

- When the number of occupied input words is different from the number of occupied output words, the larger number is allocated to the unit.
- For using the user connections 17 to 216 by extending the number of user connections with the built-in ET-LAN in the CPU unit, 26-word area (WX11 to WX36/WY11 to WY36) is used as a flag for confirming the communication instruction SEND/RECV. Change the starting number of the CPU unit or another unit not to overlap I/O maps.
- The starting numbers of I/O contacts of each unit including the CPU unit can be changed by the setting of tool software.

3.1.3 List of Occupied I/O Points for Each Unit

■ CPU Unit

Unit Type		Model No. or Function	Occupied words (occupied I/O points)	
			Input	Output
CPU Unit	SCU built-in CPU Unit	Common	2 words (32 points) WX0 to WX1	2 words (32 points) WY0 to WY1
	Communication cassette (Ethernet type)	AFP7CCRET1	4 words (64 points) WX0 to WX3	2 words (32 points) WY0 to WY1
	Analog I/O Cassette	AFP7FCRA21	2 words (32 points) WX2 to WX3	1 words (16 points) WY2
	Analog Input Cassette	AFP7FCRAD2		—
	Thermocouple Cassette	AFP7FCRTC2		—
	System reserved area	Common	WX4 to WX5	WY4 to WY5
	CPU Unit Built-in ET-LAN	ET-LAN common occupied area		WX6
User connections 1 to 16			3 words (48 points) WX7 to WX9	3 words (48 points) WY7 to WY9

(Note 1) Input/output contacts of the CPU unit are allocated for using the functions of each cassette. Regardless of use of such functions, input occupies 10 words (160 points, WX0 to WX9) and output occupies 10 words (160 points, WY0 to WY9).

(Note 2) The starting numbers of I/O contacts of each unit including the CPU unit can be changed by the setting of tool software.

■ CPU unit (Built-in ET-LAN extended connection)

Unit Type		Model No. or Function	Occupied words (occupied I/O points)	
			Input	Output
CPU Unit	CPU Unit Built-in ET-LAN	User connections 1 to 16	WX7 to WX9	WY7 to WY9

3.1 Basics of I/O Allocation

Unit Type		Model No. or Function		Occupied words (occupied I/O points)	
				Input	Output
		User connection	17 to 32	WX11	WY11 to WY12
			33 to 48	WX13	WY13 to WY14
			49 to 64	WX15	WY15 to WY16
			65 to 80	WX17	WY17 to WY18
			81 to 96	WX19	WY19 to WY20
			97 to 112	WX21	WY21 to WY22
			113 to 128	WX23	WY23 to WY24
			129 to 144	WX25	WY25 to WY26
			145 to 160	WX27	WY27 to WY28
			161 to 176	WX29	WY29 to WY30
			177 to 192	WX31	WY31 to WY32
			193 to 208	WX33	WY33 to WY34
209 to 216	WX35	WY35 to WY36			

- (Note 1) For using the user connections 17 to 216 by extending the number of user connections with the built-in ET-LAN in the CPU unit, the above areas are used as flags confirming the transmission of the communication instruction SEND/RECV. Change the starting number of the CPU unit or another unit not to overlap I/O maps.
- (Note 2) The area for user connections 1 to 16 occupies four words including flags for general-purpose communication.
- (Note 3) Occupied area in the area of user connections 17 to 216 varies according to the number of used connections.
- (Note 4) The starting numbers of I/O contacts of each unit including the CPU unit can be changed by the setting of tool software.

■ I/O Unit

Unit Type		Product no.	Occupied words (occupied I/O points)	
			Input	Output
I/O Unit	Input unit 16 points	AFP7X16DW	1 words (16 points)	—
	Input unit 32 points	AFP7X32D2	2 words (32 points)	—
	Input unit 64 points	AFP7X64D2	4 words (64 points)	—
	Output unit 16 points	AFP7Y16R, AFP7Y16T AFP7Y16P	—	1 words (16 points)
	Output unit 32 points	AFP7Y32T, AFP7Y32P	—	2 words (32 points)
	Output unit 64 points	AFP7Y64T, AFP7Y64P	—	4 words (64 points)
	I/O Mixed Unit Input: 32 points/Output: 32 points	AFP7XY64D2T AFP7XY64D2P	2 words (32 points)	2 words (32 points)

■ Intelligent Unit

Unit Type		Product no.	Occupied words (occupied I/O points)	
			Input	Output
Intelligent Unit	Analog Input Unit	AFP7AD4H	8 words (128 points)	4 words (64 points)
		AFP7AD8	16 words (256 points)	8 words (128 points)
	Analog Output Unit	AFP7DA4H	4 words (64 points)	8 words (128 points)
	Thermocouple multi-analog input unit	AFP7TC8	16 words (256 points)	8 words (128 points)
	RTD input unit	AFP7RTD8	16 words (256 points)	8 words (128 points)
	High-speed Counter Unit	AFP7HSC2T, AFP7HSC4T	8 words (128 points)	4 words (64 point)
	Pulse Output Unit	AFP7PG02T, AFP7PG02L	2 words (32 points)	2 words (32 points)
		AFP7PG04T, AFP7PG04L	4 words (64 points)	4 words (64 points)
	Positioning Unit	AFP7PP02T, AFP7PP02L AFP7PP04T, AFP7PP04L	12 words (196 points)	12 words (196 points)
	Serial Communication Unit	AFP7NSCR	2 words (32 points)	2 words (32 points)
	Multi-wire Link Unit ^(Note 1)	AFP7MW	W mode: 1 input word and 1 output word (fixed) W2 mode: 1 input word and 1 output word (fixed) F mode: 256 input words and 256 output words (maximum)	
PHLS Master Unit ^(Note 2)	AFP7PHLSM	63 words (1,008 points)	63 words (1,008 points)	

(Note 1) The number of allocated points varies depending on the number of input/output points allocated to the remote I/O part.

(Note 2) As for the PHLS master unit, input occupies 63 words (1,008 points) and output occupies 63 words (1,008 points). The actual input/output points that can be used vary by the number of slave units that are connected, with the maximum of 1,008 points.

(Note 3) The starting numbers of I/O contacts of each unit including the CPU unit can be changed by the setting of tool software.

3.2 Optional Allocation Using FPWIN GR7

3.2 Optional Allocation Using FPWIN GR7

3.2.1 Registration of a Unit to be Used and the Starting Word Number

■ Allocation method

The unit to be used and the starting I/O number are set in the following procedure.

1 2 Procedure

1. Select **Options>FP7 Configuration>I/O map setting** in the menu bar.
The "I/O map setting" dialog box will be displayed.

The "I/O map" dialog box contains the following elements:

- Left Panel:** A list of expansion units: Base (selected), Expansion 1 (Not used), Expansion 2 (Not used), and Expansion 3 (Not used).
- Configuration Fields:**
 - Select Power Supply Unit/Expansion Unit: 24V DC
 - Expansion unit: Not used
 - Expansion unit startup wait time: 5 Seconds (5 - 1800)
- Max. consumption Summary:**

Max. consumption	3.0 A	Unit maximum registered capacity:	0.00 MB
Total	0.0 A	Remaining registered capacity:	0.00 MB
Remaining	3.0 A		
- Table:** A table with columns: Slot No., Product No., Unit used, Head, Input, Outp..., Veri..., Refresh, Time ..., Consum..., Cassette, Programmabl... The table has 17 rows, with Slot No. 0 to 16. Each row has a checkbox on the left.
- Buttons:** Save Setting, Read Setting(O), OK, Cancel, Read PLC, Mount, Initialize, Relocation, Advanced, Up, Down.

2. Select and double-click Slot No. 0.
The "unit selection" dialog box will be displayed.

Unit selection [Slot No. 0]

Select unit to use _____

Unit type: CPU unit

Unit name: FP7 CPU unit

Input time constant: 0

Installation location setting _____

Starting word No. 0 (0 - 502)

Number of input words: 10 (0 - 128)

Number of output words: 10 (0 - 128)

Option _____

Exclude this unit from the target for verification.

Exclude this unit from the target for I/O refresh.

3. Confirm the installation position setting, and press the [OK] button.
The CPU unit is registered in the I/O map. If the CPU unit is different, select **Tool>Convert PLC Type** from the menu bar and change the type.
4. Select and double-click Slot No. 1.
The "unit selection" dialog box will be displayed.

Unit selection [Slot No. 1]

Select unit to use _____

Unit type: -

Unit name: -

Input time constant: 0

Installation location setting _____

Starting word No. 10 (0 - 511)

Number of input words: 0 (0 - 128)

Number of output words: 0 (0 - 128)

Option _____

Exclude this unit from the target for verification.

Exclude this unit from the target for I/O refresh.

5. In the unit type field, select a unit to be attached.
Subsequently, input words and output words are automatically entered.
6. As necessary, enter the starting word number and press the [OK] button.

3.2 Optional Allocation Using FPCWIN GR7

The registered unit and the starting word number are included in the I/O map. A number that combines the starting word number registered for each unit and 0 to F becomes the starting I/O number.

7. Repeat registrations.
8. Press the [OK] button while the "FP7 configuration" dialog box is displayed.

Info.

- The I/O map registered using FPCWIN GR7 is downloaded into the CPU unit, together with other project information. If a difference with the actual units and/or attachment status is identified when power supply is turned on or during operation, such a difference is reported as a self-diagnosis error.
- If a starting word number is not entered, the system automatically enters one.
- Based on the starting word number allocated to each unit, I/O numbers are allocated.
- The starting number of I/O numbers allocated to the internal functions of the CPU unit can be changed to another number from the word number 0.

3.2.2 Optional Settings in the "Unit Selection" Dialog Box

■ Input time constants

- Input time constants for an input unit or a mixed input/output unit can be changed as necessary. Select, and set for each unit, a desirable value from "No settings", 0.1, 0.5, 1.0, 5.0, 10.0, 20.0 or 70.0 ms. The selected time constants are added to the hardware-specific response time of each unit.
- For details, please see the *FP7 Digital Input/Output Unit Users Manual*.

■ Exclude this unit from the scope of verification.

- In general, this check box should be turned off.
- If you want to exclude this unit from the scope of verification error temporarily for unit replacement or adjustment, turn on this check box.

■ Exclude this unit from the scope of I/O refresh.

- In general, this check box should be turned off. Input/output processing is performed at the timing of I/O refresh in a normal scan.
- By using operation devices "Direct input IN" or "Direct output OT", it becomes possible to directly perform input/output processing during operation, independent of normal I/O refresh. When this operation device is used, turn on the check box [Exclude this unit from the scope of I/O refresh].
- By turning this check box on, all inputs and outputs of registered units are excluded from the scope of I/O refresh.

3.2.3 Settings When Using Expansion Unit

Make the settings according to the used configuration.

3.2 Optional Allocation Using FPWIN GR7

I/O map

Base: Expansion 1, Expansion 2(Not used), Expansion 3(Not used)

Select Power Supply Unit/Expansion Unit

Power Supply Unit: 24V DC

Expansion unit: AFP7EXPM (Master Short distance)

Expansion unit startup wait time: 5 Seconds (5 - 1800)

Max. consumption: 3.0 A, Total: 0.6 A, Remaining: 2.4 A

Unit maximum registered capacity: 2.20 MB, Remaining registered capacity: 2.20 MB

Slot No.	Product No.	Unit used	He...	Input	Out...	Ver...	Refre...	Time...	Consu...	Cassette	Programma...
<input type="checkbox"/>	0	AFP7CPS4RE/41E	FP7 CPU unit	0	10	10	Valid	Valid	200mA	Not registered	Not registere
<input type="checkbox"/>	1	AFP7X64D2	Input unit (DC typ.	10	4	0	Valid	Valid	35mA		
<input type="checkbox"/>	2	AFP7Y64T	Output unit (sink t.	14	0	4	Valid	Valid	75mA		
<input type="checkbox"/>	3	AFP7AD4H	Analog input unit (18	8	8	Valid	Valid	100mA		
<input type="checkbox"/>	4	AFP7RTD8	RTD input unit	26	16	8	Valid	Valid	65mA		
<input checked="" type="checkbox"/>	5										
<input type="checkbox"/>	6										
<input type="checkbox"/>	7										
<input type="checkbox"/>	8										
<input type="checkbox"/>	9										
<input type="checkbox"/>	10										
<input type="checkbox"/>	11										
<input type="checkbox"/>	12										
<input type="checkbox"/>	13										
<input type="checkbox"/>	14										
<input type="checkbox"/>	15										
<input type="checkbox"/>	16										

Save Setting, Read Setting(O), OK, Cancel, Read PLC, Mount, Initialize

■ Selection of Power supply unit and Expansion unit

Setting item		Description
Common to Base and Expansion 1-3	Power Supply Unit	Select 24 V DC or a power supply unit according to the used configuration.
Base	Expansion unit	AFP7EXPM (Master, short distance): Select when the total length of expansion cables is 9 m or less. AFP7EXPM (Master, long distance): Select when the total length of expansion cables is 10 m or more.
Expansion 1-3	Expansion unit	Select AFP7EXPS (Slave).
Common to Base and Expansion 1-3	Expansion unit Startup wait time	Set the wait time until the power to the expansion unit turns ON after the power to the CPU unit turned ON. A self-diagnostic error occurs when the power to the expansion unit does not turn on even after the elapse of the startup wait time. Communication via the USB port, COM port or LAN port of the CPU unit cannot be performed during the startup wait time. Setting range: 5 to 1800 sec, Default: 5 sec

3.3 Mount Allocation Using FPWIN GR7

3.3.1 Mount Registration of a Unit to be Used and the Starting Word Number

■ What is mount registration?

If all units to be used are physically at hand, you can connect FPWIN GR7 online to the FP7 CPU unit, read the actual mount status, and complete registration.

■ Allocation method

Mount registration of the unit to be used and the initial I/O number are set in the following procedure.

1 2 Procedure

1. From the menu bar, select **Online>Online Editing**.
The screen is switched to the "Online Editing" mode.
2. Select **Option>FP7 Configuration**.
3. Select "I/O Map" in the field.
The "I/O map setting" dialog box will be displayed.
4. Press the [Mount] button.
The mount status is read, and the read I/O map is registered in the CPU unit.

i Info.

- Following the mount registration operation, the system automatically reads the unit attachment status, formulates an I/O map, and enters the initial word number.
- The I/O map that has been mount-registered using FPWIN GR7 is registered into the CPU unit, together with other project information. If a difference with the actual units and/or attachment status is identified when power supply is turned on or during operation, such a difference is reported as a self-diagnosis error.
- If a starting word number is not entered, the system automatically enters one.
- Based on the starting word number allocated to each unit, I/O numbers are allocated.

3.3.2 Changing the Starting Word Number

When you want to change the starting word number following mount registration, please take the following procedure.

■ Allocation method

Changing the starting word number following mount registration should be performed in the following procedure. In the following procedure, it is assumed that an I/O map is already displayed.

1 2 Procedure

1. On the "I/O Map", double click a unit for which the starting word number should be changed.

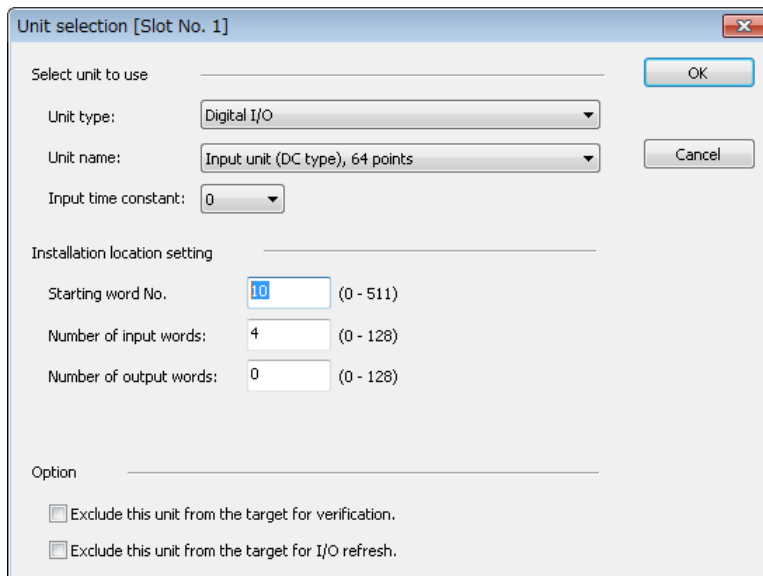

The image shows a dialog box titled "Unit selection [Slot No. 1]". It contains the following fields and options:

- Select unit to use:** A text input field.
- Unit type:** A dropdown menu with "Digital I/O" selected.
- Unit name:** A dropdown menu with "Input unit (DC type), 64 points" selected.
- Input time constant:** A dropdown menu with "0" selected.
- Installation location setting:** A text input field.
- Starting word No.:** A text input field with "10" entered, and a range "(0 - 511)" to its right.
- Number of input words:** A text input field with "4" entered, and a range "(0 - 128)" to its right.
- Number of output words:** A text input field with "0" entered, and a range "(0 - 128)" to its right.
- Option:** Two checkboxes:
 - Exclude this unit from the target for verification.
 - Exclude this unit from the target for I/O refresh.

Buttons for "OK" and "Cancel" are located on the right side of the dialog.

2. Enter a desired starting word number and press the [OK] button.
The changed number is registered in the I/O map.

i Info.

- Once you change the starting word number using FPWIN GR7, the I/O map is changed from the initial status following mount registration. It is necessary to edit the I/O map online, or to download the project once again.
- Pressing the [Reallocate] button with a desired slot selected displays the "word No. reallocation" dialog box.

3.4 I/O Map Registration

3.4 I/O Map Registration

3.4.1 I/O Map Registration

■ What is I/O map registration?

This refers to a status where I/O map information is registered in the CPU unit. To register an I/O map, the following methods are available.

- Download an I/O map created through optional allocation using FPWIN GR7 into the CPU unit.
- Perform the "mount registration" operation in the online editing mode of FPWIN GR7.

3.4.2 I/O Map Clearance

■ How to clear an I/O map

A registered "I/O map" can be cleared in the following procedure.

1 2 Procedure

1. Select **Options>FP7 Configuration** in the menu bar.
2. Select "I/O Map" in the field.
The "I/O map setting" dialog box will be displayed.
3. Press the [Initialize] button.
The "I/O map" is initialized.

i Info.

- Once the [Initialize] button is pressed, other configuration information is also deleted.

4 Installation and Wiring

4.1 Installation.....	4-2
4.1.1 Installation Environment and Space	4-2
4.1.2 Attaching Units	4-4
4.1.3 DIN Rail Attachment	4-6
4.2 Wiring the Power Supply.....	4-9
4.2.1 Common Precautions	4-9
4.2.2 Wiring for Power Supply Units	4-9
4.2.3 Wiring for the Power Supply Part of the CPU Unit.....	4-10
4.2.4 Wiring of Power Supply Part of Expansion Slave Unit.....	4-11
4.2.5 Grounding	4-11
4.3 Wiring of Expansion Cable.....	4-13
4.3.1 Expansion Cable Type	4-13
4.3.2 Connection of Function Earth Wire	4-13
4.3.3 Connecting Position and Direction of Expansion Cables	4-13
4.4 Safety Measures	4-15
4.4.1 Safety Circuit.....	4-15
4.4.2 Momentary Power Drop	4-15
4.4.3 Alarm Output.....	4-16

4.1 Installation

4.1 Installation

4.1.1 Installation Environment and Space

■ Installation environment

Operating environment (Use the unit within the range of the general specifications when installing)

- Ambient temperatures: 0 to +55°C
- Ambient humidity: 10 to 95% RH (at 25°C, no-condensing)
- Pollution degree: 2
- Altitude: Up to 2,000 m above sea level
- Overvoltage category: II or lower
- Installation location: Intended for use in a control panel with a protective construction of IP54 or higher

(made from metal of adequate strength).

Do not use the unit in the following environments.

- Areas exposed to direct sunlight
- Areas exposed to sudden temperature changes, causing condensation
- In the presence of inflammable or corrosive gas
- Areas with excessive airborne dust, metal particles or saline matter
- In the presence of benzene, paint thinner, alcohol and other organic solvents, or strong alkaline solutions such as ammonia or caustic soda
- Areas exposed to direct vibrations, shock, or drops of water
- Around power transmission lines, high voltage equipment, power cables, power equipment, radio transmitters, or any other equipment that would generate high switching surges (100 mm or more)

■ Clearance

- In order to secure clearance for ventilation, ensure that the top and the bottom of the unit are at least 50 mm away from other devices, wiring ducts, etc.

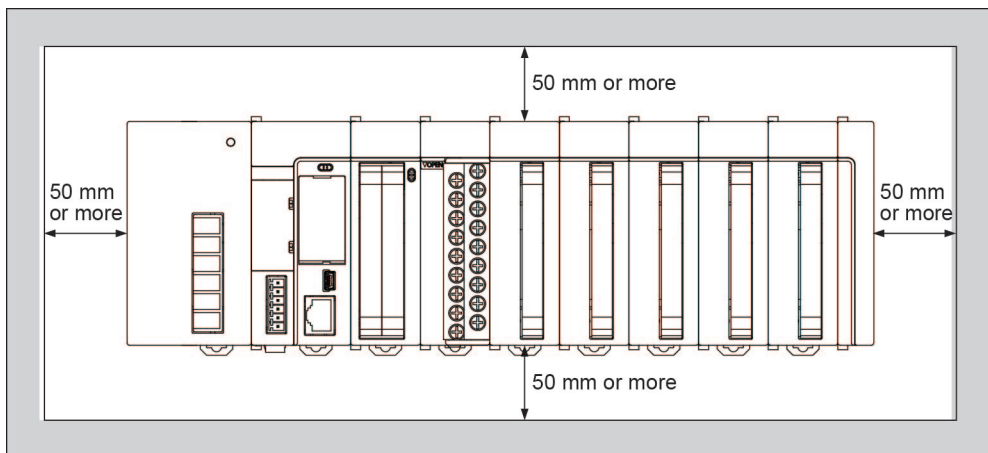

- Do not install the unit stacked up, horizontally or upside down. Doing so will prevent proper cooling of the unit and cause overheating inside.

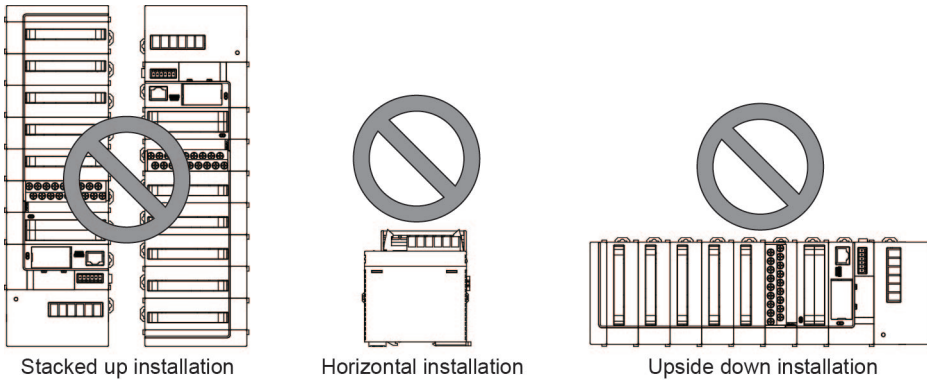

- Do not install the unit above devices which generate heat such as heaters, transformers or large scale resistors.
- In order to eliminate any effects from noise emission, power wires and electromagnetic devices should be kept at least 100 mm away from the surfaces of the unit. When installing the unit behind the doors of the control board, be especially careful to secure clearances as above.

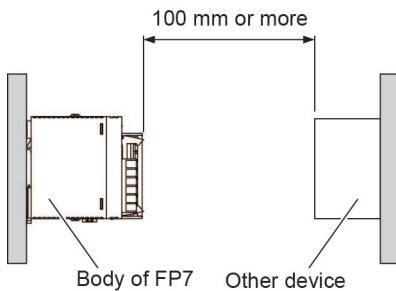

- Secure a clearance of at least 170 mm from the mounting surface of the PLC body for connecting programming tools and cables.

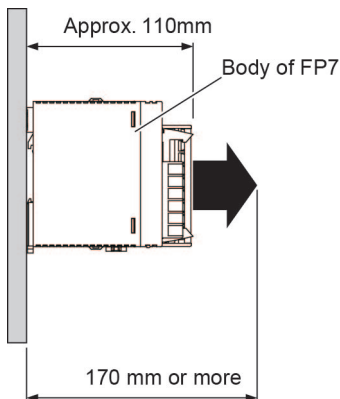

4.1 Installation

4.1.2 Attaching Units

- Attach unit attachment connectors on the side of each unit.
- Make sure to connect an end unit to the right of the end unit.
- After attaching units, attach the assembly to the DIN rail.

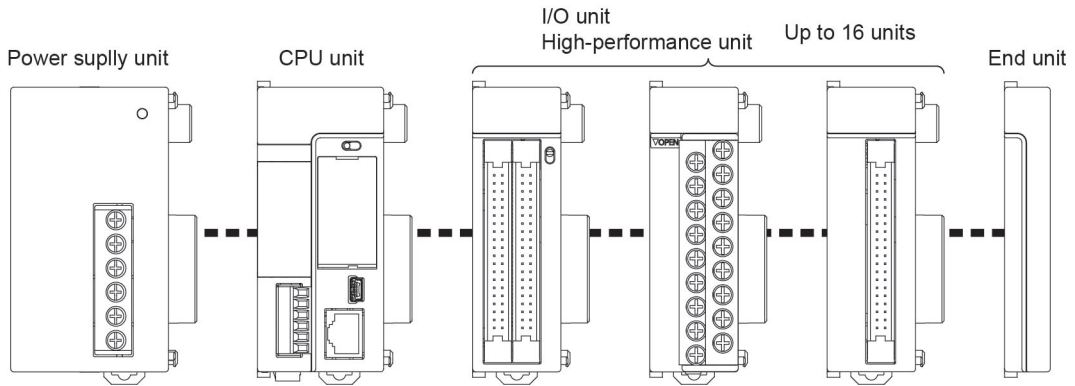

(Note 1) When the CPU unit is CPS2R, a power supply unit cannot be attached.

Unit attaching procedure

1 2 Procedure

1. Release the fixing hook on the side of the unit.
When attaching a power supply unit, remove the connector cap.

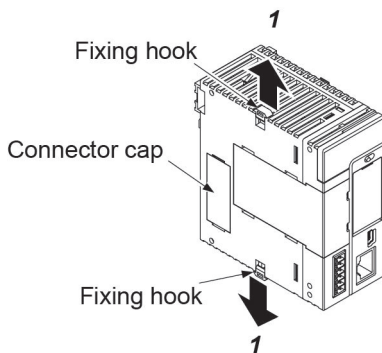

2. Attach unit connectors on the side of each unit.

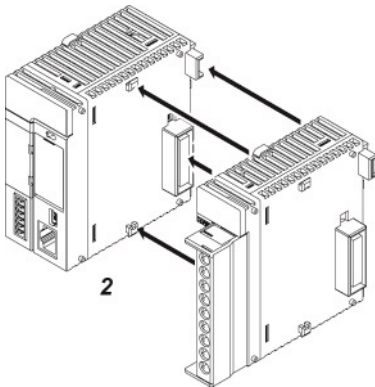

3. Lock the fixing hook.

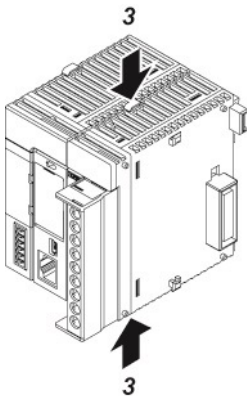

Unit removing procedure

1 2 Procedure

1. Release the fixing hook on the side of the unit.

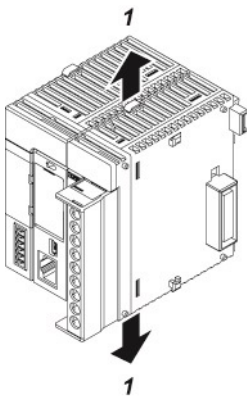

2. Slide the unit horizontally to remove it.

4.1 Installation

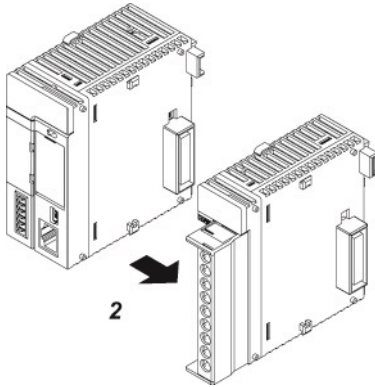

Note

- Make sure to turn off power supply before attaching a unit.
- Do not directly touch the connector part of the unit.
- Protect the connector part of the unit from stress.

4.1.3 DIN Rail Attachment

DIN rail attachment procedure

1 2 Procedure

1. Fully pull out the DIN rail attachment lever on the back of the unit.

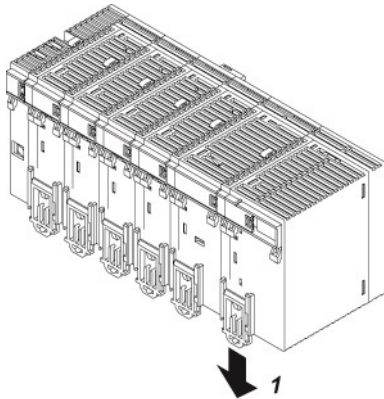

2. Fit the top of the unit attachment part into the DIN rail.

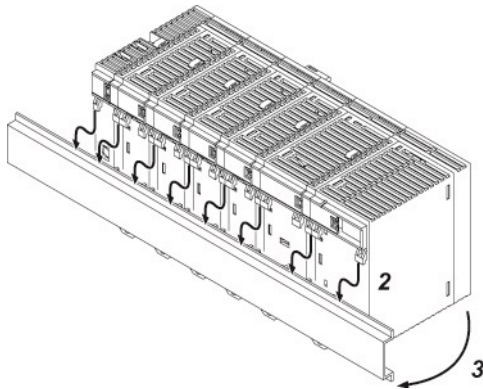

3. While pressing down the unit attachment part onto the DIN rail, fit the bottom of the unit attachment part into the DIN rail.
4. Push up the DIN rail attachment lever on the back of the unit until it clicks to lock.

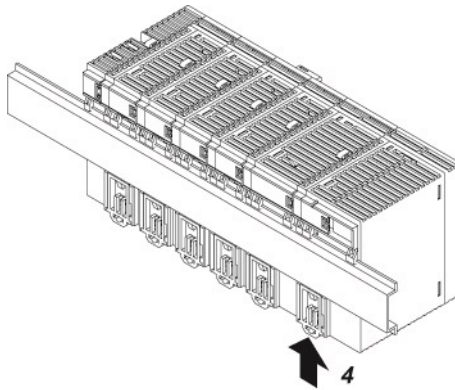

DIN rail removal procedure

1 2 Procedure

1. Fully pull out the DIN rail attachment lever on the back of the unit.

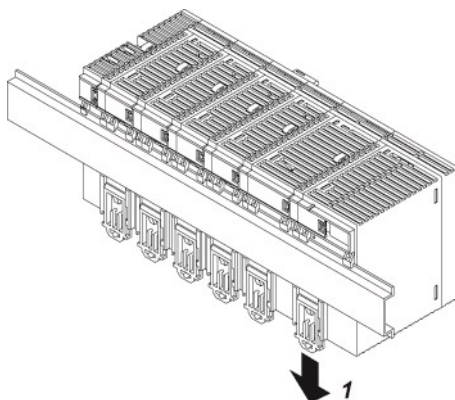

4.1 Installation

2. Pull the bottom of the unit forward.

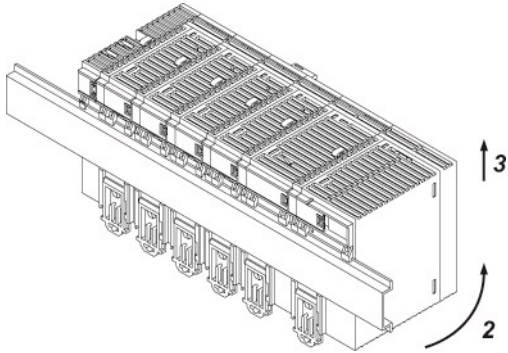

3. While pulling up the unit, remove it from the DIN rail.

4.2 Wiring the Power Supply

4.2.1 Common Precautions

■ To avoid the influence of noises

- Use a low noise power supply.
- The inherent noise resistance is sufficient for the noise superimposed on the power wires, however, the noise can be attenuated further by using the isolation transformer.
- Also, twist the power supply cables to minimize adverse effects from noise.

■ Keep the power supply wiring separate

Wiring to the CPU unit, input devices, and power equipment should have separate wiring systems.

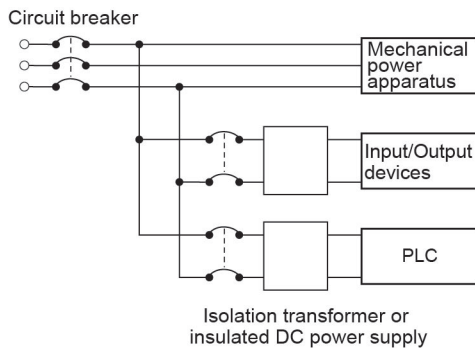

■ Measures regarding power supply sequence (start up sequence)

- Have the power supply sequence such that the power supply of PLC turns off before the power supply for input and output.
- If the input/output power supplies are turned off before the power PLC, the CPU unit will detect the input fluctuations and may begin an unscheduled operation.

4.2.2 Wiring for Power Supply Units

■ Terminal layout for power supply units

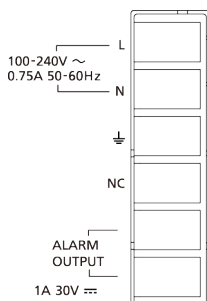

4.2 Wiring the Power Supply

■ Power supply voltage

Confirm that the connected voltage is within the allowable range of the power supply.

Product no.	Rated input voltage	Allowable voltage range	Rated output capacity	Rated output current
AFP7PSA1	100 to 240 V AC	85 to 264 V AC	24 W	1 A
AFP7PSA2	100 to 240 V AC	85 to 264 V AC	43 W	1.8 A

■ Power supply cable

Use a power supply wire of 2 mm² (AWG14) to minimize the voltage drop.

■ Suitable wires and tightening torque

Terminal	Suitable wires	Tightening torque
Power supply terminal and ground terminal	AWG14 (2.0 mm ²)	0.5 to 0.6 N·m
Alarm output terminal	AWG22 to 14 (0.3 mm ² to 2.0 mm ²)	

■ Suitable crimp terminal

M3 terminal screws are used for the terminal. Use the following solderless terminals for wiring to the terminals.

Fork type terminals



Round type terminal

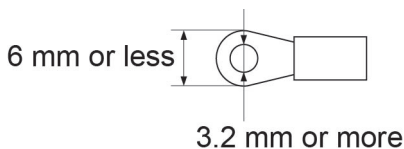

■ Suitable crimp terminal

Manufacturer	Shape	Part no.	Suitable wires
J.S.T. Mfg Co.,Ltd	Round type	2-MS3	1.04 to 2.63 mm ²
	Fork type	2-N3A	
	Round type	1.25-MS3	0.25 to 1.65 mm ²
	Fork type	1.25-B3A	

4.2.3 Wiring for the Power Supply Part of the CPU Unit

- When the CPU unit is used with 24V DC power supply, perform wiring for power supply as follows.
- Use the power supply cables (Part No.:AFP805) that come with the unit to connect the power supply.
Brown: 24 V DC, Blue: 0 V, Green: Function earth

■ Power supply part of the CPU unit

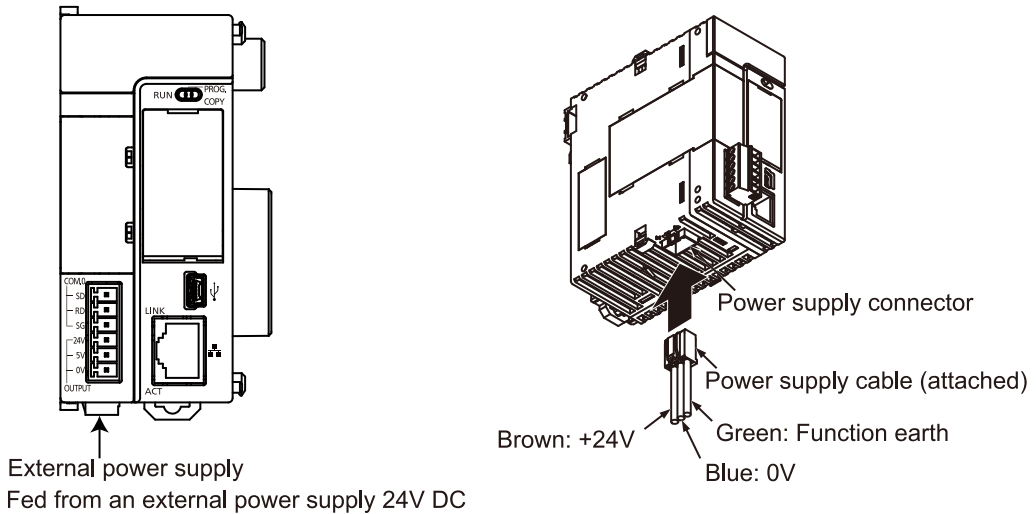

■ Power supply voltage

- Confirm that the power supply voltage is within the allowable range of the power supply.

Rated input voltage	Allowable voltage range	Rated output capacity
Operating voltage range	20.4 to 28.8 V DC	At least 24 W

- When a programmable display GT series is connected to the GT power supply terminal (24V) of the CPU unit, use it within the range of 21.6 to 26.4 V DC.

■ Selection of a power supply

- Referring to "1.4 Selection of Power Supply and Restrictions on Combination", select a power supply larger than the capacity of the unit. In the minimum configuration, select a power supply of 24 W or larger.
- In order to protect the unit against abnormal voltage from the power supply line, the power supply should be an insulated type, and should be enclosed within a protective circuit. The regulator on the unit is a non-insulated type.
- If using a power supply device without an internal protective circuit, always make sure power is supplied to the unit through a protective element such as a fuse.

4.2.4 Wiring of Power Supply Part of Expansion Slave Unit

When the power supply unit is not used, make the wiring for the power supply as well as the CPU unit with the power supply cable attached to AFP7EXPS.

4.2.5 Grounding

- Ground the instrument to ensure sufficient noise suppression.

4.2 Wiring the Power Supply

- The point of grounding should be as close to the PLC as possible. The ground wire should be as short as possible.
- Sharing the ground with another device may have an adverse effect. Therefore, be sure that grounding is dedicated.
- Earth terminals for an AC power supply unit should be grounded at a grounding resistance of 100 Ω or less.
- When 24 V DC is directly supplied to the CPU unit, ground the attached functional earth wire (green).

 CORRECT

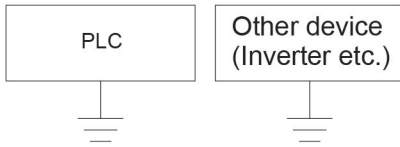

 INCORRECT

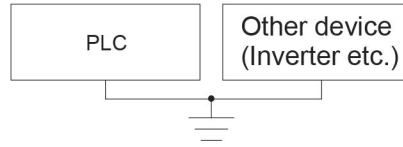

4.3 Wiring of Expansion Cable

4.3.1 Expansion Cable Type

Use the expansion cable AFP7EXPC** (sold separately) for connecting the expansion master unit AFP7EXPM and expansion slave unit AFP7EXPS, or connecting the expansion slave units AFP7EXPS together.

Product no.	Cable length
AFP7EXPCR5	0.5 m
AFP7EXPC01	1 m
AFP7EXPC03	3 m
AFP7EXPC10	10 m

4.3.2 Connection of Function Earth Wire

- A function earth wire is attached to the expansion cable. In order to avoid influence of noise, the function earth wire of the expansion cable must be grounded.
- Make grounding as the same as that of the expansion block to which the connector with the function earth wire is connected.

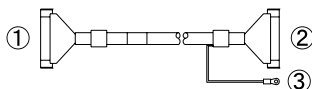

(1)	OUT side	Connected to the OUT side of the expansion master unit AFPEXPM or expansion slave unit AFPEXPS.
(2)	IN side	Connected to the IN side of the expansion slave unit AFPEXPS.
(3)	Function earth wire	Make grounding as the same as that of the expansion block to which the connector with the function earth wire is connected.

- Do not use the expansion cable in the same raceway as other cables are placed.

4.3.3 Connecting Position and Direction of Expansion Cables

- The expansion cable is connected to the MIL connector of the expansion master unit AFP7EXPM and the MIL connector on the IN side of the expansion slave unit AFP7EXPS.
- For adding the expansion block, remove the dummy connector on the OUT side of the expansion slave unit AFP7EXPS, and connect the expansion cable to the MIL connector on the IN side of the expansion slave unit AFP7EXPS in the block to be added.
- Connect the connector with the function earth wire to the MIL connector on the IN side of the expansion slave unit AFP7EXPS.
- Do not use the expansion cable in the same raceway as other cables are placed.

4.3 Wiring of Expansion Cable

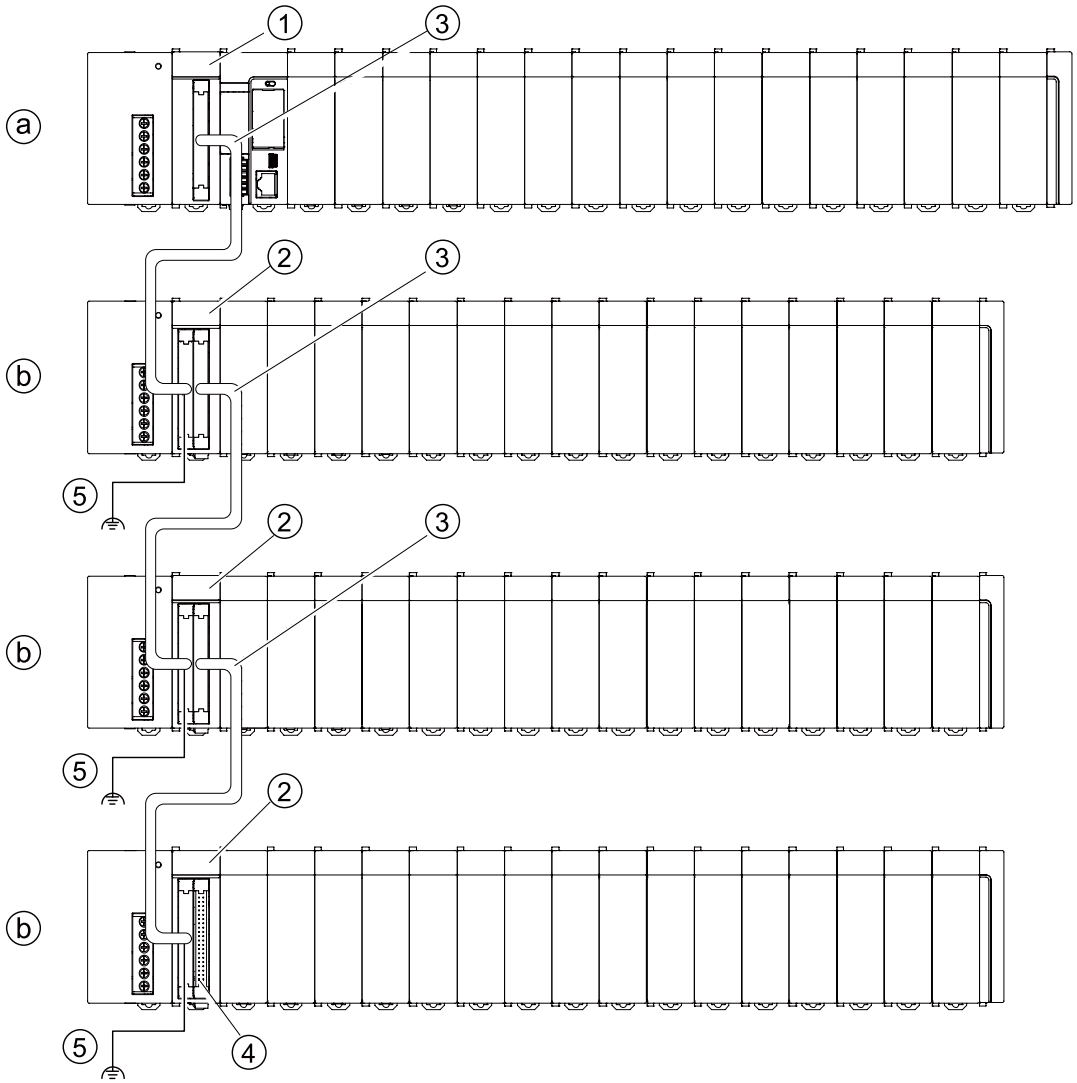

(a)	Base block	(1)	Expansion master unit	(3)	Expansion cable	
(b)	Expansion block	(2)	Expansion Slave Unit	(4)	Dummy connector	(5) Earth wire of expansion cable

4.4 Safety Measures

4.4.1 Safety Circuit

■ Precautions regarding system design

- In certain applications, malfunction may occur for the following reasons:
 - Power on timing differences between the PLC system and input/output or mechanical power apparatus.
 - Response time lag when a momentary power drop occurs.
 - Abnormality in the PLC unit, external power supply, or other devices.

In order to prevent a malfunction resulting in system shutdown take the following measures as adequate:

■ Install the interlock circuit outside PLC

- When a motor clockwise/counter-clockwise operation is controlled, provide an interlock circuit externally.

■ Install the emergency stop circuit outside PLC

- Install an emergency stop circuit outside PLC to turn off power supply to the output device.

■ Start up other devices before PLC

- The PLC should be started after booting the I/O device and mechanical power apparatus.
- When stopping the operation of PLC, have the input/output devices turned off after PLC has stopped operating.

■ Install safety measures in case of alarm outside the PLC body

- When an alarm is released, PLC output is turned off and its operation is stopped. In order to prevent a malfunction resulting in system shutdown under the above conditions, install safety measures outside PLC.

■ Perform secure grounding

- When installing PLC next to devices that generate high voltages from switching, such as inverters, do not ground them together. Use an exclusive ground for each device which should be grounded at a grounding resistance of 100 Ω or less.

4.4.2 Momentary Power Drop

Operation in the case of momentary power drop varies depending on the combination of units, the power supply voltage, and other factors. In some cases, operation may be the same as that for a power supply reset.

- When a power supply unit (AC) is being used, operation is continued in the case of momentary power drop shorter than 10 ms.
- When 24V DC is being supplied to the CPU unit, operation is continued in the case of momentary power drop shorter than 4 ms.

4.4 Safety Measures

4.4.3 Alarm Output

- A power supply unit has an alarm output contact that can be used for releasing alarm signals to outside in the event of error.
- The relay contact for alarm output is closed when power supply is ON. If the watchdog timer is operated due to a hardware error or a program error, the relay contact is turned into an open status.

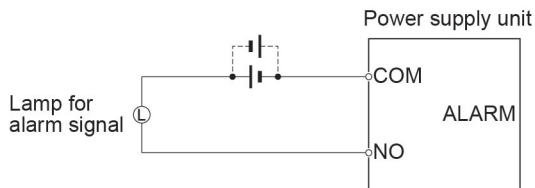

- The watchdog timer is a program error and hardware error detection timer.
- When the watchdog timer is operated, the ALARM LED in the front of the controller unit turns on. In cases where a power supply unit is attached, the ALARM contact of the power supply unit is operated at the same time. All outputs to the output units are turned off and the unit is put in halted state. In the meantime, no processing is undertaken at all, and communication with the programming tool is also halted.

5 Operation

5.1 Before Powering On.....	5-2
5.1.1 Check Points.....	5-2
5.1.2 Procedures before Starting Operation	5-2
5.2 RAM/ROM Operation.....	5-4
5.2.1 Transmission of the Project.....	5-4
5.2.2 Operations following Powering On.....	5-5
5.2.3 Data Hold During Power Failure	5-5
5.2.4 Online Editing.....	5-6
5.3 Backing Up the Project	5-7
5.3.1 Transmission from the Execution Memory RAM to the Backup Memory ROM2.....	5-7
5.3.2 Transmission from the Backup Memory ROM2 to the Execution Memory RAM/ROM1.....	5-8
5.3.3 Operations following Powering On/Off.....	5-8
5.4 SD Memory Card Operation	5-9
5.4.1 Preparing SD Memory Cards.....	5-9
5.4.2 How to Insert an SD Memory Card	5-9
5.4.3 Saving an Execution File for SD Memory Card Operation.....	5-10
5.4.4 Operation by an SD Memory Card.....	5-11
5.4.5 Transmission from an SD Memory Card to the Execution Memory ..	5-12
5.4.6 Precautions Concerning SD Memory Card Operation	5-14
5.5 Operation When Using Expansion Master Unit/Slave Unit.....	5-15
5.5.1 Operation When Power Supply Turns ON/OFF	5-15
5.5.2 Insertion and Removal of Expansion Cable.....	5-15

5.1 Before Powering On

5.1 Before Powering On

5.1.1 Check Points

Once wiring has been completed, check the following points before powering on.

■ Check Points

	Items	Description
1	Attaching Units	<ul style="list-style-type: none">• Does the product name of each unit match the device list from the design stage?• Are the unit mounting screws properly tightened? Is there any looseness?• Has the dust-proof sheet been removed from the unit?
2	Wiring	<ul style="list-style-type: none">• Are the terminal screws properly tightened? Is there any looseness?• Does the wiring of terminal match the signal name?• Is the wiring sufficiently thick for the expected current?
3	Connecting cables	<ul style="list-style-type: none">• Is the cable securely connected?• Is the expansion cable properly connected?
4	Settings of CPU	<ul style="list-style-type: none">• Is the mode switch set to "PROG."?• Are settings for the card operation switch correct?
5	Others	<ul style="list-style-type: none">• Check if there is any potential for an accident.

5.1.2 Procedures before Starting Operation

Procedures following installation and wiring and before starting operation are as follows.

1. Powering on

1. Before powering on, carry out a check while referring to "5.1.1 Check Points".
2. After powering on, check that the POWER LED (Blue) and PROG. LED (Green) are ON on the CPU unit. When a power supply unit is to be used, check that the power supply unit's POWER LED is ON.



2. Entering a project

1. Create a project using the tool software.
2. Use the tool software's "Totally Check Project" function to check for syntax errors.



3. Checking the output wiring

Use the forced I/O function to check the output wiring.



4. Checking the input wiring

Check the input wiring by using the input display LEDs or the monitoring function of the programming tool.



5. Trial operation

1. Set the mode switch to "RUN" and check that the "RUN" LED is turned on.
2. Check the sequence operation.



6. Debugging

1. If there is an error in the operation, check the project using the monitor function of the programming tool.
2. Correct the project.



7. Saving the project

Save the created project.

5.2 RAM/ROM Operation

5.2 RAM/ROM Operation

5.2.1 Transmission of the Project

Set the mode switch to "PROG". Check that the card operation switch is set to "ROM", and subsequently power on the unit.

■ Switch setting conditions

Switch	Setting
Mode switch	PROG.
Card operation switch	ROM

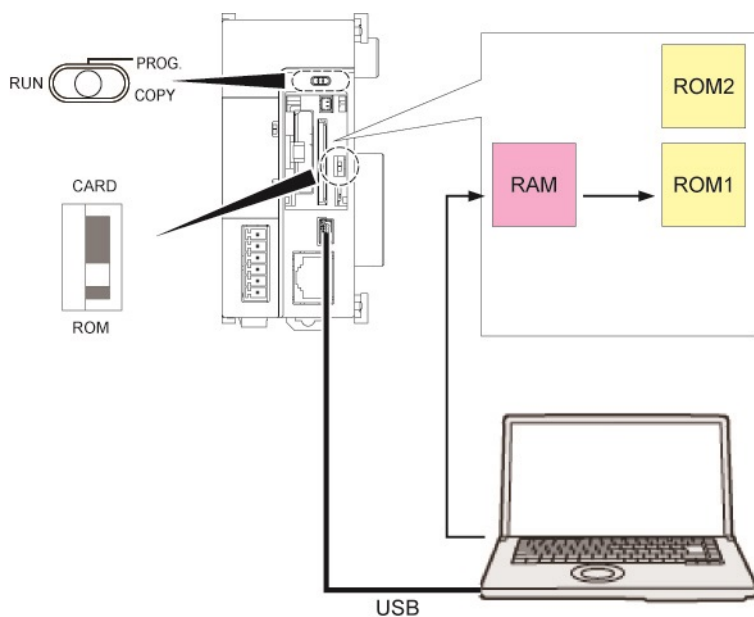

1 2 Procedure

1. Set the mode switch to PROG.
2. Set the card operation switch to ROM.
3. Power on the unit.
4. Download the project from the PC to FP7.
The downloaded data is saved in the built-in RAM, and is also automatically saved in the ROM.

5.2.2 Operations following Powering On

When the unit is powered on, whether in the PROG. mode or in the RUN mode, the project is transmitted from ROM1 to RAM.

■ Switch setting conditions

Switch	Setting
Mode switch	PROG. or RUN
Card operation switch	ROM

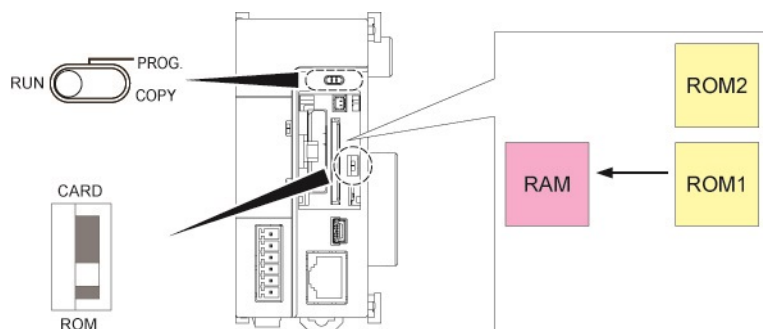

1 2 Procedure

1. The execution project is automatically transmitted from ROM1 to RAM.
2. In the RUN mode, operation is started.

5.2.3 Data Hold During Power Failure

The FP7 CPU unit backs up most data into ROM (non-volatile memory).

■ Data saved in ROM (non-volatile memory)

- Project data (programs, configuration data, comments)
- Hold type data in the operation memory
- System monitors, system records data (e.g. lifetime data, error records)

■ Data held by the built-in capacitor and the backup battery

- Calendar timer

i Info.

- Calendar timer values can continue operation for about one week by the built-in capacitor, even if no battery is used.
- In order to charge the built-in capacitor, supply power to the CPU unit for at least 30 minutes.

5.2 RAM/ROM Operation

5.2.4 Online Editing

The FP7 CPU unit can be edited online. Usable operations vary by mode.

■ **PROG. mode**

- While editing a program, the program inside the RAM is rewritten by PG converting a given network inside the program block that is being edited.
- Rewritten data in the RAM is incorporated into the ROM1.
- Comments and configuration data can also be rewritten.

■ **RUN mode**

- While editing a program, the program is written into the RAM by PG converting a given network inside the program block that is being edited.
- Rewritten data in the RAM is incorporated into the ROM1.
- Configuration data cannot be rewritten.
- Comments can be rewritten.
- It is not possible to download the entire project.
- It is possible to download the program block (PB).

After a program is rewritten in the RUN mode, operation stops for a time length proportionate to the size of the relevant PB.

5.3 Backing Up the Project

5.3.1 Transmission from the Execution Memory RAM to the Backup Memory ROM2

- In normal operation, you can save your project in the execution memory RAM/ROM1, and use the saved data. In order to prepare for unplanned rewriting, backup memory ROM2 is also installed.
- When the mode switch is set to PROG., you can back up the execution project that is saved in RAM into ROM2.

■ Switch setting conditions

Switch	Setting
Mode switch	PROG.
Card operation switch	ROM

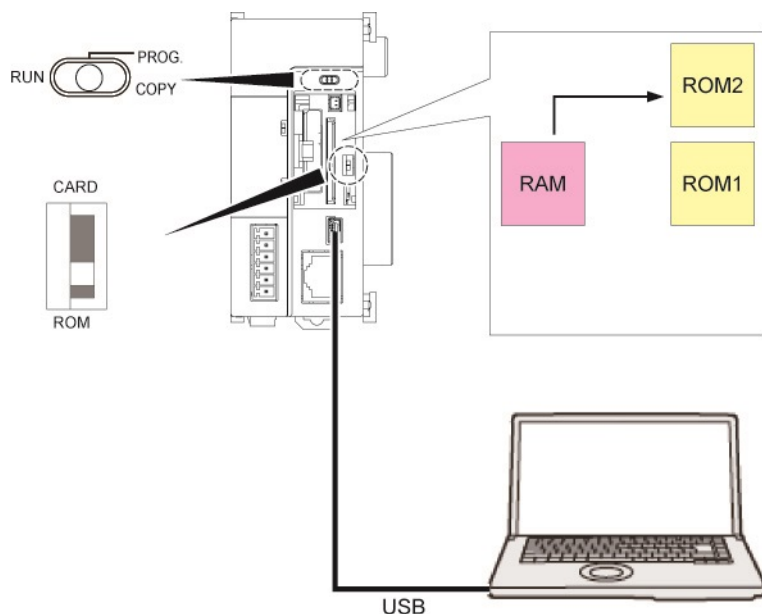

1 2 Procedure

1. Set the mode switch to PROG.
2. By executing **Online>Project Backup** using FPWIN GR7, the project is transmitted from the execution memory RAM to the backup memory ROM2.

5.3 Backing Up the Project

5.3.2 Transmission from the Backup Memory ROM2 to the Execution Memory RAM/ROM1

It is possible to transmit the backup project saved in ROM2 to RAM/ROM1 to be used as an execution project.

■ Switch setting conditions

Switch	Setting
Mode switch	PROG.
Card operation switch	ROM

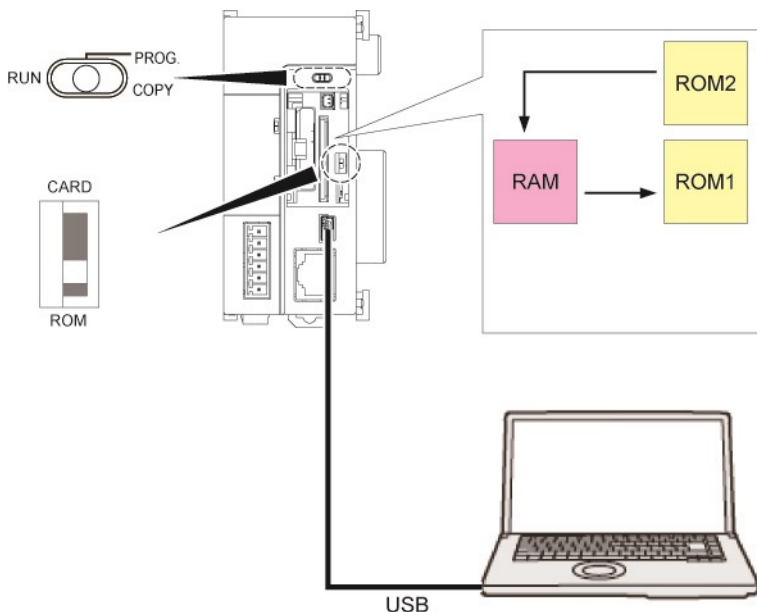

1 2 Procedure

1. Set the mode switch to PROG.
2. By executing **Online>Project Restore** using FPWIN GR7, the project is transmitted from the backup memory ROM2 to the execution memory RAM.
3. The project data is also automatically transmitted from RAM to ROM1.

5.3.3 Operations following Powering On/Off

Powering the unit on or off does not affect data saved in the backup memory ROM2.

5.4 SD Memory Card Operation

5.4.1 Preparing SD Memory Cards

■ Usable SD memory cards

We recommend SLC SD memory cards and SLC SDHC memory cards.

For details on confirmed compatible SD memory cards and SDHC memory cards, refer to <https://industry.panasonic.com/global/en/products/fasys/information/sd-card/>.

Logo printed on the CPU unit	Usable SD memory cards	
	Card type	Capacity
	SD memory card	2GB
	SDHC memory card	4GB to 32GB

■ Cautions on handling an SD memory card

The data saved in the SD memory card may be lost in the following cases. We assume no responsibility whatsoever for the loss of saved data.

- When the user or a third party has misused the SD memory card.
- When the SD memory card was affected by any static electricity or electrical noise.
- When the SD memory card was taken out, or the PLC body was powered off, while the card was being accessed (e.g. saving data into the card, deleting data from the card).

■ Formatting of SD memory cards

In principle, SD memory cards have been formatted by the time of purchase, and no formatting by the user is required. If formatting becomes necessary, download formatting software for SD memory cards from the SD Association website.

Note

- A file system formatted by PC's standard formatting software does not satisfy the SD memory card specifications. Please use the dedicated formatting software.
- It is recommended to save important data in another media for backup.
Never remove the card or power off the PLC body while the SD LED on the CPU unit is flashing (data is being read from or written into the card). Data may be damaged.
- Do not use a SD memory card with the memory capacity of which is more than the usable capacity. Data in the card may be damaged.

5.4.2 How to Insert an SD Memory Card

Take the following procedure to insert an SD memory card.

1 Procedure

1. Open the card cover on the surface of the CPU unit.

5.4 SD Memory Card Operation

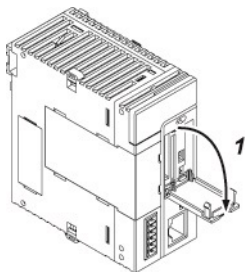

2. Press in an SD memory card into the SD memory card slot until it locks.

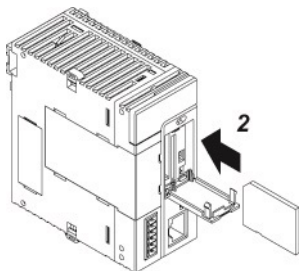

3. Close the SD memory card cover.

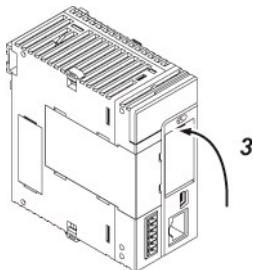

i Info.

- If the card cover is opened during access to the SD memory card while the CPU unit is operating, a self-diagnosis error is detected and operation is stopped. Access to the SD memory card is also stopped.
- Before removing an SD memory card, confirm that the operation monitor LED [SD] on the CPU unit has been turned off.

f Note

- Do not apply an excessive force to the card cover when opening or closing it or when the cover is left open. Otherwise, the cover attachment part will be deformed to cause malfunction in the cover recognition switch mounted inside the product.

5.4.3 Saving an Execution File for SD Memory Card Operation

In order to enable operation by an SD memory card, it is necessary to convert the created project into an auto execution file. Take the following procedure.

1 2 Procedure

1. Create an "AUTO" folder in an SD memory card.
2. Select **Tools>SD Memory Card>Create Auto-Run File** in the menu bar.
The "Browse Folders" dialog box is displayed.
3. Select the "AUTO" folder created in Step 1, and press the [OK] button.
An auto execution file "autoexec.fp7" and a comment file "comment.fp7" are created.

5.4.4 Operation by an SD Memory Card

■ Operation of a project saved in an SD memory card

Insert an SD memory card, set the mode switch to "RUN", and set the card operation switch to "CARD" to enable the operation of a project saved in the card.

■ Switch setting conditions

Switch	Setting
Mode switch	RUN
Card operation switch	CARD

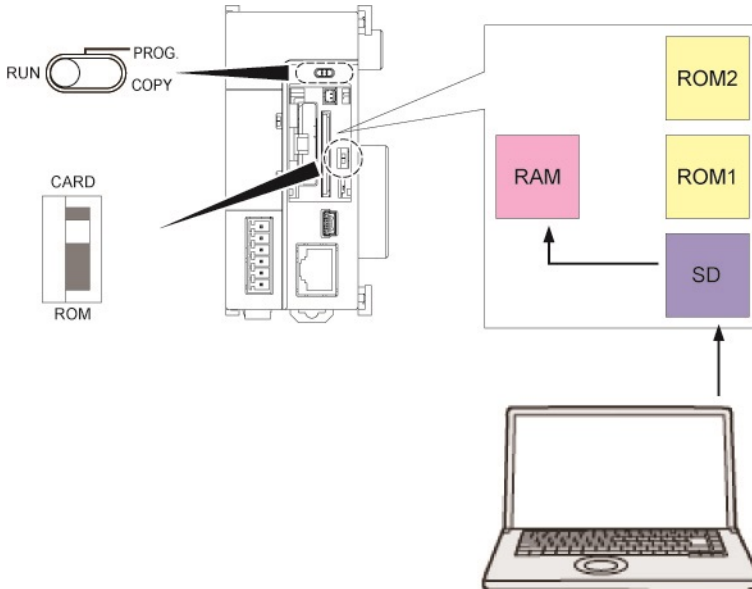

1 2 Procedure

1. Power off the unit.
2. Attach the SD memory card that houses the auto execution file "autoexec.fp7" and the comment file "comment.fp7" for the project to be used for operation to the CPU unit.

5.4 SD Memory Card Operation

3. Set the card operation switch to "CARD".

4. Close the cover and power on the unit.

The auto execution file "autoexec.fp7", a project saved in the SD memory card, is transmitted to the execution memory RAM. Transmission of the project takes place when the unit is powered on or the mode switch is set to "RUN". The comment file "comment.fp7" is not transmitted.

Info.

- If the auto execution file "autoexe.fp7" does not exist in the AUTO folder, an error (code 53: SD operation impossible: No file).

Operations during SD Memory Card Operation

If the following steps are taken, the unit runs in the "SD memory card operation" mode. Until the unit is powered off, it cannot be switched into RAM/ROM operation.

Example 1:

1. Power on the unit while the card operation switch is set to "ROM".
2. Set the card operation switch to "CARD".
3. Set the mode switch to "RUN".

Example 2:

1. Power on the unit while the card operation switch is set to "CARD".
2. Set the mode switch to "RUN".

Info.

- Online editing cannot be performed. A protection error occurs.

5.4.5 Transmission from an SD Memory Card to the Execution Memory

Insert an SD memory card, and set the mode switch to "COPY", in order to transmit a project saved in the SD memory card to ROM1 and write it in as an execution project.

■ Switch setting conditions

Switch	Setting
Mode switch	PROG. → COPY (momentary)
Card operation switch	Either CARD or ROM is possible.

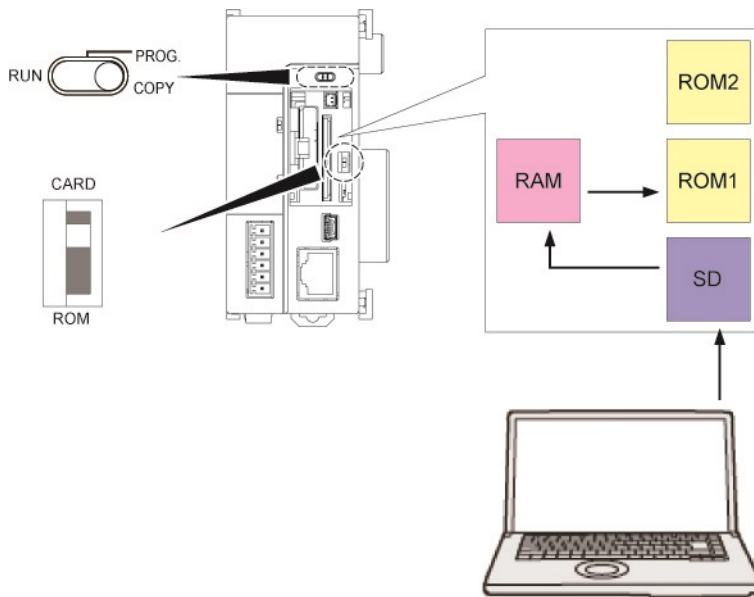

■ When power is OFF

1. Attach an SD memory card that houses the auto execution file "autoexec.fp7" and the comment file "comment.fp7" for a project to the CPU unit.
2. Close the cover and power on the unit.
3. Until "COPY LED" flashes (approx. 5 seconds), set the RUN/PROG./COPY switch to "COPY".

Transmission of project data is started. Once "COPY LED" starts to flash, the transmission process continues if you let go off the COPY switch. Once transmission is completed, "COPY LED" turns off.

i Info.

- If an auto-run file "autoexe.fp7" and a comment file "comment.fp7" do not exist in the AUTO folder, an error (code 43: Copy failure: No file) is generated.

■ When power is ON

1. Change to the PROG. mode.
2. Attach an SD memory card that houses the auto execution file "autoexec.fp7" and the comment file "comment.fp7" for the project to the CPU unit.
3. Close the cover.
4. Until "COPY LED" flashes (approx. 5 seconds), set the RUN/PROG./COPY switch to "COPY".

Transmission of project data is started. Once "COPY LED" starts to flash, the transmission process continues if you let go off the COPY switch. Once transmission is completed, "COPY LED" turns off.

i Info.

- If an auto-run file "autoexe.fp7" and a comment file "comment.fp7" do not exist in the AUTO folder, an error (code 43: Copy failure: No file) is generated.

5.4 SD Memory Card Operation

5.4.6 Precautions Concerning SD Memory Card Operation

- In the SD memory card to be used, create an "AUTO" folder, and save the auto execution file "autoexec.fp7" and the comment file "comment.fp7".
- While copying, do not remove the SD memory card from the slot. It may cause damage to the project.
- If the card operation switch is set to "CARD" while no SD memory card is inserted, a self-diagnosis error will result.
- If the unit cannot access a project in the SD memory card while the card operation switch is set to "CARD" and SD memory card operation is in progress, a self-diagnosis error will result.
- Comments cannot be read using the tool software.
- Projects cannot be read using the FPWIN Pro7.

5.5 Operation When Using Expansion Master Unit/Slave Unit

5.5.1 Operation When Power Supply Turns ON/OFF

■ Sequence of turning ON/OFF the power supply

- The power supply should be turned on or off in the following sequence.

Description	Sequence
When turning on power	Power supply for I/O device → Expansion block (expansion slave unit) → Base block (CPU unit)
When turning off power	Base block (CPU unit) → Expansion block (expansion slave unit) → Power supply for I/O device

■ Operation when the power to the base block turns off during operation

- If the power supply to the base block (CPU unit) turns off during operation, the expansion block will stop the operation. At this time, the output of the units attached to the expansion block will be turned OFF.
- If the power to the base block is turned on when the power to the expansion block is on, the system will be rebooted.

■ Operation when the power to the expansion block turns off during operation

- If the power to the expansion block (expansion slave unit) turns off during operation, a self-diagnostic error will occur and the CPU unit will stop. Other expansion blocks will also stop.
- Operation will not restart even if the power to the expansion block turns on again when the CPU stops due to the error. If the power to the base block is turned on when the power to all the expansion blocks is on, the system will be rebooted.

5.5.2 Insertion and Removal of Expansion Cable

- Do not insert or remove the expansion cable when the power is on.
- The whole system operation will stop if the expansion cable is removed during operation. Even if the cable is inserted again during operation, the operation will not restart.

(MEMO)

6 Troubleshooting

6.1 Self-diagnosis function.....	6-2
6.1.1 CPU Unit's Operation Monitor LED.....	6-2
6.1.2 Operation at the Time of Error	6-2
6.2 What to Do If an Error Occurs.....	6-4
6.2.1 ERROR LED Flashes on the CPU Unit	6-4
6.2.2 PROG Mode Does Not Change to RUN	6-4
6.2.3 ALARM LED Turns ON on the CPU Unit	6-5
6.2.4 POWER LED Does Not Turn ON on the Power Supply Unit	6-5
6.2.5 A Protect Error Message Appears	6-6
6.2.6 If Expected Output Is Not Available	6-6
6.2.7 ERR LED Turns ON on the Expansion Unit.....	6-7

6.1 Self-diagnosis function

6.1 Self-diagnosis function

6.1.1 CPU Unit's Operation Monitor LED

The CPU unit has a self-diagnostic function which identifies errors and stops operation if necessary. Indications concerning self-diagnosis are as follows.

■ LED indications concerning self-diagnosis errors

	LED indications on the CPU unit				Description	Operation status
	RUN Green	PROG Green	ERROR Red	ALARM Red		
Normal operation	●	○	○	○	Normal operation	Operation
	○	●	○	○	PROG. mode	Stop
	▲	○	○	○	Forcing input/output in the RUN mode	Operation
Error	●	○	▲	○	When a self-diagnostic error occurs (Operation)	Operation
	○	●	▲	○	When a self-diagnostic error occurs (Stop)	Stop
	○	●	-	●	System watchdog timer has been activated	Stop
	○	▲	-	○	Waiting for connection of the PHLs slave	Stop

(Note 1) ●: ON, ▲: Flashing, ○: OFF, -: Varies (ON or OFF)

6.1.2 Operation at the Time of Error

Normally, when an error occurs, the operation stops.

■ Configuration menu of FPWIN GR7

Operation mode of the CPU unit at the time of error can be set (Continue or Stop) in the "FP7 Configuration" menu of the tool software FPWIN GR7.

CPU configuration

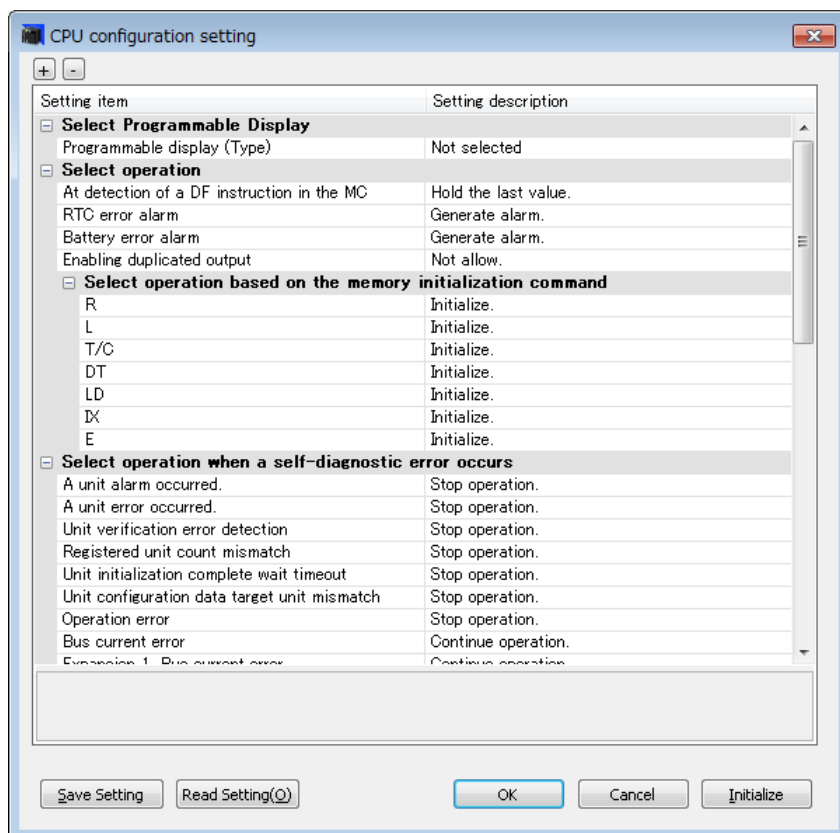

6.2 What to Do If an Error Occurs

6.2.1 ERROR LED Flashes on the CPU Unit

■ **Condition:**

A self-diagnostic error has occurred.

■ **Solution:**

Confirm the status in the following procedure.

1. Select **Online>Status Display** in FPWIN GR7, and check the error details (error code).
2. Switch to the PROG. mode.
3. If a self-diagnosis error other than a syntax error has occurred, cancel the situation in accordance with the error code.
4. In the case of a syntax error, use the **Debug>Totally Check Project** function in FPWIN GR7 to identify the syntax error.

 **Info.**

- In the case of an operation error, check the address where the error occurred before performing error clearance.
- In the case of error coded 80 or higher, the error can be cleared by pressing the [Error Clearance] button in the "Status Display" dialog box.
- In the PROG. mode, the power supply can be turned off and then on again to clear the error, but all of the contents of the operation memory except hold type data are cleared.
- An error can also be cleared by executing a self-diagnostic error set instruction (ERR).

6.2.2 PROG Mode Does Not Change to RUN

■ **Condition:**

A syntax error or a self-diagnosis error that caused operation to stop has occurred.

■ **Solution:**

Confirm the status in the following procedure.

1. Confirm that the ERROR LED is not flashing or the ALARM LED is not turned on.
2. In FPWIN GR7, use the **Totally Check Project>Debug** to identify the syntax error.

6.2.3 ALARM LED Turns ON on the CPU Unit

■ Condition:

The system watchdog timer has been activated and the operation of controller has been stopped.

■ Solution:

1. Switch the CPU unit to the PROG. mode, and turn the power supply off and then on again.
If the ALARM LED lights again, there may be a problem with the unit. If the ALARM LED goes out after the power supply is turned off and then on again, the problem may have been caused by noise or another temporary phenomenon.
2. Switch to the RUN mode.
If ALARM LED turns on after switching to the RUN mode, the program is taking excessive time. Review and modify the program.
3. Check the ambient environment for influence of noise.
If there is no problem with the program, there may be a problem in the ambient environment. Check the wiring including the earth wiring. In particular, check if the RS-232C wiring is not close to power cables, and if the wiring is shielded.

Info.

- When the program is to be reviewed, check the following points.
Example 1: Is the program in infinite loop due to an instruction that controls the flow of the program, such as a JP instruction or a LOOP instruction?
Example 2: Are interrupt instructions being executed consecutively?

6.2.4 POWER LED Does Not Turn ON on the Power Supply Unit

■ Condition:

It is possible that sufficient power is not supplied.

■ Solution:

Confirm the status in the following procedure.

1. Power off the unit and double-check the wiring status (e.g. are there any loose terminals?).
2. Check if output of the power supply unit exceeds the rating.
If capacity of the internal power supply (24V) does not suffice, examine changing combination of the units.
3. If the power supply is shared with other devices, disconnect the power supply to the other devices.
If LED on the power supply unit turns on following the above step, undercapacity of power supply is possible. Review the power supply design.

6.2 What to Do If an Error Occurs

6.2.5 A Protect Error Message Appears

■ **Condition:**

It is possible that the project is password locked.

■ **Solution:**

Confirm the status in the following procedure.

1. Select **Tools>Register/Delete Password** in FPWIN GR7.
The "Register/Delete Password" dialog box is displayed.
2. Enter a password and press the [OK] button.
The protection is canceled.

Info.

- If you press the [Forced Cancellation] button, all projects saved in PLC are deleted.

6.2.6 If Expected Output Is Not Available

■ **Condition:**

Both software reasons (e.g. program, I/O allocation) and hardware reasons (e.g. wiring, power supply) are possible.

■ **Solution (check of the output side)**

Proceed from the check of the output side to the check of the input side.

1. Check if the output indication LED on the input/output units is on.
If it is on, proceed to the next step. If it is not, proceed to Step 4.
2. Check the wiring of the load (e.g. are there any loose terminals?).
If LED on the unit turns on following the above step, undercapacity of power supply is possible. Review the power supply design.
3. Check if the power is properly supplied to both ends of the load.
If the power is properly supplied to the load, there is probably an abnormality in the load. If the power is not supplied to the load, there is probably an abnormality in the output section.
4. Monitor the output status using the tool software FPWIN GR7.
If the output monitored is turned on, there is probably a duplicated output error, etc.
5. Forcibly turn on and off the relevant output using the forced input/output functions of the tool software FPWIN GR7.
If the output indicator LED of the units is turned on, go to input condition check. If the output indicator LED remains off, there is probably an abnormality in the unit's output part.

■ **Solution (check of the input side)**

Clarify the situation in the following procedure.

1. Check whether the input indication LED on the unit is ON.
If it is OFF, proceed to the next step. If it is ON, proceed to "Step 4".
2. Check the wiring of the input device (e.g. are there any loose terminals?).
If LED on the unit turns on following the above step, undercapacity of power supply is possible. Review the power supply design.
3. Check that the power is properly supplied to the input terminals.
If the power is properly supplied to the input terminals, there is probably an abnormality in the unit's input part. If the power is not supplied to the input terminal, there is probably an abnormality in the power supply or the input device.
4. Monitor the input status using the tool software FPWIN GR7.
If the input monitored is off, there is probably an abnormality with the unit's input part. Modify the program if the input monitored is on. If the input device is a two-wire sensor, influence of leaked current is possible.

Info.

- When the program is to be reviewed, check the following points.
 1. Check if the output has been written by any duplicated use of output, etc.
 2. Check if the flow of the program has been changed by a control instruction, such as an MCR instruction or JMP instruction.
 3. Check if the allocation in the I/O map matches the mounting state.

6.2.7 ERR LED Turns ON on the Expansion Unit

■ Condition:

There is probably an error in the power supply system of the expansion block in which the expansion slave unit with the ERROR LED lit is attached or another expansion block connected to the subsequent stage, or an error in a unit in the expansion block.

■ Solution:

Clarify the situation in the following procedure.

1. Check if the power supplies to all the expansion blocks registered in the I/O map are ON.
2. Check the wiring conditions of expansion cables and power supplies.
3. Check if the end unit is connected at the end of the expansion block.
4. Check if an error occurs in a unit in the expansion block.
If a unit error occurs, refer to the manual of each unit and find the cause of the error.
5. Clear the self-diagnostic errors of the CPU unit.
6. Turn on the power to the expansion units first, and then turn on the power to the CPU unit.

6.2 What to Do If an Error Occurs

i Info.

- The expansion unit startup wait time can be set in the "I/O map" dialog box. The settable range is 5 to 1800 seconds (30 minutes). The default is 5 seconds.
- A self-diagnostic error (Error code 6: Expansion unit power supply synchronization error) will occur if the power to the expansion block does not turn on after the startup wait time passed since the power to the CPU unit has turned on. Check the power supply sequence.
- When more than one expansion block is used, the ERROR LED, on the expansion slave units in the expansion block of the next stage connected to the expansion block to which the power supply is off, does not turn on.

7 Maintenance and Inspection

7.1 Handling of Backup Battery	7-2
7.1.1 Functions of Backup Battery	7-2
7.1.2 Replacement of Backup Battery	7-2
7.1.3 Lifetime and Replacement Interval of Backup Battery	7-4
7.2 Inspection.....	7-5

7.1 Handling of Backup Battery

7.1 Handling of Backup Battery

7.1.1 Functions of Backup Battery

When the calendar timer function is to be used, attach the separately sold backup battery.

WARNING

- Never use batteries other than AFPX-BATT. It may lead to ignition and rupture of batteries.

■ Area backed up by the backup battery

Calendar timer data

■ Types of Backup Battery (separately sold)

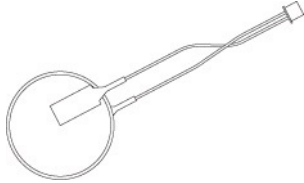
Appearance	Product name	Rated voltage	Product no.
	Backup battery	For CPS4R*/CPS3R* With a connector	AFPX-BATT

Info.

- The backup battery is for the CPS4R*/CPS3R* series. It cannot be attached to CPS2R. The calendar timer can continue operating for about one week for CPS4R*/CPS3R* and about two weeks for CPS2R through the built-in capacitor, even if no battery is used.
- In order to charge the built-in capacitor, supply power to the CPU unit for at least 30 minutes.

7.1.2 Replacement of Backup Battery

FP7 CPU unit's backup battery can be replaced while power is on. Replace the backup battery in the following procedure.

1 2 Procedure

1. Open the SD memory card cover on the surface of the CPU unit.

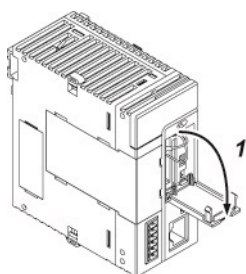

2. Remove the battery connector.

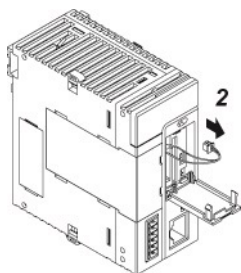

3. While extending the lever to outside, take out the backup battery from the battery holder.

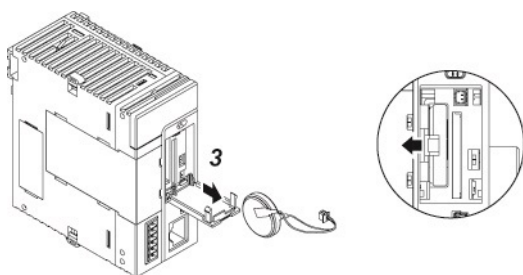

4. While extending the lever to outside, attach a new backup battery to the battery holder.
5. Connect to a power supply connector
6. Close the card cover.

i Info.

- For the FP7 CPU unit, the battery can be replaced while power is on. If the battery is to be replaced while power is off, undertake replacement within 10 minutes from powering off, after supplying power for at least 5 minutes, in order to charge the built-in capacitor. If the built-in capacitor has not been sufficiently charged, calendar timer data may become indefinite. Make sure that the battery connector cable is not pinched by the card cover.

f Note

- Do not apply an excessive force to the card cover when opening or closing it or when the cover is left open. Otherwise, the cover attachment part will be deformed to cause malfunction in the cover recognition switch mounted inside the product.

7.1 Handling of Backup Battery

7.1.3 Lifetime and Replacement Interval of Backup Battery

■ Lifetime of backup battery

Lifetime of backup battery	Suggested replacement interval
3.3 years or more	5 years

(Note 1) The lifetime indicated above is the value when no power at all is supplied.

(Note 2) Note that the lifetime in actual use may be shorter than the typical lifetime depending on the use conditions.

(Note 3) Backup battery is consumed for the backup battery detection circuit, even while power is being supplied. Lifetime while power is being supplied is approx. two times longer than the value when no power is supplied.

■ Detection of errors and replacement interval of backup battery

- When voltage of the backup battery declines, the system relays (SR24 and SR25) are turned on. As necessary, create a program for reporting the error to outside.
- If the system register's "Report Battery Error" setting is turned valid, the CPU ERROR LED on the CPU unit flashes.
- Promptly replace the battery, though data are retained for about one week from the detection of a backup battery error, even if no power at all is supplied.

Note

- The retained memory data may become indefinite after one week has passed with no power supplied, from the time when the system relays (SR24 and SR25) turned on or when the ERROR LED on the CPU unit flashed.
- The system relays (SR24 and SR25) turn on when a backup battery error is detected, regardless of settings in the CPU's configuration.
- Regardless of time passed from detection of a backup battery error, supply power to the CPU unit for at least 5 minutes before replacing the backup battery.

7.2 Inspection

In order to use the unit in the optimal conditions, ensure routine/periodic inspection.

■ Inspection Items

Inspection Items	Description	Criteria	Related Pages
Power Supply Unit	Check POWER LED on power supply unit	Normal if on	"P.2-7"
	Body of the Power Supply Unit	Periodic replacement	"P.2-7"
Display on the CPU unit	Check the RUN mode indication LED	On in RUN mode.	"P.2-2"
	Check the CPU error LED	Normally off	
	Check the Alarm LED	Normally off	
Installation	Installation to the DIN rail (Is there any looseness?) Is there any looseness of the unit?	The unit should be securely installed.	"P.4-2" to "P.4-6"
Connection status	Loose terminal screw	There should be no looseness.	"P.4-9" to "P.4-11"
	Proximity to a solderless terminal	The screws should be evenly fastened.	
	Loose connector	Locking should be on.	
	Connection status of expansion cable	There should be no looseness in the connector part.	
Voltage of the power supply unit	Voltage between terminals	100 to 240 V AC	"P.4-9", "P.8-31" to "P.8-32"
Power supply voltage of the CPU unit/Expansion slave unit	Voltage supplied to the power supply connector	24 V DC	"P.1-12", "P.8-2"
Ambient environment	Ambient temperature / in-board temperature	0 to +55°C	"P.4-2"
	Ambient humidity / in-board humidity	10 to 95% RH	
	Ambient air	Free from excessive dust and corrosive gases	
Backup battery	Backup battery for the CPU unit	Periodic replacement	"P.7-2" to "P.7-4"

(MEMO)

8 Rated voltage

8.1 CPU Unit Specifications.....	8-2
8.1.1 General Specifications	8-2
8.1.2 Performance Specifications	8-4
8.1.3 CPU Unit Communication Specifications	8-6
8.1.4 Operation Memory Area.....	8-8
8.1.5 List of System Relays	8-10
8.1.6 List of System Data Registers.....	8-17
8.1.7 List of Error/Warning Codes.....	8-24
8.2 Power Supply Unit Specifications	8-31
8.2.1 General Specifications	8-31
8.2.2 Performance Specifications	8-31
8.2.3 Alarm Output Specifications.....	8-32
8.3 Dimensions	8-33
8.3.1 Power Supply Unit	8-33
8.3.2 CPU Unit (CPS4R*/CPS3R*).....	8-34
8.3.3 CPU Unit (CPS2R).....	8-35
8.3.4 Terminal Block Type Unit (1).....	8-35
8.3.5 Terminal Block Type Unit (2).....	8-36
8.3.6 Connector Type Unit	8-37
8.3.7 Serial Communication Unit	8-38
8.3.8 Multi-wire Link Unit.....	8-39
8.3.9 PHLS Master Unit	8-40
8.3.10 End Unit	8-40
8.3.11 Figures of Unit Combination.....	8-41

8.1 CPU Unit Specifications

8.1 CPU Unit Specifications

8.1.1 General Specifications

■ General Specifications

Items	Description	
Rated voltage	24 V DC	
Allowable voltage range	20.4 to 28.8 V DC ^(Note 1)	
Allowable momentary power drop duration	When the CPU unit (DC) is used 4 ms (20.4 V is used), 7 ms (24 V is used), 10 ms (28.8 V is used) ^(Note 2)	
Allowable maximum current	Max. 2.0 A at 0 to 55°C, Max. 3.0 A at 0 to 50°C ^(Note 3)	
Operating ambient temperature	0 to +55°C ^(Note 3)	
Storage ambient temperature	-40 to +70°C	
Operating ambient humidity	10 to 95%RH (at 25°C, no-condensing)	
Storage ambient humidity	10 to 95%RH (at 25°C, no-condensing)	
Breakdown voltage	All of the expansion bus connectors - All of the power supply terminals and functional earths	500 V AC, 1 minute
Isolation resistance	All of the COM port, USB and LAN port - All of the power supply terminals and functional earths All of the expansion bus connectors - All of the power supply terminals and functional earths	100 MΩ or larger
Vibration resistance	Conforming to JIS B 3502 and IEC 61131-2 5 to 8.4 Hz, 3.5 mm single amplitude 8.4 to 150 Hz, constant acceleration of 9.8 m/s ² 10 sweeps each in X, Y and Z directions in 10 minutes (1 octave/mm)	
Shock resistance	Conforming to JIS B 3502 and IEC 61131-2 147 m/s ² , three times each in the X, Y, Z directions	
Noise resistance	1,000 V[P-P] with pulse widths 50 ns and 1 μs (using a noise simulator) (power supply terminals)	
Environment	Free from corrosive gases and excessive dust.	
Overvoltage category	Category II	
Pollution degree	Pollution degree 2	

(Note 1) When a programmable display GT series is connected to the GT power supply terminal (24 V) of the CPU unit (CPS4R*/CPS3R*), use it within the range of 21.6 to 26.4 V DC.

(Note 2) 10 ms when an AC power supply unit (AFP7PSA1/AFP7PAS2) is used

(Note 3) For details of the current consumption of a system, refer to "1.4 Selection of Power Supply and Restrictions on Combination"

■ Weight

Product name		Product no.	Weight	
Power Supply Unit	100 to 240V AC, 24W	AFP7PSA1	Approx. 240 g	
	100 to 240V AC, 3W	AFP7PSA2	Approx. 290 g	
CPU Unit	Including an end unit	AFP7CPS*	Approx. 220 g	
	Extension Cassette (Communication Cassette)	AFP7CCRS1, AFP7CCRS2, AFP7CCRM1, AFP7CCRM2, AFP7CCRS1M1	Approx. 25 g	
		AFP7CCRET1	Approx. 20 g	
	Extension Cassette (Function Cassette)	AFP7FCRA21, AFP7FCRAD2, AFP7FCRTC2	Approx. 25 g	
Input unit	DC input	16-point terminal block	AFP7X16DW	Approx. 125 g
		32-point MIL connector	AFP7X32D2	Approx. 95 g
		64-point MIL connector	AFP7X64D2	Approx. 110 g
Output unit	Relay output	16-point terminal block	AFP7Y16R	Approx. 180 g
		Transistor output	16-point terminal block	AFP7Y16T, AFP7Y16P
	32-point MIL connector		AFP7Y32T, AFP7Y32P	Approx. 95 g
	64-point MIL connector		AFP7Y64T, AFP7Y64P	Approx. 115 g
I/O Mixed Unit	Input: 32 points/Output: 32 points MIL connector	AFP7XY64D2T, AFP7XY64D2P	Approx. 115 g	
Analog Input Unit	4ch	AFP7AD4H	Approx. 130 g	
	8ch	AFP7AD8	Approx. 130 g	
Analog Output Unit	4ch	AFP7DA4H	Approx. 130 g	
Thermocouple multi-analog input unit		AFP7TC8	Approx. 145g	
RTD input unit		AFP7RTD8	Approx. 145g	
High-speed Counter Unit		AFP7HSC2T, AFP7HSC4T	Approx. 130 g	
Pulse Output Unit	2-axis	AFP7PG02T, AFP7PG02L	Approx. 130 g	
	4-axis	AFP7PG04T, AFP7PG04L	Approx. 150 g	
Positioning Unit	2-axis	AFP7PP02T, AFP7PP02L	Approx. 145g	
	4-axis	AFP7PP04T, AFP7PP04L	Approx. 145g	
Serial Communication Unit		AFP7NSCR	Approx. 110 g	
Multi-wire Link Unit		AFP7MW	Approx. 100g	
PHLS Master Unit		AFP7RMTM	Approx. 110 g	
PHLS Slave Unit	8-point terminal block	AFPRP1X08D2	Approx. 140 g	
	16-point terminal block	AFPRP2X16D2, AFPRP2Y16T AFPRP1XY16D2T	Approx. 210 g	
	e-Con	AFPRP2X08D2E	Approx. 75 g	
	Small terminal block	AFPRP2X16D2, AFPRP2Y16T AFPRP2XY16D2T, AFPRP2Y04R	Approx. 75 g	

8.1 CPU Unit Specifications

Product name	Product no.	Weight
Expansion master unit	AFP7EXPM	Approx. 120 g
Expansion slave unit (including an end unit)	AFP7EXPS	Approx. 200 g

8.1.2 Performance Specifications

Description		Rated voltage	
Program method		Relay symbol method	
Control method		Cyclic operation method	
No. of control I/O points	Basic configuration (1 block)	Max. 1,024 points (When using 64 points x 16 slots)	
	When the PHLS remote I/O system is used	Max. 16,128 points (1,008 points x 16 slots)	
Program memory	Built-in memory	Execution project saving memory (RAM and ROM1): Non-volatile memory Backup project saving memory (ROM2): Non-volatile memory	
	Memory capacity	(Note 1)	
	Max. program blocks	(Note 1)	
Comment memory	Memory capacity	3 M bytes (all comments including I/O comments, note comments, and block comments)	
Operation speed (Basic instruction/step)		CPS4R*/CPS3R*: From 11ns, CPS2R: From 14ns	
Basic instructions		Approx. 100 types	
High-level instructions		Approx. 206 types	
O p e r a t i o n m e m o r y	1-bit device	External inputs (X)	8,192 points (X0 to X511F)(Note 2)(Note 3)
		External outputs (Y)	8,192 points (Y0 to Y511F)(Note 2)(Note 3)
		Internal relays (R)	32,768 points (R0 to R2047F)(Note 3)
		Link relays (L)	16,384 points (L0 to L1023F)(Note 3)
		Timers (T)	4,096 points (T0 to T4095)(Note 3) Can count up to (Unit: 10 us, 1 ms, 10 ms, 100 ms, 1 s) × 4,294,967,295
		Counters (C)	1,024 points (C0 to C1023)(Note 3) Can count from 1 to 4,294,967,295
		System relays (R)	1,120 points (approx. 70 words)
		Pulse relays (P)	4,096 points (P0 to P255F)(Note 3)
		Error alarm relays (E)	4,096 points (E0 to E4095)(Note 3)
		Direct input (IN)	Allocate input numbers to each slot (IN0 to IN62F)(Note 3)(Note 4)
	Direct output (OT)	Allocate output numbers to each slot (OT0 to OT62F)(Note 3)(Note 4)	
16-bit device	Data register (DT)	(Note 1)(Note 3)	

8.1 CPU Unit Specifications

Description		Rated voltage
32-bit device	Link data register (LD)	16,384 words (LD0 to LD16383) ^(Note 3)
	Unit memory (UM)	Max. 512K words per unit ^(Note 4)
	System data register (SD)	110 words
	Index register	15 double words (I0 to IE) (with switching function) ^(Note 3)
	Timer set value register (TS)	4,096 double words (TS0 to TS4095) ^(Note 3)
32-bit device	Timer elapsed value register (TE)	4,096 double words (TE0 to TE4095) ^(Note 3)
	Counter set value register (CS)	1,024 double words (CS0 to CS1023) ^(Note 3)
	Timer/counter elapsed value register (CE)	1,024 double words (CE0 to CE1023) ^(Note 3)
	Master control relay (MCR)	No limits (no numbers)
	Labels (JMP, LOOP)	Max. 65,535 points per PB
Differential points (DF, DFI)	Depending on the program capacity	
No. of step ladders	No restriction	
No. of subroutines	Max. 65,535 points per PB	
Interrupt program	Fixed cycle execution type PB: 1 PB per project Execution interval: 0.1 ms or 1 ms	
	Interrupt from high-speed counter unit Max. 8 points per unit, Max. 8 units per project	
Constant scan	0 to 125 ms (adjustable in 1 ms increments)	
Memory backup for power failure	Built-in non-volatile memory backs up the project (program, comments and configuration data) and operation memory. (Excluding calendar timer)	
Calendar timer (real-time clock)	Yes (a separately sold backup battery is required) ^(Note 5)	
Self-diagnosis function	Watchdog timer, program syntax check	
Rewriting during RUN function	Yes (rewriting on a PB basis, no limit to the number of rewriting steps)	
Security function	Password function, no-read settings, encryption can be set for the program, comments and configuration data	

(Note 1) The program capacity, data register capacity and maximum number of program blocks (PBs) vary according to the type of CPU and memory configuration settings. They are set from the configuration menu of tool software FPCWIN GR7. The default values are pattern 3 for CPS4R* and pattern 1 for CPS3R* and CPS2R.

Unit type	Memory type	Memory select pattern				
		1	2	3	4	5
CPS4R*	Program capacity (step)	234,000	221,500	196,000	144,500	51,500
	Data register capacity (word)	65,536	131,072	262,144	524,288	999,424
	Maximum number of PBs	468	443	392	289	103

8.1 CPU Unit Specifications

Unit type	Memory type	Memory select pattern				
		1	2	3	4	5
CPS3R*	Program capacity (step)	121,500	96,000	64,000	32,000	
	Data register capacity (word)	131,072	262,144	425,984	589,824	
	Maximum number of PBs	243	192	128	64	
CPS2R	Program capacity (step)	64,000	32,000			
	Data register capacity (word)	131,072	262,144			
	Maximum number of PBs	128	64			

- (Note 2) Figures in the table indicate the number of devices that can be used in the program. The actual inputs and outputs that can be used vary by configuration.
- (Note 3) Operation devices are categorized into "hold type", which memorizes the status immediately before a power failure or switching to the PROG. mode, and "non-hold type", which resets the status. Internal relays, data registers, link relays and link registers can be set as non-hold type or hold type by the tool software. Counters and error alarm relays are hold type. Other operation memories are non-hold type. However, data registers (DT) that can be used as hold type are a maximum of 262,144 words (DT0 to DT262143) for CPS4R*/CPS3R*, and a maximum of 131,072 words (DT0 to DT131071) for CPS2R.
- (Note 4) Direct inputs (IN), direct outputs (OT), and unit memories (UM) are used by specifying unit slot numbers and memory addresses to be controlled by instructions.
- (Note 5) CPS4R* and CPS3R* can be used by attaching an optional battery. Precision of the calendar timer (real-time clock): Difference less than 95 seconds per month (0°C), less than 15 seconds per month (+25°C), less than 130 seconds per month (+55°C). When the unit is connected to ET-LAN, the time is synchronized by the SNTP function. Battery lifetime: 3.3 years or more, suggested replacement interval: 5 years. After power is supplied to the CPU unit for 30 minutes or longer, it can be activated by the internal capacitor even without a battery. For CPS4R*/CPS3R*, approx. one week. For CPS2R, approx. two weeks.

8.1.3 CPU Unit Communication Specifications

■ USB port (for tool software)

Description	Rated voltage
Standard	USB2.0 FULL SPEED
Communication function	MEWTOCOL-COM (slave), MEWTOCOL7-COM (slave)

(Note 1) The USB port is insulated from the internal circuit.

■ COM0 port

Description	Rated voltage
Interface	3-wire 1-channel RS232C
Transmission distance	15 m
Baud rate	300, 600, 1,200, 2,400, 4,800, 9,600, 19,200, 38,400, 57,600, 115,200 bit/s
Communication method	Half-duplex transmission
Synchronous method	Start stop synchronous system

Description	Rated voltage
Communication format	Data length: 7 bits / 8 bits Parity: No / Yes (Odd / Even) Start code: Without STX / With STX End code: CR / CR + LF / None / ETX Stop bit: 1 bit / 2 bits
Data transmission order	Transmits from bit 0 character by character.
Communication function	MEWTOCOL-COM (master/slave), MEWTOCOL7-COM (slave) MODBUS RTU (master/slave) general-purpose communication modem initialization

(Note 1) Baud rate, transmission format, and applications of communication should be set using the tool software.

(Note 2) When communication is performed at a baud rate of 38,400 bit/s or higher, the cable length should be within 3 m. For wiring the RS-232C, a shielded wire must be used to increase noise suppression.

(Note 3) When connecting a commercially available device, please confirm operation using the actual device.

(Note 4) Each SD, RD and SG terminal of the RS-232C port is insulated from the internal circuit.

■ LAN port (CPS4RE/CPS3RE)

Description	Rated voltage	
Interface	100BASE-TX / 10BASE-T	
Baud rate	100 Mbps/10 Mbps automatic negotiation ^(Note 1)	
Cable total length	100 m (500 m when using a repeater)	
Communication cable	UTP (Category 5)	
No. of nodes	254 unit	
Number of simultaneous connections	Max. 220 (User connections: 216, System connections 4)	
Communication protocol (Communication layer)	TCP/IP, UDP/IP	
DNS	Supports name server	
DHCP/DHCPV6	Automatic getting of IP address	
FTP server/Client (Supports SSL)	Server function File transmission, No. of users: 3 Client function Data and file transmission	
HTTP server/Client (Supports SSL)	Server function System WEB, Customer WEB (8 MB), No. of simultaneous sessions: 16 Client function Data transmission	
SMTP client (Supports SSL)	Client function Mail transmission	
SNTP	Time synch function	
General-purpose communication	16 kB/connection (User connections 1 to 16)	
Dedicated communication	Slave communication	MEWTOCOL-COM, MEWTOCOL7-COM, MEWTOCOL-DAT, MODBUS-TCP, MC protocol
	Master communication	MEWTOCOL-COM, MEWTOCOL-DAT, MODBUS-TCP, MC protocol

(Note 1) Switching between different speeds is done automatically by auto negotiation function.

8.1 CPU Unit Specifications

(Note 2) System connection is used when connecting tool software via LAN.

(Note 3) The LAN port is insulated from the internal circuit.

(Note 4) MC protocol is an abbreviation for MELSEC Communication Protocol, and MELSEC is a registered trademark of Mitsubishi Electric Corporation. Only QnA compatible 3E frame and binary (bulk read and bulk write) can be used.

(Note 5) The standards cite 100 m as the maximum, but noise resistance measures such as attaching a ferrite core may be necessary in some cases, depending on the usage environment. Also, if the hub is positioned close to a control board, we recommend using it at a distance of 10 m or less.

8.1.4 Operation Memory Area

Name		Usable devices and ranges		Functions
1 Bit dev ice	External input	X	8,192 points (X0 to X511F) ^(Note 1)	Turns on or off based on external input.
	External output	Y	8,192 points (Y0 to Y511F) ^(Note 1)	Externally outputs on or off state.
	Internal relay	R	32,768 points (R0 to R2047F) ^(Note 2)	Relay which turns on or off only within program.
	Link relay	L	16,384 points (L0 to L1023F) ^(Note 2)	This relay is a shared relay used for PLC link.
	Timer	T	4,096 points (T0 to T4095) ^(Note 2)	This goes on when the timer reaches the specified time.
	Counter	C	1,024 points (C0 to C1023) ^(Note 2)	This goes on when the timer increments.
	System relay	SR	Approx. 1120 points (approx. 70 words)	Relay which turns on or off based on specific conditions and is used as a flag.
	Pulse relay	P	4,096 points (P0 to P255F)	This relay only turns on during one scan at the start of the execution condition.
	Error alarm relay	E	4,096 points (E0 to E4095)	This relay ensures that error conditions that are freely allocated by the user are memorized in the memory.
	Direct input	IN	Can allocate the number of input points to each slot (IN0 to IN62F) ^(Note 3)	This relay is for input/output processing during operation, without depending on usual I/O refresh.
Direct output	OT	Can allocate the number of output points to each slot (OT0 to OT62F) ^(Note 3)		
16- bit dev ice	External input (Note1)	WX	WX0 to WX511 ^(Note 1)	Code for specifying 16 external input points as one word (16 bits) of data.
	External output (Note1)	WY	WY0 to WY511 ^(Note 1)	Code for specifying 16 external output points as one word (16 bits) of data.
	Internal relay	WR	WR0 to WR2047 ^(Note 2)	Code for specifying 16 internal relay points as one word (16 bits) of data.
	Link relay	WL	WL0 to WL1023	Code for specifying 16 link relay points as one word (16 bits) of data.
	Data register	DT	Max. DT 999424 words (DT0 to DT999423) ^{(Note 2)(Note 4)}	Data memory used in program. Data is handled in 16-bit units (one word).

Name		Usable devices and ranges	Functions
	Link register	LD 16,384 words (LD0 to LD16383) <i>(Note 2)</i>	This is a shared data memory which is used within the PLC link. Data is handled in 16-bit units (one word).
	Unit memory	UM Max. 512K words per unit <i>(Note 3)</i>	This device is for accessing the unit memory of intelligent units. Its size varies by unit, and is allocated by default.
	System data register	SD Approx. 110 words	Data memory for storing specific data. Various settings and error codes are stored.
32-bit device	Index register	I 15 double words (I0 to IE) (with switching function)	Register can be used as an address of memory area and constants modifier.
	Timer set value area	TS 4,096 double words (TS0 to TS4095) <i>(Note 2)</i>	Data memory for storing timer target data. It corresponds to the timer number.
	Timer elapsed value area	TE 4,096 double words (TE0 to TE4095) <i>(Note 2)</i>	Data memory for storing timer elapsed value. It corresponds to the timer number.
	Counter set value area	CS 4,096 double words (CS0 to CS4095) <i>(Note 2)</i>	Data memory for storing counter set value. It corresponds to the counter number.
	Counter elapsed value area	CE 4,096 double words (CE0 to CE4095) <i>(Note 2)</i>	Data memory for storing the elapsed value during operation of a counter. It corresponds to the timer number.
Constant	Signed decimal constants	K	K-32768 to K32767 (for 16-bit operation)
			K-2147483648 to K2147483647 (for 32-bit operation)
	Unsigned decimal constants	U	U 0 to U65535 (for 16-bit operation)
			U 0 to U4294967295 (for 32-bit operation)
	Hexadecimal constants	H	H0 to HFFFF (for 16-bit operation)
			H0 to HFFFFFFFF (for 32-bit operation)
Single-precision floating-point format real number	SF	SF-1.175494 × 10 ⁻³⁸ to SF-3.402823 × 10 ³⁸ SF 1.175494 × 10 ⁻³⁸ to SF 3.402823 × 10 ³⁸	
Double-precision floating-point format real number		DF	DF-2.2250738585072014 × 10 ⁻³⁰⁸ to DF-1.7976931348623158 × 10 ³⁰⁸ DF 2.2250738585072014 × 10 ⁻³⁰⁸ to DF 1.7976931348623158 × 10 ³⁰⁸

(Note 1) Figures in the table indicate the number of devices that can be used in the program. The actual inputs and outputs that can be used vary by configuration.

(Note 2) Operation devices are categorized into "hold type", which memorizes the status immediately before a power failure or switching to the PROG. mode, and "non-hold type", which resets the status. Non-hold area is cleared to zero when the unit is powered on or the mode is switched between PROG and RUN.

Types of operation devices	Hold or Non-hold
Internal relays (R), Data registers (DT), Link relays (L), Link registers (LD)	Can be set as non-hold type or hold type by the tool software.

8.1 CPU Unit Specifications

Types of operation devices	Hold or Non-hold
Counters (C), Counter set values (CS), Counter elapsed values (CE), Error alarm relays (E)	Hold type
Inputs (X), Outputs (Y), Timers (T), Timer set values (TS), Timer elapsed values (TE), Pulse relays (P), Direct inputs (IN), Direct outputs (OT), Index registers (I), Unit memories (UM), System data registers (SD)	Non-hold type

(Note 3) Direct inputs (IN), direct outputs (OT), and unit memories (UM) are used by specifying unit slot numbers and memory addresses to be controlled by instructions.

(Note 4) The number of usable data registers (DT) varies according to the type of CPU and memory configuration settings. However, data registers (DT) that can be used as hold type are a maximum of 262,144 words (DT0 to DT262143) for CPS4R*/CPS3R*, and a maximum of 131,072 words (DT0 to DT131071) for CPS2R.

Unit Type	Memory type	Memory select pattern				
		1	2	3	4	5
CPS4R*	Data register capacity (word)	65,536	131,072	262,144	524,288	999,424
CPS3R*	Data register capacity (word)	131,072	262,144	425,985	589,824	
CPS2R	Data register capacity (word)	131,072	262,144			

8.1.5 List of System Relays

WS0

Device No.	Name	Description
SR0	Self-diagnostic error flag	Turns on when a self-diagnosis error occurs. Self-diagnosis error codes are saved in the system data register SD0.
SR1	Unit alarm occurrence	Turns on when a unit alarm is detected. The slot number of the unit where an alarm has occurred is saved in the system data register SD1.
SR2	Unit error occurrence	Turns on when a unit error is detected. The slot number of the unit where an error has occurred is saved in the system data register SD2.
SR3	Unit warning occurrence	Turns on when a unit warning is detected. The slot number of the unit where a warning has occurred is saved in the system data register SD3.
SR4	Unit verification error occurrence	Turns on when an I/O verification error is detected. The slot number of the unit where an I/O verification error has occurred is saved in the system data register SD4.
SR5	Unit installation error detection	Turns on when a unit installation error is detected. The slot number of the unit where an I/O verification error has occurred is saved in the system data register SD5.
SR6	Memory configuration inconsistency detection relay	Turns ON when an inconsistency is detected in memory configuration. The setting where an error has occurred is saved in the system data register SD6.
SR7	Operation error flag (hold type)	Turns on when an operation error occurs after the unit has started operating, and remains on while the unit operation continues. The PB number where an error has occurred is saved in the system data SD7,

8.1 CPU Unit Specifications

Device No.	Name	Description
		and the address is saved in system data registers SD8 to SD9. It indicates the first operation error that has occurred.
SR8	Operation error flag (latest type)	Turns on every time an operation error occurs. The PB number where an operation error has occurred is saved in the system data register SD10, and the address is saved in system data registers SD11 to SD12. Every time a new error occurs, the data are updated. It does not turn off even if the instruction is normally completed after the occurrence of the error(s). In order to check if any error has occurred in a specific instruction, either see address data saved in the SD, or clear error flags using ERR instruction immediately before the specific instruction, and check flags immediately after executing the instruction.
SR9	Carry flag (CY flag)	Used in shift instruction and rotate instruction with a carry flag. The flag can also be operated in carry set instruction and carry reset instruction. It is not set in overflow or underflow of operation results. Turns on when an error occurs during the execution of Ethernet communication instruction. The error code is stored in the system data register SD29.
SRA	> flag	Executes comparison instruction, and turns on if the result is larger.
SRB	= flag	Executes comparison instruction, and turns on if the result is equal. Executes operation instruction, and turns on if the result is '0'.
SRC	< flag	Executes comparison instruction, and turns on if the result is smaller.
SRD	Support timer instruction flag	Turns on after support timer instruction (SPTM) is executed and subsequently specified time has passed. Turns off when execution conditions go off.
SRE	All error alarms relay	Turns on when any of the error alarm relays E0 to E4095 turns on. Turns off once all of the error alarm relays go off.
SRF	Constant scan error flag	Turns on if scan time exceeds the setting during constant scan. It also turns on if '0' is set in FP7 configuration.

WS1

Device No.	Name	Description
SR10	Normally ON relay	Is normally on.
SR11	Normally-off relay	Is normally off.
SR12	Scan relay	Turns on or off in each scan.
SR13	Initial pulse relay (ON)	Goes on for only the first scan after operation (RUN) has been started, and goes off for the second and subsequent scans.
SR14	Initial pulse relay (OFF)	Goes off for only the first scan after operation (RUN) has been started, and goes on for the second and subsequent scans.
SR15	Step ladder Initial pulse relay (ON)	Turns on in the first scan only, following startup of any single process, during stepladder control.
SR16	PB initial relay (ON)	Turns on at the start of execution of a program block. Turns off in the next scan.
SR17	PB initial relay (OFF)	Turns off at the start of execution of a program block. Turns on in the next scan.
SR18	0.01-second clock pulse relay	Clock pulse with a 0.01-second cycle

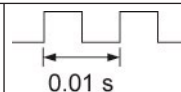

8.1 CPU Unit Specifications

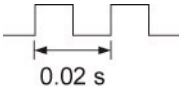
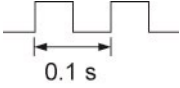
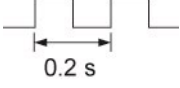
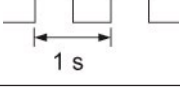
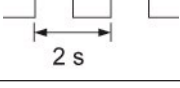
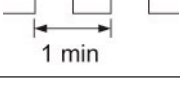
Device No.	Name	Description	
SR19	0.02-second clock pulse relay	Clock pulse with a 0.02-second cycle	
SR1A	0.1-second clock pulse relay	Clock pulse with a 0.1-second cycle	
SR1B	0.2-second clock pulse relay	Clock pulse with a 0.2-second cycle	
SR1C	1-second clock pulse relay	Clock pulse with a 1-second cycle	
SR1D	2-second clock pulse relay	Clock pulse with a 2-second cycle	
SR1E	1-minute clock pulse relay	Clock pulse with a 1-minute cycle	
SR1F	Not used		

WS2

Device No.	Name	Description
SR20	CPU operation modes	ON: RUN mode OFF: PROG mode
SR21	Operation program memory	ON: SD memory card OFF: ROM
SR22	RTC data error	Turns on if an error is detected in calendar timer data when the unit is powered on.
SR23	Power supply unit service lifetime warning	Turns on when it is detected that a power supply unit is close to its lifetime.
SR24	RTC backup battery Error flag 1 (Hold type)	Turns on when an RTC backup battery error is detected. The flag turns on if the battery is out, even if battery error alarm is disabled in the configuration menu. Once a battery error has been detected, this is held even after recovery has been made. The flag is turned off when power supply is cut off.
SR25	RTC backup battery Error flag 1 (Current type)	Turns on when an RTC backup battery error is detected. It is OFF in the normal state. The flag turns on if the battery is out, even if battery error alarm is disabled in the configuration system register.
SR26	SNTP time update fail	Turns on if acquisition of time data has failed during time synch via LAN port. Is off in the normal status.
SR27	SNTP time update completed	Turns off when time is being updated with SNTP, and turns on when the update is completed. (Note 1)
SR28	(Not used)	
SR29	Forcing flag	Turns on while forced input/output operations are in progress.
SR2A	Interrupt enable	Turns on when interrupt is enabled.

Device No.	Name	Description
SR2B	Interrupt error flag	Turns on when an interrupt error occurs.
SR2C	Interrupting flag	Turns on when an interrupt program is being executed. Only valid within a PB for execution at a specified interval or within an INT program.
SR2D	PB for execution at a specified interval in progress	Turns on when a PB (program block) for execution at a specified interval is being executed.
SR2E	(Not used)	
SR2F	Rewriting during RUN completed	Turns on in the first scan only following completion of rewriting during RUN.

(Note 1) Available from the CPU unit Ver.3.03 or later.

WS3

Device No.	Name	Description
SR30	SD slot cover status flag	ON: Cover open OFF: Cover closed
SR31	SD memory card attachment flag	ON: There is an SD memory card OFF: No SD memory card
SR32	SD memory card recognition completed flag	ON: Completed recognition of an SD memory card OFF: Other than the above
SR33	SD memory card recognition result flag	ON: Error OFF: Normal
SR34	SD memory card write protection flag	ON: Protected OFF: Not protected
SR35	SD memory card type	ON: SD OFF: SDHC
SR36	SD memory card file system	ON: FAT16 OFF: FAT32
SR37	Logging into FTP server	Turns on while logging in.
SR38	Logging trace execution	ON: Executing OFF: Not in operation
SR39	Logging trace start	ON: Active OFF: Not in operation
SR3A	SD memory card access instruction active	This relay is used to check whether other SD memory card access instructions are executed or not. ON: Executing OFF: Not in operation
SR3B	SD memory card access instruction execution complete	This relay is used to check the completion of SD memory card access instruction with the change of this flag (ON to OFF), and used to turn off the trigger of the instruction. ON: Execution complete OFF: Executing
SR3C	SD memory card access instruction execution result	The execution result of SD memory card access instruction is stored. Error codes are stored in system data register SD30. ON: Error

8.1 CPU Unit Specifications

Device No.	Name	Description
		OFF: Normal
SR3D	SD card logging graph aggregation in process	ON: Aggregating OFF: Aggregation complete
SR3E	(Not used)	
SR3F	SD memory card is being accessed. Power OFF	Turns on if the CPU unit is powered off while accessing an SD memory card.

WS5

Device No.	Name	Description
SR50	MW unit error alarm relay (1st unit)	Turns on when an error occurs in the FP7 MW Unit. The error code and unit number is stored in the system registers SD90 to SD95.
SR51	MW unit error alarm relay (2nd unit)	
SR52	MW unit error alarm relay (3rd unit)	
SR53	MW unit error alarm relay (4th unit)	
SR54	MW unit error alarm relay (5th unit)	
SR55	MW unit error alarm relay (6th unit)	

WS10 (Logging trace control relays: For LOG0)

Device No.	Name	Description
SR100	Logging trace execution	Turns on when the logging trace is performed. Other relays in LOGn turns off while this relay turns on. Storing data in the buffer memory is executed while this relay turns on.
SR101	SD memory card logging active	Turns on when writing files to a SD card becomes enabled after the logging trace execution relay turned on (buffer logging was enabled).
SR102	Logging trace completed	Turns on after the completion of file writing when stopping the logging trace is requested or it is automatically stopped.
SR103	Logging excessive speed relay	<ul style="list-style-type: none"> Turns on when the buffer logging speed exceeds the writing speed to an SD memory card in logging operation. Turns on when the number of data previously stored and the number of data stored this time increase. Turns on at the timing of buffer logging, and turns off at the timing of buffer logging or the end of scan.
SR104	Buffer overflow	<ul style="list-style-type: none"> Turns on when the buffer memory has been exhausted. At that time, new data cannot be stored. The value of the buffer overflow counter SD120 is incremented (+1). In that case, writing to the SD memory card does not stop. Turns off at the end of scan when buffer vacancy occurs while writing to a SD memory card is performed. The buffer overflow counter SD120 is cleared to 0. After buffer vacancy occurred, data logging is executed at the timing of logging to the buffer.

Device No.	Name	Description
SR105	Logging trace error	Turns on when an error is detected during the logging trace and stops the logging trace.
SR106	No SD memory card free space	Turns on when an error is detected during the logging trace and stops the logging trace.
SR107	Device and trigger setting error	Turns on when an error is detected in set values during the startup operation. The error relay SR105 also turns on. At that time, the execution relay SR100 does not turn on as the logging trace function cannot be started.
SR108	Tracing stop trigger monitor	Monitors a registered trace stop trigger when executing tracing. Turns on when conditions are met.
SR109	Trace data acquisition complete	Turns on after logging data for a specified number of times after detecting the tracing stop trigger during the execution of trace.
SR10A - SR10F	(Not used)	

WS11 - WS25 (Logging trace control relays: For LOG1 - LOG15)

Device No.	Name	Description
SR110 -SR119	Logging trace control relay For LOG1	For the details of each control relay, refer to the previous page.
SR120 -SR129	Logging trace control relay For LOG2	
SR130 -SR139	Logging trace control relay For LOG3	
SR140 -SR149	Logging trace control relay For LOG4	
SR150 -SR159	Logging trace control relay For LOG5	
SR160 -SR169	Logging trace control relay For LOG6	
SR170 -SR179	Logging trace control relay For LOG7	
SR180 -SR189	Logging trace control relay For LOG8	
SR190 -SR199	Logging trace control relay For LOG9	
SR200 -SR209	Logging trace control relay For LOG10	
SR210 -SR219	Logging trace control relay For LOG11	
SR220 -SR229	Logging trace control relay For LOG12	
SR230 -SR239	Logging trace control relay For LOG13	
SR240	Logging trace control relay	

8.1 CPU Unit Specifications

Device No.	Name	Description
-SR249	For LOG14	
SR250	Logging trace control relay	
-SR259	For LOG15	

WS90

Device No.	Name	Description
SR900	Operation history No.0 active relay	ON: Active OFF: Not in operation
SR901	Operation history No.1 active relay	
SR902	Operation history No.2 active relay	
SR903	Operation history No.3 active relay	
SR904	Operation history No.4 active relay	
SR905	Operation history No.5 active relay	
SR906	Operation history No.6 active relay	
SR907	Operation history No.7 active relay	
SR908 - SR90F	(Not used)	

WS91

Device No.	Name	Description
SR910	Operation history No.0 device settings error relay	ON: Error OFF: Normal
SR911	Operation history No.1 device settings error relay	
SR912	Operation history No.2 device settings error relay	
SR913	Operation history No.3 device settings error relay	
SR914	Operation history No.4 device settings error relay	
SR915	Operation history No.5 device settings error relay	
SR916	Operation history No.6 device settings error relay	
SR917	Operation history No.7 device settings error relay	
SR918 - SR91F	(Not used)	

WS100 - WS149

Device No.	Name	Description	
SR1000 to SR1499	Program block PB active relay	Can monitor program blocks that are being started up. SR1000 to SR1499 are allocated to 500 PBs.	
		Device No.	PB No.
		SR1000	PB 000
		SR1001	PB 001
		SR1002	PB 002
		-----	-----
		SR1009	PB 009
		SR1010	PB 010
		SR1011	PB 011
		-----	-----
		-----	-----
		SR1498	PB498
SR1499	PB499		

8.1.6 List of System Data Registers**SD0-SD28**

Device No.	Name	Description
SD0	Self-diagnostic error code	Stores the error code when a self-diagnosis error occurred.
SD1	Alarm Occurrence Unit Slot No.	Saves the slot number of the unit where an alarm has occurred. Slot No.1 to 64
SD2	Error Occurrence Unit Slot No.	Stores the slot number of the unit in which the error occurred or the slot number of the CPU unit with built-in ET-LAN. Slot No.1 to 64, 100 (CPU unit with built-in ET-LAN)
SD3	Warning Occurrence Unit Slot No.	Stores the slot number of the unit in which the warning occurred or the slot number of the CPU unit with built-in ET-LAN. Slot No.1 to 64, 100 (CPU unit with built-in ET-LAN) When the number is 0, it indicates the warning for COM0, COM1, or COM2 (communication cassette or SCU port warning).
SD4	Verification Error Occurrence Unit Slot No.	Saves the slot number of the unit where a verification error has occurred. Slot No.1 to 64
SD5	Installation error detection slot No.	Saves the slot number of the unit where an installation error was detected. Slot No.1 to 64
SD6	Memory configuration inconsistency details	When a memory configuration inconsistency is detected, information about the setting where the error has occurred is saved

8.1 CPU Unit Specifications

Device No.	Name	Description	
		Bit No.	Description
		0	Logging/Trace settings
		1	FTPc settings
		2	HTTPc settings
		3	Mailc settings
		4	EIP settings
		5	W-PLC link settings
		6	W2-PLC link settings
SD7	Operation error occurrence PB number (hold type)	Saves the PB number where the first operation error occurred after the unit has started operating.	
SD8	Address with operation error (hold type) (32-bit lower address)	Saves the address where the first operation error occurred after the unit has started operating. Perform monitoring using 32-bit data.	
SD9	Address with operation error (hold type) (32-bit higher address)		
SD10	Operation error occurrence PB number (latest type)	Saves the PB number where an operation error occurred. Every time a new error occurs, the data are updated. The value '0' is recorded at the start of the scan.	
SD11	Address with operation error (new type) (32-bit lower address)	Saves the address where an operation error occurred. Every time a new error occurs, the data are updated. The value '0' is recorded at the start of the scan. Perform monitoring using 32-bit data.	
SD12	Address with operation error (new type) (32-bit higher address)		
SD13 -SD14	(Not used)		
SD15 -SD16	Remainder of DIVFP2 instruction execution results	The division remainder of the DIVFP2 instruction is stored.	
SD17 -SD18	(Not used)		
SD19	RING counter 2.5 ms	The saved value is increased by one every time the respective time unit has passed. (H0 to HFFFF) Current values of SD19 to SD21 can only be read when SD19 to SD21 are directly specified and read by MV instruction. The scan start value is read by other instructions.	
SD20	RING counter 10 μ s		
SD21	RING counter 100 μ s		
SD22	Scan time (current value)	Saves the current value.	[Saved value (decimal)] x 10 μ s scan time indication: Indicates operation cycle time in the RUN mode only. Max. and Min. values are cleared at switching between the RUN mode and the PROG. mode.
SD23	Scan time (minimum value)	Stores the minimum value.	
SD24	Scan time (maximum value)	Saves the maximum value.	
SD25 -SD26	(Not used)		

Device No.	Name	Description
SD27	Interval for PB for execution at a specified interval	Saves interval for PB for execution at a specified interval.
SD28	(Not used)	

(Note 1) SD0 to SD5 are available only when the corresponding system relays SR0 to SR5 are on.

SD29

Device No.	Name	Description															
SD29	Ethernet communication error code	Saves the error code when the Ethernet communication instruction is executed.															
		<table border="1"> <thead> <tr> <th>SR9</th> <th>SD29</th> </tr> </thead> <tbody> <tr> <td>0: Normal</td> <td>0: Normal</td> </tr> <tr> <td rowspan="9">1: Error</td> <td>1: Incorrect IP address specification</td> </tr> <tr> <td>2: Incorrect subnet mask specification</td> </tr> <tr> <td>3: Incorrect default gateway specification</td> </tr> <tr> <td>4: Incorrect IP addresses are combined.</td> </tr> <tr> <td>10: Ethernet cable disconnected</td> </tr> <tr> <td>11: Ethernet initialization in progress</td> </tr> <tr> <td>12: IP address unestablished</td> </tr> <tr> <td>13: Client not started</td> </tr> <tr> <td>14: Connection processing in progress</td> </tr> <tr> <td>15: Connection occupied</td> </tr> </tbody> </table>	SR9	SD29	0: Normal	0: Normal	1: Error	1: Incorrect IP address specification	2: Incorrect subnet mask specification	3: Incorrect default gateway specification	4: Incorrect IP addresses are combined.	10: Ethernet cable disconnected	11: Ethernet initialization in progress	12: IP address unestablished	13: Client not started	14: Connection processing in progress	15: Connection occupied
		SR9	SD29														
		0: Normal	0: Normal														
		1: Error	1: Incorrect IP address specification														
			2: Incorrect subnet mask specification														
			3: Incorrect default gateway specification														
			4: Incorrect IP addresses are combined.														
			10: Ethernet cable disconnected														
			11: Ethernet initialization in progress														
12: IP address unestablished																	
13: Client not started																	
14: Connection processing in progress																	
15: Connection occupied																	

SD30-SD39

Device No.	Name	Description																								
SD30	SD Memory Card Access Instruction Execution result	Error codes while the SD memory card access instruction is executed are stored.																								
		<table border="1"> <thead> <tr> <th>Value</th> <th>Name</th> <th>Detailed information</th> </tr> </thead> <tbody> <tr> <td>0</td> <td>Normal end</td> <td></td> </tr> <tr> <td>1</td> <td>No SD memory card</td> <td>No SD memory card is inserted, or the cover is open.</td> </tr> <tr> <td>2</td> <td>SD memory card write-protected</td> <td>The SD memory card is write-protected.</td> </tr> <tr> <td>3</td> <td>Specified file name error</td> <td>Code that cannot be specified for a file name is used. There are too many hierarchies for the specified folder.</td> </tr> <tr> <td>4</td> <td>No specified file</td> <td>The specified file does not exist.</td> </tr> <tr> <td>5</td> <td>File already exists</td> <td>The specified file already exists.</td> </tr> <tr> <td>6</td> <td>File read error</td> <td></td> </tr> </tbody> </table>	Value	Name	Detailed information	0	Normal end		1	No SD memory card	No SD memory card is inserted, or the cover is open.	2	SD memory card write-protected	The SD memory card is write-protected.	3	Specified file name error	Code that cannot be specified for a file name is used. There are too many hierarchies for the specified folder.	4	No specified file	The specified file does not exist.	5	File already exists	The specified file already exists.	6	File read error	
		Value	Name	Detailed information																						
		0	Normal end																							
		1	No SD memory card	No SD memory card is inserted, or the cover is open.																						
		2	SD memory card write-protected	The SD memory card is write-protected.																						
		3	Specified file name error	Code that cannot be specified for a file name is used. There are too many hierarchies for the specified folder.																						
		4	No specified file	The specified file does not exist.																						
5	File already exists	The specified file already exists.																								
6	File read error																									

8.1 CPU Unit Specifications

Device No.	Name	Description		
		Value	Name	Detailed information
		7	File write error	A write-protect attribute is set for the specified file.
		8	File access position error	The reading position or writing position is incorrect.
		9	SD memory card capacity shortage	Cannot be executed because there is not enough free space on the SD memory card.
		10	Read format error	Error in the conversion format when reading a file.
		11	File access contention	A file that is being logged is specified. A file that is being accessed via FTP is specified.
		12	The specified directory is not empty.	A directory or a file exists under the directory to be deleted.
		-1 to -99	Others	
		SD31 -SD39	(Not used)	

SD40-SD49

Device No.	Name	Description
SD40	Slot No.	The slot number specified by the UNITSEL instruction operand [S1] is stored. CPU with built-in SCU U0: U0 to U2 CPU with built-in ET-LAN: U100 Serial Communication Unit (SCU): U1 to U64
SD41	COM port No. or User connection No.	The COM port number or user connection number specified by the UNITSEL instruction operand [S2] is stored. CPU with built-in SCU: U0 to U2 CPU with built-in ET-LAN: U1 to U216 Serial Communication Unit (SCU): U1 to U4
SD42 -SD49	(Not used)	

SD50-SD99

Device No.	Name	Description
SD50	Calendar timer (year)	<ul style="list-style-type: none"> Saves year, month, day, hour, minute, second and day-of-the-week data of the calendar timer as 16-bit binary data. The built-in calendar timer will operate correctly through the year 2099 and support leap years. The calendar timer can be set (time synch) by writing desired values using the programming tool or a program based on calendar setting instruction (TIMEWT).
SD51	Calendar timer (month)	
SD52	Calendar timer (day)	
SD53	Calendar timer (hours)	
SD54	Calendar timer (minutes)	

8.1 CPU Unit Specifications

Device No.	Name	Description																																						
SD55	Calendar timer (seconds)																																							
SD56	Calendar timer (day-of-the-week)																																							
SD60	Total ON number of error alarm relays	Saves the total number of error alarm relays that are on. (Max. 4096 relays). By specifying SD60 in RST instruction, all data in the error alarm buffer can be cleared.																																						
SD61	No.1 error alarm relay that turned on	Saves the number of the error alarm relay that turned on in the first place (No.1). By specifying SD61 in RST instruction, all data in the error alarm buffer can be cleared.																																						
SD62 -SD79	No.2 to No.19 error alarm relays that turned on	Saves the numbers of the error alarm relays that turned on. By specifying the device number in RST instruction, all data of the relevant relay(s) in the error alarm buffer can be cleared. Device numbers of system data registers SDs and error alarm relays correspond as follows.																																						
		<table border="1"> <thead> <tr> <th>Device No.</th> <th>Error alarm relay</th> </tr> </thead> <tbody> <tr><td>SD62</td><td>No.2</td></tr> <tr><td>SD63</td><td>No.3</td></tr> <tr><td>SD64</td><td>No.4</td></tr> <tr><td>SD65</td><td>No.5</td></tr> <tr><td>SD66</td><td>No.6</td></tr> <tr><td>SD67</td><td>No.7</td></tr> <tr><td>SD68</td><td>No.8</td></tr> <tr><td>SD69</td><td>No.9</td></tr> <tr><td>SD70</td><td>No.10</td></tr> <tr><td>SD71</td><td>No.11</td></tr> <tr><td>SD72</td><td>No.12</td></tr> <tr><td>SD73</td><td>No.13</td></tr> <tr><td>SD74</td><td>No.14</td></tr> <tr><td>SD75</td><td>No.15</td></tr> <tr><td>SD76</td><td>No.16</td></tr> <tr><td>SD77</td><td>No.17</td></tr> <tr><td>SD78</td><td>No.18</td></tr> <tr><td>SD79</td><td>No.19</td></tr> </tbody> </table>	Device No.	Error alarm relay	SD62	No.2	SD63	No.3	SD64	No.4	SD65	No.5	SD66	No.6	SD67	No.7	SD68	No.8	SD69	No.9	SD70	No.10	SD71	No.11	SD72	No.12	SD73	No.13	SD74	No.14	SD75	No.15	SD76	No.16	SD77	No.17	SD78	No.18	SD79	No.19
		Device No.	Error alarm relay																																					
		SD62	No.2																																					
		SD63	No.3																																					
		SD64	No.4																																					
		SD65	No.5																																					
		SD66	No.6																																					
		SD67	No.7																																					
		SD68	No.8																																					
		SD69	No.9																																					
		SD70	No.10																																					
		SD71	No.11																																					
		SD72	No.12																																					
		SD73	No.13																																					
		SD74	No.14																																					
		SD75	No.15																																					
SD76	No.16																																							
SD77	No.17																																							
SD78	No.18																																							
SD79	No.19																																							
SD80	For error alarm relay	Calendar timer (year)	Saves time when the error alarm relay saved in SD61 turned on.																																					
SD81		Calendar timer (month)																																						
SD82		Calendar timer (day)																																						
SD83		Calendar timer (hours)																																						

8.1 CPU Unit Specifications

Device No.	Name	Description
SD84	Calendar timer	
SD85	Calendar timer	
	(seconds)	
SD86 -SD89	(Not used)	
SD90	FP7 MW Unit error annunciation register 1st unit	<p>When an error occurs in the FP7 MW Unit, the error code is stored in the high byte and the unit number is stored in the low byte.</p> <p style="text-align: center;">bit no. 15 8 7 0</p> <p style="text-align: center;"> </p> <p style="text-align: center;">Error code Unit No.</p>
SD91	FP7 MW Unit error annunciation register 2nd unit	
SD92	FP7 MW Unit error annunciation register 3rd unit	
SD93	FP7 MW Unit error annunciation register 4th unit	
SD94	FP7 MW Unit error annunciation register 5th unit	
SD95	FP7 MW Unit error annunciation register 6th unit	
SD96 -SD99	(Not used)	

SD100 - SD115 and SD120 - SD135 (For logging trace control)

Device No.	Name	Description
SD100	Buffer free space for LOG0	<p>Stores free space of buffer memory during logging. Unit: kB</p>
SD101	Buffer free space for LOG1	
SD102	Buffer free space for LOG2	
SD103	Buffer free space for LOG3	
SD104	Buffer free space for LOG4	
SD105	Buffer free space for LOG5	
SD106	Buffer free space for LOG6	
SD107	Buffer free space for LOG7	
SD108	Buffer free space for LOG8	
SD109	Buffer free space for LOG9	
SD110	Buffer free space for LOG10	
SD111	Buffer free space for LOG11	
SD112	Buffer free space for LOG12	
SD113	Buffer free space for LOG13	

Device No.	Name	Description
SD114	Buffer free space for LOG14	<ul style="list-style-type: none"> Saves the number of times buffer overflow flags (e.g. SR104 for LOG0) turn on. For checking the number of times logging data is lost during the buffer overflow, register the buffer overflow counter as logging data.
SD115	Buffer free space for LOG15	
SD120	Buffer overflow counter for LOG0	
SD121	Buffer overflow counter for LOG1	
SD122	Buffer overflow counter for LOG2	
SD123	Buffer overflow counter for LOG3	
SD124	Buffer overflow counter for LOG4	
SD125	Buffer overflow counter for LOG5	
SD126	Buffer overflow counter for LOG6	
SD127	Buffer overflow counter for LOG7	
SD128	Buffer overflow counter for LOG8	
SD129	Buffer overflow counter for LOG9	
SD130	Buffer overflow counter for LOG10	
SD131	Buffer overflow counter for LOG11	
SD132	Buffer overflow counter for LOG12	
SD133	Buffer overflow counter for LOG13	
SD134	Buffer overflow counter for LOG14	
SD135	Buffer overflow counter for LOG15	

SD220-SD254

Device No.	Name	Description
SD220	Operation history No.0 Number of records	Stores the number of accumulated operation history records.
SD221	Operation history No.1 Number of records	
SD222	Operation history No.2 Number of records	
SD223	Operation history No.3 Number of records	
SD224	Operation history No.4 Number of records	
SD225	Operation history No.5 Number of records	
SD226	Operation history No.6 Number of records	
SD227	Operation history No.7 Number of records	
SD228 -SD229	(Not used)	

8.1 CPU Unit Specifications

Device No.	Name	Description
SD230	Operation history No.0 Number of free buffers	Stores the number of free buffers for operation history.
SD231	Operation history No.1 Number of free buffers	
SD232	Operating history No.2 Number of free buffers	
SD233	Operation history No.3 Number of free buffers	
SD234	Operation history No.4 Number of free buffers	
SD235	Operating history No.5 Number of free buffers	
SD236	Operating history No.6 Number of free buffers	
SD237	Operating history No.7 Number of free buffers	
SD238 -SD239	(Not used)	
SD240	Operation history No.0 Update counter	Stores a value +1 for each operation history record accumulated.
SD241	Operation history No.1 Update counter	
SD242	Operation history No.2 Update counter	
SD243	Operation history No.3 Update counter	
SD244	Operation history No.4 Update counter	
SD245	Operation history No.5 Update counter	
SD246	Operation history No.6 Update counter	
SD247	Operation history No.7 Update counter	
SD248 -SD254	(Not used)	

8.1.7 List of Error/Warning Codes

Error codes 1 to 6

Code	Name	Operation	Error contents and steps to take
1	CPU hardware error 1	Stop	There may be a hardware problem. Please contact your dealer.
2	CPU hardware error 2	Stop	

8.1 CPU Unit Specifications

Code	Name	Operation	Error contents and steps to take
3	I/O bus power supply error (including "no end cover")	Stop	Error in the I/O bus part is probable, such that the end unit has not been attached. Double-check the attachment status of units. This error also occurs when an expansion cable is removed during operation.
4	Unit attachment limit exceeded	Stop	is probable that the unit attachment limit has been exceeded. Double-check the configuration.
5	Project data error	Stop	Turns on when there is an error in project data.
6	Expansion unit power supply synchronization error	Stop	Turns on when there is an error in the expansion block side such that the power to the expansion unit is not on or the expansion cable is not connected correctly when the power turns on. The wait time until the power turns on can be set in the I/O map configuration dialog box.

Error codes 20 to 27

Code	Name	Operation	Error contents and steps to take
20	Syntax error	Stop Auto clear	A program with a syntax error has been written. Switch to the PROG. mode and correct the error.
21	Duplicated use	Stop Auto clear	<p>The same relay is used multiple times in OT instructions, etc. Switch to the PROG. mode and correct the error. Or, set the duplicated output to "enable" in the CPU configuration.</p> <p>Applicable devices and instructions are as follows.</p> <ul style="list-style-type: none"> Operation device (X, Y, R, L), timer/counter instruction, SSTP instruction
22	Not paired	Stop Auto clear	<p>For instructions which must be used in a pair, one instruction is either missing or in an incorrect position. Switch to the PROG. mode and enter the two instructions which must be used in a pair in the correct positions.</p> <p>Applicable instructions and cases are as follows.</p> <ul style="list-style-type: none"> MC and MCE are not paired LBLs corresponding to LOOP and JP are not located in the same area (normal program area / same sub-routine area / same interrupt program area) There are no sub-routines corresponding to CALL and FCALL There is no STPE corresponding to SSTP
24	Program area error	Stop Auto clear	<p>An instruction that can only be executed in a specified area is written in another location. Switch to the PROG. mode and correct the error.</p> <p>Applicable instructions and cases are as follows.</p> <ul style="list-style-type: none"> LBL, LOOP, JP, MC and MCE are in the stepladder area MC is nested in more than 16 layers CNDE is outside the normal program area EDPB is outside the free area ED is inside the sub-routine area or the interrupt area SBL is outside the free area or the sub-routine area An interrupt program is outside the free area or the interrupt program area RET is outside the sub-routine area IRET is outside the interrupt program area

8.1 CPU Unit Specifications

Code	Name	Operation	Error contents and steps to take
			<ul style="list-style-type: none"> STPE is outside the stepladder area
25	High-level instruction execution combination error	Stop Auto clear	In the program, high-level instructions, which execute in every scan and at the leading edge of the trigger, are programmed to be triggered by one contact. Correct the program so that the high-level instructions executed in every scan and only at the leading edge are triggered separately.
27	Compile memory full error	Stop Auto clear	The program is too large to compile in the program memory. Switch to the PROG. mode and reduce the total number of steps for the program.

(Note 1) For errors where "Auto clear" is indicated in the Operation column, error clearance is executed when power supply is cut off, or when the unit is set to the RUN mode again after the status has been corrected.

Error codes 40 to 79

Code	Name	Operation	Error contents and steps to take
40	Copy failure Cover open	Stop Auto clear	The card cover is open and the copy process cannot be executed. Close the cover.
41	Copy failure No SD card	Stop Auto clear	Copying cannot be executed because there is no SD memory card. Insert an SD memory card.
42	Copy failure SD card reading error (FAT/File error)	Stop Auto clear	Copying cannot be executed because the SD memory card is damaged. Insert a normal SD memory card.
43	Copy failure No file	Stop Auto clear	Copying cannot be executed because there is no file in the SD memory card. Check if a project file is saved in the card.
44	Copy failure Password inconsistency (limited distribution function)	Stop Auto clear	Copying cannot be executed because the password for the project file saved in the SD memory card is not consistent with the password for the execution project saved in the built-in ROM. Check the password settings.
45	Copy failure Incorrect project data	Stop Auto clear	Copying cannot be executed because an error has been identified in project data saved in the SD memory card. Check the project data.
50	SD operation impossible Cover open	Stop Auto clear	SD memory card operation cannot be executed because the card cover is open. Close the cover.
51	SD operation impossible No SD card	Stop Auto clear	SD memory card operation cannot be executed because there is no SD memory card. Insert an SD memory card.
52	SD operation impossible SD card reading error (FAT/File error)	Stop Auto clear	SD memory card operation cannot be executed because the SD memory card is damaged. Insert a normal SD memory card.
53	SD operation impossible No file	Stop Auto clear	SD memory card operation cannot be executed because there is no file in the SD memory card. Check if a project file is saved in the card.
54	SD operation impossible Password inconsistency (limited distribution function)	Stop Auto clear	SD memory card operation cannot be executed because the password for the project file saved in the SD memory card is not consistent with the password for the execution project saved in the built-in ROM. Check the password settings.

Code	Name	Operation	Error contents and steps to take
55	SD operation impossible Incorrect project data	Stop Auto clear	SD memory card operation cannot be executed because an error has been identified in project data saved in the SD memory card. Check the project data.
60	Duplicated or excessive collected I/O maps	Stop Auto clear	There is an error with I/O maps that have been collected in the CPU unit. Verify the registered data.
61	Duplicated or excessive registered I/O maps	Stop Auto clear	There is an error with I/O maps that have been registered in the CPU unit. Verify the registered data.
62	Interrupt error 1	Stop Auto clear	There may be a hardware problem. Please contact your dealer.
63	Interrupt error 2	Stop Auto clear	The interrupt program definition by INTPG instruction may be disappeared by rewriting during RUN. Check the program.
79	Operation congestion error	Stop	Occurs in the simulation function of FPWIN GR7 or FPWIN Pro. It is generated when the number of instruction executions exceeds 16,777,215 per one cycle. Reduce the number of instructions to be executed in one scan. Reduce the number of loops or shorten the program.

(Note 1) For errors where "Auto clear" is indicated in the Operation column, error clearance is executed when power supply is cut off, or when the same operation is executed again after the status has been corrected.

Error codes 80 to 119

Code	Name	Operation	Error contents and steps to take
80	Unit alarm occurrence	Select (Default stop)	An alarm has occurred in an attached unit. Check the status of the unit in the slot number saved in the system data register SD1.
81	Unit error occurrence	Select (Default stop)	An error has occurred in an attached unit. Check the status of the unit in the slot number saved in the system data register SD2. Verify the configuration settings.
82	Unit verification error detection	Select (Default stop)	Unit wiring condition has changed compared to that at the time of power-up. Check the status of the unit in the slot number saved in the system data register SD4.
83	Registered unit number inconsistency	Select (Default stop)	The number of units differs from that registered in the I/O map. Check the I/O map and the attachment status.
84	Unit initial completion waiting timeout	Select (Default stop)	An error has occurred during the unit initial operation. Check the unit status.
85	Unit configuration data inconsistency with applicable unit	Select (Default stop)	The unit's configuration data is not consistent with the applicable unit. Check the I/O map and the configuration data.
86	Operation error	Select (Default stop)	An operation error has occurred. Reasons for an operation error vary by instruction. Refer to the Instruction Manual, etc. and correct the appropriate reasons. PB and address where an operation error has occurred are saved in the system data registers SD7 to SD12.
87	Communication error occurrence	Select (Default stop)	Communication is not working with the slave unit. Check if the slave unit is in an operable state and also check if the slave unit is correctly connected.

8.1 CPU Unit Specifications

Code	Name	Operation	Error contents and steps to take
88	Error occurrence in the input/output unit installed on the remote slave	Select (Default stop)	Communication is not working with the slave unit. Check if the slave unit is in an operable state and also check if the slave unit is correctly connected.
89	Slave unit connection wait timeout	Select (Default stop)	Communication is not working with the slave unit. Check if the slave unit is in an operable state and also check if the slave unit is correctly connected.
90	Slave unit refresh synchronization timeout	Select (Default stop)	Communication is not working with the slave unit. Check if the slave unit is in an operable state and also check if the slave unit is correctly connected.
100	Bus current error	Select (Default continue)	A bus error is probable. Please contact your dealer.
104	Service power supply current error	Select (Default continue)	An error has been detected in the GT power supply terminal part. Check if it is correctly connected.
105	CPU temperature error 1	Select (Default continue)	A temperature rise has been detected in hardware. In general, select "Continue".
106	CPU temperature error 2	Select (Default continue)	
118	Built-in LAN unit error	Continue	Check the details in the system history data.
119	Ethernet communication system error	Continue	It is possible that an illegal packet is received. Check if an illegal packet is sent to FP7. Restart the power supply if this error occurs.

(Note 1) For errors where "Select" is indicated in the Operation column, either "Stop" or "Continue" can be selected in the configuration menu.

Error codes 120 to 129, 132 to 135, and 1000 to 2999

Code	Name	Operation	Error contents and steps to take
120	RTC data error	Continue	An error has been detected in clock data of the calendar timer.
121	Power supply unit lifetime warning	Continue	It is alarmed that the power supply unit is close to its lifetime. Replace the power supply unit.
122	Battery voltage decline	Continue	Voltage of the optional battery has declined. Replace the battery. If no battery is used, disable battery error alarm in the CPU configuration.
123	Gold capacitor voltage decline	Continue	It is alarmed that voltage of the built-in gold capacitor of the CPU unit has declined. Charge the CPU unit.
124	SNTP time acquisition failure	Continue	Acquisition of time data has failed during time synch via LAN port.
125	Logging settings mismatch	Continue	An error has been detected in logging data settings.
126	Logging data error	Continue	An error has been detected in logging data.
127	Comment data error	Continue	An error has been detected in comment data.
128	Duplicated PLC link area error	Continue	One of the following areas is duplicated among the PLC link network devices.

Code	Name	Operation	Error contents and steps to take
			<ul style="list-style-type: none"> • PLC link area • Automatic transmission PLC link operation state • Error information
129	Memory configuration inconsistency	Continue	An inconsistency was detected in the memory configuration.
132	Operation history buffer error	Continue	There is an error in the operation history buffer.
133	Operation history configuration data error	Continue	There is an error in the operation history configuration data. Check the operation history settings.
134	Operation history data error (when loading settings from the SD card)	Continue	There is an error in the operation history data saved in the SD card.
135	Power supply unit lifetime data read error	Continue	There is a memory error in the power supply unit. Please contact your dealer.
1000-1999	Error by ERR instruction	Stop	An error as specified by ERR instruction in the user program has occurred. Take action according to the specified detection conditions.
2000-2999	Error by ERR instruction	Continue	

(Note 1) If an RTC data error is detected, the date is set to "April 1, 2012".

Error codes for SCU unit and built-in SCU unit

Error code	Name
0x7001	Mode setting/changing error
0x7002	Parameter setting error
0x7003	Sent data amount error
0x7005	Communication cassette verification error
0x7006	PLC link registration exceeded
0x7007	Duplicated PLC link area block number
0x70E0	Configuration data version error

Warning codes for SCU unit and built-in SCU unit

Warning code	Name
0x7011	Received data error
0x7012	Receive buffer overflow
0x7013	Receive buffer FULL error
0x7021	Transmission error
0x7022	Duplicated unit number
0x7023	Duplicated PLC link area
0x7024	PLC link error
0x7025	Maximum unit number inconsistency

8.1 CPU Unit Specifications

Warning code	Name
0x7026	PLC link stop state

Error codes for built-in ET-LAN unit

Error code	Name
8001H	Local node IP address setting error
8002H	Subnet mask setting error
8003H	Default router (gateway) IP address setting error
8004H	DNS address setting error
8009H	Initial processing error
8014H	Address setting error
8015H	Operation mode setting error

Warning codes for built-in ET-LAN unit

Warning code	Name
8005H	DHCP acquisition result error (Previously: Local node IP address acquisition error)
8006H	DHCP (IPv4) error
8007H	DHCP (IPv6) error
8008H	Router (IPv6) error
800AH	Duplicated address
800CH	Static route setting error
8011-8013H	OPEN request error
8016-8017H	Name resolution failure
8018H	Connection establishment timeout
8021-8026H	Transmission error
8027-8029H	Reception error
802AH	Packet processing error
8031H	SNTP time acquisition error
8032H	
8041H	Connection unused time elapsed
8042H	Ethernet cable disconnection

8.2 Power Supply Unit Specifications

8.2.1 General Specifications

Items	Description	
Operating ambient temperature	0 to +55°C	
Operating ambient humidity	10 to 95%RH (at 25°C, no-condensing)	
Storage ambient temperature	-40 to +70°C	
Storage ambient humidity	10 to 95%RH (at 25°C, no-condensing)	
Breakdown voltage	All the AC inputs ↔ All the DC outputs	2300 V AC, 1 minute ^(Note 1)
	All the AC inputs ↔ Protective earth terminals	1500 V AC, 1 minute ^(Note 1)
	All the AC inputs ↔ All the alarms	2300 V AC, 1 minute ^(Note 1)
Insulation resistance (Test voltage: 500 V DC)	All the AC inputs ↔ All the DC outputs	100 MΩ or larger
	All the AC inputs ↔ Protective earth terminals	
	All the AC inputs ↔ All the alarms	
Vibration resistance	Conforming to JIS B 3502 and IEC 61131-2	
	5 to 8.4 Hz, 3.5 mm single amplitude	
	8.4 to 150 Hz, acceleration of 9.8 m/s ² 10 sweeps each in X, Y and Z directions (1 octave/min)	
Shock resistance	Conforming to JIS B 3502 and IEC 61131-2	
	147 m/s ² , three times each in the X, Y, Z directions	
Noise resistance	1,500 V [P-P], pulse width of 50 ns/1 μs (by noise simulator)	
Environment	Free from corrosive gases and excessive dust.	
Overvoltage category	Category II	
Pollution degree	Pollution degree 2	
Weight (main unit)	AFP7PSA1: approx. 240g	
	AFP7PSA2: approx. 290g	

(Note 1) Cutoff current: 10 mA (factory default setting)

8.2.2 Performance Specifications

Description		Rated voltage	
		AFP7PSA1	AFP7PSA2
Input	Rated input voltage	100 to 240 V AC	
	Input voltage amplitude range	85 to 264 V AC	
	Rated frequency	50 / 60 Hz	
	Frequency range	47 to 63 Hz	

8.2 Power Supply Unit Specifications

Description		Rated voltage	
Product no.		AFP7PSA1	AFP7PSA2
	Phases	Single-phase	
	Input current	0.75A or less	1.25A or less
	Inrush current	40 A (0-P) or less; Cold start	
	Leakage current	0.75 mA or less between AC input and protective earth terminals	
	Momentary power drop time	10 ms or more	
Output	Rated output current ^(Note 1)	24V DC, 1A	24V DC, 1.8A
	Overcurrent protection ^(Note 2)	On	
Remaining service life counting function		Not available	On
Guaranteed lifetime		27,000 hours (+55°C)	
Fuse		Built-in (Replacement is not available)	

(Note 1) Use the unit within the rated output current.

(Note 2) Oscillation is stopped during protected operation. To recover, turn off the input and then on again. Wait at least 180 seconds before turning the input on again.

8.2.3 Alarm Output Specifications

Description	Rated voltage
Contact capacity	1A 30V DC
Alarm contact operations	Contact OFF at CPU alarm occurrence

8.3 Dimensions

8.3.1 Power Supply Unit

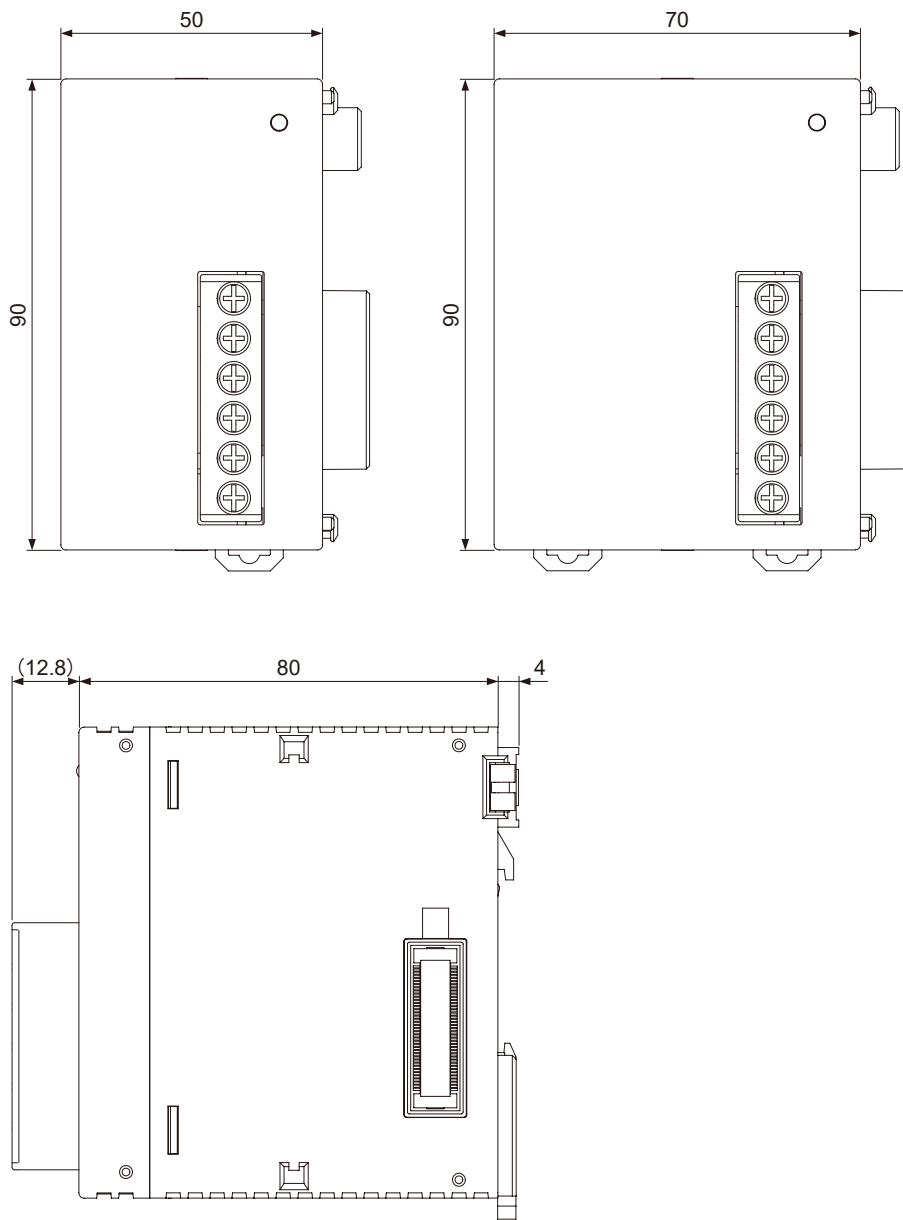

(Unit: mm)

8.3 Dimensions

8.3.2 CPU Unit (CPS4R*/CPS3R*)

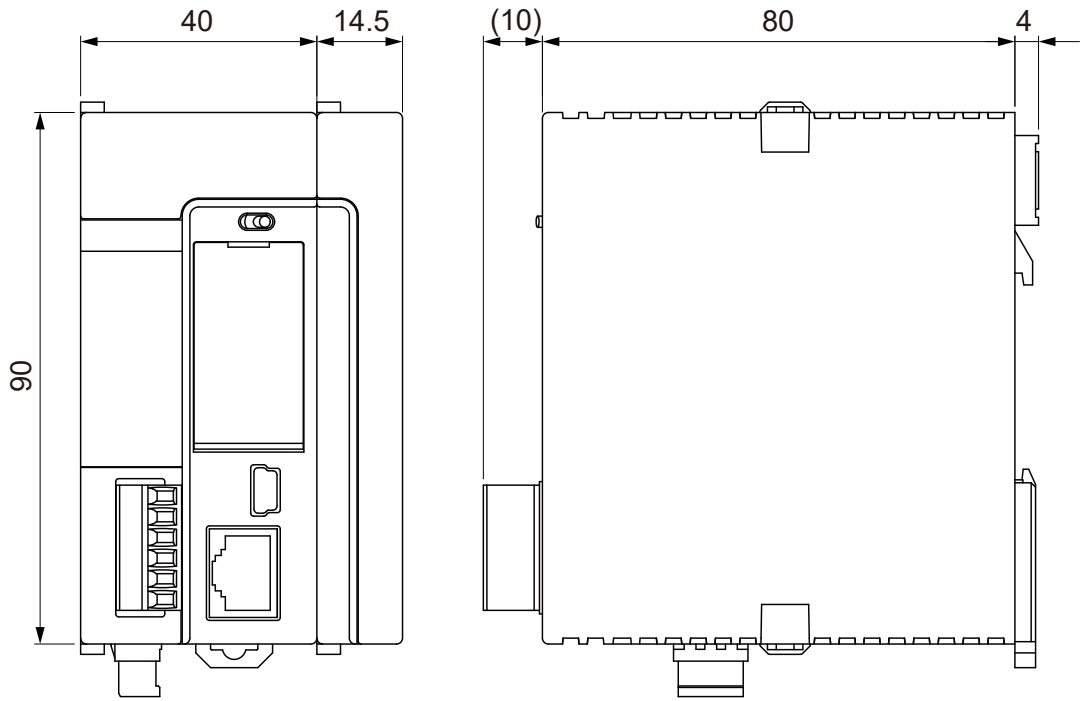

(Unit: mm)

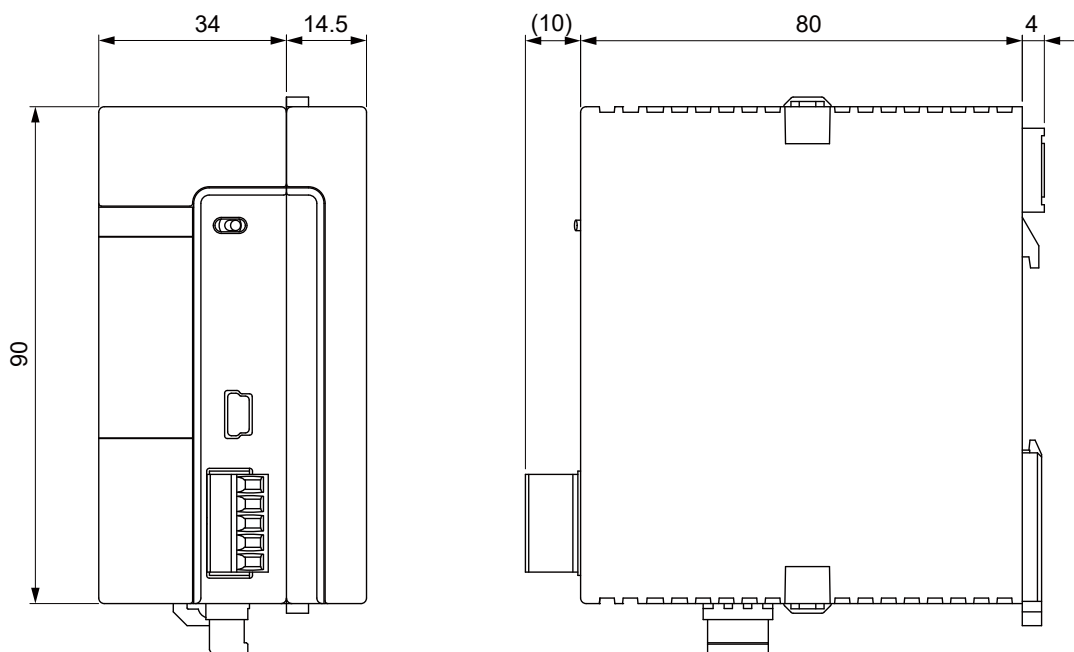
8.3.3 CPU Unit (CPS2R)

(Unit: mm)

8.3.4 Terminal Block Type Unit (1)

Applicable units: Digital I/O unit (16-point), Analog input unit, Analog output unit

8.3 Dimensions

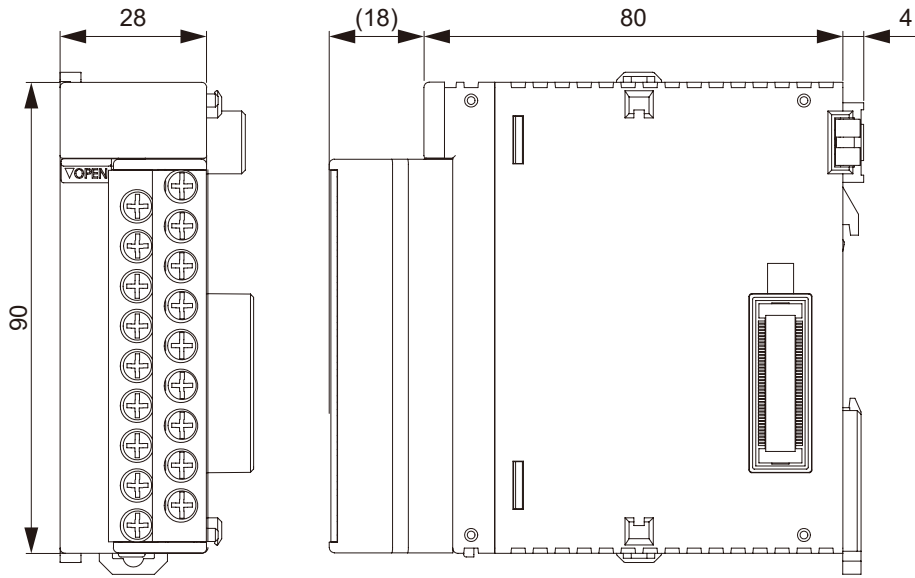

(Unit: mm)

8.3.5 Terminal Block Type Unit (2)

Applicable units: Thermocouple multi-analog input unit, RTD input unit

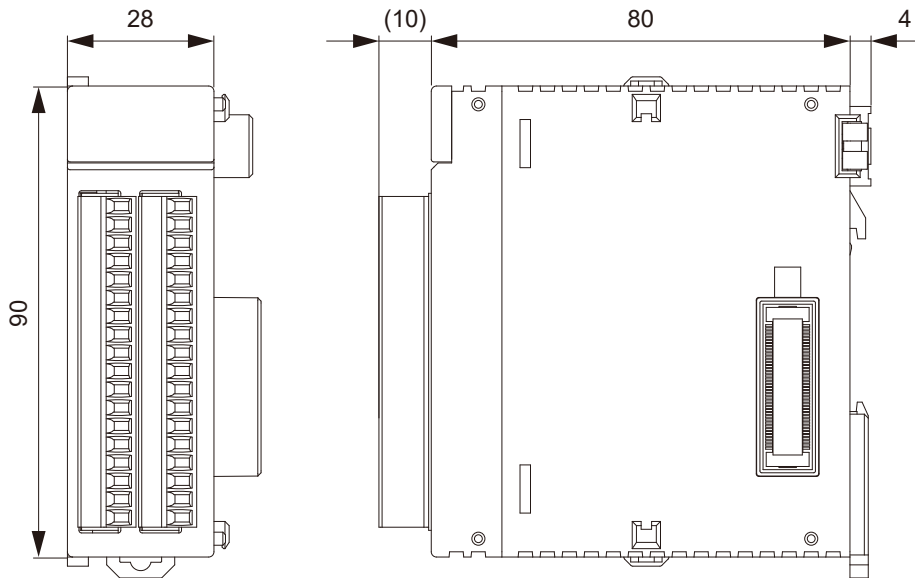

(Unit: mm)

8.3.6 Connector Type Unit

(a)	Digital I/O unit (32-point), High-speed counter unit (2-ch), Pulse output unit (2-axis), Positioning unit (2-axis), Expansion master unit
(b)	Digital I/O unit (64-point), High-speed counter unit (4-ch), Pulse output unit (4-axis), Positioning unit (4-axis), Expansion slave unit

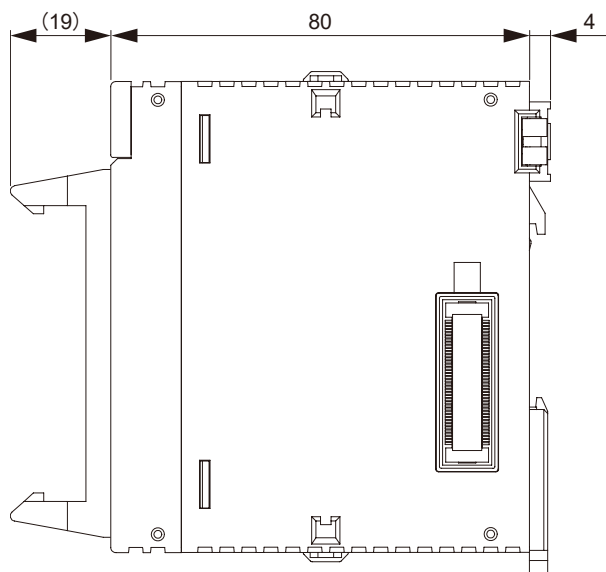
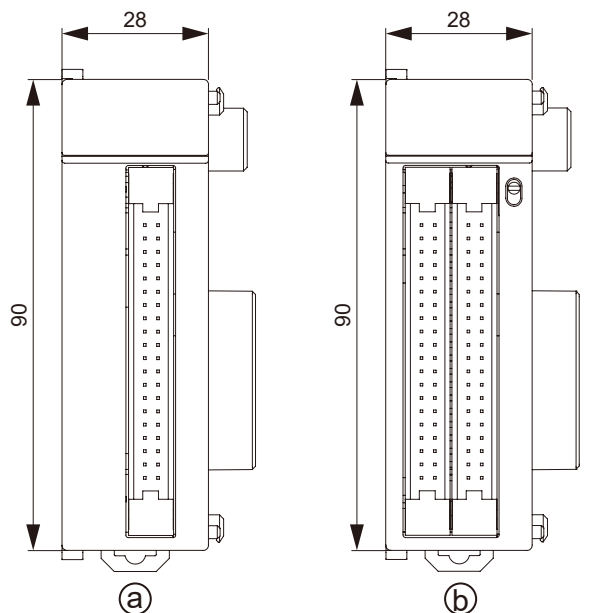

(Unit: mm)

(Note 1) The expansion slave unit is equipped with a power supply connector.

8.3 Dimensions

8.3.7 Serial Communication Unit

The drawing below shows the state that two communication cassettes are attached.

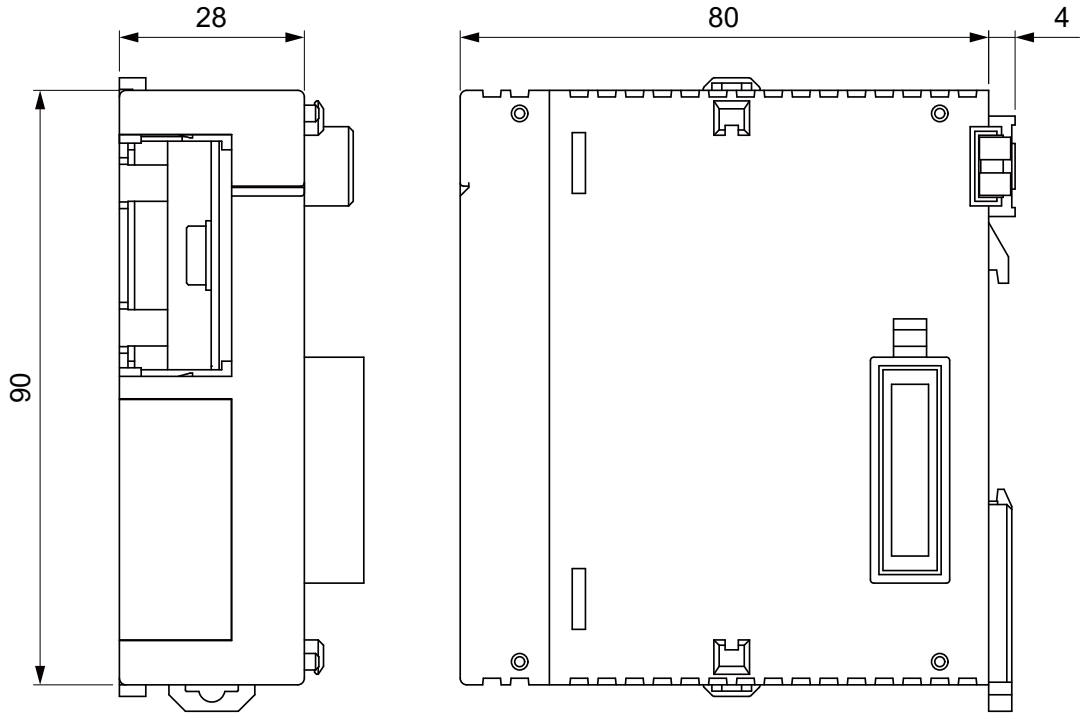

(Unit: mm)

8.3.8 Multi-wire Link Unit

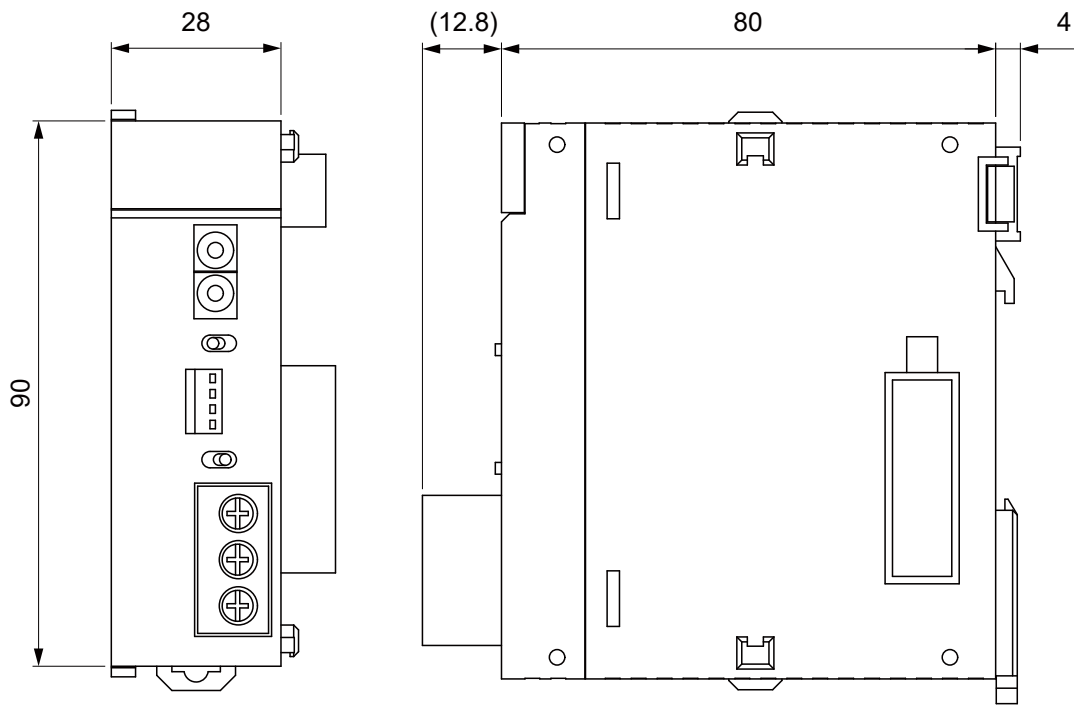

(Unit: mm)

8.3 Dimensions

8.3.9 PHL5 Master Unit

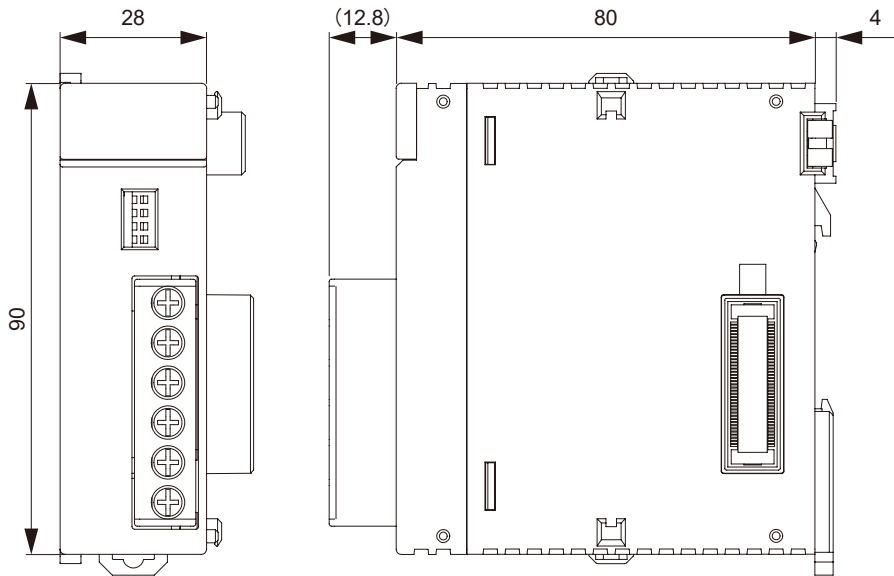

(Unit: mm)

8.3.10 End Unit

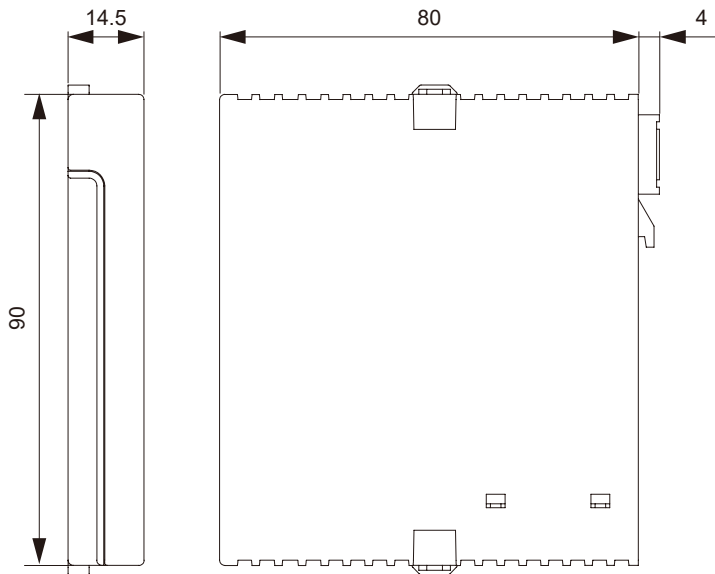

(Unit: mm)

8.3.11 Figures of Unit Combination

■ When the power supply unit AFP7PSA1 is used

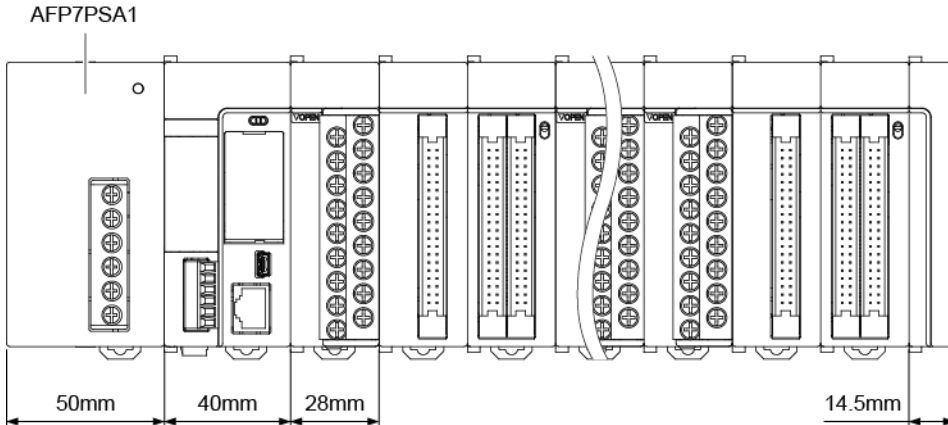

FP7 system full width

= Power supply unit AFP7PSA1 + CPU unit + n devices (input/output units and intelligent units) + End unit

= 50 mm + 40 mm + (n x 28 mm) + 14.5 mm

= 104.5 mm + (n x 28 mm)

■ When the power supply unit AFP7PSA2 is used

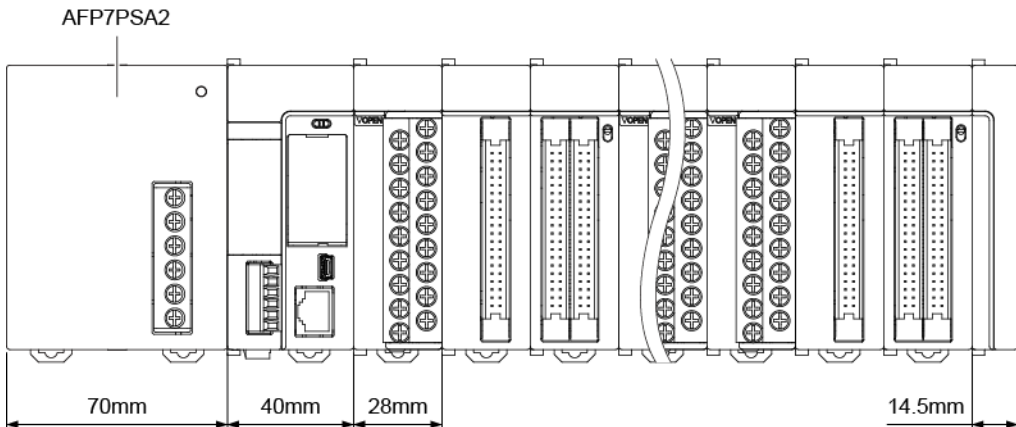

FP7 system full width

= Power supply unit AFP7PSA2 + CPU unit + n devices (input/output units and intelligent units) + End unit

= 70 mm + 40 mm + (n x 28 mm) + 14.5 mm

= 124.5 mm + (n x 28 mm)

8.3 Dimensions

■ When no power supply unit is used

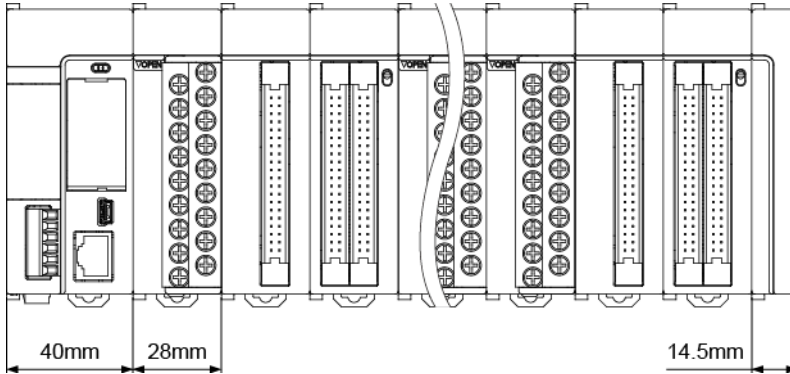

FP7 system full width

= CPU unit + n devices (input/output units and intelligent units) + End unit

= 40 mm + (n x 28 mm) + 14.5 mm

= 54.5 mm + (n x 28 mm)

Note

- The size of the CPU unit is 6 mm shorter when using CPS2R.

Record of changes

Manual number can be found at the bottom of the cover page.

Date	Manual No.	Record of Changes
Mar. 2013	WUME-FP7CPUH-01	1st Edition
-	-	- <ul style="list-style-type: none"> Added restriction when 24 V DC power is supplied to the CPU unit (1.2, 8.1). Other, corrected errors.
Jun. 2013	WUME-FP7CPUH-02	2nd Edition <ul style="list-style-type: none"> Added models. CPU units AFP7CPS3E and AFP7CPS3 Input/output units AFP7Y32P, AFP7Y64P and AFP7XY64D2P Corrected errors.
Oct. 2013	WUME-FP7CPUH-03	3rd Edition <ul style="list-style-type: none"> Added models. High-speed counter unit
Dec. 2013	WUME-FP7CPUH-04	4th Edition <ul style="list-style-type: none"> Added models. Serial communication unit AFP7NSC Communication cassette (Ethernet type) AFP7CCET1
-	-	4th Edition <ul style="list-style-type: none"> Added models. CPU unit: AFP7CPS41*, AFP7CPS31* Pulse output unit: AFP7PG02*, AFP7PG04* Function cassette <ul style="list-style-type: none"> Analog I/O cassette: AFP7FCA21 Analog input cassette: AFP7FCAD2 Thermocouple input cassette: AFP7FCTC2 Corrected errors.
Aug. 2014	WUME-FP7CPUH-05	5th Edition <ul style="list-style-type: none"> Added models. Thermocouple multi-analog input unit: AFP7TC8 RTD input unit: AFP7RTD8 Analog input unit (8ch): AFP7AD8 Expansion master unit: AFP7EXPM Expansion slave unit: AFP7EXPS Changes related to the FPWINGR7 GUI changes. Corrected errors.
Jun. 2015	WUME-FP7CPUH-06	6th Edition <ul style="list-style-type: none"> Added models.

Date	Manual No.	Record of Changes
		CPU unit: AFP7CPS21
Nov. 2019	WUME-FP7CPUH-07	7th Edition <ul style="list-style-type: none"> ● Added notes about SD card covers. ● Added error/warning codes. ● Corrected errors.
-	-	- <ul style="list-style-type: none"> ● Corrected errors.
Feb. 2021	WUME-FP7CPUH-08	8th Edition <ul style="list-style-type: none"> ● Revised due to the discontinuation of Panasonic SD memory cards and SDHC memory cards.
Nov. 2022	WUME-FP7CPUH-09	9th Edition <ul style="list-style-type: none"> ● Changed product type following FP7 update. ● Changed the manual format.
Apr. 2023	WUME-FP7CPUH-13	13th Edition <ul style="list-style-type: none"> ● Added Multi-wire Link Unit. ● Added notes for when operating the SD memory card. ● Added error/warning codes. ● Corrected errors.
Nov. 2023	WUME-FP7CPUH-14	14th Edition <ul style="list-style-type: none"> ● Added Open Source Software License. ● Added precautions concerning SD memory card operation ● Added error/warning codes. ● Corrected errors
Apr. 2024	WUME-FP7CPUH-15	15th Edition <ul style="list-style-type: none"> ● Change in Corporate name.

Order Placement Recommendations and Considerations

The Products and Specifications listed in this document are subject to change (including specifications, manufacturing facility and discontinuing the Products) as occasioned by the improvements of Products. Consequently, when you place orders for these Products, Panasonic Industry Co., Ltd. asks you to contact one of our customer service representatives and check that the details listed in the document are commensurate with the most up-to-date information.

[Safety precautions]

Panasonic Industry Co., Ltd. is consistently striving to improve quality and reliability. However, the fact remains that electrical components and devices generally cause failures at a given statistical probability. Furthermore, their durability varies with use environments or use conditions. In this respect, check for actual electrical components and devices under actual conditions before use. Continued usage in a state of degraded condition may cause the deteriorated insulation. Thus, it may result in abnormal heat, smoke or fire. Carry out safety design and periodic maintenance including redundancy design, design for fire spread prevention, and design for malfunction prevention so that no accidents resulting in injury or death, fire accidents, or social damage will be caused as a result of failure of the Products or ending life of the Products.

The Products are designed and manufactured for the industrial indoor environment use. Make sure standards, laws and regulations in case the Products are incorporated to machinery, system, apparatus, and so forth. With regard to the mentioned above, confirm the conformity of the Products by yourself.

Do not use the Products for the application which breakdown or malfunction of Products may cause damage to the body or property.

- i) usage intended to protect the body and ensure security of life
- ii) application which the performance degradation or quality problems, such as breakdown, of the Products may directly result in damage to the body or property

It is not allowed the use of Products by incorporating into machinery and systems indicated below because the conformity, performance, and quality of Products are not guaranteed under such usage.

- i) transport machinery (cars, trains, boats and ships, etc.)
- ii) control equipment for transportation
- iii) disaster-prevention equipment / security equipment
- iv) control equipment for electric power generation
- v) nuclear control system
- vi) aircraft equipment, aerospace equipment, and submarine repeater
- vii) burning appliances
- viii) military devices
- ix) medical devices (except for general controls)
- x) machinery and systems which especially require the high level of reliability and safety

[Acceptance inspection]

In connection with the Products you have purchased from us or with the Products delivered to your premises, please perform an acceptance inspection with all due speed and, in connection with the handling of our Products both before and during the acceptance inspection, please give full consideration to the control and preservation of our Products.

[Warranty period]

Unless otherwise stipulated by both parties, the warranty period of our Products is three years after the purchase by you or after their delivery to the location specified by you. The consumable items such as battery, relay, filter and other supplemental materials are excluded from the warranty.

[Scope of warranty]

In the event that Panasonic Industry Co., Ltd. confirms any failures or defects of the Products by reasons solely attributable to Panasonic Industry Co., Ltd. during the warranty period, Panasonic Industry Co., Ltd. shall supply the replacements of the Products, parts or replace and/or repair the defective portion by free of charge at the location where the Products were purchased or delivered to your premises as soon as possible.

However, the following failures and defects are not covered by warranty and we are not responsible for such failures and defects.

- (1) When the failure or defect was caused by a specification, standard, handling method, etc. which was specified by you.
- (2) When the failure or defect was caused after purchase or delivery to your premises by an alteration in construction, performance, specification, etc. which did not involve us.
- (3) When the failure or defect was caused by a phenomenon that could not be predicted by the technology at purchasing or contracted time.
- (4) When the use of our Products deviated from the scope of the conditions and environment set forth in the instruction manual and specifications.
- (5) When, after our Products were incorporated into your products or equipment for use, damage resulted which could have been avoided if your products or equipment had been equipped with the functions, construction, etc. the provision of which is accepted practice in the industry.
- (6) When the failure or defect was caused by a natural disaster or other force majeure.
- (7) When the equipment is damaged due to corrosion caused by corrosive gases etc. in the surroundings.

The above terms and conditions shall not cover any induced damages by the failure or defects of the Products, and not cover your production items which are produced or fabricated by using the Products. In any case, our responsibility for compensation is limited to the amount paid for the Products.

[Scope of service]

The cost of delivered Products does not include the cost of dispatching an engineer, etc. In case any such service is needed, contact our sales representative.

Panasonic Industry Co., Ltd.

(MEMO)

(MEMO)

Panasonic Industry Co., Ltd.

1006, Oaza Kadoma, Kadoma-shi, Osaka 571-8506, Japan
<https://industry.panasonic.com/>

Please visit our website for inquiries and about our sales network.

© Panasonic Industry Co., Ltd. 2013-2024

April, 2024

WUME-FP7CPUH-15