

PROGRAMMABLE CONTROLLER
FP0R

User's Manual

Safety Precautions

Observe the following notices to ensure personal safety or to prevent accidents.
To ensure that you use this product correctly, read this User's Manual thoroughly before use.
Make sure that you fully understand the product and information on safety.
This manual uses two safety flags to indicate different levels of danger.

WARNING

If critical situations that could lead to user's death or serious injury is assumed by mishandling of the product.

- Always take precautions to ensure the overall safety of your system, so that the whole system remains safe in the event of failure of this product or other external factor.
- Do not use this product in areas with inflammable gas. It could lead to an explosion.
- Exposing this product to excessive heat or open flames could cause damage to the lithium battery or other electronic parts.

CAUTION

If critical situations that could lead to user's injury or only property damage is assumed by mishandling of the product.

- To prevent excessive exothermic heat or smoke generation, use this product at the values less than the maximum of the characteristics and performance that are assured in these specifications.
- Do not dismantle or remodel the product. It could cause excessive exothermic heat or smoke generation.
- Do not touch the terminal while turning on electricity. It could lead to an electric shock.
- Use the external devices to function the emergency stop and interlock circuit.
- Connect the wires or connectors securely.
The loose connection could cause excessive exothermic heat or smoke generation.
- Do not allow foreign matters such as liquid, flammable materials, metals to go into the inside of the product. It could cause excessive exothermic heat or smoke generation.
- Do not undertake construction (such as connection and disconnection) while the power supply is on. It could lead to an electric shock.

Copyright / Trademarks

- This manual and its contents are copyrighted.
- You may not copy this manual, in whole or part, without written consent of Panasonic Industrial Devices SUNX Co., Ltd.
- Windows is a registered trademark of Microsoft Corporation in the United States and other countries.
- All other company names and product names are trademarks or registered trademarks of their respective owners.

Table of Contents

Before You Start

Programming Tool Restrictions

When Using FP0 Programs

1. Functions and Restrictions of the Unit	1-1
1.1 Unit Types.....	1-2
1.2 Restrictions on Unit Combination	1-7
1.3 Programming Tools	1-8
2. Specifications and Functions of Control Unit	2-1
2.1 Part Names and Functions	2-2
2.2 Input and Output Specifications	2-4
2.3 Terminal layout diagrams	2-7
2.4 Functions of T32 Control Unit	2-10
3. Expansion	3-1
3.1 Expansion Method	3-2
3.2 Part Names and Functions	3-3
3.3 Input and Output Specifications.....	3-4
3.4 Terminal layout diagram	3-7
4. I/O Allocation	4-1
4.1 I/O Allocation	4-2
4.2 I/O Allocation for FP0R Control Unit.....	4-3
4.3 I/O Numbers of FP0/FP0R Expansion Unit	4-4
5. Installation and Wiring.....	5-1
5.1 Installation.....	5-2
5.2 Wiring of Power Supply	5-6
5.3 Wiring of Input and Output.....	5-8
5.4 Wiring of MIL Connector Type	5-11
5.5 Wiring of Terminal Block Type	5-13
5.6 Wiring of Molex Connector Type	5-15
5.7 Wiring of COM Port.....	5-16
5.8 Safety Measures.....	5-20
6. Preparation of USB Port.....	6-1
6.1 USB Connection	6-2
7. Communication	7-1
7.1 Functions and Types	7-2
7.2 Communicaton Port Type	7-4
7.3 Communication Specifications.....	7-5
7.4 Computer Link	7-7
7.5 General-purpose Serial Communication.....	7-18
7.6 PC(PLC) link Function	7-34
7.7 MODBUS RTU Communication.....	7-49

8. High-speed Counter, Pulse Output and PWM Output Functions	8-1
8.1 Overview of Each Functions.....	8-3
8.2 Function Specifications and Restricted Items	8-5
8.3 High-speed Counter Function	8-10
8.4 Pulse Output Function.....	8-20
8.5 PWM Output Function	8-58
9. Security Functions	9-1
9.1 Password Protect Function	9-2
9.2 Upload Protection.....	9-8
9.3 Setting Function for FP Memory Loader	9-9
9.4 Table of Security Settings/Cancel	9-12
10. Other Functions	10-1
10.1 P13 (PICWT) Instruction	10-2
10.2 Sampling Trance Function	10-3
10.3 Time Constant Processing	10-6
11. Self-Diagnostic and Troubleshooting	11-1
11.1 Self-Diagnostic function.....	11-2
11.2 Troubleshooting.....	11-3
11.3 Operation Errors.....	11-9
12. Precautions During Programming.....	12-1
12.1 Use of Duplicated Output	12-2
12.2 Handling Index Registers	12-4
12.3 Instructions of Leading Edge Detection Method.....	12-6
12.4 Precautions for Programming.....	12-9
12.5 Rewrite Function During RUN	12-10
12.6 Processing During Forced Input and Output	12-15
13. Specifications.....	13-1
13.1 Table of Specifications	13-2
13.2 I/O Number Allocation	13-8
13.3 Relays, Memory Areas and Constants.....	13-10
13.4 Power Supply Unit and I/O Link Unit Specifications.....	13-11
14. Dimensions and Others.....	14-1
14.1 Dimensions.....	14-2
14.2 Cable/Adapter Specifications	14-7

15. Appendix 15-1
15.1 System Registers/Special Internal Relays/Special Data Registers 15-2
15.2 Table of Basic Instructions..... 15-39
15.3 Table of High-level Instructions 15-47
15.4 Table of Error codes 15-67
15.5 MEWTOCOL-COM Communication Commands..... 15-80
15.6 Hexadecimal/Binary/BCD 15-81
15.7 ASCII Codes 15-82

Before You Start

Operating environment (Use the unit within the range of the general specifications when installing)

- * Ambient temperature: 0 to +55°C
- * Ambient humidity: 10 to 95 % RH (at 25 °C, non-condensing)
- * For use in pollution Degree 2 environment.
- * Do not use the unit in the following environments.
 - Direct sunlight
 - Sudden temperature changes causing condensation.
 - Inflammable or corrosive gas.
 - Excessive airborne dust, metal particles or saline matter.
 - Benzine, paint thinner, alcohol or other organic solvents or strong alkaline solutions such as ammonia or caustic soda.
 - Direct vibration, shock or direct drop of water.
 - Influence from power transmission lines, high voltage equipment, power cables, power equipment, radio transmitters, or any other equipment that would generate high switching surges.(100 mm or more)

Static electricity

- Do not touch connector pins directly to prevent static electricity from causing damage.
- Always rid yourself of any static electricity before handling this product.

Power supply

- Use a power supply wire that is twisted.
- The unit has sufficient noise immunity against the noise generated on the power line. However, it is recommended to take measures for reducing noise such as using an isolating transformer before supplying the power.
- Allocate an independent wiring for each power supplying line, input/output device and operating device.
- If using a power supply without a protective circuit, power should be supplied through a protective element such as fuse. If an incorrect voltage is directly applied, the internal circuit may be damaged or destroyed.
- Be sure to supply power to a control and an expansion unit from a single power supply. Turning on/off of the power of all the units must be conducted simultaneously.

Power supply sequence

- Have the power supply sequence such that the power supply of the control unit turns off before the power supply for input and output. If the input/output power supply is turned off before the control unit, or if the control unit is not shut off momentarily, the controller detects change of input level, and might conduct an unexpected operation.

Before turning on the power

When turning on the power for the first time, be sure to take the precautions given below.

- When performing installation, check to make sure that there are no scraps of wiring, particularly conductive fragments, adhering to the unit.
- Verify that the power supply wiring, I/O wiring, and power supply voltage are all correct.
- Sufficiently tighten the installation screws and terminal screws.
- Set the mode selector to PROG. mode.

Before entering a program

Be sure to perform a program clear operation before entering a program. Refer to the respective tool software manuals for the details of the operation procedure. (Tool software: FPWIN Pro, FPWIN GR)

Request concerning program storage

To prevent the accidental loss of programs, the user should consider the following measures.

- Drafting of documents

To avoid accidentally losing programs, destroying files, or overwriting the contents of files, documents should be printed out and then saved.

- Specifying the password carefully.

The password setting is designed to avoid programs being accidentally overwritten. If the password is forgotten, however, it will be impossible to overwrite the program even if you want to. Also, if a password is forcibly bypassed, the program is deleted. When specifying the password, note it in the specifications manual or in another safe location in case it is forgotten at some point.

Programming Tool Restrictions

Restrictions on usable programming tools depending on the units.

Type of programming tool		Type of unit
Windows software	FPWIN GR Ver.2	Used (Ver.2.80 or later)
	FPWIN GR Ver.1	Not used
Windows software Conforms to IEC61131-3	FPWIN Pro Ver.6	Used (Ver.6.10 or later)
Handy programming unit (Discontinued product)	AFP1113V2 AFP1114V2	Not used
	AFP1113 AFP1114	Not used
	AFP1111A AFP1112A AFP1111 AFP1112	Not used
	AFP8670 AFP8671	Used (Ver.2.0 or later)



Note:

- In case of using FPWIN GR Ver.1, please purchase upgrade model FPWIN GR Ver.2.
 - FPWIN GR Ver.2 can be upgraded free of charge at our web site.
 - FPWIN Pro Ver.6 can be upgraded free of charge at our web site.
 - The handy programming unit cannot be used.
- Do not download any programs for other units such as FP1 to the FP0R using the handy programming unit.

http://industrial.panasonic.com/ac/e/dl_center/software/

When Using FP0 Programs

The programs used on the existing FP0 can be used on the FP0R in the following 2 cases.

1. Using the programs in the FP0R specifications.

It enables to make maximum use of the performance and functions of the FP0R.

2. Using the programs in the same specifications as the FP0.

It enables to execute the programs in the same specifications as the FP0 (FP0 compatibility mode).

The points to take care when using the FP0 programs on the FP0R are described below in the above 2 cases.

- When using the programs in the FP0R specifications
- When using the programs in the same specifications as the FP0

When using the programs in the FP0R specifications.

As the FP0 programs cannot be used as they are, it is required to change the following 3 items for the FP0 programs before downloading the programs into the FP0R.

1. Change in the model setting

Change the model for the FP0 programs to the one for the FP0R with a tool software.

2. Resetting of system registers

As the system registers will be initialized once the model setting is changed, reset the system registers if necessary.

3. Modification of the programs

Depending on programs, they should be changed according to the specifications of FP0R.

Differences between specifications of FP0 and FP0R effecting program change

Change in data areas	As the size of the data area and the settings of hold and non-hold areas changes, check if the address of the used data memory is correct. The area that has been used as a hold area might be a non-hold area.																												
Change in supported instructions	<p>The following instructions that are supported on the FP0 cannot be used. Replace them with the instructions for the FP0R based on the following description.</p> <table border="0"> <tr> <td>[FP0]</td> <td>[FP0R]</td> </tr> <tr> <td>F144(TRNS) instruction</td> <td>→ F159(MTRN) instruction</td> </tr> <tr> <td>F168(SPD1) instruction</td> <td>→ F171(SPDH), F177(HOME) instructions</td> </tr> <tr> <td>F169(PLS) instruction</td> <td>→ F172 (PLSH) instruction</td> </tr> <tr> <td>F170(PWM) instruction</td> <td>→ F173(PWMH) instruction</td> </tr> </table> <p>As for the following instructions, the specifications change. Modify the programs in accordance with the specifications after the change.</p> <table border="0"> <tr> <td>[FP0]</td> <td>[FP0R]</td> </tr> <tr> <td>F12(ICRD) instruction</td> <td></td> </tr> <tr> <td>Unit of read: 64 words</td> <td>→ Unit of read: 2048 words</td> </tr> <tr> <td>P13(PICWT) instruction</td> <td></td> </tr> <tr> <td>Unit of write: 64 words</td> <td>→ Unit of write: 2048 words</td> </tr> </table>	[FP0]	[FP0R]	F144(TRNS) instruction	→ F159(MTRN) instruction	F168(SPD1) instruction	→ F171(SPDH), F177(HOME) instructions	F169(PLS) instruction	→ F172 (PLSH) instruction	F170(PWM) instruction	→ F173(PWMH) instruction	[FP0]	[FP0R]	F12(ICRD) instruction		Unit of read: 64 words	→ Unit of read: 2048 words	P13(PICWT) instruction		Unit of write: 64 words	→ Unit of write: 2048 words								
[FP0]	[FP0R]																												
F144(TRNS) instruction	→ F159(MTRN) instruction																												
F168(SPD1) instruction	→ F171(SPDH), F177(HOME) instructions																												
F169(PLS) instruction	→ F172 (PLSH) instruction																												
F170(PWM) instruction	→ F173(PWMH) instruction																												
[FP0]	[FP0R]																												
F12(ICRD) instruction																													
Unit of read: 64 words	→ Unit of read: 2048 words																												
P13(PICWT) instruction																													
Unit of write: 64 words	→ Unit of write: 2048 words																												
Change in special internal relays	<p>The addresses of the following special internal relays are changed.</p> <p>High-speed counter control flag</p> <table border="0"> <tr> <td>[FP0]</td> <td>[FP0R]</td> </tr> <tr> <td>R903A: For CH0</td> <td>→ R9110 : For CH0</td> </tr> <tr> <td>R903B: For CH1</td> <td>→ R9111 : For CH1</td> </tr> <tr> <td>R903C: For CH2</td> <td>→ R9112 : For CH2</td> </tr> <tr> <td>R903D: For CH3</td> <td>→ R9113 : For CH3</td> </tr> </table>	[FP0]	[FP0R]	R903A: For CH0	→ R9110 : For CH0	R903B: For CH1	→ R9111 : For CH1	R903C: For CH2	→ R9112 : For CH2	R903D: For CH3	→ R9113 : For CH3																		
[FP0]	[FP0R]																												
R903A: For CH0	→ R9110 : For CH0																												
R903B: For CH1	→ R9111 : For CH1																												
R903C: For CH2	→ R9112 : For CH2																												
R903D: For CH3	→ R9113 : For CH3																												
Change in special data registers	<p>The contents of the following special data registers are changed.</p> <table border="0"> <tr> <td>[FP0]</td> <td>[FP0R]</td> </tr> <tr> <td>DT9052(DT90052):</td> <td>DT90052:</td> </tr> <tr> <td>High-speed counter control flag</td> <td>High-speed counter control flag</td> </tr> <tr> <td>As each 4 bits of the control code for all 4 channels are allocated, write the control code in the area of the corresponding channel.</td> <td>As the areas to write the channel numbers to be changed and the control codes are separated, write the corresponding channel numbers and control codes.</td> </tr> </table> <div style="display: flex; justify-content: space-around; align-items: flex-start;"> <div style="text-align: center;"> <p>bit15 12 11 8 7 4 0</p> <p>DT9052 DT90052</p> <p>For ch3 For ch2 For ch1 For ch0</p> <p>Control codes for each ch</p> </div> <div style="text-align: center;"> <p>bit15 12 11 8 7 4 0</p> <p>DT90052</p> <p>ch specification area Control code</p> </div> </div> <p>The addresses of the following special data registers are changed.</p> <p>Elapsed value of high-speed counter CH0 to CH3</p> <table border="0"> <tr> <td>[FP0]</td> <td>[FP0R]</td> </tr> <tr> <td>DT9044(DT90044)-DT9045(DT90045)</td> <td>→DT90300-DT90301</td> </tr> <tr> <td>DT9048(DT90048)-DT9049(DT90049)</td> <td>→DT90304-DT90305</td> </tr> <tr> <td>DT9104(DT90104)-DT9105(DT90105)</td> <td>→DT90308-DT90309</td> </tr> <tr> <td>DT9108(DT90108)-DT9109(DT90109)</td> <td>→ DT90312-DT90313</td> </tr> </table> <p>Target value of high-speed counter CH0 to CH3</p> <table border="0"> <tr> <td>[FP0]</td> <td>[FP0R]</td> </tr> <tr> <td>DT9046(DT90046)-DT9047(DT90047)</td> <td>→ DT90302-DT90303</td> </tr> <tr> <td>DT9050(DT90050)-DT9051(DT90051)</td> <td>→ DT90306-DT90307</td> </tr> <tr> <td>DT9106(DT90106)-DT9107(DT90107)</td> <td>→ DT90310-DT90311</td> </tr> <tr> <td>DT9110(DT90110)-DT9111(DT90111)</td> <td>→ DT90314-DT90315</td> </tr> </table> <p>Note) The numbers in parentheses are for FP0-T32.</p>	[FP0]	[FP0R]	DT9052(DT90052):	DT90052:	High-speed counter control flag	High-speed counter control flag	As each 4 bits of the control code for all 4 channels are allocated, write the control code in the area of the corresponding channel.	As the areas to write the channel numbers to be changed and the control codes are separated, write the corresponding channel numbers and control codes.	[FP0]	[FP0R]	DT9044(DT90044)-DT9045(DT90045)	→DT90300-DT90301	DT9048(DT90048)-DT9049(DT90049)	→DT90304-DT90305	DT9104(DT90104)-DT9105(DT90105)	→DT90308-DT90309	DT9108(DT90108)-DT9109(DT90109)	→ DT90312-DT90313	[FP0]	[FP0R]	DT9046(DT90046)-DT9047(DT90047)	→ DT90302-DT90303	DT9050(DT90050)-DT9051(DT90051)	→ DT90306-DT90307	DT9106(DT90106)-DT9107(DT90107)	→ DT90310-DT90311	DT9110(DT90110)-DT9111(DT90111)	→ DT90314-DT90315
[FP0]	[FP0R]																												
DT9052(DT90052):	DT90052:																												
High-speed counter control flag	High-speed counter control flag																												
As each 4 bits of the control code for all 4 channels are allocated, write the control code in the area of the corresponding channel.	As the areas to write the channel numbers to be changed and the control codes are separated, write the corresponding channel numbers and control codes.																												
[FP0]	[FP0R]																												
DT9044(DT90044)-DT9045(DT90045)	→DT90300-DT90301																												
DT9048(DT90048)-DT9049(DT90049)	→DT90304-DT90305																												
DT9104(DT90104)-DT9105(DT90105)	→DT90308-DT90309																												
DT9108(DT90108)-DT9109(DT90109)	→ DT90312-DT90313																												
[FP0]	[FP0R]																												
DT9046(DT90046)-DT9047(DT90047)	→ DT90302-DT90303																												
DT9050(DT90050)-DT9051(DT90051)	→ DT90306-DT90307																												
DT9106(DT90106)-DT9107(DT90107)	→ DT90310-DT90311																												
DT9110(DT90110)-DT9111(DT90111)	→ DT90314-DT90315																												

When using the FP0R in the same specifications as FP0

The FP0R supports an operation mode "FP0 compatibility mode". Using this mode enables to use the programs of the FP0 as they are.

In the FP0 compatibility mode, the programs except some programs can operate with the same specifications as the FP0.



Note:

The FP0 compatibility mode is not available for the F32 type.

The speed of arithmetic processing in the FP0 compatibility mode is the same as the FP0R, so the timing for processing the program may differ from the original timing for the FP0 program.

If you want to execute the program in the condition close to the original timing, set a constant scan or insert a program that does not affect the external operation to adjust the timing.

How to use FP0 compatibility mode

Download the programs uploaded from the FP0 or the programs that the model code is created as the FP0, using an applicable programming tool for the FP0R. A confirmation message will be shown on the tool, and the mode will be automatically changed to the FP0 compatibility mode.

Tools supporting FP0 compatibility mode

FPWIN GR Ver. 2.80 or later/FPWIN Pro Ver.6.10 or later

Restrictions on switching to FP0 compatibility mode

For downloading the FP0 programs to the FP0R in the FP0 compatibility mode, the model setting for the FP0 programs should match the model type of the FP0R as the table below.

Model setting for FP0 program	Applicable FP0R model
C10	C10RM, C10RS, C10CRM, C10CRS
C14	C14RM, C14RS, C14CRM, C14CRS
C16	C16T, C16P, C16CT, C16CP
C32	C32T, C32P, C32CT, C32CP
T32	T32T, T32P, T32CT, T32CP

Differences between the specifications of FP0 compatibility mode and FP0

Basically, the FP0 programs do not need to be modified to activate the FP0 programs in the FP0 compatibility mode, however, as for the following items, the specifications are different. Check the contents, and change the programs if necessary.

1. P13(PICWT) instruction specifications - EEPROM(FROM) write instruction

The execution time of this instruction differs. Depending on the number of write blocks, the execution time may be longer or shorter.

No. of write blocks (No. of words)	FP0	FP0 compatibility mode
1 block (64 words)	Approx. 5ms	Approx. 100ms
2 blocks (128 words)	Approx. 10ms	Approx. 100ms
4 blocks (256 words)	Approx. 20ms	Approx. 100ms
8 blocks (512 words)	Approx. 40ms	Approx. 100ms
16 blocks (1024 words)	Approx. 80ms	Approx. 100ms
32 blocks (2048 words)	Approx. 160ms	Approx. 100ms
33 blocks (2112 words)	Approx. 165ms	Approx. 200ms
41 blocks (2624 words)	Approx. 205ms	Approx. 200ms
64 blocks (4096 words)	Approx. 320ms	Approx. 200ms
96 blocks (6144 words)	Approx. 480ms	Approx. 300ms
256 blocks (16320 words)	Approx. 800ms	Approx. 800ms

2. F170(PWM) instruction specifications - PWM output instruction

The settable frequencies differ. Especially, the setting for the low frequency band cannot be specified.

Setting	FP0		FP0 compatibility mode	
	Frequency (Hz)	Cycle (ms)	Frequency (Hz)	Cycle (ms)
H11	1000	1.0	1000	1
H12	714	1.4	750	1.3
H13	500	2.0	500	2
H14	400	2.5	400	2.5
H15	200	5.0	200	5
H16	100	10.0	100	10
H0	38	26.3	40	25
H1	19	52.6	20	50
H2	9.5	105.3	10	100
H3	4.8	208.3	6	166.7
H4	2.4	416.7	Cannot specify (Error occurs)	
H5	1.2	833.3		
H6	0.6	1666.7		
H7	0.3	3333.3		
H8	0.15	6666.7		

3. Data size of elapsed value and target value of pulse output and high-speed counter

The data size is changed.

FP0: 24 bits

FP0 compatibility mode: 32 bits

4. F144(TRNS) instruction specifications - Serial data communication

The following 2 items in the specifications for sending data are changed.

1) Processing of starting data of send buffer

FP0: Stores the number of unsent bytes every one-byte transmission.

FP0 compatibility mode: Stores 0 after the completion of all data transmission.

2) Restriction on the number of sent bytes

FP0: No restriction

FP0 compatibility mode: 2048 bytes

5. F169(PLS) instruction specifications - Pulse output (JOG operation)

The following 2 items in the specifications are changed.

1) "Operation mode and direction output" setting process

FP0: "00: No counting mode" is selectable.

FP0 compatibility mode: "00: No counting mode" is not selectable.

Performs the same operation as the one when specifying "10: Incremental counting mode with not direction output".

2) Pulse width specification

FP0: It is possible to set the fixed pulse width (80 μ s) or duty ratio.

FP0 compatibility mode: The settings are invalid and the duty ratio of pulse width is fixed at 25%.

6. F168(SPD1) instruction specifications - Positioning control (Home return)

The specifications during pulse output are changed.

FP0 : The elapsed value during home return is not fixed. It becomes zero when home return is done.

FP0 compatibility mode: The elapsed value is counted even during the home return operation. It becomes zero when home return is done.

7. Real number calculation process

As the accuracy of real number calculation has been improved, the calculation result in the FP0 compatibility mode may differ from the result in the existing FP0 program.

8. Process when a secondary battery is out of charge (T32 type only)

If the secondary battery installed in the T32 type is out of charge, the next power-on process will be different.

FP0: The value in the hold area of data memory will be unstable.

FP0 compatibility mode: The value in the hold area of data memory will be cleared to 0.

Chapter 1

Functions and Restrictions of the Unit

1.1 Unit Types

1.1.1 FP0R Control Units

Type	Program capacity	Specifications					COM port	Product No.	
		No. of I/O points	Power supply voltage	Input	Output	Connection type			
C10	16k steps	10 points (Input: 6 points/ Output: 4 points)	24V DC	24V DC ±common	Relay output: 2A	Terminal block	—	AFP0RC10RS	
						Molex connector	—	AFP0RC10RM	
	16k steps	10 points (Input: 6 points/ Output: 4 points)	24V DC	24V DC ±common	Relay output: 2A	Terminal block	RS232C	AFP0RC10CRS	
						Molex connector	RS485	AFP0RC10MRS	
C14	16k steps	14 points (Input: 8 points/ Output: 6 points)	24V DC	24V DC ±common	Relay output: 2A	Terminal block	—	AFP0RC14RS	
						Molex connector	—	AFP0RC14RM	
	16k steps	14 points (Input: 8 points/ Output: 6 points)	24V DC	24V DC ±common	Relay output: 2A	Terminal block	RS232C	AFP0RC14CRS	
						Molex connector	RS485	AFP0RC14MRS	
C16	16k steps	16 points (Input: 8 points/ Output: 8 points)	24V DC	24V DC ±common	Transistor output: (NPN) 0.2A	MIL connector	—	AFP0RC16T	
					Transistor output: (PNP) 0.2A			—	AFP0RC16P
	16k steps	16 points (Input: 8 points/ Output: 8 points)	24V DC	24V DC ±common	Transistor output: (NPN) 0.2A	MIL connector	RS232C	AFP0RC16CT	
					Transistor output: (PNP) 0.2A			RS232C	AFP0RC16CP
					Transistor output: (NPN) 0.2A	MIL connector	RS485	AFP0RC16MT	
					Transistor output: (PNP) 0.2A			RS485	AFP0RC16MP
	C32	32k steps	32 points (Input: 16 points/ Output: 16 points)	24V DC	24V DC ±common	Transistor output: (NPN) 0.2A	MIL connector	—	AFP0RC32T
						Transistor output: (PNP) 0.2A			—
32k steps		32 points (Input: 16 points/ Output: 16 point)	24V DC	24V DC ±common	Transistor output: (NPN) 0.2A	MIL connector	RS232C	AFP0RC32CT	
					Transistor output: (PNP) 0.2A			RS232C	AFP0RC32CP
					Transistor output: (NPN) 0.2A	MIL connector	RS485	AFP0RC32MT	
					Transistor output: (PNP) 0.2A			RS485	AFP0RC32MP

T32	32k steps	32 points (Input: 16 points/ Output: 16 points)	24V DC	24V DC ±common	Transistor output: (NPN) 0.2A	MIL connector	RS232C	AFP0RT32CT
					Transistor output: (PNP) 0.2A		RS232C	AFP0RT32CP
					Transistor output: (NPN) 0.2A	MIL connector	RS485	AFP0RT32MT
					Transistor output: (PNP) 0.2A		RS485	AFP0RT32MP
F32	32k steps	32 points (Input: 16 points/ Output: 16 points)	24V DC	24V DC ±common	Transistor output: (NPN) 0.2A	MIL connector	RS232C	AFP0RF32CT
					Transistor output: (PNP) 0.2A		RS232C	AFP0RF32CP
					Transistor output: (NPN) 0.2A	MIL connector	RS485	AFP0RF32MT
					Transistor output: (PNP) 0.2A		RS485	AFP0RF32MP

FP0 Expansion Units

Product name	Specifications					Product No.
	No. of I/O points	Power supply voltage	Input	Output	Connection type	
FP0R-E8 Expansion Unit	8 points (Input: 8 points)	-	24V DC ±common	-	MIL connector	AFP0RE8X
	8 points (Input: 4 points, Output: 4 points)	24V DC	24V DC ±common	Relay output: 2A	Terminal block	AFP0RE8RS
					Molex connector	AFP0RE8RM
	8 points (Output: 8 points)	24V DC	-	Relay output: 2A	Terminal block	AFP0RE8YRS
	8 points (Output: 8 points)	-	-	Transistor output: (NPN) 0.3A	MIL connector	AFP0RE8YT
8 points (Output: 8 points)	-	-	Transistor output: (PNP) 0.3A	MIL connector	AFP0RE8YP	
FP0R-E16 Expansion unit	16 points (Input: 16 points)	-	24V DC ±common	-	MIL connector	AFP0RE16X
	16 points (Input: 8 points, Output: 8 points)	24V DC	24V DC ±common	Relay output: 2A	Terminal block	AFP0RE16RS
					Molex connector	AFP0RE16RM
	16 points (Input: 8 points, Output: 8 points)	-	24V DC ±common	Transistor output: (NPN) 0.3A	MIL connector	AFP0RE16T
	16 points (Input: 8 points, Output: 8 points)	-	24V DC ±common	Transistor output: (PNP) 0.3A	MIL connector	AFP0RE16P
	16 points (Output: 16 points)	-	-	Transistor output: (NPN) 0.3A	MIL connector	AFP0RE16YT
16 points (Output: 16 points)	-	-	Transistor output: (PNP) 0.3A	MIL connector	AFP0RE16YP	
FP0R-E32 Expansion unit	32 points (Input: 16 points, Output: 16 points)	-	24V DC ±common	Transistor output: (NPN) 0.3A	MIL connector	AFP0RE32T
	32 points (Input: 16 points, Output: 16 points)	-	24V DC ±common	Transistor output: (PNP) 0.3A	MIL connector	AFP0RE32P

1.1.2 Intelligent Units

Product name	Specifications	Part No.	Product No.	Exclusive manual
FP0 Analog I/O unit	<Input specifications> No. of channels: 2 channels Input range: Voltage: 0 to 5 V, -10~+10V (Resolution: 1/4000) Current: 0 to 20 mA (Resolution: 1/4000)	FP0-A21	AFP0480	ARCT1F390
	<Output specifications> No. of channels: 1 channel Output range: Voltage: -10 to +10 V (Resolution: 1/4000) Current: 0 to 20 mA (Resolution: 1/4000)			
FP0 A/D Converter unit	<Input specifications> No. of channels: 8 channels Input range: Voltage: 0 to 5 V, -10 to +10V, -100 to 100 mV (Resolution: 1/4000) Current: 0 to 20 mA (Resolution: 1/4000)	FP0-A80	AFP0401	ARCT1F321
FP0 Thermocouple unit	K, J, T, R thermocouples, resolution: 0.1°C	FP0-TC4	AFP0420	ARCT1F366
	K, J, T, R thermocouples, resolution: 0.1°C	FP0-TC8	AFP0421	
FP0 RTD (Resistance-temperature detector) unit	Pt100, Pt1000, Ni1000 Resolution: 0.1°C /0.01°C (Switch type)	FP0-RTD6	AFP0430	ARCT1F445
FP0 D/A Converter unit	<Output specifications> No. of channels: 4 channels Output range: (Voltage output type): -10 to +10 V (Resolution: 1/4000) (Current output type): 4 to 20 mA (Resolution: 1/4000)	FP0-A04V	AFP04121	ARCT1F382
		FP0-A04I	AFP04123	

1.1.3 Link Units

Product name	Specifications	Power supply voltage	Part No.	Product No.	Exclusive manual
FP0 I/O Link Unit	This is a link unit designed to make the FP0R function as a slave unit to MEWNET-F (remote I/O system).	24V DC	FP0-IOL	AFP0732	This manual
FP0 CC-Link Slave unit	This unit is for making the FP0R function as a slave unit of the CC-Link. Only one unit can be connected to the furthest right edge of the FP0 expansion bus. Note) Accuracy will change if an FP0 thermocouple unit is used at the same time.	24V DC	FP0-CCLS	AFP07943	ARCT1F380
C-NET Adapter S2 type (for PLC side)	This is an RS485 adapter designed to allow use of the computer link function for connecting to a host computer via C-NET. With PLC tool port cable (30 cm). A power supply is not required.	-	-	AFP15402	ARCT1F96
C-NET Adapter (for computer side)	This is an RS485 adapter designed to allow use of the computer link function for connecting to a network-connected PLC via C-NET from a host computer.	100 to 240V AC	-	AFP8536	
		24V DC	-	AFP8532	
FP Web-Server2 unit	Connected with FP series PLCs, it conducts Ethernet communication, sends e-mail, and displays the PLC data on HTML pages.		FP-WEB2	AFP0611	ARCT1F446

1.1.4 Power Supply Unit

Product name	Specifications	Part No.	Product No.
FP0 Power supply unit	Input voltage: 100 to 240 V AC Free input Output capacity: 0.7A, 24 V DC	FP0-PSA4	AFP0634

1.1.5 Options

Product name		Specifications	Product No.
FP Memory loader		Programming tool for copying programs written to control unit	Data clear type AFP8670
			Data hold type AFP8671
FP0 Mounting plate	Slim type	Mounting plate for mounting control unit or expansion unit on a panel vertically.	AFP0803 (10-pack)
	Flat type	Mounting plate for mounting Control unit on a panel horizontally.	AFP0804 (10-pack)
Wiring tools	Terminal screwdriver	Required for connecting the terminal block (made by Phoenix Contact Co.) supplied with the relay output terminal type.	AFP0806
	Molex connector pressure contact tool	Required for connecting the connector supplied with the relay output type Molex connector. Equivalent to Molex Product No.: 57189-500.	AFP0805
	Multi-wire connector pressure contact tool	Required for connecting the connector supplied with the transistor output type.	AXY52000FP
Options for wiring	Relay output Molex type I/O cable	Loose-wiring cable, with Molex socket attached at one end. 9P. AWG20 (0.5mm ²), 2 pcs (blue and white) /set.	Length: 1 m AFP0551 (2 cable set)
			Length: 3 m AFP0553 (2 cable set)
	Transistor output type I/O cable	Loose-wiring cable, with connector attached at one end. 10P. AWG22 (0.3mm ²), 2 pcs (blue and white) /set.	Length: 1 m AFP0521 (2 cable set)
			Length: 3 m AFP0523 (2 cable set)
	Flat cable connector for transistor output type.	Required for wiring with flat cables. 10P.	AFP0808 (4-pack)

1.1.6 Repair Parts

Product name	Specifications	Product No.
Terminal socket	Attaches to relay output and terminal block type. Maintenance parts	AFP0802(2 cable set)
Molex socket	Attaches to relay output and Molex connector type. Maintenance parts	AFP0801(2 cable set)
Wire-press socket	Attaches to transistor output type. Maintenance parts	AFP0807(2 cable set)
Wire-press contact	For transistor output type unit.	Suitable wire: AWG #22 / AWG #24 AXW7221FP (5 pins in line)
		Suitable wire: AWG #26 / AWG #28 AXW7231FP (5 pins in line)
FP0R/FPΣ Power supply cable	Attaches to FP0R control unit. Maintenance parts. Length: 1m	AFPG805 (1-pack)
FP0 Power supply cable	Attaches to FP0 various units. Maintenance parts Length: 1m	AFP0581(1-pack)

Note) Order wire-press contacts in units of 200 pins in 40 rows.

1.2 Restrictions on Unit Combination

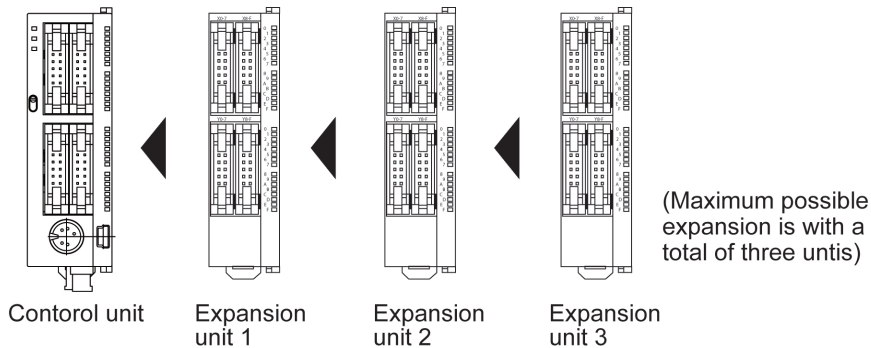

Up to three expansion units can be added on the right of the FP0R, these expansion units being either expansion units or intelligent units.

A combination of relay output and transistor output types is also possible.

Controllable I/O points

Type of control unit	No. of I/O points when using control unit	When the expansion unit is the same output type	When the expansion unit is a transistor output type
C10	10 points	Max. 58 points	Max. 106 points
C14	14 points	Max. 62 points	Max. 110 points
C16	16 points	Max. 112 points	Max. 112 points
C32 T32 F32	32 points	Max. 128 points	Max. 128 points



Note:

- Install the FP0 thermocouple unit on the right side of all other expansion units.
- If it is installed on the left side, the total precision will deteriorate.
- Install the FP0 CC-Link slave unit on the right side of all other expansion units. There is no expansion connector on the right side.
- Install the FP0 RTD unit on the right side of all other expansion units.

1.3 Programming Tools

1.3.1 Required Tools for Programming

1.Programming tool software

- The tool software can also be used with the FP series.
- "FPWIN GR Ver.2" or "FPWIN Pro Ver.6" Windows software is used with FP0R.
FP Programmer cannot be used.

2.PC connection cable

- A commercial USB cable (A: mini B type) is used for the connection.
- A cable for connecting a PC (Mini-DIN 5-pin, D-sub 9-pin) can be also used for the connection.

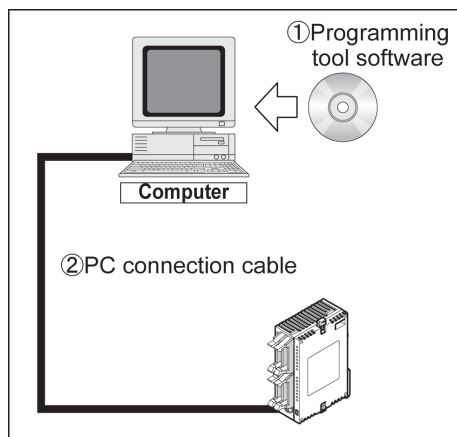

1.3.2 Software Environment and Suitable Cable

Standard ladder diagram tool software FPWIN GR Ver.2

Type of software		OS (Operating system)	Hard disk capacity	Product No.
FPWIN GR Ver.2 English-language menu	Full type	Windows®98 Windows®ME	40MB or more	AFPS10520
	Small type	Windows®2000 Windows®XP		AFPS11520
	Upgrade version	Windows Vista®		AFPS10520R

Note1) Ver.1.1 must be installed to install the upgrade version.

Note2) Ver.2.0 can be upgraded to Ver.2.1 or later free of charge at our web site

http://industrial.panasonic.com/ac/e/dl_center/software/

Use the latest version.

Note3) The small type can be used only for each series of FP-e, FPΣ, FP0 and FP-X.

Conforms to IEC61131-3 programming tool software FPWIN Pro Ver.6

Type of software	OS (Operating system)	Hard disk capacity	Product No.
FPWIN Pro Ver.6 English-language menu	Windows®2000 Windows®XP Windows Vista®	100MB or more	AFPS50560

Note1) The small type and upgrade version is not available for Ver.6.

Note2) Ver.6.0 can be upgraded to Ver.6.1 or later free of charge at our web site

(http://industrial.panasonic.com/ac/e/dl_center/software/).

Use the latest version.

Type of computer and suitable cable

For the connection between a personal computer (RS232C) and the control unit (RS232C)

D-sub connector cable

PLC side connector	PLC side connector	Specifications	Product No.
D-sub 9-pin	Female-Mini DIN round 5-pin	L type (3 m)	AFC8503
	Female-Mini DIN round 5-pin	Straight type (3 m)	AFC8503S

Note) A USB/RS232C conversion cable is necessary to connect with a personal computer without a serial port using a PC connection cable.

For the connection between a personal computer (USB) and the control unit (USB)

USB cable

Use a commercial cable.

Cable type	Length
USB 2.0 cable (A: miniB)	Max. 5 m

Note) Windows®2000 or later OS is required for the communication with a USB.

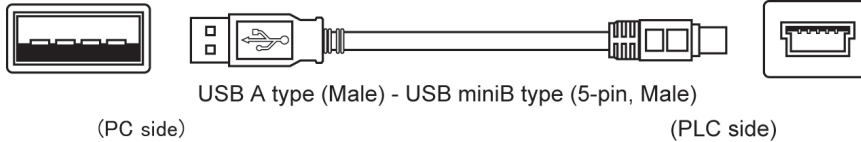

Chapter 2

Specifications and Functions of Control Unit

2.1 Part Names and Functions

2.1.1 Part Names and Functions

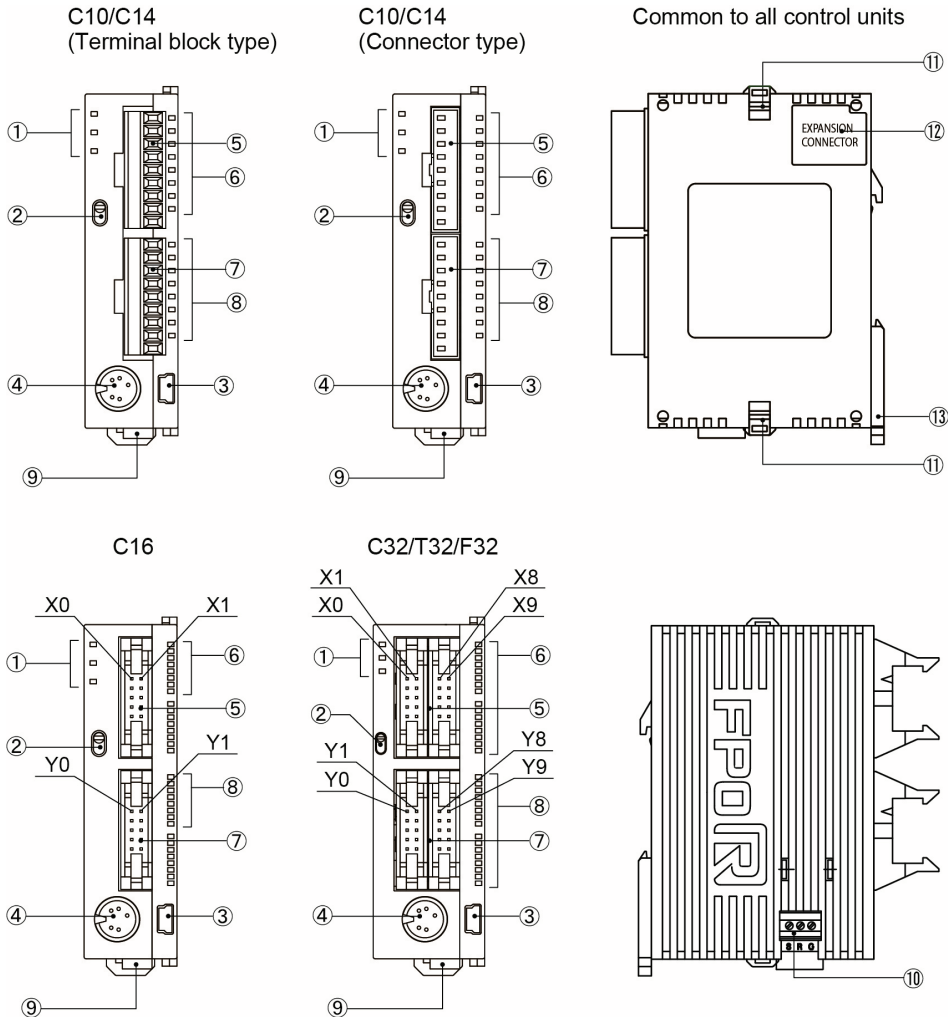

① Operation monitor LEDs

These LEDs display the current operation status of PLC such as RUN/STOP and ERROR/ALARM.

LED	LED and operation status
RUN (Green)	Lights: In the RUN mode - The program is being executed.
	Flashes: The forced input/output is being executed in the RUN mode. (The RUN and PROG. LEDs flash alternately.)
PROG. (Green)	Lights: In the PROG. mode - The operation has stopped. The forced input/output is being executed in the PROG. mode.
	Flashes: The forced input/output is being executed in the RUN mode. (The RUN and PROG. LEDs flash alternately.)
ERROR/ALARM (Red)	Flashes: An error is detected during the self-diagnostic function. (ERROR)
	Lights: A hardware error occurs, or operation slows because of the program, and the watchdog timer is activated. (ALARM)

② **RUN/PROG. mode switch**

This switch is used to change the operation mode of PLC.

Switch	Operation mode
RUN (Position: Up)	RUN mode :The program is executed and the operation begins.
PROG. (Position: Down)	PROG. mode :The operation stops. In this mode, programming can be done using a tool software.

- Switching between RUN and STOP can be also performed by the remote operation from a programming tool.
- When performing remote switching from the programming tool, the setting of the mode switch and the actual mode of operation may differ. Verify the mode with the status indicator LED.
- Restart the power supply to operate in the mode set with the RUN/PROG. mode switch.

③ **USB connector (Mini-USB B type (5-pin))**

This connector is used to connect a programming tool.

A commercial USB cable (USB2.0 cable (A: miniB)) can be used.

④ **Tool port (RS232C)**

This connector is used to connect a programming tool.

A commercial mini-DIN 5-pin connector is used for the tool port on the control unit.

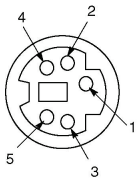

Pin No.	Signal name	Abbreviation	Signal direction
1	Signal Ground	SG	-
2	Send Data	SD	Unit → External device
3	Receive Data	RD	Unit ← External device
4	(Not used)	-	-
5	+5 V	+5 V	Unit → External device

- The followings are the default settings when the unit is shipped from the factory. The system register should be used to change these.

Baud rate 9600bps
 Char. Bit 8 bits
 Parity check Odd parity
 Stop bit 1 bit

Note) The unit number of the tool port should be set by the system register.

⑤ **Input connector**

⑥ **Input status LEDs**

⑦ **Output connector**

⑧ **Output indicator LEDs**

⑨ **Power supply connector (24 V DC)**

Supply 24 V DC. It is connected using the power supply cable (AFPG805) supplied with the unit.

⑩ **COM port (RS232C or RS485)**

Communication interface for connection with an external device such as a programmable display.

⑪ **expansion hook**

This hook is used to secure expansion units. The hook on the right side is also used for installation on the flat-type mounting plate (AFP0804).

⑫ **Right-side connector for FP0 expansion**

This is used to connect the FP0-cum-FPΣ expansion unit installed on the right side of control unit to the internal circuit. (The connector is located under the seal.)

⑬ **DIN hook**

This hook enables the unit to attach to a rail at a touch. It is also used to install the unit on the slim type mounting plate (AFP0803).

2.2 Input and Output Specifications

2.2.1 Input Specifications

Input specifications (for all types)

Item	Description
Insulation method	Optical coupler
Rated input voltage	24 V DC
operating voltage range	21.6 V DC to 26.4 V DC
Rated input current	Approx. 2.6 mA
Output points per common	For C10: 6 points/common For C14, C16: 8 points/common For C32, T32, F32: 16 points/common (Either the positive or negative of the input power supply can be connected to common terminal.)
Min. on voltage/Min. on current	19.2 V DC/2 mA
Max. off voltage/Max. off current	2.4 V DC/1.2 mA
Input impedance	9.1 k Ω
Response time	OFF→ON 20 μ s or less Note) The input time constant can be set using system registers. (0.1 ms to 64 ms)
	ON→OFF Same as above
Operating mode indicator	LED display

Note) This specification is applied when the rated input a voltage is 24 V DC and the temperature is 25°C.

Limitations on number of simultaneous input on points

Keep the number of input points per common which are simultaneously on within the following range as determined by the ambient temperature.

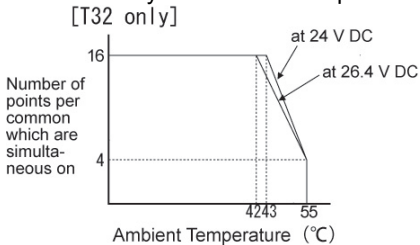

Circuit diagram

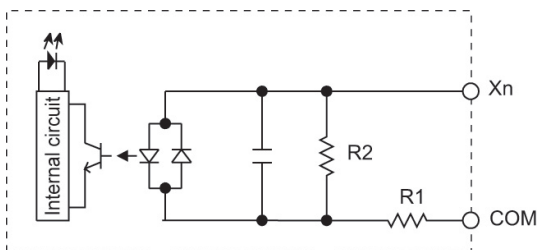

R1=9.1 k Ω R2=1 k Ω

2.2.2 Output Specifications

Transistor output specifications

Item	Description	
	NPN	PNP
Insulation method	Optical coupler	
Output type	Open collector	
Rated load voltage	5 V DC to 24 V DC	24 V DC
Operating load voltage range	4.75 V DC to 26.4 V DC	21.6 V DC to 26.4 V DC
Max. load current	0.2A	
Output points per common	For C16: 8 points/common For C32, T32, F32: 16 points/common	
Off state leakage current	1 μ A or less	
On state voltage drop	0.2 V DC or less	
Response time	OFF \rightarrow ON	20 μ s or less (Load current: 5 mA or more) 0.1 ms or less (Load current: 0.5 mA or more)
	ON \rightarrow OFF	40 μ s or less (Load current: 5 mA or more) 0.2 ms or less (Load current: 0.5 mA or more)
External power supply (+ and - terminals)	Voltage	21.6V DC to 26.4V DC
	Current	C16: 30 mA or less C32, T32, F32: 60 mA or less
Surge absorber	Zener diode	
Operating mode indicator	LED display	

Limitations on number of simultaneous output on points

Keep the number of output points per common which are simultaneously on within the following range as determined by the ambient temperature.

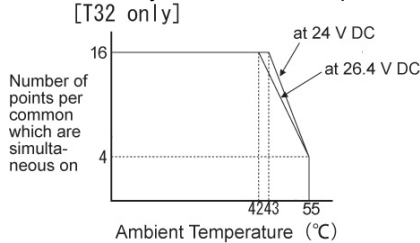

Circuit diagram

[NPN]

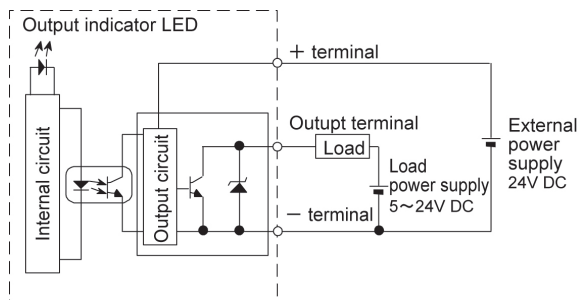

[PNP]

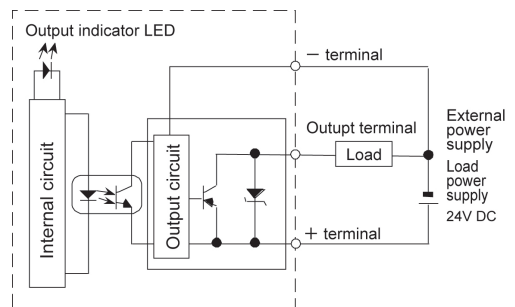

Relay output specifications (C10/C14)

Item	Description	
Output type	1a output	
Rated control capacity	2 A 250 V AC, 2 A 30 V DC (4.5 A or less/common) ^{Note)}	
Output points per common	C10:2 points/common+1 point/common+1 point/common C14:4 points/common+1 point/common+1 point/common	
Response time	OFF → ON	Approx. 10 ms
	ON → OFF	Approx. 8 ms
Lifetime	Mechanical	Min. 20,000,000 operations (Switching rate: 180 times/min.)
	Electrical	Min. 100,000 operations (Switching rate: 20 times/min. at rated control capacity)
Surge absorber	None	
Operating mode indicator	LED display	



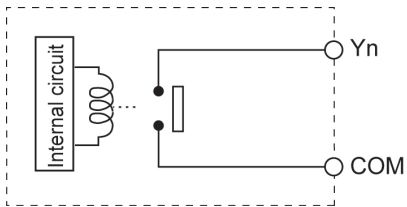

Note) Resistance load

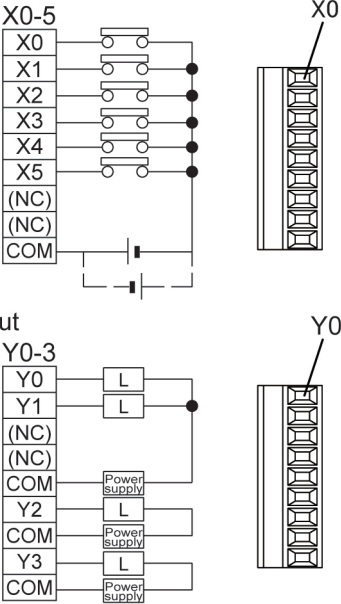
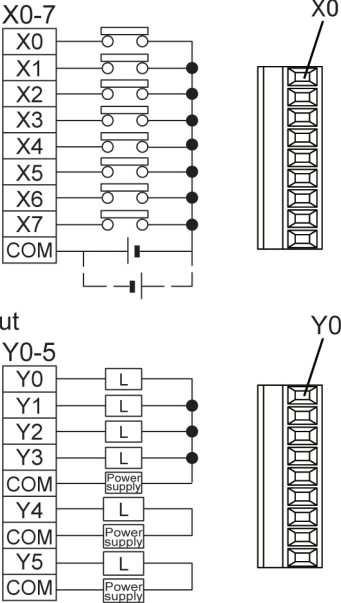

Circuit diagram

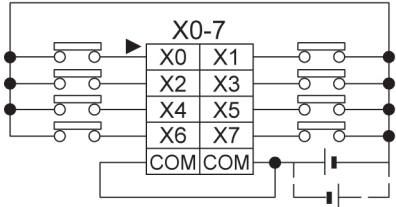
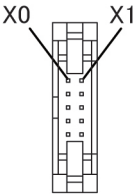
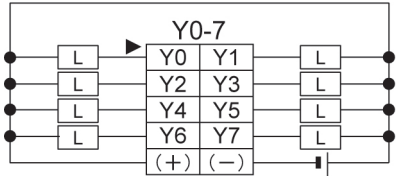
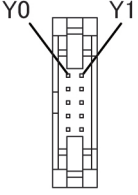

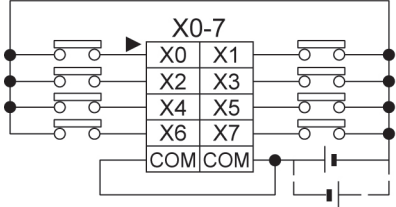
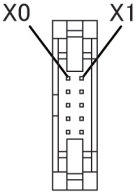
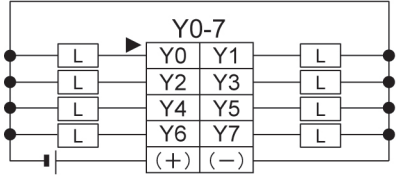
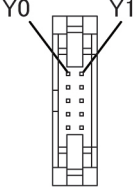
2.3 Terminal layout diagrams

Model No.	Terminal layout diagrams
C10RS C10CRS C10RM C10CRM	<p data-bbox="412 311 471 336">Input</p>  <p data-bbox="412 649 491 674">Output</p> <p data-bbox="573 962 1092 987">(The above illustration is the terminal block type.)</p>
C14RS C14CRS C14RM C14CRM	<p data-bbox="412 1035 471 1060">Input</p>  <p data-bbox="412 1373 491 1398">Output</p> <p data-bbox="573 1686 1092 1711">(The above illustration is the terminal block type.)</p>

Model No.	Terminal layout diagrams
C16T C16CT C16MT	<p data-bbox="303 282 364 311">Input</p>   <p data-bbox="303 575 385 604">Output</p>   <p data-bbox="721 794 950 817">(Front view of connector)</p> <p data-bbox="303 846 371 904"> Note: Two COM terminals of the input circuit are connected internally.</p>
C16P C16CP C16MP	<p data-bbox="303 973 364 1002">Input</p>   <p data-bbox="303 1267 385 1296">Output</p>   <p data-bbox="721 1485 950 1508">(Front view of connector)</p> <p data-bbox="303 1537 371 1595"> Note: Two COM terminals of the input circuit are connected internally.</p>

Model No.	Terminal layout diagrams
C32T C32CT C32MT T32CT T32MT F32CT F32MT	<div data-bbox="285 311 1016 552"> <p>Input</p> </div> <div data-bbox="1048 336 1208 523"> </div> <div data-bbox="285 575 1016 788"> <p>Output</p> </div> <div data-bbox="1048 581 1208 768"> </div> <div data-bbox="1039 768 1245 788"> <p>(Front view of connector)</p> </div> <div data-bbox="285 819 1105 938"> <p> Note: Four COM terminals of the input circuit are connected internally. Two (+) terminals of the output circuit are connected internally. Two (-) terminals of the output circuit are connected internally.</p> </div>
C32P C32CP C32MP T32CP T32MP F32CP F32MP	<div data-bbox="285 996 1016 1238"> <p>Input</p> </div> <div data-bbox="1048 1022 1208 1209"> </div> <div data-bbox="285 1261 1016 1474"> <p>Output</p> </div> <div data-bbox="1048 1267 1208 1454"> </div> <div data-bbox="1039 1454 1245 1474"> <p>(Front view of connector)</p> </div> <div data-bbox="285 1505 1105 1624"> <p> Note: Four COM terminals of the input circuit are connected internally. Two (+) terminals of the output circuit are connected internally. Two (-) terminals of the output circuit are connected internally.</p> </div>

2.4 Functions of T32 Control Unit

2.4.1 Memory Backup Function

The FP0R-T32 control unit has a secondary battery (Charging type).

The backup function for the operation memory and clock/calendar function can be used.

Backup of operation memory

- (1) Timer/Counter (T/C)
- (2) Internal relays (R)
- (3) Data Registers (DT)
- (4) Step ladders

The range specified with a programming tool is the hold area to be backed up.

If the range is not specified, it will be the area of the default.

Note) If the battery is out of charge and the hold area becomes indefinite, the value in the hold area will be cleared to 0 when the power supply is turned on again.



Key Point:

Programs and system registers will be held in the internal ROM regardless of the built-in back up battery.

2.4.2 Built-in Backup Battery

Time the built-in backup battery can be used (Backup time)

The built-in backup battery is not charged when the unit is shipped.

Charge the battery sufficiently before use. (Full charge (Ambient temperature: 25°C): 72 hours)

It will be charged automatically if the DC power is supplied to the control unit.

Relation between charging time and backup time

The number of days in the backup time varies according to the rate of charging time.

If it is charged on a full charge (72 hours) at the ambient temperature of 25°C, the backup time will be approx. 50 days.

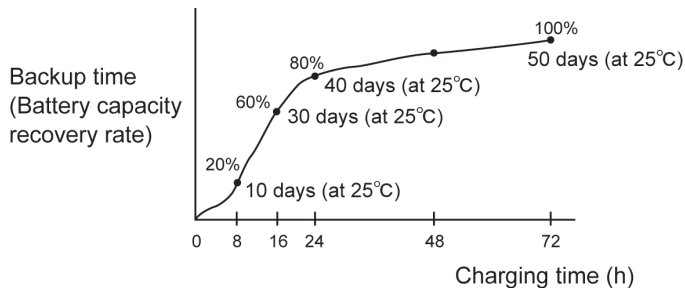

The backup time will vary according to the ambient temperature when the battery is charged.

Ambient temperature when charged	Number of days in backup time
70 °C	Approx. 14 days
-20 °C	Approx. 25 days

Predicted life of built-in backup battery

The life of the built-in backup battery varies according to the ambient temperature while the control unit is on (energized).

Note) The temperature when the control unit is off (not powered) has little influence on the battery life.

Ambient temperature	Lifetime of built-in backup battery
55 °C	Approx. 430 days <Approx. 1 year>
45 °C	Approx. 1200 days <Approx. 3 years>
40 °C	Approx. 2100 days <Approx. 6 years>
35 °C	Approx. 3300 days <Approx. 9 years>
34 °C or lower	Approx. 10 years



Note: The built-in backup battery cannot be replaced.

2.4.3 Clock/Calendar

The clock/calendar function is available for the FP0R-T32.

Note) As the value is unstable in the initial state, write the value using a programming tool.

Area of clock/calendar

With the clock/calendar function, data indicating the hour, minute, second, day, year and other information stored in the special data registers DT90053 to DT90057 can be read using the transmission instruction and used in sequence programs.

Special data register No.	Higher bytes	Lower bytes	Reading	Writing
DT90053	Hour data H00 to H23	Minute data H00 to H59	Available	Not available
DT90054	Minute data H00 to H59	Second data H00 to H59	Available	Available
DT90055	Day data H01 to H31	Hour data H00 to H23	Available	Available
DT90056	Year data H00 to H99	Month data H01 to H12	Available	Available
DT90057	-	Day-of-the-week data H00 to H06	Available	Available

Setting of Clock/Calendar Function

Setting using a programming tool

Using FWIN GR

1. Select [Online Edit Mode] under the [Online] on the menu bar, or press the [CTRL] and [F2] keys at the same time, to switch to the [Online] screen.
2. Select "Set PLC Data and Time" under "Tool" on the menu bar.

Set PLC Date and Time dialog box

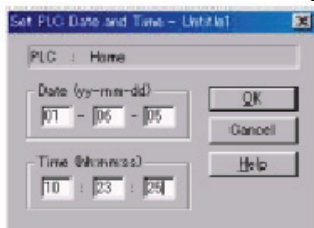

The above steps display the "Set PLC Date and Time dialog box" shown at the left. Input the date and time, and click on the "OK" button.

Using FWIN Pro

1. Select [Online Mode] under the [Online] on the menu bar, or press the [Shift] and [Esc] keys at the same time, to switch to the [Online Mode] screen.
2. Select "Special Relay/Special Data Register" under "Monitor" on the menu bar.
3. The screen will appear to set various parameters.

Setting and changing using program

- (1) The values written to the special data registers DT90054 to DT90057, which are allocated as the clock/calendar setting area, are sent.
- (2) A value of H8000 is written to DT90058.

Note) The value can be sent using the differential instruction "DF", or by changing H8000 to H0000.

Example showing the date and time being written

Set the time to 12:00:00 on the 5th day when the X0 turns on.

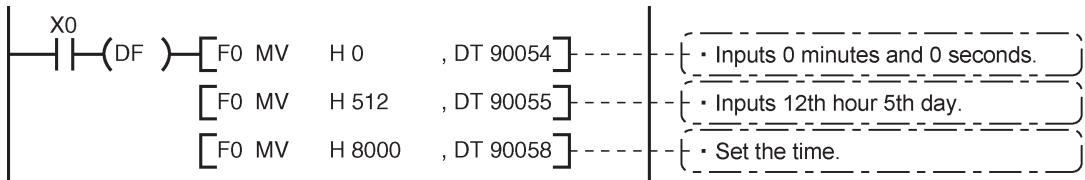

Note: As the value is unstable in the initial state, write the value using a programming tool. As a day of the week is not automatically set on programming tools, fix what day is set to 00, and set the value for 00.

Example showing the clock/calendar being used

Sample program for fixed schedule and automatic start

In the example shown here, the clock/calendar function is used to output (Y0) signal for one second, at 8:30 a.m. every day.

Here, the "Hour/minute" data stored in the special data register DT90053 is used to output the signal at the appointed time.

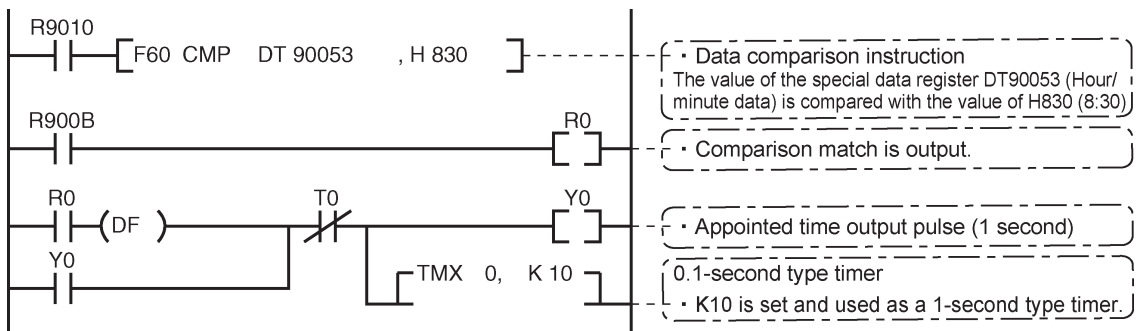

- The hour data is stored in the upper 8 bits of DT90053 and the minute data in the lower 8 bits, in the BCD format.
- This hour and minute data is compared with the appointed time (BCD), and the R900B (=flag) special internal relay is used to detect whether or not it matches the appointed time.

Chapter 3

Expansion

3.1 Expansion Method

The FP0/FP0R expansion units (expansion I/O unit, high-performance unit) are connected to the right side of the control Unit.

Unit expansion is done using the right-side connector for FP0/FP0R expansion and the expansion hooks on the side of the unit.

(1) Peel the seal on the right side of the unit to expose the internal right-side connector for the FP0/FP0R expansion.

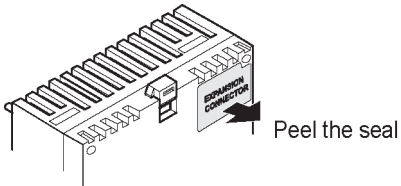

(2) Using a screwdriver or similar tool, pull out the top and bottom expansion hooks.

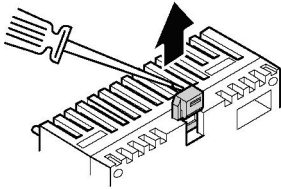

(3) Align the pins and holes in the four corners of the control unit and expansion unit, and insert the pins into the holes so that there is no gap between the units.

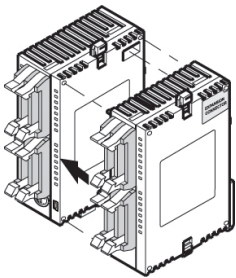

(4) Press down the expansion hooks raised in Step (2) to secure the unit.

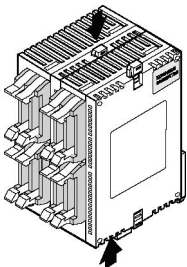

3.2 Part Names and Functions

Expansion Units

E8RS/E16RS
(Terminal type)

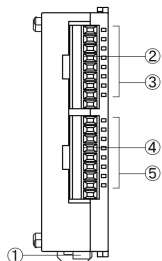

E8RM/E16RM
(Connector type)

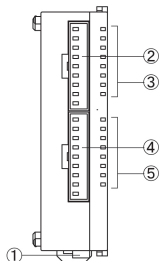

E16

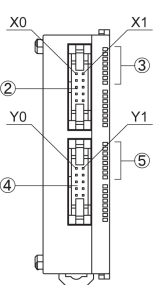

E32

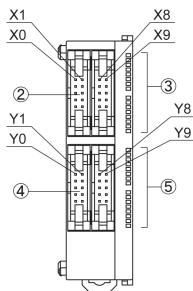

Expansion output units

E8Y

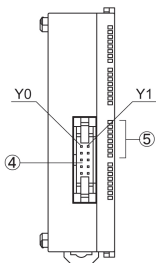

E16Y

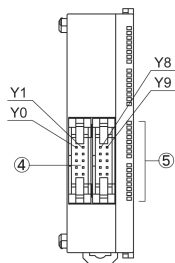

E8YRS
(Terminal type)

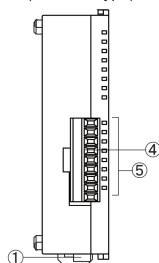

Expansion input units

E8X

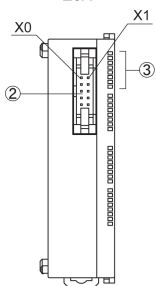

E16X

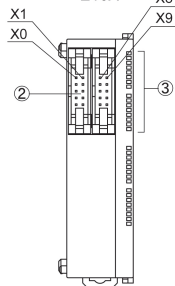

Common to all expansion units

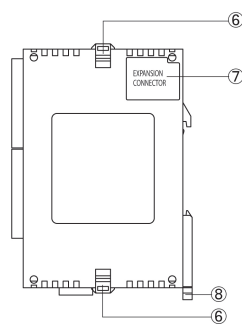

Part Names and Functions

① Power supply connector

Supply 24 V DC. It is connected using the cable (AFP0581) supplied with the unit.

② Input connector

③ Input indicator LED

④ Output connector

⑤ Output indicator LEDs

⑥ Expansion hook

This hook is used to secure expansion units.

⑦ Expansion connector

This connector is used to connect an expansion unit and internal circuit.

⑧ DIN hook

This hook enables the unit to attach to a rail at a touch. It is also used to install the unit on the slim type mounting plate (AFP0803).

3.3 Input and Output Specifications

(1) Input specifications

Item		Specifications
Insulation method		Optical coupler
Rated input voltage		24 V DC
Rated input current		Approx. 4.7 mA (at 24 V DC)
Input impedance		Approx. 5.1 kΩ
Operating voltage range		21.6 V DC to 26.4 V DC
Input point per common (Either the positive or negative of the input power supply can be connected to common terminal.)	E8X/E16P/E16T	8 points/common
	E32T/E16X	16 points/common
	E8R	4 points/common
Min. on voltage/Min. on current		19.2 V DC/3 mA
Max. off voltage/Max. off current		2.4 V DC/1 mA
Response time	OFF → ON	2 ms or less
	ON → OFF	2 ms or less
Operating mode indicator		LED display

Note) The above table shows the specifications of FP0R Expansion Unit. For FP0 Expansion Unit, the rated input voltage is approx. 4.3 mA, and the input impedance is approx. 5.6 kΩ.

Limitations on number of simultaneous input on points

Keep the number of input points per common which are simultaneously on within the following range as determined by the ambient temperature.

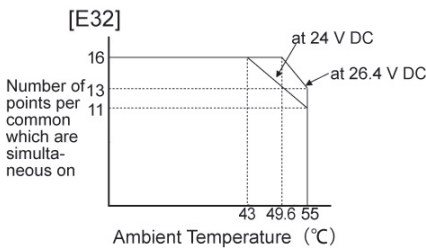

Internal circuit diagram

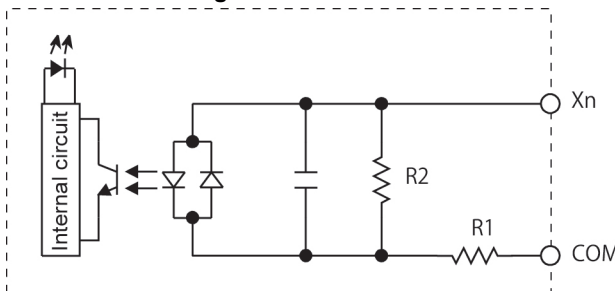

R1=5.1 kΩ, R2=910Ω

(2) Output specifications

Relay type output specifications

E8RS/E8RM/E8YRS/E16RS/E16RM

Item	Description	
Output type	1a relay output	
Rated control capacity	2 A 250 V AC, 2 A 30 V DC (Max. 4.5 A or less/common) ^{Note)}	
Output points per common	E8R	4 points/common
	E16R, E8YR	8 points/common
Response time	OFF → ON	Approx. 10 ms
	ON → OFF	Approx. 8 ms
Lifetime	Mechanical	Min. 20,000,000 operations
	Electrical	Min. 100,000 operations
Surge absorber	None	
Operating mode indicator	LED display	

Note) Resistance load

Internal circuit diagram

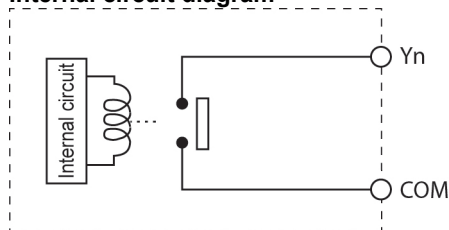

Transistor type output specifications

(NPN output type: E8YT/E16YT/E16T/E32T)

(PNP output type: E8YP/E16YP/E16P/E32P)

Item	Description	
	NPN	PNP
Insulation method	Optical coupler	
Output type	Open collector	
Rated load voltage	5 V DC to 24 V DC	24 V DC
Operating load voltage range	4.75 V DC to 26.4 V DC	21.6 V DC to 26.4 V DC
Max. load current	0.3A/point (Max. 1 A per common)	
Output points per common	E16T, E8Y	8 points/common
	E32, E16Y	16 points/common
Off state leakage current	100 μA or less	
On state voltage drop	1.5V or less	
External power supply (for driving internal circuit)	Voltage	21.6 V DC to 26.4 V DC
	Current	3 mA/1 point
Response time	OFF→ON	1 ms or less
	ON→OFF	1 ms or less
Surge absorber	Zener diode	
Operating mode indicator	LED display	

Note) The above table shows the specifications of FP0R expansion unit. For FP0 Expansion Unit, the maximum load current is 0.1 A.

Limitations on number of simultaneous input on points

Keep the number of input points per common which are simultaneously on within the following range as determined by the ambient temperature.

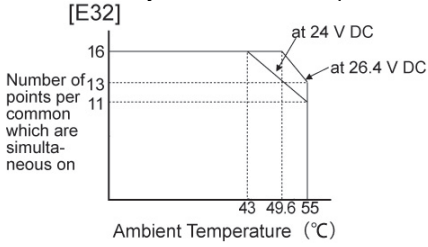

Internal circuit diagram

[NPN]

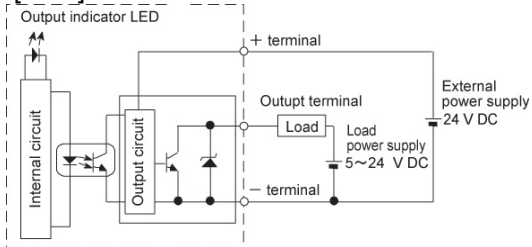



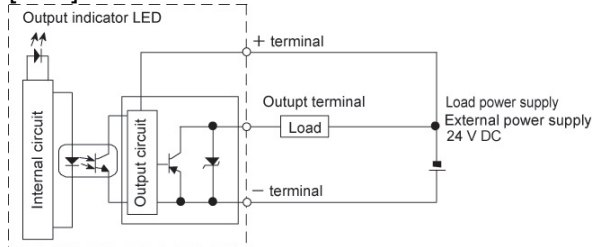

[PNP]

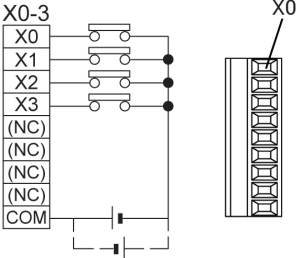
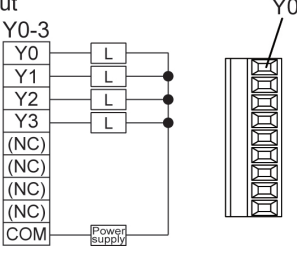
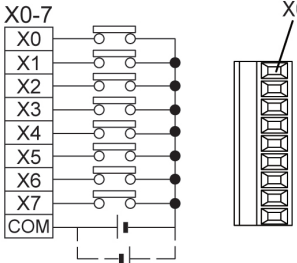
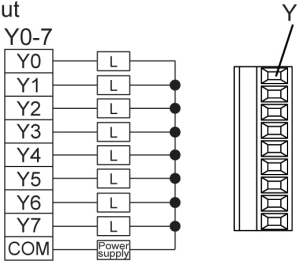

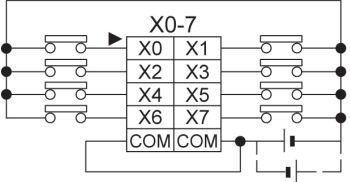
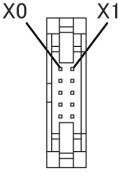
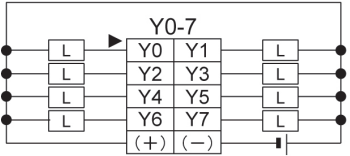
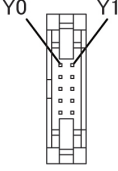
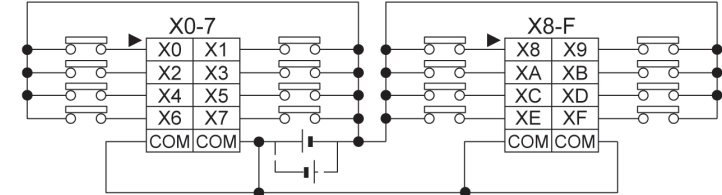
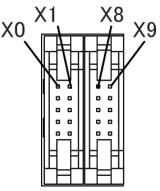
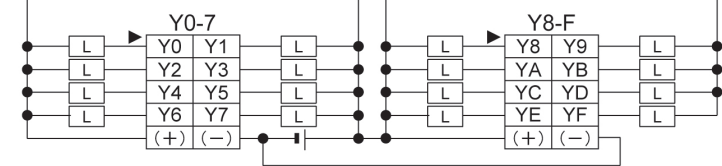
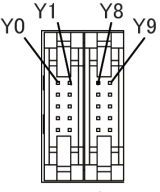
3.4 Terminal layout diagram

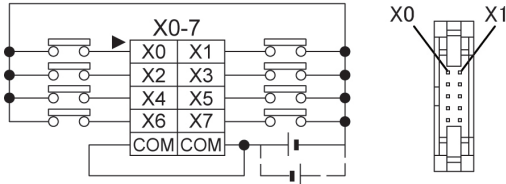
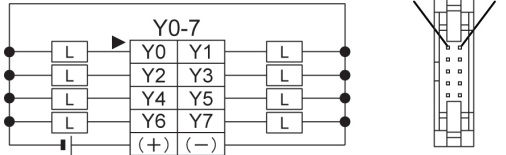
Model No.	Terminal layout diagrams
<p>E8RS E8RM</p>	<p>Input</p>  <p>Output</p> 
<p>E16RS E16RM E8YRS</p>	<p>Input (No input for E8YRS)</p>  <p>Output</p> 

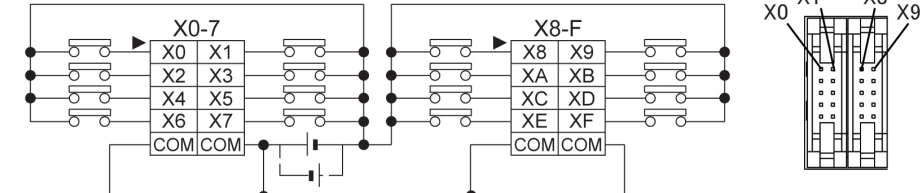
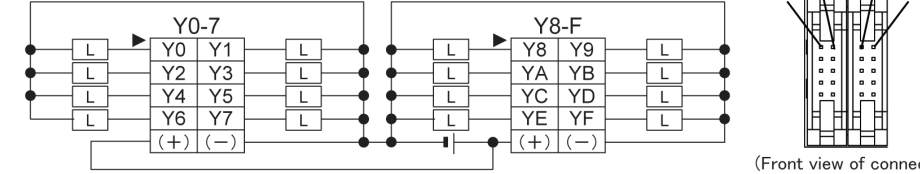
Model No.	Terminal layout diagrams
E8X E16T E8YT	<p data-bbox="257 314 509 340">Input (No input for E8YT)</p>   <p data-bbox="257 575 522 600">Output (No output for E8X)</p>   <p data-bbox="625 765 827 784">(Front view of connector)</p> <p data-bbox="257 817 323 871"></p> <p data-bbox="330 852 1071 877">Note: Two COM terminals of the input circuit are connected internally.</p>
E16X E32T E16YT	<p data-bbox="257 937 518 962">Input (No input for E16YT)</p>   <p data-bbox="257 1199 536 1224">Output (No output for E16X)</p>   <p data-bbox="996 1389 1197 1408">(Front view of connector)</p> <p data-bbox="257 1435 323 1489"></p> <p data-bbox="330 1470 1071 1551">Note: Two COM terminals of the input circuit are connected internally. Two (+) terminals of the output circuit are connected internally. Two (-) terminals of the output circuit are connected internally.</p>

Model No.	Terminal layout diagrams
E16P E8YP	<p data-bbox="285 311 540 338">Input (No input for E8YP)</p>  <p data-bbox="285 571 358 598">Output</p>  <p data-bbox="655 765 857 782">(Front view of connector)</p> <p data-bbox="285 817 353 871"> Note: Two COM terminals of the input circuit are connected internally.</p>
E32P E16YP	<p data-bbox="285 938 550 966">Input (No input for E16YP)</p>  <p data-bbox="285 1199 358 1226">Output</p>  <p data-bbox="1033 1392 1234 1410">(Front view of connector)</p> <p data-bbox="285 1441 353 1495"> Note: Two COM terminals of the input circuit are connected internally. Two (+) terminals of the output circuit are connected internally. Two (-) terminals of the output circuit are connected internally.</p>

Chapter 4

I/O Allocation

4.1 I/O Allocation

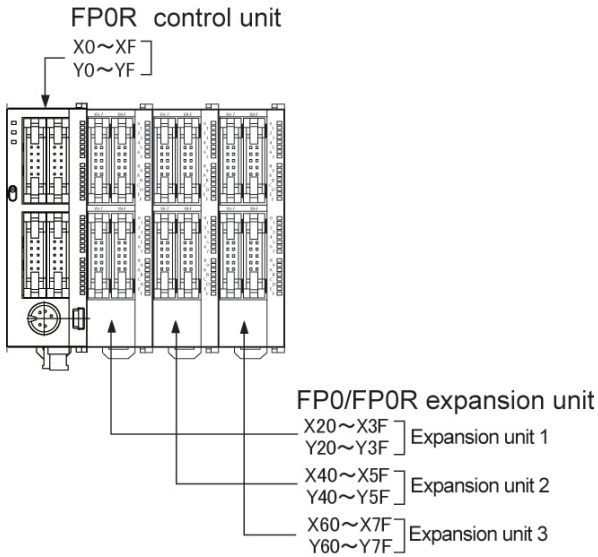

Note) The usable I/O numbers are different depending on the units.

Regarding I/O number

Specifying X and Y numbers

On the FP0R, the same numbers are used for input and output.

Example: X20 }
 Y20 } The same numbers are used for input and output

Expression of numbers for input/output relays

Since input relay "X" and output relay "Y" are handled in units of 16 points, they are expressed as a combination of decimal and hexadecimal numbers as shown below.

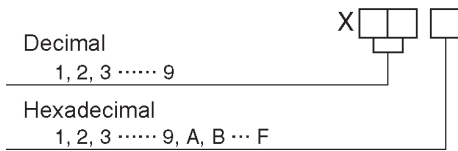

4.2 I/O Allocation for FP0R Control Unit

4.2.1 I/O Numbers of FP0R Control Unit

The I/O allocation of FP0R control unit is fixed.

Type of control unit	Number of allocation	I/O number
C10	Input (6 point)	X0 to X5
	Output (4 points)	Y0 to Y3
C14	Input (8 points)	X0 to X7
	Output (6 points)	Y0 to Y5
C16	Input (8 points)	X0 to X7
	Output (8 points)	Y0 to Y7
C32/T32/F32	Input (16 points)	X0 to XF
	Output (16 points)	Y0 to YF

4.3 I/O Numbers of FP0/FP0R Expansion Unit

- I/O numbers do not need to be set as I/O allocation is automatically performed when an expansion unit is added.

- The I/O allocation of expansion unit is determined by the installation location.

Type of unit		Number of allocation	Expansion unit 1	Expansion unit 2	Expansion unit 3
FP0/FP0R Expansion unit	E8X	Input (8 points)	X20 to X27	X40 to X47	X60 to X67
	E8R	Input (4 points)	X20 to X23	X40 to X43	X60 to X63
		Output (4 points)	Y20 to Y23	Y40 to Y43	Y60 to Y63
	E8YT/P E8YR	Output (8 points)	Y20 to Y27	Y40 to Y47	Y60 to Y67
	E16X	Input (16 points)	X20 to X2F	X40 to X4F	X60 to X6F
	E16R	Input (8 points)	X20 to X27	X40 to X47	X60 to X67
	E16T/P	Output (8 points)	Y20 to Y27	Y40 to Y47	Y60 to Y67
	E16YT/P	Output (16 points)	Y20 to Y2F	Y40 to Y4F	Y60 to Y6F
E32T/P		Input (16 points)	X20 to X2F	X40 to X4F	X60 to X6F
		Output (16 points)	Y20 to Y2F	Y40 to Y4F	Y60 to Y6F
FP0 Analog I/O unit	FP0-A21	Input (16 points) CH0	WX2 (X20 to X2F)	WX4 (X40 to X4F)	WX6 (X60 to X6F)
		Input (16 points) CH1	WX3 (X30 to X3F)	WX5 (X50 to X5F)	WX7 (X70 to X7F)
		Output (16 points)	WY2 (Y20 to Y2F)	WY4 (Y40 to Y4F)	WY6 (Y60 to Y6F)
FP0 A/D conversion unit FP0 Thermocouple unit	FP0-A80 FP0-TC4 FP0-TC8	Input (16 points) CH0, 2, 4, 6	WX2 (X20 to X2F)	WX4 (X40 to X4F)	WX6 (X60 to X6F)
		Input (16 points) CH1, 3, 5, 7	WX3 (X30 to X3F)	WX5 (X50 to X5F)	WX7 (X70 to X7F)
FP0 RTD unit	FP0-RTD	Input (16 points) CH0, 2, 4	WX2 (X20 to X2F)	WX4 (X40 to X4F)	WX6 (X60 to X6F)
		Input (16 points) CH1, 3, 5	WX3 (X30 to X3F)	WX5 (X50 to X5F)	WX7 (X70 to X7F)
		Output (16 points)	WY2 (Y20 to Y2F)	WY4 (Y40 to Y4F)	WY6 (Y60 to Y6F)
FP0 D/A conversion unit	FP0-A04V FP0-A04I	Input (16 points)	WX2 (X20 to X2F)	WX4 (X40 to X4F)	WX6 (X60 to X6F)
		Output (16 points) CH0, 2	WY2 (Y20 to Y2F)	WY4 (Y40 to Y4F)	WY6 (Y60 to Y6F)
		Output (16 points) CH1, 3	WY3 (Y30 to Y3F)	WY5 (Y50 to Y5F)	WY7 (Y70 to Y7F)
FP0 I/O link unit	FP0-IOL	Input (32 points)	X20 to X3F	X40 to X5F	X60 to X7F
		Output (32 points)	Y20 to Y3F	Y40 to Y5F	Y60 to Y7F

- The data for the each channels of FP0 A/D conversion unit (FP0-A80), FP0 thermocouple unit (FP0-TC4/FP0-TC8) and FP0 D/A conversion unit (FP0-A04V/FP0-A04I) is converted and loaded with a user program that includes a switching flag to convert the data.

- Regarding FP0 CC-Link slave unit, please refer to the exclusive manual.

Chapter 5

Installation and Wiring

5.1 Installation

5.1.1 Installation Environment and Space

Operating environment

(Use the unit within the range of the general specifications when installing)

- Ambient temperature: 0 to +55 °C
 - Ambient humidity: 10 to 95 % RH (at 25 °C, non-condensing)
 - For use in pollution Degree 2 environment.
-
- Do not use the unit in the following environments.
 - Direct sunlight
 - Sudden temperature changes causing condensation.
 - Inflammable or corrosive gas.
 - Excessive airborne dust, metal particles or saline matter.
 - Benzine, paint thinner, alcohol or other organic solvents or strong alkaline solutions such as ammonia or caustic soda.
 - Direct vibration, shock or direct drop of water.
 - Influence from power transmission lines, high voltage equipment, power cables, power equipment, radio transmitters, or any other equipment that would generate high switching surges.(100 mm or more)

Static electricity

- Do not touch connector pins directly to prevent static electricity from causing damage.
- Always rid yourself of any static electricity before handling this product.

Measures regarding heat discharge

Always install the unit oriented with the tool port facing outward on the bottom in order to prevent the generation of heat.

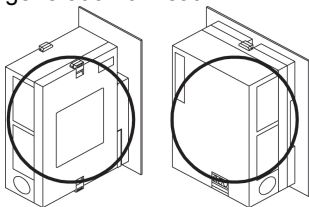

- Do not install the unit as shown below.

INCORRECT

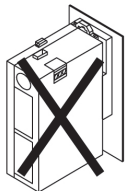

Upside-down

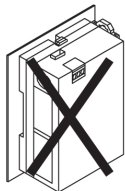

Upside-down

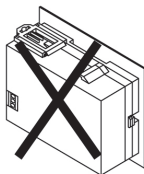

Installations such that the input and output connectors face down

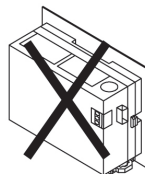

Input and output connectors on top

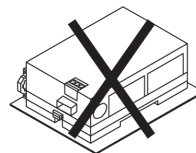

Horizontal installation of the unit

- Do not install the unit above devices which generate heat such heaters, transformers or large scale resistors.

Installation space

- Leave at least 50 mm of space between the wiring ducts of the unit and other devices to allow heat radiation and unit replacement.

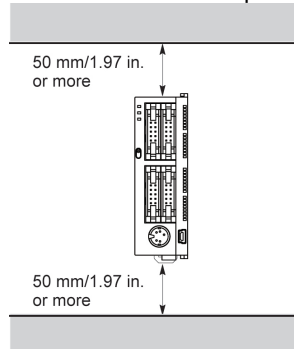

- Maintain at least 100 mm of space between devices to avoid adverse affects from noise and heat when installing a device or panel door to the front of the PLC unit.

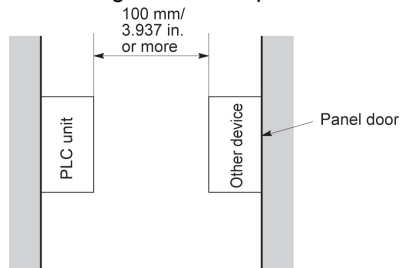

- Leave at least 100 mm of space from the front surface of the control unit in order to allow room for programming tool connections and wiring.

5.1.2 Installation and Removal

Attachment to DIN rail and removal from DIN rail

The unit can be simply attached to DIN rail.

Procedure of installation

- (1) Fit the upper hook of the unit onto the DIN rail.
- (2) Without moving the upper hook, press on the lower hook to fit the unit into position.

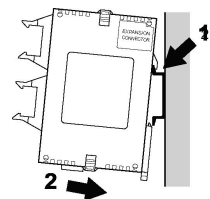

Procedure of removal

- (1) Insert a slotted screwdriver into the DIN rail attachment lever.
- (2) Pull the attachment lever downwards.
- (3) Lift up the unit and remove it from the rail.

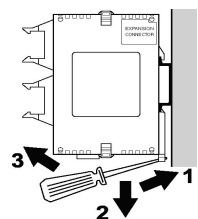

5.1.3 Installation Using the Optional Mounting Plate

When using the slim type FP0 mounting plate (AFP0803)

Use M4 size pan-head screws for attachment of the mounting plate and install according to the dimensions shown below.

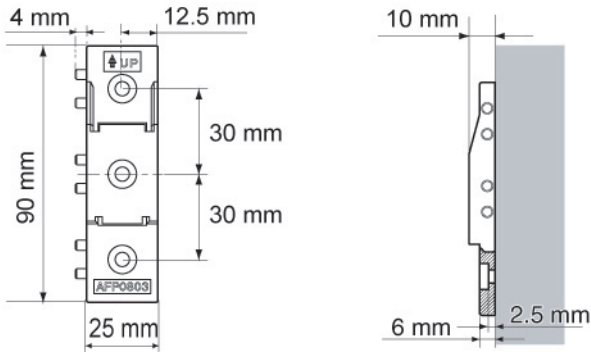

The rest of the procedure is the same as that for attaching the unit to the DIN rails.

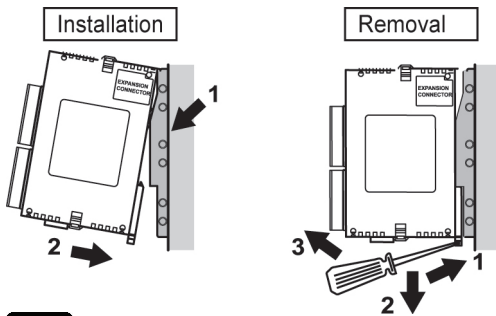

Note:

When using an expansion unit, tighten the screws after joining all of the mounting plate to be connected. Tighten the screws at each of the four corners.

[Example] When using the maximum numbers of the expansion units (with AFP0803)

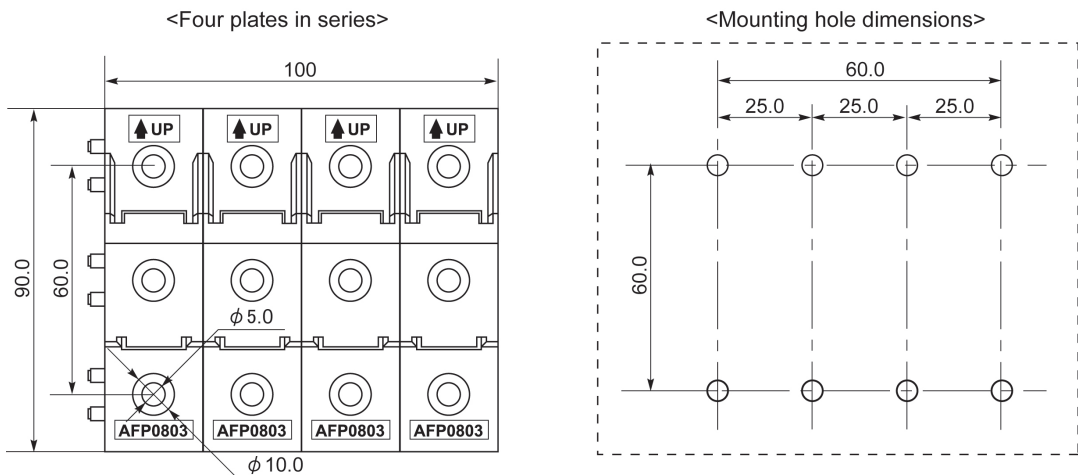

When using the flat type mounting plate (AFP0804)

Use M4 size pan-head screws for attachment of the mounting plate and install according to the dimensions shown below.

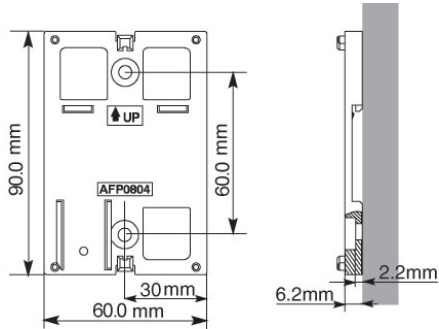

Raise the expansion hooks of the unit. Align the expansion hooks with the mounting plate and press the hooks.

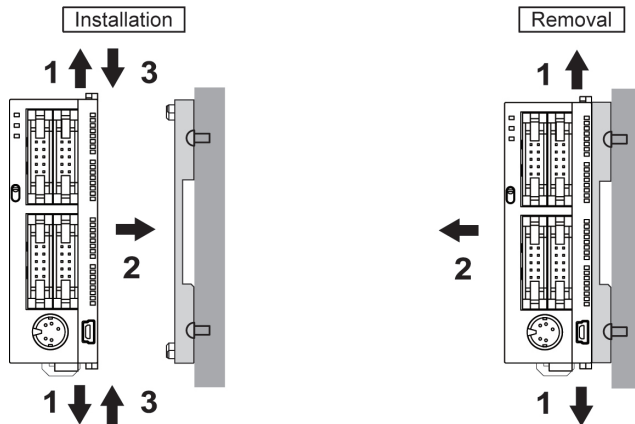

An unit with an attached mounting plate can also be installed sideways on a DIN rail.

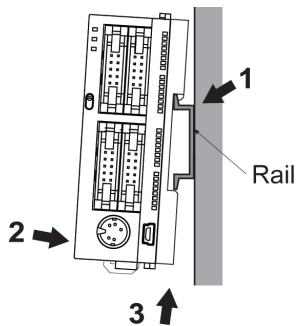

Note:

The flat type mounting plate (AFP0804) should be used only with the control unit as a stand-alone unit. It should not be used when the unit is being used in combination with an FP0/FP0R expansion unit.

5.2 Wiring of Power Supply

5.2.1 Wiring of Power Supply

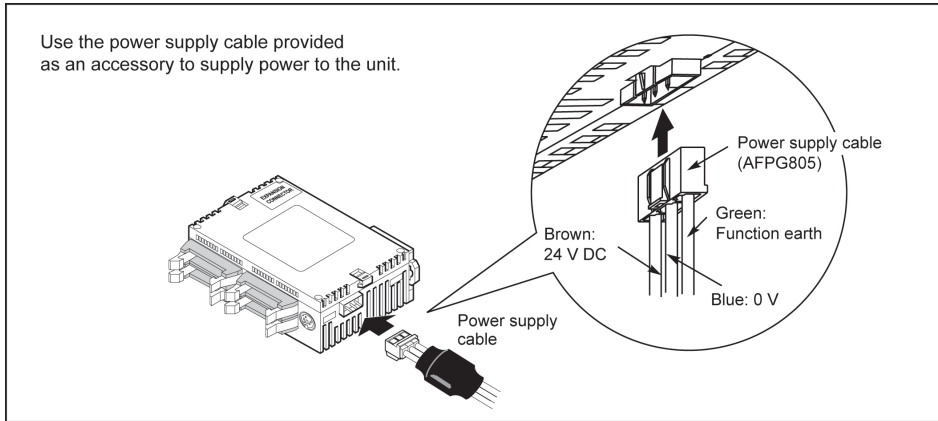

Power supply wiring for the unit

Use the power supply cable (Part number: AFPG805) that comes with the unit to connect the power supply.

Brown: 24 V DC

Blue: 0 V

Green: Function earth

Power supply wire

To minimize adverse effects from noise, twist the brown and blue wires of the power supply cable.

Power supply type

- To protect the system against erroneous voltage from the power supply line, use an insulated power supply with an internal protective circuit.
- The regulator on the unit is a non-insulated type.
- If using a power supply device without an internal protective circuit, always make sure power is supplied to the unit through a protective element such as a fuse.

Power supply voltage

Rated voltage	24V DC
Operating voltage range	21.6V DC to 26.4V DC

Wiring system

- Isolate the wiring systems to the control unit, input/output devices, and mechanical power apparatus.

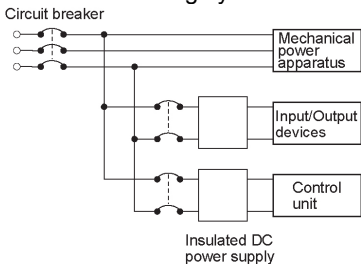

Measures regarding power supply sequence

- The power supply sequence should be set up so that power to the control unit is turned off before the input/output power supplies.
- If the input/output power supplies are turned off before the power to the control unit, the unit will detect the input fluctuations and may begin an unscheduled operation.
- Be sure to supply power to the control unit and an expansion unit from the same power supply, and turn the power on and off simultaneously for both.

5.2.2 Grounding

In situations of excess noise

Under normal conditions, the inherent noise resistance is sufficient. However, in situations of excess noise, ground the instrument to increase noise suppression.

Exclusive grounding

- The grounding connection should have a resistance of less than 100Ω.
- The point of grounding should be as close to the PLC as possible. The ground wire should be as short as possible.
- If two devices share a single ground point, it may produce an adverse effect. Always use an exclusive ground for each device.

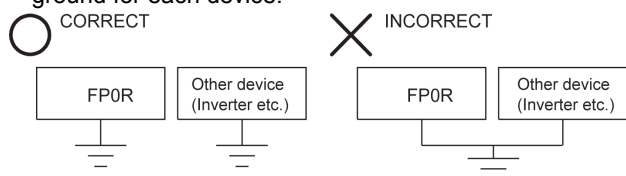

Note:

Depending on the surroundings in which the equipment is used, grounding may cause problems.

Since the power supply line of the FP0/FP0R expansion unit is connected to the function earth through a varistor, if there is an irregular potential between the power supply line and earth, the varistor may be shorted.

As for the FP0R control unit, since its power supply line is connected to the function earth through a high-voltage capacitor, it is no problem.

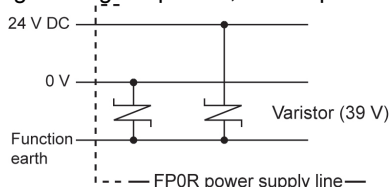

Do not ground the function earth terminal when grounding a plus (+) terminal of the power.

Do not ground the FP0R function earth terminal when grounding a plus (+) terminal of the power.

In some computers, the SG terminal of RS232C port and connector shielding are connected.

In addition, an FP0R tool port shielding and function earth terminal are connected.

Therefore, the GND terminal of FP0R and the function earth terminal are connected if the computer is connected.

Especially when the FP0R is connected to a computer with a plus (+) terminal grounded, the GND terminal is in the state that the voltage of -24 V is applied. As a result, short circuit occurs which may lead to the breakage of FP0R and its neighboring parts if the GND terminal is connected to the earth terminal in that state.

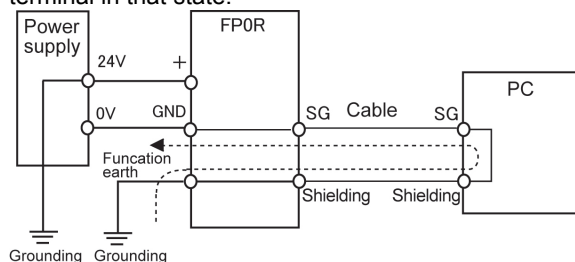

5.3 Wiring of Input and Output

5.3.1 Input Wiring

Connection of photoelectric sensor and proximity sensor

Relay output type

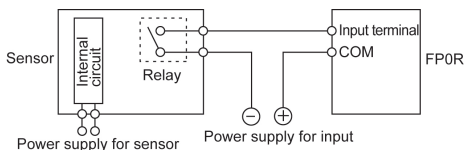

NPN open collector output type

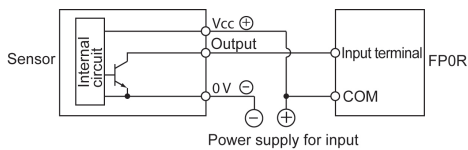

Voltage output type

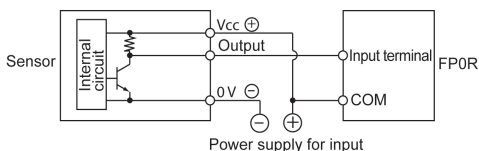

Two-wire output type

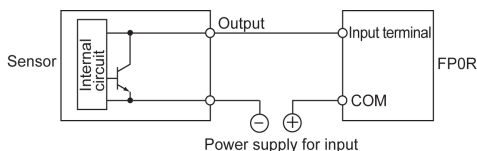

Precaution when using LED-equipped reed switch

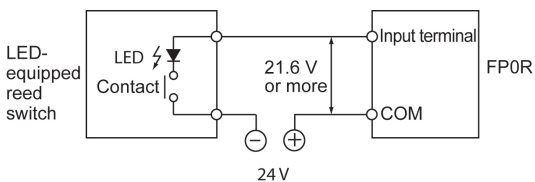

When a LED is connected in series to an input contact such as LED-equipped reed switch, make sure that the voltage applied to the PLC input terminal is greater than the ON voltage. In particular, take care when connecting a number of switches in series.

Precaution when using two-wire type sensor

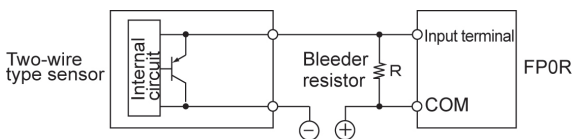

I : Sensor's leakage current (mA)
R : Bleeder resistor (kΩ)

The off voltage of the input is 2.4 V, therefore, select the value of bleeder resistor "R" so that the voltage between the COM terminal and the input terminal will be less than 2.4 V. The input impedance is 9.1 kΩ.

$$I \times \frac{9.1R}{9.1R + R} \leq 2.4 \quad \text{Therefore,}$$

$$R \leq \frac{21.84}{9.11 - 2.4} \quad (\text{k}\Omega)$$

The wattage W of the resistor is:

$$W = \frac{(\text{Power supply voltage})^2}{R}$$

In the actual selection, use a value that is 3 to 5 times the value of W.

Precaution when using LED-equipped limit switch

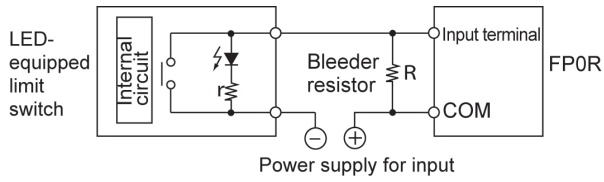

If the input of PLC does not turn off because of leakage current from the LED-equipped limit switch, the use of a bleeder resistor is recommended, as shown on the left.

r : Internal resistor of limit switch (kΩ)
R : Bleeder resistor (kΩ)

The off voltage of input is 2.4 V, therefore when the power supply voltage is 24 V, select the bleeder resistor "R" so that

The current will be greater than $I = \frac{24-2.4}{r}$

The resistance R of the bleeder resistor is:

$$R \leq \frac{21.84}{9.11-2.4} \text{ (k}\Omega\text{)}$$

The wattage W of the resistor is:

$$W = \frac{(\text{Power supply voltage})^2}{R} \times (3 \text{ to } 5 \text{ times})$$

5.3.2 Output Wiring

Protective circuit for inductive loads

- With an inductive load, a protective circuit should be installed in parallel with the load.
- When switching DC inductive loads with relay output, be sure to connect a diode across the ends of the load.

When using an AC inductive load (Relay output type)

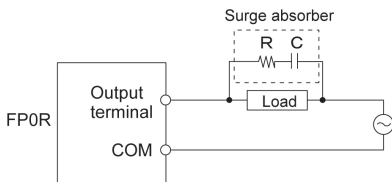

Example of surge absorber:
Resistance(R): 50 Ω
Capacity(C) : 0.47 μF

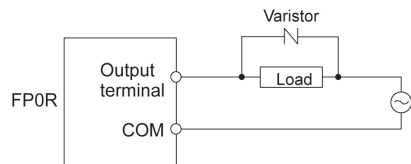

When using an DC inductive load

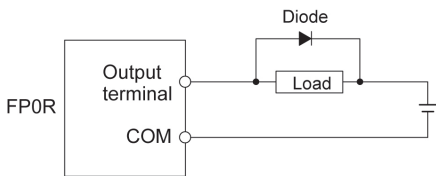

Diode:
Reverse voltage: 3 times the load voltage
Averag rectified forward current: Load current or more

Precautions when using capacitive loads

When connecting loads with large in-rush currents, to minimize their effect, connect a protection circuit as shown below.

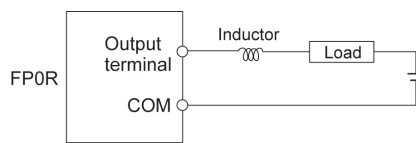
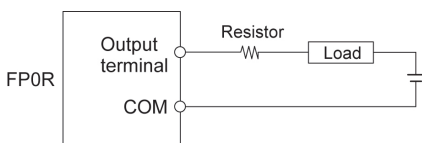

Use an external fuse as overload protection

A fuse is not built in the output circuit. It is recommended to install external fuses on every circuit, in order to prevent the output circuit to be burned out when the output is shorted. However, in some cases such as shortcircuit, the element of the unit may not be protected.

5.3.3 Precautions Regarding Input and Output Wirings

Separate the input, output, and power lines

- Be sure to select the thickness (dia.) of the input and output wires while taking into consideration the required current capacity.
- Arrange the wiring so that the input and output wiring are separated, and these wirings are separated from the power wiring, as much as possible. Do not route them through the same duct or wrap them up together.
- Separate the input/output wires from the power and high voltage wires by at least 100 mm.

5.4 Wiring of MIL Connector Type

Supplied connector and suitable wires

The connector listed below is supplied with the unit. Use the suitable wires given below. Also, use the required pressure connection tools for connecting the wires.

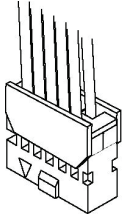

Suitable wires (Twisted wire)

Size	Nominal cross-sectional area	Insulation thickness	Remark	Rated current
AWG#22	0.3mm ²	Dia. 1.5 to dia. 1.1	Twisted wire of 12 pcs/0.18	3A
AWG#24	0.2mm ²		Twisted wire	

Note) The contact suitable for AWG#22 or AWG#24 is supplied with the product. For purchasing a contact suitable for AWG#26 or AWG#28, specify AXW7231FP.

Connector for loose-wire cable (Attached to the control unit and expansion I/O unit)

Manufacturer	Type and product No.	Unit type and required quantity		
		E8	C16/E16	C32/T32/F32/E32
Manufactured by us	Housing(10P)	1 pc	2 pcs x 1 set	2 pcs x 2 sets
	Semi-cover(10P)	2 pcs	4 pcs x 1 set	4 pcs x 2 sets
	Contact (for AW22 and 24) 5 pins	2 pcs x 1 set	4 pcs x 1 set	4 pcs x 2 sets

Note) The parts of the number of the connectors are supplied with the product. If you need more connectors, purchase AFP0807 (2 sets/pack).

Pressure connection tool

Manufacturer	Product No.
Manufactured by us	AXY52000FP

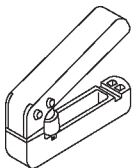

Pressure connection tool



Key Point:

When using a MIL connector for flat cables, purchase the product number AFP0808 (4 pcs, 10-pin strain-relief with key). In this case, the suitable wire is AWG#28 and the rated current is 1A.

Wiring method

The wire end can be directly crimped without removing the wire's insulation, saving labor.

(1) Bend the welder (contact) back from the carrier, and set it in the pressure connection tool.

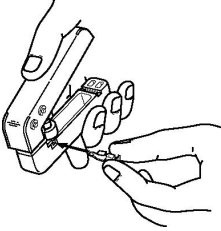

(2) Insert the wire without removing its insulation until it stops, and lightly grip the tool.

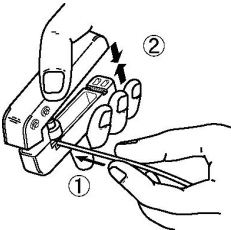

(3) After press-fitting the wire, insert it into the housing.

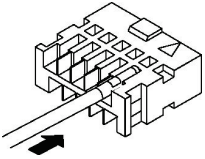

(4) When all wires has been inserted, fit the semi-cover into place.

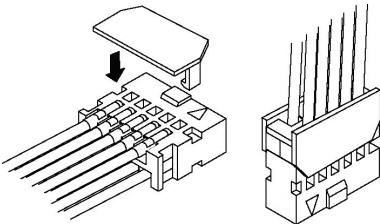

If there is a wiring mistake or the cable is incorrectly pressure-connected, the contact puller pin provided with the fitting can be used to remove the contact.

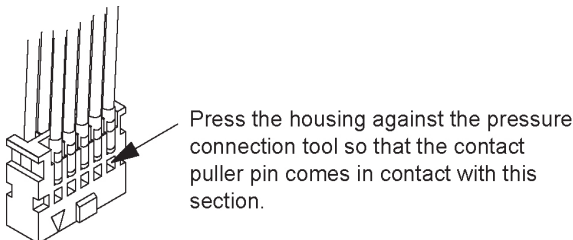

Press the housing against the pressure connection tool so that the contact puller pin comes in contact with this section.

5.5 Wiring of Terminal Block Type

Attached terminal block/Suitable wires

A screw-down connection type is used for the terminal block. The suitable wires are given below.

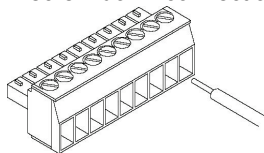

Terminal block socket

The terminal socket manufactured by Phoenix Contact is used.

No. of pins	Model No. of Phoenix Contact	
	Model No.	Product No.
9 pins	MC1,5/9-ST-3,5	1840434

Suitable wires (Twisted wire)

Size	Nominal cross-sectional area
AWG#24 to 16	0.2mm ² to 1.25mm ²

Pole terminal

If a pole terminal is being used, the following models manufactured by Phoenix Contact Co. should be used.

Manufacturer	Cross-sectional area (mm ²)	Size	Part No.	
			With insulating sleeve	Without insulating sleeve
Phoenix Contact Co.	0.25	AWG #24	AI 0,25 – 6 BU	A 0,25 – 7
	0.34	AWG #22	AI 0.34 – 6 TQ	A 0,34 – 7
	0.50	AWG #20	AI 0,5 – 6 WH	A 0,5 – 6
	0.75	AWG #18	AI 0,75 – 6 GY	A 0,75 – 6
	1.00	AWG #18	–	A 1 – 60
	0.5×2	AWG #20 (for 2 pcs)	AI – TWIN 2× 0.5 – 8 WH	–

Pressure welding tool for pole terminals

Manufacturer	Model No. of Phoenix Contact	
	Model No.	Product No.
Phoenix Contact Co.	CRIMPFOX 6	1212034

For tightening the terminal block

When tightening the terminals of the terminal block, use a screwdriver (Product No. 1205037) with a blade size of 0.4 x 2.5 (Part No. SZS 0,4x2,5).

The tightening torque should be 0.22 to 0.25 N m (2.3 to 2.5 kgf-cm) or less.

Wiring method

(1) Remove a portion of the wire's insulation.



(2) Insert the wire into the terminal block until it contacts the back of the block socket, and then tighten the screw clockwise to fix the wire in place. (The tightening torque: 0.22 to 0.25 N m (2.3 to 2.5 kgf-cm))

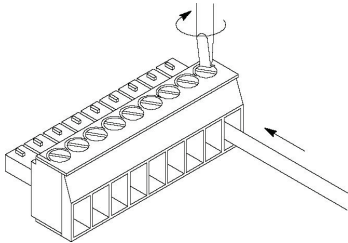

Notes for wiring

- When removing the wire's insulation, be careful not to scratch the core wire.
- Do not twist the wires to connect them.
- Do not solder the wires to connect them. The solder may break due to vibration.
- After wiring, make sure stress is not applied to the wire.
- In the terminal block socket construction, if the wire is fastened upon counter-clockwise rotation of the screw, the connection is faulty. Disconnect the wire, check the terminal hole, and then re-connect the wire.

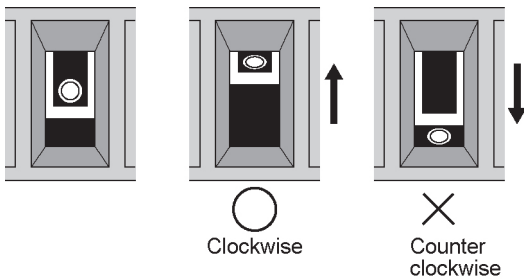

5.6 Wiring of Molex Connector Type

Supplied connector and suitable wires

The connector listed below is supplied with the unit. Use the suitable wires given below. Also, use the required pressure connection tools for connecting the wires.

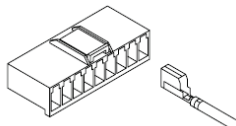

Supplied connector

Manufacturer	Molex Japan model No.		
Japan Molex Co., Ltd.	Housing	51067-0900	2 pcs
	Contact	50217-8100	20 pcs

Suitable wires (Twisted wire)

Size	Cross-sectional area	Insulation thickness
AWG#24~18	0.2mm ² ~0.75mm ²	Dia. 1.4 to dia. 3.0

Pressure connection tool

Manufacturer	Molex Japan model No.
Japan Molex Co., Ltd.	57189-5000

Wiring method

(1) Remove a portion of the wire's insulation.

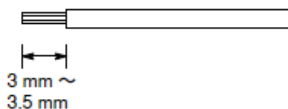

(2) Place the contact in the crimping tool, place the wire in the contact and lightly squeeze the tool

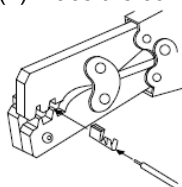

(3) Insert the crimped wire into the housing until it contacts the back side.

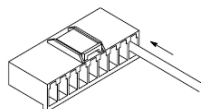

(4) When removing the wire, use a flat-head screwdriver, or other similar tool, to pull up the hold-down pin of the housing and then pull out the wire.

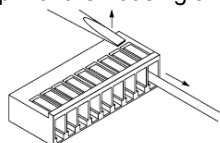

5.7 Wiring of COM Port

5.7.1 Suitable Wires and Wiring Method

Terminal block/Suitable wires

A screw-down connection type is used for the COM port. Use the suitable wires given below.

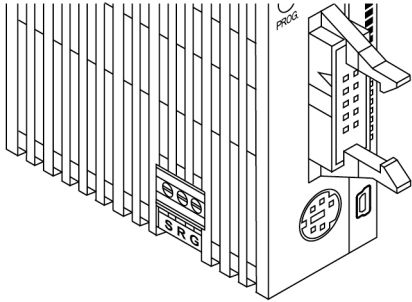

COM port (RS232C port) terminal layout

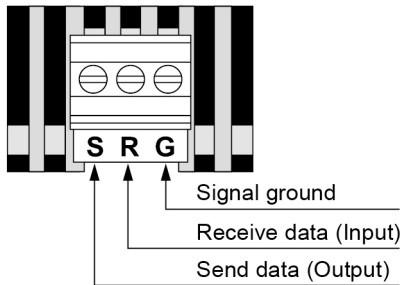

COM port (RS485 port) terminal layout

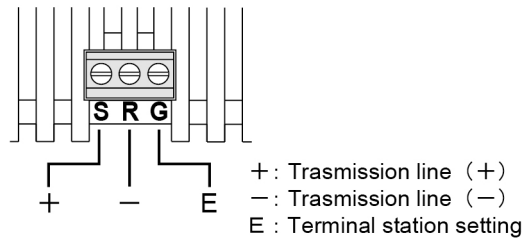

Terminal block

The communication connector manufactured by Phoenix Contact is used.

No. of pins	Phoenix Contact model No.	
	Model No.	Product No.
3 pins	MKDS1/3-3.5	1751400

Suitable wires (Twisted wire)

Size	Cross-sectional area
AWG#28 to 16	0.08mm ² to 1.25mm ²

Use the above wires shielded. it is recommended to ground the shielded part. Also, if using a pole terminal, refer to "5.5 Wiring of Terminal Block Type".

Wiring method

(1) Remove a portion of the wire's insulation.



(2) Insert the wire into the COM port until it contacts the back side.

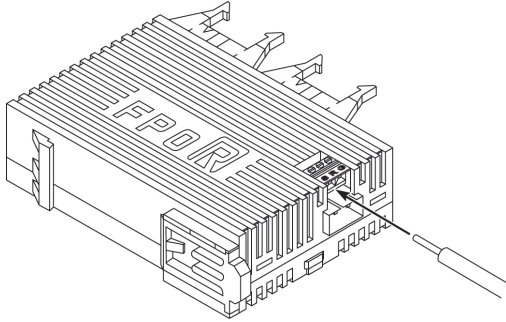

(3) Tighten the screw.

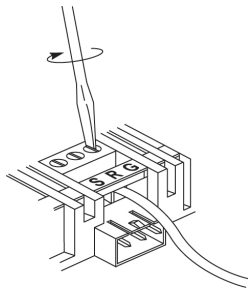

For tightening the terminal block

When tightening the COM port, use a screwdriver (Phoenix Contact Co., Product No. 1205037) with a blade size of 0.4 x 2.5 (Part No. SZS 0,4x2,5). The tightening torque should be 0.22 to 0.25 N•m (2.3 to 2.5 kgf-cm) or less.

Notes for wiring

1. When removing the wire's insulation, be careful not to scratch the core wire.
2. Do not twist the wires to connect them.
3. Do not solder the wires to connect them. The solder may break due to vibration.
4. After wiring, make sure stress is not applied to the wire.
5. In the terminal block socket construction, if the wire is fastened upon counter-clockwise rotation of the screw, the connection is faulty. Disconnect the wire, check the terminal hole, and then re-connect the wire.

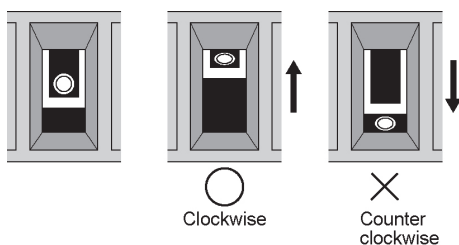

5.7.2 Connection of COM Port (RS485 Type)

- Wiring should extend from one unit to the next, between "+" terminals, and "-" terminals as below.
Never run two wires from a single unit to two other units.
- In the unit that serves as the terminal station, connect the "E" terminal and "-" terminal.

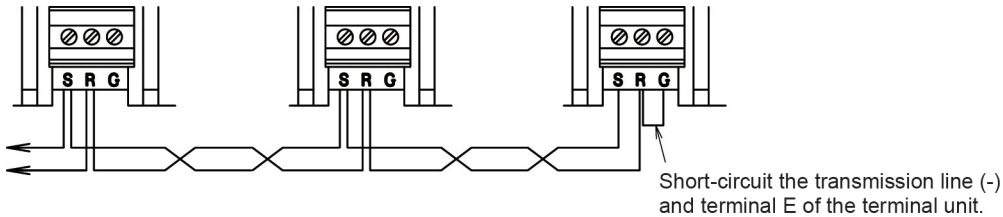

5.7.3 Selection of Transmission Cables (RS485 Type)

Please use the following cables as transmission cables.

Appropriate electrical cables (twisted cables)

Type	Cross-sectional view	Conductor		Insulator		Cable diam.	Sample appropriate cable
		Size	Resistance (at 20°C)	Material	Thickness		
Shielded twisted pair		0.5 mm ² (AWG20) or greater	Max. 33.4 Ω/km	Polyethylene	Max. 0.5 mm	Approx. 7.8 mm	Belden 9207 Hitachi Cable, Ltd. KPEV-S0.5 mm ² x 1P
VCTF		0.5 mm ² (AWG20) or greater	Max. 37.8 Ω/km	Polychlorinated biphenyl	Max. 0.6 mm	Approx. 6.2 mm	VCTF-0.5 mm ² x 2C(JIS)



Note:

- Use shielded twisted pair cables.
- Use only one type of transmission cable. Do not mix more than 1 type.
- Twisted pair cables are recommended in noisy environments.
- When using shielded cable with crossover wiring for the RS485 transmission line, grounded one end.
- If two wires are connected to the plus terminal and minus terminal of RS485, use the wires of the same cross-sectional area which is 0.5 mm².

5.7.4 Baud Rate Setting (RS485 Type)

- Set the baud rate before installation when using the COM port.

System register settings

For using the FP0R (RS485 type), set the baud rate of the COM port to 115200 bps or 19200 bps. The default setting of the system register is 9600 bps.

Setting using FPWIN GR

Select "Options" > "PLC Configuration" > "COM Port" in the menu bar.

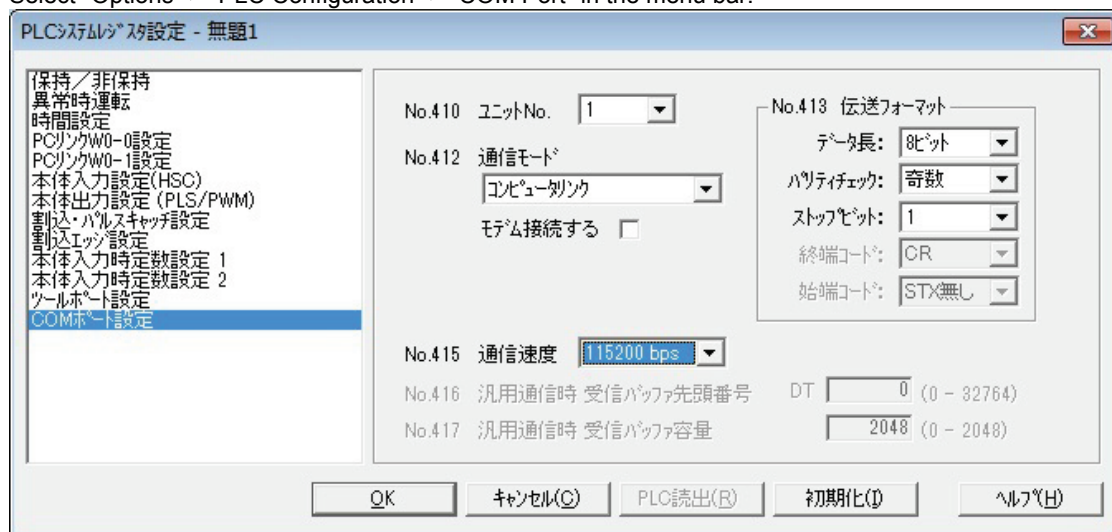

Setting of baud rate switches

As for the FP0R (RS485 type), the baud rate switches are built in the control unit. Set the baud rate switches to 115200 bps or 19200 bps. The initial setting (factory default) is 115200 bps.

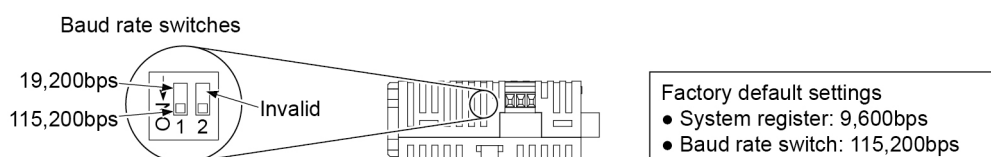

Note:

The factory settings of the system register and baud rate switches are different. Set the system register the same as the baud rate switches.

5.8 Safety Measures

5.8.1 Safety Measures

Precautions regarding system design

On the system using PLC, malfunction may occur for the following reasons:

- Power on timing differences between the PLC and input/output or mechanical power apparatus.
- Response time lag when a momentary power drop occurs.
- Abnormality in the PLC unit, external power supply, or other devices.

In order to prevent a malfunction resulting in system shutdown, choose the adequate safety measures listed in the following:

Interlock circuit

When a motor clockwise/counter-clockwise operation is controlled, provide an interlock circuit externally.

Emergency stop circuit

Provide an emergency stop circuit to the PLC externally to turn off the power supply of the output device.

Start up sequence

The PLC should be started after booting the I/O device and mechanical power apparatus. To keep this sequence, the following measures are recommended.

- Turn on the PLC with the mode selector set to the PROG. mode, and then switch to the RUN mode.
- Program the PLC so as to disregard the inputs and outputs until the outside devices are energized.

Note) In case of stopping the operation of the PLC also, have the input/output devices turned off after the PLC has stopped operating.

Grounding

When installing the controller next to devices that generate high voltages from switching, such as inverters, do not ground them together. Use an exclusive ground for each device.

5.8.2 Momentary Power Failures

Operation of momentary power failures

If the duration of the power failure is less than 5 ms, the FP0R continues to operate. If the power is off for 5 ms or longer, operation changes depending on the combination of units, the power supply voltage, and other factors.

(In some cases, operation may be the same as that for a power supply reset.)

5.8.3 Protection of Power Supply and Output Sections

Power supply

An insulated power supply with an internal protective circuit should be used. The power supply for the control unit operation is a non-insulated circuit, so if an incorrect voltage is directly applied, the internal circuit may be damaged or destroyed.

If using a power supply without a protective circuit, power should be supplied through a protective element such as fuse.

Protection of output

If current exceeding the rated control capacity is being supplied in the form of a motor lock current or a coil shorting in an electromagnetic device, a protective element such as a fuse should be attached externally.

Chapter 6

Preparation of USB Port

6.1 USB Connection

6.1.1 Precautions when connecting PLC with USB port

Note the following restriction for using a personal computer and PLC with USB connection.

PLC type	Applicable OS	FPWIN GR version
FP-X	Windows® 98 Windows® Me Windows® 2000 Windows® XP Windows Vista®	2.5 or later
FP0R	Windows® 2000 Windows® XP Windows Vista®	2.8 or later
FP-X, FP0R	Windows® 7	2.9 or later

Do not connect a computer to PLC with USB before installing FPWIN GR.

When connecting a personal computer to PLC with USB, the dialog boxes as below may be displayed. If the FPWIN GR has not been installed, click [Cancel] to close these dialog boxes.

Windows® XP

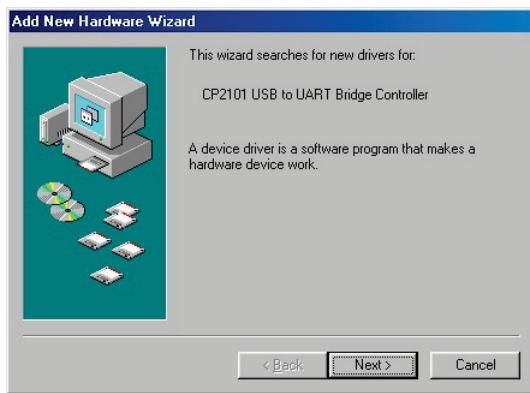

Windows® 98SE



For Windows® 7, although the following window appears, it will automatically disappear after a short time. (The driver is not installed.)

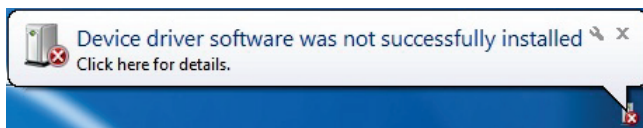
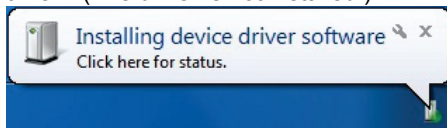

Restrictions on USB Communication

- The FP0R connected to the USB is recognized by the PC as that is connected through the COM port. When multiple FP0R units are connected to one PC with the USB, they cannot communicate with the PC simultaneously.
- The PC can communicate with the FP0R that was connected first only, and it cannot communicate with the other FP0R.
- A USB HUB cannot be used for the connection.

6.1.2 Installation of USB Driver

USB drivers must be installed to connect the unit with the USB.

The installation procedures differ depending on the OS in the PC to be used.



Note:

For the PC with more than one connector, it may be requested to reinstall these two drivers if the positions of the USB connectors are changed. In that case, reinstall the drivers.

Procedure of installing the driver (e.g.: Windows® XP)

1. Once the FP0R is connected, the following screen is displayed. Select “No, not this time”, and click “Next>”.

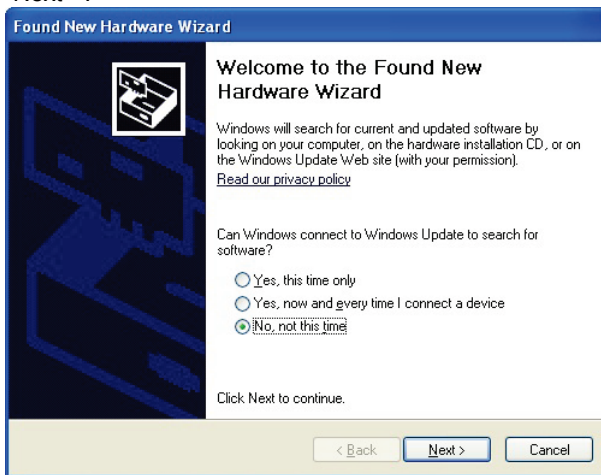

2. Select “Install from a list of specific location”, and click “Next>”.

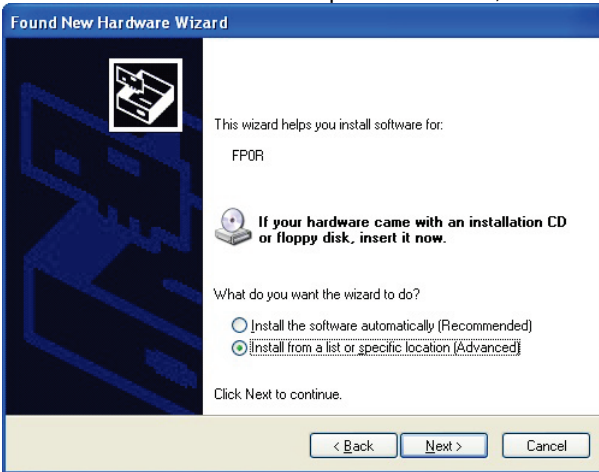

3. Select “Search for the best driver in these locations”, and check “Include this location in the search”. Then, click the “Browse” button to specify the folder that the USB driver of FP0R has been stored, and click “Next>”.

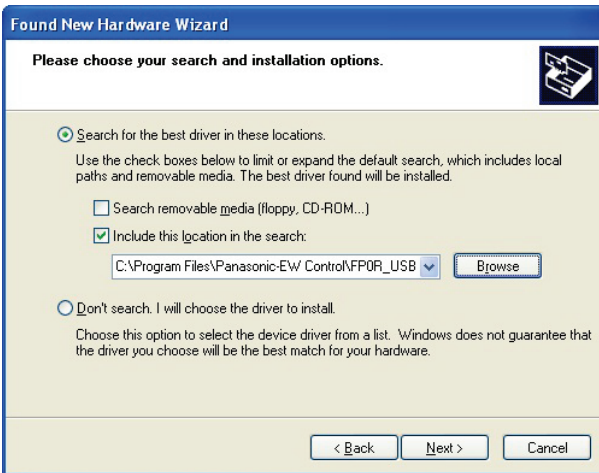

4. Although the following dialog box appears during the installation, click “Continue anyway”.



5. Click "Finish" on the following screen to be displayed.

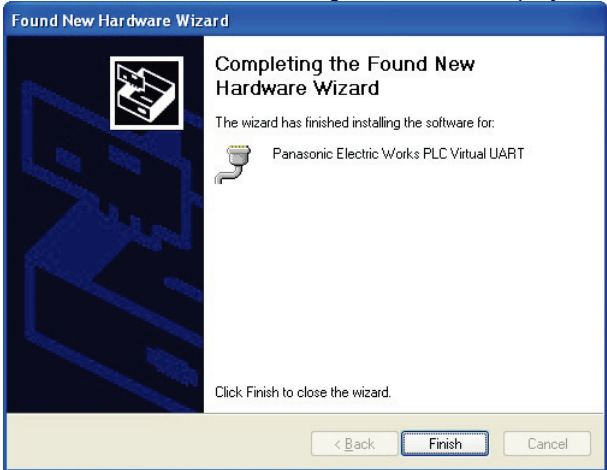

Procedure of installing the driver (e.g.: Windows® 7)

1. Once the FP0R is connected, the following screen is displayed. (It will automatically disappear after a short time.)

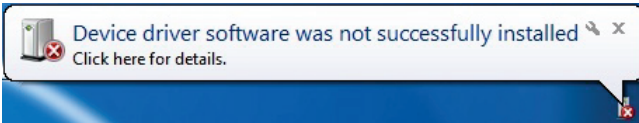
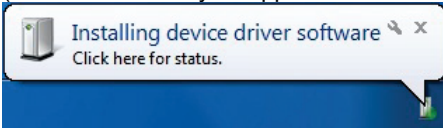

2. Click the start menu and move the mouse pointer to "Computer", and right-click on it to select "Properties".

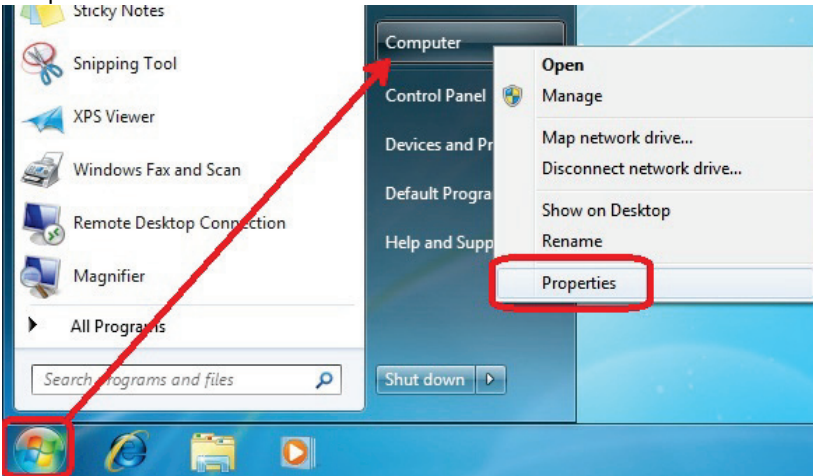

3. As the following screen is displayed, click "Device Manager".

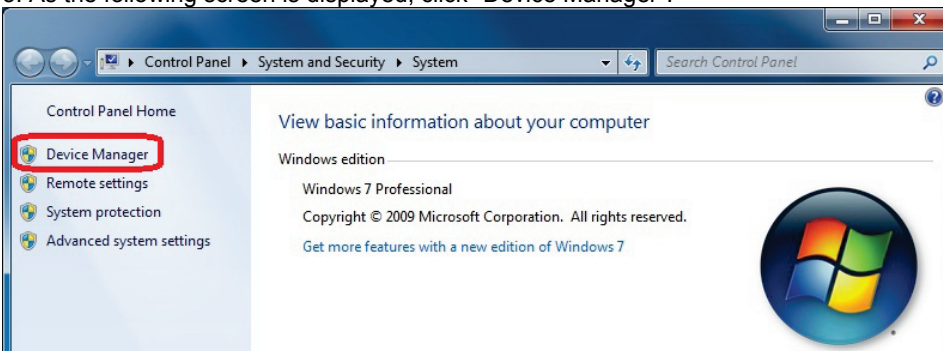

4. Double-click on "FP0R".

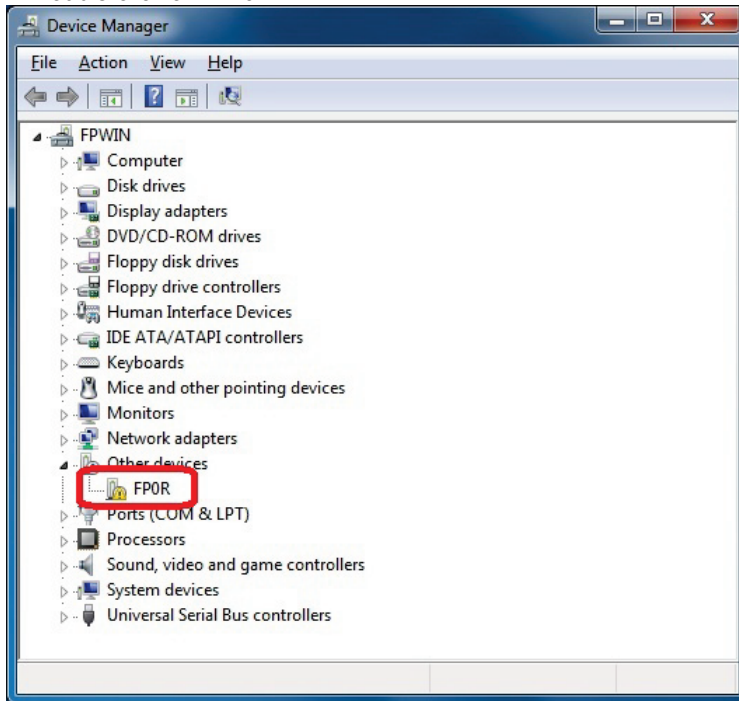

5. Click "Update Driver..."

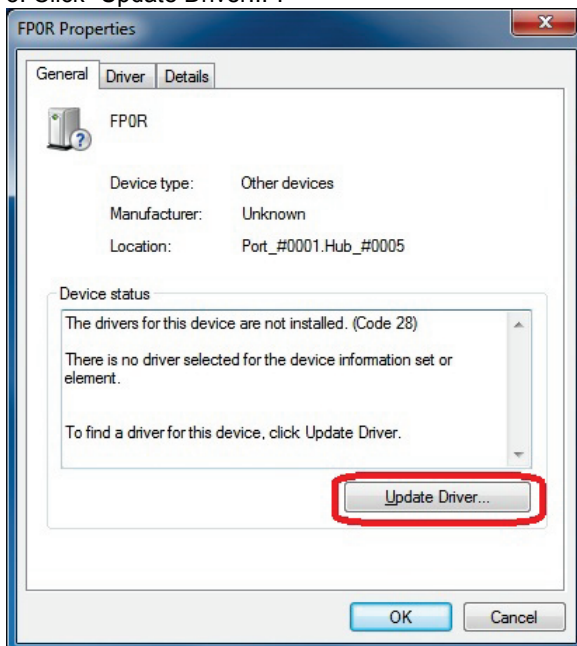

6. Click "Browse my computer for driver software".

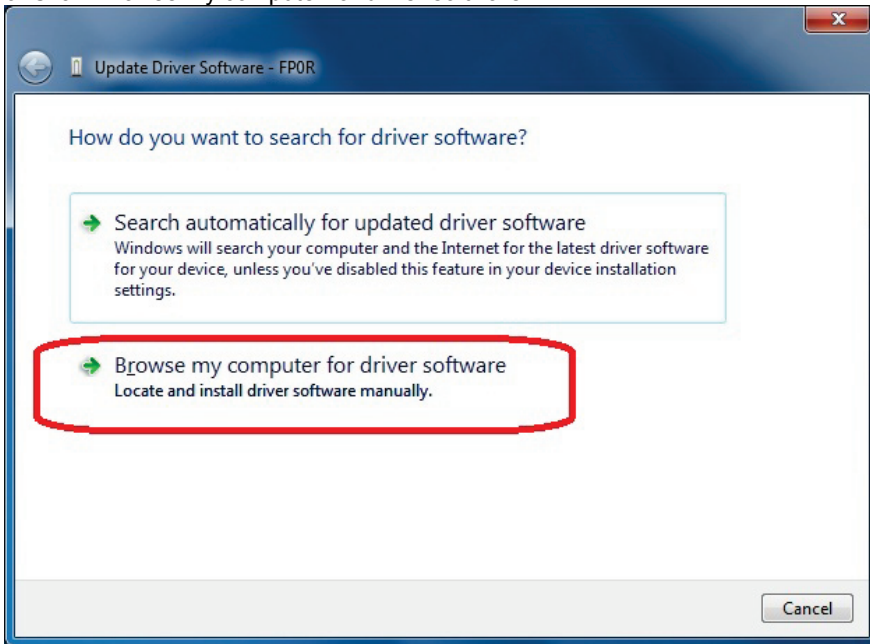

7. Click the "Browse..." button to specify the folder that the USB driver of FP0R has been stored, and click "Next".

If the location was not changed when installing FPWIN GR, the USB driver of FP0R has been stored in "C:\Program Files\Panasonic-EW SUNX Control\FP0R USB".

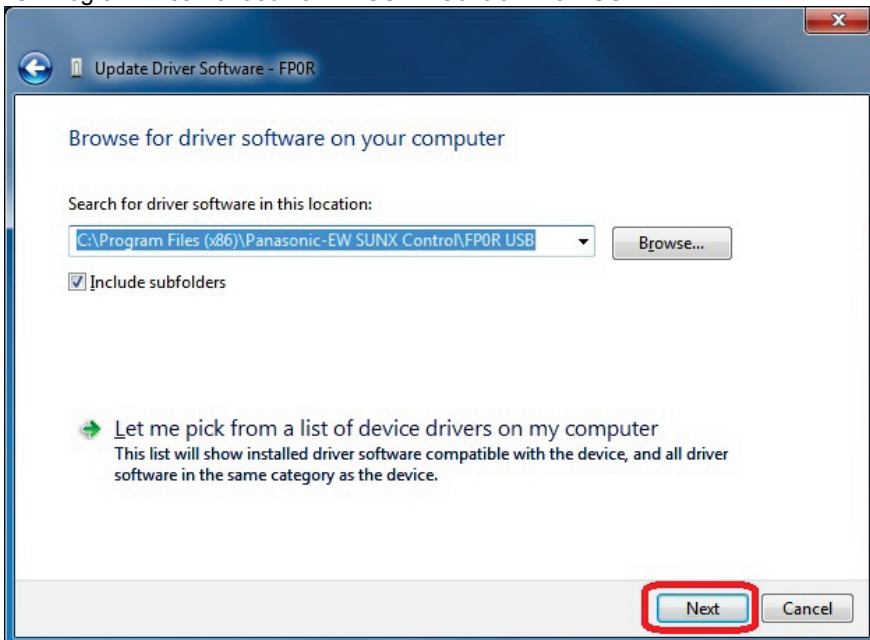

8. Although the following warning dialog box appears, click "Install this driver software anyway".

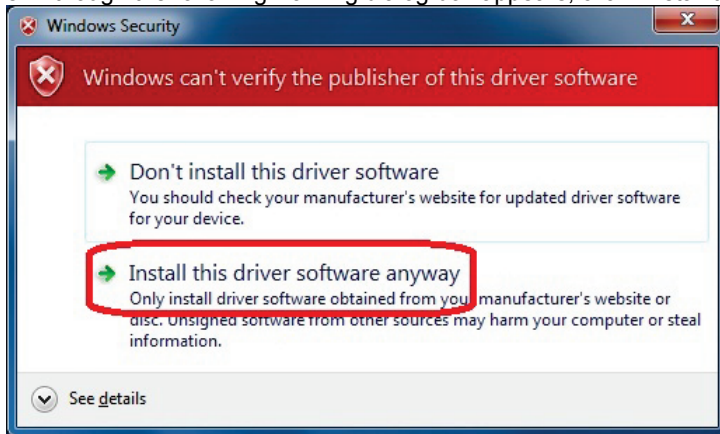

9. The installation of the driver software begins. Once the installation completes successfully, the following screen will be displayed.

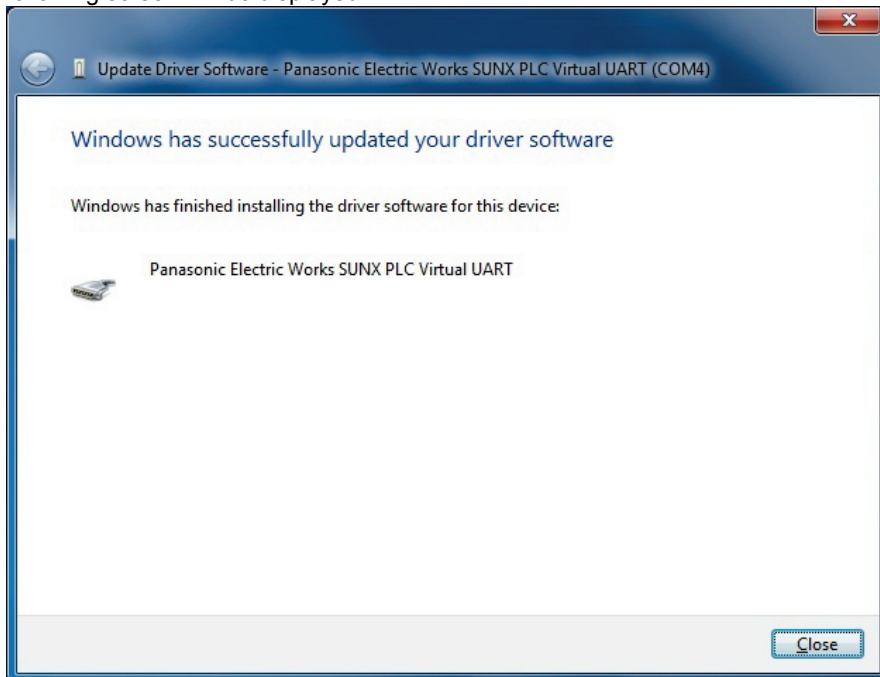

In this case, the USB port has been assigned to "COM4". However, it may differ depending on the environment of the PC you use.

6.1.3 Confirming COM Ports

The USB connected to the FP0R is recognized as a COM port by a PC. The COM port number assigned to the USB differs according to the PC environment.

How to confirm COM port

1. Connect the PLC and a PC with a USB cable.

2. Display "Device Manager".

For Windows Vista® or Windows® 7

Select "Windows Start Menu" > "Computer" > "System Properties" > "Device Manager".

For Windows XP

Select "My computer" > "View System information" > "Hardware" tab > "Device Manager".

3. Double-click "Ports (COM & LPT)". As the table of allocation of COM ports is shown, confirm the COM port number.

"Panasonic Electric Works PLC Virtual UART(COMn)" is the allocated COM port.

COM4 is allocated in the following display.

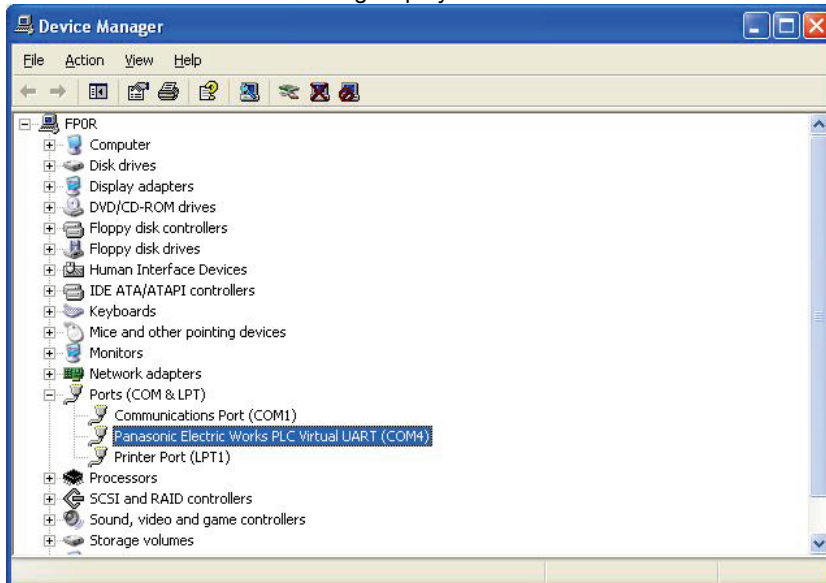

6.1.4 Communication with Programming Tool

The following communication setting should be specified to perform the communication with a programming tool (FPWIN GR/FPWIN Pro) using the USB.

1. Display the "Communication Setting" window from the programming tool.

<Using FPWIN GR>

Select "Communication Setting" under "Option" from the menu bar.

<Using FPWIN Pro>

Select "Communication Setting" under "Online" from the menu bar.

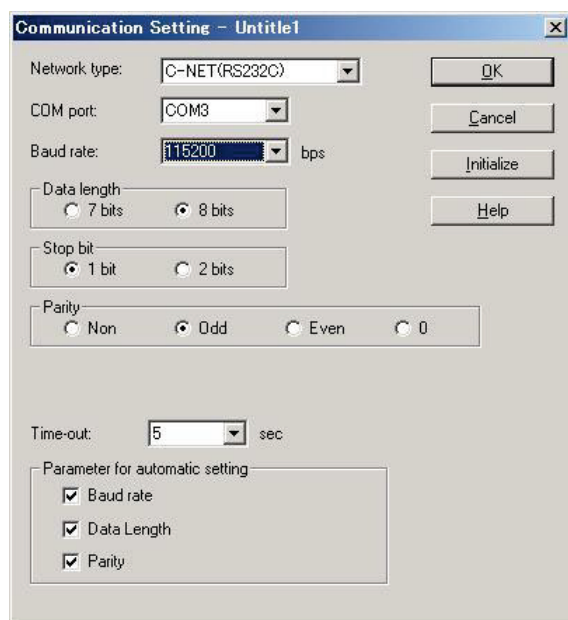

2. Specify the communication setting as the table below. Once the setting has been completed, the communication with the USB becomes available.

Network type	C-NET(RS232C)
Port No.	COM port number allocated for the USB
Baud rate	The baud rate cannot be specified. Even if any rate is selected, the setting will be invalid. (USB2.0 FullSpeed)
Data length	8 bits
Stop bit	1 bit
Parity	Odd

Chapter 7

Communication

7.1 Functions and Types

7.1.1 Communication Modes and Communication Ports

On the FP0R, four different communication modes are available. According to the communication mode to be used, the usable communication ports vary.

Communication mode	Usable communication port
Computer link	Tool port
	USB port
	COM port
General-purpose serial communication	Tool port
	COM port
PC(PLC) link	COM port
MODBUS RTU	COM port

7.1.2 Computer Link

- Computer link is used for communication with a computer connected to the PLC. Instructions (command messages) are transmitted to the PLC, and the PLC responds (sends response messages) based on the instructions received.
- A proprietary MEWNET protocol called MEWTOCOL-COM is used to exchange data between the computer and the PLC.
- The PLC answers automatically to the commands received from the computer, so no program is necessary on the PLC side in order to carry out communication.

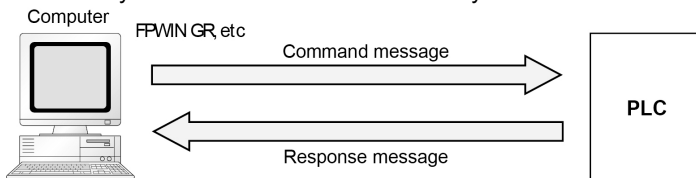

7.1.3 General-purpose Serial Communication

- With general-purpose serial communication, data can be sent back and forth between an external device connected such as an image processing device and a bar code reader.
- Reading and writing of data is done using a ladder program in the FP0R, while reading and writing of data from an external is handled through the data registers.

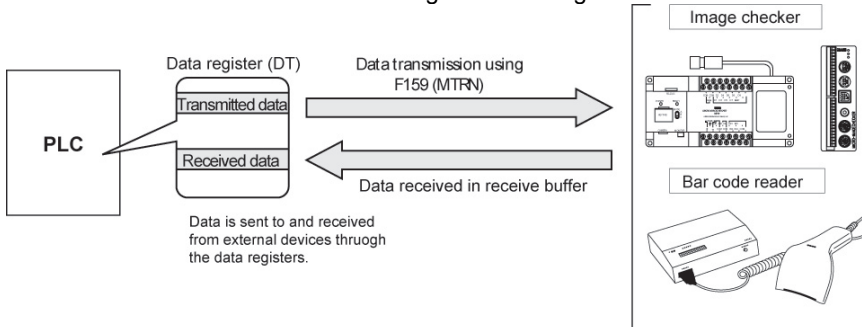

7.1.4 PC(PLC) Link

Using a commercial R232C/RS485 converter enables to configure a PC(PLC) link (MEWNET-W0) with the FP0R.

- Exclusive internal relays "link relays (L)" and data registers "link registers (LD)" are shared between the connected PLCs.

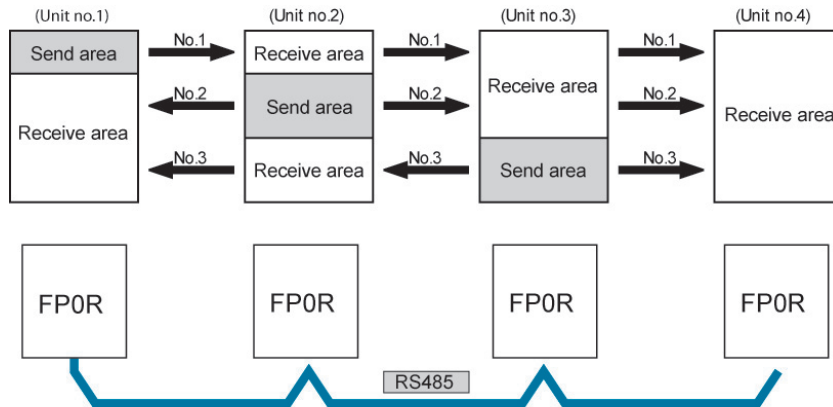

The link relays and link registers of the PLCs contain areas for sending and areas for receiving data. These areas are used to share data among the PLCs.

7.1.5 MODBUS RTU

Function overview

- The MODBUS RTU protocol enables the communication between the FP0R and other devices (including our FP-e, Programmable display GT series and KT temperature control unit).
- Communication is performed when the master unit sends instructions (command messages) to slave units and the slave unit returns responses (response messages) according to the instructions.

Master function

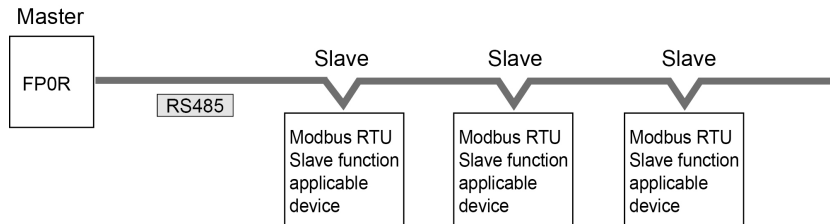

Slave function

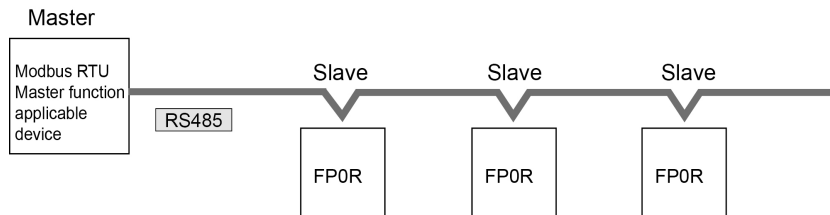

7.2 Communicaton Port Type

7.2.1 Tool Port

This connector is used to connect a programming tool.

A commercial mini-DIN 5-pin connector is used for the tool port on the control unit.

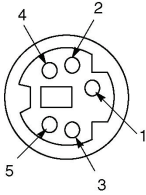

Pin No.	Signal name	Abbreviation	Signal direction
1	Signal Ground	SG	-
2	Send Data	SD	Unit → External device
3	Receive Data	RD	Unit ← External device
4	(Not used)	-	-
5	+5 V	+5 V	Unit → External device

7.2.2 USB Port

This connector is used to connect a programming tool.

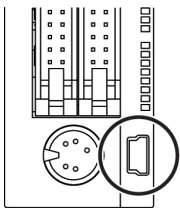

A commercial USB2.0 cable (A: miniB) can be used.

Standard	USB2.0
connector shape	USB miniB type

Note) The USB driver should be installed. It is assigned to a virtual COM port on the PC Select "RS232C(C-NET)" in a programming tool.

7.2.3 COM Port

It is a screw down connection type terminal block (3-pin).

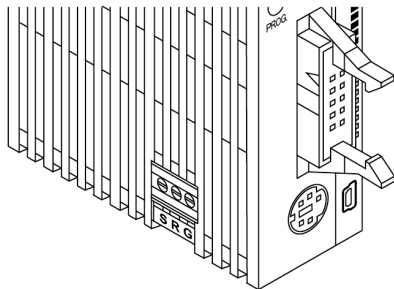

COM port (RS232C port) terminal layout

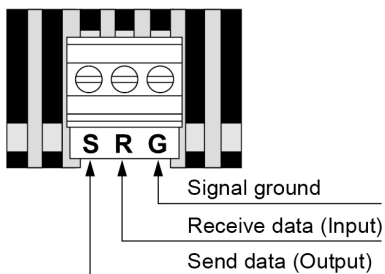

COM port (RS485 port) terminal layout

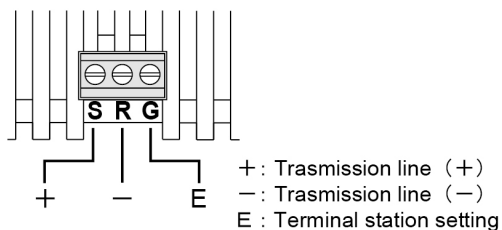

7.3 Communication Specifications

Tool Port

	Description
Interface	RS232C
Transmission distance	15 m
Baud rate	2400,4800,9600,19200,38400,57600,115200 bit/s
Communication method	Half-duplex communication
Synchronous method	Start stop synchronous system
Communication format	Data length: 7 bits/8bits Parity: None/Even/Odd Start code: STX/No STX End code: CR/CR+LF/None/ETX Stop bit: 1 bit/2 bits
Data transmission order	Transmits from bit 0 character by character.
Communication mode	Computer link (slave) Modem initialization General-purpose communication (only in RUN mode)

USB port

	Description
Standard (Baud rate)	USB2.0 Fullspeed
Communication mode	Computer link (slave)

COM port (RS232C port)

	Description
Interface	RS232C
Transmission distance	15 m
Baud rate	2400,4800,9600,19200,38400,57600,115200 bit/s
Communication method	Half-duplex communication
Synchronous method	Start stop synchronous system
Communication format	Data length: 7 bits/8bits Parity: None/Even/Odd Start code: STX/No STX End code: CR/CR+LF/None/ETX Stop bit: 1 bit/2 bits
Data transmission order	Transmits from bit 0 character by character.
Communication mode	Computer link (master/slave) Modem initialization General-purpose communication MODBUS RTU (master/slave) PC(PLC) link

Factory default settings

	Baud rate	Data length	Parity	Stop bit
Tool port	9600 bit/s	8 bits	Odd	1 bit
COM port (RS232C port)	9600 bit/s	8 bits	Odd	1 bit

COM port (RS485)

Item		Description
Interface		RS485
Communication mode		1:N communication
Transmission distance		Max. 1200 m ^{Note1) 2)}
Baud rate		19200, 115200 bps ^{Note2) 3)}
Communication method		Two-wire, half-duplex transmission
Synchronous method		Start stop synchronous system
Transmission line		Shielded twisted-pair cable or VCTF
Transmission code	Computer link	ASCII
	General-purpose serial communication	ASCII, Binary
	MODBUS RTU	Binary
Communication format (to be set by system register) ^{Note4)}	Data length	7bit / 8bit
	Parity	None/Even/Odd
	Stop bit	1bit / 2bit
	Start code	STX/No STX
	End code	CR/CR+LF/None/ETX
No. of connected units ^{Note2) 5)}		Max. 99 units (Max. 32 units when our C-ENT adapter is connected.)
Communication function		Computer link (master/slave) Modem initialization General-purpose serial communication Modbus RTU (Master/Slave) PC(PLC) link

Note1) When connecting a commercially available device that has an RS485 interface, please confirm operation using the actual device. In some cases, the number of units, transmission distance, and baud rate vary depending on the connected device.

Note2) The values for the transmission distance, baud rate and number of units should be within the values noted in the graph below.

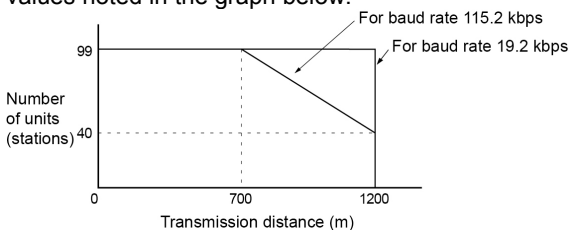

Note3) The settings of the baud rate switches on the side of the unit and the system register No. 415 should be the same. Only 19200 bps can be specified when the C-NET adapter is connected with the RS485 interface.

Note4) The start code and end code can be used only in the general-purpose serial communication mode.

Note5) Unit numbers should be registered by the system register.

Factory default settings

Port type	Baud rate	Data length	Parity	Stop bit
Tool port	9600 bit/s	8 bits	Odd	1 bit
COM port (RS485)	115200 bit/s	8 bits	Odd	1 bit



Note:

If the potential difference between the power supplies of RS485 devices exceeds 4 V, the unit may not communicate as it is the non-isolated type. The large potential difference leads to the damage to the devices.

7.4 Computer Link

7.4.1 Overview

- Computer link is used for communication with a computer connected to the PLC. Instructions (command messages) are transmitted to the PLC, and the PLC responds (sends response messages) based on the instructions received.
- A proprietary MEWNET protocol called MEWTOCOL-COM is used to exchange data between the computer and the PLC.
- The PLC answers automatically to the commands received from the computer, so no program is necessary on the PLC side in order to carry out communication.

- There are a MEWTOCOL master function and a MEWTOCOL slave function for the computer link. The side that issues commands is called master, and the side that receives the commands, executes the process and sends back responses is called slave.

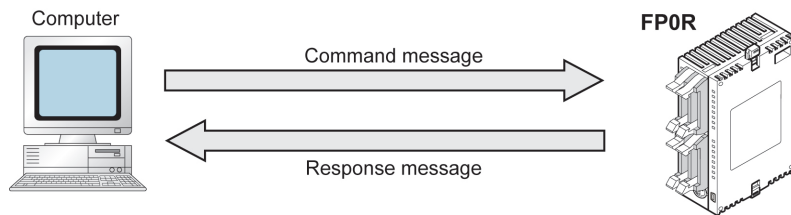

MEWTOCOL master function

- This function is to carry out the communication on the master side (side that issues commands) of the computer link. It is executed with the PLC's instruction F145(SEND) or F146(RECV). It is not necessary to write the response process as a ladder, so the program is easier than the general-purpose communication function.

The 1:1 or 1:N communication is available between our devices equipped with the computer link function and the MEWTOCOL-COM. **[Our devices (e.g.)]:** PLC, temperature control unit, eco-power meter, machine vision

MEWTOCOL slave function

- This function is to receive commands from the computer link, execute the process and send back the results. Any special ladder program is not necessary to use this function. (Set the communication conditions in the system registers.) It enables the 1:1 or 1:N communication with a master computer or PLC.
- The program for the computer side must be written in BASIC or C language according to the MEWTOCOL-COM. MEWTOCOL-COM contains the commands used to monitor and control PLC operation.



Note:

It is necessary to set the system register of the communication port to the computer link for using this function. Both the master and slave functions are available for the FP0R, however, only the slave function is available for the tool and USB ports.

7.4.2 MEWTOCOL Slave Function

Outline of operation

Command and response

- Instructions issued by the computer to the PLC are called commands.
- Messages sent back to the computer from the PLC are called responses. When the PLC receives a command, it processes the command regardless of the sequence program, and sends a response back to the computer. On the computer side, the execution result of the command can be confirmed by the transmitted response.

MEWTOCOL-COM sketch

- Communication is carried out in a conversational format, based on the MEWTOCOL-COM communication procedures.
- Data is sent in ASCII format.
- The computer has the first right of transmission.
- The right of transmission shifts back and forth between the computer and the PLC each time a message is sent.

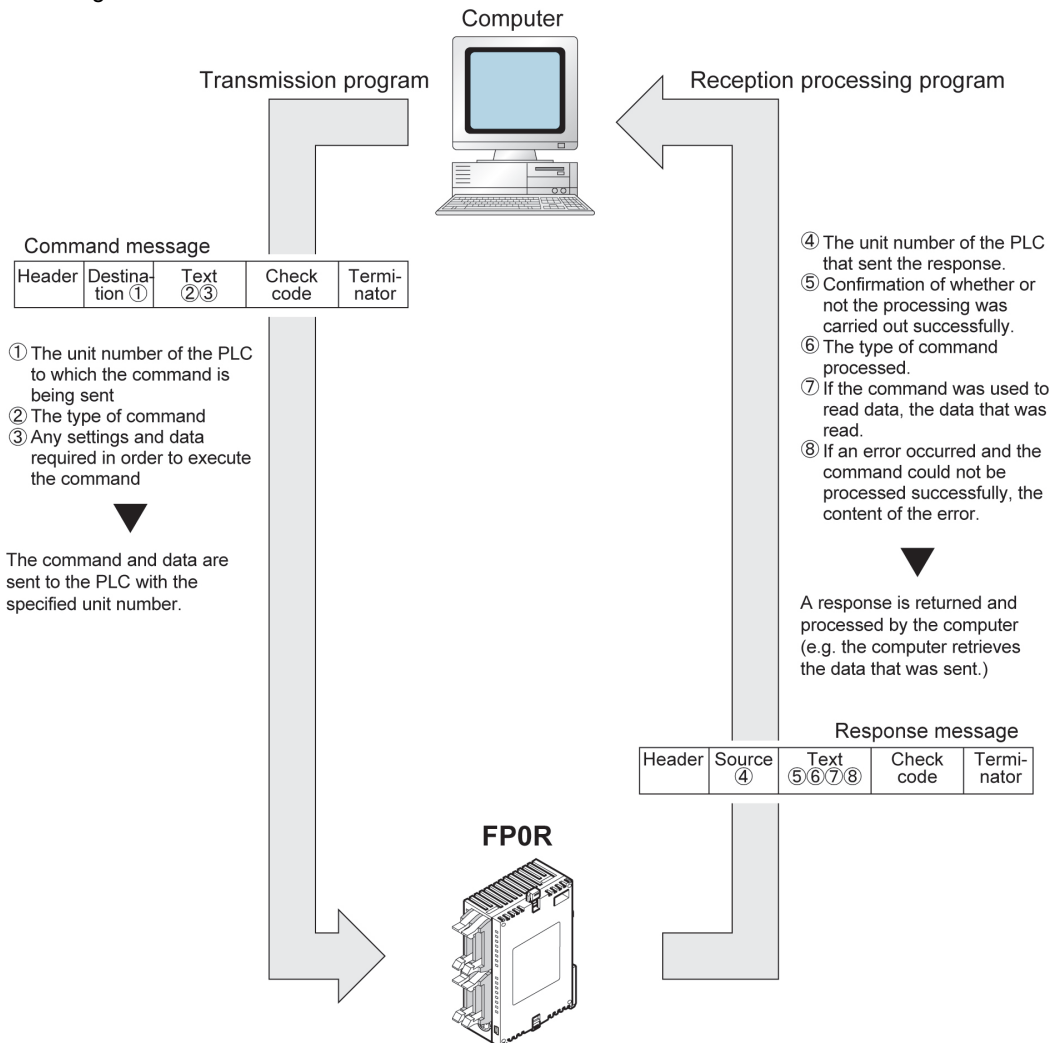

Format of command and response

Command message

All command-related items should be noted in the text segment. The unit number must be specified before sending the command.

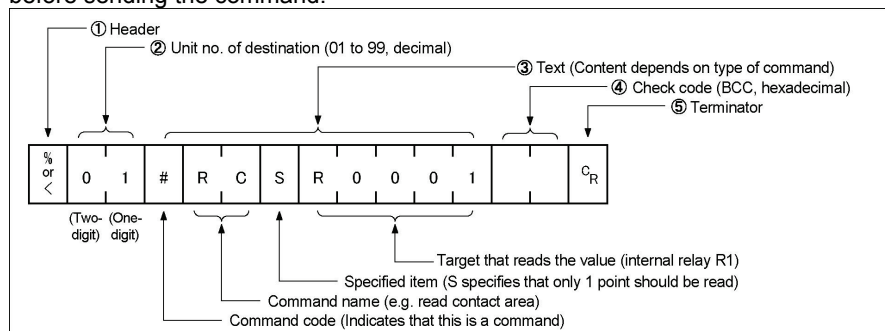

1. Header (Start code)

Commands must always have a "%" (ASCII code: H25) or a "<" (ASCII code: H3C) at the beginning of a message.

2. Unit number

The unit number of the PLC to which you want to send the command must be specified. In 1:1 communication, the unit number "01" (ASCII code: H3031) should be specified. The unit number of the PLC is specified by the system register.

3. Text

The content differs depending on the command. The content should be noted in all upper-case characters, following the fixed formula for the particular command.

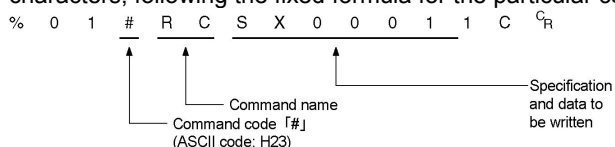

4. Check code

BCC (block check code) for error detection using horizontal parity. The BCC should be created so that it targets all of the text data from the header to the last text character.

The BCC starts from the header and checks each character in sequence, using the exclusive OR operation, and replaces the final result with character text. It is normally part of the calculation program and is created automatically.

The parity check can be skipped by entering "*" *" (ASCII code: H2A2A) instead of the BCC.

5. Terminator (End code)

Messages must always end with a "C_R" (ASCII code: H0D).



Note: When writing

- The method for writing text segments in the message varies depending on the type of command.
- If there is a large number of characters to be written, they may be divided and sent as several commands, if there is a large number of characters in the value that was loaded, they may be divided and several responses sent.



Key Point:

- With the FP0R, an expansion header "<" is supported to send single frame of up to 2048 characters as well as general "%".

Type of header	No. of characters that can be sent in 1 frame
%	Max. 118 characters
<	Max. 2048 characters

Response message

The PLC that received the command in the example above sends the processing results to the computer.

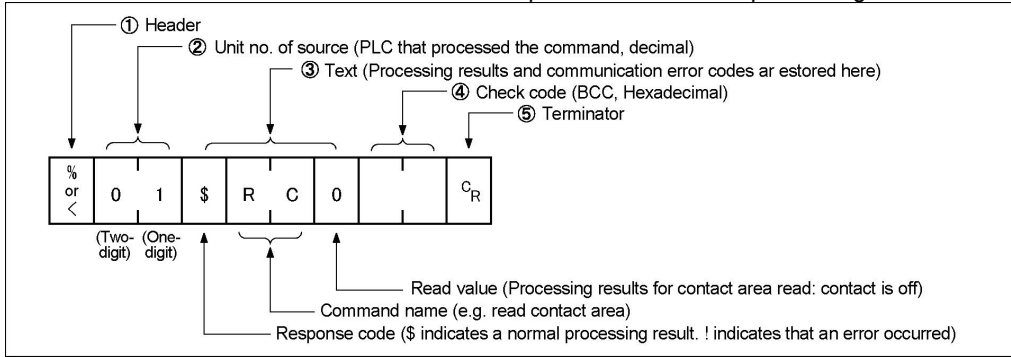

1. Header (Start code)

A "%" (ASCII code: H25) or a "<" (ASCII code: H3C) must be at the beginning of a message. The response must start with the same header that was at the beginning of the command.

2. Unit number

The unit number of the PLC that processed the command is stored here.

3. Text

The content of this varies depending on the type of command. If the processing is not completed successfully, an error code will be stored here, so that the content of the error can be checked.

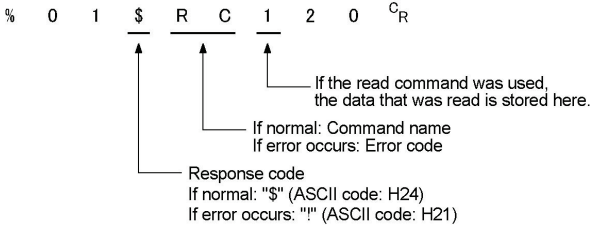

4. Check code

BCC (block check code) for error detection using horizontal parity. The BCC starts from the header and checks each character in sequence, using the exclusive OR operation, and replaces the final result with character text.

5. Terminator (End code)

There is always a "C_R" (ASCII code: H0D) at the end of the message.



Note: When reading

- If no response is returned, the communication format may not be correct, or the command may not have arrived at the PLC, or the PLC may not be functioning. Check to make sure all of the communication specifications (e.g. baud rate, data length, and parity) match between the computer and the PLC.
- If the response contains an "!" instead of a "\$", the command was not processed successfully. The response will contain a communication error code. Check the meaning of the error code.
- Unit number and command name are always identical in a command and its corresponding response (see below). This makes the correspondence between a command and a response clear.

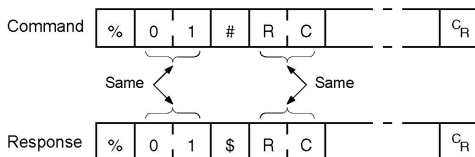

Commands to be used

Command name	Code	Description
Read contact area	RC (RCS) (RCP) (RCC)	Reads the on and off status of contacts. -Specifies only one point. -Specifies multiple contacts. -Specifies a range in word units.
Write contact area	WC (WCS) (WCP) (WCC)	Turns contacts on or off. -Specifies only one point. -Specifies multiple contacts. -Specifies a range in word units.
Read data area	RD	Reads the contents of a data area.
Write data area	WD	Writes data to a data area.
Read timer/counter set value area	RS	Reads the timer/counter setting value.
Write timer/counter set value area	WS	Writes the timer/counter setting value.
Read timer/counter elapsed value area	RK	Reads the timer/counter elapsed value.
Write timer/counter elapsed value area	WK	Writes the timer/counter elapsed value.
Register or Reset contacts monitored	MC	Registers the contact to be monitored.
Register or Reset data monitored	MD	Registers the data to be monitored.
Monitoring start	MG	Monitors a registered contact or data using MD and MC.
Preset contact area (fill command)	SC	Embeds the area of a specified range in a 16-point on and off pattern.
Preset data area (fill command)	SD	Writes the same contents to the data area of a specified range.
Read system register	RR	Reads the contents of a system register.
Write system register	WR	Specifies the contents of a system register.
Read the status of PLC	RT	Reads the specifications of the programmable controller and error codes if an error occurs.
Remote control	RM	Switches the operation mode of the programmable controller. (RUN mode <=> PROG. mode)
Abort	AB	Aborts communication.

7.4.3 Setting Communication Parameters

Tool port/COM port

The settings for baud rate and communication format are entered using a programming tool.



Note: When the MEWTOCOL master is used, also select "Computer Link". (COM port only)

Setting with FPWIN GR

Select "Options" in the menu bar, and then select "PLC Configuration". Click "**Tool Port**" or "**COM Port**" from the left list.

Dialog box of PLC system register setting (Tool port selection screen)

The screenshot shows the 'PLC Configuration - Untitle1' dialog box. On the left is a tree view with 'Tool Port' selected. The main area contains several settings:

- No. 410 Unit No.: 1
- No. 412 Comm. Mode: Computer Link (with a 'Modem Enabled' checkbox that is unchecked)
- No. 413 Communication Format: Char. Bit: 8 Bits, Parity: Odd, Stop Bit: 1, Terminator: CR, Header: STX not exist.
- No. 415 Baudrate: 9600 bps
- No. 420 Starting address for data received of serial data communication mode: DT 4096 (0-12314)
- No. 421 Buffer capacity setting for data received of serial data communication mode: 2048 (0-2048)

Buttons at the bottom include OK, Cancel, Read PLC, Initialize, and Help.

No. 410 Unit number

The unit number can be set within a range of 1 to 99.

No. 412 Communication mode

Select the operation mode of communication port operation mode. Click "Computer Link".

No. 413 Communication Format setting

The default setting of communication format is as below.

Set the communication format to match the external device connected to the communication port.

(The terminator and header cannot be changed.)

Char. Bit: 8 bits

Parity: Odd

Stop Bit: 1 bit

Terminator: Setting disable

Header: Setting disable

No. 415 Baud rate setting

The default setting for the baud rate is "9600 bps". Set the value to match the external device connected to the communication port. For using the RS485 type, make the same setting as that of the baud rate switches (19200 or 115200 bps).

USB port

The setting for the USB port is fixed. The setting for the communication parameter is not available.

7.4.4 1:1 Communication (MEWTOCOL Slave Function)

Overview

For a 1:1 computer link between the FP0R and a computer, and RS232C cable is needed. Communication is performed via commands from the computer and responses from the PLC.

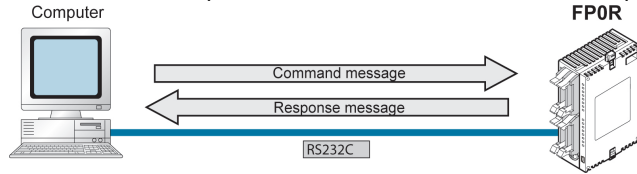

System register settings

No.	Name	Set value
No.410	Unit No.	1
No.412	Communication mode	Computer link
No.413	Communication format	Char. bit: 7 bits/8 bits Parity: None/Odd/Even Stop bit: 1 bit/2 bit Terminator: CR Header: No STX
No.415	Baud rate	2400 to 115200 bps

Note) The communication format and baud rate should be set to match the connected computer.

Programming of computer link

- For a computer link, a program should be created that allows command messages to be sent and response messages to be received on the computer side. No communication program is required on the PLC side. (Specify the communication format only by the system register.)
- The program for the computer side must be written in BASIC or C language according to the MEWTOCOL-COM. MEWTOCOL-COM contains the commands used to monitor and control PLC operation.

Example of connection to the computer <1:1 communication>

Tool port

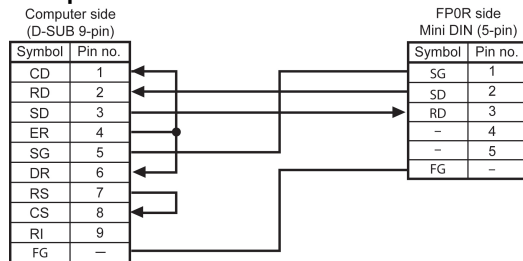

COM port (RS232C port)

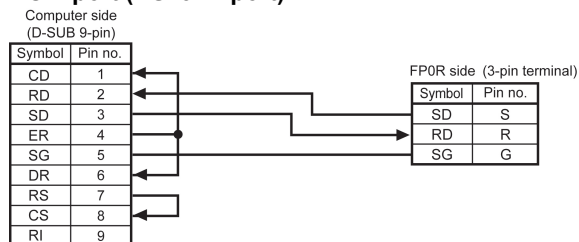

7.4.5 1:N Communication (MEWTOCOL Slave Function)

A computer and PLCs are connected through a commercially available RS232C-RS485 converter, and the respective computer and PLCs are wired using an RS485 cable with crossover wiring. The computer and the PLC communicate via commands and responses: The computer sends a command specifying the unit number, and the PLC with that unit number sends a response back to the computer.

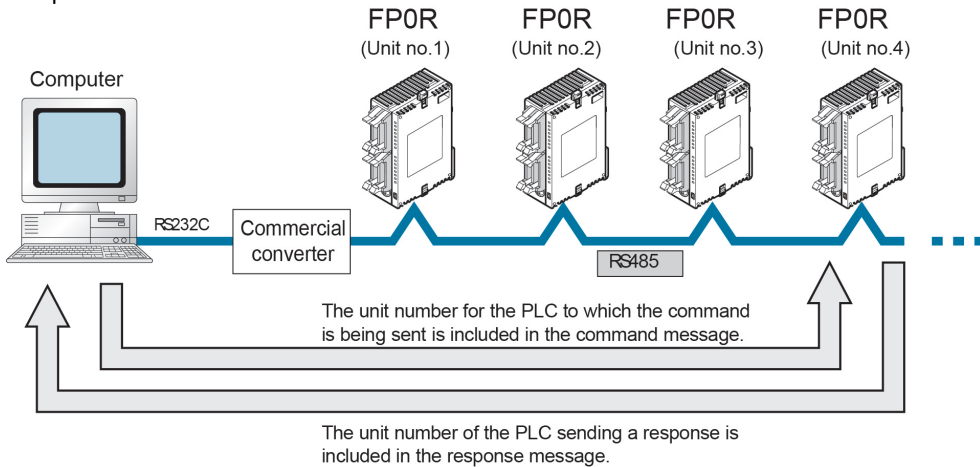

Note) LINEEYE CO., LTD SI-35 is recommended to be used as a converter. For the RS232C-type COM port, a RS232C-RS485 conversion adapter is also required on the PLC side.

Setting of unit numbers

By default, the unit number for each communication port is set to 1 in the system register settings. There is no need to change this for 1:1 communication, but if 1:N communication is used to connect multiple PLCs to the transmission line (e.g. in a C-NET), the unit number must be specified so that the destination of the command can be identified.

The unit number is specified by using the system register.

Setting system registers

No.	Name	Set Value
No. 410	Unit number	1 to 99 (Set the desired unit number) (With a C-NET adapter, a maximum of 32 units (stations) can be specified.)
No. 412	Communication mode	Computer link
No. 413	Communication format	Char. bit: 7 bits/8 bits Parity: None/Odd/Even Stop bit: 1 bit/2 bit Terminator: CR Header: STX not exist
No. 415	Baud rate ^{Note2)}	2400 to 115200 bps

Note1) The communication format and baud rate should be set to match the connected computer.

Note2) The baud rates of 300, 600 and 1200 bps can be specified by the SYS1 instruction.

For using the RS485 type, make the same setting as that of the baud rate switches (19200 or 115200 bps).

7.4.6 MEWTOCOL Master

Use the F145 (SEND) "Data send" or F146 (RECV) "Data receive" instruction to use the MEWTOCOL master function.

Communication port

The MEWTOCOL master is not available for the tool port. It is available for the COM port only.

Sample program

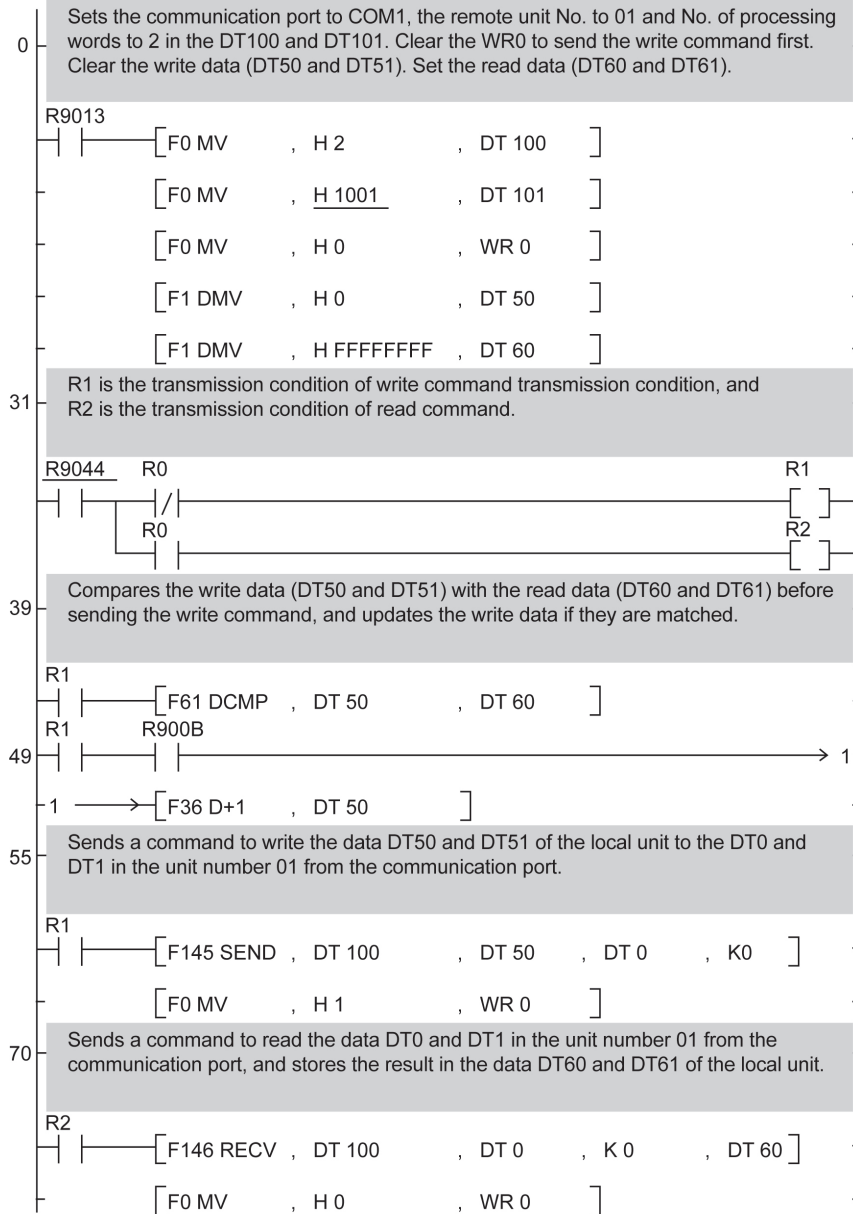

Flowchart

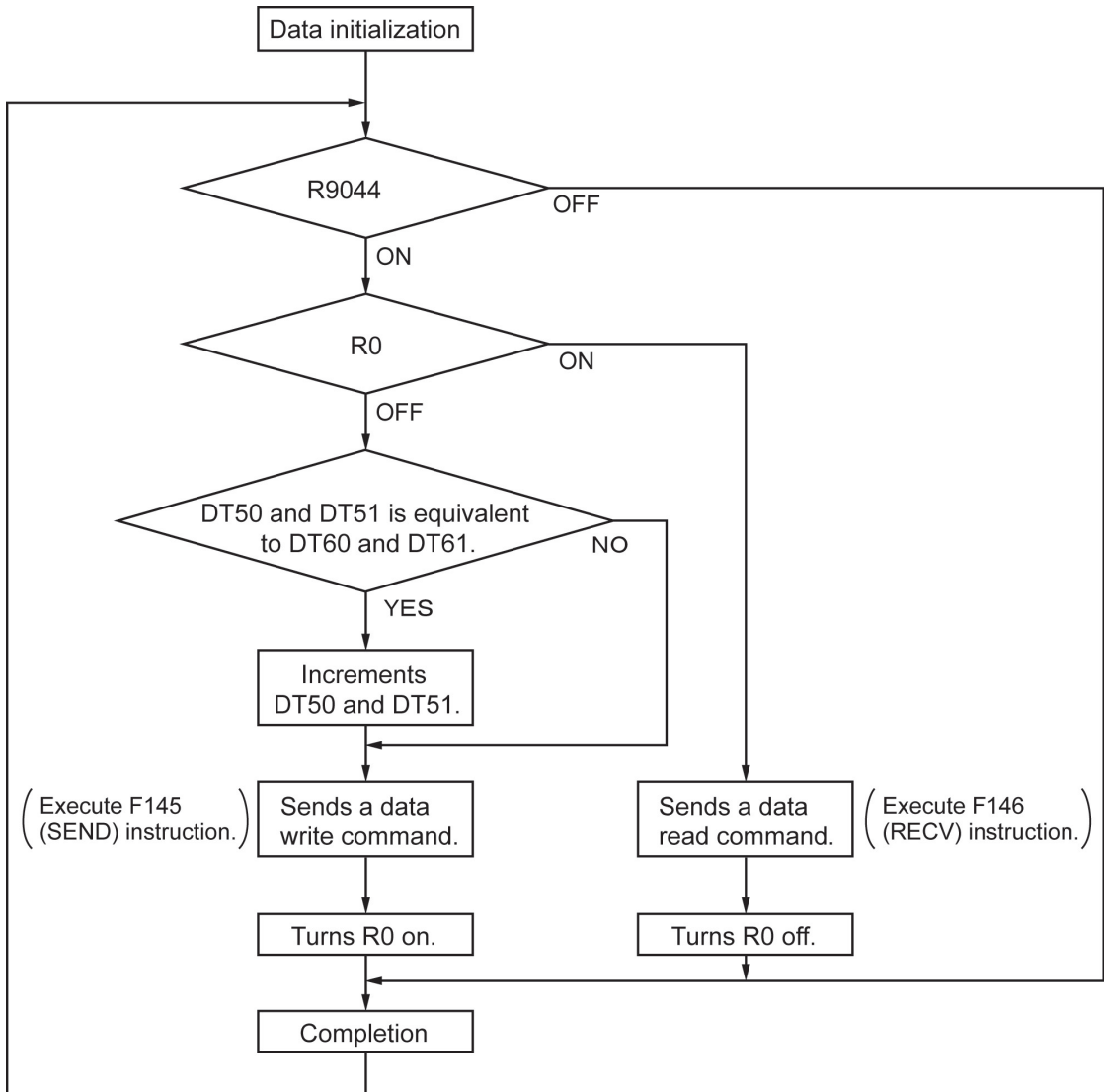

With the above program, the procedures 1 to 3 are executed repeatedly.

1. Updates the write data if the write data (DT50 and DT51) and the read data (DT60 and DT61) are matched.
2. Writes the DT50 and DT51 of the local unit into the data DT0 and DT1 in the unit number 1 from the COM port.
3. Reads the DT0 and DT1 in the unit number 1 into the data DT60 and DT61 of the local unit from the COM port.

7.4.7 Setting in Compatibility Mode with FP0 (FP0 Compatibility Mode)

Setting Communication Parameters

Confirm that the model of the programming tool is FP0.

Note) Only the salve function is available in the FP0 compatibility mode.

Usable communication ports on FP0R (FP0 compatibility mode)

Tool port

USB port (No communication parameter)

COM port (RS232C port)

Tool port settings

Dialog box of PLC system register setting

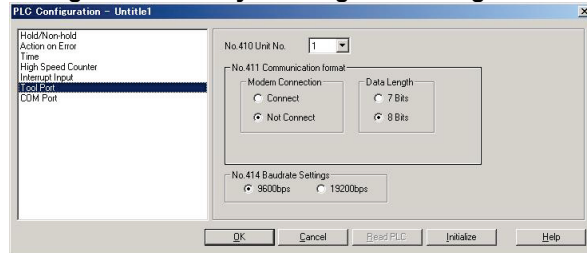

No. 410 Unit number

The unit number can be set within a range of 1 to 32.

No. 411 Communication format

Modem connection: Connect/Not Connect

Char. bit: 7 bits/8 bits

- Change the value to match the connected external device.

No. 414 Baud rate setting

The baud rate of 9600 or 19200 bps can be selected. Specify the value to match the connected external device.

COM port (RS232C port) settings

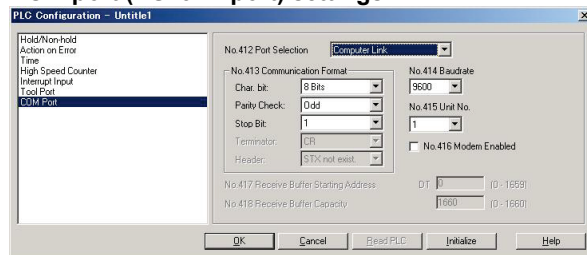

No. 412 Mode selection

Select the computer link.

No. 413 Communication Format

Char. Bit: 7 bits/8 bits

Parity: None/Odd/Even

Stop bit: 1 bit/2 bits

Terminator: CR

Header: STX not exist

- Change the value to match the connected external device.

No. 414 Baud rate

Select one of the values from "300, 600, 1200, 2400, 4800, 9600 and 19200 bps".

No. 415 Unit number

The unit number can be set within a range of 1 to 32.

No. 416 Modem enabled

Check the box to connect a modem.

7.5 General-purpose Serial Communication

7.5.1 Overview

- In general-purpose serial communication, data is sent and received over the communication port to and from an external device such as an image processing device or a bar code reader.
- Data is read from and written to an external device connected to the communication port by means of an FP0R program and the FP0R data registers.

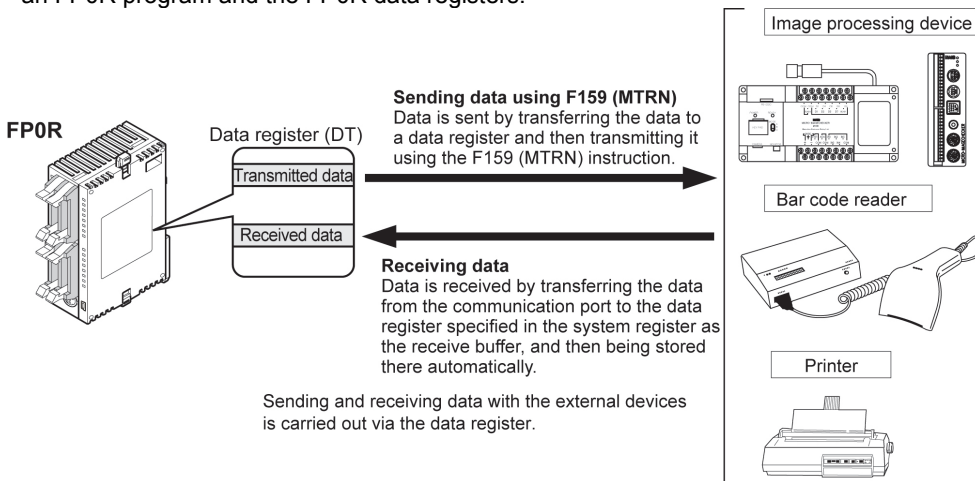

Outline of operation

To send data to and receive it from an external device using the general-purpose serial communication function, the data transmission and data reception functions described below are used. The F159 (MTRN) instruction and the "reception done" flag are used in these operations, to transfer data between the PLC and an external device.

Sending data

Data to be transmitted from the PLC is stored in the data register used as the send buffer (DT). When F159(MTRN) is executed, the data is output from the communication port.

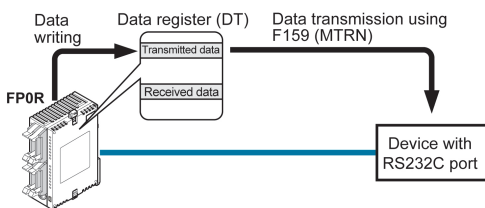

- The terminator specified in the system register is automatically added to the data that has been sent.
- The maximum volume of data that can be sent is 2048 bytes.

Receiving data

Data received from the communication port is stored in the receive buffer specified in the system register, and the "reception done" flag goes on. Data can be received whenever the "reception done" flag is off.

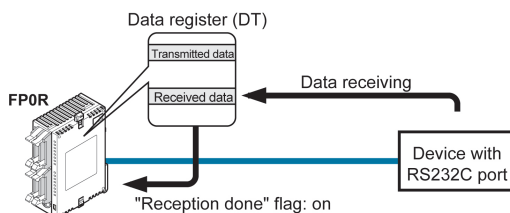

- When data is being received, the "reception done" flag is controlled by the F159(MTRN) instruction.
- No terminator is included in the stored data.
- The maximum volume of data that can be received is 4094 bytes.



Key Point: In the compatibility mode with the FP0 (FP0 compatibility mode), the F159(MTRN) instruction is changed to the F144(TRNS) instruction.

Communication Port

- Tool port
- COM port

7.5.2 Programming Example of General-purpose Serial Communication

The F159(MTRN) instruction is used to send and receive data via the specified communication port.

F159 (MTRN) instruction

Data is sent and received via the specified COM port .

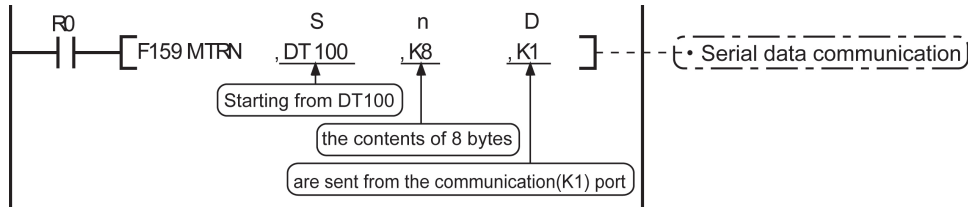

Devices that can be specified for S: Only data registers (DT) can be specified as the send buffer.

Devices that can be specified for n: WX, WY, WR, WL, SV, EV, DT, LD, I (I0 to ID), K, H

Devices that can be specified for D: Only the K constants (K0 and K1 only)

Sending data

The amount of data specified by n is sent to the external device from among the data stored in the data table, starting with the area specified by S, through the communication port specified by D. Data can be sent with the header and terminator automatically attached. A maximum of 2048 bytes can be sent.

When the above program is run, the eight bytes of data contained in DT101 to DT104 and stored in the send buffer starting from DT100 are sent from the communication port.

Receiving data

Data can be received when the “reception done” flag is off. The received data is stored in the receive buffer specified by the system register. When the reception of the data is completed (the terminator is received), the “reception done” flag turns on, and subsequently, receiving data is prohibited. To receive the next data, execute the F159 (MTRN) instruction and turn the “reception done” flag off to clear the number of received bytes to 0. To receive data continuously without sending data, clear the number of transmitted bytes to 0 (set “n” to “K0”), and then execute the F159 (MTRN) instruction.

Binary communication

Selecting “STX not exist” for the header and “None” for the terminator in the general-purpose serial communication enables the binary communication.

Sending data: Sends the data of bytes to be specified.

Receiving data: Check the No. of bytes received before the process. At that time, the reception done flag does not work.

Data to be sent/received with FP0R

Remember the following when accessing data in the FP0R send and receive buffers:

- If a header has been chosen in the communication format settings, the code STX (H02) will automatically be added at the beginning of the data begin sent.
- The data without the code STX at the reception is stored in the receive buffer, and the “reception done” flag turns on when the terminator (end code) is received. When the terminator has been set to “None”, the “reception done” flag does not work.
However, if the code STX is added in the middle of the data, the number of received byte is cleared to 0, and the data is stored from the beginning of the receive buffer again.
- A terminator is automatically added to the end of the data being sent.
- There is no terminator on the data stored in the receive buffer.

Sending data:

Data written to the send buffer will be sent just as it is.

Example:

The data “12345” is transmitted as an ASCII code to an external device.

1. Data sent using the F95 (ASC) instruction should be converted to ASCII code data.

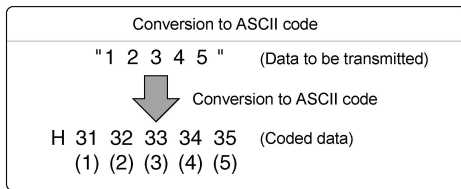

2. If DT100 is being used as the start address of send buffer, data will be stored in sequential order in the data registers starting from the next register (DT101), in two-byte units consisting of the upper and the lower byte.

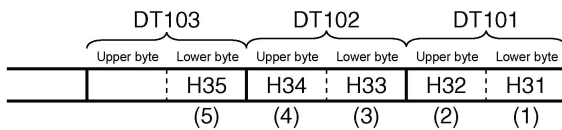

Receiving data:

The data of the receive area being read is ASCII code data.

Example:

The data “12345_R” is transmitted from a device with RS232C port.

If DT200 is being used as the receive buffer, received data will be stored in the registers starting from DT201, in sequential order of first the lower byte and then the upper byte.

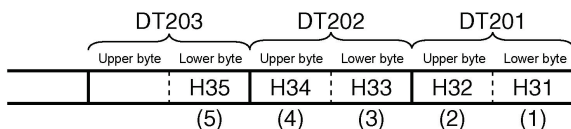

7.5.3 Sending Data

Communication with external devices is handled through the data registers. Data to be output is stored in the data register used as the send buffer (DT), and when the F159 (MTRN) instruction is executed, the data is output from the communication port.

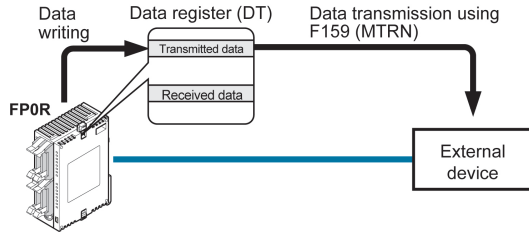

Data table for transmission (send buffer)

DT100	K8		When transmission begins: K8 When transmission ends: K0 Reduces one by one at every transmission. Data is transmitted in order from the low order byte. Binary data can be transmitted.
DT101	H42(B)	H41(A)	
DT102	H44(D)	H43(C)	
DT103	H46(F)	H45(E)	
DT104	H48(H)	H47(G)	

Data table before transmission

Sample program for sending data

The following program transmits the characters "ABCDEFGH (Hex)" to an external device using the communication port.

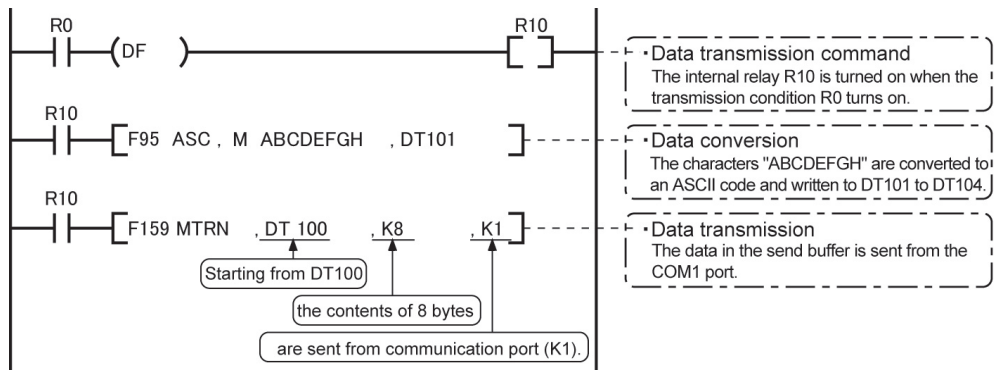

The program described above is executed in the following sequence.

- 1) "ABCDEFGH" is converted to an ASCII code and stored in a data register.
- 2) The data is sent from the communication port using the F159 (MTRN) instruction.

Explanatory diagram

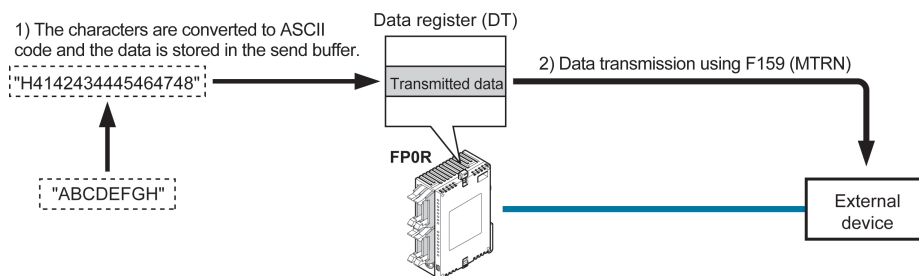

Explanation of data table

The data table for transmission starts at the data register specified in S.

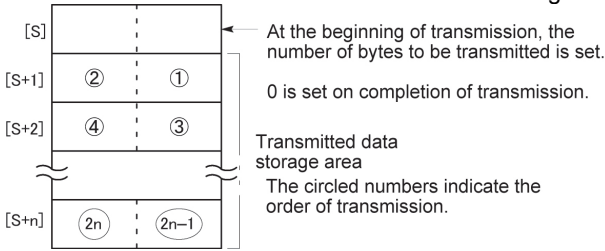

- Use an F0 (MV) or F95 (ASC) instruction to write the data to be transmitted to the transmission data storage area specified in S.

Transmission process

When the execution condition of the F159 (MTRN) instruction turns on and the “transmission done” flag R9039 is on, operation is as follows:

1. The number of transmission data [N] is preset in the start address of send buffer [S]. The “reception done” flag R9038 is turned off, and the reception data number is cleared to 0.

2. The set data is transmitted in order from the lower-order byte in S+1 of the table.

- During transmission, the “transmission done” flag R9039 turns off.
- If system register 413 is set to header (start code) with STX, the header is automatically added to the beginning of the data.
- The terminator (end code) specified in system register 413 is automatically added to the end of the data.

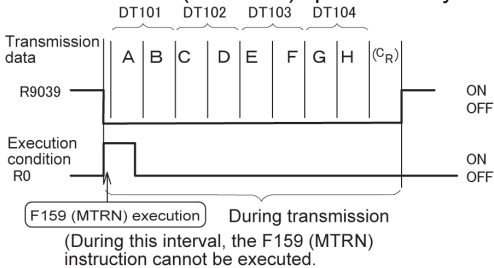

3. When all of the specified quantity of data has been transmitted, the S value is cleared to 0 and the “transmission done” flag R9039 turns on.

When you do not wish to add the terminator (end code) during transmissions:

- Specify the number of bytes to be transmitted using a negative number.
- If you also do not wish to add a terminator to received data, set system register 413 to “Terminator - None”.

Programming example:

The following program transmits 8 bytes of data without adding the terminator.

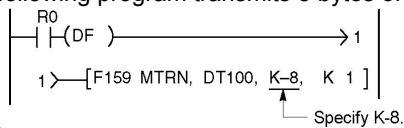

Key Point:

- Do not include the terminator (end code) in the transmission data. The terminator is added automatically.
- When “STX exist” is specified for the header (start code) in system register 413, do not add the header to the transmission data. The header is added automatically.

7.5.4 Receiving Data

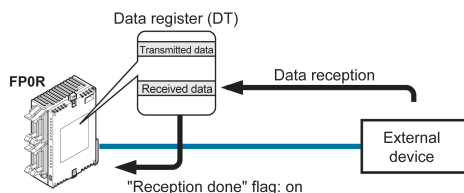

Data input from the communication port is stored in the receive buffer specified by the system register, and the “reception done” flag goes on. If the “reception done” flag is off, data can be received at any time.

Data table for reception (receive buffer)

This is the state when the above program is executed.

DT200	K8		The received number of bytes is stored as data is stored. Received data is stored in order from the lower-order byte.
DT201	H42(B)	H41(A)	
DT202	H44(D)	H43(C)	
DT203	H46(F)	H45(E)	
DT204	H48(H)	H47(G)	

Receive buffer when reception is completed.

DT200 to DT204 are used as the receive buffer.

System register settings are as follows:

- System register 416: K200

- System register 417: K5

Sample program for receiving data

8-byte data received in the receive buffer through the communication port 1 are copied to DT0.

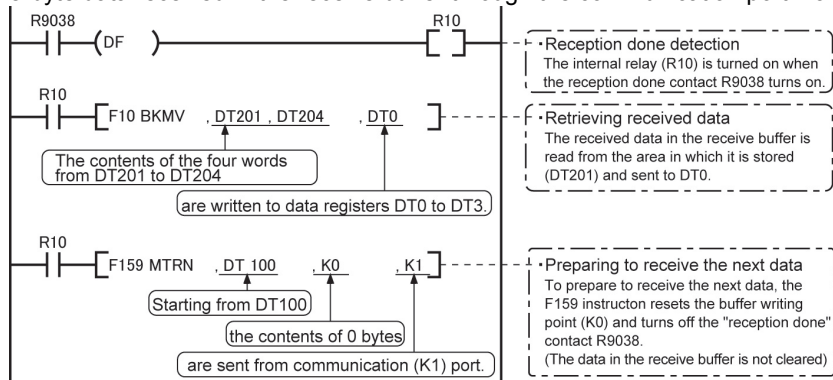

The program described above is executed in the following sequence.

- 1) The data sent from external devices is stored in the receive buffer.
- 2) The “reception done” contact R9038 is turned on.
- 3) The received data is sent from the receive buffer to the area starting with data register DT0.
- 4) The F159 (MTRN) instruction is executed with no data to clear the number of received bytes and to turn off the reception done” contact R9038. The system is now ready to receive the next data. (The data in the receive buffer is not cleared.)



Note:

Be aware that the “reception done” flag R9038 changes even while a scan is in progress (e.g., if the “reception done” flag is used multiple times as an input condition, there is a possibility of different statuses existing within the same scan.) To prevent multiple read access to the special internal relay you should generate a copy of it at the beginning of the program.

Explanatory diagram

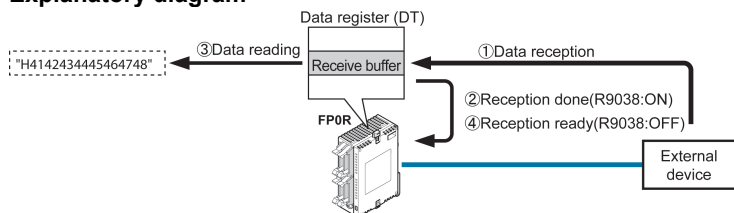

Explanation of data table

Data sent from an external device connected to the communication port is stored in the data registers that have been set as the receive buffer.

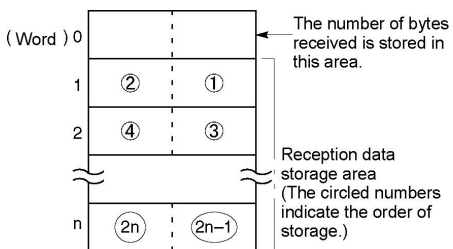

- Specify the data registers in system register 416 to 419.
- The number of bytes of data received is stored in the starting address of the receive buffer. The initial value is 0.
- Received data is stored in the received data storage area in order from the lower-order byte.

Reception process

When the “reception done” flag R9038 is off, operation takes place as follows when data is sent from an external device. (The R9038 flag is off during the first scan after RUN).

1. Incoming data is stored in order from the lower-order byte of the 2nd-word area of the receive buffer. Header and terminator (start and end codes) are not stored.

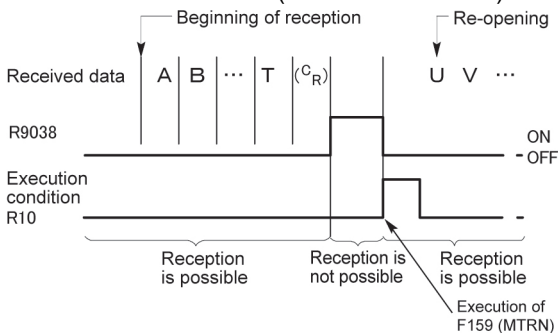

2. When the terminator (end code) is received, the “reception done” flag R9038 turns on. Reception of any further data is prohibited. When the terminator has been set to “None”, the “reception done” flag does not turn on. Check the number of received bytes to judge whether the reception has completed or not.
3. When an F159 (MTRN) instruction is executed, the “reception done” flag R9038 turns off (except the case when the terminator has been set to “None”), the number of received bytes is cleared, and subsequent data is stored in order from the lower-order byte.

For repeated reception of data, perform the following steps:

1. Receive data
2. Reception done (R9038: on, reception prohibited)
3. Process received data
4. Execute F159 (MTRN) (R9038: off, reception possible)
5. Receive subsequent data

Prepare for reception

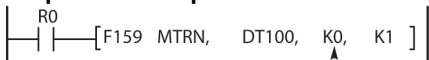

- To repeatedly perform only reception, specify K0.
- R9038 also turns off when transmission is performed with a byte number specification.

- The “reception done” flag R9038 turns on when data reception from the external device is completed. Reception of any further data is prohibited.
- To receive subsequent data, you must execute the F159 (MTRN) instruction to turn off the “reception done” flag R9038.

7.5.5 Flag Operation in Serial Communication

Header: No-STX, Terminator: CR

Receiving data:

The “reception done” flag, the “transmission done” flag, and the F159 (MTRN) instruction are related as follows:

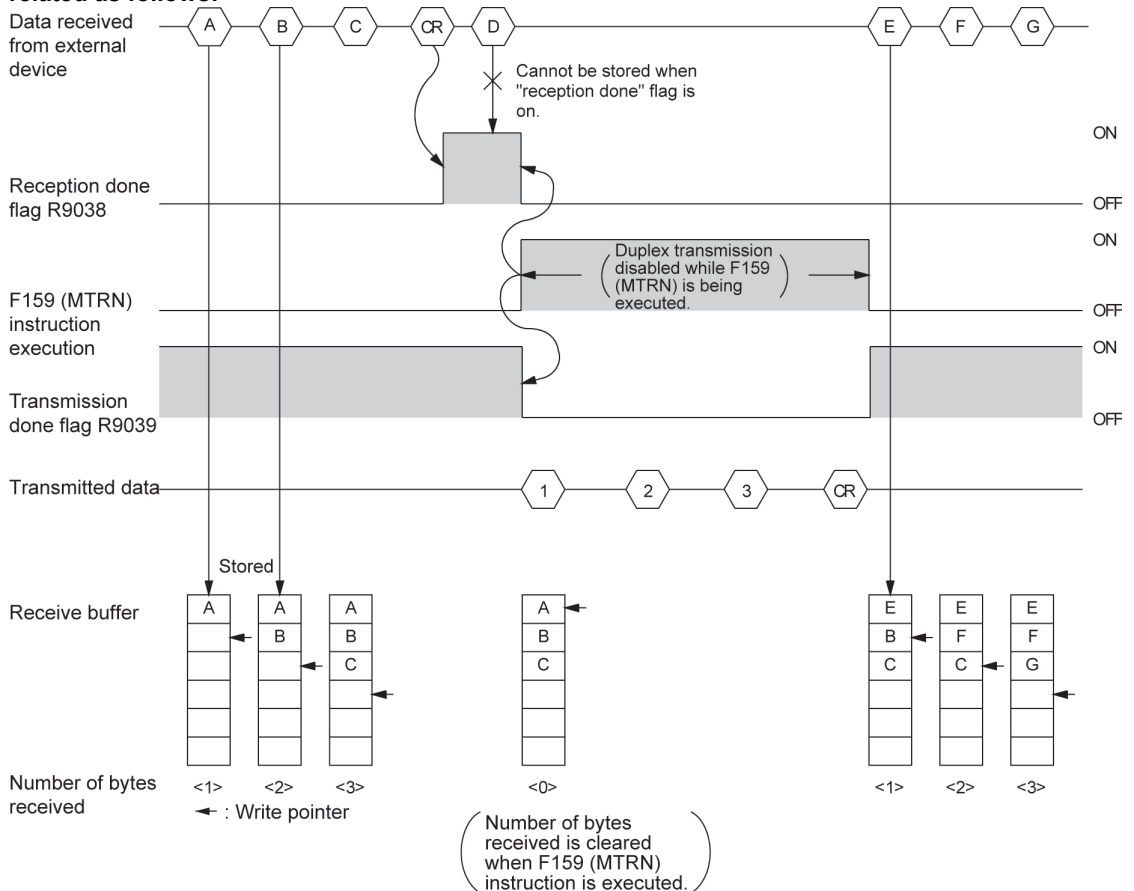

- For general-purpose serial communication, half-duplex transmission must be used.
- Reception is disabled when the “reception done” flag R9038 is on.
- When F159 (MTRN) is executed, the number of bytes received is cleared, and the address (write pointer) in the receive buffer is reset to the initial address.
- Also, when F159 (MTRN) is executed, the error flag R9037, the “reception done” flag R9038 and the “transmission done” flag R9039 goes off.
- Duplex transmission is disabled while F159 (MTRN) is being executed. The “transmission done” flag R9039 must be observed.
- Reception stops if the error flag R9037 goes on. To resume reception, execute the F159 (MTRN) instruction, which turns off the error flag.



Note:

Be aware that the “reception done” flag R9038 changes even while a scan is in progress (e.g., if the “reception done” flag is used multiple times as an input condition, there is a possibility of different statuses existing within the same scan.) To prevent multiple read access to the special internal relay you should generate a copy of it at the beginning of the program.

Header: STX, Terminator: ETX

Receiving data:

The “reception done” flag, the “transmission done” flag, and the F159 (MTRN) instruction are related as follows:

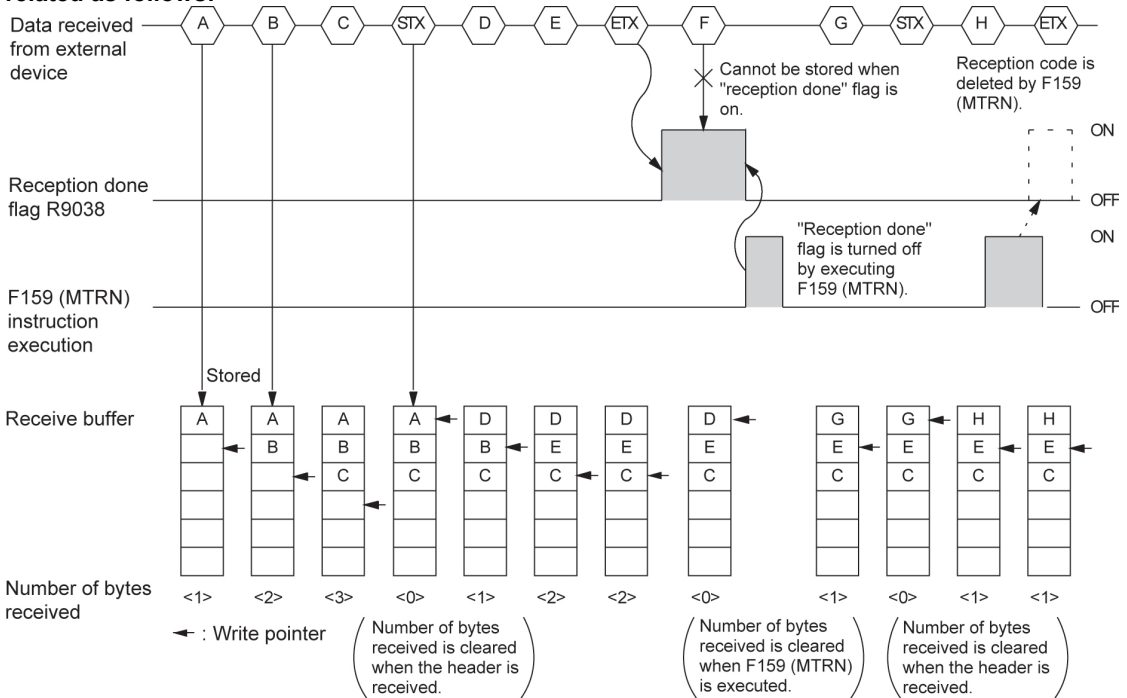

- The data is stored in the receive buffer in sequential order. When the header is received, the number of bytes received is cleared, and the address (write pointer) in the receive buffer is reset to the initial address.
- Reception is disabled while the “reception done” flag R9038 is on.
- Also, When F159 (MTRN) is executed, the number of bytes received is cleared, and the address (write pointer) in the receive buffer is reset to the initial address.
- If there are two headers, data following the second header overwrites the data in the receive buffer.
- The “reception done” flag R9038 is turned off by the F159 (MTRN) instruction. Therefore, if F159 (MTRN) is executed at the same time the terminator is received, the “reception done” flag will not be detected.

Sending data:

The “reception done” flag, the “transmission done” flag, and the F159 (MTRN) instruction are related as follows:

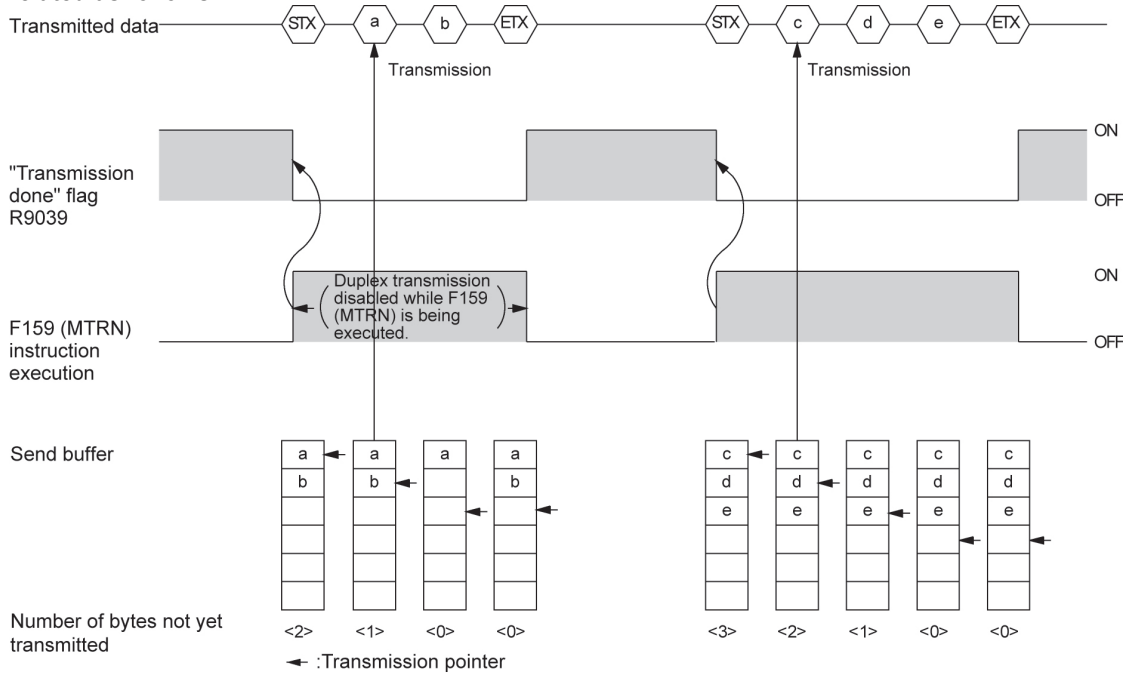

- Header (STX) and terminator (ETX) are automatically added to the data being transmitted. The data is transmitted to an external device.
- When the F159 (MTRN) instruction is executed, the “transmission done” flag R9039 goes off.
- Duplex transmission is disabled while F159 (MTRN) is being executed. The “transmission done” flag R9039 must be observed.

7.5.6 Changing Communication Mode Using F159(MTRN) Instruction

An F159 (MTRN) instruction can be executed to change between general-purpose serial communication mode and computer link mode. To do so, specify H8000 for n (the number of transmission bytes) and execute the instruction.

Changing from “general-purpose” to “computer link”

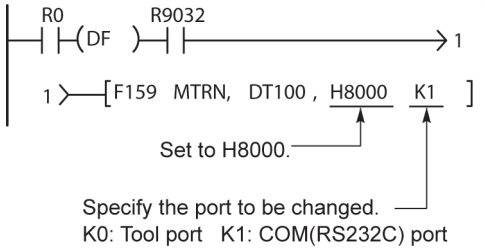

Changing from “computer link” to “general-purpose”

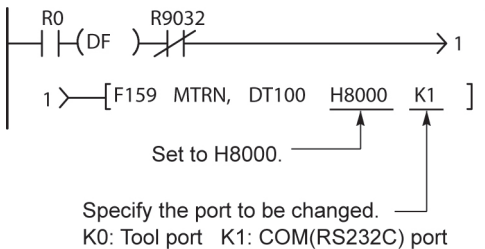

R9032: The COM port mode flag turns on when general-purpose serial communication mode is selected.



Note:

When the power is turned on, the operating mode selected in system register 412 takes effect. It is not possible to change to the MODBUS RTU mode.

7.5.7 Setting Communication Parameters

Tool port/COM port

The settings for baud rate and communication format of the tool port are entered using a programming tool.

Setting with FPWIN GR

Select "Options" in the menu bar, and then select "PLC Configuration". Click "Tool Port" or "COM Port" from the left list.

Dialog box of PLC system register setting (Tool port selection screen)

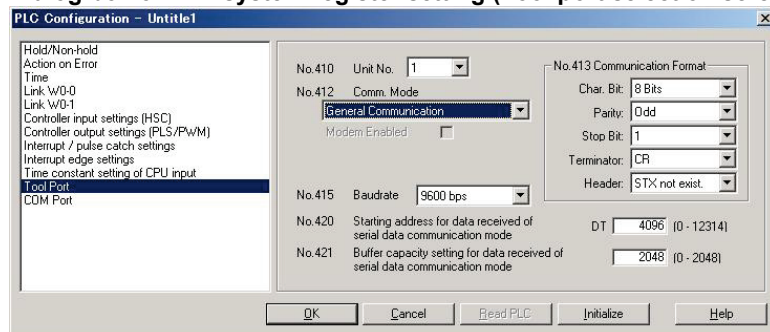

No. 410 Unit number

The unit number can be set within a range of 1 to 99.

No. 412 Communication mode

Select the operation mode of communication port operation mode. Click "General communication".

No. 413 Communication Format setting

The default setting of communication format is as below.

Set the communication format to match the external device connected to the communication port.

(The terminator and header cannot be changed.)

Char. Bit: 8 bits

Parity: Odd

Stop Bit: 1 bit

Terminator: CR

Header: STX not exist

No. 415 Baud rate setting

The default setting for the baud rate is "9600 bps". Set the value to match the external device connected to the communication port. For using the RS485 type, make the same setting as that of the baud rate switches (19200 or 115200 bps).

No. 416 Starting address for data received (For the tool port: No. 420)

No. 417 Buffer capacity setting for data received (For the tool port: No. 421)

For the general-purpose serial communication, setting "Receive buffer" is required.

To change this area, specify the starting address using system register No. 416 or 420 and the volume (number of words) using No. 417 or 421. The receive buffer layout is shown below. When setting for the tool port and the COM port both, do not specify the same buffer number.

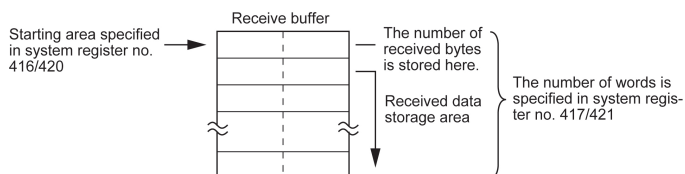

7.5.8 Connection with 1:1 Communication (General-purpose Serial Communication)



System register settings

No.	Name	Set Value
No. 412	Selection of communication mode	General-purpose serial communication
No. 413	Communication format	Char. bit: 7 bits/8 bits Parity: None/Odd/Even Stop bit: 1 bit/2 bits Terminator: CR/CR+LF/None/ETX Header: STX not exist
No. 415	Baud rate ^{Note1)}	2400 to 115200 bps
No. 416 No. 420	Starting address for receive buffer ^{Note2)}	C10, 14, 16: DT0 to DT12314 C32, T32, F32: DT0 to DT32764 (Default setting: Tool port: DT4096, COM port: DT0)
No. 417 No. 421	Receive buffer capacity ^{Note1)}	0 to 2048 words (Default setting: 2048 words)

Note1) The baud rates of 300, 600 and 1200 bps can be specified by the SYS1 instruction. However, the setting value of the system register cannot be changed. For using the RS485 type, make the same setting as that of the baud rate switches (19200 or 115200 bps).

Note2) No. 416 and 417 is the COM port. No. 420 and 421 is the tool port.

7.5.9 1:N Communication (General-purpose Serial Communication)

The FP0R and the external units are connected using an RS485 cable. Using the protocol that matches the external units, the F159 (MTRN) instruction is used to send and receive data.

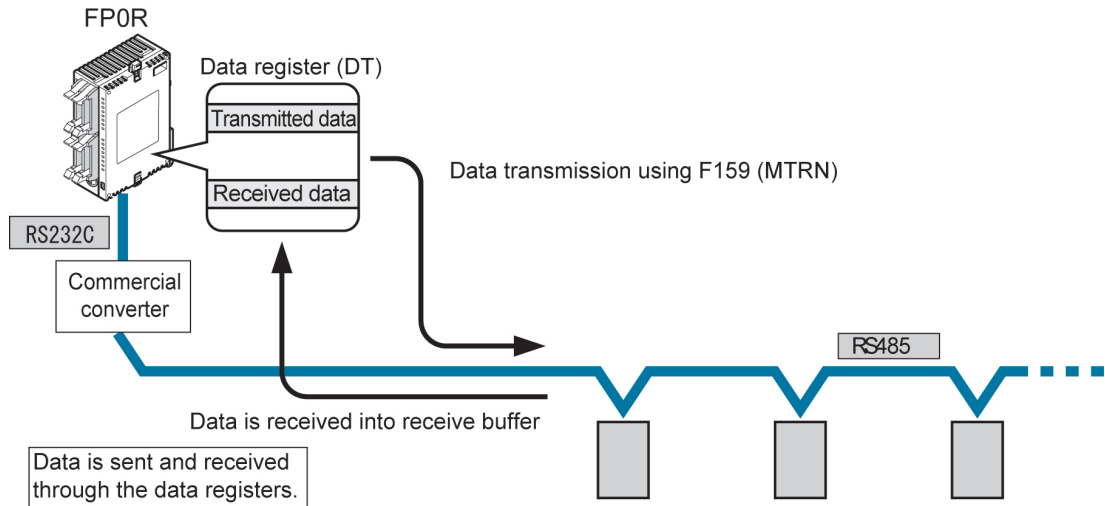

System register settings

No.	Name	Set Value
No. 412	Selection of communication mode	General-purpose serial communication
No. 413	Communication format	Char. bit: 7 bits/8 bits Parity: None/Odd/Even Stop bit: 1 bit/2 bits Terminator: CR/CR+LF/None/ETX Header: STX not exist
No. 415	Baud rate ^{Note 2)}	2400 to 115200 bps
No. 416 No. 420	Starting address for receive buffer ^{Note3)}	C10, 14, 16: DT0 to DT12314 C32, T32, F32: DT0 to DT32764 (Default setting: Tool port: DT4096, COM port: DT0)
No. 417 No. 421	Receive buffer capacity ^{Note3)}	0 to 2048 words

Note1) The communication format and baud rate should be set to match the connected devices.

Note2) The baud rates of 300, 600 and 1200 bps can be specified by the SYS1 instruction. However, the setting value of the system register cannot be changed. For using the RS485 type, make the same setting as that of the baud rate switches (19200 or 115200 bps).

Note3) No. 416 and 417 is the COM port. No. 420 and 421 is the tool port.

7.5.10 Settings in Compatibility Mode with FP0 (FP0 Compatibility Mode)

Programming Example of General-purpose Serial Communication in FP0 compatibility mode

The high-level instruction F144(TRNS) is used to send and receive data via the COM port (RS232C port). (The F159(MTRN) instruction is used in the normal FP0R mode.)



Key Point: In the FP0 compatibility mode, the F144(TRNS) instruction is used instead of F159(MTRN) instruction.

F144(TRNS) instruction

Data is sent and received between the FP0R and an external device via the COM port (RS232C port).

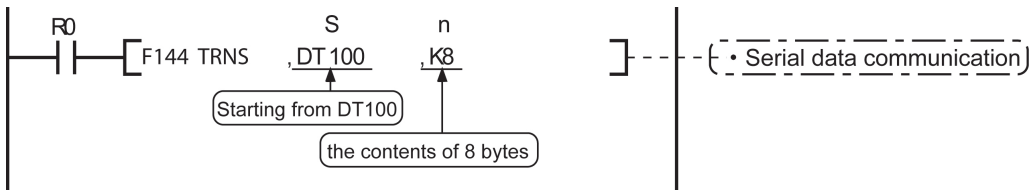

Devices that can be specified for S: Only data registers (DT) can be specified as the send buffer.

Devices that can be specified for n: WX, WY, WR, WL, SV, EV, DT, LD, I (I0 to ID), K, H

Sending data

The amount of data specified by n is sent to the external device from among the data stored in the data table, starting with the area specified by S, through the COM port specified by D. Data can be sent with the header and terminator automatically attached. A maximum of 2048 bytes can be sent. When the above program is run, the eight bytes of data contained in DT101 to DT104 and stored in the send buffer starting from DT100 are sent from the COM port.

Receiving data

Data can be received when the “reception done” flag is off. The received data is stored in the receive buffer specified by the system register. When the reception of the data is completed (the terminator is received), the “reception done” flag (R9038) turns on, and subsequently, receiving data is prohibited. To receive the next data, execute the F144(TRNS) instruction and turn the “reception done” flag (R9038) off to clear the number of received bytes to 0. To receive data continuously without sending data, clear the number of transmitted bytes to 0 (set “n” to “K0”), and then execute the F144 (TRNS) instruction.

Setting Communication Parameters

Confirm that the model of the programming tool is FP0.

Usable communication port

COM port (RS232C port)

COM port (RS232C port) settings

Dialog box of PLC system register setting

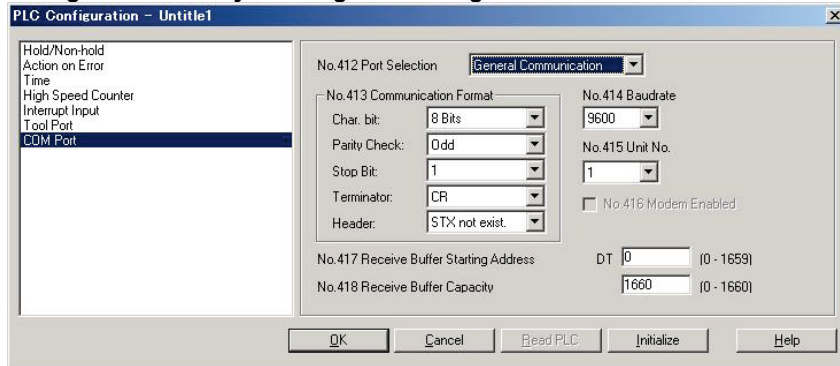

No. 412 Communication mode

Select "General communication".

No. 413 Communication Format setting

Char. Bit: 7 bits/8 bits

Parity: None/Odd/Even

Stop bit: 1 bit/2 bits

Terminator: End code: CR/CR+LF/None/ETX

Header: STX not exist/STX

- Specify the value to match the connected external device.

No. 414 Baud rate setting

Select one of the values from "300, 600, 1200, 2400, 4800, 9600 and 19200 bps".

No. 415 Unit number

The unit number can be set within a range of 1 to 99.

No. 417 Starting address for data received

No. 417 Buffer capacity setting for data received

For the general-purpose serial communication, setting "Receive buffer" is required.

To change this area, specify the starting address using system register No.417 and the volume (number of words) using No.418. The receive buffer layout is shown below.

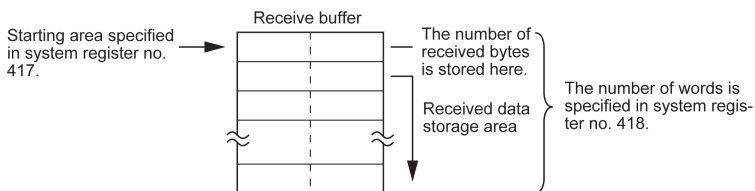

Starting address for data received

C10,C14,C16: DT0 to DT1659

C32 : DT0 to DT6143

T32 : DT0 to DT16383

(Default: Tool port: DT4096 COM(RS232C) port: DT0)

Buffer capacity setting for data received

C10, C14, C16: 0 to 1660 words (Default: 1660 words)

C32: 0 to 6144 words (Default: 6144 words)

T32: 0 to 16384 words (Default: 16384 words)

7.6 PC(PLC) link Function

7.6.1 Overview

A system can be configured for the PC(PLC) link (MEWNET-W0) with the FP0R.

- Exclusive internal relays "link relays (L)" and data registers "link registers (LD)" are shared between the connected PLCs.
- Turning on a link relay contact in one PLC turns on the same link relay in all other PLCs on the same network.
- Likewise, if the contents of a link register in one PLC are changed, the values of the same link register are changed in all PLCs on the same network.
- The status of the link relays and link registers in any one PLC is fed back to all of the other PLCs connected to the network, so control of data that needs to be consistent throughout the network, such as target production values and type codes, can easily be implemented to coordinate the data, and the data of all units are updated at the same time.

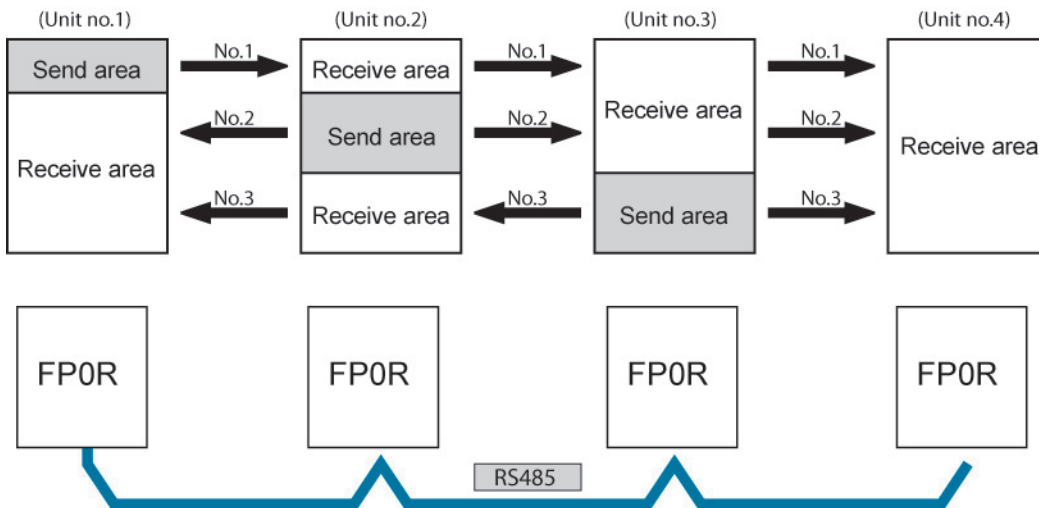

The link relays and link registers of the PLCs contain areas for sending and areas for receiving data. These areas are used to share data among the PLCs.

PLCs connectable to the PC link via MEWNET-W0

- FP2 Multi Communication Unit (Using Communication cassette RS485 type)
- FP-X (Using Communication cassette RS485 type)
- FP Σ (Using Communication cassette RS485 type)
- FP0R (RS485 type)

Operation of PLC link

Turning on a link relay contact in one PLC turns on the same link relay in all other PLCs on the same network.

Likewise, if the contents of a link register in one PLC are changed, the values of the same link register are changed in all PLCs on the same network.

Link relay

Link relay L0 for unit no.1 is turned on. The status change is fed back to the programs of the other units, and Y0 of the other units is set to TRUE.

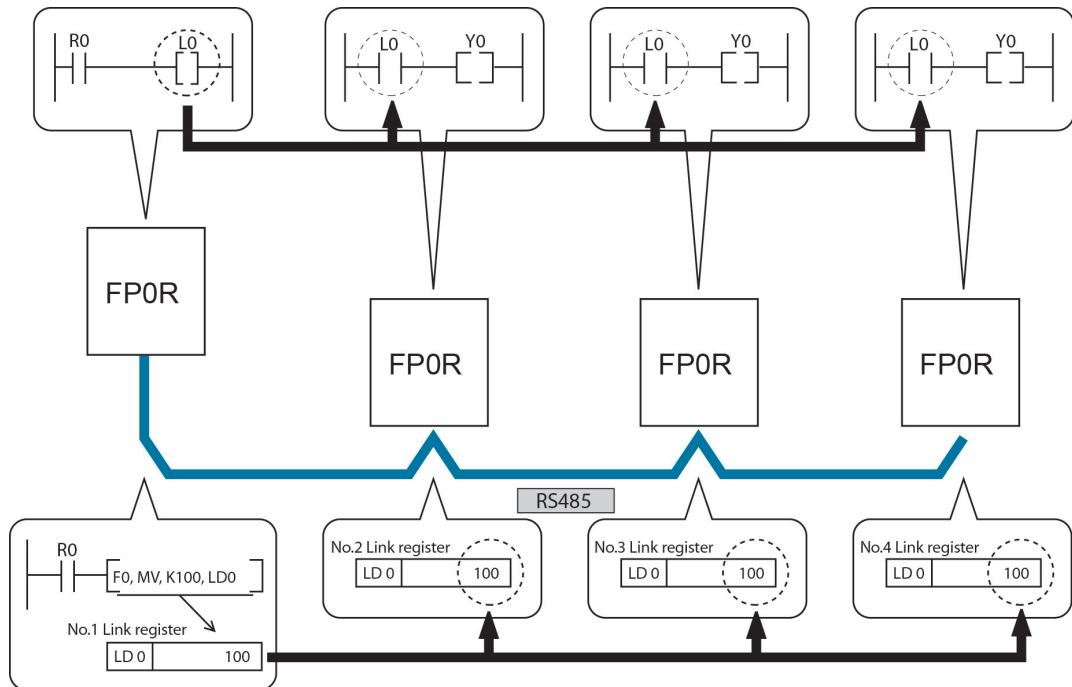

Link register

A constant of 100 is written to link register LD0 of unit no.1.

The contents of LD0 in the other units are also changed to a constant of 100.

Communication port

It is available for the COM port only.

7.6.2 Setting of Unit Numbers

By default, the unit number for the communication port is set to 1 in the system registers.
In a PC(PLC) link that connects multiple PLCs on the same transmission line, the unit number must be set in order to identify the different PLCs.

The unit number is specified either by using **the SYS1 instruction** or **the system register**.

Note1) The priority order for unit number settings is as follows:

1. SYS1 instruction
2. System registers

Note2) Unit numbers should be set sequentially and consecutively, starting from 1, with no breaks between them. If there is a missing unit number, the transmission time will be longer.

Note3) If fewer than 16 units are linked, the transmission time can be shortened by setting the largest unit number in system register no. 47.

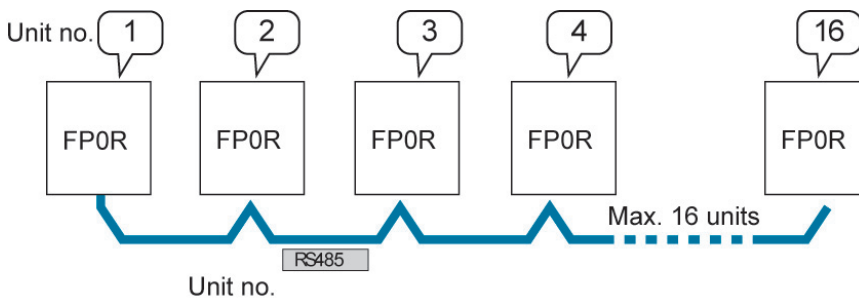

Unit numbers are the numbers to identify the different PLCs on the same network. The same number must not be used for more than one PLC on the same network.



Note:

When using the PC(PLC) link with the RS232C, the number of units is 2.

7.6.3 Setting Communication Parameters: PC(PLC) Link

Settings for baud rate and communication format

The settings for baud rate and communication format of the COM port are entered using a programming tool.

Setting with FPCWIN GR

Select "Options" in the menu bar, and then select "PLC Configuration". Click the "COM Port" tab.

Dialog box of PLC system register setting

The screenshot shows the 'PLC Configuration - Untitled1' dialog box. On the left is a tree view with 'COM Port' selected. The main area contains the following settings:

- No.410 Unit No.: 1
- No.412 Comm. Mode: PC Link
- Modem Enabled:
- No.415 Baudrate: 115200 bps
- No.416 Starting address for data received of serial data communication mode: DT 0 (0-12314)
- No.417 Buffer capacity setting for data received of serial data communication mode: 2048 (0-2048)
- No.413 Communication Format:
 - Char. Bit: 8 Bits
 - Parity: Odd
 - Stop Bit: 1
 - Terminator: CR
 - Header: STX not exist

Buttons at the bottom: OK, Cancel, Read PLC, Initialize, Help.

No. 410 Unit number

The unit number can be set within a range of 1 to 16.

No. 412 Communication Mode

Click on , and select "PC Link".



Key Point:

When using a PC(PLC) link, the communication format and baud rate are fixed:

No.	Name	Set Value
No. 413	Communication format	Char. bit: 8 bits Parity: Odd Stop bit: 1 bit Terminator: CR Header: STX not exist
No. 415	Baud rate setting for COM1 port	115200 bps

7.6.4 Link Area Allocation

The link relays and link registers to be used in the PC(PLC) link are allocated in the link area of the CPU unit. Link area allocations are specified by setting the system registers of the CPU unit.

System registers

No.	Name	Default value	Set value	
For PC (PLC) link 0	40	Range of link relays used for PC(PLC) link	0	0 to 64 words
	41	Range of link data registers used for PC(PLC) link	0	0 to 128 words
	42	Starting number for link relay transmission	0	0 to 63
	43	Link relay transmission size	0	0 to 64 words
	44	Starting number for link data register transmission	0	0 to 127
	45	Link data register transmission size	0	0 to 127 words
	46	PC(PLC) link switch flag	Normal	Normal: 1st half Reverse: 2nd half
For PC (PLC) link 1	46	PC(PLC) link switch flag	Normal	Normal: 1st half Reverse: 2nd half
	50	Range of link relays used for PC(PLC) link	0	0 to 64 words
	51	Range of link data registers used for PC(PLC) link	0	0 to 128 words
	52	Starting number for link relay transmission	64	64 to 127
	53	Link relay transmission size	0	0 to 64 words
	54	Starting number for link data register transmission	128	128 to 255
	55	Link data register transmission size	0	0 to 127 words
57	Maximum unit number setting for MEWNET-W0 PC(PLC) link	16	1 to 16 ^{Note)}	

Note) The same maximum unit number should be specified for all the PLCs connected in the PC(PLC) link.

Link area configuration

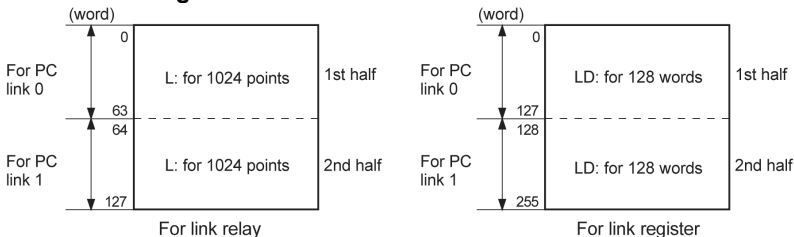

- Link areas consist of link relays and link registers, and are divided into areas for PC(PLC) link 0 and PC(PLC) link 1 and used with those units.

- The link relay which can be used in an area for either PC(PLC) link 0 or PC(PLC) link 1 is maximum 1024 points (64 words), and the link register is maximum 128 words.



Note:

The PC link 1 can be used to connect with the second PC link W0 of the FP2 Multi Communication Unit (MCU). At that time, the link relay number and link register number for the PC link can be the same values as the FP2 (from WL64, from LD128).

Example of allocation

The areas for PC(PLC) link are divided into send areas and receive areas. The link relays and link registers are sent from the send area to the receive area of a different PLC. Link relays and link registers with the same numbers as those on the transmission side must exist in the receive area on the receiving side.

For PC(PLC) link 0

Link relay allocation

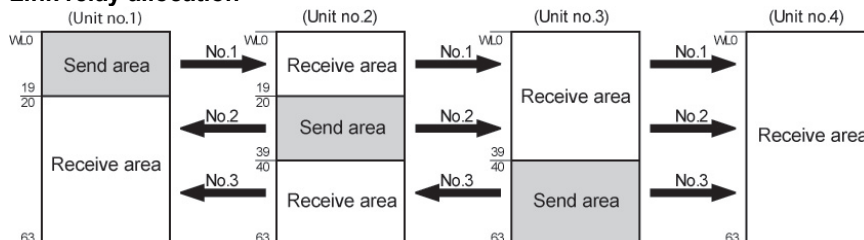

System registers

No.	Name	Setting for various units			
		No. 1	No. 2	No. 3	No. 4
40	Range of link relays used	64	64	64	64
42	Starting No. of word for link relay transmission	0	20	40	0
43	Link relay transmission size	20	20	24	0

Note) No.40 (range of link relays used) must be set to the same range for all the units.

Link register allocation

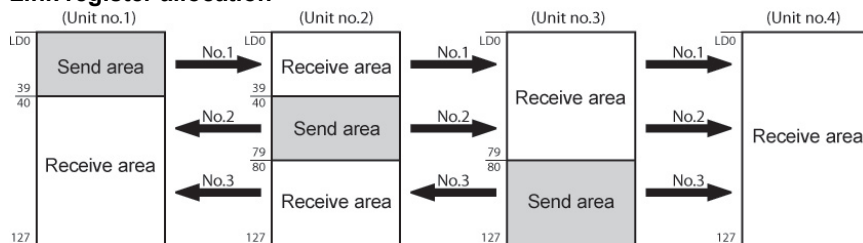

System registers

No.	Name	Setting for various units			
		No. 1	No. 2	No. 3	No. 4
41	Range of link registers used	128	128	128	128
44	Starting No. for link register transmission	0	40	80	0
45	Link register transmission size	40	40	48	0

Note) No.41 (range of link registers used) must be set to the same range for all the units.

When link areas are allocated as shown above, the No.1 send area can be sent to the No.2, No.3 and No.4 receive areas. Also, the No.1 receive area can receive data from the No.2 and No.3 send areas. No.4 is allocated as a receive area only, and can receive data from No.1, No.2 and No.3, but cannot transmit it to other stations.

For PC(PLC) link 1
Link relay allocation

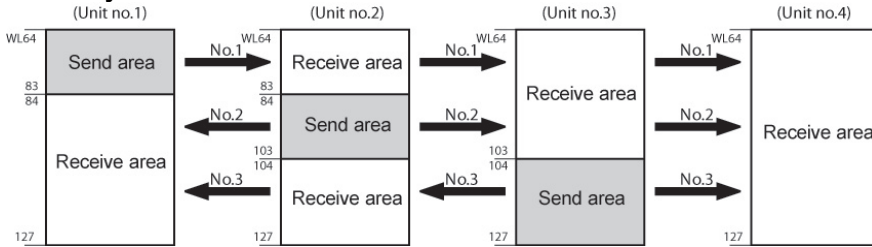

System registers

No.	Name	Setting for various units			
		No. 1	No. 2	No. 3	No. 4
50	Range of link relays used	64	64	64	64
52	Starting No. of word for link relay transmission	64	84	104	64
53	Link relay transmission size	20	20	24	0

Note) No.50 (range of link relays used) must be set to the same range for all the units.

Link register allocation

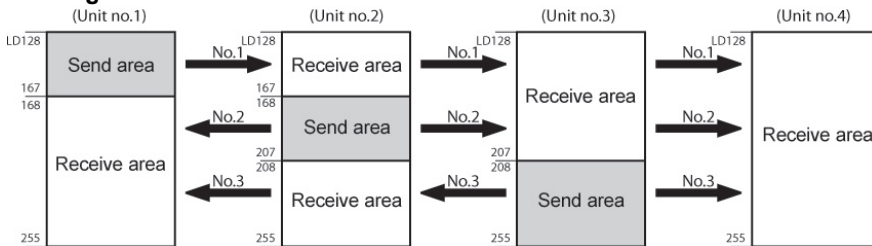

System registers

No.	Name	Setting for various units			
		No. 1	No. 2	No. 3	No. 4
51	Range of link registers used	128	128	128	128
54	Starting No. for link register transmission	128	128	208	128
55	Link register transmission size	40	40	48	0

Note) No.51 (range of link registers used) must be set to the same range for all the units.

When link areas are allocated as shown above, the No.1 send area can be sent to the No.2, No.3 and No.4 receive areas. Also, the No.1 receive area can receive data from the No.2 and No.3 send areas. No.4 is allocated as a receive area only, and can receive data from No.1, No.2 and No.3, but cannot transmit it to other stations.



Note:

The PC link 1 can be used to connect with the second PC link W0 of the FP2 Multi Communication Unit (MCU). At that time, the link relay number and link register number for the PC link can be the same values as the FP2 (from WL64, from LD128).

Partial use of link areas

In the link areas available for PC(PLC) link, link relays with a total of 1024 points (64 words) and link registers with a total of 128 words can be used. This does not mean, however, that it is necessary to reserve the entire area. Parts of the area which have not been reserved can be used as internal relays and internal registers.

Link relay allocation

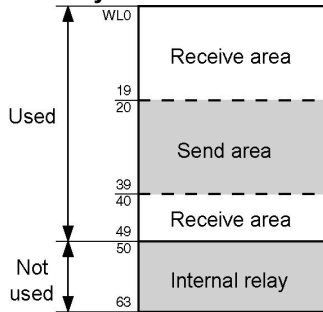

No.	Name	No.
No.40	Range of link relays used	50
No.42	Starting No. of word for link relay transmission	20
No.43	Link relay transmission size	20

With the above settings, the 14 words (224 points) consisting of WL50 to WL63 can be used as internal relays.

Link register allocation

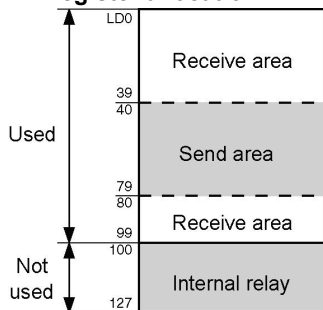

No.	Name	No.
No.41	Range of link registers used	100
No.44	Starting No. for link register transmission	40
No.45	Link register transmission size	40

With the above settings, the 28 words consisting of LD100 to LD127 can be used as internal registers.



Note: Precautions When Allocating Link Areas

If a mistake is made when allocating a link area, be aware that an error will result, and communication will be disabled.

Avoid overlapping send areas

When sending data from a send area to the receive area of another PLC, there must be a link relay and link register with the same number in the receive area on the receiving side. In the example shown below, there is an area between No.2 and No.3 which is overlapped, and this will cause an error, so that communication cannot be carried out.

Example of link relay allocations

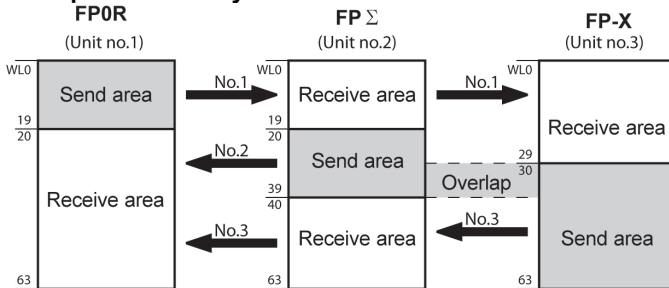

System registers

No.	Name	Set value of various control units		
		No. 1	No. 2	No. 3
No.40	Range of link relays used	64	64	64
No.42	Starting No. of word for link relay transmission	0	20	30
No.43	Link relay transmission size	20	20	34

Invalid allocations

The allocations shown below are not possible, neither for link relays nor for link registers:

- Send area is split

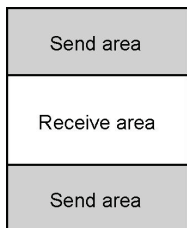

- Send and receive areas are split into multiple segments

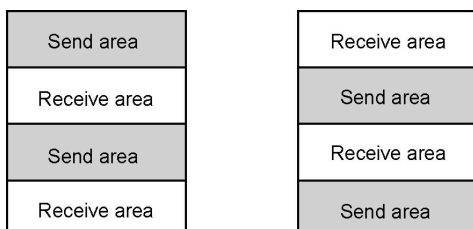

7.6.5 Setting the Largest Unit Number for PC(PLC) Link

The largest unit number can be set using system register no.47 (using system register no.57 for PC(PLC) link 1).

[Sample setting]

No. of units linked	Setting contents
2	1st unit: Unit no. 1 is set 2nd unit: Unit no. 2 is set A largest unit no. of 2 is set for each.
4	1st unit: Unit no. 1 is set 2nd unit: Unit no. 2 is set 3rd unit: Unit no. 3 is set 4th unit: Unit no. 4 is set A largest unit no. of 4 is set for each.
n	Nth unit: Unit no. n is set A largest unit no. of n is set for each.



Note:

- Unit numbers should be set sequentially and consecutively, starting from 1, with no breaks between them. If there is a missing unit number, the transmission time will be longer.
- If fewer than 16 units are linked, the transmission time can be shortened by setting the largest unit number in system register no.47 (in system register no.57 for PC(PLC) link 1).
- For all PLCs which are linked, the same value should be set for the largest unit number.
- If there are fewer than 16 units linked and the largest unit number has not been set (default=16), or the largest unit number has been set but the unit number settings are not consecutive, or the unit number settings are consecutive but there is a unit for which the power supply has not been turned on, the response time for the PC(PLC) link (the link transmission cycle) will be longer.



Reference: <7.6.7 PC(PLC) Link Response Time>

Setting PC(PLC) link switching flag

PC(PLC) link switching flag can be set using system register no. 46.

If it is set to 0 (default value), the first half of the link relays and registers are used. If it is set to 1, the second half of the link relays and registers are used.

First half(WL0 to WL63, LD0 to LD127) is used.

Second half(WL64 to WL127, LD128 to LD255) is used.

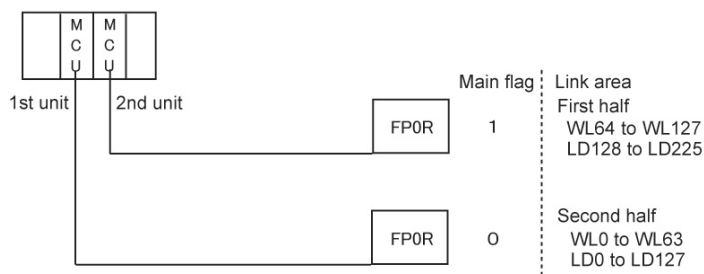

7.6.6 Monitoring

When using a PC(PLC) link, the operation status of the links can be monitored using the following relays.

Transmission assurance relays

For PC(PLC) link 0: R9060 to R906F (correspond to unit no. 1 to 16)

For PC(PLC) link 1: R9080 to R908F (correspond to unit no. 1 to 16)

If the transmission data from a different unit is being used with the various PLCs, check to make sure the transmission assurance relay for the target unit is on before using the data.

Exclusive internal relays "link relays (L)" and data registers "link registers (LD)" are shared between the connected PLCs.

Relay no.	R906F	R906E	R906D	R906C	R906B	R906A	R9069	R9068	R9067	R9066	R9065	R9064	R9063	R9062	R9061	R9060
Unit no.	16	15	14	13	12	11	10	9	8	7	6	5	4	3	2	1
Conditions for on/off	ON: When the PC(PLC) link is normal OFF: If transmission is stopped, a problem has occurred, or a PC(PLC) link is not being used															

Operation mode relays

For PC(PLC) link 0: R9070 to R907F (correspond to unit no. 1 to 16)

For PC(PLC) link 1: R9090 to R909F (correspond to unit no. 1 to 16)

The operation modes (RUN/PROG.) can be checked for any given PLC.

Relay no.	R907F	R907E	R907D	R907C	R907B	R907A	R9079	R9078	R9077	R9076	R9075	R9074	R9073	R9072	R9071	R9070
Unit no.	16	15	14	13	12	11	10	9	8	7	6	5	4	3	2	1
Conditions for on/off	ON: When the unit is in the RUN mode OFF: When the unit is in the PROG. mode															

PLC link transmission error relay R9050

This relay goes on if a problem is detected during transmission.

Relay no.	R9050															
Unit no.	16	15	14	13	12	11	10	9	8	7	6	5	4	3	2	1
Conditions for on/off	ON: When a transmission error has occurred in the PC(PLC) link, or when there is an error in the setting for the PC(PLC) link area OFF: When there is no transmission error.															



Key Point: Monitoring the PC(PLC) link status

Using a programming tool, the PC(PLC) link status items, such as the transmission cycle time and the number of times that errors have occurred, can be monitored.

Using FPWIN GR: Select [Status Display] under [Online] in the menu. Click the [PC link] button after the [Status Display] screen is shown.

Using FPWIN Pro: Select [PLC Link Status] under [Online] in the menu.



Note: Remote programming of the linked PLCs is not possible from the programming tool.

7.6.7 PC(PLC) Link Response Time

The maximum value for the transmission time (T) of one cycle can be calculated using the following formula.

$$T \text{ max.} = \underbrace{Ts1 + Ts2 + \dots + Tsn}_{\textcircled{1} \text{ Ts (transmission time per station)}} + \underbrace{Tlt + Tso + Tik}_{\substack{\textcircled{2} \text{ Tlt (link table sending time)} \\ \textcircled{3} \text{ Tso (master station scan time)} \\ \textcircled{4} \text{ Tik (link addition processing time)}}$$

The various items in the formula are calculated as described below.

① Ts (transmission time per station)

Ts = scan time + Tpc (PC(PLC) link sending time)

Tpc = Ttx (sending time per byte) x Pcm (PLC link sending size)

Ttx = 1/(baud rate x 1000) x 11 ms Approx. 0.096 ms at 115.2 kbps

Pcm = 23 + (number of relay words + number of register words) x 4

② Tlt (link table sending time)

Tlt = Ttx (sending time per byte) x Ltm (link table sending size)

Ttx = 1/(baud rate x 1000) x 11 ms Approx. 0.096 ms at 115.2 kbps

Ltm = 13 + 2 x n (n = number of stations being added)

③ Tso (master station scan time)

This should be confirmed using the programming tool.

④ Tik (link addition processing time) If no stations are being added, Tik = 0.

Tik = Tlc (link addition command sending time) + Twt (addition waiting time) + Tls (sending time for command to stop transmission if link error occurs) + Tso (master station scan time)

Tlc = 10 x Ttx (sending time per byte)

Ttx = 1/(baud rate x 1000) x 11 ms Approx. 0.096 ms at 115.2 kbps

Twt = Initial value 400 ms (can be changed using SYS1 system register instruction)

Tls = 7 x Ttx (sending time per byte)

Ttx = 1/(baud rate x 1000) x 11 ms Approx. 0.096 ms at 115.2 kbps

Tso = Master station scan time

Calculation example 1

When all stations have been added to a 16-unit link, the largest station number is 16, relays and registers have been evenly allocated, and the scan time for each PLCs is 1 ms.

Ttx = 0.096 Each Pcm = 23 + (4 + 8) x 4 = 71 bytes Tpc = Ttx x Pcm = 0.096 x 71 ≈ 6.82 ms

Each Ts = 1 + 6.82 = 7.82 ms Tlt = 0.096 x (13 + 2 x 16) = 4.32 ms

Given the above conditions, the maximum value for the transmission time (T) of one cycle will be:

T max. = 7.82 x 16 + 4.32 + 1 = 130.44 ms

Calculation example 2

When all stations have been added to a 16-unit link, the largest station number is 16, relays and registers have been evenly allocated, and the scan time for each PLC is 5 ms

Ttx = 0.096 Each Pcm = 23 + (4 + 8) x 4 = 71 bytes Tpc = Ttx x Pcm = 0.096 x 71 ≈ 6.82 ms

Each Ts = 5 + 6.82 = 11.82 ms Tlt = 0.096 x (13 + 2 x 16) = 4.32 ms

Given the above conditions, the maximum value for the transmission time (T) of one cycle will be:

T max. = 11.82 x 16 + 4.32 + 5 = 198.44 ms

Calculation example 3

When all but one station have been added to a 16-unit link, the largest station number is 16, relays and registers have been allocated evenly, and the scan time for each PLC is 5 ms.

$$T_{tx} = 0.096 \quad \text{Each } T_s = 5 + 6.82 = 11.82 \text{ ms}$$

$$T_{lt} = 0.096 \times (13 + 2 \times 15) \doteq 4.13 \text{ ms}$$

$$T_{lk} = 0.96 + 400 + 0.67 + 5 \doteq 407 \text{ ms}$$

Note: The default value for the addition waiting time is 400 ms.

Given the above conditions, the maximum value for the transmission time (T) of one cycle will be:

$$T \text{ max.} = 11.82 \times 15 + 4.13 + 5 + 407 = 593.43 \text{ ms}$$

Calculation example 4

When all stations have been added to an 8-unit link, the largest station number is 8, relays and register have been evenly allocated, and the scan time for each PLC is 5 ms.

$$T_{tx} = 0.096 \quad \text{Each } P_{cm} = 23 + (8 + 16) \times 4 = 119 \text{ bytes}$$

$$T_{pc} = T_{tx} \times P_{cm} = 0.096 \times 119 \doteq 11.43 \text{ ms}$$

$$\text{Each } T_s = 5 + 11.43 = 16.43 \text{ ms} \quad T_{lt} = 0.096 \times (13 + 2 \times 8) \doteq 2.79 \text{ ms}$$

Given the above conditions, the maximum value for the transmission time (T) of one cycle will be:

$$T \text{ max.} = 16.43 \times 8 + 2.79 + 5 = 139.23 \text{ ms}$$

Calculation example 5

When all stations have been added to a 2-unit link, the largest station number is 2, relays and registers have been evenly allocated, and the scan time for each PLC is 5 ms.

$$T_{tx} = 0.096 \quad \text{Each } P_{cm} = 23 + (32 + 64) \times 4 = 407 \text{ bytes}$$

$$T_{pc} = T_{tx} \times P_{cm} = 0.096 \times 407 \doteq 39.072 \text{ ms}$$

$$\text{Each } T_s = 5 + 39.072 = 44.072 \text{ ms} \quad T_{lt} = 0.096 \times (13 + 2 \times 2) \doteq 1.632 \text{ ms}$$

Given the above conditions, the maximum value for the transmission time (T) of one cycle will be:

$$T \text{ max.} = 44.072 \times 2 + 1.632 + 5 = 94.776 \text{ ms}$$

Calculation example 6

When all stations have been added to a 2-unit link, the largest station number is 2, 32 relays and 2 register words have been evenly allocated, and the scan time for each PLC is 1 ms.

$$T_{tx} = 0.096 \quad \text{Each } P_{cm} = 23 + (1 + 1) \times 4 = 31 \text{ bytes}$$

$$T_{pc} = T_{tx} \times P_{cm} = 0.096 \times 31 \doteq 2.976 \text{ ms}$$

$$\text{Each } T_s = 1 + 2.976 = 3.976 \text{ ms} \quad T_{lt} = 0.096 \times (13 + 2 \times 2) \doteq 1.632 \text{ ms}$$

Given the above conditions, the maximum value for the transmission time (T) of one cycle will be:

$$T \text{ max.} = 3.976 \times 2 + 1.632 + 1 = 10.584 \text{ ms}$$



Note:

- In the description, "stations that have been added" refers to stations which are connected between station no. 1 and the largest station number and for which the power supply has been turned on.
- Comparing examples 2 and 3, the transmission cycle time is longer if there is one station that has not been added to the link. As a result the PC(PLC) link response time is longer.
- The SYS1 instruction can be used to minimize the transmission cycle time even if there are one or more stations that have not been added to the link.

Reducing the transmission cycle time when there are stations that have not been added

If there are stations that have not been added to the link, the Tlk time (link addition processing time) and with this the transmission cycle time will be longer.

$$T_{max} = Ts_1 + Ts_2 + \dots + Ts_n + Tlt + Tso + Tlk$$

$$Tlk = Tlc \text{ (link addition command sending time)} + Twt \text{ (addition waiting time)} + Tls \text{ (link error stop command sending time)} + Tso \text{ (master station scan time)}$$

With the SYS1 instruction, the link addition waiting time Twt in the above formula can be reduced. Thus, SYS1 can be used to minimize the increase in the transmission cycle time.

<Programming example of SYS1 instruction>

(SYS1, M PCLK1T0, 100)

Function: Setting SYS1 to change the waiting time for a link to be added to the PC(PLC) link from the default value of 400 ms to 100 ms.

Keywords: Setting for key word no. 1: PCLK1T0

Permissible range for key word no. 2: 10 to 400 (10 ms to 400 ms)



Note:

If there are any units that have not been added to the link, the setting should not be changed as long as a longer link transmission cycle time does not cause any problem.

- The SYS1 instruction should be executed at the beginning of the program, at the rise of R9014. The same waiting time should be set for all linked PLCs.
- The waiting time should be set to a value of at least twice the maximum scan time for any of the PLCs connected to the link.
- If a short waiting time has been set, there may be PLCs that cannot be added to the link even if their power supply is on. (The shortest time that can be set is 10 ms.)

Error detection time for transmission assurance relays

The power supply of any given PLC fails or is turned off, it takes (as a default value) 6.4 seconds for the transmission assurance relay of the PLC to be turned off at the other stations. This time period can be shortened using the SYS1 instruction.

<Programming example of SYS1 instruction>

(SYS1, M PCLK1T1, 100)

Function: Setting SYS1 to change the time that the PC(PLC) link transmission assurance is off from the default value of 6400 ms to 100 ms.

Keywords: Setting for key word no. 1: PCLK1T1

Permissible range for key word no. 2: 100 to 6400 (100 ms to 6400 ms)



Note:

The setting should not be changed as long as a longer transmission assurance relay detection time does not cause any problems.

- The SYS1 instruction should be executed at the beginning of the program, at the rise of R9014. The same time should be set for all linked PLCs.
- The time should be set to a value of at least twice the maximum transmission cycle time when all of the PLCs are connected to the link.
- If short time has been set, the transmission assurance relay may not function properly. (The shortest time that can be set is 100 ms.)

7.7 MODBUS RTU Communication

7.7.1 Overview of Functions

- The MODBUS RTU protocol enables the communication between the FP0R and other devices (including our FP-X, FP-e, Programmable display GT series, KT temperature control unit and MODBUS device made by other companies).
- Enables to have conversations if the master unit sends instructions (command messages) to slave units and the slave units respond (response messages) according to the instructions.
- Enables the communication between the devices of max. 99 units as the master function and slave function is equipped.

About MODBUS RTU

- The MODBUS RTU communication is a function for the master unit to read and write the data in slave units communicating between them.
- There are ASCII mode and RTU (binary) mode in the MODBUS protocol, however, the FP0R is supported with the RTU (binary) mode only.

Master function

Writing and reading data for various slaves is available using the F145 (SEND) and F146 (RECV) instructions.

Individual access to each slave and the global transmission is possible.

Use Type II instructions of F145 and F146 (Type directly specifying MODBUS address) to communication with MODBUS devices made by other companies.

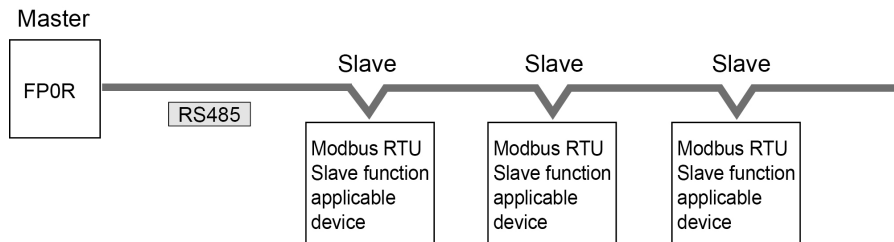

Slave function

If the slave units receive a command message from the master unit, they send back the response message corresponding to the content.

Do not execute the F145 (SEND) or F146 (RECV) instructions when the unit is used as a slave unit.

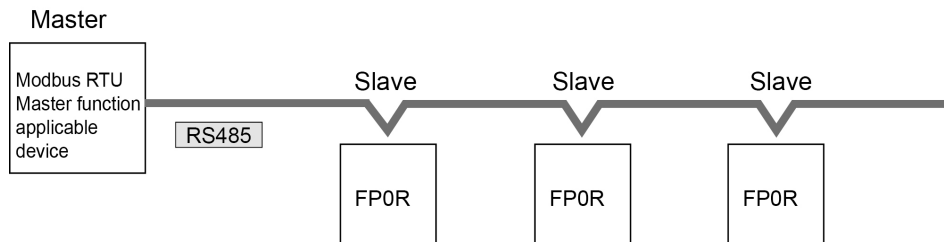

MODBUS RTU command message frame

START	ADDRESS	FUNCTION	DATA	CRC CHECK	END
3.5-character time	8 bits	8 bits	n*8 bits	16 bits	3.5-character time

ADDRESS (Unit No.) 8 bits, 0 to 99 (decimal)
 Note1) 0= Broadcast address
 Note2) Slave unit No. is 1 to 99 (decimal)
 Note3) For MODBUS, 0 to 247 (decimal)

FUNCTION 8 bits

DATA Varies depending on commands.

CRC 16 bits

END 3.5-character time (Differs depending on baud rate. Refer to reception judgement time.)

Response in normal status

The same message as a command is returned for single write command.
 A part of a command message (6 bytes from the beginning) is returned for multiple write command.

Response in abnormal status

In case a parameter disabled to be processed is found in a command (except transmission error)

Slave address (unit number) Function code + 80H Error code CRC	One of either 1, 2 or 3
---	-------------------------

Error code contents

1: Function code error
2: Device number error (out of range)
3: Device quantity error (out of range)

Reception done judgment time

The process for receiving a message completes when the time that is exceeding the time mentioned below has passed after the final data was received.

Baud rate	Reception done judgment time
2400	Approx. 13.3 ms
4800	Approx. 6.7 ms
9600	Approx. 3.3 ms
19200	Approx. 1.7 ms
38400	Approx. 0.8 ms
57600	Approx. 0.6 ms
115200	Approx. 0.3 ms

Note) The reception done judgment time is an approx. 32-bit time.

Supported commands

Executable instructions for master	Code (decimal)	Name (MODBUS original)	Name for FP0R	Remarks (Reference No.)
F146 (RECV)	01	Read Coil Status	Read Y and R Coils	0X
F146 (RECV)	02	Read Input Status	Read X Input	1X
F146 (RECV)	03	Read Holding Registers	Read DT	4X
F146 (RECV)	04	Read Input Registers	Read WL and LD	3X
F145 (SEND)	05	Force Single Coil	Write Single Y and R	0X
F145 (SEND)	06	Preset Single Register	Write DT 1 Word	4X
Cannot be issued	08	Diagnostics	Loopback Test	
F145 (SEND)	15	Force Multiple Coils	Write Multiple Ys and Rs	0X
F145 (SEND)	16	Preset Multiple Registers	Write DT Multiple Words	4X
Cannot be issued	22	Mask Write 4X Register	Write DT Mask	4X
Cannot be issued	23	Read/Write 4X Registers	Read/Write DT	4X

Table for MODBUS reference No. and FP0R device No.

MODBUS reference No.		Data on BUS (hexadecimal)	PLC device No.
Coil		000001-001760	Y0-Y109F
		002049-006144	R0-R255F
Input		100001-101760	X0-X109F
Holding register	C10, C14, C16	400001-412315	DT0-DT12314
	C32, T32, F32	400001-432765	DT0-DT32764
Input register		300001-300128	WL0-WL127
		302001-302256	LD0-LD255

7.7.2 Setting Communication Parameters

Settings for baud rate and communication format

The settings for baud rate and communication format of the COM port are entered using a programming tool.

Setting with FPWIN GR

Select "Options" in the menu bar, and then select "PLC Configuration". Click the "COM Port" tab.

Dialog box of PLC system register setting

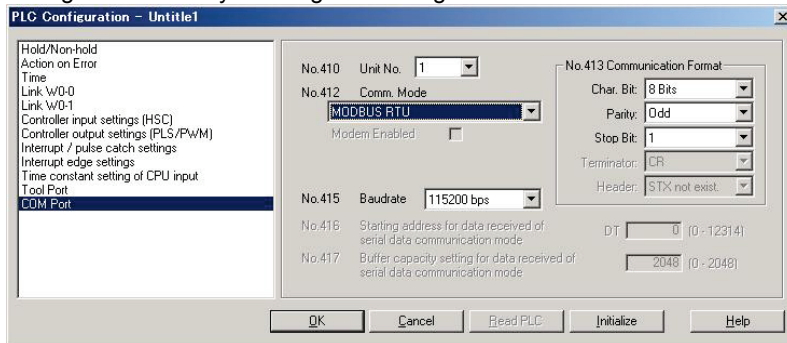

No. 410 Unit number

The unit number can be set within a range of 1 to 99.

No. 412 Communication mode

Click on , and select "MODBUS RTU link".

No. 413 Communication Format setting

The default setting of communication format is as below.

Set the communication format to match the external device connected to the communication port.

(The terminator and header cannot be changed.)

Char. Bit: 8 bits

Parity: Odd

Stop Bit: 1 bit

Terminator: Setting disable

Header: Setting disable

No. 415 Baud rate setting

The default setting for the baud rate is "9600 bps". Set the value to match the external device connected to the communication port. For using the RS485 type, make the same setting as that of the baud rate switches (19200 or 115200 bps).

7.7.3 MODBUS Master

Use the F145 (SEND) “Data send” or F146 (RECV) “Data receive” instruction to use the MODBUS master function.

Sample program

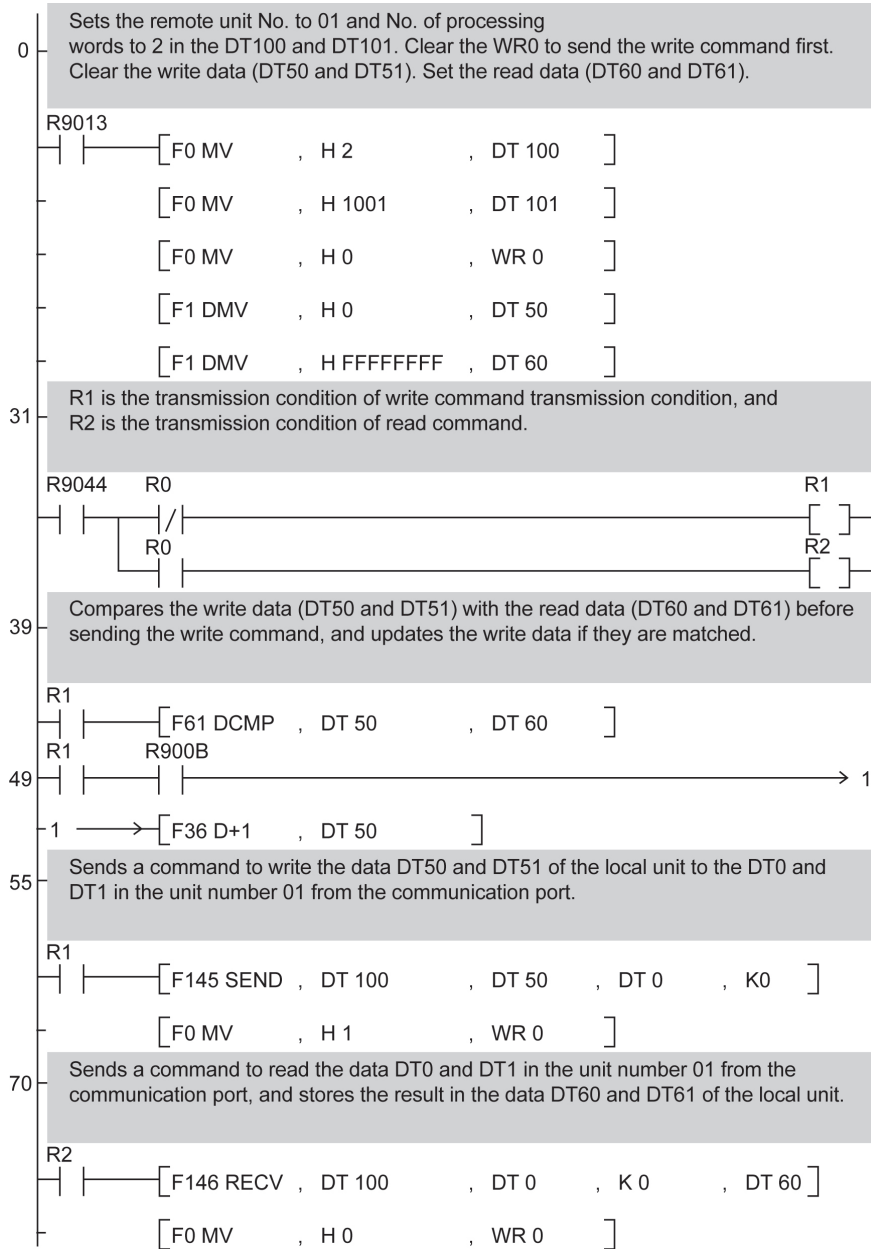

Flow chart

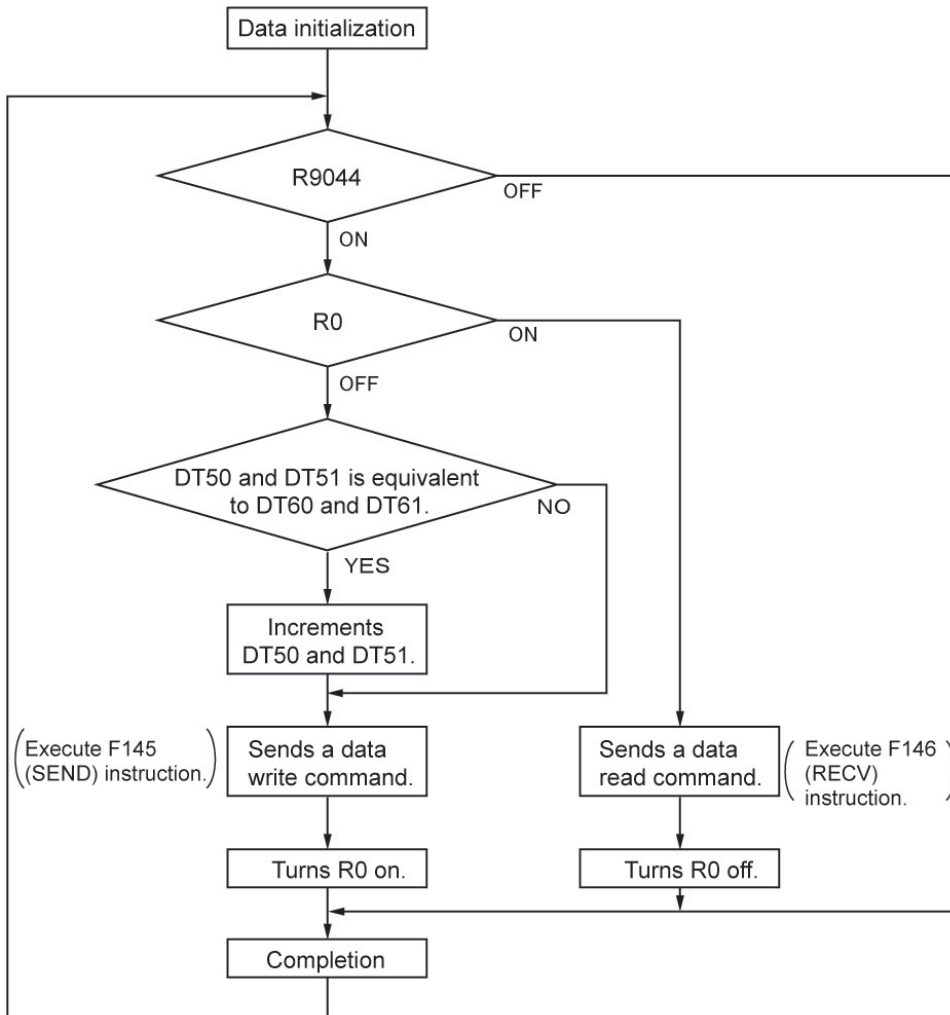

The above program executes the operation 1 to 3 repeatedly.

1. Updates the write data if the write data (DT50 and DT51) and the read data (DT60 and DT61) are matched.
2. Writes the DT50 and DT51 of the local unit into the data DT0 and DT1 in the unit number 1 from the COM port.
3. Reads the data DT0 and DT1 in the unit number 1 into the data DT60 and DT61 of the local unit from the COM port.

Sample program (For Type II)

Use a program as below to directly specify a MODBUS address.

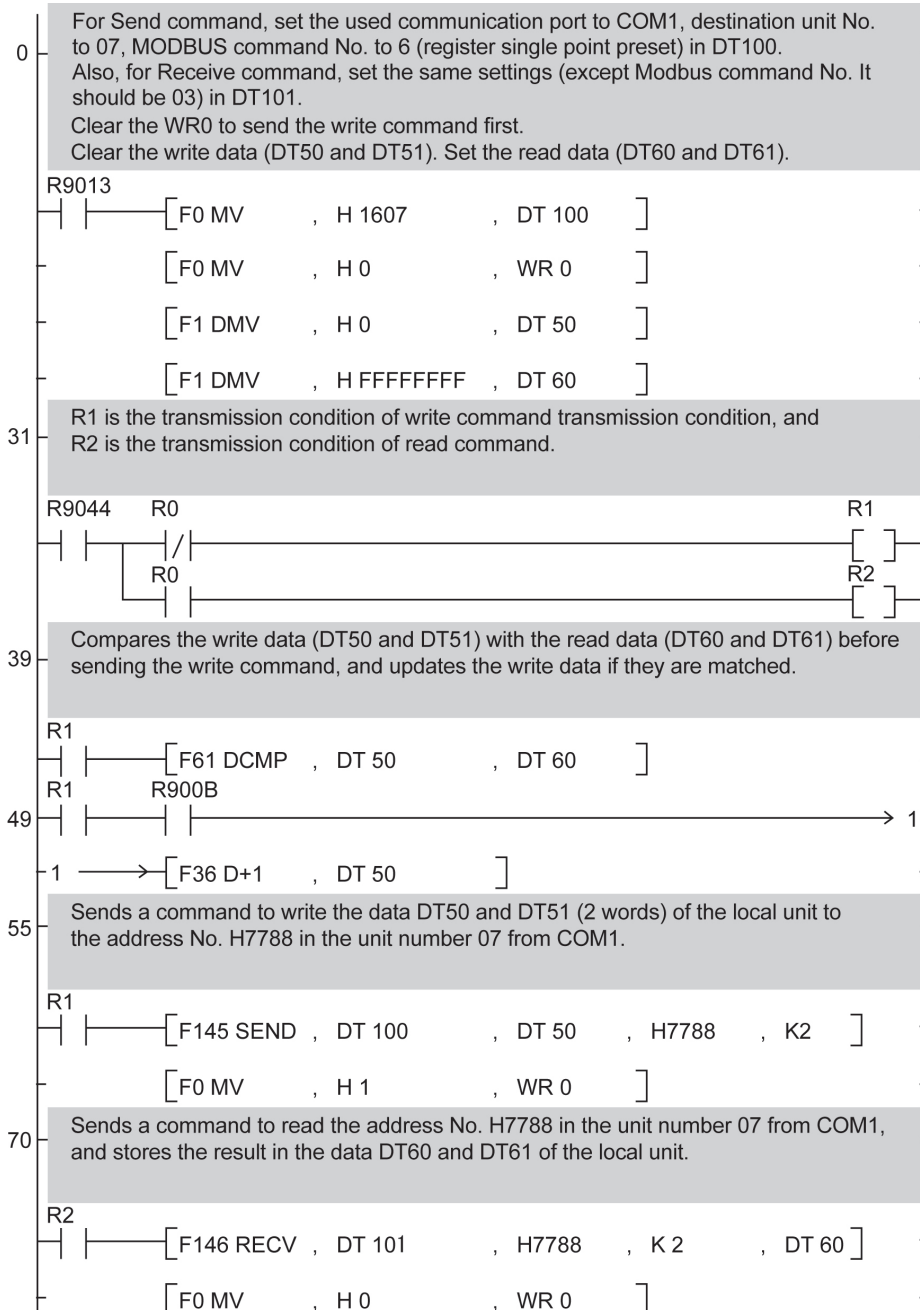

Flow chart (For Type II)

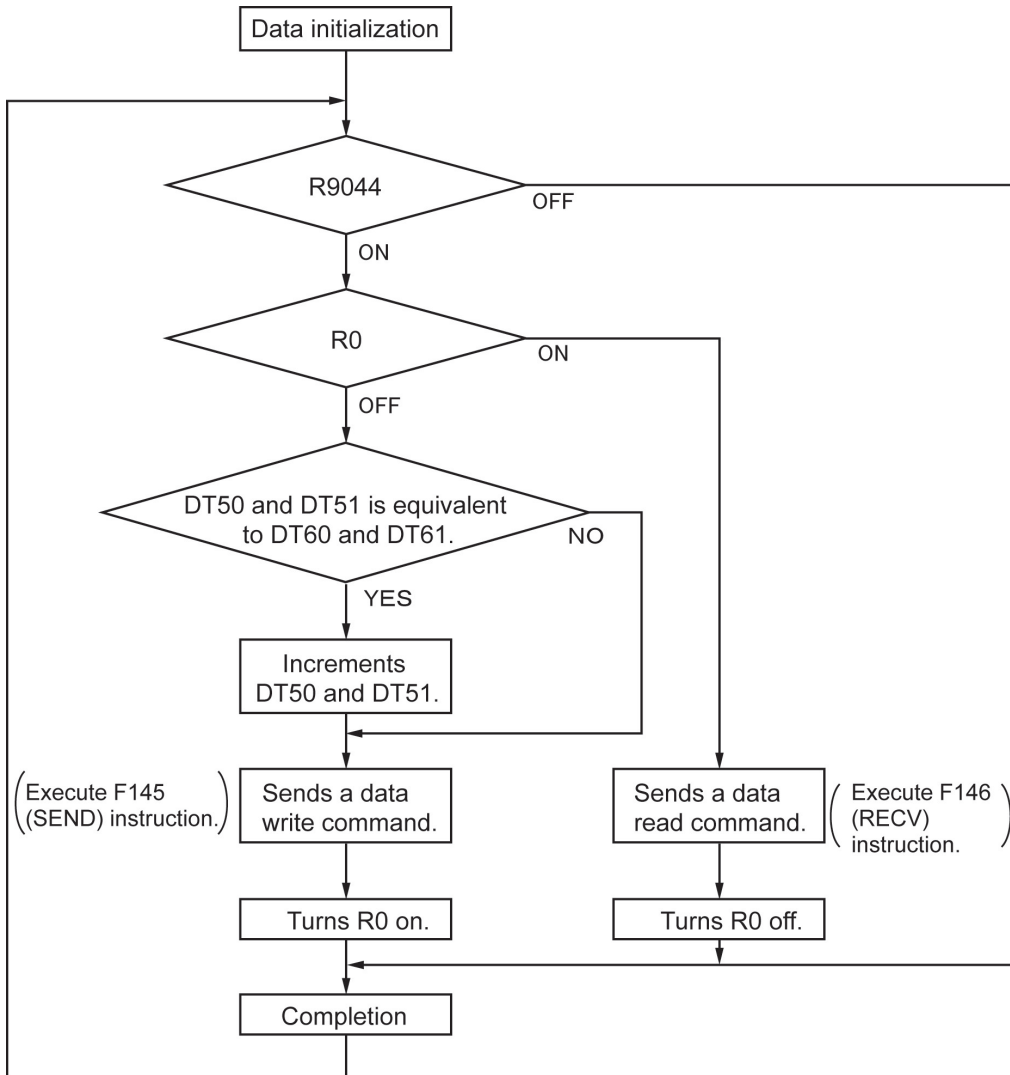

The above program executes the operation 1 to 3 repeatedly.

1. Updates the write data if the write data (DT50 and DT51) and the read data (DT60 and DT61) are matched.
2. Writes the DT50 and DT51 of the local unit into the data No. H7788 in the unit number 07 from the COM port.
3. Reads the data No. H7788 in the unit number 07 into the data DT60 and DT61 of the local unit from the COM port.

Chapter 8

High-speed Counter, Pulse Output and PWM Output Functions

8.1 Overview of Each Functions

8.1.1 Three Pulse Input/Output Functions

High-speed counter function

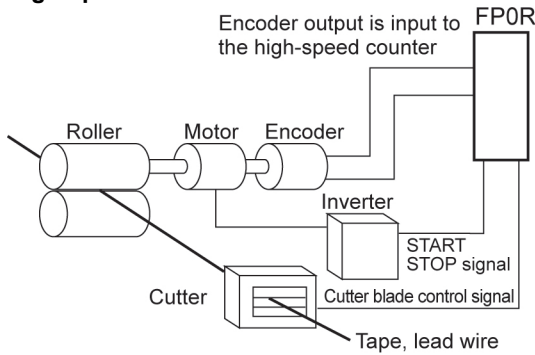

The high-speed counter function counts external inputs such as those from sensors or encoders. When the count reaches the target value, this function turns on/off the desired output.

Pulse output function

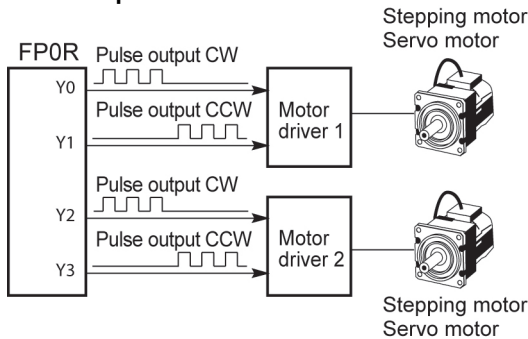

Combined with a commercially available motor driver, the function enables positioning control. With the exclusive instruction, you can perform trapezoidal control, home return, and JOG operation.

PWM output function

● When you increase the pulse width...

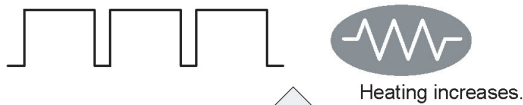

● When you decrease it...



By using the exclusive instruction, the PWM output function enables a pulse output of the desired duty ratio.

8.1.2 Performance of Built-in High-speed Counter

Number of Channel

- There are six channels for the built-in high-speed counter
- The channel number allocated for the high-speed counter will change depending on the function being used.

Counting range

- K-2, 147, 483, 648 to K+2, 147, 483, 647 (Coded 32-bit binary)
- The built-in high-speed counter is a ring counter. Consequently, if the counted value exceeds the maximum value, it returns to the minimum value. Similarly, if the counted value drops below the minimum value, it goes back to the maximum value and continues counting from there.

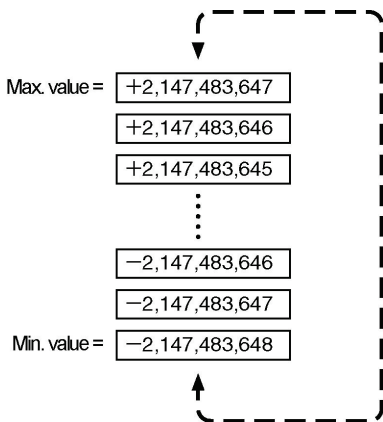

8.2 Function Specifications and Restricted Items

8.2.1 Specifications

High-speed counter function

High-speed counter channel No.		Input/output contact No. being used	Memory area being used			Performance specifications	
		Input contact number (value in parenthesis is reset input) ^{Note1)}	Control flag	Elapsed value area	Target value area	Mini-mum input pulse width ^{Note2)}	Maximum counting speed
[Single phase] Incremental, Decremental	CH0	X0 (X2)	R9110	DT90300 to DT90301	DT90302 to DT90303	10 μ s	6CH: 50 kHz
	CH1	X1 (X2)	R9111	DT90304 to DT90305	DT90306 to DT90307		
	CH2	X3 (X5)	R9112	DT90308 to DT90309	DT90310 to DT90311		
	CH3	X4 (X5)	R9113	DT90312 to DT90313	DT90314 to DT90315		
	CH4 ^{Note3)}	X6 (None)	R9114	DT90316 to DT90317	DT90318 to DT90319		
	CH5 ^{Note3)}	X7 (None)	R9115	DT90320 to DT90321	DT90322 to DT90323		
[2-phase] 2-phase input One input, Direction distinction	CH0	X0 X1 (X2)	R9110	DT90300 to DT90301	DT90302 to DT90303	25 μ s	1CH: 15kHz 2CH: 15kHz 3CH: 10kHz
	CH2	X3 X4 (X5)	R9112	DT90308 to DT90309	DT90310 to DT90311		
	CH4 ^{Note3)}	X6 X7 (None)	R9114	DT90316 to DT90317	DT90318 to DT90319		

Note1) The reset input X2 can be set to either CH0 or CH1. The reset input X5 can be set to either CH2 or CH3. The inputs X4 to X7 are also used for the home input of the pulse output function. It is necessary to set how to use each input by system registers.

Note2) For information on minimum input pulse width, also refer to <8.3.3 Minimum Input Pulse Width>.

Note3) CH4 and CH5 cannot be used for the C10 type.

Note4) The maximum counting speed is the values when executing with the conditions of each item (counting method or number of channels) only. These values are not available if executing the high-speed counter match ON/OFF instruction, other pulse I/O process simultaneously or executing the interrupt program.

Pulse output function

High-speed counter channel No.		Input/output contact number used					Memory area used					
		CW or pulse output	CCW or sign output	Deviation counter clear output		Home input <small>Note3)</small>	Near home input <small>Note2)</small>	Position control starting input <small>Note5)</small>	Pulse output instruction flag	Elapsed value area	Target value area	Target area for match on-off
				C16	C32 T32 F32							
Independence	CH0	Y0	Y1	Y6	Y8	X4	DT90052 <bit4>	X0	R9120	DT90400 DT90401	DT90402 DT90403	DT90404 DT90405
	CH1	Y2	Y3	Y7	Y9	X5		X1	R9121	DT90410 DT90411	DT90412 DT90413	DT90414 DT90415
	CH2	Y4	Y5	None	YA	X6		X2	R9122	DT90420 DT90421	DT90422 DT90423	DT90424 DT90425
	CH3	Y6	Y7	None	YB	X7		X3	R9123	DT90430 DT90431	DT90432 DT90433	DT90434 DT90435
Linear Interpolation	CH0 X axis	Y0	Y1	Y6	Y8	X4	-	R9120	DT90400 DT90401	DT90402 DT90403	DT90404 DT90405	
	CH1 Y axis	Y2	Y3	Y7	Y9	X5		R9121	DT90410 DT90411	DT90412 DT90413	DT90414 DT90415	
	CH2 X axis	Y4	Y5	None	YA	X6		R9122	DT90420 DT90421	DT90422 DT90423	DT90424 DT90425	
	CH3 Y axis	Y6	Y7	None	YB	X7		R9123	DT90430 DT90431	DT90432 DT90433	DT90434 DT90435	

Note1) The pulse output function is available only for the transistor output type.

Note2) When using CH2 or CH3 with the C16 type, the deviation counter clear output cannot be used.

Also, Y6 and Y7 are also used for the pulse output of CH3 and the deviation counter clear of CH0 or CH1, and they can be used only as one of the outputs.

Note3) The home inputs X4 to X7 are also used for the input of the high-speed counter. It is necessary to set how to use each input by system registers.

Note4) The near home input is used by assigning an arbitrary contact and operating the bit 4 of the special data register DT90052 with the instruction (F0).

Note5) The home control start input is used for the trigger to start the position control when using the JOG positioning instruction (F171). It is used by specifying X0 to X3 with the system register or assigning an arbitrary contact and operating the bit 6 of the special data register DT90052 with the instruction (F0).

Note6) For the linear interpolation, CH0 and CH1 or CH2 and CH3 are used in combination.

Note7) The output frequency is the value only when the conditions of each item (such as output method or No. of channels) are executed. This is the value when the pulse input/output process is not simultaneously performed or interrupt program is not executed.

PWM output function

High-speed counter channel No.	Output contact No. used	Pulse output instruction flag	Output frequency	Duty
CH0	Y0	R9120	6 Hz to 4.8 kHz	0.0% to 99.9% (Resolution: 1000)
CH1	Y2	R9121		
CH2	Y4	R9122		
CH3	Y6	R9123		

Note) The PWM output function is only available with the transistor output type.

8.2.2 Functions Used and Restrictions

Simplified chart - Maximum counting speed of High-speed counter

The maximum counting speed of the high-speed counter varies according to No. of channels to be used or the simultaneous use of the pulse output function. Use the chart below as a guide.

Combination of high-speed counter										Max. counting speed (Frequency kHz)			
										Combination with pulse output function (Trapezoidal control, No change in speed 50kHz)			
Single-phase						2-phase				Single-phase	2-phase	Single-phase	2-phase
CH0	CH1	CH2	CH3	CH4	CH5	CH0	CH2	CH4	Single-phase				
A									50		50		
A	A								50		50		
A	A	A							50		50		
A	A	A	A						50	-	50	-	
A	A	A	A	A					50		40		
A	A	A	A	A	A				50		40		
-						A			-	15	-	14	
						A	A			15		10	
						A	A	A		10		10	
		A				A			50	15	50	14	
		A	A			A			50	15	50	14	
		A	A	A		A			50	15	50	14	
		A	A	A	A	A			50	15	50	14	
				A	A	A	A		50	15	50	10	
				A	A	A	A		50	15	50	10	
A								A	50	15	50	12	
A	A							A	50	13	50	12	
A	A	A						A	50	12	50	11	
A	A	A	A					A	50	12	50	9	
A							A	A	50	13	50	10	
A	A						A	A	50	12	50	10	

Note) The maximum counting speed may be lower than the above-mentioned values when the change of pulse output speed, CAM control instruction, target value match ON/OFF instruction and other interrupt programs are executed simultaneously.

Max. counting speed (Frequency kHz)					
Combination with pulse output function (Trapezoidal control, No change in speed 50kHz)					
Pulse output 2 CH		Pulse output 3 CH		Pulse output 4 CH	
Single-phase	2-phase	Single-phase	2-phase	Single-phase	2-phase
50	-	50	-	30	-
50		35		25	
50		30		20	
40		30		20	
35		29		20	
30		24		15	
-	10	-	10	-	10
	9		8		8
	9		8		8
50	10	44	10	30	10
50	10	40	10	28	10
44	10	30	10	25	10
35	10	25	10	20	10
50	9	35	8	28	8
40	9	30	8	25	8
50	10	50	10	40	8
50	10	45	8	35	7
50	9	40	8	30	7
50	8	35	8	30	7
50	10	50	8	40	8
50	9	45	8	35	7

Note) The maximum counting speed may be lower than the above-mentioned values when the change of pulse output speed, CAM control instruction, target value match ON/OFF instruction and other interrupt programs are executed simultaneously.

FP0R pulse output performance

Independent control

Single-phase				Maximum output frequency kHz
CH0	CH1	CH2	CH3	
Available				50
Available	Available			50
Available	Available	Available		50
Available	Available	Available	Available	50

Note) Even if all channels are used, they can be used within the ranges above.

Interpolation control

Linear interpolation		Maximum output frequency kHz (Composite speed)
CH0	CH2	
Available		50
Available	Available	50

Note) Even if all channels are used for the interpolation function, they can be used within the ranges above.

Note) The maximum counting speed may be lower than the above-mentioned values when the change of pulse output speed, CAM control instruction, target value match ON/OFF instruction and other interrupt programs are executed simultaneously.

8.3 High-speed Counter Function

8.3.1 Overview of High-speed Counter Function

Instructions used and the contents of the controls

Type of control	Instruction number	Description
Reset/disabling of counter	F0	Performs controls such as resetting the high-speed counter of the specified channel or disabling the count.
Read/Write of elapsed value	F1	Reads and writes the elapsed value of the high-speed counter.
Target value match ON/OFF control	F166	Turns on (F166 instruction) or off (F167 instruction) the specified output when the elapsed value of the high-speed counter reaches the target value. The output is used by presetting with an instruction such as the SET/RET instruction.
	F167	
Cam control	F165	Turns on or off a maximum of 31 points of internal relays according to the elapsed value of the high-speed counter and the predetermined table.
Input pulse measurement	F178	Measures the pulse number and cycle of the high-speed counter.

Setting the system register

In order to use the high-speed counter function, it is necessary to set system register numbers nos. 400 and 401.

8.3.2 Input Modes and Count

Incremental input mode

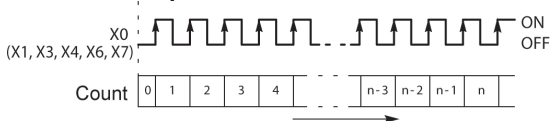

Decremental input mode

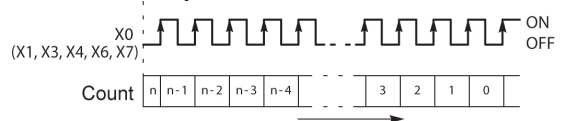

Two-phase input mode

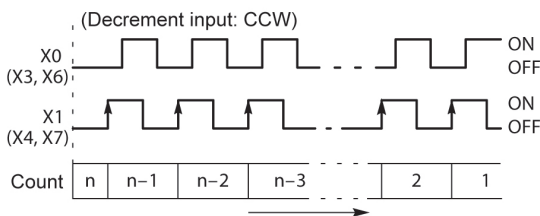
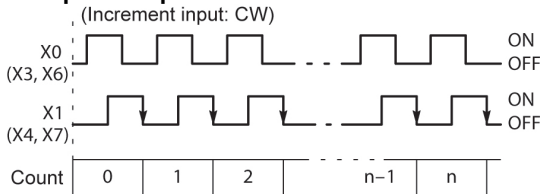

Incremental/decremental input mode

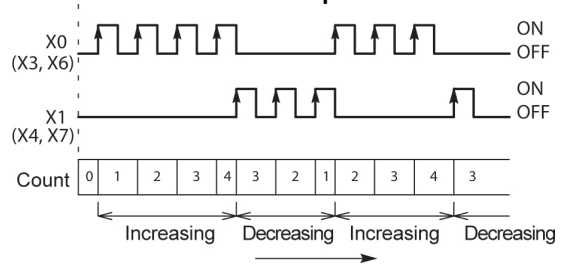

Direction discrimination

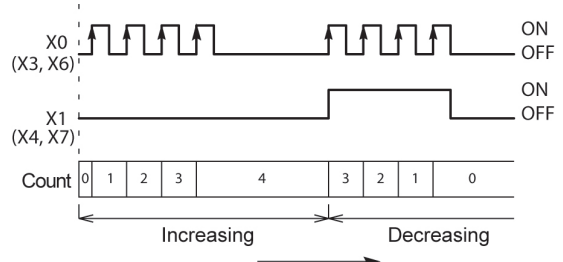

**Count for reset input
(Incremental input mode)**

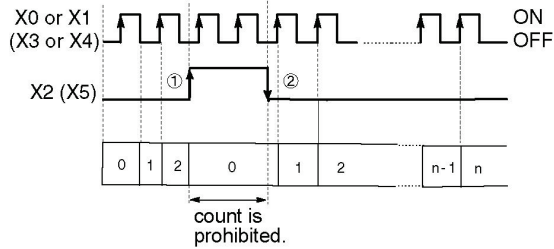

The reset input is executed by the interruption at (1) on (edge) and (2) off (edge).

(1) on (edge) ... Count disable, Elapsed value clear

(2) off (edge) ... Count enable

DT90052 (bit2): "able/disable" setting of the input can be set by the reset input.

8.3.3 Minimum Input Pulse Width

For the period T ($1/\text{frequency}$), a minimum input pulse width of $T/2$ (single-phase input) or $T/4$ (two-phase input) is required.

<Single phase>

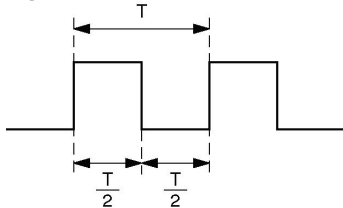

<Two-phase>

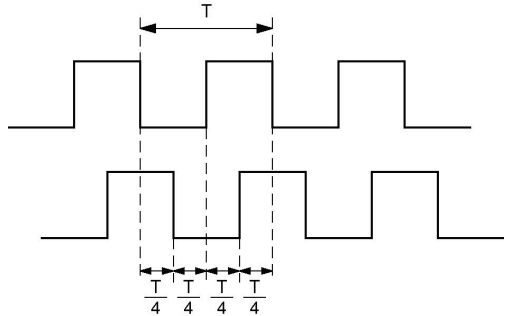

8.3.4 I/O Allocation

- As shown in the table in the previous section “8.2.1”, the inputs and outputs used will differ depending on the channel number being used.
- The output turned on and off can be specified from Y0 to Y7 as desired with instructions F166 (HC1S) and F167 (HC1R).

When using CH0 with incremental input and reset input

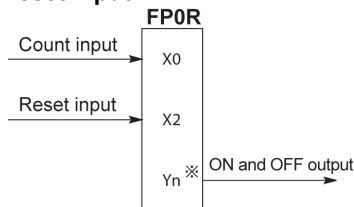

* The output turned on and off when the target value is reached can be specified from Y0 to Y7 as desired.

When using CH0 with two-phase input and reset input

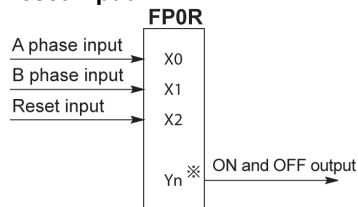

* The output turned on and off when the target value is reached can be specified from Y0 to Y7 as desired.



Reference: <8.2.1 Table of Specifications>

8.3.5 Instructions used with High-speed Counter Function

High-speed counter control instruction (F0)

- This instruction is used for counter operations such as software reset and count disable.
- Specify this instruction together with the special data register DT90052.
- Once this instruction is executed, the settings will remain until this instruction is executed again.

Operations that can be performed with this instruction

- Counter software reset (bit0)
- Counting operation enable/disable (bit1)
- Hardware reset enable/disable (bit2)
- Clear high-speed counter instructions F166 to F167 (bit3)
- Clear target value match interrupt (bit3)

Example: Performing a software reset

In case of CH0

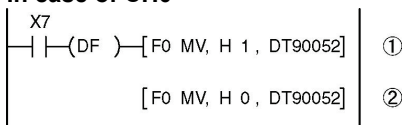

In the above program, the reset is performed in step (1) and 0 is entered just after that in step (2). The count is now ready for operation. If it is only reset, counting will not be performed.

In case of CH1

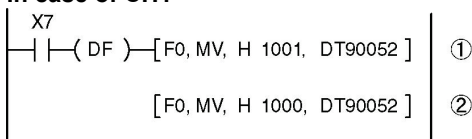

High-speed counter/pulse output control flag area of FP0R

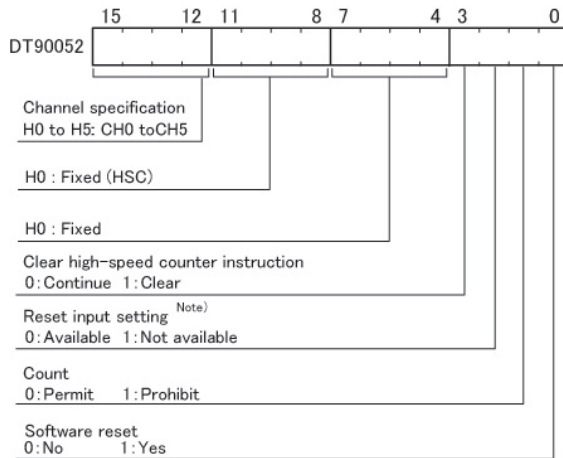

- The area DT90052 for writing channels and control codes is allocated as shown in the left figure.
- Control codes written with an F0 (MV) instruction are stored by channel in special data registers DT90370 to DT90375.

Note) In the reset input setting, the reset input allocated in the high-speed counter setting of the system registers are defined to “enable/disable”.

High-speed counter control flag monitor area

Channel No.	Control code flag monitor area
CH0	DT90370
CH1	DT90371
CH2	DT90372
CH3	DT90373
CH4	DT90374
CH5	DT90375

Elapsed value write and read instruction (F1)

- This instruction writes or reads the elapsed value of the high-speed counter.
- Specify this instruction together with the elapsed value area of high-speed counter after the special data register DT90300.
- If the F1 (DMV) instruction is executed specifying DT90300, the elapsed value will be stored as 32-bit data in the combined area of special data registers DT90300 and DT90301.
- Use this F1 (DMV) instruction to set the elapsed value.

Example 1: Writing the elapsed value

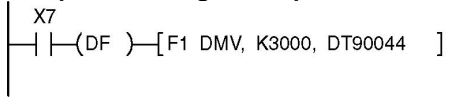

Set the initial value of K3000 in the high-speed counter.

Example 2: Reading the elapsed value

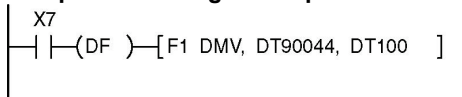

Read the elapsed value of the high-speed counter and copies it to DT100 and DT101.



Note:

The elapsed value area varies during scanning. Replace it with an arbitrary data register at the beginning of the program as necessary in cases such as using it several times in the program.

Target value match ON instruction (F166)

Example 1:

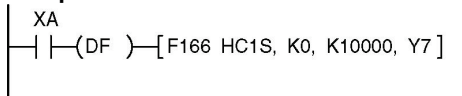

If the elapsed value (DT90300 and DT90301) for channel 0 matches K10000, output Y7 turns on.

Example 2:

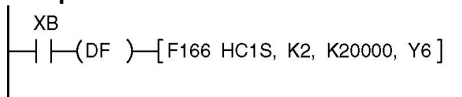

If the elapsed value (DT90308 and DT90309) for channel 2 matches K20000, output Y6 turns on.

Target value match OFF instruction (F167)

Example 1:

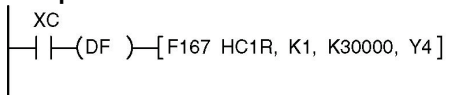

If the elapsed value (DT90304 and DT90305) for channel 1 matches K30000, output Y4 turns off.

Example 2:

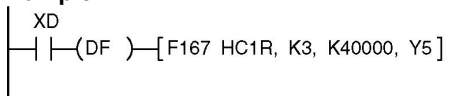

If the elapsed value (DT90312 and DT90313) for channel 3 matches K40000, output Y5 turns off.

Input pulse measurement instruction (F178)

- This instruction is used to measure the pulse number and cycle of a specified high-speed counter channel when using the high-speed counter function.
 - The pulse number to be measured is counted in a specified counting cycle.
 - The one pulse (on-off cycle) right after the execution of the instruction is measured as the pulse cycle.
- Note) The last numbers of the actual measured values may vary due to the measurement error.

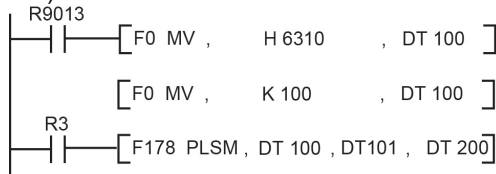

Setting conditions:

- Channel No.: 0
- Storage location of measured pulse number: DT200 to DT201
- No. of moving average of measured pulse number: Once
- Measurement cycle of measured pulse number: 100ms
- Pulse cycle measurement by 1μs and 1 ms
- Storage location of measured pulse cycle (1 μs unit): DT202 to DT203
- Storage location of measured pulse cycle (1 ms unit): DT204 to DT205
- Measurement limit of measured pulse cycle (1ms unit): 2s

Operation of F178 instruction (In case of the above sample program)

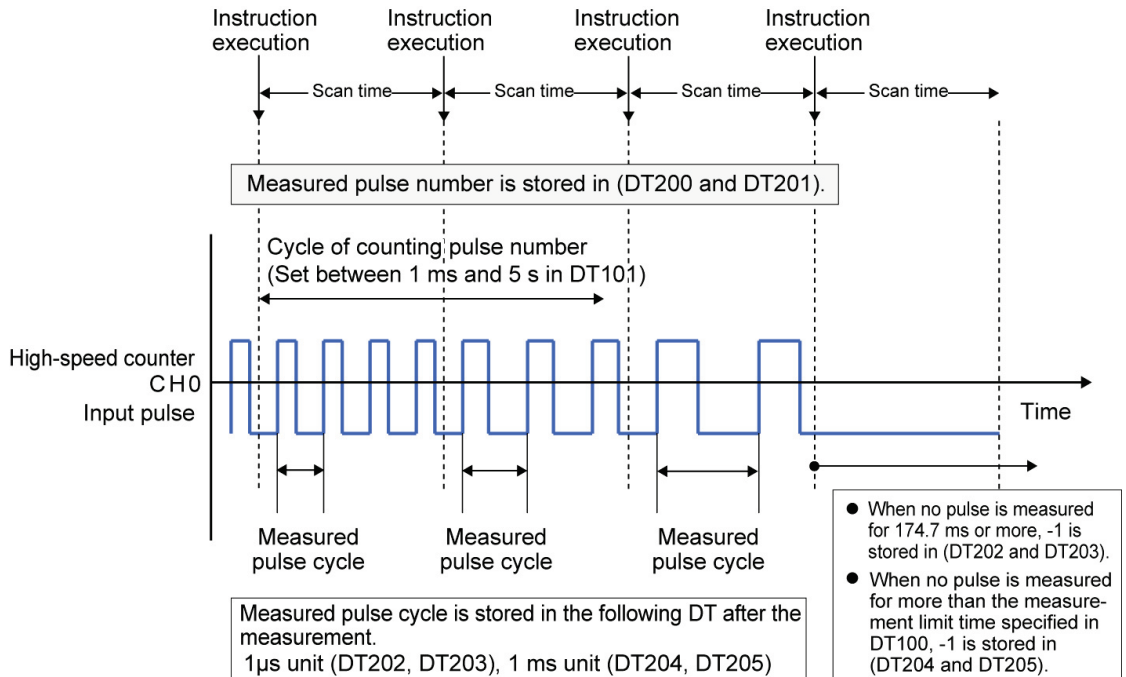

Example) When a single pulse of 250Hz was measured repeatedly
Pulse number measured within 100 ms: 25 (Error±1) is stored in DT200 and DT201.
Pulse cycle: $1/250 \times 10^6 = 4000$ (Error±1) is stored in DT202 and DT203.
Pulse cycle: $1/250 \times 10^3 = 4$ (Error±1) is stored in DT204 and DT205.

Sample program (F178)

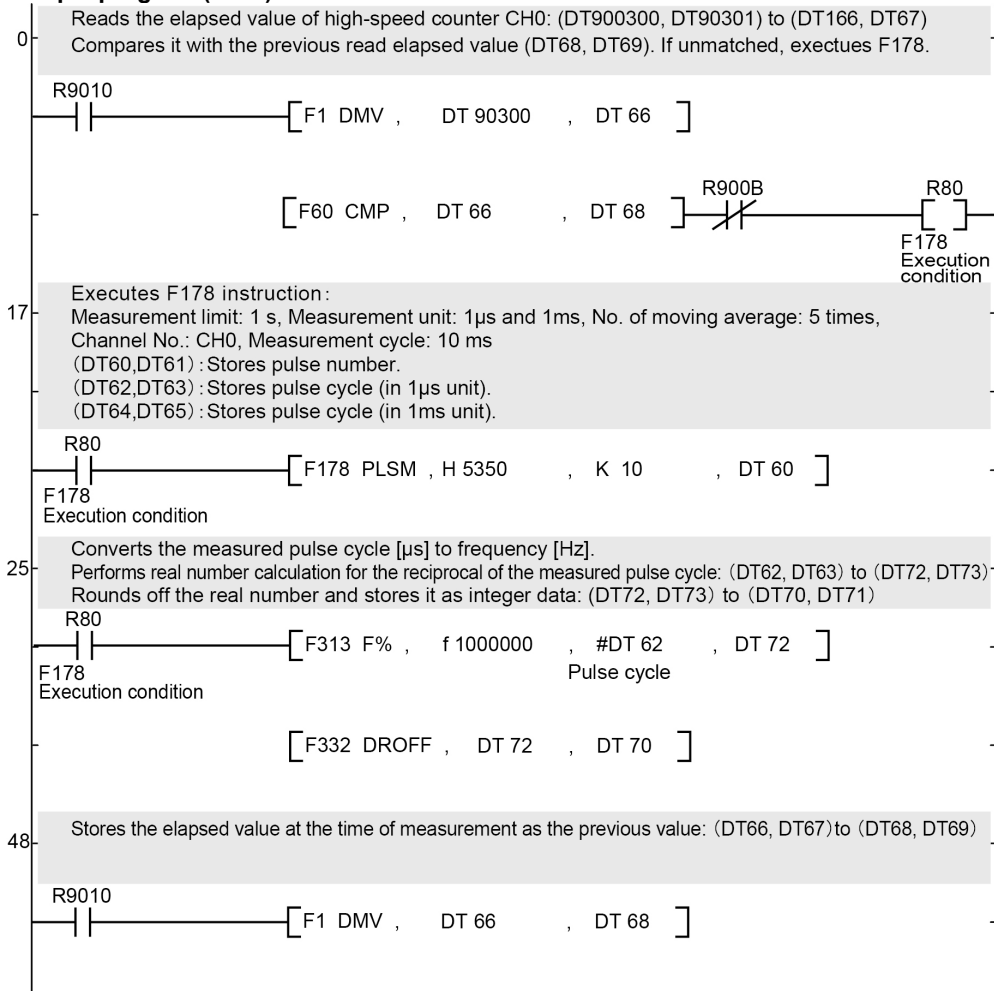

8.3.6 High-speed counter control flag

Note that there are the following restrictions on using each function of the high-speed counter.

Allocation and role of high-speed counter control flag

- When a high-speed counter instructions (F165/F166/F167/F178) is executed, the high-speed counter control flag of the corresponding channel is ON. No other high-speed counter instruction can be executed as long as this flag is ON.
- The high-speed counter control flags are allocated to each channel.

Channel No.	High-speed counter control flag
CH0	R9110
CH1	R9111
CH2	R9112
CH3	R9113

Operation of high-speed counter control flag

- The high-speed counter flag varies during scanning. Replace it with an internal relay at the beginning of the program when using it several times in the program.

8.3.7 Sample program

Positioning operations with a single speed inverter

Wiring example

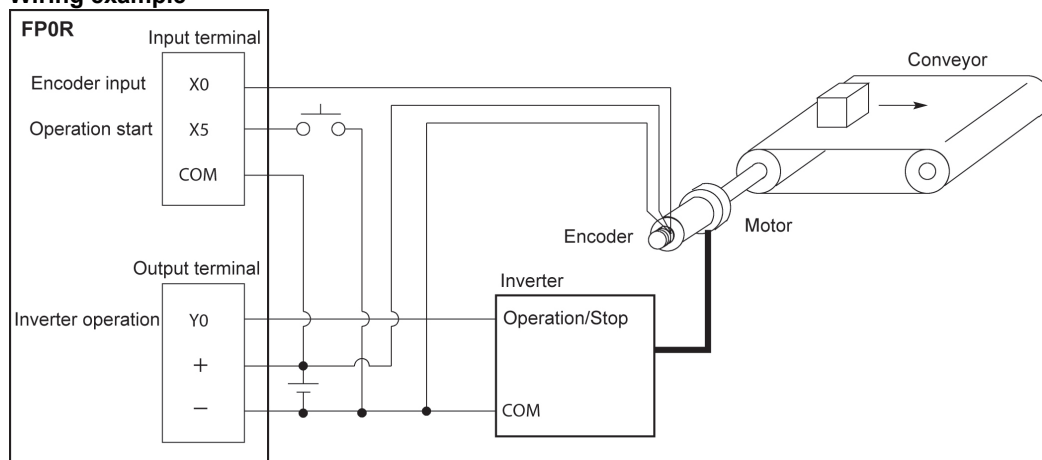

Operation chart

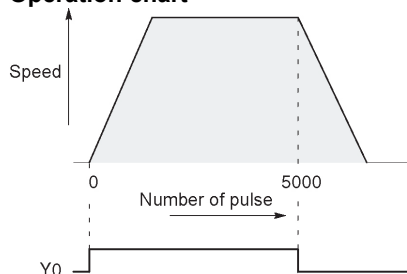

I/O allocation

I/O No.	Description
X0	Encoder input
X5	Operation start signal
Y0	Inverter operation signal
R100	Positioning operation running
R101	Positioning operation start
R102	Positioning done pulse
R9110	High-speed counter CH0 control flag

Program

When X5 is turned on, Y0 turns on and the conveyor begins moving. When the elapsed value (DT90300 and DT90301) reaches K5000, Y0 turns off and the conveyor stops.

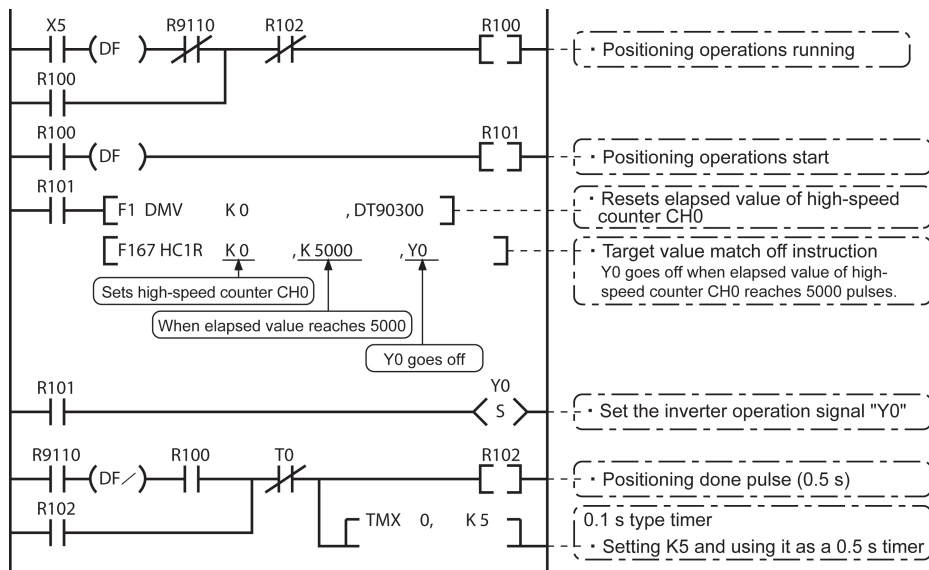

Positioning operations with a double speed inverter

Wiring example

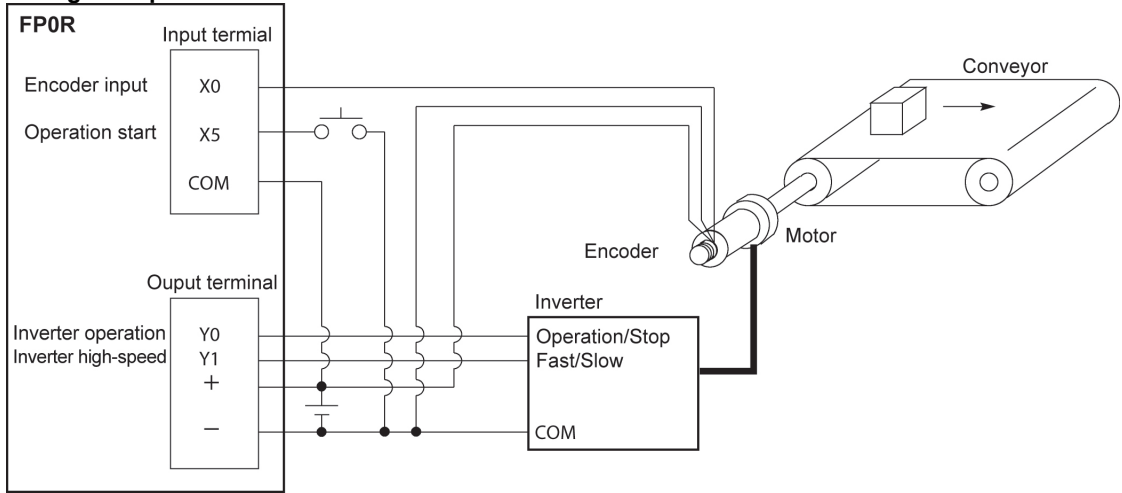

Operation chart

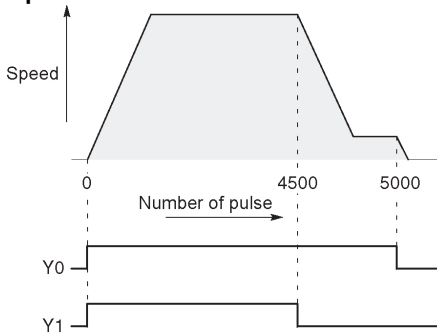

I/O allocation

I/O No.	Description
X0	Encoder input
X5	Operation start signal
Y0	Inverter operation signal
Y1	Inverter high-speed signal
R100	Positioning operation running
R101	Positioning operation start
R102	Arrival at deceleration point
R103	Positioning done pulse
R900C	Comparison instruction <flag>
R9110	High-speed counter CH0 control flag

Program

When X5 is turned on, Y0 and Y1 turn on and the conveyor begins moving. When the elapsed value (DT90300 and DT90301) reaches K4500, Y1 turns off and the conveyor begins decelerating. When the elapsed value reaches K5000, Y0 turns off and the conveyor stops.

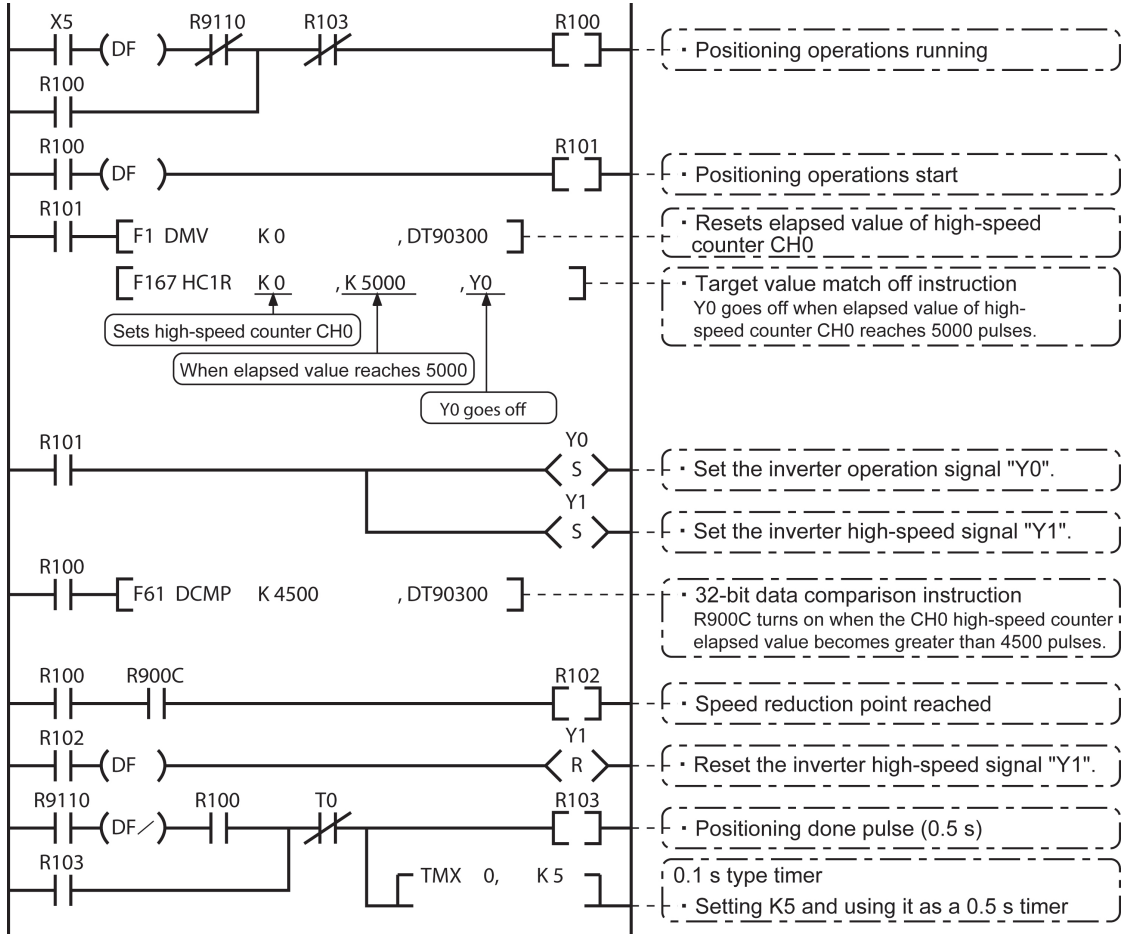

8.4 Pulse Output Function

8.4.1 Overview of Pulse Output Function

Instructions used and the contents of the controls

Type of control	Instruction number	Description
Forced stop, deceleration stop	F0	Controls to stop a specified channel.
Read/Write of elapsed value	F1	Reads and writes the elapsed value of the built-in high-speed counter during the pulse output control.
JOG operation	F172	Outputs pulses as long as the execution condition is on.
Home return	F177	Performs the home return in a specified channel.
Trapezoidal control	F171	Automatically outputs pulses with the trapezoidal control by specifying the initial speed, target speed, acceleration time, deceleration time and target value.
JOG positioning	F171	Outputs specified pulses after the position control start input during the JOG operation.
Data table control	F174	Outputs pulses according to a specified data table.
Linear interpolation	F175	Performs the linear interpolation control by specifying the composite speed, acceleration time, deceleration time, X-axis target value and Y-axis target value.

Setting the system register

For using the pulse output function, it is necessary to set the system register No. 402.

8.4.2 Types of Pulse Output Method and Operation Modes

Clockwise/counter-clockwise output method

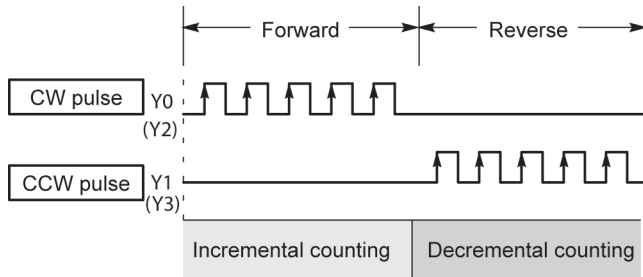

Control is carried out using two pulses: a forward rotation pulse and a reverse rotation pulse.

Pulse/direction output method (forward: OFF/reverse: ON)

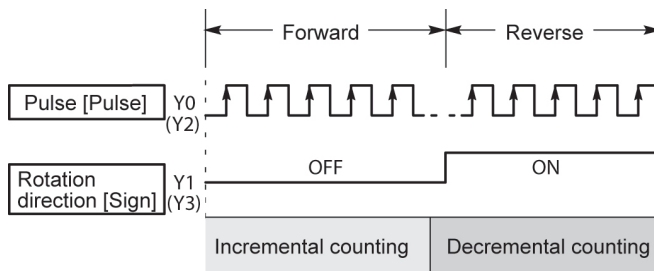

Control is carried out using one pulse output to specify the speed and another to specify the direction of rotation with on/off signals. In this mode, forward rotation is carried out when the rotation direction signal is OFF.

Pulse/direction output method (forward: ON/reverse: OFF)

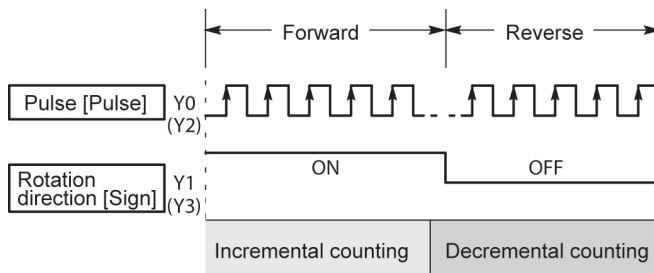

Control is carried out using one pulse output to specify the speed and another to specify the direction of rotation with on/off signals. In this mode, forward rotation is carried out when the rotation direction signals is ON.

Operation mode**Incremental <Relative value control>**

Outputs the pulses set with the target value.

Selected Mode Target value	CW/CCW	Pulse and direction forward OFF/ reverse ON	Pulse and direction forward ON/ reverse OFF	HSC counting Method
Positive	Pulse output from CW	Pulse output when direction output is OFF	Pulse output when direction output is ON	Incremental
Negative	Pulse output from CCW	Pulse output when direction output is ON	Pulse output when direction output is OFF	Decremental

Example:

When the current position (value of elapsed value area) is 5000, the pulse of 1000 is output from CW by executing the pulse output instruction with the target value +1000, and the current position will be 6000.

Absolute <Absolute value control>

Outputs a number of pulses equal to the difference between the set target value and the current value.

Selected Mode Target value	CW/CCW	Pulse and direction forward OFF/ reverse ON	Pulse and direction forward ON/ reverse OFF	HSC counting method
Target value greater than current value	Pulse output from CW	Pulse output when direction output is OFF	Pulse output when direction output is ON	Incremental
Target value less than current value	Pulse output from CCW	Pulse output when direction output is ON	Pulse output when direction output is OFF	Decremental

Example:

When the current position (value of elapsed value area) is 5000, the pulse of 4000 is output from CCW by executing the pulse output instruction with the target value +1000, and the current position will be 1000.

8.4.3 I/O Allocation

Double pulse input driver (CW pulse input and CCW pulse input method)

- Two output contacts are used as a pulse output for “CW, CCW”.
- The I/O allocation of pulse output terminal and home input is determined by the channel used.
- Set the control code for F171 (SPDH) instruction to “CW/CCW”.

<When using CH0>

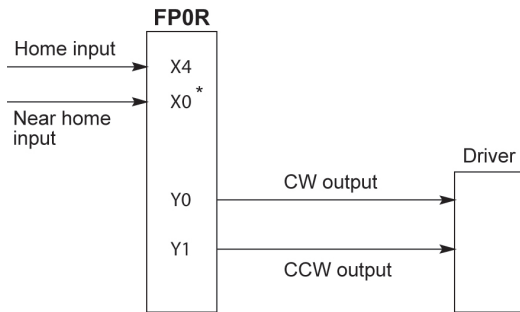

* X0 or any other input can be specified for the near home input.

<When using CH2>

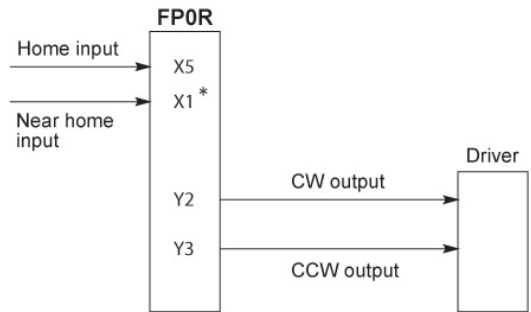

* X1 or any other input can be specified for the near home input.

Single pulse input driver (pulse input and directional switching input method)

- One output point is used as a pulse output and the other output is used as a direction output.
- The I/O allocation of pulse output terminal, direction output terminal, and home input is determined by the channel used.
- Near home input is substituted by allocating the desired contact and turning on and off the <bit4> of special data register DT90052.
- Up to four driver systems can be connected.

<When using CH0>

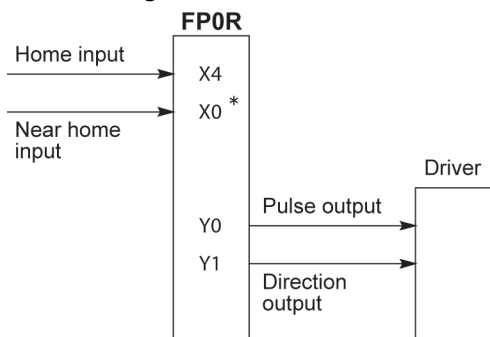

* X0 or any other input can be specified for the near home input.

<When using CH2>

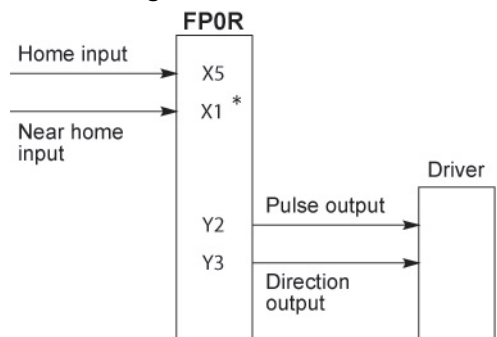

* X1 or any other input can be specified for the near home input.



Reference: <8.2.1 Table of Specifications>

Wiring example

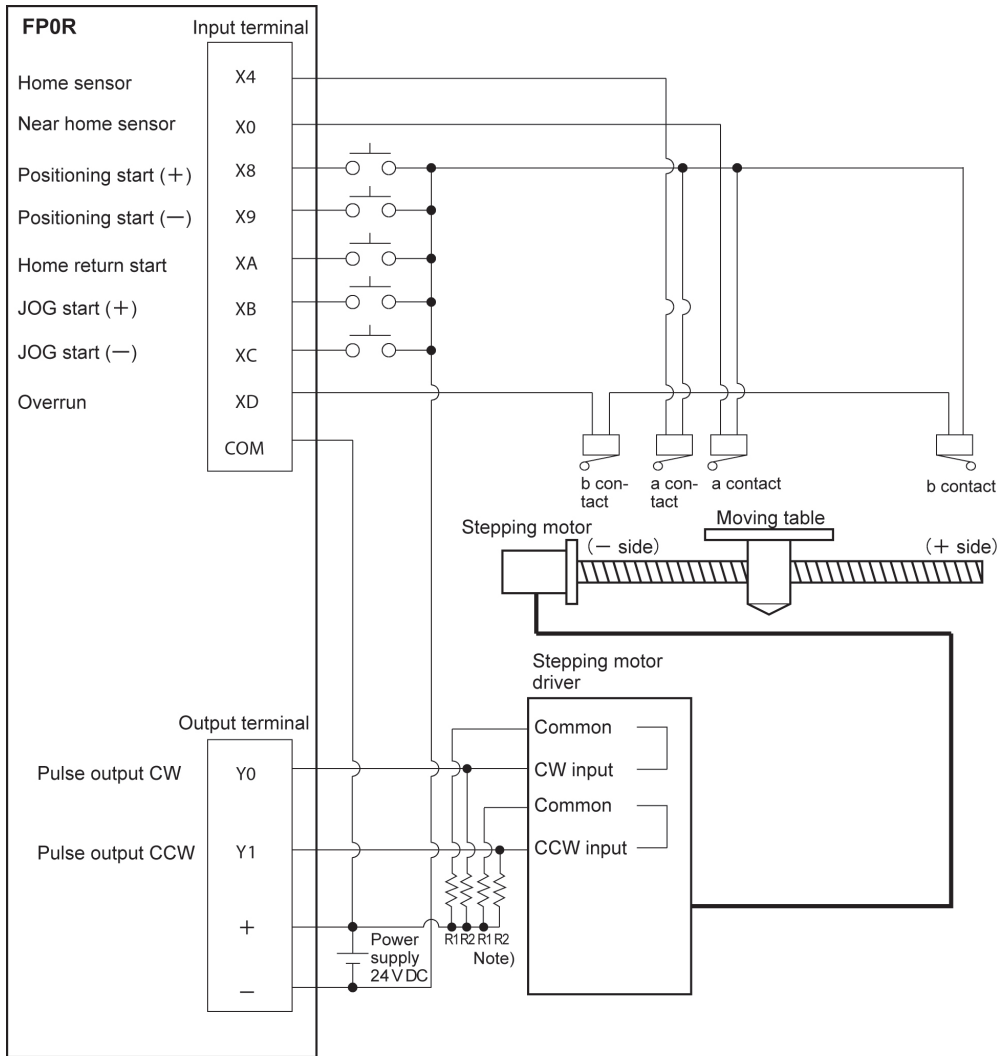

Note) When the stepping motor input is a 5 V optical coupler type, connect a resistor of 2 k Ω (1/2 W) to R1, and connect a resistor of 2 k Ω (1/2 W) – 470 Ω (2 W) to R2.

Table of I/O allocation

I/O No.	Description
X4	Home sensor input
X0	Near home sensor input
X8	Positioning start signal (+)
X9	Positioning start signal (-)
XA	Home return start signal
XB	JOG start signal (+)
XC	JOG start signal (-)
XD	Overrunning signal
Y0	Pulse output CW
Y1	Pulse output CCW

8.4.4 Pulse output control instructions (F0) (F1)

Pulse output control instruction (F0)

- This instruction is used for resetting the built-in high-speed counter, stopping the pulse output, and setting and resetting the near home input.
- Specify this F0 (MV) instruction together with special data register DT90052.
- Once this instruction is executed, the settings will remain until this instruction is executed again.

Example 1:

Enable the near home input during home return operations and begin deceleration.

In case of CH0

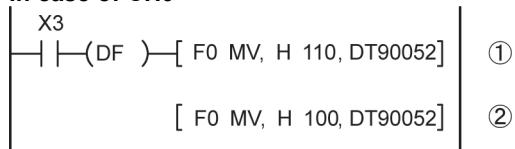

In these programs, the near home input is enabled in step (1) and 0 is entered just after that in step (2) to perform the preset operations.

Operations executable by Pulse output control instruction (F0)

DT90052 Bit No.	Type of control	Description
0	Software reset	Resets the value in an elapsed value area (Example: For CH0, DT90400 and DT90401).
1	Count disable/enable	Disables or enables the count of an elapsed value area (Example: For CH0, DT90400 and DT90401).
2	Clear of pulse output control	Clears the control of the target value match ON/OFF instructions F166/F167.
3	Stop of pulse output	Forcibly stops the pulse output during the execution of the pulse output instructions F171 to F177.
4	Near home input	Enables the near home input when executing the home return instruction F177. Allocates an arbitrary input to the near home input.
5	Deceleration stop request	Forcibly stops the pulse output during the execution of the pulse output instructions F171 to F177.
6	Request of position control	Can be used as an input to start positioning control when executing the JOG positioning instruction (F171).

FP0R Pulse output control flag area

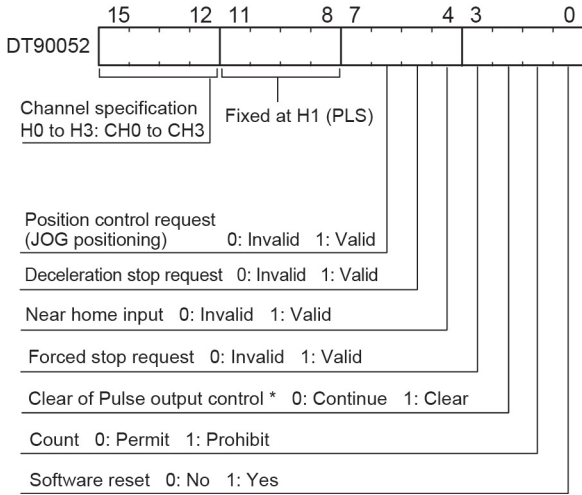

- The area DT90052 for writing channels and control codes is allocated as shown in the left figure.
- Control codes written with an F0 (MV) instruction are stored by channel in special data register DT90380 to DT90383.

Pulse output control flag monitor area

Channel No.	Control code monitor area
CH0	DT90380
CH1	DT90381
CH2	DT90382
CH3	DT90383

8.4.5 Forced Stop, Deceleration Stop (F0) Instruction

Pulse output control instruction (F0)

- Forced stop and deceleration stop is executed by F0(MV) instruction in combination with the special data register DT90052. Once this instruction is executed, the settings will remain until this instruction is executed again.

[Example] Performing the forced stop of pulse output.

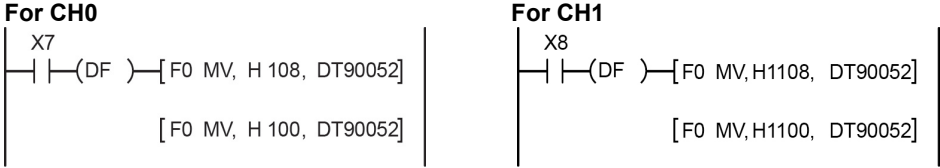

[Example 2] Performing the deceleration stop of pulse output

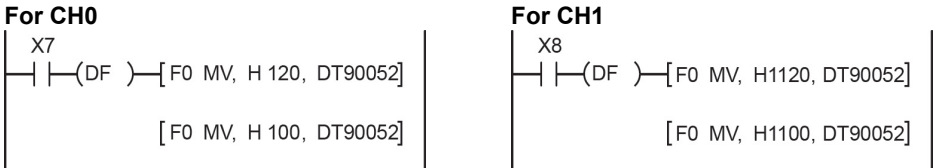

Note:

- Performing a forced stop may cause the elapsed value at the PLC output side to differ from the elapsed value at the motor input side. Therefore, you must execute a home return after pulse output has stopped..
- When executing the forced stop (pulse output stop) with the pulse output control instruction (F0), the operations being executed with various instructions are cancelled and the pulse output is immediately stopped. When the forced stop request flag (bit3 of DT90052) is on, instructions cannot be executed.
- When executing the deceleration stop with the pulse output control instruction (F0), the operations being executed with various instructions are cancelled and the deceleration operation starts. When the deceleration stop request flag (bit5 of DT90052) is on, instructions cannot be executed. As for the data table control instruction (F174), the operation is similar to that of the forced stop.
- After the execution of the forced stop or deceleration stop, pulses are not output unless the execution condition of each pulse output instruction (F171 to F177) changes from OFF to ON.

8.4.6 Elapsed Value Read and Write (F1) Instruction

Elapsed value read and write instruction (F1)

- This instruction is used to read and write the pulse number counted by the pulse output control.
- Specify this F1 (DMV) instruction in combination with the pulse output elapsed area after the special data register DT90400.
- When executing the F1 (DMV) instruction with DT90400, the elapsed value is stored as 32-bit data in the combined area of the special data registers DT90400 and DT90401.
- The elapsed values can be read or written with this F1 (DMV) instruction only.

Example 1: Writing the elapsed value

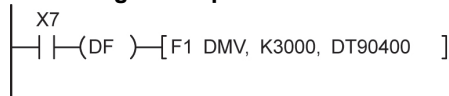

Set the initial value K3000 in the pulse output CH0.

Example 2: Reading the elapsed value

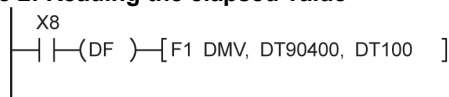

Read the elapsed value of the pulse output CH0 to DT100 and DT101.

Elapsed value area

Channel No.	Pulse output elapsed value area
CH0	DT90400 to DT90401
CH1	DT90410 to DT90411
CH2	DT90420 to DT90421
CH3	DT90430 to DT90431



Note:

The elapsed value area varies during scanning. Replace it with an arbitrary data register at the beginning of the program as necessary in cases such as using it several times in the program.

8.4.7 JOG Operation Instruction (F172)

- This instruction is used to output pulses according to a specified parameter when the trigger (execution condition) is on.
- When the trigger (execution condition) turns off, deceleration is performed within a specified deceleration time. However, if the trigger turns on again, acceleration is performed up to the target speed again.
- When the deceleration stop is requested by the F0 instruction during the pulse output, the deceleration stop is performed.
- There are two kinds of control method, which are type 0 and type 1.

Operation modes of JOG operation

There are two operation modes for the JOG operation, which are type 0 and type 1. Those operation specifications for the specified target value differ.

Type 0

Regardless of the settings for the target value, the JOG operation is performed when the trigger is on.

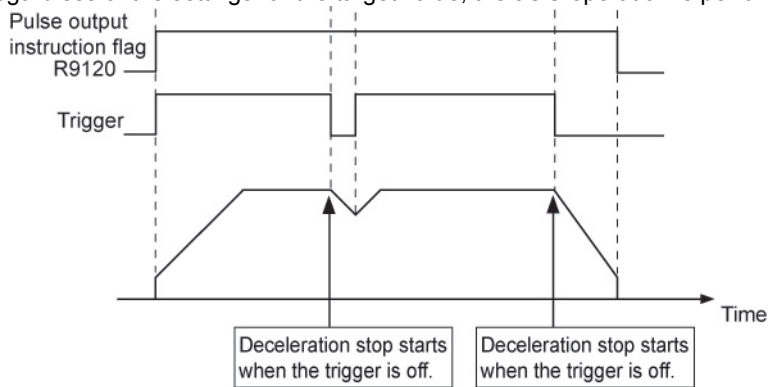

Type 1

Even if the trigger is on, the deceleration stop is performed according to the settings of the target value.

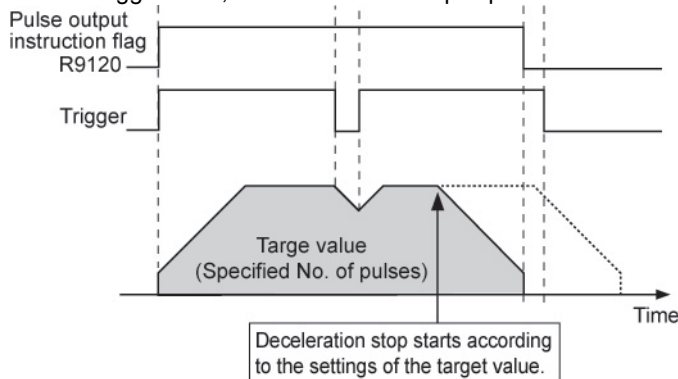

Sample program JOG operation: Type 0 (No target value)

The explanation below shows the case that pulses are output from Y0 when using forward rotation and Y1 when using reverse rotation with the following conditions; Initial speed: 1 kHz, Target speed: 7kHz, Acceleration time: 100 ms, Deceleration time: 1000 ms.

Timing chart

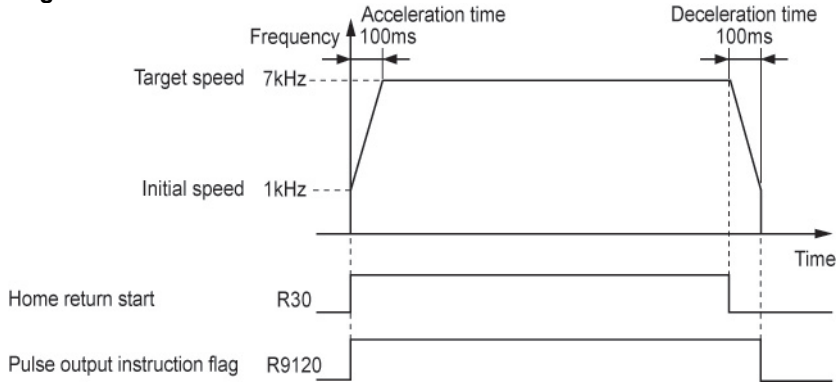

Data table

Data register No.	Setting item (Unit)	Example of sample program	Settable range
DT300	Control code	Type 0 (No target value) Output type: CW/CCW H1000 0000 (Forward) H1000 0010 (Reverse)	Set according to the control code on the next page.
DT302	Initial speed (Hz)	K1000	K1 to K50000
DT304	Target speed (Hz)	K7000	K1 to K50000
DT306	Acceleration time (ms)	K100	K1 to K32760
DT308	Deceleration time (ms)	K100	K1 to K32760
DT310	Target value (pulses)	K0	K-2,147,483,648 to K+2,147,483,647

Note)

1. Each setting item occupies 2-word data registers.
2. When the control type 0 (No target value) is specified for the control code, the target value (pulse number) of data table is invalid.
3. For the JOG operation, the time from the initial speed to the maximum speed (50 kHz) is specified as acceleration time or deceleration time. For the details, refer to "8.4.17 Difference in Acceleration/Deceleration Characteristics Between Instructions".

Sample program

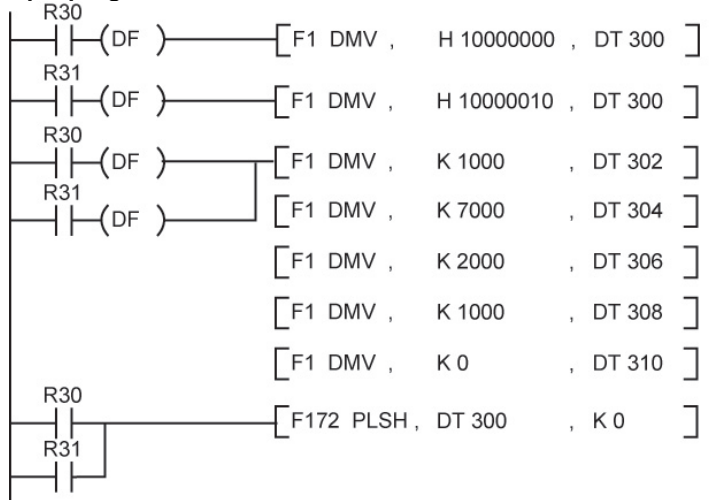

Control code

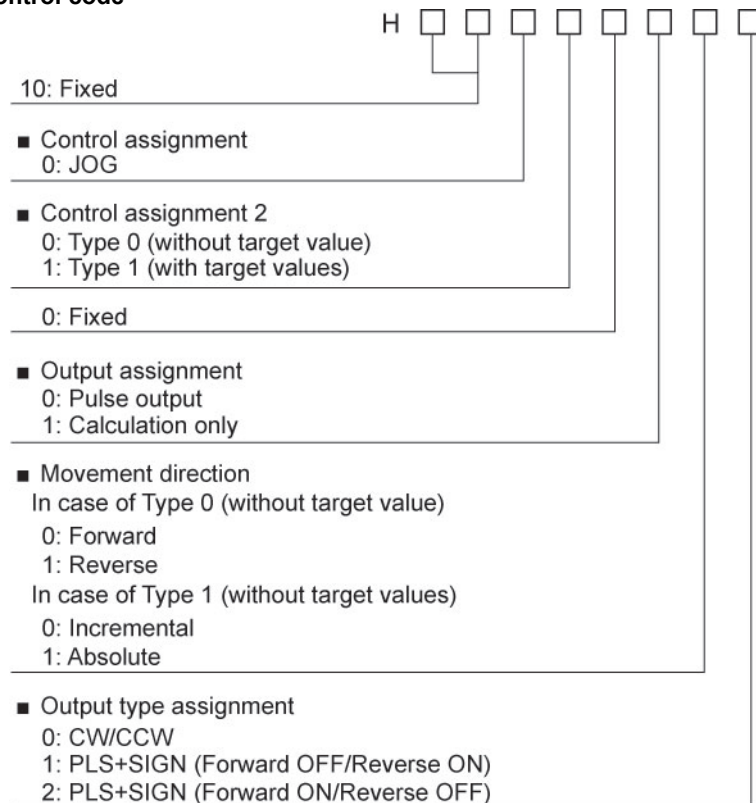

Precautions during programming

- For using the pulse output function, it is necessary to set the system register No. 402.
- Performing rewriting during RUN stops the pulse output.

Sample program JOG operation: Type 1 (With target value)

- The explanation below shows the case that pulses are output from Y0 when using forward rotation and Y1 when using reverse rotation with the following conditions; Initial speed: 1 kHz, Target speed: 5kHz, Acceleration time: 120 ms, Deceleration time: 120 ms.
- When the elapsed value (absolute value) reaches K324000 (positive direction) and K-45600 (negative direction), the deceleration stop is performed.

Timing chart

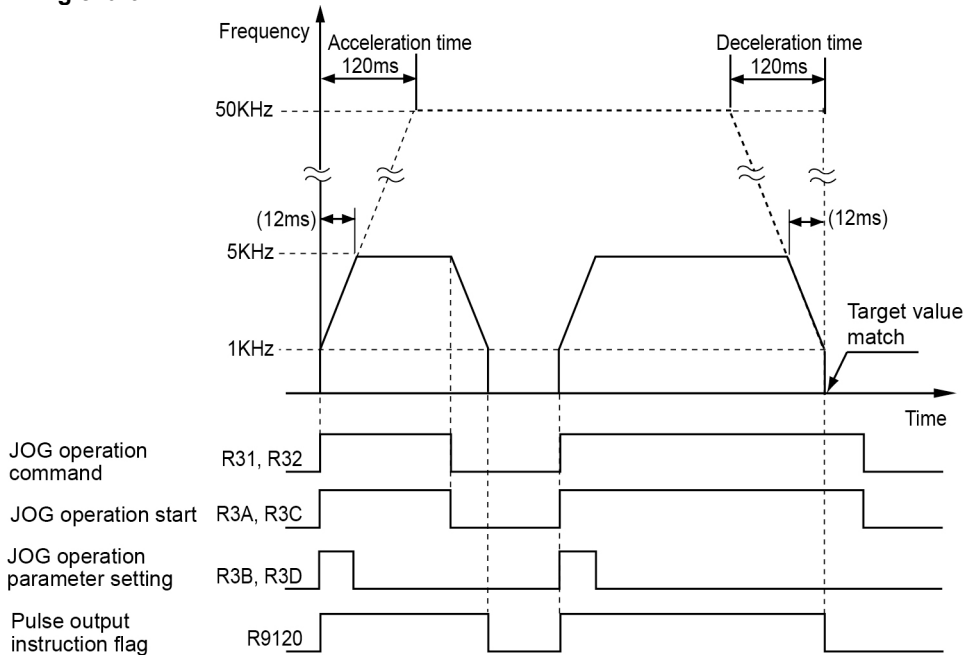

Data table

Data register No.	Setting item (Unit)	Example of sample program	Settable range
DT300	Control code	Type 1 (With target value) Absolute CW/CCW H1001 0010	Set according to the control code on the next page.
DT302	Initial speed (Hz)	K1000	K1 to K50000
DT304	Target speed (Hz)	K5000	K1 to K50000
DT306	Acceleration time (ms)	K120	K1 to K32760
DT308	Deceleration time (ms)	K120	K1 to K32760
DT310	Target value (pulses)	324000 (Positive direction) K-45600 (Negative direction)	K-2,147,483,648 to K+2,147,483,647

Note)

1. Each setting item occupies 2-word data registers.
2. When the control type 0 (No target value) is specified for the control code, the target value (pulse number) of data table is invalid.
3. For the JOG operation, the time from the initial speed to the maximum speed (50 kHz) is specified as acceleration time or deceleration time. For the details, refer to "8.4.17 Difference in Acceleration/Deceleration Characteristics Between Instructions".

Sample program

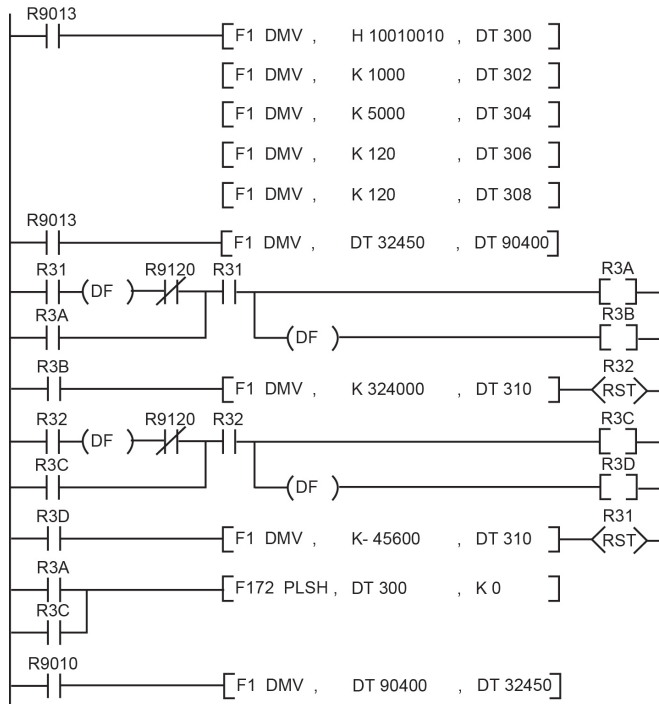

Control code

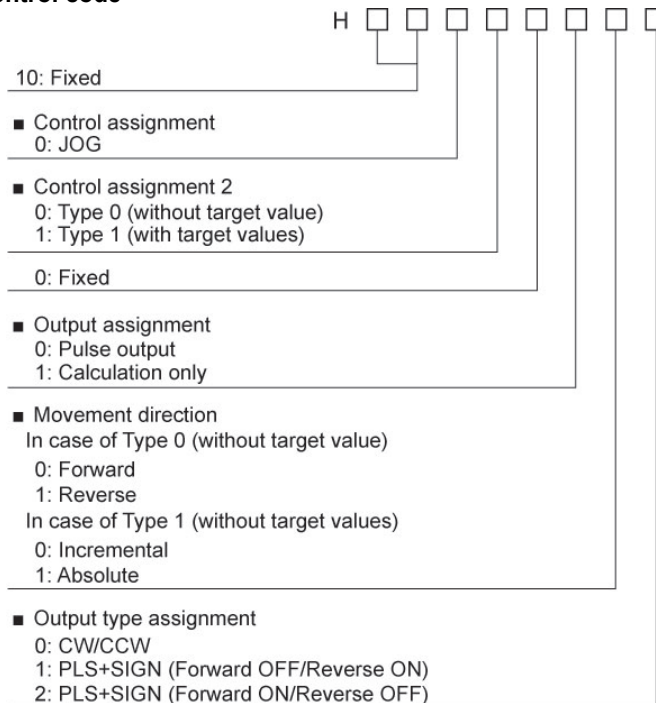

Precautions during programming

- For using the pulse output function, it is necessary to set the system register No. 402.
- Performing rewriting during RUN stops the pulse output.

8.4.8 Home Return Instruction (F177)

- When the trigger (execution condition) turns on, the home return is performed according to a specified data table.
- On the completion of the home return, the elapsed value area is reset to "0".

Operation modes of Home return operation

There are two kinds of operation modes, which are type 0 and type 1.

Type 0

The home input is effective regardless of whether or not there is a near home input, whether deceleration is taking place, or whether deceleration has been completed. Also, the home return can be performed without the near home input.

• Without near home input

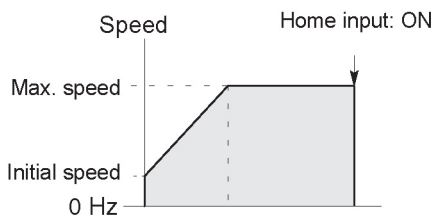

• With near home input

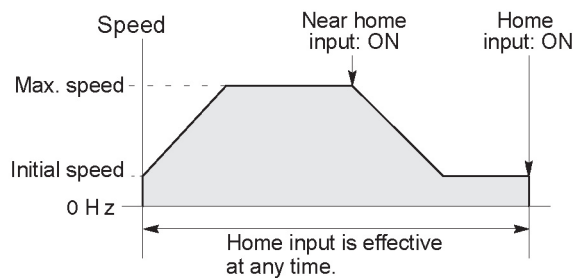

• Home input ON during deceleration

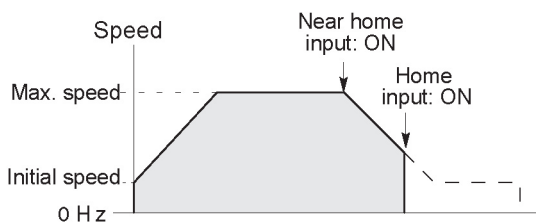

Type 1

In this mode, the home input is effective only after deceleration (started by near home input) has been completed. If the leading edge of home input (off to on) is detected during the operation at a creep speed after the deceleration operation, the pulse output stops.

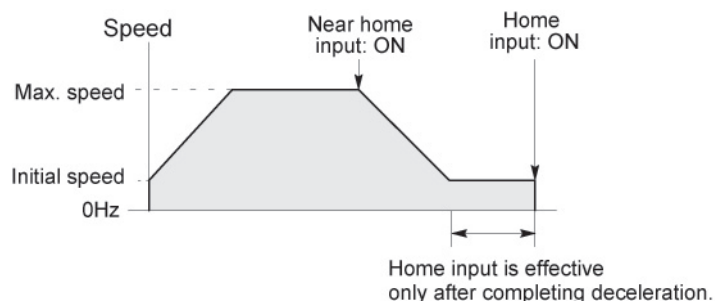

Sample program: Home return

The explanation below shows the case that home return is performed with the following conditions; Initial speed: 1 kHz, Target speed: 5 kHz, Creep speed: 500 Hz, Acceleration time: 300 ms, Deceleration time: 500 ms.

Timing chart

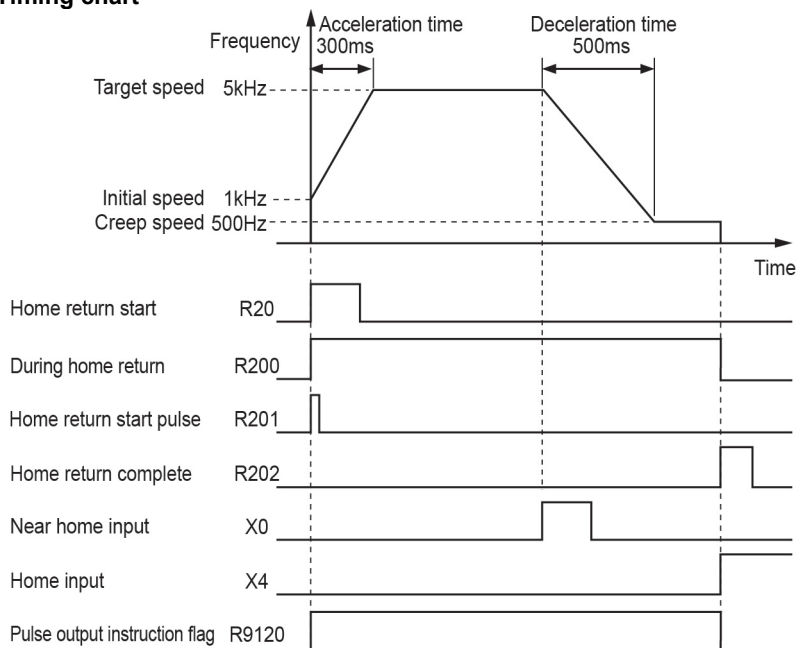

Data table

Data register No.	Setting item (Unit)	Example of sample program	Settable range
DT200	Control code	Home return type 1 Operating direction: Reverse CW/CCW H1001 0010	Set according to the control code on the next page.
DT202	Initial speed (Hz)	K1000	K1 to K50000
DT204	Target speed (Hz)	K5000	K1 to K50000
DT206	Acceleration time (ms)	K300	K1 to K32760
DT208	Deceleration time (ms)	K500	K1 to K32760
DT210	Creep speed (Hz)	K500	K1 to K50000
DT212	Deviation counter clear signal output time	K0 (Not output)	K0: Not output deviation counter clear signal K1 to K200 x 0.5ms (0.5ms to 100ms)

Note)

- Each setting item occupies 2-word data registers.
- The time from the initial speed to the target speed is specified as acceleration time. The time from the target speed to the creep speed is specified as deceleration time. For the details, refer to "8.4.17 Difference in Acceleration/Deceleration Characteristics Between Instructions".

Sample program

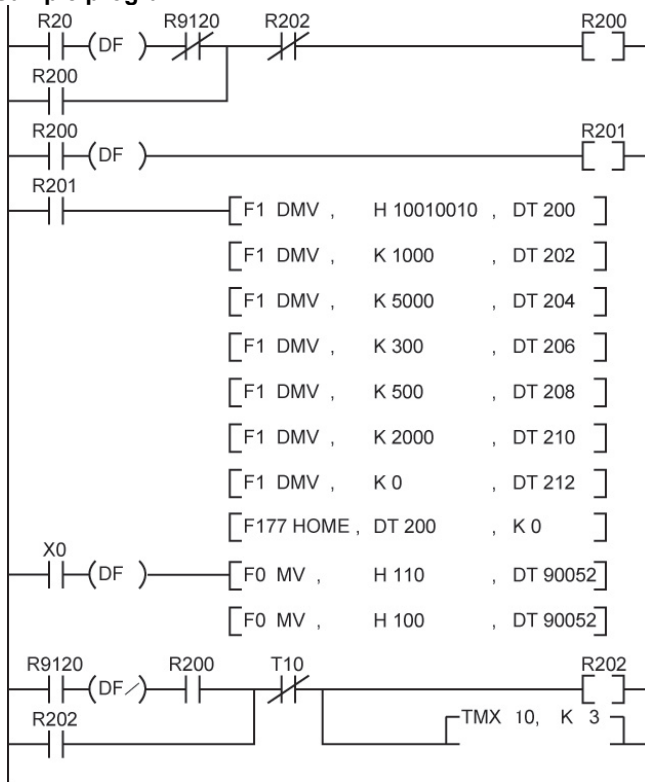

Control code

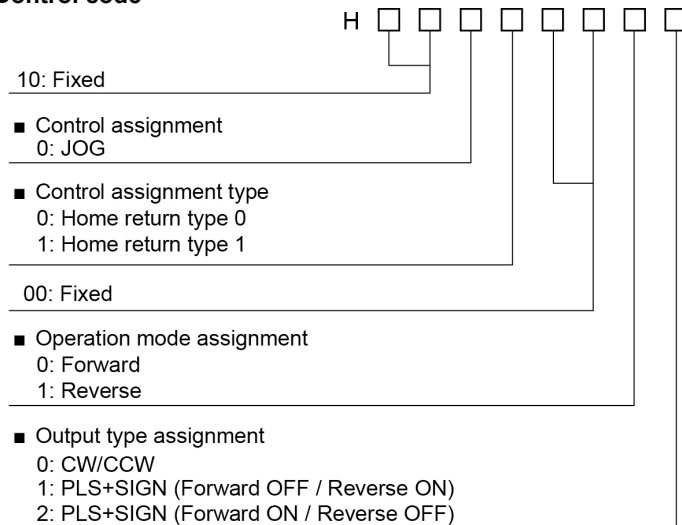

Precautions during programming

- For using the pulse output function, it is necessary to set the system register No. 402.
- When the deceleration stop is requested by the F0 instruction during the pulse output, the deceleration stop is performed.
- Even when the home input is on, the pulse output starts by the execution of this instruction.
- When the near home input turns on during acceleration, the deceleration operation starts.

8.4.9 Trapezoidal Control Instruction (F171)

- This instruction automatically performs trapezoidal control according to the specified data table while the trigger (execution condition) is on.

Control method of Trapezoidal control instruction (F171): Type 0 and Type 1

There are two kinds of operation modes, which are type 0 and type 1.

Type 0

- For type 0, the time from the initial speed to the target speed is specified as acceleration time or deceleration time.

- The time specified in a program is set as the acceleration time to be processed in the PLC as is. The same is true for the deceleration time.

- After the execution of the instruction, the speed up to the target speed can be changed.

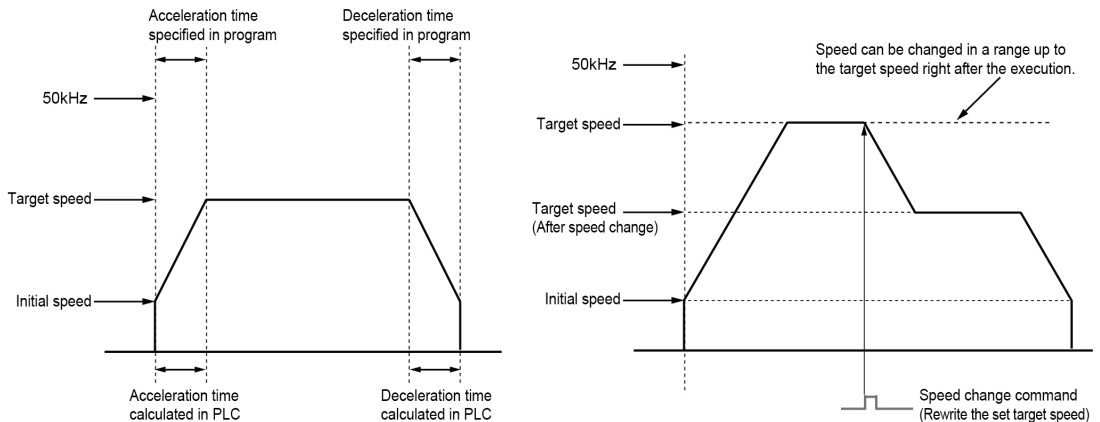

Type 1

- For type 1, the time from the initial speed to the maximum speed (50 kHz) is specified as acceleration time or deceleration time.

- When the target speed is below 50 kHz, the acceleration time processed in the PLC is relatively shorter than the time specified in a program. The same is true for the deceleration time.

- Use the type 1 to change the speed to a speed faster than the target speed after the execution of the instruction.

- After the execution, the speed up to the maximum speed, 50 kHz can be changed.

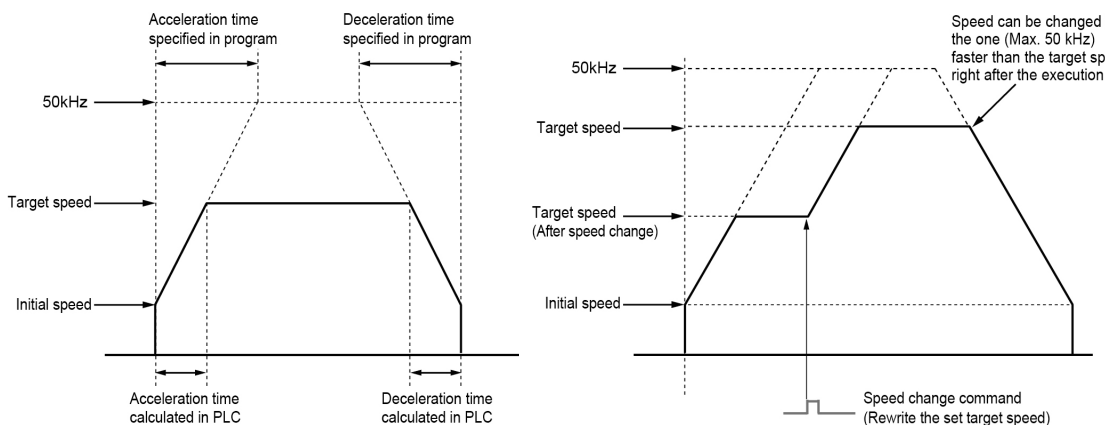

Note:

For the details of the difference in acceleration/deceleration characteristics, refer to "8.4.17 Difference in Acceleration/Deceleration Characteristics Between Instructions".

Sample program: Trapezoidal control Type 0 (F171)

The explanation below shows the case that pulses are output from Y0 with the following conditions; Initial speed: 1 kHz, Target speed: 10 kHz, Acceleration time: 100 ms, Deceleration time: 1000 ms, Movement amount: 30000 pulses.

Timing chart

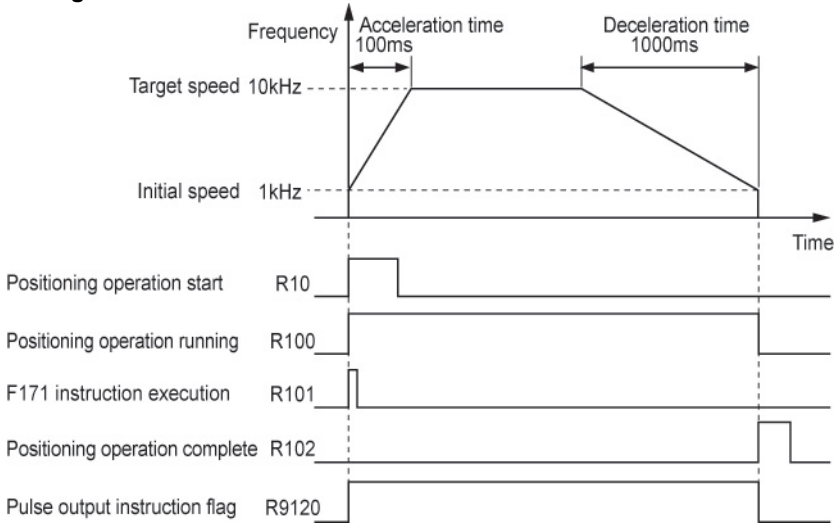

Data table

Data register No.	Setting item (Unit)	Example of sample program	Settable range
DT100	Control code	Type 0 Incremental CW/CCW H1000 0000	Set according to the control code on the next page.
DT102	Initial speed (Hz)	K1000	K1 to K50000
DT104	Target speed (Hz)	K10000	K1 to K50000
DT106	Acceleration time (ms)	K100	K1 to K32760
DT108	Deceleration time (ms)	K1000	K1 to K32760
DT110	Target value (pulses)	K30000	K-2,147,483,648 to K+2,147,483,647

Note)

1. Each setting item occupies 2-word data registers.
2. For type 0, the time from the initial speed to the target speed is specified as acceleration time or deceleration time.

For the details, refer to "8.4.17 Difference in Acceleration/Deceleration Characteristics Between Instructions".

Sample program

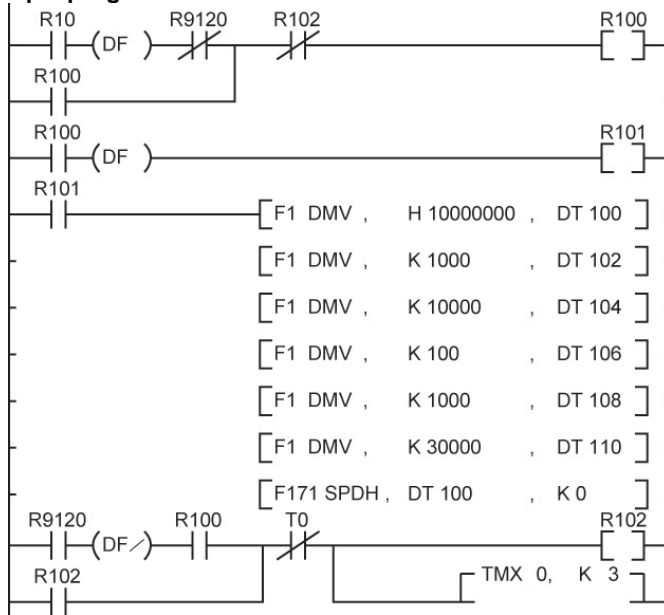

Control code

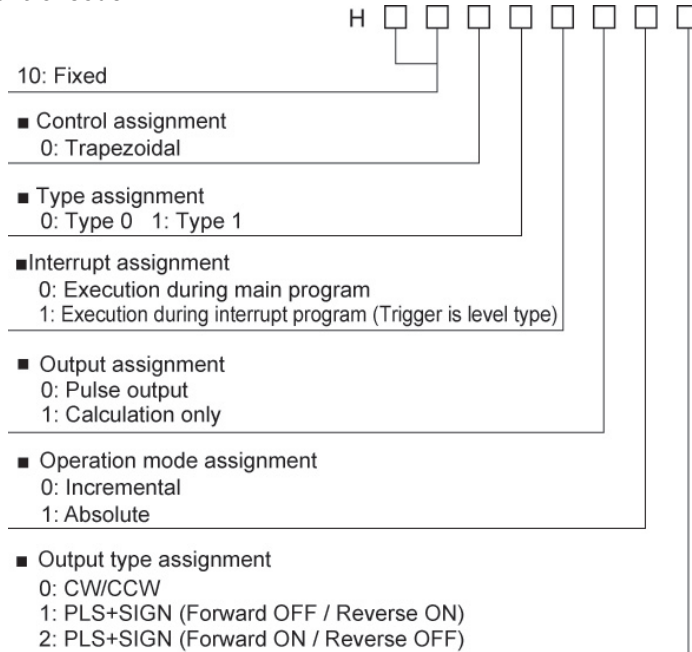

Precautions during programming

- For using the pulse output function, it is necessary to set the system register No. 402.
- Performing rewriting during RUN stops the pulse output.
- When the deceleration stop is requested by the F0 instruction during the pulse output, the deceleration stop is performed.
- When the instruction is started during the interrupt program, specify the execution in the interrupt program with the control code. When describing the same channel in both the normal program and the interrupt program, be sure to program not to execute them simultaneously.

8.4.11 Speed Change After Starting Trapezoidal Control Type 1 (F171)

- The explanation below shows the program to change the speed to a speed over the target speed during the trapezoidal control.
- Use the type 1 to change the speed to a speed faster than the target speed.

Time chart

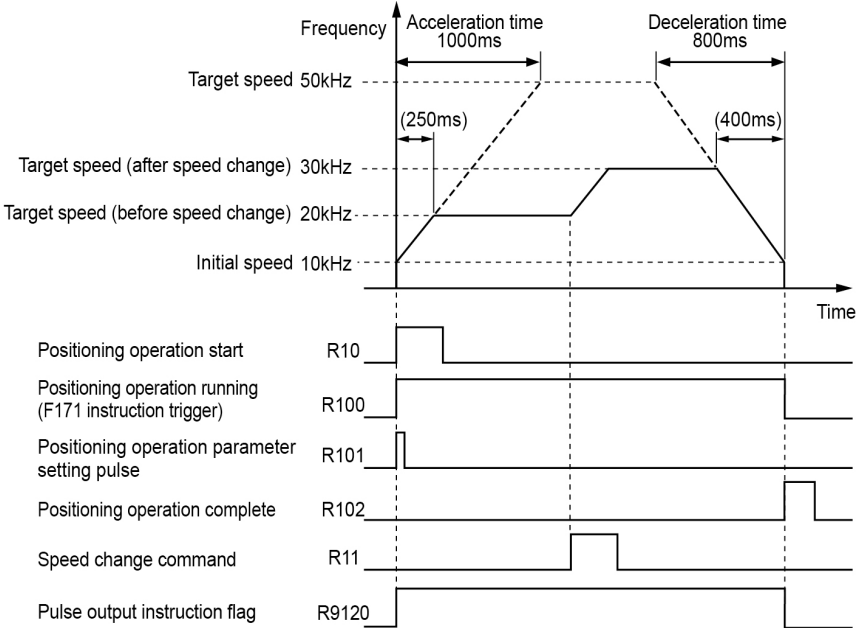

Sample program

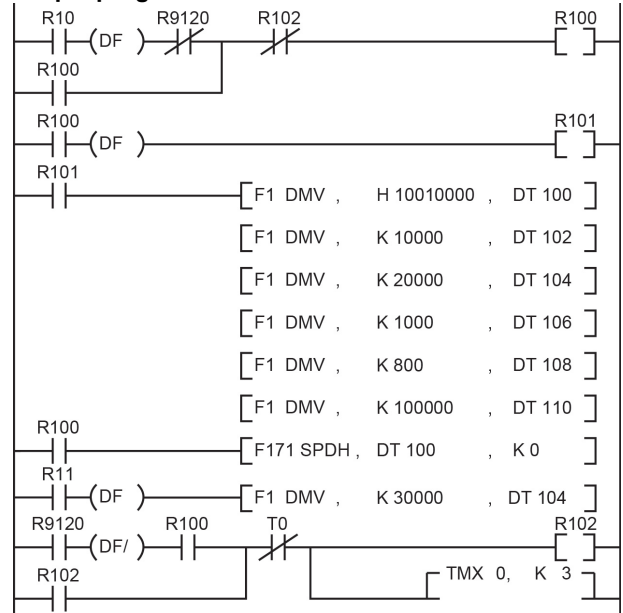

Precautions during programming

- To change the speed, specify the execution condition of F171 instruction to be always executed.
- Using the type 1 enables to perform the acceleration/deceleration control up to the maximum speed (50 kHz).
- Speed cannot be changed when the instruction is executed in the interrupt program.

8.4.12 Precautions When Changing Speed (Common to F171 and F172)

Precautions during programming

- To change the speed, specify the execution condition of instruction to be always executed.
- Using the type 0 of trapezoidal control instruction (F171) enables to perform the acceleration/deceleration control up to the target value. Using the type 1 of trapezoidal control instruction (F171) enables to perform the acceleration/deceleration control up to the maximum speed (50 kHz).
- The speed cannot be changed during the deceleration requested by the deceleration stop and during the deceleration to stop at the target position.
- Acceleration cannot be performed from that position when the elapsed value goes beyond the acceleration forbidden area starting position. The acceleration forbidden area starting position can be monitored by the special data registers shown in the table below.
- The speed cannot be changed to a value below the deceleration minimum speed. If a value below the deceleration minimum speed is specified, the speed will be corrected. The deceleration minimum speed can be monitored by the special data registers shown in the table below.

Pulse output control area

Channel No.	Deceleration minimum speed area	Acceleration forbidden area starting position area
CH0	DT90407	DT90408 to DT90409
CH1	DT90417	DT90418 to DT90419
CH2	DT90427	DT90428 to DT90429
CH3	DT90437	DT90438 to DT90439

8.4.13 JOG Positioning Control Instruction (F171)

- When the trigger (execution condition) turns on, the JOG operation is started. When the position control start input becomes effective, a specified pulse is output and the deceleration stop is performed.
- The position control start input becomes effective when the leading edge of the external inputs X0 to X3 or the bit 6 of the special data register DT90052 is detected. To use the external inputs X0 to X3, specify them by the system register No. 402 for each channel.

Control method of JOG positioning control instruction (F171): Type 0 and Type 1

Type 0

- Once the trigger (execution condition) turns on, the JOG operation is started, and acceleration is performed up to the target speed.
- When the position control start input becomes effective, pulses are output up to a specified target value.
- The speed can be changed by rewriting the target speed during the operation after executing the instruction.

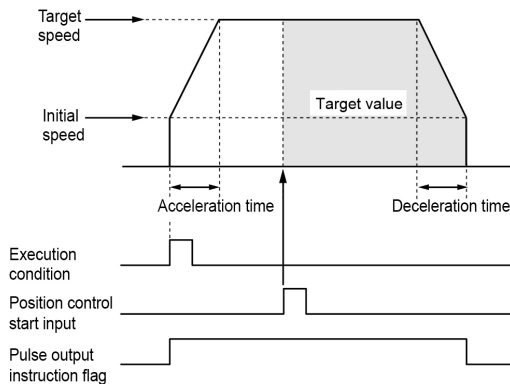

Type 1

- Once the trigger (execution condition) turns on, the JOG operation is started, and acceleration is performed up to the target speed 1.
- When the position control start input becomes effective, the speed is changed to the target speed 2 at a specified changeover time and pulses are output up to a specified target value.
- The speed cannot be changed after executing the instruction.

When Target speed 1 > Target speed 2

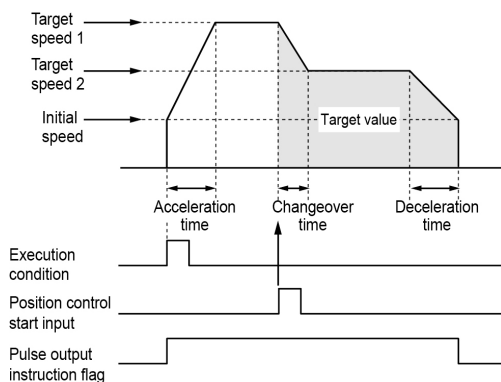

When Target speed 1 < Target speed 2

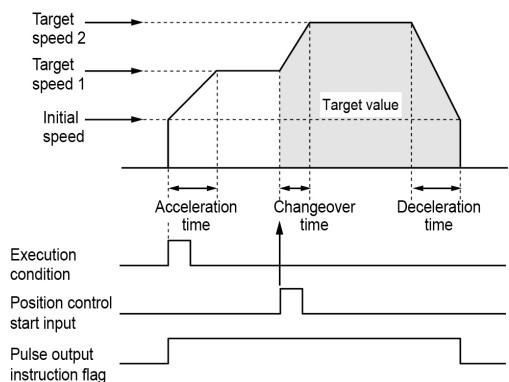



Note:

- When the position control start input does not turn on, the pulse output will not stop. Create a program to stop the operation when an error occurs, with a combination of the forced stop by the F0 instruction (bit 3 of DT90052) and the deceleration stop by the F0 instruction (bit 5 of DT90052). As for the position control start input, only the leading edge is detected.
- When the pulse number from turning on the position control start input until stopping is small relative to a specified deceleration time, the operation stops before decelerating to the initial speed. When it is large relative to a specified deceleration time, deceleration starts after holding the target speed.
- Performing rewriting during RUN stops the pulse output.
- When the deceleration stop is requested by the F0 instruction during the pulse output, the deceleration stop is performed.
- When the position control start input turns on in the acceleration area, the deceleration stop is performed.

Sample program: JOG positioning operation: Type 0

- When the trigger (execution condition) is on, the JOG operation is started. When the position control start input turns on, a specified pulse is output and the deceleration stop is performed.

Time chart

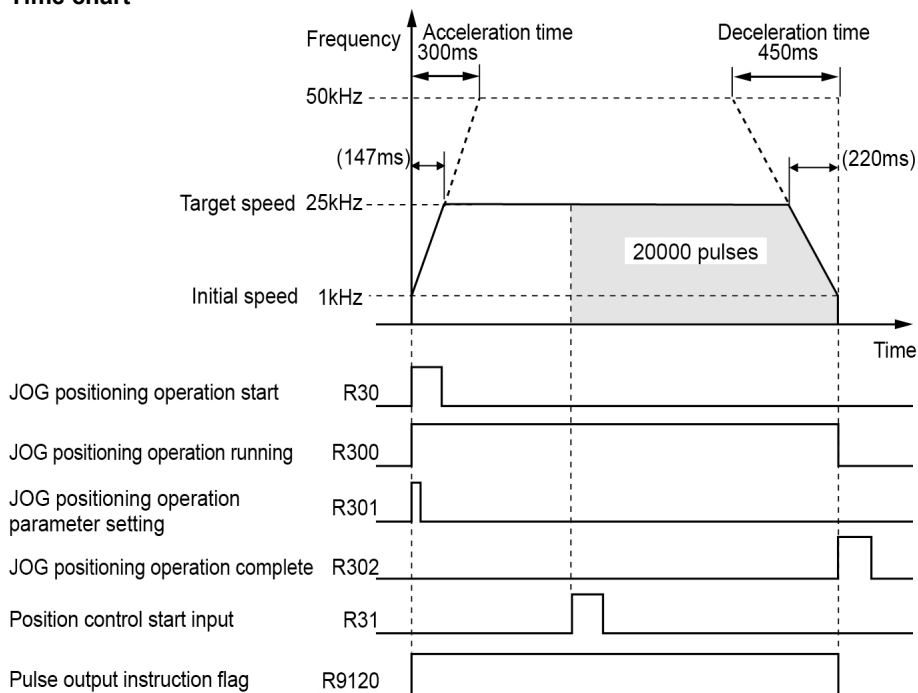

Data table

Data register No.	Setting item (Unit)	Example of sample program	Settable range
DT300	Control code	JOG positioning Type 0 CW/CCW H1010 0000	Set according to the control code on the next page.
DT302	Initial speed (Hz)	K1000	K1 to K50000
DT304	Target speed (Hz)	K25000	K1 to K50000
DT306	Acceleration time (ms)	K300	K1 to K32760
DT308	Deceleration time (ms)	K450	K1 to K32760
DT310	Target value (pulses)	K20000	K-2,147,483,648 to K+2,147,483,647

Note)

1. Each setting item occupies 2-word data registers.
2. For the type 0 of JOG positioning control instruction (F171), the time from the initial speed to the maximum speed (50 kHz) is specified as acceleration time or deceleration time. For the details, refer to "8.4.17 Difference in Acceleration/Deceleration Characteristics Between Instructions".
3. When the target value is set to zero, the operation stops once the position control start input turns on.

Sample program

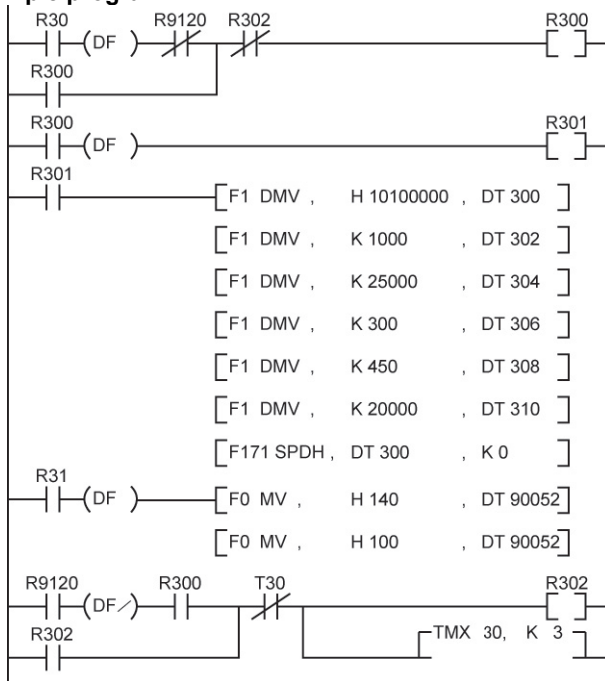

Control code



10: Fixed

■ Control assignment
1: JOG positioning

■ Control assignment 2
0: Type 0

■ Interrupt assignment
0: Execution during main program
1: Execution during interrupt program (Trigger is level type)

■ Output assignment
0: Pulse output
1: Calculation only

■ Operation mode assignment
0: Incremental

■ Output type assignment
0: CW/CCW
1: PLS+SIGN (Forward OFF / Reverse ON)
2: PLS+SIGN (Forward ON / Reverse OFF)

- Only when the target value is set to "0", the pulse output direction can be reversed by changing the output type assignment from "0,1,2" to "4,5,6".

Precautions during programming

- For using the pulse output function, it is necessary to set the system register No. 402.
- When the instruction is started during the interrupt program, specify the execution in the interrupt program with the control code. When describing the same channel in both the normal program and the interrupt program, be sure to program not to execute them simultaneously.

Sample program: JOG positioning operation: Type 1

- When the trigger (execution condition) is on, the JOG operation is started. When the position control start input turns on, the position control is performed up to a specified target value after changing the target speed at the changeover time specified in advance.

Time chart

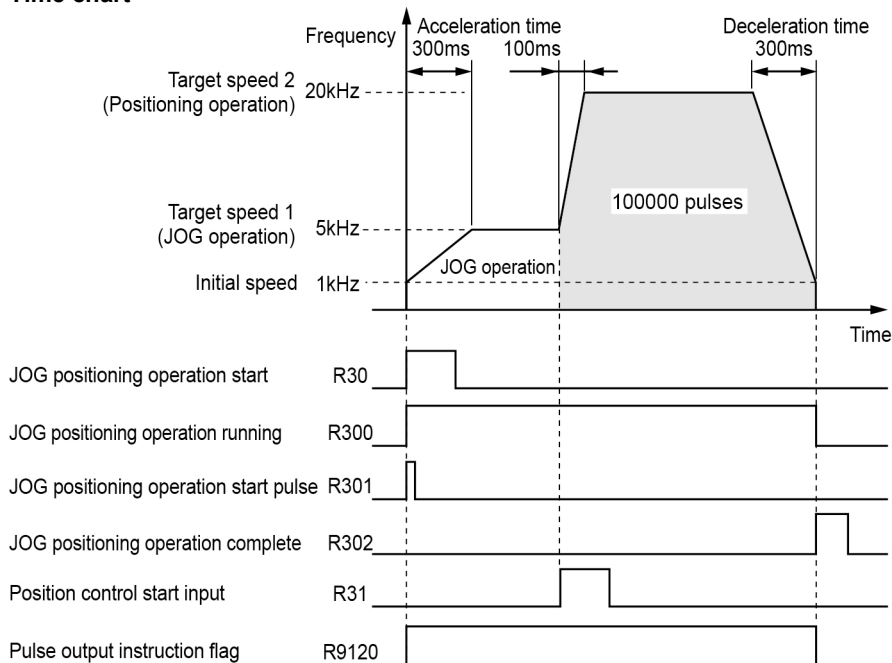

Data table

Data register No.	Setting item (Unit)	Example of sample program	Settable range
DT300	Control code	H1011 0000 JOG positioning Type 1 CW/CCW	Set according to the control code on the next page.
DT302	Initial speed (Hz)	K1000	K1 to K50000
DT304	Target speed 1 (Hz)	K5000	K1 to K50000
DT306	Acceleration time (ms)	K300	K1 to K32760
DT308	Target speed 2 (Hz)	K20000	K1 to K50000
DT310	Changeover time (ms)	K100	K1 to K32760
DT312	Deceleration time (ms)	K300	K1 to K32760
DT314	Target value (pulses)	K100000	K-2,147,483,648 to K+2,147,483,647

Note)

1. Each setting item occupies 2-word data registers.
2. For the type 1 of JOG positioning control instruction, the time from the initial speed to the target speed 1 is specified as acceleration time, the time from the target speed 1 to the target speed 2 is as changeover time, and the time from the target speed 2 to the initial speed is as deceleration time. For the details, refer to "8.4.17 Difference in Acceleration/Deceleration Characteristics Between Instructions".

Sample program

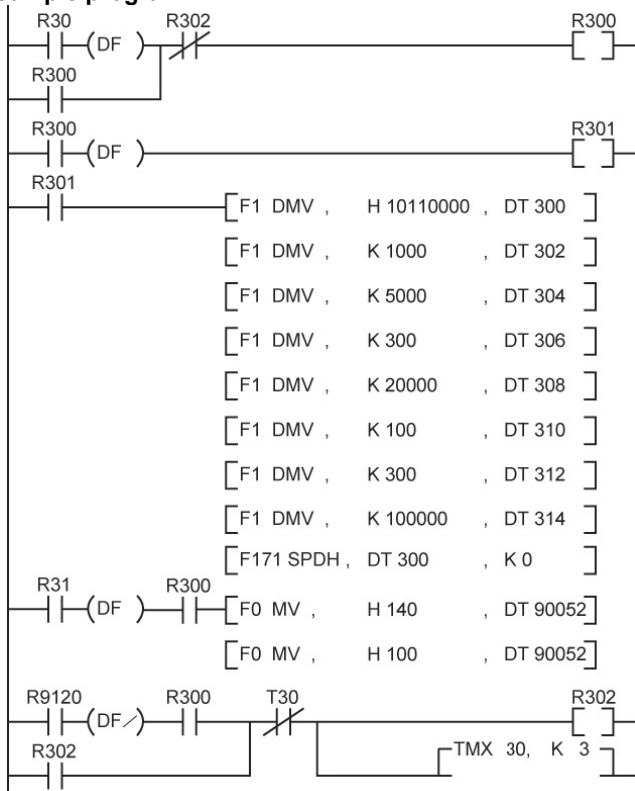

Control code

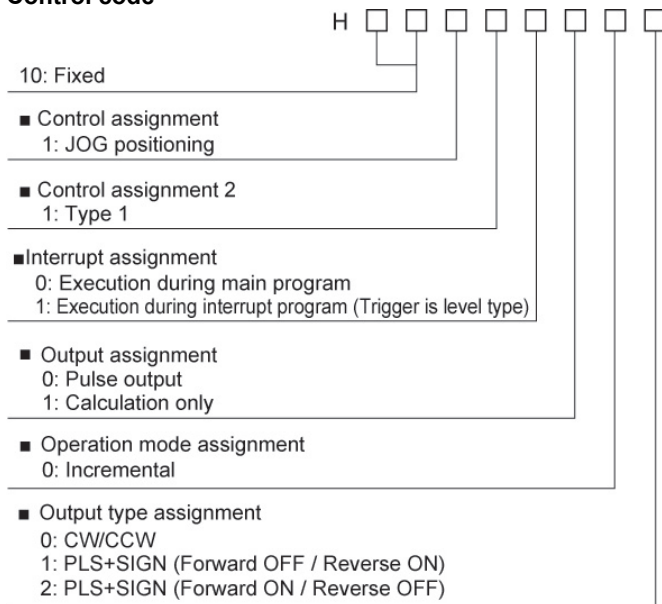

Precautions during programming

- For using the pulse output function, it is necessary to set the system register No. 402.
- When the instruction is started during the interrupt program, specify the execution in the interrupt program with the control code. When describing the same channel in both the normal program and the interrupt program, be sure to program not to execute them simultaneously.

8.4.14 JOG Positioning Control Type 0 - Change Speed (F171)

- Use the type 1 to change the speed to a speed faster than the target speed.

Time chart

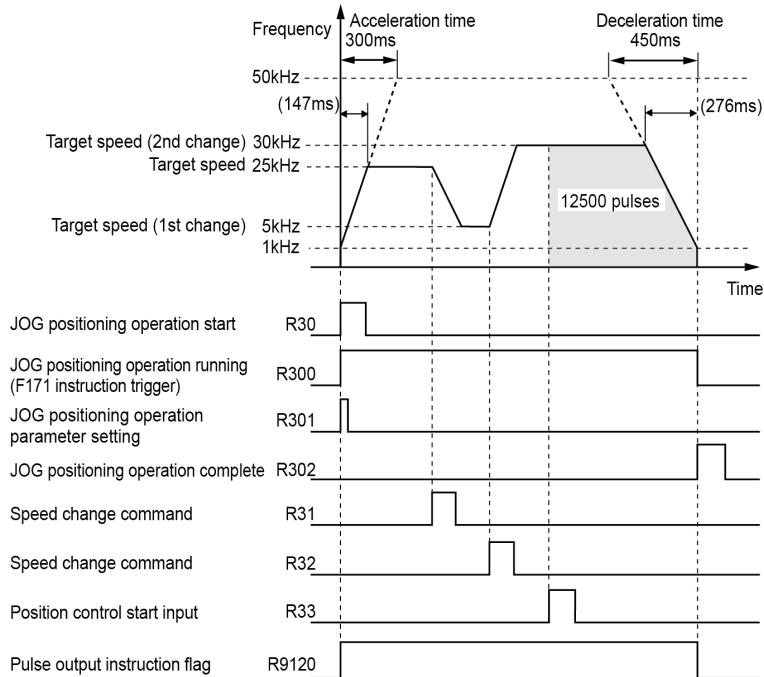

Sample program

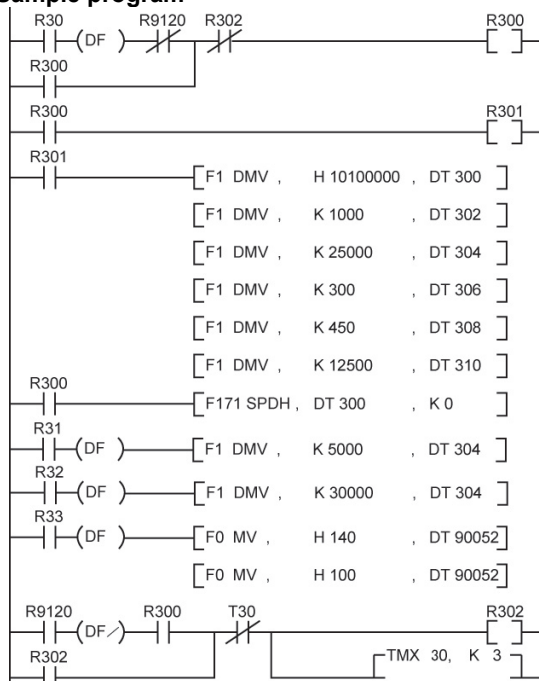

Precautions during programming

- To change the speed, specify the execution condition of F171 instruction to be always executed.
- Using the type 1 enables to perform the acceleration/deceleration control up to the maximum speed (50 kHz).

8.4.15 Data Table Control Instruction (F174)

- Pulses are output from the specified channel according to the specified data table.
- Positioning is performed sequentially according to the values of data tables, and stops at the data table that the value of pulse output stop (K0) is written.

Time chart

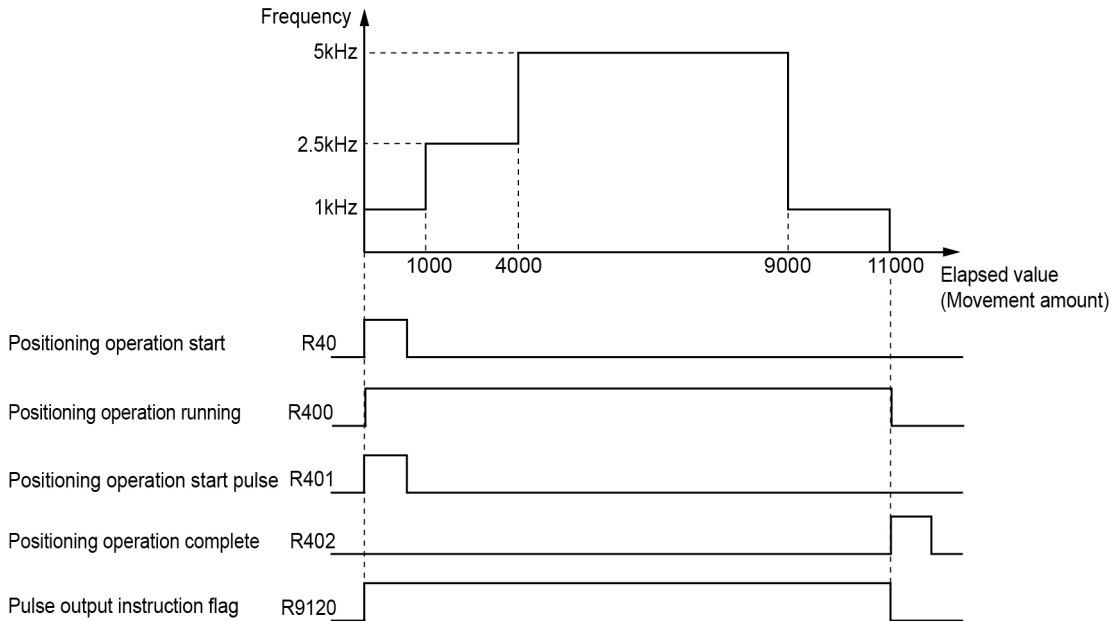

Data table

Data register No.	Setting item (Unit)	Example of sample program	Settable range
DT400	Control code	H1000 0010 Absolute CW/CCW	Set according to the control code on the next page.
DT402	Frequency 1 (Hz)	K1000	Set frequencies in the following range. K1 to K50000
DT404	Target value 1 (pulses)	K1000	
DT406	Frequency 2 (Hz)	K2500	
DT408	Target value 2 (pulses)	K4000	
DT410	Frequency 3 (Hz)	K5000	Set target values in the following range. K-2,147,483,648 to K+2,147,483,647
DT412	Target value 3 (pulses)	K9000	
DT414	Frequency 4 (Hz)	K1000	
DT416	Target value 4 (pulses)	K11000	
DT418	End of table	K0	K0 fixed

Note)

Each setting item occupies 2-word data registers.

Sample program

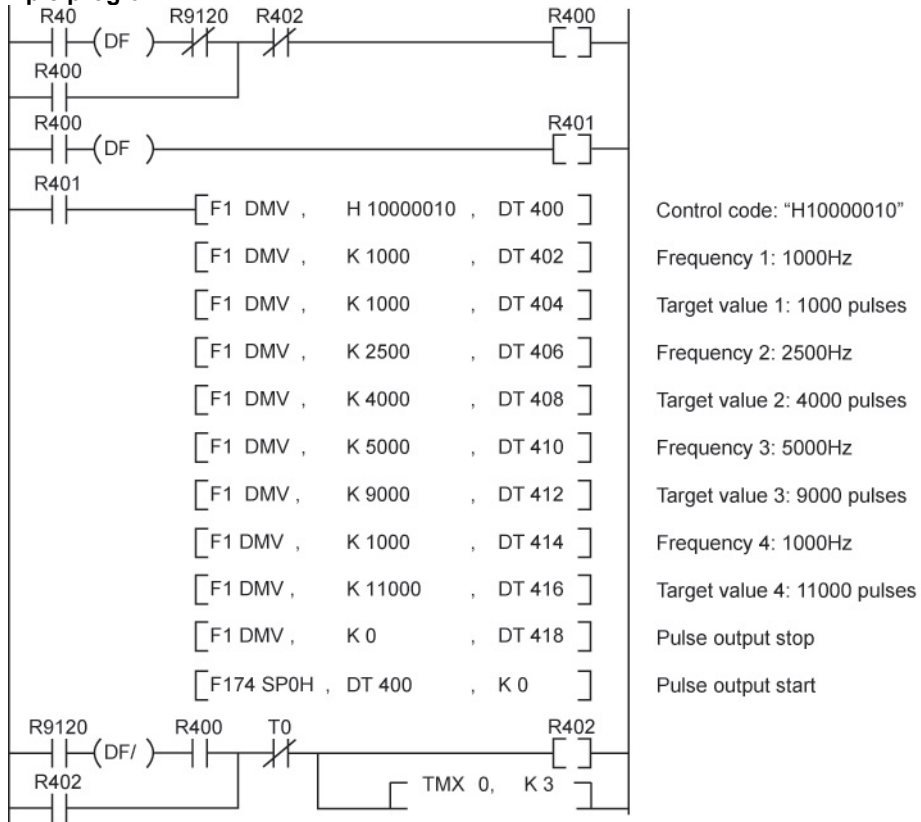

Control code

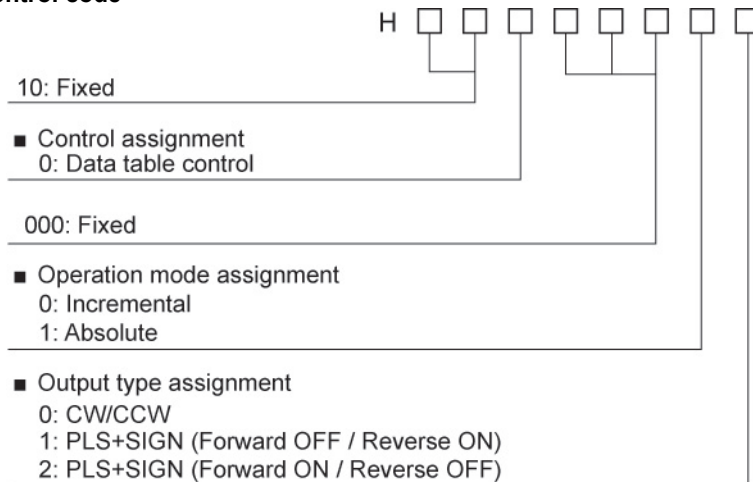

Precautions during programming

- When the deceleration stop is requested by the F0 instruction during the pulse output, an operation similar to the forced stop is performed and the pulse output stops immediately.

8.4.16 Linear Interpolation Control Instruction (F175)

- The linear interpolation controls positioning with two axes according to the specified data table.
- Specify the number (K0 or K2) corresponding to the channel (CH0 or CH2) assigned to the X axis to execute the F175 instruction.

Time chart

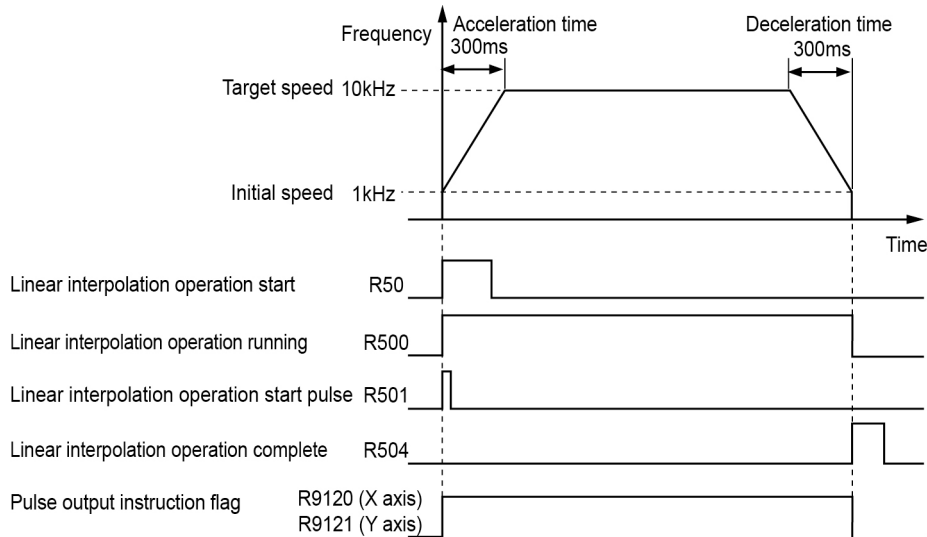

Data table

Data register No.	Setting item (Unit)	Example of sample program	Settable range
DT500	Control code	H1000 0000 Increment CW/CCW	Set according to the control code on the next page.
DT502	Composite speed (Initial speed) (Hz)	K500	K6 to K50000
DT504	Composite speed (Target speed) (Hz)	K5000	K6 to K50000
DT506	Acceleration time (ms)	K300	K1 to K32760
DT508	Deceleration time (ms)	K300	K1 to K32760
DT510	X-axis target value (pulses)	K5000	K-8,388,608 to K+8,388,607
DT512	Y-axis target value (pulses)	K2000	K-8,388,608 to K+8,388,607
DT514	X-axis component speed (Initial speed) (Hz)	The result is stored as 2 words in real type. $\text{X-axis component speed} = \frac{\text{(composite speed)} \times \text{(X-axis movement amount)}}{\sqrt{(\text{X-axis movement amount})^2 + (\text{Y-axis movement amount})^2}}$ $\text{Y-axis component speed} = \frac{\text{(composite speed)} \times \text{(Y-axis movement amount)}}{\sqrt{(\text{X-axis movement amount})^2 + (\text{Y-axis movement amount})^2}}$	
DT516	X-axis component speed (Target speed) (Hz)		
DT518	Y-axis component speed (Initial speed) (Hz)		
DT520	Y-axis component speed (Target speed) (Hz)		

Note) Each setting item occupies 2-word data registers.

Sample program

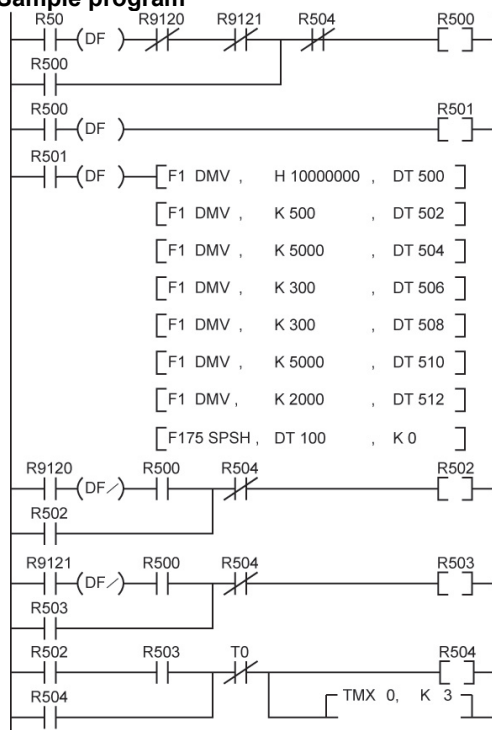

Control code

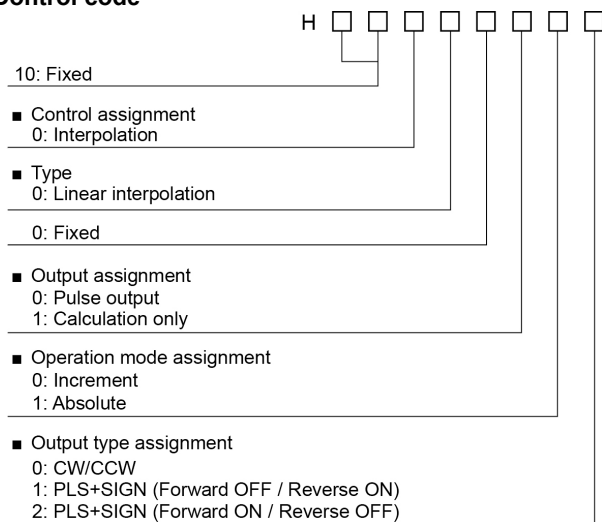

Precautions during programming

- For using the pulse output function, it is necessary to set the system register No. 402.
- Specify the composite speed to make the component speed of each axis be 6 Hz or more.
- Set the composite speed (Initial speed) to be 30 Hz or less.
- For the linear interpolation instruction (F175), specify the same value for the acceleration time and deceleration time.
- To perform the operation only to the negative direction in the incremental mode, set the target value to zero.
- To perform the operation only to the negative direction in the absolute mode, set the target value to the same as the current value.
- When the deceleration stop is requested by the F0 instruction during the pulse output, the deceleration stop is performed.

8.4.17 Difference in Acceleration/Deceleration Characteristics Between Instructions

- The method to calculate the acceleration/deceleration time and the speed table for acceleration/deceleration differs according to the type of pulse output instructions.
- Select an appropriate type of instruction according to applications.

Acceleration/deceleration characteristics of each instruction

Common to JOG operation Type 0 and Type 1 (F172)

- Specify the time from the initial speed to the maximum speed (50 kHz) as acceleration time and the time from the maximum speed (50 kHz) to the initial speed as deceleration time in the program. The actual acceleration/deceleration time is relatively shorter than the specified acceleration/deceleration time.
- Each section between the initial speed and the maximum speed (50 kHz), and between the maximum speed (50 kHz) and the initial speed is divided into the speed table of 30 steps to calculate the speed. Therefore, the acceleration/deceleration is not as smooth compared to other control patterns especially when the target speed is low.

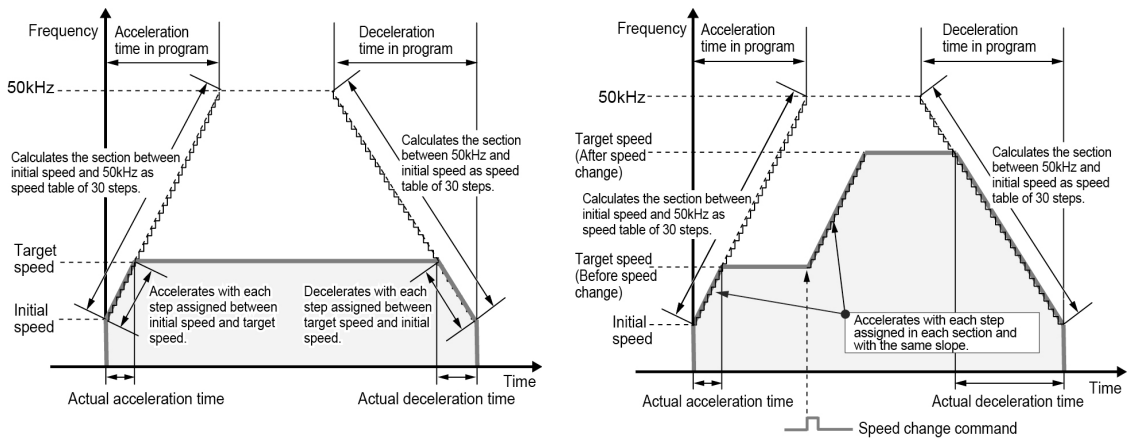

Common to Home return operation Type 0 and Type 1 (F177)

- Specify the time from the initial speed to the target speed as acceleration time and the time from the target speed to the creep speed as deceleration time in the program.
- Each section between the initial speed and the target speed, and between the target speed and the creep speed is divided into the speed table of 30 steps to calculate the speed. Therefore, the acceleration/deceleration is smoother compared to other control patterns.

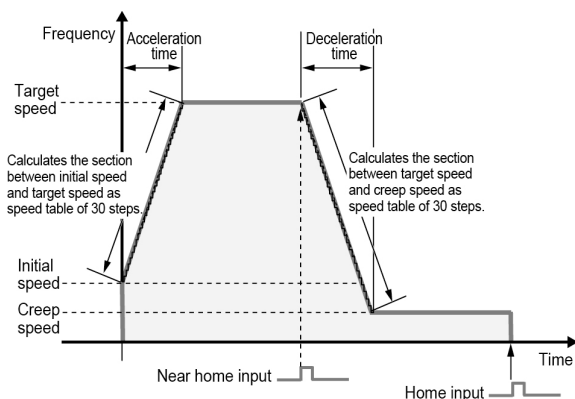

Trapezoidal control Type 0 (F171)

- Specify the time from the initial speed to the target speed as acceleration time and the time from the target speed to the initial speed as deceleration time in the program.
- Each section between the initial speed and the target speed, and between the target speed and the initial speed is divided into the speed table of 30 steps to calculate the speed. Therefore, the acceleration/deceleration is smoother compared to the trapezoidal control type 1.
- After the execution of the instruction, the speed can be changed within the range of the target speed. To change the target speed to the one faster than the target speed right after the execution, select the type 1..

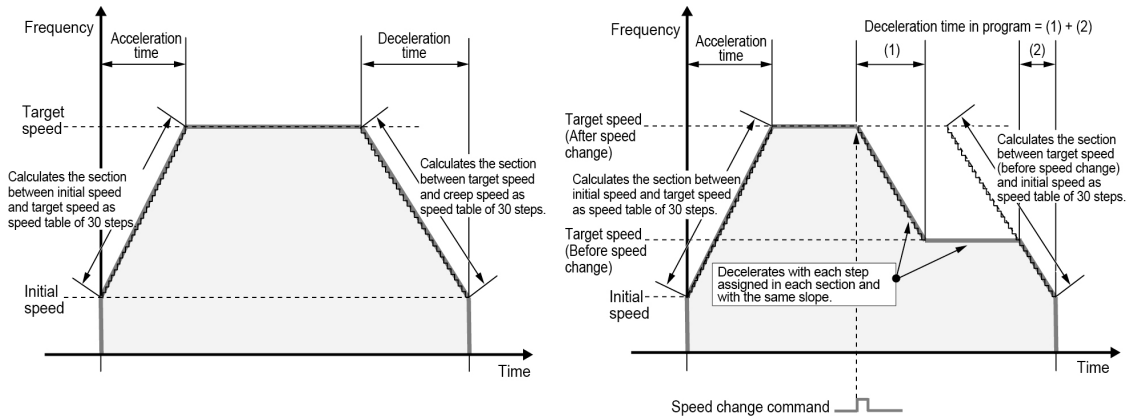

Trapezoidal control Type 1 (F171)

- Specify the time from the initial speed to the maximum speed (50 kHz) as acceleration time and the time from the maximum speed (50 kHz) to the initial speed as deceleration time in the program. The actual acceleration/deceleration time is relatively shorter than the specified acceleration/deceleration time.
- Each section between the initial speed and the maximum speed (50 kHz), and between the maximum speed (50 kHz) and the initial speed is divided into the speed table of 30 steps to calculate the speed. Therefore, the acceleration/deceleration is not as smooth compared to other control patterns especially when the target speed is low. To use in a low-speed area with a device such as a stepping motor, select the trapezoidal control Type 0.
- After the execution of the instruction, the speed can be changed within the range of the maximum speed (50 kHz).

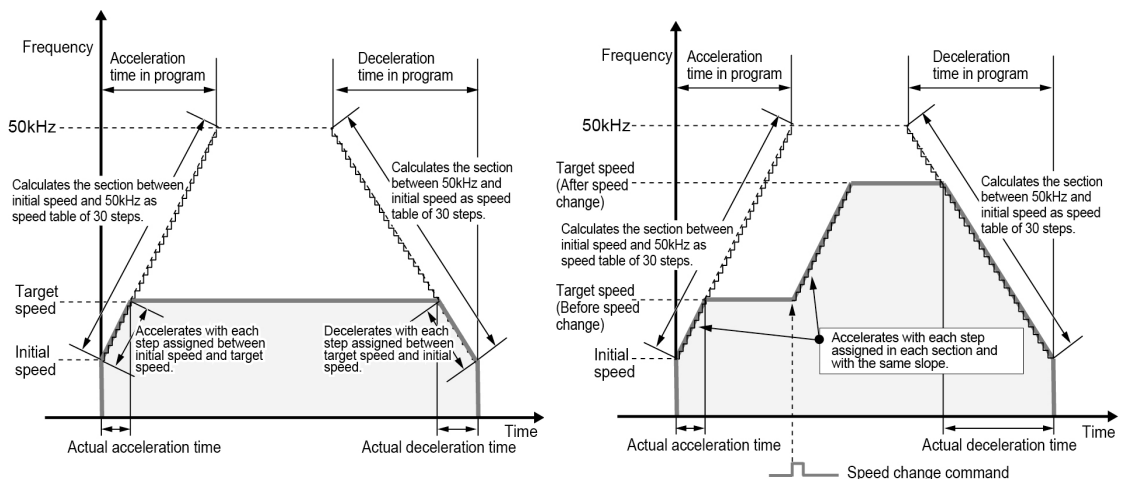

JOG positioning control Type 0 (F171)

- Specify the time from the initial speed to the maximum speed (50 kHz) as acceleration time and the time from the maximum speed (50 kHz) to the initial speed as deceleration time in the program. The actual acceleration/deceleration time is relatively shorter than the specified acceleration/deceleration time.
- Each section between the initial speed and the maximum speed (50 kHz), and between the maximum speed (50 kHz) and the initial speed is divided into the speed table of 30 steps to calculate the speed. Therefore, the acceleration/deceleration is not as smooth compared to the JOG positioning control Type 1 especially when the target speed is low. To use in a low-speed area with a device such as a stepping motor, select the type 1.
- After the execution of the instruction, the speed can be changed within the range of the maximum speed (50 kHz).

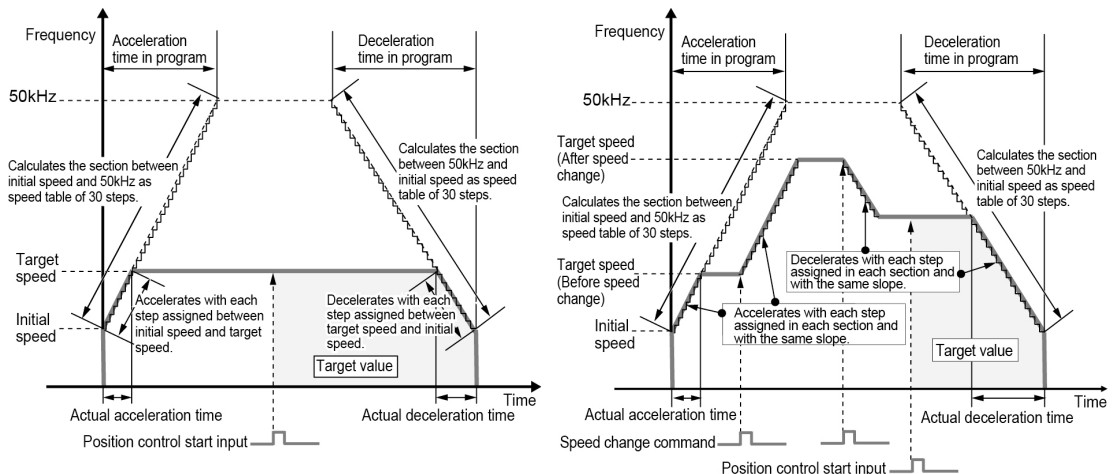

JOG positioning control Type 1 (F171)

- Specify the time from the initial speed to the target speed 1 as acceleration time, the time from the target speed 1 to the target speed 2 as the changeover time and the time from the target speed 2 to the initial speed as deceleration time in the program.
- Each section between the initial speed and the target speed 1, between the target speed 1 and the target speed 2, and between the target speed 2 and the initial speed is divided into the speed table of 30 steps to calculate the speed. Therefore, the acceleration/deceleration is smoother compared to the JOG positioning control Type 0.
- The speed cannot be changed after the execution of the instruction.

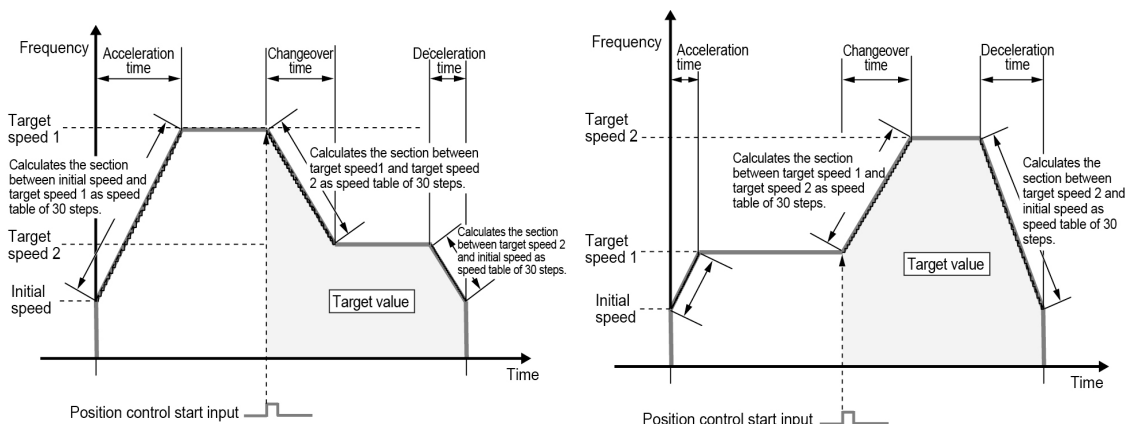

8.4.18 Pulse Output Instruction Flag

- Note that there are the following restrictions on using each function of the pulse output

Allocation and role of pulse output instruction flag

- When a pulse output instruction (F171/F172/F174/F175/F177) or PWM output instruction (F173) is executed and pulses are being output, the pulse output instruction flag of the corresponding channel is ON. No other pulse output instruction can be executed as long as this flag is ON.
- The pulse output instruction flags are allocated to each channel.

Channel	Pulse output instruction flag
CH0	R9120
CH1	R9121
CH2	R9122
CH3	R9123

Operation of pulse output instruction flag

- The pulse output instruction flags vary even during scanning. Replace them with internal relays at the beginning of the program when using them several times in the program.

8.4.19 Common Precautions for Pulse Output Instructions

- Note that there are the following restrictions on using each function of the pulse output

Precautions when using instructions in PULSE+SIGN mode (Common to F171, F172, F175, F177)

- When each instruction is executed, pulses are output approx. 300 μ s after the direction signal has been output; the motor drive characteristics are simultaneously taken into consideration.

Stop by pulse output control instruction (F0) (Common to F171, F172, F174, F175, F177)

- When executing the deceleration stop with the pulse output control instruction (F0), the operations being executed with various instructions are cancelled and the deceleration operation starts. When the deceleration stop request flag (bit 5 of DT90052) is on, instructions cannot be executed. As for the data table control instruction (F174), the operation is similar to that of the forced stop.
- When executing the forced stop (pulse output stop) with the pulse output control instruction (F0), the operations being executed with various instructions are cancelled and the pulse output is immediately stopped. When the forced stop request flag (bit 3 of DT90052) is one, instructions cannot be executed.

Specification of initial speed and speed error (Common to F171, F172, F174, F175, F177)

- Note that there are the following characteristics according to the initial speed specified with each instruction.
 - (1) When the initial speed is 1 Hz or higher, and lower than 46 Hz, the control can be performed up to 10 kHz.
 - (2) When the initial speed is 46 Hz or higher, and lower than 184 Hz, the control can be performed up to the maximum frequency.
 - (3) When the initial speed is 184 Hz or higher, the control can be performed up to the maximum frequency. The speed error will be smallest.

Control code and quick start (Common to F171, F172, F175)

- When "Calculation only" is specified in the digit to set the output of the control code of each instruction, the pulse output is not performed.
- Instructions can be quickly started when executing them for the same channel and with the same parameter after executing calculation only.

Duty cycle of pulse output (Common to F171, F172, F174, F175, F177)

- Pulses are output with a 25% duty cycle.

8.5 PWM Output Function

8.5.1 Overview

PWM output function

With the F173 (PWMH) instruction, the pulse width modulation output of the specified duty ratio is obtained.

System register setting

In order to use the PWM output function, it is necessary to set system register numbers no.402.

8.5.2 PWM Output Instruction F173

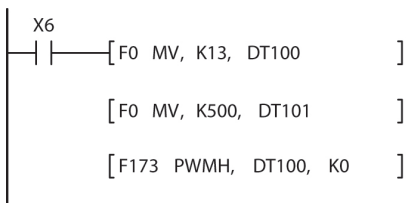

While X6 is on, a pulse with a period of 1 ms and duty ratio of 50% is output from Y0 of specified channel CH0.

When the program runs, the data table will be as shown below.

Data table

DT100	Control code *1	: K13
DT101	Duty *2	: 50%

*1: Specify the control code by setting the K constant.

K	Frequency (Hz)	Period (ms)
K3	6	166.67
K4	7.5	133.33
K5	12.5	80.00
K6	25	40.00
K7	50	20.00
K8	100	10.00
K9	200	5.00
K10	400	2.50
K11	600	1.67
K12	800	1.25
K13	1.0 k	1.00
K14	1.2 k	0.83
K15	1.6 k	0.63
K16	2.0 k	0.50
K17	3.0 k	0.33
K18	4.8 k	0.21

*2: Specify the duty by setting the K constant.

Duty: K0 to K999(1000 resolutions)



Note:

- If a value outside the specified range is written to the duty area while the instruction is being executed, a frequency corrected to the maximum value is output. If written when instruction execution is started, an operation error is occurred.

Chapter 9

Security Functions

9.1 Password Protect Function

9.1.1 Password Protect Function

This function is used to prohibit reading and writing programs and system registers by setting a password on the FP0R.

There are two ways to set a password as below.

1. Sets using the programming tool.
2. Sets using an instruction (SYS1 instruction).

Characters usable for password

Digit number of password	Usable characters
4-digit password	4 characters of the following 16 characters, 0 to 9 and A to F, can be used.
8-digit password	A maximum of 8 one-byte characters (case-sensitive) and symbols can be used.



Note: Precautions on the password setting

Do not forget your password. If you forget your password, you cannot read programs. (Even if you ask us for your password, we cannot crack it.)

9.1.2 Setting using Programming Tool

Setting using FPCWIN GR

1. Select [Online Edit Mode] under the [Online] on the menu bar, or press the [CTRL] and [F2] keys at the same time, to switch to the [Online] screen.
2. Select or “Set PLC Password” under “Tool” on the menu bar. The following display will be shown.

Security information dialog box

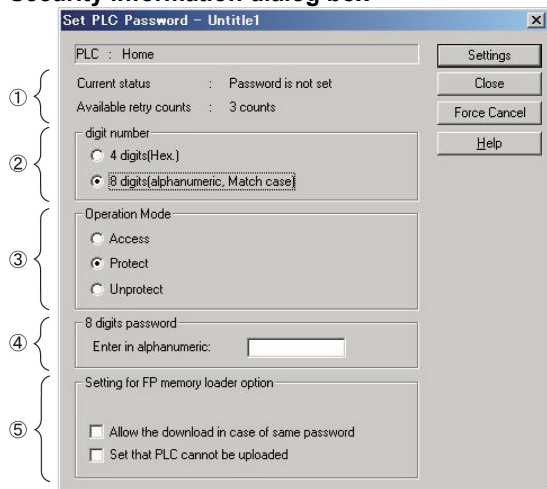

- ① Indicates the current status of the password setting.
- ② Specify the type of the password to be used.
- ③ Specify an operation mode.
Access: Accesses programs by inputting a password.
Protect: Sets a password.
Unprotect: Releases the password setting.
- ④ Input a password.
- ⑤ Those are the settings when using the FP memory loader (Ver. 2.0 or later).

Confirmation the contents of the password setting Confirm the settings indicated in the dialog box.

Current status

Indicates the current status of the password setting. There are following five statuses.

Item	Settings
Password is not set	Password is not set.
4 digits Protect	Four-digit password, and access is prohibited.
4 digits Available to access	Four-digit password, and access is allowed. (The status that inputting the password completes and that can access programs.)
8 digits Protect	Eight-digit password, and access is prohibited.
8 digits Available to access	Eight-digit password, and access is allowed. (The status that inputting the password completes and that can access programs.)

Available retry counts

This is the number of times that you can input the password in succession (up to 3 times). Every time incorrect password is input, the number will decrease.

If you fail to input the correct password for 3 times in succession, you cannot access the program.

Turn the power supply of the FP0R off and then on again to try to input the password again.



Note:

If the power supply of the PLC is turned on/off with the setting that the access is allowed, the setting will be that the PLC is protected again.

How to prohibit access with password

1. Select "Tool" > "Set PLC Password" in the menu bar.

The "Set PLC Password" dialog box is displayed.

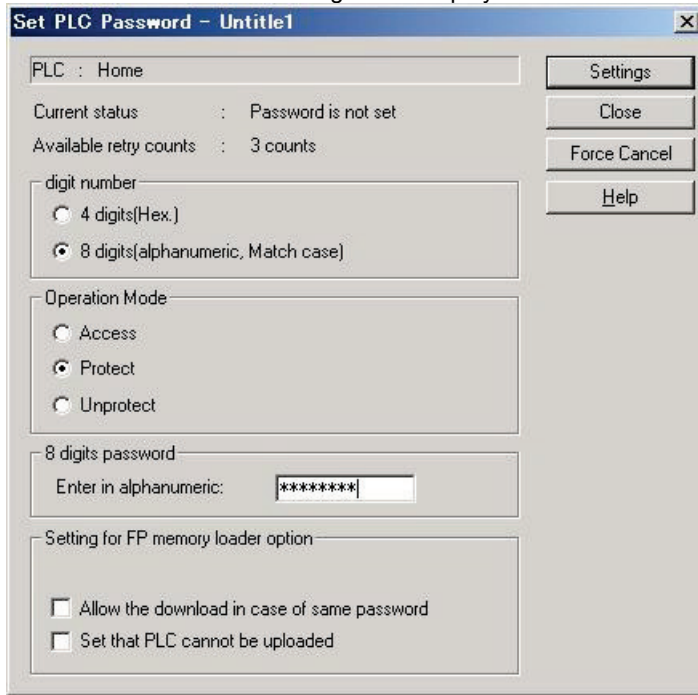

2. Set the items in the table below, and click on the "Settings" button.

Item	Settings
Digit number	Select "4 digits" or "8 digits".
Operation Mode	Select "Protect".
4 digits or 8 digits	Input a password to be set.



3. Input the password for confirmation again, and click the [OK] button.

Once the PLC is in write-read inhibit state (password-protected), the following message is displayed.

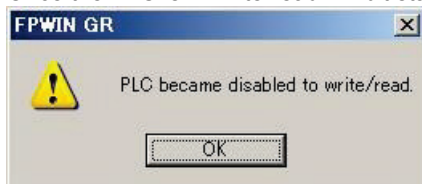

4. Click the "OK" button.

How to permit access with password

1. Select "Tool" > "Set PLC Password" in the menu bar.

The "Set PLC Password" dialog box is displayed.

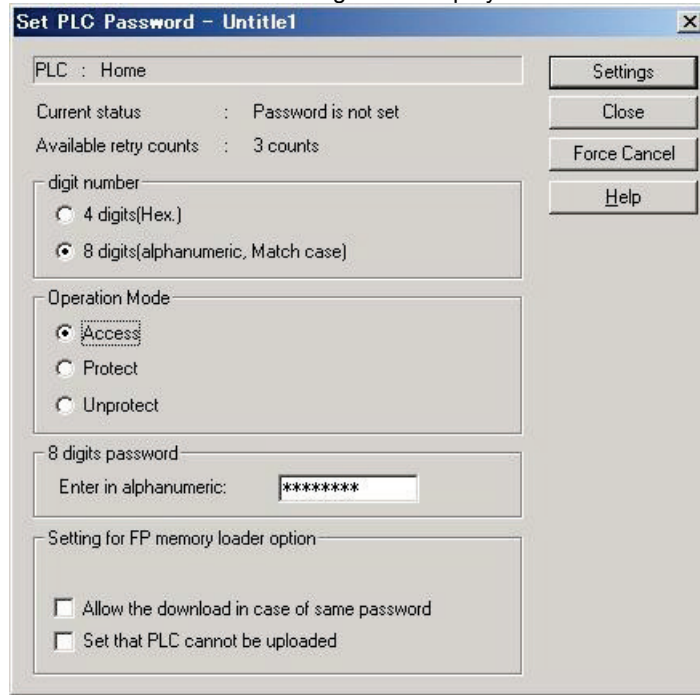

Set the items in the table below, and click on the "Settings" button.

Item	Settings
Digit number	Select "4 digits" or "8 digits".
Operation Mode	Select "Access".
4 digits or 8 digits	Input the set password.

Once access is permitted, the following message is displayed.

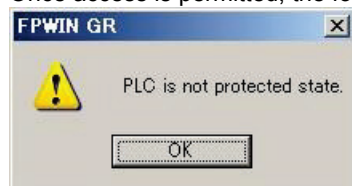

3. Click the "OK" button.



Note:

If the power supply of the PLC is turned on/off when the access is permitted, the PLC will be password protected again.

How to cancel the password protection

Following two methods are available to cancel the password setting.

	Description	Program
Unprotect	Cancels the registered password to be specified.	All programs are retained.
Force cancel	Erases all programs and security information to cancel the setting forcibly.	All programs are deleted. (The upload protection setting is also deleted.)

How to cancel the password protection (Programs are retained.)

1. Select "Tool" > "Set PLC Password" in the menu bar.

The "Set PLC Password" dialog box is displayed.

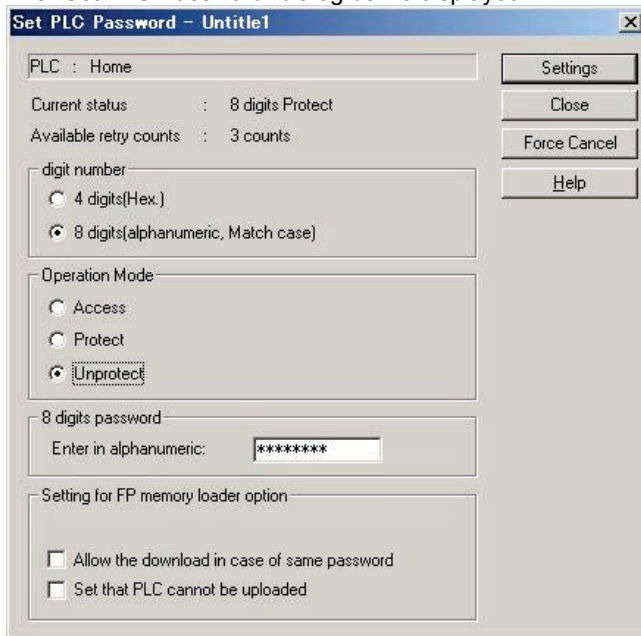

2. Set the items in the table below, and click on the "Settings" button.

Item	Settings
Digit number	Select "4 digits" or "8 digits".
Operation Mode	Select "Unprotect".
4 digits or 8 digits	Input the set password.

Once the cancellation of protection is completed, the following message is displayed.

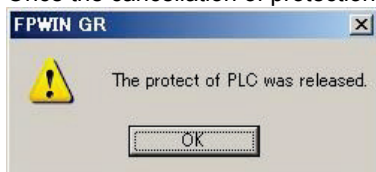

3. Click the "OK" button.



Note:

Unless the access is permitted, the cancellation of password cannot be executed.

How to force cancel (Programs and security information are all deleted.)

1. Select "Tool" > "Set PLC Password" in the menu bar.

The "Set PLC Password" dialog box is displayed.

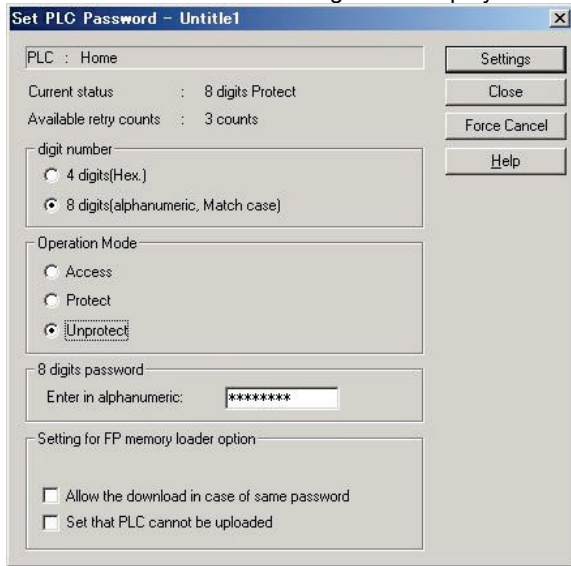

2. Click the "Force Cancel" button.

A confirmation message is displayed.

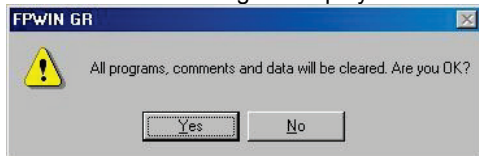

3. Confirm the message and click the "OK" button.

If the current status is "Password is not set", this procedure has completed. All programs and security information were deleted.

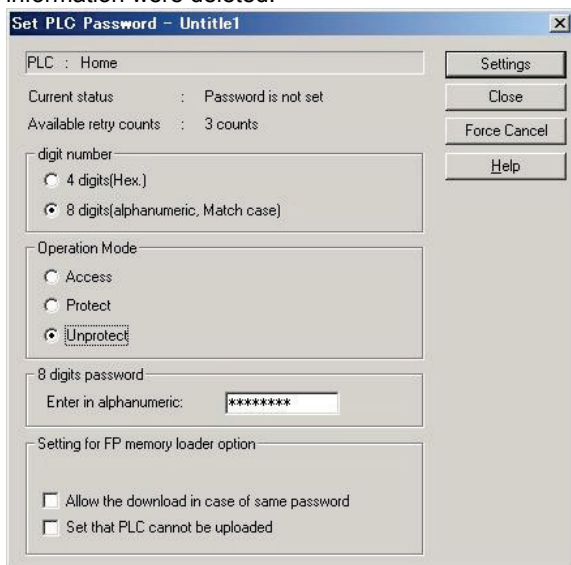

9.2 Upload Protection

9.2.1 Upload Protection

Overview of program upload protection function

- This function is to prohibit reading programs and system registers by setting to disable program uploading.
- If the upload protection is set, note that the ladder programs and system registers will be disabled to be uploaded after that. Transferring programs to the FP memory loader will be also unperformable.
- The setting can be cancelled using the programming tool, however, all ladder programs, system registers and password information will be deleted when the setting is cancelled.
- Editing the files that are controlled with a PC can be carried out online using the programming tool. However, the programs will be broken if the programs are not absolutely matched. When using this function, store ladder programs as files without fail.

Interaction with the password protect function

- The password setting can be specified simultaneously for the PLC in which this function is set.
- This function can be also set in a password-protected PLC.



Note:

When performing "Release the upload-protection by compulsion"

- All programs and security information will be deleted when the upload protection setting is cancelled. We cannot restore the deleted programs even if you ask us. We cannot read the data of the PLC in which the program upload protection has been set. Keeping your programs is your responsibility.

9.2.2 Setting Method

Use the programming tool to set the upload protection on the control unit.

Upload protection setting with FPWIN GR

1. Select "Online" > "Online Edit Mode" in the menu bar, and press the CTRL and F2 keys. The screen is switched to "Online Monitor".
2. Select "Tool" > "Upload settings" in the menu bar.

The "Upload settings" dialog box is displayed.



3. Select "Set the PLC cannot be uploaded.", and press the "Execute" button.

Force Cancel with FPWIN GR

Select "Release the upload-protection by compulsion" in the "Upload settings" dialog box, and press the "Execute" button.

9.3 Setting Function for FP Memory Loader

9.3.1 Setting Function for FP Memory Loader

The following two functions of the FP memory loader (AFP8670/AFP8671) (*) can be set through the FP0R.

Limited distribution function

(Programs can be downloaded only to the units which the same password has been set.)

When downloading a program from the memory loader, the program can be downloaded only when the program stored in the memory loader matches the password set for the PLC with this function enabled.

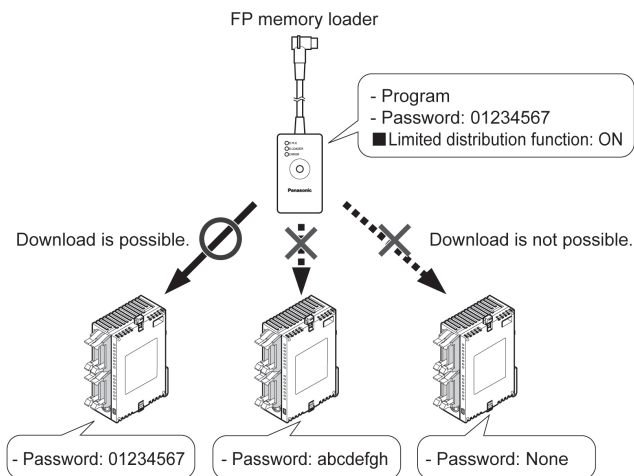

Upload protection setting function

If this function is valid, the PLC will be in the upload protection state by downloading a program to the PLC from the FP memory loader.

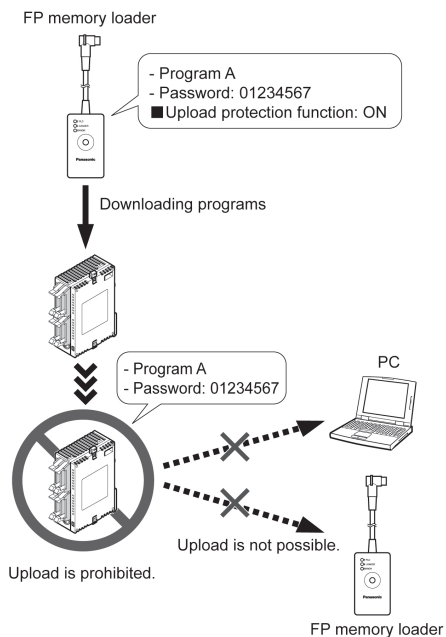

9.3.2 Setting Method

Setting with FPWIN GR

1. Select "Online" > "Online Edit Mode" in the menu bar, and press the CTRL and F2 keys.

The screen is switched to "Online Monitor".

2. Select "Tool" > "Set PLC Password" in the menu bar.

The "Set PLC Password" dialog box is displayed.

3. Set the items in the table below, and click on the "Settings" button.

Item	Settings
Digit number	Select "8 digits".
Operation Mode	Select "Protect".
8 digits password	Enter a 8-digit password.
Setting of FP memory loader option	Check the box of the function to use. - Limited distribution function → "Allow the download in case of same password" - Enable the upload protection setting. → "Set that PLC cannot be uploaded"



Note:

This function is available only when a 8-digit password has been set.

9.3.3 Table of Corresponding Operations of FP Memory Loader Security Function

Note that the operation differs according to the combination of the program stored in the FP memory loader and the status of the PLC to which is written.

Version check list

Status of destination PLC Program in FP memory loader	Password	4-digit password	8-digit password
	Not set	Protected	Protected
- Password is unset. or - 4-bit or 8-bit password is set.	○	○	○
- 8-digit password is set and - "Allow the download in case of same password" is set	×	×	●
- 8-digit password is set and - "Set that PLC cannot be uploaded" is set.	○ Note1)	○ Note1)	○ Note1)
- 8-digit password is set and - "Allow the download in case of same password" is set and - "Set that PLC cannot be uploaded" is set.	×	×	●

○: Download possible ●: Download possible only for models with the same password

×: Download impossible

Note1) The upload protection setting is not available in FP memory loader Ver1.*.

Note2) Although programs cannot be downloaded with FP memory loader Ver.2 or later, only the upload protection setting is activated.

Status of PLC that program has been downloaded

Status of FP memory loader	Password setting for FP0R after download
No password setting	The password will be cleared.
4-digit password setting	The password will be overwritten with a new 4-digit password.
8-digit password setting Limited distribution setting: Off	The password will be overwritten with a new 8-digit password.
8-digit password setting Limited distribution setting: On	The password will not change. (The program itself will not be downloaded.)

9.4 Table of Security Settings/Cancel

For the settings on the FP0R control unit

		Status of security			
		Security not set	Upload protection	4-digit password	8-digit password
Sets/ Cancels	Upload protection	A		A	A
	4-digit password	A	A		N/A
	8-digit password	A	A	N/A	

A: Available N/A: Not available

Chapter 10

Other Functions

10.1 P13 (PICWT) Instruction

Data registers of 32765 words can be stored and used in the built-in ROM (F-ROM data area) control unit using the P13 (PICWT) instruction.

Note the followings for the use:

1. Restrictions on the number of writing

Writing can be performed within 10000 times. If writing continues for more than that, the correct operation cannot be guaranteed.

2. The power supply turns off when the P13 (PICWT) instruction is being executed.

If the power supply turns off during this instruction is being executed, the hold type area may not be kept. (Also, when the power is shut off during rewriting in the RUN mode, the same event may occur.)

10.2 Sampling Trace Function

10.2.1 Overview

The sampling trace function is available for the FP0R. Using this function enables to take samplings and record (accumulate) the state of arbitrary data of 16 bits + 3 data registered in the PLC at an arbitrary timing, and to examine the changes in the bit and data in details after stopping sampling at an arbitrary timing.

The sampling trace function is used by [Time chart monitor] under the online menu of the FPWIN GR.

The instructions, functions, special relays and special registers related to the sampling trace function are as below.

Number	Name	Operation
F155 (SMPL)	sampling instruction	
F156 (STRG)	Sampling stop trigger instruction	
R902C	Sample point flag	OFF = Sampling by instruction ON = Sampling at regular time intervals
R902D	Sampling trace end flag	When sampling trace starts = 0 stops = 1
R902E	Sampling trigger flag	Turns on when sampling stop trigger is on.
R902F	Sampling enable flag	Turns on when sampling operation starts.
DT90028	Interval of sampling trace	K0 = For sampling by instruction K1 to K3000 (10 ms to 30 seconds) For sampling at regular time intervals

10.2.2 Details of Sampling Trace Function

No. of data collectable at one sampling: 16 bits + 3 data

**Sampling capacity (No. of samples accumulable): 300 samples (C10, C14, C16)
1000 samples (C32, T32, F32)**

Types of sampling timing (When an instruction is executed, or at regular time intervals)

- 1: Sampling at regular time intervals From 10 ms
- 2: Sampling by F155 (SMPL) instruction

Sampling for every scan can be executed by the instruction.

Also, more than one sampling can be executed in one scan.

Timing for the execution of the F155 (SMPL) instruction can be set by the ladder sequence.

It is not possible to activate the sampling at regular time intervals and the sampling by the F155 (SMPL) instruction simultaneously.

How to stop sampling

Methods of the stop trigger (request): Following two methods are available.

- 1: Deactivate request by the tool software
- 2: Deactivate request by the F156 (STRG) instruction

If the stop trigger activates, the PLC will continue to take samplings for the specified number of delay, and then stop the sampling operation.

Once the sampling operation stops, the data will be automatically retrieved by the tool software and will be indicated in a time chart.

The number of samples before and after the trigger point can be adjusted by the number of delay. When using the 32-point type with the initial settings (number of samples: 1000, number of delay: 100), the number of samples before and after the trigger point is 900 and 1000 respectively.

Operation image of sampling trace

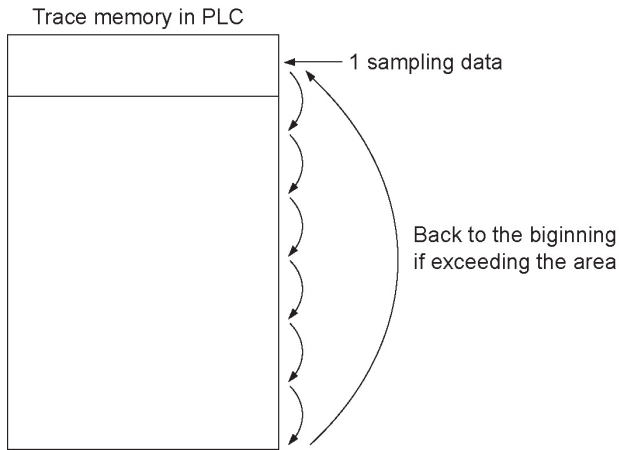

10.2.3 How to Use Sampling Trace

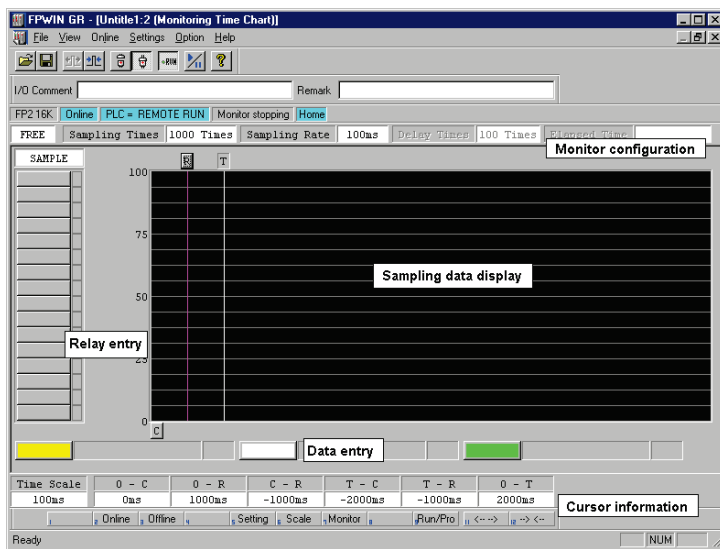

1. Sampling at regular time intervals

- 1) Register the bit/word device to be monitored by the time chart monitor function of FPWIN GR.
- 2) Specify the sampling configurations.
 - Set the mode of the sampling configurations to "TRACE".
 - Set the sampling rate (time).

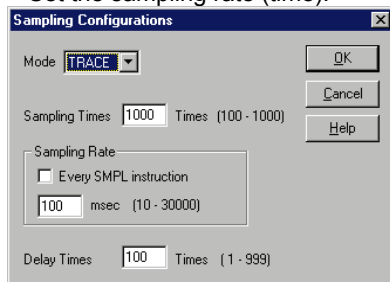

3) Start monitoring. Start with the  button.

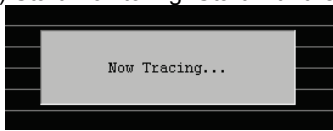

2. Sampling by instruction

- 1) Register the bit/word device to be monitored by the time chart monitor function of FPWIN GR.
- 2) Specify the sampling configurations.
Set the mode of the sampling configurations to " TRACE ".
Set the sampling rate (time) to 0.

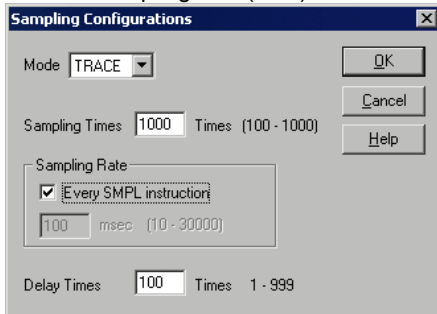

3. Read data by trigger

- 1) Stop sampling by stopping monitoring the trace that has been started in the above procedure 1 or 2 on the time chart display of FPWIN GR. The data will be indicated in the time chart.

Stop monitoring. (Stop with the , stop by the "Trigger Break" in the menu, or stop by the F156 instruction.)

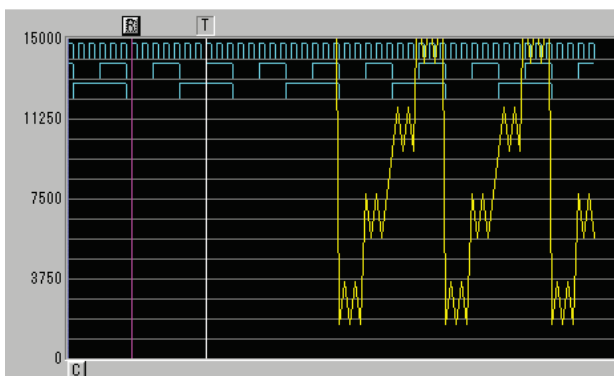
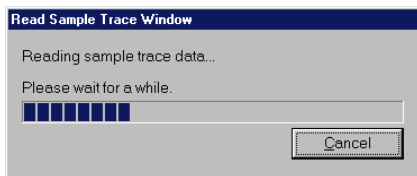
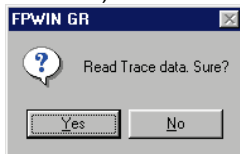

Reference: <FPWIN GR Help>

10.3 Time Constant Processing

The input time constants for 16 points of the CPU input X0 to XF can be set by the system registers 430 to 433.

If this setting is specified, an operation like the equivalent circuit below will be performed.

By the setting, the noises or chattering of input will be removed.

CXn = Input signal of Xn contact

Xn = Image memory of input Xn

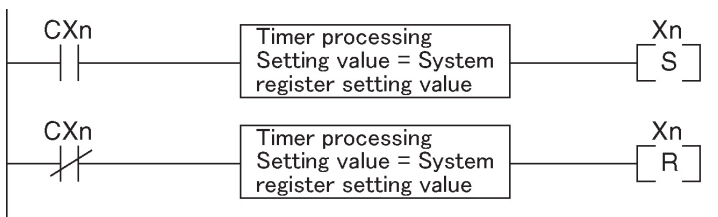

Note:

- The input signal of X contact is retrieved at the timing of the normal I/O update.
- If the partial update instruction is executed for the input in the time constant processing, the time constant processing will be invalid, and the input status at the time will be read out and set.
- The time constant processing can be performed for the input other than X0 to XF (add-on cassettes or expansion units) by the F182 (FILTR) instruction.
- The timer instruction is not used for the timer processing in this equivalent circuit.
- The time constant processing is invalid when the high-speed counter, pulse catch or interrupt has been specified.

Input time constant setting function and applicable models

System register No.	Control unit input I/O No.	Applicable model	
		C10/C14/C16	C32/T32/F32
430	X0 to X3	A	A
431	X4 to X7	A	A
432	X8 to XB	N/A	A
433	XC to XF	N/A	A

A: Available N/A: Not available

Chapter 11

Self-Diagnostic and Troubleshooting

11.1 Self-Diagnostic function

11.1.1 LED Display for Status Condition

How to read status indicator LEDs on control unit

	LED status			Description	Operation status
	RUN	PROG.	ERROR/ALARM		
Normal condition	Light (on)	Off	Off	Normal operation	Operation
	Off	Light (on)	Off	PROG. mode	Stop
	Flashes	Flashes	Off	Forcing input/output in Run mode	Operation
Abnormal condition	Light (on)	Off	Flashes	Self-diagnostic error (Operation is running.)	Operation
	Off	Light (on)	Flashes	Self-diagnostic error (Operation stops.)	Stop
	Light (on) or off	Light (on) or off	Light (on)	System watchdog timer has been activated	Stop

- The control unit has a self-diagnostic function which identifies errors and stops operation if necessary.
- When an error occurs, the status of the status indicator LEDs on the control unit vary, as shown in the table above.

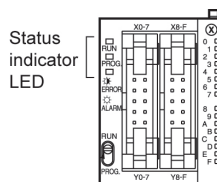

11.1.2 Operation Mode When an Error Occurs

Normally, when an error occurs, the operation stops.

When the duplicated output error or operation error occurs, the user may select whether operation is to be continued or stopped by setting the system registers. You can set the error which operation is to be continued or stopped using the programming tool software as shown below.

“PLC System Register” setting menu on programming tool software

To specify the steps to be taken by the FPWIN GR if a PLC error occurs, select “PLC System Register setting” under “Option” on the menu bar, and click on the “Action on Error” tab. The screen shown below is displayed.

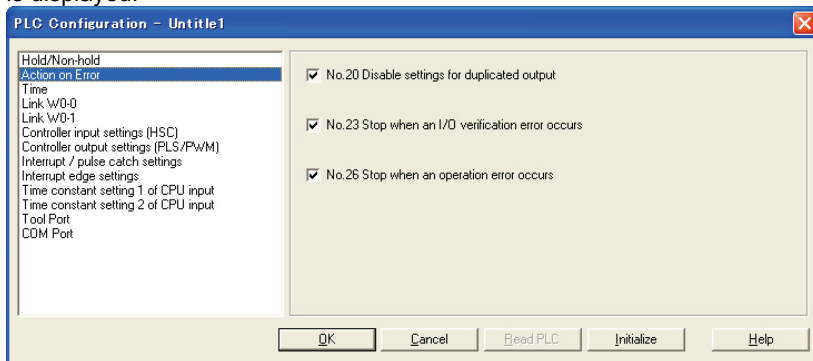

Example1: When allowing duplicated output

Turn off the check box for No. 20. When operation is resumed, it will not be handled as an error.

Example2: When continuing operation even a calculation error has occurred

Turn off the check box for No. 26. When operation is resumed, it will be continued, but will be handled as an error.

11.2 Troubleshooting

11.2.1 If ERROR/ALARM LED is Flashing

Condition: The self-diagnostic error occurs

Procedure 1

Check the error contents (error code) using the programming tool.

Using FPCWIN GR

With the FPCWIN GR, if a PLC error occurs during programming or debugging and the RUN mode is changed to the PROG. mode, the following status display dialog box is displayed automatically. Check the contents of the self-diagnosed error.

Status display dialog box

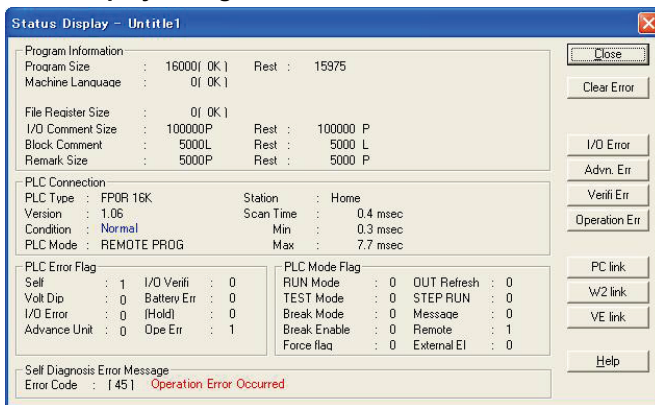

If the error is an operation error, the error address can be confirmed in this dialog box.



Key Point:

To display the status display dialog box, select "Status Display" under "Online" on the menu bar.

Using FPCWIN Pro

With the FPCWIN Pro, the contents of the self-diagnostic error can be checked in the following PLC status dialog box. Select "PLC status" under "Monitor" in the menu to display this dialog box.

PLC status dialog box

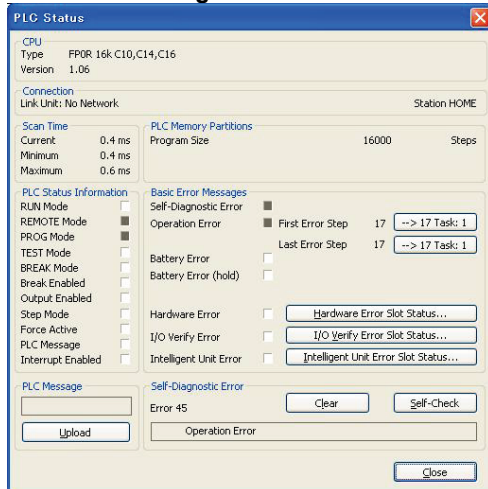

Procedure 2

<For error code is 1 to 9>

- Condition

There is a syntax error in the program.

- Operation 1

Change to PROG. mode and clear the error.

- Operation 2

Execute a total-check function using FPWIN GR to determine the location of the syntax error.

Or execute a check or compile using FPWIN Pro to determine the location of the syntax error.

<For error code is 20 or higher>

- Condition

A self-diagnostic error other than a syntax error has occurred.

- Operation

Use the programming tool in PROG. mode to clear the error.

Using FPWIN GR/FPWIN Pro

Click on the “Clear Error” button in the “Status display dialog box”. Error code 43 and higher can be cleared.

- In the PROG. mode, the power supply can be turned off and then on again to clear the error, but all of the contents of the operation memory except hold type data are cleared.
- An error can also be cleared by executing a self-diagnostic error set instruction F148 (ERR).



Key Point:

When an operation error (error code 45) occurs, the address at which the error occurred is stored in special data registers DT90017 and DT90018. If this happens, click on the “Operation Err” button in the “Status display dialog box” and confirm the address at which the error occurred before cancelling the error.

11.2.2 If ERROR LED is ON

Condition: The system watchdog timer has been activated and the operation of PLC has been activated.

Procedure 1

Set the mode selector of PLC from RUN to PROG. mode and turn the power off and then on.

- If the ERROR/ALARM LED is turned on again, there is probably an abnormality in the FP0R control unit. Please contact your dealer.
- If the ERROR/ALARM LED is flashed, go to chapter 11.2.1.

Procedure 2

Set the mode selector from PROG. to RUN mode.

- If the ERROR/ALARM LED is turned on, the program execution time is too long. Check the program.

Check

- (1)Check if instructions such as “JMP” or “LOOP” are programmed in such a way that a scan never finish.
- (2)Check if interrupt instructions are executed in succession.

11.2.3 ALL LEDs are OFF

Procedure 1

Check wiring of power supply.

Procedure 2

Check if the power supplied to the FP-X control unit is in the range of the rating.

- Be sure to check the fluctuation of the voltage.

Procedure 3

Disconnect the power supply wiring to the other devices if the power supplied to the FP-X control unit is shared with them.

- If the LED on the control unit turn on at this moment, increase the capacity of the power supply or prepare another power supply for other devices.
- Please contact your dealer for further questions.

11.2.4 Diagnosing Output Malfunction

Proceed from the check of the output side to the check of the input side.

Check of output condition 1: Output indicator LEDs are on

Procedure 1

Check the wiring of the loads.

Procedure 2

Check if the power is properly supplied to the loads.

- If the power is properly supplied to the load, there is probably an abnormality in the load. Check the load again.
- If the power is not supplied to the load, there is probably an abnormality in the output section. Please contact your dealer.

Check of output condition 2: Output indicator LEDs are off

Procedure 1

Monitor the output condition using a programming tool.

- If the output monitored is turned on, there is probably a duplicated output error.

Procedure 2

Forcing on the output using forcing input/output function.

- If the output indicator LED is turned on, go to input condition check.
- If the output indicator LED remains off, there is probably an abnormality in the output unit. Please contact your dealer.

Check of input condition 1: Input indicator LEDs are off

Procedure 1

Check the wiring of the input devices.

Procedure 2

Check that the power is properly supplied to the input terminals.

- If the power is properly supplied to the input terminal, there is probably an abnormality in the input unit. Please contact your dealer.
- If the power is not supplied to the input terminal, there is probably an abnormality in the input device or input power supply. Check the input device and input power supply.

Check of input condition 2: Input indicator LEDs are on

Procedure

Monitor the input condition using a programming tool.

- If the input monitored is off, there is probably an abnormality with the input unit. Please contact your dealer.
- If the input monitored is on, check the leakage current at the input devices (e.g., two-wire type sensor) and check the program again.

Check

- (1)Check for the duplicated use of output. Check whether the output has been rewritten using the high-level instruction.
- (2)Check the program flow when a control instruction such as MCR or JMP is used.

11.2.5 A Protect Error Message Appears

When a password function is used

Procedure

Enter a password in the “Set PLC Password” menu (FPWIN GR), “Security settings” menu (FPWIN Pro) and change it to the state to enable “Access”.

Using FPWIN GR

- (1) Select “Set PLC Password” under “Tool” on the menu bar.
- (2) The PLC password setting dialog box shown below is displayed. Turn on the radio button next to “Access”, enter a password, and click on the “Settings” button.

Set PLC password dialog box

The screenshot shows the "Set PLC Password" dialog box. It includes fields for "PLC" (set to Home), "Current status" (Password is not set), and "Available retry counts" (3 counts). There are radio buttons for "digit number" (4 digits(Hex.) and 8 digits(alphanumeric, Match case)), "Operation Mode" (Access, Protect, Unprotect), and "Setting for FP memory loader option" (Allow the download in case of same password, Set that PLC cannot be uploaded). Buttons for "Settings", "Close", "Force Cancel", and "Help" are visible.

Using FPWIN Pro

- (1) Select "Security Settings" under "Online" on the menu bar.
- (2) The security setting dialog box shown below is displayed. Input the password in the field of "PLC access", and click the "Login" button.

Security Settings dialog box

The screenshot shows the "Security Settings" dialog box. It has sections for "Status Information" (Password protection: Password set and user logged in, Password retry count: 3), "Upload Protection" (Enable upload protection), "PLC Protection" (Password: Enter old password, Enter new password, Repeat new password, Change Protection, Clear Protection), "FP Memory Loader" (Enable upload protection, Allow download to PLC only if password in the PLC is the same), and "PLC Access" (Please enter up to 8 characters, Enter password, Login, Logout, Help).

11.2.6 PROG Mode does not Change to RUN

Condition: A syntax error or a self-diagnosed error that caused operation to stop has occurred.

Procedure 1

Check if the ERROR/ALARM LED is flashing.



Example:

If the ERROR/ALARM LED is flashing, check <11.2.1 If ERROR/ALARM LED is Flashing >.

Procedure 2

Execute a total check (FPWIN GR) or check/compile (FPWIN Pro) to determine the location of the syntax error.

Using FPWIN GR

Select "Debug" on the menu bar, and select "Totally check program". Click on the "Execute" button in the total check dialog box.

Using FPWIN Pro

Select "Compile All" under "Project", or "Check" under "Object" on the menu bar. As the dialog box is displayed, check the contents.

11.3 Operation Errors

11.3.1 Outline of Operation Errors

- An operation error is a condition in which operation is impossible when a high-level instruction is executed.
- When an operation error occurs, the ERROR/ALARM LED on the control unit will blink and the operation error flags (R9007 and R9008) will turn on.
- The operation error code "E45" is set at special data register DT90000.
- The error address is stored in special data registers DT90017 and DT90018.

Types of operation error

1. Address error

The memory address (number) specified by index modification is outside the area which can be used.

2. BCD data error

Operation is attempted on non-BCD data when an instruction handling BCD is executed, or BCD conversion is attempted on data which is not within the possible conversion range.

3. Parameter error

In an instruction requiring the specification of control data, the specified data is outside the possible range.

4. Over area error

The data manipulated by a block instruction exceeds the memory range.

11.3.2 Operation Mode When an Operation Error Occurs

- Normally, the operation stops when an operation error occurs.
- When you set system register 26 to "continuation", the control unit operates even if an operation error occurs.

Using FPWIN GR

1. Set the mode of the CPU to RPOG.
2. Select the "Option" in "PLC Configuration" option from the menu bar.
3. On the "PLC Configuration" menu, select "Action on error". This displays system registers 20 to 26.
4. Remove the check of system register 26.
5. Press the "OK" to write the setting to the PLC.

Using FPWIN Pro

1. Change the mode to offline.
2. Select "Action on error" from the system register table of the project navigator.
3. Change the setting of No. 26.

11.3.3 Dealing with Operation Errors

<Procedure>

1. Check the location of the error.

Check the address where the error occurred, which is stored in DT90017 and DT90018, and make sure the high-level instruction for that address is correct and appropriate.

2. Clear the error.

Use a programming tool to clear the error.

- When using FPWIN GR, select "Online" -> "Status Display" in the menu bar. Execute "Clear Error".
- When using FPWIN Pro, select "Monitor" -> "PLC Status". Press the "Error Clear" button.
- An error can be cleared by turning the power off and on in PROG. mode, however, the contents of the operation memory except the hold type data will be cleared.
- An error can also be cleared by executing a self-diagnostic error set instruction (F148).
- If the mode selector is set to "RUN", RUN will resume as soon as the error is cleared. So if the cause of the error is not removed, the error may seem not to be cleared.

11.3.4 Points to Check in Program

1. Check if an extraordinarily large value or negative value was stored in the index register.

<Example> When a data register is modified using an index register

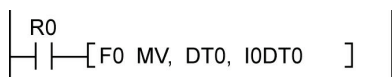

In this case, index register modifies the address of data register DT0. However, it may exceed the addressable range of the data register depending on the data in I0. If the value exceeds the range, an operation error will occur. The same is true when the contents of I0 are a negative value.

2. Is there any data which cannot be converted using BCD ↔ BIN data conversion?

<Example> When BCD-to-BIN conversion is attempted

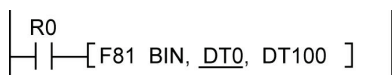

In this case, if DT0 contains a hexadecimal number with one of the digits A through F such as 12A4, conversion will be impossible and an operation error will result.

<Example> When BIN-to-BCD conversion is attempted

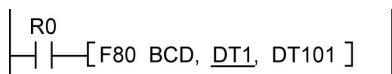

In this case, if DT1 contains a negative value or a value greater than K9999, an operation error will occur.

3. Check if the divisor of a division instruction is "0".

<Example>

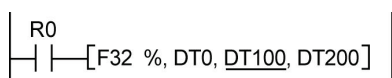

In this case, if the content of DT100 is "0", an operation error will occur.

Chapter 12

Precautions During Programming

12.1 Use of Duplicated Output

12.1.1 Duplicated Output

What is duplicated output?

- Duplicated output refers to repeatedly specifying the same output in a sequence program.
- If the same output is specified for the "OT" and "KP" instructions, it is considered to be duplicated output.
(Even if the same output is used for multiple instructions, such as the SET, RST instruction or high-level instruction (such as data transfer), it is not regarded as duplicated output.)
- If you enter RUN mode while the duplicated output condition exists, it will be normally flagged as an error. (The ERROR/ALARM LED will flash and the self-diagnostic error flag R9000 will go on.)

How to check for duplicated use

You can check for duplicated outputs in the program using the programming tool, by the following method.

Using FPWIN GR

Select the "Debug" → "Totally Check Program" in the menu bar, and click "Execute". If there are any duplicated outputs, an error message and the address will be displayed.

Using FPWIN Pro

If there are any duplicated outputs, an error message and the address will be displayed when compiling programs.

Enabling duplicated output

- If you need to use output repeatedly due to the content of the program, duplicated output can be enabled.
- In this case, change the setting of system register 20 to "enable".
- When this is done, an error will not occur when the program is executed.

12.1.2 When Output is Repeated with an OT, KP, SET or RST Instruction

Condition of internal and output relays during operation

- When instructions are repeatedly used which output to internal and output relays such as transfer instructions and OT, KP, SET and RST instructions, the contents are rewritten at each step during operation.

<Example> Processing when SET, RST and OT instructions are used (X0 to X2 are all on).

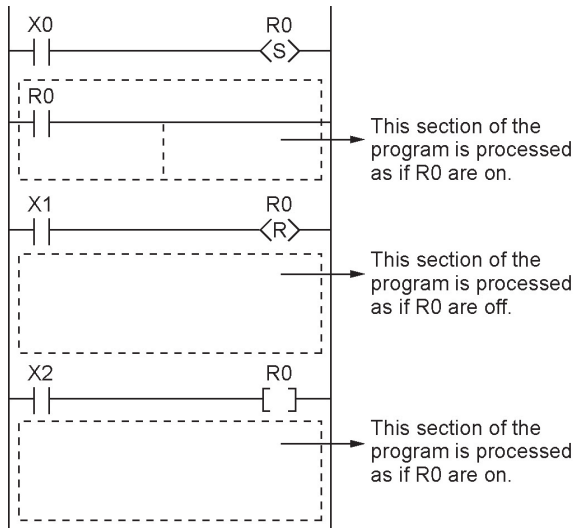

The output is determined by the final operation results

- If the same output is used by several instructions such as the OT, KP, SET, RST or data transfer functions, the output obtained at the I/O update is determined by the final results of the operation.

<Example> Output to the same output relay Y0 with OT, KP, SET and RST instructions.

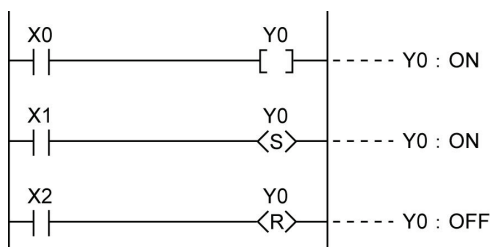

When X0 to X2 are all on, Y0 is output as off at I/O update.

- If you need to output a result while processing is still in progress, use a partial I/O update instruction (F143).

12.2 Handling Index Registers

12.2.1 Index Registers

- Like other registers, index registers have 14 points, I0 to ID, for reading and writing 16-bit data.
- Use an index register to indirectly specify a memory area number. (This is called index modification.)

<Example> Transferring the contents of data register DT100 to the number specified by the contents of an index register.

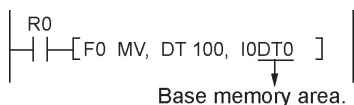

In this example, the number of the destination data register varies depending on the contents of I0 with DT0 acting as a base. For example, when I0 contains K10, the destination will be DT10, and when I0 is K20, the destination will be DT20.

- In this way, index registers allow the specification of multiple memory areas with a single instruction, and thus index registers are very convenient when handling large amounts of data.

12.2.2 Memory Areas Which can be Modified with Index Registers

- Index registers can be used to modify other types of memory areas in addition to data registers DT.
<Example> I0WX0, I0WY1, I0WR0, I0SV0, I0EV2, I0DT100
- Constants can be also modified.
<Example> I0K10, I0H1001
- An index register cannot modify another index register.
<Example> I0I0, I0I1
- When using index modification with an instruction which handles 32-bit data, specify with I0. In this case, I0 and I1 are handled together as 32-bit data.

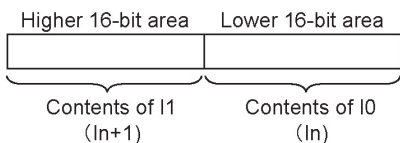

12.2.3 Example of Using an Index Register

Repeatedly reading in external data

<Example> Writing the contents of input WX3 to a sequence of data registers beginning from DT0.

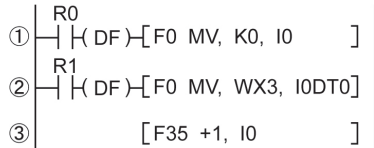

- ① When R0 turns on, 0 is written to index register I0.
- ② When the R1 turns on, the contents of input WX3 is transferred to the data register specified by I0DT0.
- ③ Add 1 to I0.

In this case, the contents of I0 will change successively, and the destination data register will be as follows.

Input times of R1	Contents of I0	Destination data register
1st	0	DT0
2nd	1	DT1
3rd	2	DT2
:	:	:

Inputting and outputting data based on a number specified by an input

<Example 1> Setting a timer number specified by a digital switch

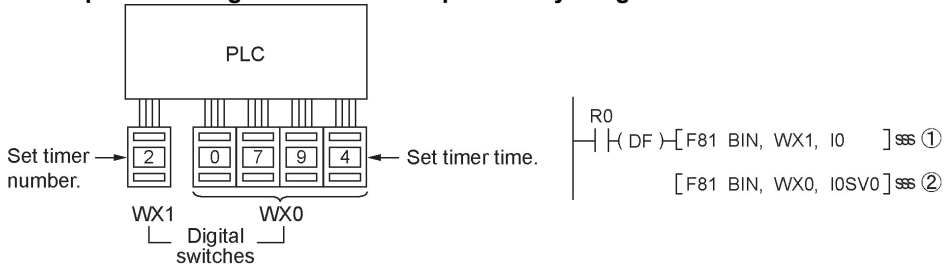

- ① Convert the BCD timer number data in WX1 to binary and set it in index register I0.
- ② Convert the BCD timer set value in WX0 to binary and store in the timer set value area SV specified by contents of I0.

<Example 2> Taking external output of the elapsed value in a timer number specified by a digital switch

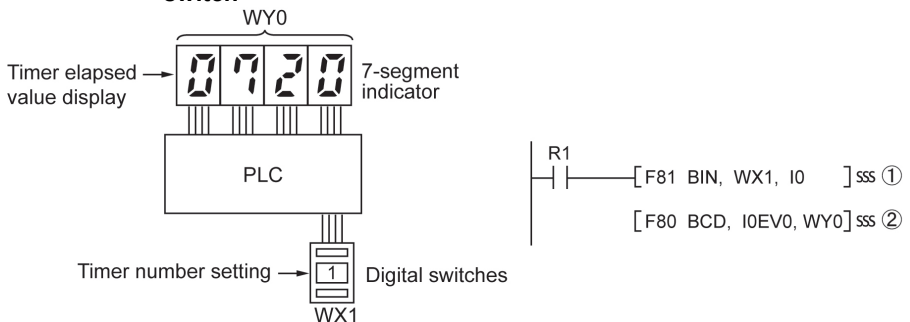

- ① Convert the BCD timer number data in WX1 to binary and set it in index register I0.
- ② Convert the elapsed value data EV in the timer specified by I0 to BCD, and output it to output relay WY0.

12.3 Instructions of Leading Edge Detection Method

12.3.1 Instructions of Leading Edge Detection Method

Instructions using the leading edge detection operation

1. DF (leading edge differential) instruction
2. Count input for CT (counter) instruction
3. Count input for F118 (UCD up-down counter) instruction
4. Shift input for SR (shift register) instruction
5. Shift input for F119 (LRSR left-right shift register) instruction
6. NSTP (next step) instruction
7. Differential execution type high-level instruction (P13)

Leading edge detection method

- An instruction with a leading edge detection method operates only in the scan where its trigger (execution condition) is detected switching from off to on.

1. Standard operation

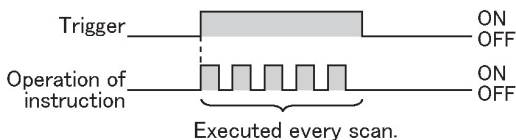

2. Leading edge detection operation

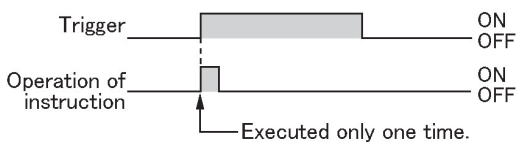

How to perform leading edge detection

The condition of the previous execution and the condition of the current execution are compared, and the instruction is executed only if the previous condition was off and the current condition is on. In any other case, the instruction is not executed.

Precautions when using an instruction which performs leading edge detection

- When RUN begins, for example when the system is powered on, the off -> on change of the execution condition (trigger) is not detected. Execution of the instruction will take place as explained on the next page.
- When used with one of the instructions indicated in instructions 1 to 6 below which change the order of execution of instructions, the operation of the instruction may change depending on input timing. Take care regarding this point.

Be careful when using leading edge detection type instructions with control instructions, such as;

1. MC and MCE instructions
2. JP and LBL instructions
3. LOOP and LBL instructions
4. CNDE instruction
5. Step ladder instructions
6. Subroutine instructions

12.3.2 Operation and Precautions When RUN starts

Operation of first scan after RUN begins

- The leading edge detection instruction is not executed when the mode has been switched to the RUN mode, or when the power supply is booted in the RUN mode, if the trigger (execution condition) is already on.

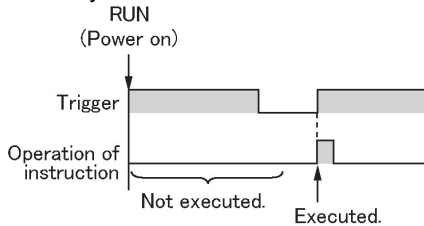

- If you need to execute an instruction when the trigger (execution condition) is on prior to switching to RUN mode, make a program as below using R9014 (initial pulse off relay). (R9014 is a special internal relay which is off during the first scan and turns on at the second scan.)

<Example 1> DF (leading edge differential) instruction

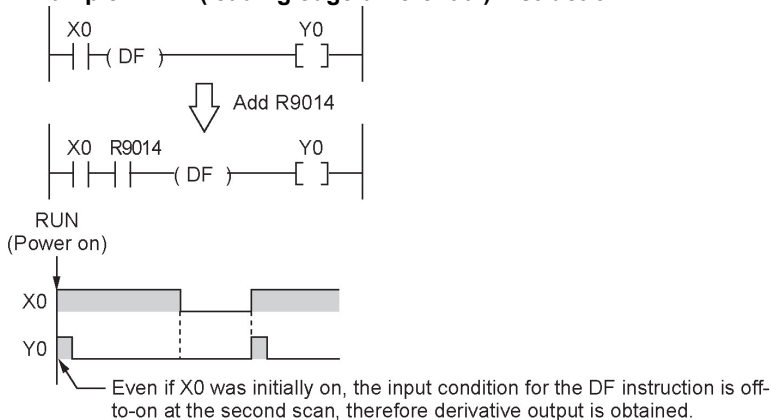

<Example 2> CT (counter) instruction

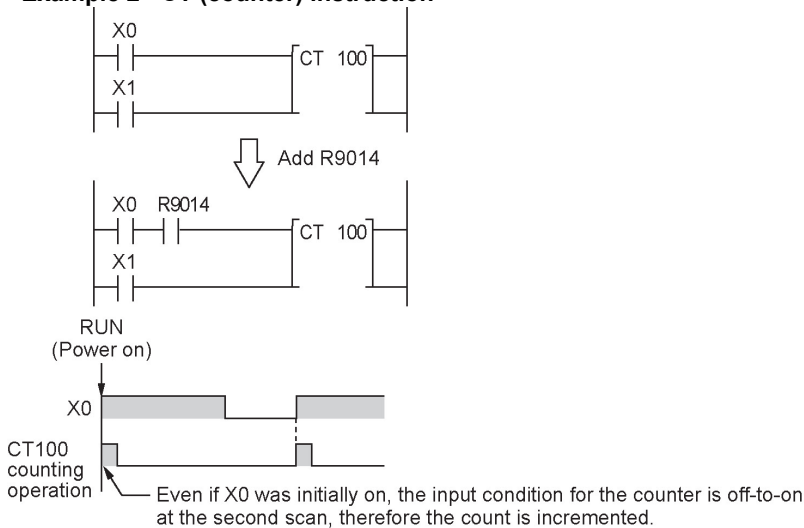

12.3.3 Precautions When Using a Control Instruction

- If a leading edge detection instruction is in a control instruction, it will be executed only under the following condition: The leading edge detection instruction was off when the execution condition of the previous control instruction was reset, and the leading edge detection instruction is on when the execution condition of the current control instruction becomes on.
- When a leading edge detection instruction is used with an instruction which changes the order of instruction execution such as MC, MCE, JP or LBL, the operation of the instruction may change as follows depending on input timing. Take care regarding this point.

<Example 1> Using the DF instruction between MC and MCE instructions

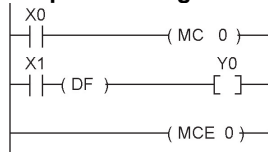

[Time chart 1]

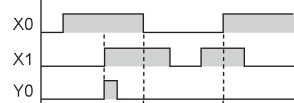

X1 was on when X0 became off.

The input condition (X1) for the DF instruction has not changed since the time of the previous execution, thus derivative output is not obtained.

[Time chart 2]

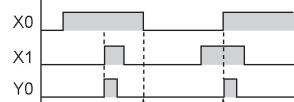

X1 was off when X0 became off.

The input condition (X1) for the DF instruction has changed from off to on since the time of the previous execution, thus derivative output is obtained.

<Example 2> Using the CT instruction between JP and LBL instructions

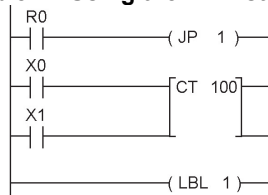

[Time chart 1]

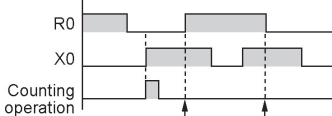

Final timing at which the previous JP instruction was not executed.

The count is not incremented, because the final timing at which the previous JP instruction was not executed has not been change, and the execution condition X0 for the counter input has not changed.

[Time chart 2]

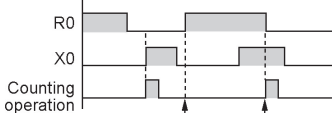

Final timing at which the previous JP instruction was not executed.

The count is not incremented, because the count input changed from off to on after the final timing at which the previous JP instruction was not executed.

12.4 Precautions for Programming

Programs which are not executed correctly

Do not write the following programs as they will not be executed correctly.

<Example 1>

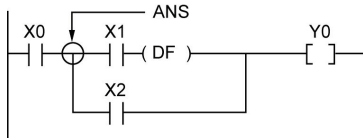

- When X1 was on prior to X0, Y0 will not be on even if X0 becomes on.

<Example 2>

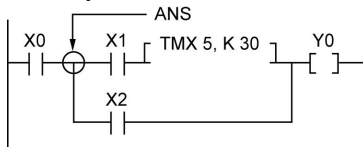

- TMX5 will activate if X1 becomes on regardless of whether X0 is on or off.

<Example 3>

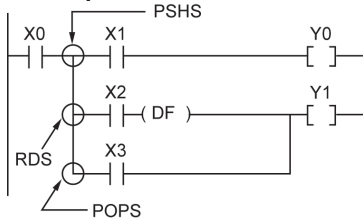

- When X2 was on prior to X0, Y1 will not be on even if X0 becomes on.

When a combination of contacts are set as the trigger (execution condition) of a differential instruction (DF) or timer instruction, do not use an AND stack (ANS) instruction, read stack (RDS) instruction, or pop stack (POPS) instruction.

Examples in which the above programs are rewritten correctly

<Program in which the example 1 is rewritten>

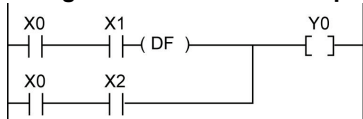

<Program in which the example 2 is rewritten>

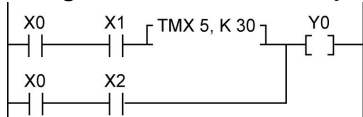

<Program in which the example 3 is rewritten>

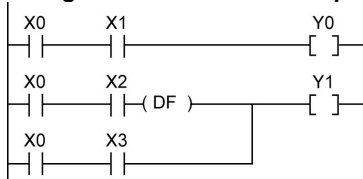

12.5 Rewrite Function During RUN

12.5.1 Operation of Rewrite During RUN

How operation of rewrite during RUN is performed

Rewriting programs can be executed even in RUN mode. When a rewrite is attempted during RUN, the tool service time is temporarily extended, program rewriting is performed, and operation is resumed without the need to change the mode. For this reason, the time of the scan during the RUN rewrite extends from several ms to several hundreds of ms.

Operation during rewrite

1. External output (Y) is held.
2. External input (X) is ignored.
3. The timer (T) stops the clock.
4. Rise and fall changes in the inputs of differential instructions (DF), counter instructions (CT), and left/right sift registers are ignored.
5. Interrupt functions are stopped.
6. Internal clock relays (special internal relays) are also stopped.
7. Pulse output is stopped during the rewrite.

Set values for timer/counter instructions

All set values specified with decimal constants (K) in timer and counter instructions are preset in the corresponding set value areas (SV). Values in the elapsed value area (EV) do not change/

Operation of rewrite during RUN complete flag

The rewrite during RUN complete flag (R9034) is a special internal relay that goes on for only the first scan following the completion of rewriting in the RUN mode. It can be used instead of the initial pulse relay following a change in the program.

12.5.2 Cases Where Rewriting During Run is Not Possible

When the timeout error message is indicated:

Even if the timeout error message is indicated, it is highly possible that the program in PLC has been already rewritten. Carry out the following operations.

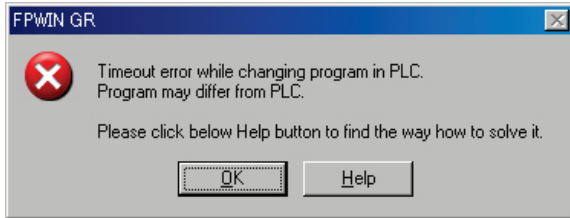

1. When ladder symbol mode

As a ladder editing is left, set it to the offline edit mode. Complete the program conversion in the tool software, and then change to the online edit mode to check.

2. When boolean mode

A ladder editing is cleared.

Set it to the offline edit mode and carry out the editing operation again. After the operation, change to the online edit mode to check.

When the timeout error occurs using the through mode in GT series programmable display

Extend the timeout time of the programmable display using the GTWIN.

(The default setting is 5 seconds.)

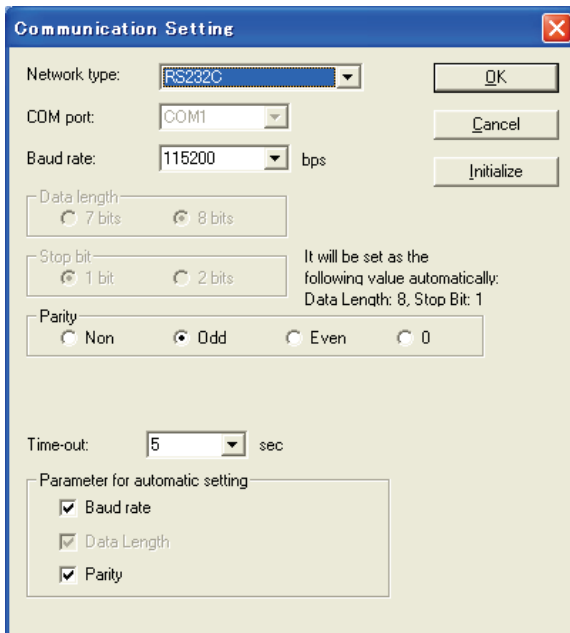

Select "Transfer" from "File" in the menu bar. The "Transfer data" screen will open.

Select "Condition" to open "Communication Setting" screen.

Change the value for "Timeout".

Click "OK" button to complete the change of setting.

Cases where rewriting is not possible during RUN

1. When the result of rewriting is a syntax error.

<Example>

When executing the rewriting which does not form the following pair of instructions.

1. Step ladder instructions (SSTP/STPE)
2. Subroutine instructions (SUB/RET)
3. Interrupt instructions (INT/IRET)
4. JP/LBL
5. LOOP/LBL
6. MC/MCE

Also, rewriting is not possible during RUN in case of other syntax error.

2. During the forced input/output operation

Interrupt restrictions

When using interrupt, high-speed counter, pulse output or PWM output functions, do not perform a rewrite during RUN.

If a rewrite during RUN is executed, the operation as below will be performed. Exercise caution.

1. Interrupt programs will be disabled.

Enable by executing an ICTL instruction once again.

<Example> Using R9034 (rewrite during RUN completed flag)

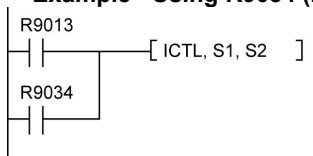

2. The high-speed counter will continue to count.

Target value match on/off instructions (F166/F167) will continue.

Coincidence interrupt programs will be disabled when the F166/F167 instruction is running.

3. The pulse output/PWM output stops when the rewriting is performed. The operation after the completion of the rewriting during RUN varies depending on each instruction.

Mode	Instruction No.	Name	Operation after the completion of rewriting during RUN
FP0 compatibility mode	F168(SPD1)	Pulse output (Trapezoidal control)	The operation before rewriting continues.
	F168(SPD1)	Pulse output (Home return)	The operation before rewriting continues.
	F169(PLS)	Pulse output (JOG operation)	Stop
	F170(PWM)	PWM output	Stop
FP0R mode	F171(SPDH)	Pulse output (Trapezoidal control)	Stop
	F171(SPDH)	Pulse output(JOG positioning)	Stop
	F172(PLSH)	Pulse output (JOG operation)	Stop
	F173(PWMH)	PWM output	Stop
	F174(SPOH)	Pulse output (Selectable data table control operation)	The operation before rewriting continues.
	F175(PSH)	Pulse output (Linear interpolation)	The operation before rewriting continues.
	F177(HOME)	Pulse output (Home return)	The operation before rewriting continues.

4. The regular sampling trace will not stop.

12.5.3 Procedures and Operation of Rewrite During RUN

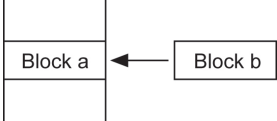
Item		FPWIN GR Ladder symbol mode	FPWIN GR Boolean mode
Rewrite procedure		<p>Maximum of 128 steps. Changes are performed by block. When PG conversion is executed online, the program will be rewritten.</p> 	<p>Rewriting performed by step. Caution is required as rewriting takes place simultaneously with the change.</p>
Operation of each instruction	OT/KP	If an instruction written in block a is detected in block b, the condition before the rewrite will be held.	If an instruction written in block a is detected in block b, the condition before the rewrite will be held. Y contact relays which are on will be held in the on state. To turn them off in the RUN mode, use forced output. To turn them off in the RUN mode, use forced output.
	TM/CT	If an instruction written in block a is detected in block b, the condition before the rewrite will be held. Set values specified by K constants in TM/CT instructions are preset in all of the corresponding SV in the program. (Elapsed values EV do not change.)	If an instruction written in block a is detected in block b, the condition before the rewrite will be held. Set values specified by K constants in TM/CT instructions are preset in all of the corresponding SV in the program. (Elapsed values EV do not change.)
	Fun High-level instructions	If an instruction written in block a is detected in block b, the condition before the rewrite will be held.	If deleted, the output memory area will be held.
	MC/ MCE	When writing MC/MEC instructions, be sure to write the instructions as a pair.	Writing or deleting a single instruction during RUN is not possible. Write or delete the instruction in FPWIN GR ladder symbol mode.
	CALL/ SUB/ RET	A subroutine is a program appearing between SUBn and RET instructions. Be sure to write it to an address which follows the ED instruction.	Write in the order: RET, SUB, CALL Delete in the order: CALL, SUB, RET
	INT/ IRET	An interrupt program is a program appearing between INTn and IRET instructions. Be sure to write it to an address which follows the ED instruction.	Write in the order: IRET, INT Delete in the order: INT, IRET

Item		FPWIN GR Ladder symbol mode	FPWIN GR Boolean mode
Operation of each instruction	SSTP/ STPE	A distance with the same number cannot be defined twice. An SSTP instruction cannot be written in a subprogram.	Writing and deletion of a single instruction is not possible for a program with no step ladder area. Write or delete both instructions simultaneously in FPWIN GR ladder symbol mode. In the case of an SSTP instruction only, writing and deletion of a single instruction is possible for a program with a step ladder area.
	JP/ LOOP/LBL	Be sure to write the instruction for setting the loop number before LBL-LOOP instructions.	Write in the order: JP-LBL or LOOP-LBL Delete in the order: LBL-JP or LBL-LOOP

12.6 Processing During Forced Input and Output

12.6.1 Processing When Forced Input/Output is Initiated During RUN

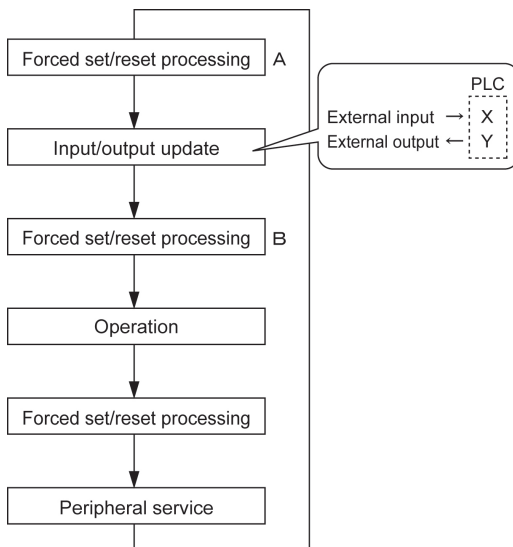

1. Processing of external input (X)

- Regardless of the state of the input from the input device, forced on/off operation will take precedence at a contact specified for forced input/output in the above procedure B. At this time, the input LED will not blink, however, the area of input X in the operation memory will be rewritten.
- As for contacts not specified, the on/off state will be read according to the input status from the input device.

2. Processing of external output (Y)

- Regardless of the state of the result of operation, forced on/off will take precedence at a contact specified for forced input/output in the above procedure A. At this time, the area of output Y in the operation memory will be forcibly rewritten. External output will take place according to the input/output update timing in the above diagram.
- The on/off state of contacts not specified will be determined by the operation result.

3. Processing of Timer (T) and Counter (C)

- Regardless of the timer/counter input condition, forced on/off operation will take precedence at a contact specified for forced input/output. At this time, the contact of the timer (T) or counter (C) in the operation memory will be rewritten. Timing and counting will not take place during control.
- The on/off state of contacts not specified will be determined by the operation result.

Operation during operation

For small-sized PLCs FP0, FP0R, FPΣ and FP-X

The internal relay R or output Y specified by OT or KP instruction is rewritten according to the results of operation. However, as the R or Y is set/reset again right before the peripheral service (as the above procedure C), the monitoring value with the tooling software or the output to external devices is forcibly rewritten to a specified value.

For medium-sized PLCs FP2, FP2SH

For the internal relay R and output Y specified by OT or KP instruction, the value of the forced processing has a priority. When rewritten by a high-level instruction, the result of the instruction has a priority.

Chapter 13

Specifications

13.1 Table of Specifications

13.1.1 General Specifications

Item	Description		
Rated operating voltage	24 V DC		
Operating voltage range	20.4 to 28.8 V DC		
Allowable momentary power off time	C10, C14, C16: 5 ms(at 20.4 V), 10 ms(at 21.6 V)		
	C32, T32, F32 : 10 ms(at 20.4 V)		
Fuse	Built-in (Not replaceable)		
Ambient temperature	0 to +55 °C		
Storage temperature	-40 to +70 °C (T32 only: -20 to +70 °C)		
Ambient humidity	10 to 95 % RH (at 25 °C, No condensation)		
Storage humidity	10 to 95 % RH (at 25 °C, No condensation)		
Breakdown voltage (Detection current: 5 mA)		Tr output type	Ry output type
	Between "input terminals" and "output terminals"	500 V AC for 1 minute	1500 V AC for 1 minute
	Between "output terminals" and "output terminals" (Between different commons)	-	1500 V AC for 1 minute
	Between "input terminals" and "power/ground terminals"	500 V AC for 1 minute	500 V AC for 1 minute
	Between "output terminals" and "power/ground terminals"	500 V AC for 1 minute	1500 V AC for 1 minute
	Between "ground terminal" and "power terminal"	500 V AC for 1 minute	500 V AC for 1 minute
Insulation resistance (Test voltage: 500 V DC)		Tr output type	Ry output type
	Between "input terminals" and "output terminals"	Over 100 MΩ	Over 100 MΩ
	Between "output terminals" and "output terminals" (Between different commons)	-	Over 100 MΩ
	Between "input terminals" and "power/ground terminals"	Over 100 MΩ	Over 100 MΩ
	Between "output terminals" and "power/ground terminals"	Over 100 MΩ	Over 100 MΩ
Vibration resistance	5 to 9 Hz, Single amplitude of 3.5 mm, 1 sweep/min., 9 to 150 Hz, Constant acceleration of 9.3 m/s ² , 1 sweep/min., 10 min. on 3 axes (Towards X,Y & Z directions)		
	Shock resistance		
	147 m/s ² , 4 times on 3 axes (Towards X,Y & Z directions)		
	Noise immunity		
	1000 V[P-P] with pulse width 50 ns, 1μs (using a noise simulator) (Power supply terminal)		
Operating condition	Must be free from corrosive gases and excessive dust		
Overvoltage category	Category II		
Pollution level	Pollution level 2		
Weight	C10:100g, C14:105g, C16:85g, C32:115g, T32:120g, F32:115g E16T/P, E16X : 65g, E16YT/P: 70g, E32T/P: 80g, E8X: 60g, E8YT/P: 60g, E8RS/M: 90g, E16RS/M: 100g, E8YRS: 95g		

Unit's current consumption table

		Control unit current consumption	Expansion unit current consumption	Input circuit current consumption	Output circuit current consumption
		This is the current consumed from the control unit power supply connector. If expansion units or intelligent units are added, the current is increased by the value indicated below.	This is the current consumed from the expansion unit power supply connector. If a unit is not listed below, it means that it has no power supply connector	This is the current consumed by the input circuits of the various units. This value indicates the current that flows into the input circuit.	This is the current consumed by the output circuits of the various units. This value indicates the current used to drive the output circuits. This value does not include the load current value.
FP0R control unit	FP0R-C10	100 mA or less	–	15.9 mA or less	–
	FP0R-C14	120 mA or less	–	21.1 mA or less	–
	FP0R-C16	70 mA or less	–	21.1 mA or less	20 mA or less
	FP0R-C32 FP0R-T32 FP0R-F32	90 mA or less	–	42.2 mA or less	40 mA or less
FP0/FP0R expansion unit	FP0-E8X	10 mA or less	–	37.6 mA or less	–
	FP0-E8R	10 mA or less	50 mA or less	18.8 mA or less	–
	FP0-E8YR	10 mA or less	100 mA or less	–	–
	FP0-E8YT/P	15 mA or less	–	–	26 mA or less
	FP0-E16X	10 mA or less	–	75.2 mA or less	–
	FP0-E16R	20 mA or less	100 mA or less	37.6 mA or less	–
	FP0-E16T/P	20 mA or less	–	37.6 ma or less	26 mA or less
	FP0-E16YT/P	25 mA or less	–	–	52 mA or less
FP0 intelligent unit	FP0-E32T/P	35 mA or less	–	75.2 mA or less	52 mA or less
	FP0-A21	20 mA or less	100 mA or less	–	–
	FP0-A80	20 mA or less	60 mA or less	–	–
	FP0-A04V	20 mA or less	100 mA or less	–	–
	FP0-A04I	20 mA or less	130 mA or less	–	–
	FP0-TC4 FP0-TC8 FP0-RTD6	25 mA or less	–	–	–
	FP0-IOL	30 mA or less	40 mA or less	–	–
	FP0-CCLS	40 mA or less	40 mA or less	–	–
Programmable display (5 VDC, RS232C type)		80 mA or less	–	–	–
C-NET adapter S2	AFP15402	50 mA or less	–	–	–

13.1.2 Control Specifications

Item		C10, C14	C16	C32	T32	F32
Programming method		Relay symbol				
Control method		Cyclic operation				
Program memory	Built-in memory	Flash ROM				
	Memory capacity	16000 steps		32000 steps		
	Rewriting during RUN	Available (Simultaneous rewriting capacity: 512 steps)				
	Download during RUN	Available (All programs)				
Security function		Password function (4-digit, 8-digit), Read protection setting				
Comment memory	Memory capacity	328 kbytes (All comments including I/O comments, annotations, interlinear comments)				
	Download during RUN	Available (All comments)				
I/O update time & base time		Without expansion units: 0.2 ms or less With expansion units: 0.2 ms or less + (1×the number of expansion unit) ms				
Operation speed	Up to 3k steps	Basic instruction: from 0.08 μs, Timer instruction: 2.2 μs, High-level instruction: from 0.32μs (MV instruction)				
	After 3k steps	Basic instruction: from 0.58 μs, Timer instruction: 3.66 μs, High-level instruction: from 1.62μs (MV instruction)				
Basic instruction		Approx. 110 types				
High-level instruction		Approx. 210 types				
External input (X)		1760 points				
External output (Y)		1760 points				
Internal Relay (R)		4096 points				
Special Internal Relay(R)		224 points				
Link Relay (L)		2048 points				
Timer/Counter (T/C)		1024 points (Factory default: Timer 1008 points: T0 to T1007, Counter 16 points: C1008 to C1023)				
Data register(DT)		12315 words		32765 words		
Special data register(DT)		440 words (DT90000 to DT90443)				
Link data register (LD)		256 words				
Index register (I0 to ID)		14 words				
Master control relay(MCR)		256 points				
Number of labels (JMP, LOOP)		256 labels				
Differential points		Number of points that is within the program capacity				
Number of step ladder		1000 stages				
Number of subroutines		500 subroutines				
Sampling trace		Available Sampling by commands/Sampling at regular time intervals For one sampling: 16 bits + 3 words C10/C14/C16=300 samples C32/T32/F32=1000 samples				
High speed counter (HSC)		At single phase 6 points (Max. 50 kHz) or second phase 3 points (Max. 15 kHz) ^{*1}				
Pulse output		- 4 points (Max. 50 kHz) ^{*1*2}				
PWM output		- 4 points (Max. 4.8 kHz) ^{*1*2}				
Pulse catch input		8 points in total (including HSC and interrupt input)				
Interrupt program		Input: 8 programs (C10 only. Input: 6 programs) Periodical: 1 program Pulse match: 4 programs				
Periodical interrupt		0.5 ms unit: 0.5 ms to 1.5 s/10 ms unit: 10 ms to 30 s				
Constant scan		0.5 ms unit: 0.5 ms to 600 ms				

Item		C10, C14	C16	C32	T32	F32
Flash ROM Backup *3	Backup by F12, P13 Instruction	All areas *4				
	Auto backup when power is OFF *4	Counter: 16 points Internal relay: 128 points Data register : 315 words				-
RAM backup		-			All areas *5 (Built-in backup battery) *6	All areas *5
Clock/Calendar *7		-			Available	-
Communication port		Tool port/USB port/COM port				
Self-diagnosis functions		Watchdog timer (Approx. 690 ms), program syntax checking				

*1) The specification is when rated input voltage is at 24 V DC and temperature at 25 °C.

Frequency may decrease depending on voltage, temperature or operating condition.

*2) No. of channels: A total of 4 channels is available for pulse output and PWM output.

Frequency: Pulse output can be specified up to 50 kHz. PWM output can be specified up to 4.8 kHz.

An error on the pulse width that is a maximum of 40µs may occur for the setting value depending on voltage, temperature or operating condition.

*3) Guaranteed number of writing is up to 10000 times.

*4) Auto backup area when power is off

Type C10, C14, C16

C32, T32

Backup area C1008 to 1023 (C: Contact, EV: Elapsed value)

C1008 to 1023 (C: Contact, EV: Elapsed value)

R2480 to 255F

R2480 to 255F

DT12000 to 12314

DT32450 to 32764

*5) All the areas of timer/counter, internal relays, link relays, link registers and data registers can be held. Non-hold areas and hold areas can be specified by the setting of system register.

*6) Notes about built-in backup battery (T32 only)

Secondary battery is used for this product.

It has not been charged when it is shipped from the factory. Energize and charge it before you use it.

The secondary battery does not have a function to notify the battery voltage reduction. However, if the battery is out of charge and the hold area becomes indefinite, the values in the hold areas will be cleared to 0 when the power is turned on next time.

(We recommend to add a program for clearing the data to 0 when the values in hold areas become indefinite.)

- Relation between charging time and backup time

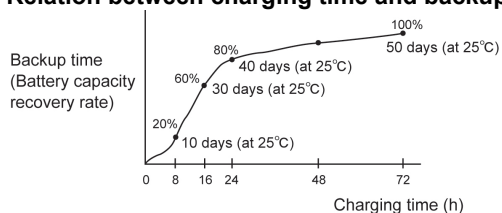

- Backup time

When ambient temperature is 70 °C: 14 days

When ambient temperature is 25 °C: 50 days

When ambient temperature is -20 °C: 25 days

- Predicted backup life

When ambient temperature is 55 °C: 430 days

When ambient temperature is 45 °C: 1200 days

When ambient temperature is 40 °C: 2100 days

When ambient temperature is 35 °C: 3300 days

When ambient temperature is 34 °C or lower: 10 years

(The temperature when the power is off has little influence on the battery life.)

*7) Precision of Clock/Calendar (T32 only):

When ambient temperature is 0 °C: Less than 104 seconds per month

When ambient temperature is 25 °C: Less than 51 seconds per month

When ambient temperature is 55 °C: Less than 155 seconds per month

13.1.3 Communication Specifications

Tool port

	Description
Interface	RS232C
Transmission distance	15 m
Baud rate	2400,4800,9600,19200,38400,57600,115200 bit/s
Communication method	Half-duplex operation
Synchronous method	Asynchronous communication method
Transmission format	Data length 7 bits / 8 bits
	Parity: None/Even/Odd
	Start code: STX / No STX
	End code: CR / CR+LF / None / ETX
	Stop bit: 1 bit / 2 bits
Order of data transmission	Transmits from bit 0 character by character.
Communication function	Computer link (Slave) Modem initialization General-purpose communication (In the RUN mode only)

USB port

	Description
Standard (Baud rate)	USB2.0 Fullspeed
Communication mode	Computer link (Slave)

COM port (RS232C port)

	Description
Interface	RS232C
Transmission distance	15 m
Baud rate	2400,4800,9600,19200,38400,57600,115200 bit/s
Communication method	Half-duplex communication
Synchronous method	Start stop synchronous system
Communication format	Data length: 7 bits/8bits
	Parity: None/Even/Odd
	Start code: STX/No STX
	End code: CR/CR+LF/None/ETX
	Stop bit: 1 bit/2 bits
Order of data transmission	Transmits from bit 0 character by character.
Communication function	Computer link (Master/Slave) Modem initialization General-purpose communication MODBUS RTU (Master/Slave) PC(PLC) link (A maximum of 16 units can be connected by converting to RS485.)

Factory default

	Baud rate	Data length	Parity	Stop bit
Tool port	9600 bit/s	8 bits	Odd	1 bit
COM port (RS232C port)	9600 bit/s	8 bits	Odd	1 bit

COM port (RS485 port)

Item	Description	
Interface	RS485	
Communication mode	1:N communication	
Transmission distance	Max. 1200 m ^{Note1) 2)}	
Baud rate	19200, 115200 bps ^{Note2) 3))}	
Communication method	Two-wire, half-duplex transmission	
Synchronous method	Start stop synchronous system	
Transmission line	Shielded twisted-pair cable or VCTF	
Transmission code	Computer link	ASCII
	General-purpose serial communication	ASCII, Binary
	MODBUS RTU	Binary
Communication format (to be set by system register) ^{Note4)}	Data length	7 bits/8bits
	Parity	7 bits/8bits
	Stop bit	None/Even/Odd
	Start code	STX/No STX
	End code	CR/CR+LF/None/ETX
No. of connected units ^{Note2) 5)}	Transmits from bit 0 character by character.	
Communication function	Computer link (Master/Slave) Modem initialization General-purpose communication MODBUS RTU (Master/Slave) PC(PLC) link	

Note1) When connecting a commercially available device that has an RS485 interface, please confirm operation using the actual device. In some cases, the number of units, transmission distance, and baud rate vary depending on the connected device.

Note2) The values for the transmission distance, baud rate and number of units should be within the values noted in the graph below.

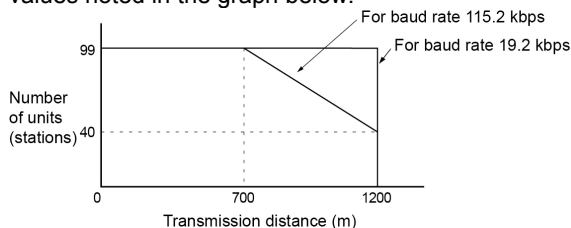

Note3) The settings of the baud rate switches on the side of the unit and the system register No. 415 should be the same. Only 19200 bps can be specified when the C-NET adapter is connected with the RS485 interface.

Note4) The start code and end code can be used only in the general-purpose serial communication mode.

Note5) Unit numbers should be registered by the system register.

Factory default

Port type	Baud rate	Data length	Parity	Stop bit
Tool port	9600 bit/s	8 bits	Odd	1 bit
COM port (RS485 port)	115200 bit/s	8 bits	Odd	1 bit



Note:

If the potential difference between the power supplies of RS485 devices exceeds 4 V, the unit may not communicate as it is the non-isolated type. The large potential difference leads to the damage to the devices.

13.2 I/O Number Allocation

13.2.1 I/O Numbers for FP0R Control Unit

The I/O allocation for the FP0R control unit is fixed.

Unit type	Allocation points	I/O No.
C10	Input: 6 points	X0 to X5
	Output: 4 points	Y0 to Y3
C14	Input: 8 points	X0 to X7
	Output: 6 points	Y0 to Y5
C16	Input: 8 points	X0 to X7
	Output: 8 points	Y0 to Y7
C32/T32/F32	Input: 16 points	X0 to XF
	Output: 16 points	Y0 to YF

13.2.2 I/O Numbers for FP0 Expansion Unit

- I/O numbers do not need to be set as I/O allocation is performed automatically by the PLC when an expansion I/O unit is added.
- The I/O allocation for expansion units is determined by the installation location.

Unit type		Allocation points	Expansion unit 1	Expansion unit 2	Expansion unit 3
FP0/FP0R expansion unit	E8X	Input: 8 points	X20 to X27	X40 to X47	X60 to X67
	E8R	Input: 4 points	X20 to X23	X40 to X43	X60 to X63
		Output: 4 points	Y20 to Y23	Y40 to Y43	Y60 to Y63
	E8YT/P E8YR	Output: 8 points	Y20 to Y27	Y40 to Y47	Y60 to Y67
	E16X	Input: 16 points	X20 to X2F	X40 to X4F	X60 to X6F
	E16R	Input: 8 points	X20 to X27	X40 to X47	X60 to X67
		Output: 8 points	Y20 to Y27	Y40 to Y47	Y60 to Y67
	E16YT/P	Output: 16 points	Y20 to Y2F	Y40 to Y4F	Y60 to Y6F
E32T/P	Input: 16 points	X20 to X2F	X40 to X4F	X60 to X6F	
	Output: 16 points	Y20 to Y2F	Y40 to Y4F	Y60 to Y6F	
FP0 analog I/O unit	FP0-A21	Input: 16 points (ch0)	WX2 (X20 to X2F)	WX4 (X40 to X4F)	WX6 (X60 to X6F)
		Input: 16 points (ch1)	WX3 (X30 to X3F)	WX5 (X50 to X5F)	WX7 (X70 to X7F)
		Output: 16 points	WY2 (Y20 to Y2F)	WY4 (Y40 to Y4F)	WY6 (Y60 to Y6F)
FP0 A/D converter unit FP0 thermocouple unit	FP0-A80 FP0-TC4 FP0-TC8	Input: 16 points (ch0, 2, 4, 6)	WX2 (X20 to X2F)	WX4 (X40 to X4F)	WX6 (X60 to X6F)
		Input: 16 points (ch1, 3, 5, 7)	WX3 (X30 to X3F)	WX5 (X50 to X5F)	WX7 (X70 to X7F)
FP0 RTD unit	FP0-RTD	Input (16 points) CH0, 2, 4	WX2 (X20 to X2F)	WX4 (X40 to X4F)	WX6 (X60 to X6F)
		Input (16 points) CH1, 3, 5	WX3 (X30 to X3F)	WX5 (X50 to X5F)	WX7 (X70 to X7F)
		Output (16 points)	WY2 (Y20 to Y2F)	WY4 (Y40 to Y4F)	WY6 (Y60 to Y6F)
FP0 D/A converter unit	FP0-A04V FP0-A04I	Input: 16 points	WX2 (X20 to X2F)	WX4 (X40 to X4F)	WX6 (X60 to X6F)
		Output: 16 points (ch0, 2)	WY2 (Y20 to Y2F)	WY4 (Y40 to Y4F)	WY6 (Y60 to Y6F)
		Output: 16 points (ch1, 3)	WY3 (Y30 to Y3F)	WY5 (Y50 to Y5F)	WY7 (Y70 to Y7F)
FP0 I/O link unit	FP0-IOL	Input: 32 points	X20 to X3F	X40 to X5F	X60 to X7F
		Output: 32 points	Y20 to Y3F	Y40 to Y5F	Y60 to Y7F

- The data of each channel for FP0 A/D converter unit (FP0-A80), FP0 thermocouple unit (FP0-TC4/FP0-TC8), FP0 D/A converter unit (FP0-A04V/FP0-A04I) is switched and read/write using a program that includes the flag for switching converted data.
- Regarding FP0 CC-Link slave unit, please refer to the exclusive manual.

13.3 Relays, Memory Areas and Constants

	Item	Number of points and range of memory area available for use		Function
		C10, C14, C16	C32, T32, F32	
Relay	External input ^{Note1)} (X)	1760 points (X0 to X109F)		Turns on or off based on external input.
	External output ^{Note1)} (Y)	1760 points (Y0 to Y109F)		Externally outputs on or off state
	Internal relay ^{Note2)} (R)	4096 points (R0 to R255F)		Relay which turns on or off only within program.
	Link relay ^{Note2)} (L)	2048 points (L0 to L127F)		This relay is a shared relay used for PLC link.
	Timer ^{Note2)} (T)	1024 points (T0 to T1007/C1008 to C1023) ^{Note3)}		This goes on when the timer reaches the specified time. It corresponds to the timer number.
	Counter ^{Note2)} (C)			This goes on when the counter increments. It corresponds to the counter number.
	Special internal relay (R)	224 points (from R9000)		Relay which turns on or off based on specific conditions and is used as a flag.
Memory area	External input ^{Note1)} (WX)	110 words (WX0 to WX109)		Code for specifying 16 external input points as one word (16 bits) of data.
	External output ^{Note1)} (WY)	110 words (WY0 to WY109)		Code for specifying 16 external output points as one word (16 bits) of data.
	Internal relay ^{Note2)} (WR)	256 words (WR0 to WR255)		Code for specifying 16 internal relay points as one word (16 bits) of data.
	Link relay (WL)	128 words (WL0 to WL127)		Code for specifying 16 link relay points as one word (16 bits) of data.
	Data register ^{Note2)} (DT)	12315 words (DT0 to DT12314)	32765 words (DT0 to DT32764)	Data memory used in program. Data is handled in 16-bit units (one word).
	Link register ^{Note2)} (LD)	256 words (LD0 to LD255)		This is a shared data memory which is used within the PLC link. Data is handled in 16-bit units (one word).
	Timer/Counter set value area ^{Note2)} (SV)	1024 words (SV0 to SV1023)		Data memory for storing a target value of a timer and setting value of a counter. Stores by timer/counter number
	Timer/Counter elapsed value area ^{Note2)} (EV)	1024 words (EV0 to EV1023)		Data memory for storing the elapsed value during operation of a timer/counter. Stores by timer/counter number.
	Special data register (DT)	440 words (DT90000 to DT90439)		Data memory for storing specific data. Various settings and error codes are stored.
	Index register (I)	14 words (I0 to ID)		Register can be used as an address of memory area and constants modifier.
Control Instruction point	Master control relay points (MCR)	256 points		
	Number of labels (JP and LOOP)	256 points		
	Number of step ladders	1000 stages		
	Number of subroutines	500 subroutines		
	Number of interrupt programs	C10: 11 programs (6 external input points, 1 periodical interrupt point, 4-pulse match points) Other than C10: 13 programs (8 external input points, 1 periodical interrupt point, 4-pulse match points)		
Constant	Decimal constants (Integer type) (K)	K-32, 768 to K32, 767 (for 16-bit operation) K-2, 147, 483, 648 to K2, 147, 483, 647 (for 32-bit operation)		
	Hexadecimal constants (H)	H0 to HFFFF (for 16-bit operation) H0 to HFFFFFFFF (for 32-bit operation)		
	Floating point type (F)	F-1.175494 x 10 ⁻³⁸ to F-3.402823 x 10 ³⁸		
		F 1.175494 x 10 ⁻³⁸ to F 3.402823 x 10 ³⁸		

Note1) The number of points noted above is the number reserved as the calculation memory. The actual number of points available for use is determined by the hardware configuration.

Note2) There are two types, one is the hold type that the last state is stored even if the power supply turns off or the mode is changed to PROG. mode from RUN mode, and the other is the non-hold type that the state is reset. For C10/C14/C16/C32: The hold type areas and non-hold type areas are fixed. For information on the sections of each area, refer to the performance specifications.

For T32/F32: The settings of the hold type areas and non-hold type areas can be changed using the system registers.

On T32, if the battery has run out, the data in the hold area may be indefinite (Not cleared to 0)

Note3) The points for the timer and counter can be changed by the setting of system register 5. The number given in the table are the numbers when system register 5 is at its default setting.

13.4 Power Supply Unit and I/O Link Unit Specifications

13.4.1 Power Supply Unit Specifications (AFP0634)

Item		Description
Input	Rated operating voltage	100-240 V AC
	Operating voltage range	85-264 V AC
	Rated frequency	50/60 Hz
	Operating frequency	47 to 63 Hz
	The number of phase	Single phase
	Inrush current	30 A(0-p) or less (Cold start)
	Leakage current	0.75 mA or less
	Holding time	10 ms or more
Output	Rated voltage	24 V DC
	Voltage accuracy	±5%
	Rated current	0.7 A
	Operating output current	0 to 0.7 A
	Output ripple	500 mV or less
	Over current regulation	0.735 A or more
	Over voltage regulation	Possible
Life time	20000h (at 55 °C)	

13.4.2 I/O Link Unit Specifications (AFP0732)

Item	Description
Communication method	Two-wire half-duplex communication
Synchronous method	Start stop synchronous system
Transmission line	Duplex cable (twisted-pair cable or VCTF 0.75 mm ² x 2C <JIS> or equivalent)
Transmission distance (Total length)	Max. 700 m (when using twisted-pair cable) Max. 400 m (when using VCTF cable)
Baud rate	0.5Mbps
No. of I/O points per one I/O link unit	64 points (Input: 32 points + Output: 32 points) ^{Note)}
Remote I/O map allocation	32X/32Y
Interface	RS485-compliant
Transmission error check	CRC method

Note) Those numbers of points are the numbers that can be used for I/O link via a host computer and the network MEWNET-F. When setting the output of the I/O link error flag to ON (available), it is 63 points (31 input points & 32 input points).

Chapter 14

Dimensions and Others

14.1 Dimensions

14.1.1 C10/C14 Control Unit (Terminal Block)

■ FP0RC10CRS/14CRS ■ FP0RC10RS/14RS

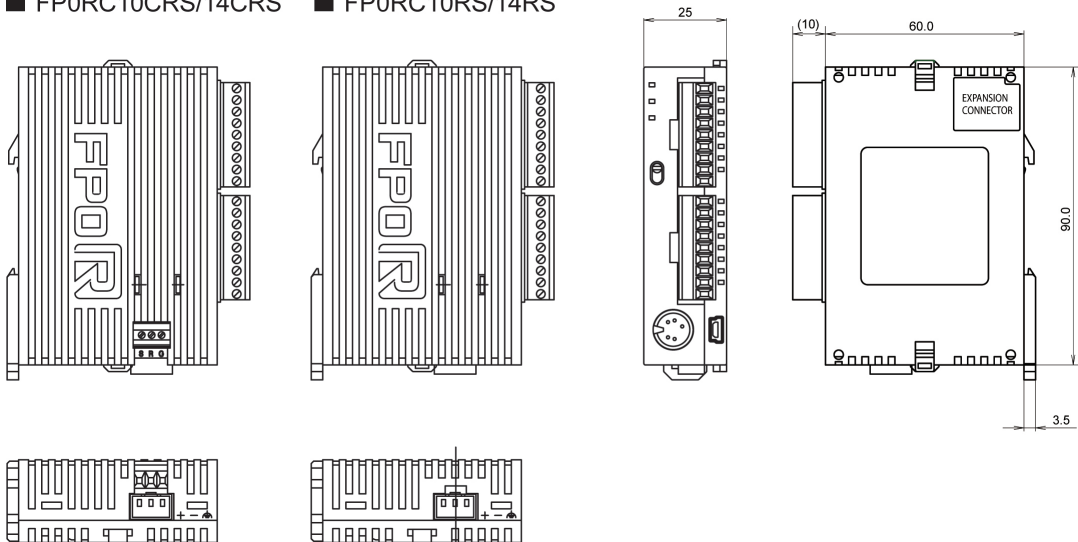

■ When mounting terminal block and power supply cable

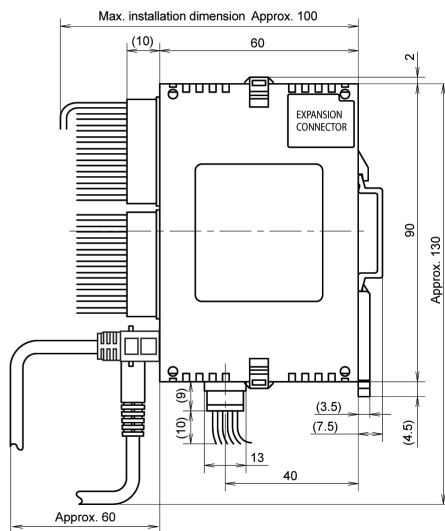

(Unit: mm)

Note) As for the expansion unit, refer to the dimensions only.
Target expansion units: E8RS, E16RS

14.1.2 C10/C14 Control Unit (Molex Connector)

■ FP0RC10CRM/14CRM ■ FP0RC10RM/14RM

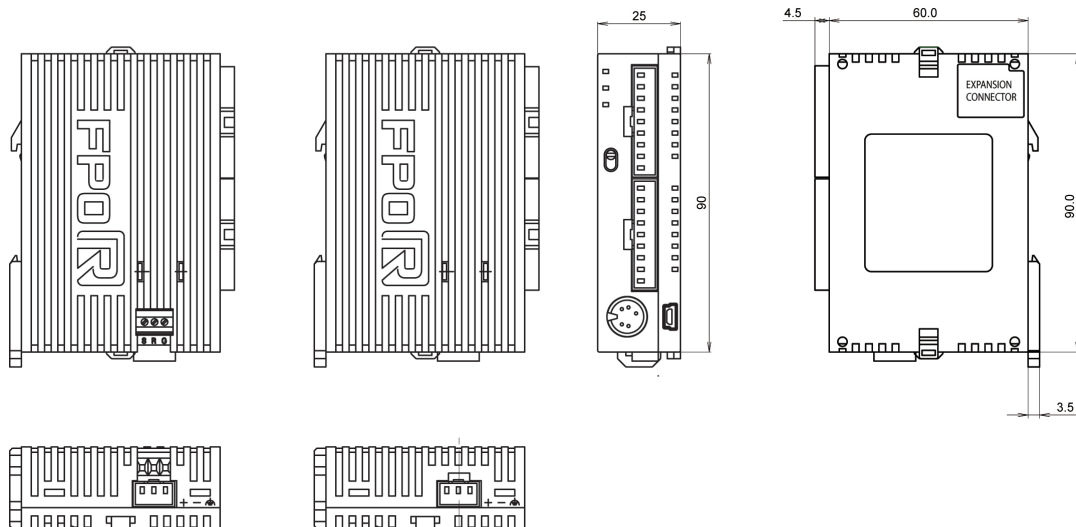

■ When mounting Molex connector and power supply cable

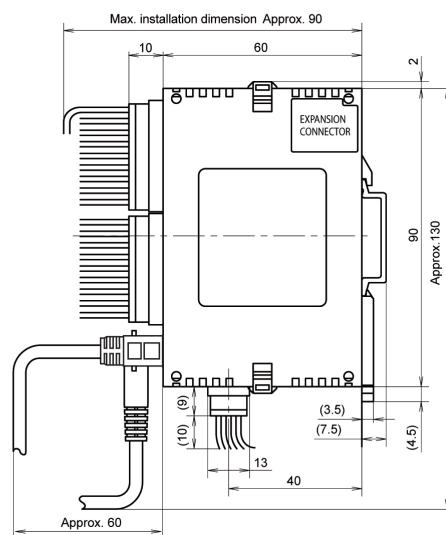

(Unit: mm)

Note) As for the expansion unit, refer to the dimensions only.
Target expansion units: E8RM,E16RM

14.1.3 C16 Control Unit (MIL Connector)

■ FP0RC16CT/P

■ FP0RC16T/P

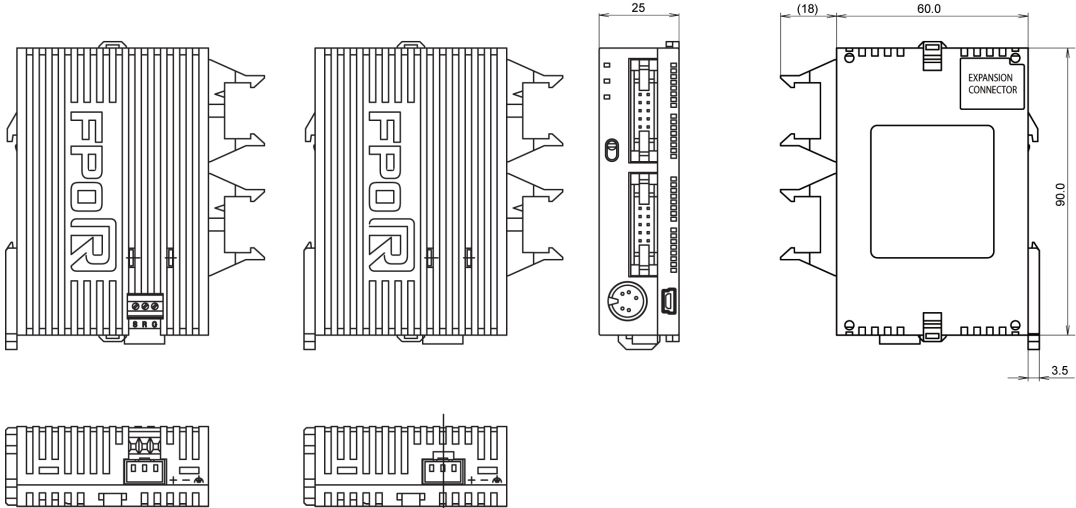

■ When mounting MIL connector and power supply cable

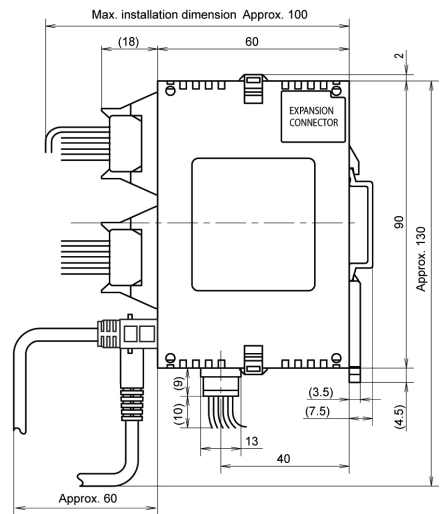

(Unit: mm)

Note) As for the expansion unit, refer to the dimensions only.

Target expansion units: E16X, E16YT, E16YP, E16T, E16P, E8X, E8YT, E8YP

14.1.4 C32/T32/F32 Control Unit (MIL Connector)

■ FP0RC32CT/P
 FP0RT32CT/P
 FP0RF32CT/P

■ FP0RC32T/P

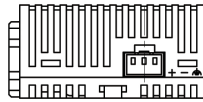
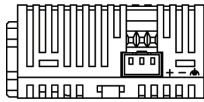
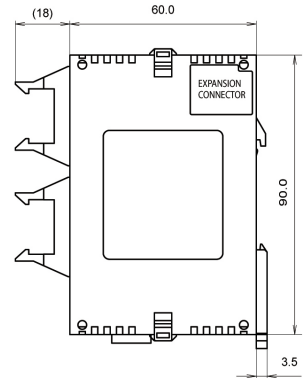
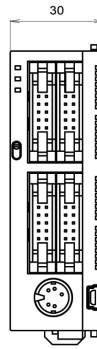
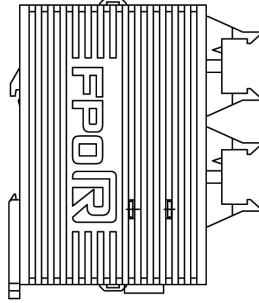
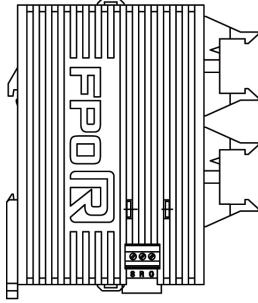

■ When mounting MIL connector and power supply cable

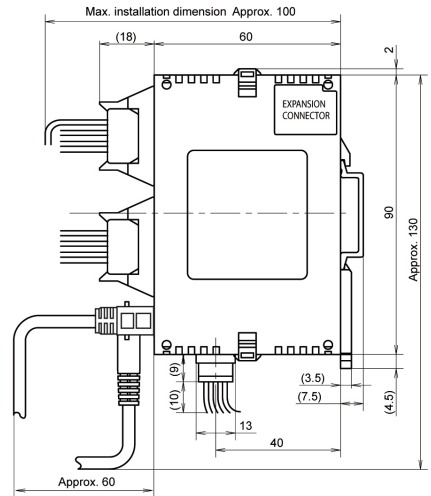

(Unit: mm)

Note) As for the expansion unit, refer to the dimensions only.
 Target FP0 expansion units: E32T, E32P

14.1.5 Power Supply Unit

■ Power supply unit FP0-PSA4

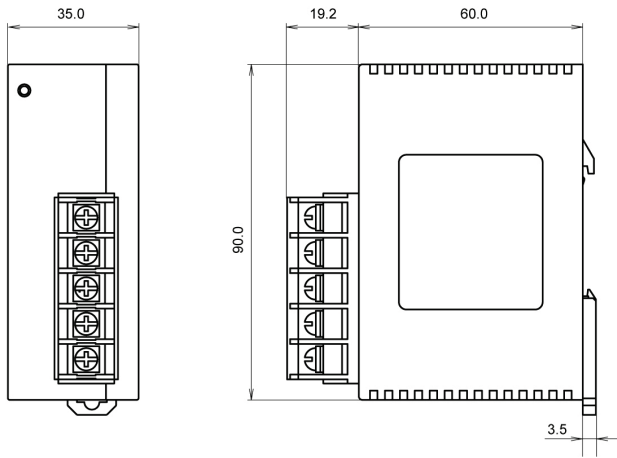

(Unit: mm)

14.1.6 I/O Link Unit

■ I/O link unit (AFP0732)

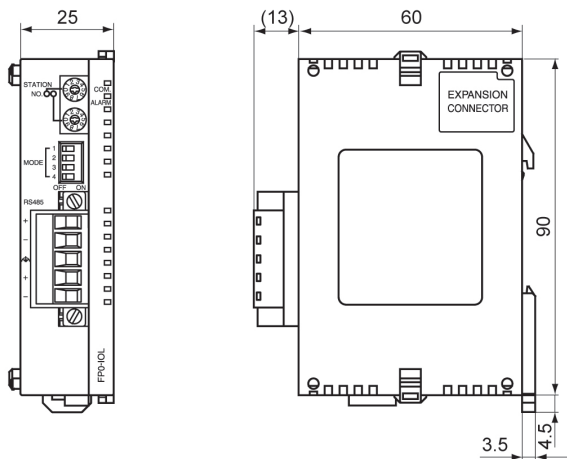

(Unit: mm)

14.1.7 When Using DIN Rail

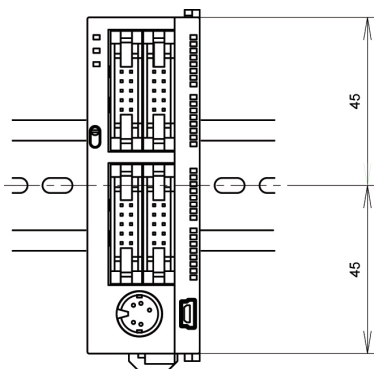

(Unit: mm)

14.2 Cable/Adapter Specifications

14.2.1 AFC8503/AFC8503S (PC connection cable)

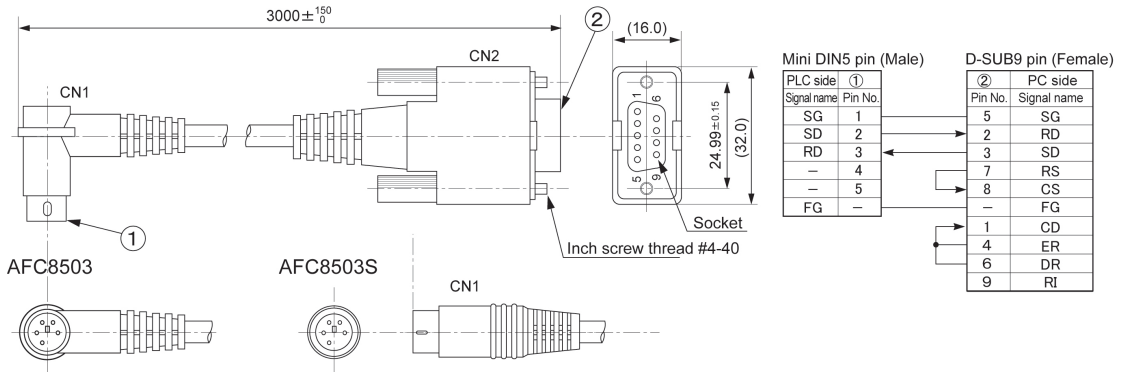

(Unit: mm)

14.2.2 AFC85305/AFC8531/AFC8532 (For extending for the tool port)

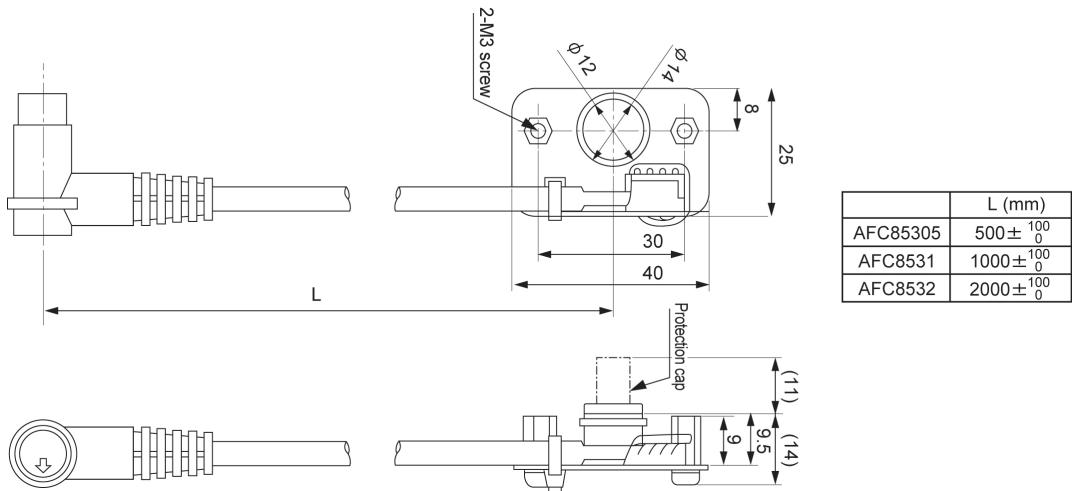

(Unit: mm)

Chapter 15

Appendix

15.1 System Registers / Special Internal Relays / Special Data Registers

Precaution for System Registers

What is the system register area

- System registers are used to set values (parameters) which determine operation ranges and functions used. Set values based on the use and specifications of your program.
- There is no need to set system registers for functions which will not be used.

Type of system registers

The registers to be used depend on each PLC.

1. Allocation of timers and counters (System registers 5)

The number of timers and counters is set by specifying the starting counter number.

2. Hold/non-hold type setting (System registers 6 to 13)

When these registers are set to "hold type", the values in the relays and data memory will be retained even if the system is switched to PROG. mode or the power is turned off. If set to "non-hold type" the values will be cleared to "0".

3. Operation mode setting on error (System registers 20, 23 and 26)

Set the operation mode when errors such as battery error, duplicated use of output, I/O verification error and operation error occur.

4. Time settings (System registers 31 to 34)

Set time-out error detection time and the constant scan time.

5. MEWNET-W0 PC(PLC) link settings (System registers 40 to 47, 50 to 55, and 57)

These settings are for using link relays and link registers for MEWNET-W0 PC(PLC) link communication. Note) The default value setting is "no PC(PLC) link communication".

6. Input settings (System registers 400 to 405)

When using the high-speed counter function, pulse catch function or interrupt function, set the operation mode and the input number to be used for the function.

7. Tool and COM ports communication settings (System registers 410 to 421)

Set these registers when the Tool port and COM ports are to be used for computer link, general-purpose serial communication, PC(PLC) link, and modem communication.

8. Input time constant settings (System registers 430 to 433)

Changing the input signal width to be loaded enables to prevent the malfunctions caused by chattering or noises.

Checking and changing the set value of system register

If you are going to use a value which is already set (the value which appears when read), there is no need write it again.

Using programming tool software

Produce:

1. Set the control unit in the PROG mode.
2. Option -> PLC Configuration
3. When the function for which setting are to be entered is selected in the PLC Configuration dialog box, the value and setting status for the selected system register are displayed.
To change the value and setting status, write in the new value and /or select the setting status.
4. To register these settings, choose OK

Precautions for system register setting

-System register settings are effective from the time they are set.

However, input settings, tool port, COM port, and modem connection settings become effective when the mode is changed from PROG. to RUN. With regard to the modem connection setting, when the power is turned off and on or when the mode is changed from PROG. to RUN, the controller sends a command to the modem which enables it for reception.

-When the initialized operation is performed, all set system register values (parameters) will be initialized

15.1.1 Table of System Registers for FP0R

	No.	Name	Default value	Descriptions
Hold/ Non-hold 1	5	Starting number setting for counter	1008	0 to 1024
	6	Hold type area starting number setting for timer and counter (T32/F32)	1008	0 to 1024
	7	Hold type area starting number setting for internal relays (T32/F32)	248	0 to 256
	8	Hold type area starting number setting for data registers (T32/F32)	0	0 to 32765
	14	Hold or non-hold setting for step ladder process (T32/F32)	Non-hold	Hold/Non-hold
	4	Previous value is held for a leading edge detection instruction (DF instruction) with MC ^{Note)}	Hold	Hold/ Non-hold
Hold/ Non-hold 2	10	Hold type area starting word number for PC(PLC) link relays (for PC(PLC) link 0) (T32/F32)	0	0 to 64
	11	Hold type area starting word number for PC(PLC) link relays (for PC(PLC) link 1) (T32/F32)	64	64 to 128
	12	Hold type area starting number for PC(PLC) link registers (for PC(PLC) link 0) (T32/F32)	0	0 to 128
	13	Hold type area starting number for PC(PLC) link registers (for PC(PLC) link 1) (T32/F32)	128	128 to 256
Action on error	20	Disable or enable setting for duplicated output	Disabled	Disabled/Enabled
	23	Operation setting when an I/O verification error occurs	Stop	Stop/Continuation of operation
	26	Operation setting when an operation error occurs	Stop	Stop/Continuation of operation
Time setting	31	Wait time setting for multi-frame communication	6500.0 ms	10 to 81900 ms
	32	Communication timeout setting for SEND/RECV, RMRD/RMWT commands	10000.0 ms	10 to 81900 ms
	34	Constant value settings for scan time	Normal scan	0: Normal scan 0 to 600 ms: Scans once each specified time interval

	No.	Name	Default value	Descriptions
PC (PLC) link 0 setting	40	Range of link relays used for PC(PLC) link	0	0 to 64 words
	41	Range of link data registers used for PC(PLC) link	0	0 to 128 words
	42	Starting word number for link relay transmission	0	0 to 63
	43	Link relay transmission size	0	0 to 64 words
	44	Starting number for link data register transmission	0	0 to 127
	45	Link data register transmission size	0	0 to 127 words
	46	PC(PLC) link switch flag	Normal	Normal/reverse
PC (PLC) link 1 setting	47	Maximum unit number setting for MEWNET-W0 PC(PLC) link	16	1 to 16
	50	Range of link relays used for PC(PLC) link	0	0 to 64 words
	51	Range of link data registers used for PC(PLC) link	0	0 to 128 words
	52	Starting word number for link relay transmission	64	64 to 127
	53	Link relay transmission size	0	0 to 64 words
	54	Starting number for link data register transmission	128	128 to 255
	55	Link data register transmission size	0	0 to 127 words
57	Maximum unit number setting for MEWNET-W0 PC(PLC) link	16	1 to 16	

		No.	Name	Default value	Descriptions		
Controller input settings 1	High-speed counter	400	High-speed counter operation mode settings (X0 to X2)	CH0: Do not set input X0 as high-speed counter	CH0	Do not set input X0 as high-speed counter. Two-phase input (X0, X1) Two-phase input (X0, X1), Reset input (X2) Incremental input (X0) Incremental input (X0), Reset input (X2) Decremental input (X0) Decremental input (X0), Reset input (X2) Individual input (X0, X1) Individual input (X0, X1), Reset input (X2) Incremental/decremental control input (X0, X1) Incremental/decremental control input (X0, X1), Reset input (X2)	
				CH1: Do not set input X1 as high-speed counter		CH1	Do not set input X1 as high-speed counter. Incremental input (X1) Incremental input (X1), Reset input (X2) Decremental input (X1) Decremental input (X1), Reset input (X2)
		400	High-speed counter operation mode settings (X3 to X5)	CH2: Do not set input X3 as high-speed counter	CH2	Do not set input X3 as high-speed counter. Two-phase input (X3, X4) Two-phase input (X3, X4), Reset input (X5) Incremental input (X3) Incremental input (X3), Reset input (X5) Decremental input (X5) Decremental input (X5), Reset input (X5) Individual input (X3, X4) Individual input (X3, X4), Reset input (X5) Incremental/decremental control (X3, X4) Incremental/decremental control (X3, X4), Reset input (X5)	
				CH3: Does not set input X4 as high-speed counter		CH3	Does not set input X4 as high-speed counter. Incremental input (X4) Incremental input (X4), Reset input (X5) Decremental input (X4) Decremental input (X4), Reset input (X5)
	Controller input settings 2	High-speed counter	401	High-speed counter/pulse output settings (X6 to X7)	CH4: Do not set input X6 as high-speed counter	CH4	Do not set input X6 as high-speed counter. Incremental input (X6) Decremental input (X6) Two-phase input (X6, X7) Individual input (X6, X7) Incremental/decremental control input (X6, X7)
					CH5: Do not set input X7 as high-speed counter		CH5

Note1) If the operation mode is set to Two-phase, incremental/decremental, or incremental/decremental control, the setting for CH1 or CH3 is invalid in system register 400 and the setting for CH5 is invalid in system register 401.

Note2) If reset input settings overlap, the CH1 setting takes precedence in system register 400 and the CH3 setting takes precedence in system register 401.

Note3) If system register 400 to 403 have been set simultaneously for the same input relay, the following precedence order is effective: [High-speed counter]→[Pulse catch]→[Interrupt input].

<Example>

When the high-speed counter is being used in the addition input mode, even if input X0 is specified as an interrupt input or as pulse catch input, those settings are invalid, and X0 functions as counter input for the high-speed counter.

		No.	Name	Default value	Descriptions																		
Transistor type C16 or over	Controller output settings 2 (PLS/PWM)	402	Pulse/ PWM output settings (Y0 to Y7)	CH0: Normal output	Normal output (Y0, Y1) Pulse output (Y0, Y1) Pulse output (Y0, Y1)/Home input X4 Pulse output (Y0, Y1)/Home input X4/Position control starting input X0 PWM output (Y0), Normal output (Y1)																		
				CH1: Normal output	Normal output (Y2, Y3) Pulse output (Y2, Y3) Pulse output (Y2, Y3)/Home input X5 Pulse output (Y3, Y4)/Home input X5/Position control starting input X1 PWM output (Y2), Normal output (Y3)																		
				CH2: Normal output	Normal output (Y4, Y5) Pulse output (Y4, Y5) Pulse output (Y4, Y5)/Home input X6 Pulse output (Y4, Y5)/Home input X6/Position control starting input X2 PWM output (Y4), Normal output (Y5)																		
				CH3: Normal output	Normal output (Y6, Y7) Pulse output (Y6, Y7) Pulse output (Y6, Y7)/Home input X7 Pulse output (Y6, Y7)/Home input X7/Position control starting input X3 PWM output (Y6), Normal output (Y7)																		
Inter- rupt/ Pulse catch settings		403	Pulse catch input settings	Not set	<div style="text-align: center;">X0 X1 X2 X3 X4 X5 X6 X7</div> Controller input <table border="1" style="display: inline-table; border-collapse: collapse;"><tr><td style="width: 20px; height: 15px;"></td><td style="width: 20px; height: 15px;"></td><td style="width: 20px; height: 15px;"></td><td style="width: 20px; height: 15px;"></td><td style="width: 20px; height: 15px;"></td><td style="width: 20px; height: 15px;"></td><td style="width: 20px; height: 15px;"></td><td style="width: 20px; height: 15px;"></td><td style="width: 20px; height: 15px;"></td></tr></table> The pressed contact is set for the pulse catch.																		
404	Interrupt input settings	Not set	<div style="text-align: center;">X0 X1 X2 X3 X4 X5 X6 X7</div> Controller input <table border="1" style="display: inline-table; border-collapse: collapse;"><tr><td style="width: 20px; height: 15px;"></td><td style="width: 20px; height: 15px;"></td><td style="width: 20px; height: 15px;"></td><td style="width: 20px; height: 15px;"></td><td style="width: 20px; height: 15px;"></td><td style="width: 20px; height: 15px;"></td><td style="width: 20px; height: 15px;"></td><td style="width: 20px; height: 15px;"></td><td style="width: 20px; height: 15px;"></td></tr></table> The pressed contact is set for the interrupt input.																				
Inter- rupt edge settings		405	Interrupt edge setting for controller input	Leading edge	<div style="text-align: center;">X0 X1 X2 X3 X4 X5 X6 X7</div> Leading edge <table border="1" style="display: inline-table; border-collapse: collapse;"><tr><td style="width: 20px; height: 15px;"></td><td style="width: 20px; height: 15px;"></td><td style="width: 20px; height: 15px;"></td><td style="width: 20px; height: 15px;"></td><td style="width: 20px; height: 15px;"></td><td style="width: 20px; height: 15px;"></td><td style="width: 20px; height: 15px;"></td><td style="width: 20px; height: 15px;"></td><td style="width: 20px; height: 15px;"></td></tr></table> <div style="text-align: center;">X0 X1 X2 X3 X4 X5 X6 X7</div> Trailing edge <table border="1" style="display: inline-table; border-collapse: collapse;"><tr><td style="width: 20px; height: 15px;"></td><td style="width: 20px; height: 15px;"></td><td style="width: 20px; height: 15px;"></td><td style="width: 20px; height: 15px;"></td><td style="width: 20px; height: 15px;"></td><td style="width: 20px; height: 15px;"></td><td style="width: 20px; height: 15px;"></td><td style="width: 20px; height: 15px;"></td><td style="width: 20px; height: 15px;"></td></tr></table> The pressed contact is up and set to trailing edge.																		

Note1) When using the pulse output/PWM output, the controller output settings must be specified.
The output that has been set to the pulse output/PWM output cannot be used as the normal output.

Note2) X4 to X7 can be used as the home input of the pulse output CH0 to CH3.
When using the home return function of the pulse output, always set the home input. In that case, X4 to X7 cannot be set as the high-speed counter.

Note3) C16 type:
 - For performing the home return for the pulse output CH0 with deviation counter clear, the above Y6 should be set to the normal output to use Y6 for the deviation counter clear signal.
 - For performing the home return for the pulse output CH1 with deviation counter clear, the above Y7 should be set to the normal output to use Y7 for the deviation counter clear signal.
 - The home return cannot be performed for the pulse output CH2 with deviation counter clear.

Note4) C32/T32/F32 type:
 When performing the home return with deviation counter clear, the deviation counter clear signals corresponding to each CH are used fixedly as follows; CH0=Y8, CH1=Y9, CH2=YA, CH3=YB
 For performing the home return for each type,
 it is necessary to specify the home input corresponding to each channel to be used for the home return in the system register 401.
 Home input corresponding to each channel: CH0=4, CH1=X5, CH2=X6, CH3=X7
 For performing the JOG positioning for each type,
 it is necessary to specify the position control starting input signal corresponding to each channel to be used for the JOG positioning.

Note3) The settings for pulse catch and interrupt input can only be specified in system registers 403 to 405.

	No.	Name	Default value	Descriptions
Tool port setting	410	Unit No. setting	1	1 to 99
	412	Communication mode setting	Computer link	Computer link General-purpose communications ^{Note2)}
		Selection of modem connection	Disabled	Enabled/Disabled
	413	Communication format setting	Data length bit: 8 bits Parity check: "with odd" Stop bit: 1 bit	Enter the settings for the various items. - Data length bit: 7 bits/8 bits - Parity check: none/with odd/with even - Stop bit: 1 bit/2 bits - The following setting is valid only when the communication mode specified by system register 412 has been set to "General-purpose serial communication". - Terminator CR/CR+LF/None/ETX - Header: STX not exist/STX exist
	415	Communication speed (Baud rate) setting	9600 bps	2400 bps / 4800 bps / 9600 bps / 19200 bps / 38400 bps / 57600 bps / 115200 bps
	420	Starting address for received buffer of general (serial data) communication mode	4096	0 to 32764
421	Buffer capacity setting for data received of general (serial data) communication mode	2048	0 to 2048	
COM port setting	410	Unit No. setting	1	1 to 99
	412	Communication mode setting	Computer link	Computer link General-purpose serial communication PC(PLC) link MODBUS RTU
		Selection of modem connection	Disabled	Enabled/Disabled
	413	Communication format setting	Data length bit: 8 bits Parity check: Odd Stop bit: 1 bit	Enter the settings for the various items. - Data length bit: 7 bits/8 bits - Parity check: none/with odd/with even - Stop bit: 1 bit/2 bits - The following setting is valid only when the communication mode specified by system register 412 has been set to "General-purpose serial communication". - Terminator CR/CR+LF/None/ETX - Header: STX not exist/STX exist
	415	Communication speed (Baud rate) setting	9600 bps	2400 bps / 4800 bps / 9600 bps / 19200 bps / 38400 bps / 57600 bps / 115200 bps
	416	Starting address for received buffer of general (serial data) communication mode	0	0 to 32764
417	Buffer capacity setting for data received of general (serial data) communication mode	2048	0 to 2048	

Note1) The communication format in a PLC link is fixed at the following settings:

Data length is 8 bits, odd parity, stop bit is 1.

The communication speed (baud rate) is fixed at 115200 bps.

Note2) The general-purpose communication with the tool port is available only in RUN mode. In PROG mode, the computer link mode must be used regardless of settings.

Item	Address	Name	Default value	Description
Controller input time constant settings	430	Controller input time constant setting 1 X0 to X3	1 ms	None 0.1 ms 0.5 ms 1 ms 2 ms 4 ms 8 ms 16 ms 32 ms 64 ms
	431	Controller input time constant setting 1 X4 to X7		
	432	Controller input time constant setting 2 X8 to XB (C32/T32/F32)		
	433	Controller input time constant setting 2 XC to XF (C32/T32/F32)		

Note) X6 and X7 is invalid for C10.

15.1.2 Table of Special Internal Relays for FP0R



The special internal relays turn on and off under special conditions. The on and off states are not output externally. Writing is not possible with a programming tool or an instruction.

WR900 FP0R

Relay No.	Name	Description
R9000	Self-diagnostic error flag	Turns on when a self-diagnostic error occurs. ⇒ The content of self-diagnostic error is stored in DT90000.
R9001	Not used	
R9002	Not used	
R9003	Not used	
R9004	I/O verification error flag	Turns on when an I/O verification error occurs.
R9005	Not used	
R9006	Not used	
R9007	Operation error flag (hold)	Turns on and keeps the on state when an operation error occurs. ⇒ The address where the error occurred is stored in DT90017. (indicates the first operation error which occurred).
R9008	Operation error flag (non-hold)	Turns on for an instant when an operation error occurs. ⇒ The address where the operation error occurred is stored in DT90018. The contents change each time a new error occurs.
R9009	Carry flag	This is set if an overflow or underflow occurs in the calculation results, and as a result of a shift system instruction being executed.
R900A	> Flag	Turns on for an instant when the compared results become larger in the comparison instructions (F60 to F63).
R900B	= Flag	Turns on for an instant, - when the compared results are equal in the comparison instructions (F60 to F63). - when the calculated results become 0 in the arithmetic instructions.
R900C	< Flag	Turns on for an instant when the compared results become smaller in the comparison instructions (F60 to F63).
R900D	Auxiliary timer instruction flag	Turns on when the set time elapses (set value reaches 0) in the timing operation of the F137(STMR)/F183(DSTM) auxiliary timer instruction. The flag turns off when the trigger for auxiliary timer instruction turns off.
R900E	Tool port communication error	Turns on when communication error at tool port is occurred.
R900F	Constant scan error flag	Turns on when scan time exceeds the time specified in system register 34 during constant scan execution. This goes on if 0 has been set using system register 34.

A: Available, N/A: Not available

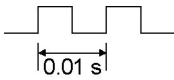
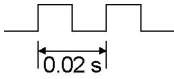
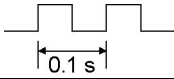
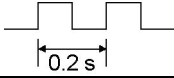
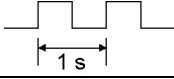
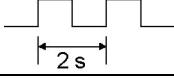
WR901 FP0R

Relay No.	Name	Description
R9010	Always on relay	Always on.
R9011	Always off relay	Always off.
R9012	Scan pulse relay	Turns on and off alternately at each scan.
R9013	Initial (on type) pulse relay	Goes on for only the first scan after operation (RUN) has been started, and goes off for the second and subsequent scans.
R9014	Initial (off type) pulse relay	Goes off for only the first scan after operation (RUN) has been started, and goes on for the second and subsequent scans.
R9015	Step ladder initial pulse relay (on type)	Turns on for only the first scan of a process after the boot at the step ladder control.
R9016	Not used	
R9017	Not used	
R9018	0.01 s clock pulse relay	Repeats on/off operations in 0.01 sec. cycles. 
R9019	0.02 s clock pulse relay	Repeats on/off operations in 0.02 s. cycles. 
R901A	0.1 s clock pulse relay	Repeats on/off operations in 0.1 s. cycles. 
R901B	0.2 s clock pulse relay	Repeats on/off operations in 0.2 s. cycles. 
R901C	1 s clock pulse relay	Repeats on/off operations in 1 s. cycles. 
R901D	2 s clock pulse relay	Repeats on/off operations in 2 s. cycles. 
R901E	1 min clock pulse relay	Repeats on/off operations in 1 min. cycles. 
R901F	Not used	

A: Available, N/A: Not available

WR902 FP0R

Relay No.	Name	Description
R9020	RUN mode flag	Turns off while the mode selector is set to PROG. Turns on while the mode selector is set to RUN.
R9021	Not used	
R9022	Not used	
R9023	Not used	
R9024	Not used	
R9025	Not used	
R9026	Message flag	Turns on while the F149 (MSG) instruction is executed.
R9027	Not used	
R9028	Not used	
R9029	Forcing flag	Turns on during forced on/off operation for input/output relay timer/counter contacts.
R902A	Interrupt enable flag	Turns on while the external interrupt trigger is enabled by the ICTL instruction.
R902B	Interrupt error flag	Turns on when an interrupt error occurs.
R902C	Sample point flag	Sampling by the instruction=0 Sampling at constant time intervals=1
R902D	Sampling trace end flag	When the sampling operation stops=1, When the sampling operation starts=0
R902E	Sampling stop trigger flag	When the sampling stop trigger activates=1 When the sampling stop trigger stops=0
R902F	Sampling enable flag	When sampling starts=1 When sampling stops=0

A: Available, N/A: Not available

WR903 FP0R

Relay No.	Name	Description
R9030	Not used	
R9031	Not used	
R9032	COM port communication mode flag	<ul style="list-style-type: none"> - Turns on when the general-purpose communication function is being used - Goes off when the MEWTOCOL-COM or the PLC link function is being used.
R9033	Print instruction execution flag	<ul style="list-style-type: none"> Off: Printing is not executed. On: Execution is in progress.
R9034	RUN overwrite complete flag	Goes on for only the first scan following completion of a rewrite during the RUN operation.
R9035	Not used	
R9036	Not used	
R9037	COM port communication error flag	<ul style="list-style-type: none"> - Goes on is a transmission error occurs during data communication. - Goes off when a request is made to send data, using the F159 (MTRN) instruction.
R9038	COM port reception done flag during general purpose communication	- Turns on when the terminator is received during general - purpose serial communication.
R9039	COM port transmission done flag during general-purpose serial communication	<ul style="list-style-type: none"> - Goes on when transmission has been completed in general-purpose serial communication. - Goes off when transmission is requested in general-purpose serial communication.
R903A	Not used	
R903B	Not used	
R903C	Not used	
R903D	Not used	
R903E	TOOL port reception done flag during general purpose communication	- Turns on the terminator is received during general -purpose serial communication.
R903F	TOOL port transmission done flag during general-purpose serial communication	<ul style="list-style-type: none"> - Goes on when transmission has been completed in general-purpose serial communication. - Goes off when transmission is requested in general-purpose serial communication.

A: Available, N/A: Not available

Note) R9030 to R9030F can be changed during 1 scan.

WR904 FP0R

Relay No.	Name	Description
R9040	TOOL port operation mode flag	- Turns on when the general-purpose communication function is being used - Goes off when the computer link function is being used.
R9041	COM port PLC link flag	Turn on while the PLC link function is used.
R9042	Not used	
R9043	Not used	
R9044	COM port SEND/RECV instruction execution flag	Monitors whether the F145 (SEND) or F146 (RECV) instructions can be executed or not. Off: None of the above mentioned instructions can be executed. (During executing the instruction) On: One of the above mentioned instructions can be executed.
R9045	COM port SEND/RECV instruction execution end flag	Monitors if an abnormality has been detected during the execution of the F145 (SEND) or F146 (RECV) instructions as follows: Off: No abnormality detected. On: An abnormality detected. (communication error) End code: DT90124
R9046	Not used	
R9047	Not used	
R9048	Not used	
R9049	Not used	
R904A	Not used	
R904B	Not used	
R904C to R904F	Not used	

A: Available, N/A: Not available

Note) R9040 to R904F can be changed during 1 scan.

WR905 FP0R

Relay No.	Name	Description
R9050	MEWNET-W0 PLC link transmission error flag	When using MEWNET-W0 - Turns on when a transmission error occurs at PLC link. - Turns on when there is an error in the PLC link area settings.
R9051 to R905F	Not used	

WR906 FP0R

Relay No.	Name	Description
R9060	MEWNET-W0 PC(PLC) link 0 transmission assurance relay	Unit No.1 Turns on when Unit No. 1 is communicating properly in PC(PLC) link 0 mode. Turns off when operation is stopped, when an error occurs, or when not in the PC(PLC) link 0 mode.
R9061		Unit No.2 Turns on when Unit No. 2 is communicating properly in PC(PLC) link 0 mode. Turns off when operation is stopped, when an error occurs, or when not in the PC(PLC) link 0 mode.
R9062		Unit No.3 Turns on when Unit No. 3 is communicating properly in PC(PLC) link 0 mode. Turns off when operation is stopped, when an error occurs, or when not in the PC(PLC) link 0 mode.
R9063		Unit No.4 Turns on when Unit No. 4 is communicating properly in PC(PLC) link 0 mode. Turns off when operation is stopped, when an error occurs, or when not in the PC(PLC) link 0 mode.
R9064		Unit No.5 Turns on when Unit No. 5 is communicating properly in PC(PLC) link 0 mode. Turns off when operation is stopped, when an error occurs, or when not in the PC(PLC) link 0 mode.
R9065		Unit No.6 Turns on when Unit No. 6 is communicating properly in PC(PLC) link 0 mode. Turns off when operation is stopped, when an error occurs, or when not in the PC(PLC) link 0 mode.
R9066		Unit No.7 Turns on when Unit No. 7 is communicating properly in PC(PLC) link 0 mode. Turns off when operation is stopped, when an error occurs, or when not in the PC(PLC) link 0 mode.
R9067		Unit No.8 Turns on when Unit No. 8 is communicating properly in PC(PLC) link 0 mode. Turns off when operation is stopped, when an error occurs, or when not in the PC(PLC) link 0 mode.
R9068		Unit No.9 Turns on when Unit No. 9 is communicating properly in PC(PLC) link 0 mode. Turns off when operation is stopped, when an error occurs, or when not in the PC(PLC) link 0 mode.
R9069		Unit No.10 Turns on when Unit No. 10 is communicating properly in PC(PLC) link 0 mode. Turns off when operation is stopped, when an error occurs, or when not in the PC(PLC) link 0 mode.
R906A		Unit No.11 Turns on when Unit No. 11 is communicating properly in PC(PLC) link 0 mode. Turns off when operation is stopped, when an error occurs, or when not in the PC(PLC) link 0 mode.
R906B		Unit No.12 Turns on when Unit No. 12 is communicating properly in PC(PLC) link 0 mode. Turns off when operation is stopped, when an error occurs, or when not in the PC(PLC) link 0 mode.
R906C		Unit No.13 Turns on when Unit No. 13 is communicating properly in PC(PLC) link 0 mode. Turns off when operation is stopped, when an error occurs, or when not in the PC(PLC) link 0 mode.
R906D		Unit No.14 Turns on when Unit No. 14 is communicating properly in PC(PLC) link 0 mode. Turns off when operation is stopped, when an error occurs, or when not in the PC(PLC) link 0 mode.
R906E		Unit No.15 Turns on when Unit No. 15 is communicating properly in PC(PLC) link 0 mode. Turns off when operation is stopped, when an error occurs, or when not in the PC(PLC) link 0 mode.
R906F		Unit No.16 Turns on when Unit No. 16 is communicating properly in PC(PLC) link 0 mode. Turns off when operation is stopped, when an error occurs, or when not in the PC(PLC) link 0 mode.

A: Available, N/A: Not available

WR907 FP0R

Relay No.	Name	Description
R9070	MEWNET-W0 PC(PLC) link 0 operation mode relay	Unit No.1 Turns on when Unit No. 1 is in the RUN mode. Turns off when Unit No. 1 is in the PROG. mode.
R9071		Unit No.2 Turns on when Unit No. 2 is in the RUN mode. Turns off when Unit No. 2 is in the PROG. mode.
R9072		Unit No.3 Turns on when Unit No. 3 is in the RUN mode. Turns off when Unit No. 3 is in the PROG. mode.
R9073		Unit No.4 Turns on when Unit No. 4 is in the RUN mode. Turns off when Unit No. 4 is in the PROG. mode.
R9074		Unit No.5 Turns on when Unit No. 5 is in the RUN mode. Turns off when Unit No. 5 is in the PROG. mode.
R9075		Unit No.6 Turns on when Unit No. 6 is in the RUN mode. Turns off when Unit No. 6 is in the PROG. mode.
R9076		Unit No.7 Turns on when Unit No. 7 is in the RUN mode. Turns off when Unit No. 7 is in the PROG. mode.
R9077		Unit No.8 Turns on when Unit No. 8 is in the RUN mode. Turns off when Unit No. 8 is in the PROG. mode.
R9078		Unit No.9 Turns on when Unit No. 9 is in the RUN mode. Turns off when Unit No. 9 is in the PROG. mode.
R9079		Unit No.10 Turns on when Unit No. 10 is in the RUN mode. Turns off when Unit No. 10 is in the PROG. mode.
R907A		Unit No.11 Turns on when Unit No. 11 is in the RUN mode. Turns off when Unit No. 11 is in the PROG. mode.
R907B		Unit No.12 Turns on when Unit No. 12 is in the RUN mode. Turns off when Unit No. 12 is in the PROG. mode.
R907C		Unit No.13 Turns on when Unit No. 13 is in the RUN mode. Turns off when Unit No. 13 is in the PROG. mode.
R907D		Unit No.14 Turns on when Unit No. 14 is in the RUN mode. Turns off when Unit No. 14 is in the PROG. mode.
R907E		Unit No.15 Turns on when Unit No. 15 is in the RUN mode. Turns off when Unit No. 15 is in the PROG. mode.
R907F		Unit No.16 Turns on when Unit No. 16 is in the RUN mode. Turns off when Unit No. 16 is in the PROG. mode.

A: Available, N/A: Not available

WR908 FP0R

Relay No.	Name	Description
R9080	MEWNET-W0 PC(PLC) link 1 trans- mission assurance relay	Unit No.1 Turns on when Unit No. 1 is communicating properly in PC(PLC) link 1 mode. Turns off when operation is stopped, when an error occurs, or when not in the PC(PLC) link 1 mode.
R9081		Unit No.2 Turns on when Unit No. 2 is communicating properly in PC(PLC) link 1 mode. Turns off when operation is stopped, when an error occurs, or when not in the PC(PLC) link 1 mode.
R9082		Unit No.3 Turns on when Unit No. 3 is communicating properly in PC(PLC) link 1 mode. Turns off when operation is stopped, when an error occurs, or when not in the PC(PLC) link 1 mode.
R9083		Unit No.4 Turns on when Unit No. 4 is communicating properly in PC(PLC) link 1 mode. Turns off when operation is stopped, when an error occurs, or when not in the PC(PLC) link 1 mode.
R9084		Unit No.5 Turns on when Unit No. 5 is communicating properly in PC(PLC) link 1 mode. Turns off when operation is stopped, when an error occurs, or when not in the PC(PLC) link 1 mode.
R9085		Unit No.6 Turns on when Unit No. 6 is communicating properly in PC(PLC) link 1 mode. Turns off when operation is stopped, when an error occurs, or when not in the PC(PLC) link 1 mode.
R9086		Unit No.7 Turns on when Unit No. 7 is communicating properly in PC(PLC) link 1 mode. Turns off when operation is stopped, when an error occurs, or when not in the PC(PLC) link 1 mode.
R9087		Unit No.8 Turns on when Unit No. 8 is communicating properly in PC(PLC) link 1 mode. Turns off when operation is stopped, when an error occurs, or when not in the PC(PLC) link 1 mode.
R9088		Unit No.9 Turns on when Unit No. 9 is communicating properly in PC(PLC) link mode. Turns off when operation is stopped, when an error occurs, or when not in the PC(PLC) link mode.
R9089		Unit No.10 Turns on when Unit No. 10 is communicating properly in PC(PLC) link 1 mode. Turns off when operation is stopped, when an error occurs, or when not in the PC(PLC) link 1 mode.
R908A		Unit No.11 Turns on when Unit No. 11 is communicating properly in PC(PLC) link 1 mode. Turns off when operation is stopped, when an error occurs, or when not in the PC(PLC) link 1 mode.
R908B		Unit No.12 Turns on when Unit No. 12 is communicating properly in PC(PLC) link 1 mode. Turns off when operation is stopped, when an error occurs, or when not in the PC(PLC) link 1 mode.
R908C		Unit No.13 Turns on when Unit No. 13 is communicating properly in PC(PLC) link 1 mode. Turns off when operation is stopped, when an error occurs, or when not in the PC(PLC) link 1 mode.
R908D		Unit No.14 Turns on when Unit No. 14 is communicating properly in PC(PLC) link 1 mode. Turns off when operation is stopped, when an error occurs, or when not in the PC(PLC) link 1 mode.
R908E		Unit No.15 Turns on when Unit No. 15 is communicating properly in PC(PLC) link 1 mode. Turns off when operation is stopped, when an error occurs, or when not in the PC(PLC) link 1 mode.
R908F		Unit No.16 Turns on when Unit No. 16 is communicating properly in PC(PLC) link 1 mode. Turns off when operation is stopped, when an error occurs, or when not in the PC(PLC) link 1 mode.

A: Available, N/A: Not available

WR909 FP0R

Relay No.	Name	Description
R9090	MEWNET- W0 PC(PLC) link 1 operation mode relay	Unit No.1 Turns on when Unit No. 1 is in the RUN mode. Turns off when Unit No. 1 is in the PROG. mode.
R9091		Unit No.2 Turns on when Unit No. 2 is in the RUN mode. Turns off when Unit No. 2 is in the PROG. mode.
R9092		Unit No.3 Turns on when Unit No. 3 is in the RUN mode. Turns off when Unit No. 3 is in the PROG. mode.
R9093		Unit No.4 Turns on when Unit No. 4 is in the RUN mode. Turns off when Unit No. 4 is in the PROG. mode.
R9094		Unit No.5 Turns on when Unit No. 5 is in the RUN mode. Turns off when Unit No. 5 is in the PROG. mode.
R9095		Unit No.6 Turns on when Unit No. 6 is in the RUN mode. Turns off when Unit No. 6 is in the PROG. mode.
R9096		Unit No.7 Turns on when Unit No. 7 is in the RUN mode. Turns off when Unit No. 7 is in the PROG. mode.
R9097		Unit No.8 Turns on when Unit No. 8 is in the RUN mode. Turns off when Unit No. 8 is in the PROG. mode.
R9098		Unit No.9 Turns on when Unit No. 9 is in the RUN mode. Turns off when Unit No. 9 is in the PROG. mode.
R9099		Unit No.10 Turns on when Unit No. 10 is in the RUN mode. Turns off when Unit No. 10 is in the PROG. mode.
R909A		Unit No.11 Turns on when Unit No. 11 is in the RUN mode. Turns off when Unit No. 11 is in the PROG. mode.
R909B		Unit No.12 Turns on when Unit No. 12 is in the RUN mode. Turns off when Unit No. 12 is in the PROG. mode.
R909C		Unit No.13 Turns on when Unit No. 13 is in the RUN mode. Turns off when Unit No. 13 is in the PROG. mode.
R909D		Unit No.14 Turns on when Unit No. 14 is in the RUN mode. Turns off when Unit No. 14 is in the PROG. mode.
R909E		Unit No.15 Turns on when Unit No. 15 is in the RUN mode. Turns off when Unit No. 15 is in the PROG. mode.
R909F		Unit No.16 Turns on when Unit No. 16 is in the RUN mode. Turns off when Unit No. 16 is in the PROG. mode.

A: Available, N/A: Not available

WR910 FP0R

Relay No.	Name	Description
R9110	High-speed counter control flag	HSC-CH0
R9111		HSC-CH1
R9112		HSC-CH2
R9113		HSC-CH3
R9114		HSC-CH4
R9115		HSC-CH5
R9116 to R911F	Not used	
R9120	Pulse output instruction flag	PLS-CH0
R9121		PLS-CH1
R9122		PLS-CH2
R9123		PLS-CH3
R9124 to R912F	Not used	
R9130	Pulse output control flag	PLS-CH0
R9131		PLS-CH1
R9132		PLS-CH2
R9133		PLS-CH3
R9134 to R913F	Not used	

A: Available, N/A: Not available

15.1.3 Table of Special Data Registers for FP0R

FP0R (A: Available, N/A: Not available)

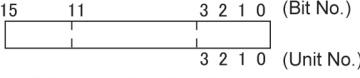
Address	Name	Description	Reading	Writing
DT90000	Self-diagnostic error code	The self-diagnostic error code is stored here when a self-diagnostic error occurs.	A	N/A
DT90001	Not used	-	N/A	N/A
DT90002	Not used	-	N/A	N/A
DT90003	Not used	-	N/A	N/A
DT90004	Not used	-	N/A	N/A
DT90005	Not used	-	N/A	N/A
DT90006	Not used	-	N/A	N/A
DT90007	Not used	-	N/A	N/A
DT90008	Not used	-	N/A	N/A
DT90009	Not used	-	N/A	N/A
DT90010	Extension (right side) I/O verify error unit [0 to 3]	<p>When the state of installation of FP0 expansion I/O unit has changed since the power was turned on, the bit corresponding to the unit No. will turn on. Monitor using binary display.</p>  <p>ON "1": Error OFF "0": Normal</p>	A	N/A
DT90011	Not used	-	N/A	N/A
DT90012	Not used	-	N/A	N/A
DT90013	Not used	-	N/A	N/A

Address	Name	Description	Reading	Writing
DT90014	Operation auxiliary register for data shift instruction	One shift-out hexadecimal digit is stored in bit positions 0 to 3 when the data shift instruction, F105 (BSR) or F106 (BSL) is executed. The value can be read and written by executing F0 (MV) instruction.	A	A
DT90015	Operation auxiliary register for division instruction	The divided remainder (16-bit) is stored in DT90015 when the division instruction F32(%) or F52(B%) instruction is executed. The divided remainder (32-bit) is stored in DT90015 and DT90016 when the division instruction F33(D%) or F53(DB%) is executed. The value can be read and written by executing F0(MV) instruction.	A	A
DT90016			A	A
DT90017	Operation error address (hold type)	After commencing operation, the address where the first operation error occurred is stored. Monitor the address using decimal display.	A	N/A
DT90018	Operation error address (latest type)	The address where an operation error occurred is stored. Each time an error occurs, the new address overwrites the previous address.	A	N/A
DT90019	2.5 ms ring counter Note1)	The data stored here is increased by one every 2.5 ms. (H0 to HFFFF) Difference between the values of the two points (absolute value) x 2.5 ms = Elapsed time between the two points.	A	N/A
DT90020	10 μs ring counter Note1) Note2)	The data stored here is increased by one every 10.67 μs. (H0 to HFFFF) Difference between the values of the two points (absolute value) x 10.67 μs = Elapsed time between the two points. Note) The exact value is 10.67 μs.	A	N/A
DT90021	Not used	-	N/A	N/A

Note1) It is renewed once at the beginning of each one scan.

Note2) As DT90020 is renewed even if F0(MV), DT90020 and D instruction is being executed, it can be used to measure the block time.

Address	Name	Description	Reading	Writing
DT90022	Scan time (current value) <small>Note)</small>	The current scan time is stored here. Scan time is calculated using the formula: Scan time (ms) = stored data (decimal) x 0.1 ms Example: K50 indicates 5 ms.	A	N/A
DT90023	Scan time (minimum value) <small>Note)</small>	The minimum scan time is stored here. Scan time is calculated using the formula: Scan time (ms) = stored data (decimal) x 0.1 ms Example: K50 indicates 5 ms.	A	N/A
DT90024	Scan time (maximum value) <small>Note)</small>	The maximum scan time is stored here. The scan time is calculated using the formula: Scan time (ms) = stored data (decimal) x 0.1 ms Example: K125 indicates 12.5 ms.	A	N/A
DT90025	Mask condition monitoring register for interrupts (INT0 to 11)	The mask conditions of interrupts using the instruction can be stored here. Monitor using binary display. <p>0: interrupt disabled 1: interrupt enabled</p>	A	N/A
DT90026	Not used	-	N/A	N/A
DT90027	Periodical interrupt interval (INT24)	The value set by ICTL instruction is stored. K0: periodical interrupt is not used. K1 to K3000: 0.5ms to 1.5s or 10ms to 30s	A	N/A
DT90028	Sample trace interval	K0: Sampling by the SMPL instruction K1 to K3000 (x 10 ms): 10 ms to 30 s	A	N/A
DT90029	Not used	-	N/A	N/A
DT90030	Character storage by F149 MSG instruction	The contents of the specified message (Data length) are stored in these special data registers when F149 (MSG) instruction is executed.	A	N/A
DT90031				
DT90032				
DT90033				
DT90034				
DT90035				
DT90036	Not used	-	N/A	N/A

Note) Scan time display is only possible in RUN mode, and shows the operation cycle time. (In PROG. mode, the scan time for the operation is not displayed.) The maximum and minimum values are cleared each time the mode is switched from RUN to PROG.

Address	Name	Description	Reading	Writing
DT90037	Work1 for SRC instructions	The number of data that match the searched data is stored here when F96 (SRC) instruction is executed.	A	N/A
DT90038	Work2 for SRC instructions	The position of the first matching data is stored here when an F96 (SRC) instruction is executed.	A	N/A
DT90039	Not used	-	N/A	N/A
DT90040	Not used	-	N/A	N/A
DT90041	Not used	-	N/A	N/A
DT90042	Not used	-	N/A	N/A
DT90043	Not used	-	N/A	N/A
DT90044	Not used	-	N/A	N/A
DT90045	Not used	-	N/A	N/A
DT90046	Not used	-	N/A	N/A
DT90047	Not used	-	N/A	N/A
DT90048	Not used	-	N/A	N/A
DT90049	Not used	-	N/A	N/A
DT90050	Not used	-	N/A	N/A
DT90051	Not used	-	N/A	N/A
DT90052	High-speed counter control flag	<p>The pulse output instruction can be continued or cleared by writing a value with MV instruction (F0).</p> <p>Control code setting 【FP0R type】</p> <p>Channel setting [HSC] 0 to 5: CH0 to CH5</p> <p>[HSC] 0</p> <p>[HSC] High-speed counter instruction 0: Continue / 1: Clear</p> <p>[HSC] Hardware reset (Note) 0: Enable/1: Disable</p> <p>[HSC] Count 0: Enable/1: Disable</p> <p>[HSC] Software reset 0: No/1: Yes</p>	A	A

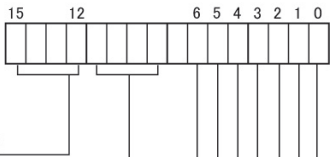
Address	Name	Description	Reading	Writing
DT90052	Pulse output control flag	<p>A value can be written with F0 (MV) instruction to reset the high-speed counter, disable counting, continue or clear high-speed counter instruction.</p> <p>Control code setting 【FP0R type】</p>  <p>Channel setting [PLS] 0~3: CH0~CH3</p> <p>[PLS] 1</p> <p>[PLS] Position control start request 0: Disable/1: Enable</p> <p>[PLS] Deceleration stop request 0: Disable/1: Enable</p> <p>[PLS] Near home input 0: Disable/1: Enable</p> <p>[PLS] Pulse output 0: Continue / 1: Clear</p> <p>[PLS] Pulse output control(match ON/OFF)·· 0: Continue/1:Cancel</p> <p>[PLS] Count 0: Enable/1: Disable</p> <p>[PLS] Software reset 0: No/1: Yes</p>	A	A

Address	Name	Description	Reading	Writing																
DT90053	Clock/calender monitor (hour/minute) (T32 only)	<p>Hour and minute data of the clock/calender are stored here. This data is read-only data. It cannot be overwritten.</p> <p style="text-align: center;">Higher byte Lower byte</p> <table border="1" style="margin-left: auto; margin-right: auto;"> <tr> <td style="width: 10px; height: 15px;"></td> <td style="width: 10px; height: 15px;"></td> <td style="width: 10px; height: 15px;"></td> <td style="width: 10px; height: 15px;"></td> </tr> </table> <p style="text-align: center;">Hour data Minute data H00 to H23 H00 to H59</p>					A	N/A												
DT90054	Clock/calender setting (minute/second) (T32 only)	<p>The year, month, day, hour, minute, second and day-of-the-week data for the clock/calender is stored. The built-in clock/calender will operate correctly through the year 2099 and supports leap years. The clock/calender can be set by writing a value using a programming tool software or a program that uses the F0 (MV) instruction.(see example for DT90058)</p> <p style="text-align: center;">Higher byte Lower byte</p> <table border="1" style="margin-left: auto; margin-right: auto;"> <tr> <td style="width: 10px; height: 15px;"></td> <td style="width: 10px; height: 15px;"></td> <td style="width: 10px; height: 15px;"></td> <td style="width: 10px; height: 15px;"></td> </tr> </table> <table border="1" style="margin-left: auto; margin-right: auto;"> <tr> <td style="width: 100px; height: 20px;">DT90054</td> <td style="width: 100px; height: 20px;">Minute data (H00 to H59)</td> <td style="width: 100px; height: 20px;">Second data (H00 to H59)</td> </tr> <tr> <td style="width: 100px; height: 20px;">DT90055</td> <td style="width: 100px; height: 20px;">Day data (H01 to H31)</td> <td style="width: 100px; height: 20px;">Hour data (H00 to H23)</td> </tr> <tr> <td style="width: 100px; height: 20px;">DT90056</td> <td style="width: 100px; height: 20px;">Year data (H00 to H99)</td> <td style="width: 100px; height: 20px;">Month data (H01 to H12)</td> </tr> <tr> <td style="width: 100px; height: 20px;">DT90057</td> <td style="width: 100px; height: 20px;">—</td> <td style="width: 100px; height: 20px;">Day-of-the-week (H00 to H06)</td> </tr> </table> <p>As a day of the week is not automatically set on FPWIN GR, fix what day is set to 00, and set each value for 00 to 06.</p>					DT90054	Minute data (H00 to H59)	Second data (H00 to H59)	DT90055	Day data (H01 to H31)	Hour data (H00 to H23)	DT90056	Year data (H00 to H99)	Month data (H01 to H12)	DT90057	—	Day-of-the-week (H00 to H06)	A	A
DT90054	Minute data (H00 to H59)		Second data (H00 to H59)																	
DT90055	Day data (H01 to H31)		Hour data (H00 to H23)																	
DT90056	Year data (H00 to H99)	Month data (H01 to H12)																		
DT90057	—	Day-of-the-week (H00 to H06)																		
DT90055	Clock/calender setting (day/hour) (T32 only)																			
DT90056	Clock/calender setting (year/month) (T32 only)																			
DT90057	Clock/calender setting (day-of-the-week) (T32 only)																			

Address	Name	Description	Reading	Writing
DT90058	Clock/calender setting and 30 seconds correction register (T32 only)	<p>The clock/calender is adjusted as follows.</p> <p>When setting the clock/calender by program</p> <p>By setting the highest bit of DT90058 to 1, the time becomes that written to DT90054 to DT90057 by F0 (MV) instruction. After the time is set, DT90058 is cleared to 0. (Cannot be performed with any instruction other than F0 (MV) instruction.)</p> <p><Example> Set the time to 12:00:00 on the 5th day when the X0 turns on.</p> <div style="display: flex; align-items: center; border: 1px solid black; padding: 5px;"> <div style="margin-right: 10px;"> <p>X0</p> </div> <div style="border-left: 1px solid black; padding-left: 5px;"> <p>Inputs 0 minutes and 0 seconds</p> <p>[F0 MV, H 512, DT90055] Inputs 12th hour 5th day</p> <p>[F0 MV, H8000, DT90058] Sets the time</p> </div> </div> <p>Note) If the values of DT90054 to DT90057 are changed with the programming tool software, the time will be set when the new values are written. Therefore, it is unnecessary to write to DT90058.</p> <p>When the correcting times less than 30 seconds</p> <p>By setting the lowest bit of DT90058 to 1, the value will be moved up or down and become exactly 0 seconds. After the correction is completed, DT90058 is cleared to 0.</p> <p>Example: Correct to 0 seconds with X0: on</p> <div style="display: flex; align-items: center; border: 1px solid black; padding: 5px;"> <div style="margin-right: 10px;"> <p>X0</p> </div> <div style="border-left: 1px solid black; padding-left: 5px;"> <p>Correct to 0 seconds.</p> </div> </div> <p>At the time of coorection, if between 0 and 29 seconds, it will be moved down, and if between 30 and 59 seconds, it will be moved up.</p> <p>In the example above, if the time was 5 minutes 29 seconds, it will become 5 minutes 0 seconds;and, if the time was 5 minutes 35 seconds, it will become 6 minutes 0 seconds.</p>	A	A
DT90059	Communication error code	Error code is sotred here when a communication error occurs.	N/A	N/A

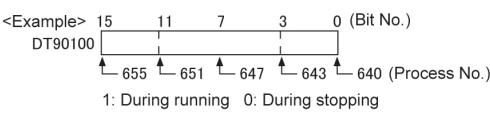
Address	Name	Description	Reading	Writing
DT90060	Step ladder process (0 to 15)	<p>Indicates the startup condition of the step ladder process. When the process starts up, the bit corresponding to the process number turns on.</p> <p>Monitor using binary display.</p> <p><Example> </p> <p>Note) A programming tool software can be used to write data.</p>	A	A Note)
DT90061	Step ladder process (16 to 31)			
DT90062	Step ladder process (32 to 47)			
DT90063	Step ladder process (48 to 63)			
DT90064	Step ladder process (64 to 79)			
DT90065	Step ladder process (80 to 95)			
DT90066	Step ladder process (96 to 111)			
DT90067	Step ladder process (112 to 127)			
DT90068	Step ladder process (128 to 143)			
DT90069	Step ladder process (144 to 159)			
DT90070	Step ladder process (160 to 175)			
DT90071	Step ladder process (176 to 191)			
DT90072	Step ladder process (192 to 207)			
DT90073	Step ladder process (208 to 223)			
DT90074	Step ladder process (224 to 239)			
DT90075	Step ladder process (240 to 255)			
DT90076	Step ladder process (256 to 271)			
DT90077	Step ladder process (272 to 287)			
DT90078	Step ladder process (288 to 303)			
DT90079	Step ladder process (304 to 319)			
DT90080	Step ladder process (320 to 335)			
DT90081	Step ladder process (336 to 351)			

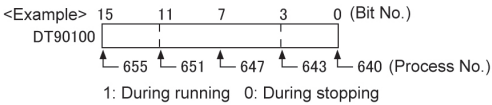
Address	Name	Description	Reading	Writing
DT90082	Step ladder process (352 to 367)	<p>Indicates the startup condition of the step ladder process. When the process starts up, the bit corresponding to the process number turns on .</p> <p>Monitor using binary display.</p> <p><Example>  </p> <p>Note) A programming tool software can be used to write data.</p>	A	A Note)
DT90083	Step ladder process (368 to 383)			
DT90084	Step ladder process (384 to 399)			
DT90085	Step ladder process (400 to 415)			
DT90086	Step ladder process (416 to 431)			
DT90087	Step ladder process (432 to 447)			
DT90088	Step ladder process (448 to 463)			
DT90089	Step ladder process (464 to 479)			
DT90090	Step ladder process (480 to 495)			
DT90091	Step ladder process (496 to 511)			
DT90092	Step ladder process (512 to 527)			
DT90093	Step ladder process (528 to 543)			
DT90094	Step ladder process (544 to 559)			
DT90095	Step ladder process (560 to 575)			
DT90096	Step ladder process (576 to 591)			
DT90097	Step ladder process (592 to 607)			

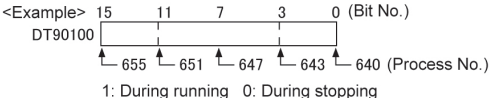
Address	Name	Description	Reading	Writing
DT90098	Step ladder process (608 to 623)	<p>Indicates the startup condition of the step ladder process. When the process starts up, the bit corresponding to the process number turns on.</p> <p>Monitor using binary display</p> <p><Example> </p> <p>A programming tool software can be used to write data.</p>	A	A
DT90099	Step ladder process (624 to 639)			
DT90100	Step ladder process (640 to 655)			
DT90101	Step ladder process (656 to 671)			
DT90102	Step ladder process (672 to 687)			
DT90103	Step ladder process (688 to 703)			
DT90104	Step ladder process (704 to 719)			
DT90105	Step ladder process (720 to 735)			
DT90106	Step ladder process (736 to 751)			
DT90107	Step ladder process (752 to 767)			
DT90108	Step ladder process (768 to 783)			
DT90109	Step ladder process (784 to 799)			
DT90110	Step ladder process (800 to 815)			
DT90111	Step ladder process (816 to 831)			
DT90112	Step ladder process (832 to 847)			
DT90113	Step ladder process (848 to 863)			
DT90114	Step ladder process (864 to 879)			
DT90115	Step ladder process (880 to 895)			
DT90116	Step ladder process (896 to 911)			
DT90117	Step ladder process (912 to 927)			
DT90118	Step ladder process (928 to 943)			
DT90119	Step ladder process (944 to 959)			
DT90120	Step ladder process (960 to 975)			
DT90121	Step ladder process (976 to 991)			
DT90122	Step ladder process (992 to 999) (higher byte is not used.)			

Address	Name	Description	Reading	Writing
DT90123	Not used	-	N/A	N/A
DT90124	COM SEND/RECV instruction end code	For details, refer to Programming Manual (F145 and F146).	N/A	N/A
DT90125	Not used	-	N/A	N/A
DT90126	Forced ON/OFF operating station display	Used by the system	N/A	N/A
DT90127 to DT90139	Not used	-	N/A	N/A
DT90140	MEWNET-W0 PC(PLC) link 0 status	The number of times the receiving operation is performed.	A	N/A
DT90141		The current interval between two receiving operations: value in the register x 2.5ms		
DT90142		The minimum interval between two receiving operations: value in the register x 2.5ms		
DT90143		The maximum interval between two receiving operations: value in the register x 2.5ms		
DT90144		The number of times the sending operation is performed.		
DT90145		The current interval between two sending operations: value in the register x 2.5ms		
DT90146		The minimum interval between two sending operations: value in the register x 2.5ms		
DT90147		The maximum interval between two sending operations: value in the register x 2.5ms		
DT90148	MEWNET-W0 PC(PLC) link 1 status	The number of times the receiving operation is performed.	A	N/A
DT90149		The current interval between two receiving operations: value in the register x 2.5ms		
DT90150		The minimum interval between two receiving operations: value in the register x 2.5ms		
DT90151		The maximum interval between two receiving operations: value in the register x 2.5ms		
DT90152		The number of times the sending operation is performed.		
DT90153		The current interval between two sending operations: value in the register x 2.5ms		
DT90154		The minimum interval between two sending operations: value in the register x 2.5ms		
DT90155		The maximum interval between two sending operations: value in the register x 2.5ms		
DT90156	MEWNET-W0 PC(PLC) link 0 status	Area used for measurement of receiving interval.	A	N/A
DT90157		Area used for measurement of sending interval.		

Address	Name	Description	Reading	Writing
DT90158	MEWNET-W0 PC(PLC) link 1 status	Area used for measurement of receiving interval.	A	N/A
DT90159		Area used for measurement of sending interval.		
DT90160	MEWNET-W0 PC(PLC) link 0 unit No.	Stores the unit No. of PC(PLC) link 0.	A	N/A
DT90161	MEWNET-W0 PC(PLC) link 0 error flag	Stores the error contents of PC(PLC) link 0.	A	N/A
DT90162 to DT90169	Not used	-	N/A	N/A
DT90170	MEWNET-W0 PC(PLC) link 0 status	Duplicated destination for PC(PLC) inter-link address	A	N/A
DT90171		Counts how many times a token is lost.		
DT90172		Counts how many times two or more tokens are detected.		
DT90173		Counts how many times a signal is lost.		
DT90174		No. of times underfined commands have been received.		
DT90175		No. of times sum check errors have occurred during reception.		
DT90176		No. of times format errors have occurred in received data.		
DT90177		No. of times transmission errors have occurred.		
DT90178		No. of times procedural errors have occurred.		
DT90179		No. of times overlapping parent units have occurred.		
DT90180 to DT90189	Not used	-	N/A	N/A
DT90190	Not used	-	N/A	N/A
DT90191	Not used	-	N/A	N/A
DT90192	Not used	-	N/A	N/A
DT90193	Not used	-	N/A	N/A
DT90194 to DT90218	Not used	-	N/A	N/A

Address	Name		Description	Reading	Writing			
DT90219	Unit No. (Station No.) selection for DT90220 to DT90251		0: Unit No. (Station No.) 1 to 8, 1: Unit No. (Station No.) 9 to 16	A	A			
DT90220	PC(PLC) link Unit (station) No. 1 or 9	System register 40 and 41	<p>The contents of the system register settings pertaining to the PLC inter-link function for the various unit numbers are stored as shown below.</p> <p><Example> When DT90219 is 0</p>	A	N/A			
DT90221		System register 42 and 43						
DT90222		System register 44 and 45						
DT90223		System register 46 and 47						
DT90224	PC(PLC) link Unit (station) No. 2 or 10	System register 40 and 41						
DT90225		System register 42 and 43						
DT90226		System register 44 and 45						
DT90227		System register 46 and 47						
DT90228	PC(PLC) link Unit (station) No. 3 or 11	System register 40 and 41				<ul style="list-style-type: none"> When the system register 46 in the home unit is in the standard setting, the values in the home unit are copied in the system registers 46 and 47. <p>When the system register 46 in the home unit is in the reverse setting, the registers 40 to 45 and 47 corresponding to the home unit mentioned in the left column will be changed to 50 to 55 and 57, and the system register 46 will be set as it is. Also, the system registers 40 to 45 corresponding to other units will be changed to the values which the received values are corrected, and the registers 46 and 57 in the home unit are set for the registers 46 and 47.</p>	A	N/A
DT90229		System register 42 and 43						
DT90230		System register 44 and 45						
DT90231		System register 46 and 47						
DT90232	PC(PLC) link Unit (station) No. 4 or 12	System register 40 and 41						
DT90233		System register 42 and 43						
DT90234		System register 44 and 45						
DT90235		System register 46 and 47						
DT90236	PC(PLC) link Unit (station) No. 5 or 13	System register 40 and 41						
DT90237		System register 42 and 43						
DT90238		System register 44 and 45						
DT90239		System register 46 and 47						

Address	Name		Description	Reading	Writing
DT90240	PC(PLC) link Unit (station) No. 6 or 14	System register 40 and 41	<p>The contents of the system register settings pertaining to the PLC inter-link function for the various unit numbers are stored as shown below.</p> <p><Example> when DT90219 is 0.</p>	A	N/A
DT90241		System register 42 and 43			
DT90242		System register 44 and 45			
DT90243		System register 46 and 47			
DT90244	PC(PLC) link Unit (station) No. 7 or 15	System register 40 and 41	<ul style="list-style-type: none"> When the system register 46 in the home unit is in the standard setting, the values in the home unit are copied in the system registers 46 and 47. When the system register 46 in the home unit is in the reverse setting, the registers 40 to 45 and 47 corresponding to the home unit mentioned in the left column will be changed to 50 to 55 and 57, and the system register 46 will be set as it is. Also, the system registers 40 to 45 corresponding to other units will be changed to the values which the received values are corrected, and the registers 46 and 57 in the home unit are set for the registers 46 and 47. 	A	N/A
DT90245		System register 42 and 43			
DT90246		System register 44 and 45			
DT90247		System register 46 and 47			
DT90248	PC(PLC) link Unit (station) No. 8 or 16	System register 40 and 41			
DT90249		System register 42 and 43			
DT90250		System register 44 and 45			
DT90251		System register 46 and 47			
DT90252	Not used			N/A	N/A
DT90253	Not used				
DT90254	Not used				
DT90255	Not used				
DT90256	Not used			N/A	N/A

Address	Name		Description	Reading	Writing
DT90300	Elapsed value area	Lower words	Counting area for input (X0) or (X0, X1) of the main unit.	A	A ^{Note)}
DT90301		Higher words		A	A ^{Note)}
DT90302	Target value area	Lower words	The target value is set when instructions F166 (HC1S) and F167 (HC1R) are executed.	A	A ^{Note)}
DT90303		Higher words		A	A ^{Note)}
DT90304	Elapsed value area	Lower words	Counting area for input (X1) of the main unit.	A	A ^{Note)}
DT90305		Higher words		A	A ^{Note)}
DT90306	Target value area	Lower words	The target value is set when instructions F166 (HC1S) and F167 (HC1R) are executed.	A	A ^{Note)}
DT90307		Higher words		A	A ^{Note)}
DT90308	Elapsed value area	Lower words	Counting area for input (X2) or (X2, X3) of the main unit.	A	A ^{Note)}
DT90309		Higher words		A	A ^{Note)}
DT90310	Target value area	Lower words	The target value is set when instructions F166 (HC1S) and F167 (HC1R) are executed.	A	A ^{Note)}
DT90311		Higher words		A	A ^{Note)}
DT90312	Elapsed value area	Lower words	Counting area for input (X3) of the main unit.	A	A ^{Note)}
DT90313		Higher words		A	A ^{Note)}
DT90314	Target value area	Lower words	The target value is set when instructions F166 (HC1S) and F167 (HC1R) are executed.	A	A ^{Note)}
DT90315		Higher words		A	A ^{Note)}
DT90316	Elapsed value area	Lower words	Counting area for input (X4) or (X4, X5) of the main unit.	A	A ^{Note)}
DT90317		Higher words		A	A ^{Note)}
DT90318	Target value area	Lower words	The target value is set when instructions F166 (HC1S) and F167 (HC1R) are executed.	A	A ^{Note)}
DT90319		Higher words		A	A ^{Note)}

Note) Writing in the elapsed value area is available by F1 (DMV) instruction only.

Writing in the target value area is available by F166 (HC1S) and F167 (HC1R) instructions only.

Address	Name		Description	Reading	Writing
DT90320	Elapsed value area	Lower words	HSC-CH5	Counting area for input (X5) of the main unit.	A <small>Note1)</small>
DT90321		Higher words			A <small>Note1)</small>
DT90322	Target value area	Lower words		The target value is set when instructions F166 (HC1S) and F167 (HC1R) are executed.	A <small>Note1)</small>
DT90323		Higher words			A <small>Note1)</small>
DT90324	Not used			N/A	N/A
DT90325	Not used			N/A	N/A
DT90326	Not used			N/A	N/A
DT90327	Not used			N/A	N/A
DT90328	Not used			N/A	N/A
DT90329	Not used			N/A	N/A
DT90330	Not used			N/A	N/A
DT90331	Not used			N/A	N/A
DT90332	Not used			N/A	N/A
DT90333	Not used			N/A	N/A
DT90334	Not used			N/A	N/A
DT90335	Not used			N/A	N/A
DT90336	Not used			N/A	N/A
DT90337	Not used			N/A	N/A
DT90338	Not used			N/A	N/A
DT90339	Not used			N/A	N/A
DT90340	Not used			N/A	N/A
DT90341	Not used			N/A	N/A
DT90342	Not used			N/A	N/A
DT90343	Not used			N/A	N/A
DT90344	Not used			N/A	N/A
DT90345	Not used			N/A	N/A
DT90346	Not used			N/A	N/A
DT90347	Not used			N/A	N/A
DT90348	Not used			N/A	N/A
DT90349	Not used			N/A	N/A
DT90350	Not used			N/A	N/A
DT90351	Not used			N/A	N/A
DT90352	Not used			N/A	N/A
DT90353	Not used			N/A	N/A
DT90354	Not used			N/A	N/A
DT90355	Not used			N/A	N/A
DT90356	Not used			N/A	N/A
DT90357	Not used			N/A	N/A
DT90358	Not used			N/A	N/A
DT90359	Not used			N/A	N/A
DT90360	Not used			N/A	N/A
DT90361	Not used			N/A	N/A
DT90362	Not used			N/A	N/A
DT90363	Not used			N/A	N/A

Note1) Writing in the elapsed value area is available by F1 (DMV) instruction only.

Writing in the target value area is available by F166 (HC1S) and F167 (HC1R) instructions only.

Address	Name		Description	Reading	Writing
DT90370	Control flag monitor area	HSC-CH0	When HSC control is executed by F0 (MV)S, DT90052 instruction, the setting value for the target CH is stored in each CH.	A	N/A
DT90371		HSC-CH1		A	N/A
DT90372		HSC-CH2		A	N/A
DT90373		HSC-CH3		A	N/A
DT90374		HSC-CH4		A	N/A
DT90375		HSC-CH5		A	N/A
DT90376	Not used		-	N/A	N/A
DT90377	Not used		-	N/A	N/A
DT90378	Not used		-	N/A	N/A
DT90379	Not used		-	N/A	N/A
DT90380	Control flag monitor area (Transistor output type only)	PLS-CH0	When pulse output control is executed by F0 (MV)S, DT90052 instruction, the setting value for the target CH is stored in each CH.	A	N/A
DT90381		PLS-CH1		A	N/A
DT90382		PLS-CH2		A	N/A
DT90383		PLS-CH3		A	N/A
DT90384	Not used		-	N/A	N/A
DT90385	Not used		-	N/A	N/A
DT90386	Not used		-	N/A	N/A
DT90387	Not used		-	N/A	N/A
DT90388	Not used		-	N/A	N/A
DT90389	Not used		-	N/A	N/A

Address	Name		Description	Reading	Writing	
DT90400	Elapsed value area	Lower words	Available for the transistor output type only. Note) When controlling the pulse output CH by F166(HC1S), F167(HC1R) instructions, the target value is stored. The target value for match ON/OFF is stored.	A	A	
DT90401		Higher words		A	A	
DT90402	Target value area	Lower words		A	N/A	
DT90403		Higher words		A	N/A	
DT90404	Target value area for match ON/OFF	Lower words		A	N/A	
DT90405		Higher words		A	N/A	
DT90406	Corrected speed of initial speed	Lower words	PLS-CH0	The initial speed of the calculated result is stored.	A	N/A
DT90407	Deceleration minimum speed			The minimum speed for the change of speed.	A	N/A
DT90408	Acceleration forbidden area starting position	Lower words	PLS-CH0	If the elapsed value crosses over this position when changing the speed, acceleration cannot be performed.	A	N/A
DT90409		Higher words			A	N/A
DT90410	Elapsed value area	Lower words	PLS-CH1	Available for the transistor output type only. Note) When controlling the pulse output CH by F166(HC1S), F167(HC1R) instructions, the target value is stored. The target value for match ON/OFF is stored.	A	A
DT90411		Higher words			A	A
DT90412	Target value area	Lower words			A	N/A
DT90413		Higher words			A	N/A
DT90414	Target value area for match ON/OFF	Lower words			A	N/A
DT90415		Higher words			A	N/A
DT90416	Corrected speed of initial speed	Lower words	PLS-CH1	The initial speed of the calculated result is stored.	A	N/A
DT90417	Deceleration minimum speed			The minimum speed for the change of speed.	A	N/A
DT90418	Acceleration forbidden area starting position	Lower words	PLS-CH1	If the elapsed value crosses over this position when changing the speed, acceleration cannot be performed.	A	N/A
DT90419		Higher words			A	N/A

Address	Name		Description	Reading	Writing	
DT90420	Elapsed value area	Lower words	Available for the transistor output type only. Note) When controlling the pulse output CH by F166(HC1S), F167(HC1R) instructions, the target value is stored. The target value for match ON/OFF is stored.	A	A	
DT90421		Higher words		A	A	
DT90422	Target value area	Lower words		A	N/A	
DT90423		Higher words		A	N/A	
DT90424	Target value area for match ON/OFF	Lower words		A	N/A	
DT90425		Higher words		A	N/A	
DT90426	Corrected speed of initial speed	Lower words		PLS-CH2	A	N/A
DT90427	Deceleration minimum speed			A	N/A	
DT90428	Acceleration forbidden area starting position	Lower words		If the elapsed value crosses over this position when changing the speed, acceleration cannot be performed.	A	N/A
DT90429		Higher words			A	N/A
DT90430	Elapsed value area	Lower words	Available for the transistor output type only. Note) When controlling the pulse output CH by F166(HC1S), F167(HC1R) instructions, the target value is stored. The target value for match ON/OFF is stored.	A	A	
DT90431		Higher words		A	A	
DT90432	Target value area	Lower words		A	N/A	
DT90433		Higher words		A	N/A	
DT90434	Target value area for match ON/OFF	Lower words		A	N/A	
DT90435		Higher words		A	N/A	
DT90436	Corrected speed of initial speed	Lower words		PLS-CH3	A	N/A
DT90437	Deceleration minimum speed			A	N/A	
DT90438	Acceleration forbidden area starting position	Lower words		If the elapsed value crosses over this position when changing the speed, acceleration cannot be performed.	A	N/A
DT90439		Higher words			A	N/A

15.2 Table of Basic Instructions

Name	Boolean	Symbol	Description	Steps *3	FP0/FP-e	FP0R	FPΣ	FP-X	FP2	FP2SH/FP10SH
Sequence basic instructions										
Start	ST		Begins a logic operation with a Form A (normally open) contact.	1 (2)	○	○	○	○	○	○
Start Not	ST/		Begins a logic operation with a Form B (normally closed) contact.	1 (2)	○	○	○	○	○	○
Out	OT		Outputs the operated result to the specified output.	1 (2)	○	○	○	○	○	○
Not	/		Inverts the operated result up to this instruction.	1	○	○	○	○	○	○
AND	AN		Connects a Form A (normally open) contact serially.	1 (2)	○	○	○	○	○	○
AND Not	AN/		Connects a Form B (normally closed) contact serially.	1 (2)	○	○	○	○	○	○
OR	OR		Connects a Form A (normally open) contact in parallel.	1 (2)	○	○	○	○	○	○
OR Not	OR/		Connects a Form B (normally closed) contact in parallel.	1 (2)	○	○	○	○	○	○
Leading edge start	ST↑		Begins a logic operation only for one scan when the leading edge of the trigger is detected.	2	×	○	△*2	△*2	○	○
Trailing edge start	ST↓		Begins a logic operation only for one scan when the trailing edge of the trigger is detected.	2	×	○	△*2	△*2	○	○
Leading edge AND	AN↑		Connects a Form A (normally open) contact serially only for one scan when the leading edge of the trigger is detected.	2	×	○	△*2	△*2	○	○
Trailing edge AND	AN↓		Connects a Form A (normally open) contact serially only for one scan when the trailing edge of the trigger is detected.	2	×	○	△*2	△*2	○	○
Leading edge OR	OR↑		Connects a Form A (normally open) contact in parallel only for one scan when the leading edge of the trigger is detected.	2	×	○	△*2	△*2	○	○
Trailing edge OR	OR↓		Connects a Form A (normally open) contact in parallel only for one scan when the trailing edge of the trigger is detected.	2	×	○	△*2	△*2	○	○
Leading edge out	OT↑		Outputs the operated result to the specified output only for one scan when leading edge of the trigger is detected. (for pulse relay)	2	×	×	×	×	○	○
Trailing edge out	OT↓		Outputs the operated result to the specified output only for one scan when trailing edge of the trigger is detected. (for pulse relay)	2	×	×	×	×	○	○
Alternative out	ALT		Inverts the output condition (on/off) each time the leading edge of the trigger is detected.	3	×	○	○	○	○	○
AND stack	ANS		Connects the multiple instruction blocks serially.	1	○	○	○	○	○	○
OR stack	ORS		Connects the multiple instruction blocks in parallel.	1	○	○	○	○	○	○

○ : Available, × : Not available, △ : Not available partially

*1) The type of the devices that can be specified depends on the models.

*2) This instruction is available for FP-X Ver. 2.0 or later, and FPΣ Ver. 3.10 or later.

*3) In the FP2/FP2SH/10SH, when using X1280, Y1280, R1120 (special internal relay included), L1280, T256, C256 or anything beyond for the ST, ST/, OT, AN, AN/, OR and OR/ instructions, the number of steps is shown in parentheses. Also, in the FP2/FP2SH/FP10SH, when a relay number has an index modifier, the number of steps is shown in parentheses. For the FPΣ and FP-X, the number of steps varies according to the relay number to be used.

Name	Boolean	Symbol	Description	Steps *5 *6	FP0/FP-e	FP0R	FPΣ	FP-X	FP2	FP2SH/FP10SH
Push stack	PSHS		Stores the operated result up to this instruction. *2	1	○	○	○	○	○	○
Read stack	RDS		Reads the operated result stored by the PSHS instruction. *2	1	○	○	○	○	○	○
Pop stack	POPS		Reads and clears the operated result stored by the PSHS instruction	1	○	○	○	○	○	○
Leading edge differential	DF		Turns on the contact for only one scan when the leading edge of the trigger is detected.	1	○	○	○	○	○	○
Trailing edge differential	DF/		Turns on the contact for only one scan when the trailing edge of the trigger is detected.	1	○	○	○	○	○	○
Leading edge differential (initial execution type)	DFI		Turns on the contact for only one scan when the leading edge of the trigger is detected. The leading edge detection is possible on the first scan.	1	×	○	○	○	○	○
Set	SET		Output is set to and held at on.	3	○	○	○	○	○	○
Reset	RST		Output is set to and held at off.	3	○	○	○	○	○	○
Keep	KP		Outputs at set trigger and holds until reset trigger turns on.	1 (2)	○	○	○	○	○	○
No operation	NOP		No operation.	1	○	○	○	○	○	○
Basic function instructions										
On-delay timer	TML		After set value "n" x 0.001 seconds, timer contact "a" is set to on.	3 (4)	○	○	○	○	○	○ *3
	TMR		After set value "n" x 0.01 seconds, timer contact "a" is set to on.	3 (4)	○	○	○	○	○	○ *3
	TMX		After set value "n" x 0.1 seconds, timer contact "a" is set to on.	3 (4)	○	○	○	○	○	○ *3
	TMY		After set value "n" x 1 second, timer contact "a" is set to on.	4 (5)	○	○	○	○	○	○ *3
Auxiliary timer (16-bit)	F137 (STMR)		After set value "S" x 0.01 seconds, the specified output and R900D are set to on.	5	○	○	○	○	○	
Auxiliary timer (32-bit)	F183 (DSTM)		After set value "S" x 0.01 seconds, the specified output and R900D are set to on.	7	○	○	○	○	○	
Time constant processing	F182		Executes the filter processing for the specified input.	9	×	○	○	○	×	×
Counter	CT		Decrements from the preset value "n"	3 (4)	○	○	○	○	○	○ *3

○ : Available, × : Not available, △ : Not available partially

*1) The type of the devices that can be specified depends on the models.





*2) The allowable number of using the PSHS and RDS instruction depends on the models.

*3) For FP2SH, FP10SH and FP-X Ver2.0 or later, any device can be set for the setting value of counter or timer instruction.

*4) This instruction is available for FP-X Ver. 2.0 or later.

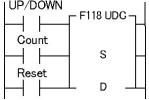
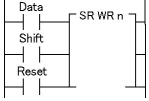
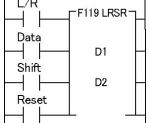
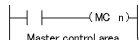
*5) In the FP2/FP2SH/FP10SH, when using Y1280, R1120 (special internal relay included), L1280 or anything beyond for the KP instruction, the number of steps is shown in parentheses. Also, in the FP2/FP2SH/FP10SH, when a relay number has an index modifier, the number of steps is shown in parentheses.

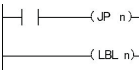
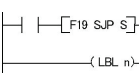
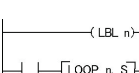
*6) In the FP2/FP2SH/FP10SH, when timer 256 or higher, or counter 255 or lower, is used, the number of steps is the number in parentheses. Also, in the FP2/FP2SH/FP10SH, when a timer number or counter number has an index modifier, the number of steps is the number in parentheses. For the FPΣ and FP-X, the number of steps varies according to the specified timer number or counter number.

Name	Boolean	Symbol	Description	Steps	FP0/FP-e	FP0R	FPΣ	FP-X	FP2	FP2SH/FP10SH
UP/DOWN counter	F118 (UDC)		Increments or decrements from the preset value "S" based on up/down input.	5	○	○	○	○	○	○
Shift register	SR		Shifts one bit of 16-bit [word internal relay (WR)] data to the left.	1 (2) *1	○	○	○	○	○	○
Left/right shift register	F119 (LRSR)		Shifts one bit of 16-bit data range specified by "D1" and "D2" to the left or to the right.	5	○	○	○	○	○	○
Control instructions										
Master control relay	MC		Starts the master control program.	2	○	○	○	○	○	○
Master control relay end	MCE		Ends the master control program.	2	○	○	○	○	○	○
Jump	JP		The program jumps to the label instruction and continues from there.	2 (3) *2	○	○	○	○	○	○
Label	LBL			1						
Auxiliary jump	F19 (SJP)		The program jumps to the label instruction specified by "S" and continues from there.	3	×	×	×	×	○	○
Label	LBL			1						
Loop	LOOP		The program jumps to the label instruction and continues from there (the number of jumps is set in "S").	4 (5) *3	○	○	○	○	○	○
Label	LBL			1						
Break	BRK		Stops program execution when the predetermined trigger turns on in the TEST/RUN mode only.	1	×	×	×	×	○	○

○ : Available, × : Not available, △ : Not available partially

*1) In the FP2/FP2SH/FP10SH, when internal relay WR240 or higher is used, the number of steps is the number in parentheses. Also, in the FP2/FP2SH/FP10SH, when the specified internal relay number (word address) has an index modifier, the number of steps is the number in parentheses.

*2) In the FP2/FP2SH/FP10SH, when the number "n" in a jump instruction has an index modifier, the number of steps is the number in parentheses.

*3) In the FP2/FP2SH/FP10SH, when the number "n" in a loop instruction has an index modifier, the number of steps is the number in parentheses.

Name	Boolean	Symbol	Description	Steps	FP0/FP-e	FP0R	FPΣ	FP-X	FP2	FP2SH/FP10SH
End	ED		The operation of program is ended. Indicates the end of a main program.	1	○	○	○	○	○	○
Conditional end	CNDE		The operation of program is ended when the trigger turns on.	1	○	○	○	○	○	○
Eject	EJECT		Adds page break for use when printing.	1	×	○	○	○	○	○
Step ladder instructions										
Start step	SSTP		The start of program "n" for process control	3	○	○	○	○	○	○
Next step	NSTL		Starts the specified process "n" and clears the process currently started. (Scan execution type)	3	○	○	○	○	○	○
	NSTP		Starts the specified process "n" and clears the process currently started. (Pulse execution type)	3	○	○	○	○	○	○
Clear step	CSTP		Resets the specified process "n".	3	○	○	○	○	○	○
Clear multiple steps	SCLR		Resets multiple processes specified by "n1" and "n2".	5	△ *1	○	○	○	○	○
Step end	STPE		End of step ladder area	1	○	○	○	○	○	○
Subroutine instructions										
Subroutine call	CALL		When the trigger is on: Executes the subroutine. When the trigger is off: Not execute the subroutine. The output in the subroutine is maintained.	2 (3) *2	○	○	○	○	○	○
Output off type subroutine call	FCAL		When the trigger is on: Executes the subroutine. When the trigger is off: Not execute the subroutine. But, the output in the subroutine is cleared.	4 (5) *2	×	×	×	×	×	○
Subroutine entry	SUB		Indicates the start of the subroutine program "n".	1	○	○	○	○	○	○
Subroutine return	RET		Ends the subroutine program.	1	○	○	○	○	○	○
Interrupt instructions										
Interrupt	INT		Indicates the start of the interrupt program "n".	1	○	○	○	○	○	○
Interrupt return	IRET		Ends the interrupt program.	1	○	○	○	○	○	○
Interrupt control	ICTL		Select interrupt enable/disable or clear in "S1" and "S2" and execute.	5	○	○	○	○	○	○

○ : Available, × : Not available, △ : Not available partially

*1) Available for FP-e only.

*2) In the FP2/FP2SH/FP10SH, when the number "n" of a subroutine program has an index modifier, the number of steps is the number in parentheses.

Name	Boolean	Symbol	Description	Steps	FP0/FP-e	FP0R	FPΣ	FP-X	FP2	FP2SH/FP10SH
Special setting instructions										
Communication conditions setting	SYS1	┌ ─┬─┐ [DP] [SYS1.M] ─┬─┐	Change the communication conditions for the COM port or tool port based on the contents specified by the character constant.	13	×	○	○ ^{*1}	○ ^{*1}	×	×
Password setting			Change the password specified by the PLC based on the contents specified by the character constant.		×	○	○ ^{*2}	○	×	×
Interrupt setting			Set the interrupt input based on the contents specified by the character constant.		×	○	○	○	×	×
PLC link time setting			Set the system setting time when a PLC link is used, based on the contents specified by the character constant.		×	○	○	○	×	×
MEWTOCOL-COM response control			Change the communication conditions of the COM. port or tool port for MEWTOCOL-COM based on the contents specified by the character constant.		×	○	○	○	×	×
High-speed counter operation mode changing			Change the operation mode of the high-speed counter, based on the contents specified by the character constant.		×	○	○ ^{*3}	○ ^{*3}	×	×
System registers "No. 40 to No. 47" changing	SYS2	┌ ─┬─┐ [SYS2.S.D1.D2] ─┬─┐	Change the setting value of the system register for the PLC link function.	7	×	○	○	○	×	×

○ : Available, × : Not available, △ : Not available partially

*1) With FP-X Ver2.0 or later, and FPΣ Ver 3.10 or later, the baud rate can be selected from 300, 600 or 1200 bps.

*2) With FPΣ 32k type, the 8-digit password can be selected.

*3) With FPΣ 32k type and FP-X Ver1.10 or later, it can be used.

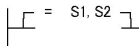
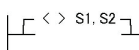
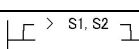
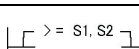
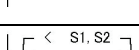
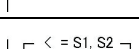
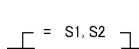
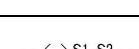
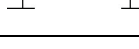
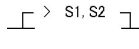
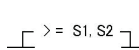
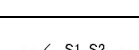
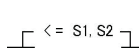
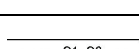
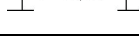
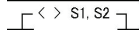
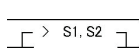
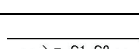
Name	Boolean	Symbol	Description	Steps	FP0/FP-e	FP0R	FPΣ	FP-X	FP2	FP2SH/FP10SH
Data compare instructions										
16-bit data compare (Start)	ST=		Begins a logic operation by comparing two 16-bit data in the comparative condition "S1=S2".	5	○	○	○	○	○	○
	ST<>		Begins a logic operation by comparing two 16-bit data in the comparative condition "S1<S2" or "S1>S2".	5	○	○	○	○	○	○
	ST>		Begins a logic operation by comparing two 16-bit data in the comparative condition "S1>S2".	5	○	○	○	○	○	○
	ST>=		Begins a logic operation by comparing two 16-bit data in the comparative condition "S1>S2" or "S1=S2".	5	○	○	○	○	○	○
	ST<		Begins a logic operation by comparing two 16-bit data in the comparative condition "S1<S2".	5	○	○	○	○	○	○
	ST<=		Begins a logic operation by comparing two 16-bit data in the comparative condition "S1<S2" or "S1=S2".	5	○	○	○	○	○	○
16-bit data compare (AND)	AN=		Connects a Form A (normally open) contact serially by comparing two 16-bit data in the comparative condition "S1=S2".	5	○	○	○	○	○	○
	AN<>		Connects a Form A (normally open) contact serially by comparing two 16-bit data in the comparative condition "S1<S2" or "S1>S2".	5	○	○	○	○	○	○
	AN>		Connects a Form A (normally open) contact serially by comparing two 16-bit data in the comparative condition "S1>S2".	5	○	○	○	○	○	○
	AN>=		Connects a Form A (normally open) contact serially by comparing two 16-bit data in the comparative condition "S1>S2" or "S1=S2".	5	○	○	○	○	○	○
	AN<		Connects a Form A (normally open) contact serially by comparing two 16-bit data in the comparative condition "S1<S2".	5	○	○	○	○	○	○
	AN<=		Connects a Form A (normally open) contact serially by comparing two 16-bit data in the comparative condition "S1<S2" or "S1=S2".	5	○	○	○	○	○	○
16-bit data compare (OR)	OR=		Connects a Form A (normally open) contact in parallel by comparing two 16-bit data in the comparative condition "S1=S2".	5	○	○	○	○	○	○
	OR<>		Connects a Form A (normally open) contact in parallel by comparing two 16-bit data in the comparative condition "S1<S2" or "S1>S2".	5	○	○	○	○	○	○
	OR>		Connects a Form A (normally open) contact in parallel by comparing two 16-bit data in the comparative condition "S1>S2".	5	○	○	○	○	○	○
	OR>=		Connects a Form A (normally open) contact in parallel by comparing two 16-bit data in the comparative condition "S1>S2" or "S1=S2".	5	○	○	○	○	○	○
	OR<		Connects a Form A (normally open) contact in parallel by comparing two 16-bit data in the comparative condition "S1<S2".	5	○	○	○	○	○	○
	OR<=		Connects a Form A (normally open) contact in parallel by comparing two 16-bit data in the comparative condition "S1<S2" or "S1=S2".	5	○	○	○	○	○	○

○ : Available, × : Not available, △ : Not available partially

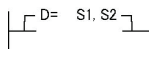
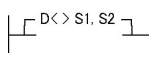
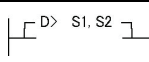
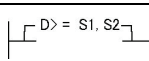
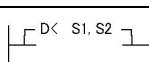
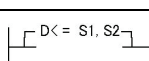
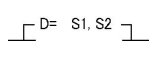
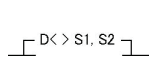
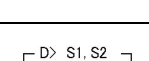
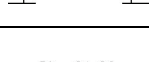
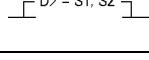
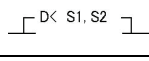
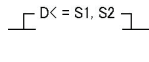
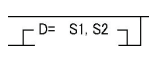
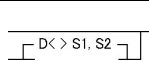
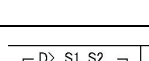
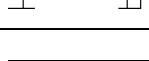
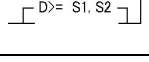
Name	Boolean	Symbol	Description	Steps	FP0/FP-e	FP0R	FPΣ	FP-X	FP2	FP2SH/FP10SH
32-bit data compare (Start)	STD=		Begins a logic operation by comparing two 32-bit data in the comparative condition "(S1+1, S1)=(S2+1, S2)".	9	○	○	○	○	○	○
	STD<>		Begins a logic operation by comparing two 32-bit data in the comparative condition "(S1+1, S1)<(S2+1, S2)" or "(S1+1, S1)>(S2+1, S2)".	9	○	○	○	○	○	○
	STD>		Begins a logic operation by comparing two 32-bit data in the comparative condition "(S1+1, S1)>(S2+1, S2)".	9	○	○	○	○	○	○
	STD>=		Begins a logic operation by comparing two 32-bit data in the comparative condition "(S1+1, S1)>(S2+1, S2)" or "(S1+1, S1)=(S2+1, S2)".	9	○	○	○	○	○	○
	STD<		Begins a logic operation by comparing two 32-bit data in the comparative condition "(S1+1, S1)<(S2+1, S2)".	9	○	○	○	○	○	○
	STD<=		Begins a logic operation by comparing two 32-bit data in the comparative condition "(S1+1, S1)<(S2+1, S2)" or "(S1+1, S1)=(S2+1, S2)".	9	○	○	○	○	○	○
32-bit data compare (AND)	AND=		Connects a Form A (normally open) contact serially by comparing two 32-bit data in the comparative condition "(S1+1, S1)=(S2+1, S2)".	9	○	○	○	○	○	○
	AND<>		Connects a Form A (normally open) contact serially by comparing two 32-bit data in the comparative condition "(S1+1, S1)<(S2+1, S2)" or "(S1+1, S1)>(S2+1, S2)".	9	○	○	○	○	○	○
	AND>		Connects a Form A (normally open) contact serially by comparing two 32-bit data in the comparative condition "(S1+1, S1)>(S2+1, S2)".	9	○	○	○	○	○	○
	AND>=		Connects a Form A (normally open) contact serially by comparing two 32-bit data in the comparative condition "(S1+1, S1)>(S2+1, S2)" or "(S1+1, S1)=(S2+1, S2)".	9	○	○	○	○	○	○
	AND<		Connects a Form A (normally open) contact serially by comparing two 32-bit data in the comparative condition "(S1+1, S1)<(S2+1, S2)".	9	○	○	○	○	○	○
	AND<=		Connects a Form A (normally open) contact serially by comparing two 32-bit data in the comparative condition "(S1+1, S1)<(S2+1, S2)" or "(S1+1, S1)=(S2+1, S2)".	9	○	○	○	○	○	○
32-bit data compare (OR)	ORD=		Connects a Form A (normally open) contact in parallel by comparing two 32-bit data in the comparative condition "(S1+1, S1)=(S2+1, S2)".	9	○	○	○	○	○	○
	ORD<>		Connects a Form A (normally open) contact in parallel by comparing two 32-bit data in the comparative condition "(S1+1, S1)<(S2+1, S2)" or "(S1+1, S1)>(S2+1, S2)".	9	○	○	○	○	○	○
	ORD>		Connects a Form A (normally open) contact in parallel by comparing two 32-bit data in the comparative condition "(S1+1, S1)>(S2+1, S2)".	9	○	○	○	○	○	○
	ORD>=		Connects a Form A (normally open) contact in parallel by comparing two 32-bit data in the comparative condition "(S1+1, S1)>(S2+1, S2)" or "(S1+1, S1)=(S2+1, S2)".	9	○	○	○	○	○	○
	ORD<		Connects a Form A (normally open) contact in parallel by comparing two 32-bit data in the comparative condition "(S1+1, S1)<(S2+1, S2)".	9	○	○	○	○	○	○
	ORD<=		Connects a Form A (normally open) contact in parallel by comparing two 32-bit data in the comparative condition "(S1+1, S1)<(S2+1, S2)" or "(S1+1, S1)=(S2+1, S2)".	9	○	○	○	○	○	○

○ : Available, × : Not available, △ : Not available partially

Name	Boolean	Symbol	Description	Steps	FP0/FP-e	FP0R	FPΣ	FP-X	FP2	FP2SH/FP10SH
Floating point type real number data compare (Start)	STF=		Begins a logic operation by comparing two 32-bit data in the comparative condition "(S1+1, S1)=(S2+1, S2)".	9	×	○	△ ^{*1}	△ ^{*1}	×	×
	STF<>		Begins a logic operation by comparing two 32-bit data in the comparative condition "(S1+1, S1)<(S2+1, S2)" or "(S1+1, S1)>(S2+1, S2)".	9	×	○	△ ^{*1}	△ ^{*1}	×	×
	STF>		Begins a logic operation by comparing two 32-bit data in the comparative condition "(S1+1, S1)>(S2+1, S2)".	9	×	○	△ ^{*1}	△ ^{*1}	×	×
	STF>=		Begins a logic operation by comparing two 32-bit data in the comparative condition "(S1+1, S1)>(S2+1, S2)" or "(S1+1, S1)=(S2+1, S2)".	9	×	○	△ ^{*1}	△ ^{*1}	×	×
	STF<		Begins a logic operation by comparing two 32-bit data in the comparative condition "(S1+1, S1)<(S2+1, S2)".	9	×	○	△ ^{*1}	△ ^{*1}	×	×
	STF<=		Begins a logic operation by comparing two 32-bit data in the comparative condition "(S1+1, S1)<(S2+1, S2)" or "(S1+1, S1)=(S2+1, S2)".	9	×	○	△ ^{*1}	△ ^{*1}	×	×
Floating point type real number data compare (AND)	ANF=		Connects a Form A (normally open) contact serially by comparing two 32-bit data in the comparative condition "(S1+1, S1)=(S2+1, S2)".	9	×	○	△ ^{*1}	△ ^{*1}	×	×
	ANF<>		Connects a Form A (normally open) contact serially by comparing two 32-bit data in the comparative condition "(S1+1, S1)<(S2+1, S2)" or "(S1+1, S1)>(S2+1, S2)".	9	×	○	△ ^{*1}	△ ^{*1}	×	×
	ANF>		Connects a Form A (normally open) contact serially by comparing two 32-bit data in the comparative condition "(S1+1, S1)>(S2+1, S2)".	9	×	○	△ ^{*1}	△ ^{*1}	×	×
	ANF>=		Connects a Form A (normally open) contact serially by comparing two 32-bit data in the comparative condition "(S1+1, S1)>(S2+1, S2)" or "(S1+1, S1)=(S2+1, S2)".	9	×	○	△ ^{*1}	△ ^{*1}	×	×
	ANF<		Connects a Form A (normally open) contact serially by comparing two 32-bit data in the comparative condition "(S1+1, S1)<(S2+1, S2)".	9	×	○	△ ^{*1}	△ ^{*1}	×	×
	ANF<=		Connects a Form A (normally open) contact serially by comparing two 32-bit data in the comparative condition "(S1+1, S1)<(S2+1, S2)" or "(S1+1, S1)=(S2+1, S2)".	9	×	○	△ ^{*1}	△ ^{*1}	×	×
Floating point type real number data compare (OR)	ORF=		Connects a Form A (normally open) contact in parallel by comparing two 32-bit data in the comparative condition "(S1+1, S1)=(S2+1, S2)".	9	×	○	△ ^{*1}	△ ^{*1}	×	×
	ORF<>		Connects a Form A (normally open) contact in parallel by comparing two 32-bit data in the comparative condition "(S1+1, S1)<(S2+1, S2)" or "(S1+1, S1)>(S2+1, S2)".	9	×	○	△ ^{*1}	△ ^{*1}	×	×
	ORF>		Connects a Form A (normally open) contact in parallel by comparing two 32-bit data in the comparative condition "(S1+1, S1)>(S2+1, S2)".	9	×	○	△ ^{*1}	△ ^{*1}	×	×
	ORF>=		Connects a Form A (normally open) contact in parallel by comparing two 32-bit data in the comparative condition "(S1+1, S1)>(S2+1, S2)" or "(S1+1, S1)=(S2+1, S2)".	9	×	○	△ ^{*1}	△ ^{*1}	×	×
	ORF<		Connects a Form A (normally open) contact in parallel by comparing two 32-bit data in the comparative condition "(S1+1, S1)<(S2+1, S2)".	9	×	○	△ ^{*1}	△ ^{*1}	×	×
	ORF<=		Connects a Form A (normally open) contact in parallel by comparing two 32-bit data in the comparative condition "(S1+1, S1)<(S2+1, S2)" or "(S1+1, S1)=(S2+1, S2)".	9	×	○	△ ^{*1}	△ ^{*1}	×	×

○ : Available, × : Not available, △ : Not available partially

*1) This instruction is available for FP-X V1.10 or later and FPΣ 32k type

15.3 Table of High-level Instructions

The high-level instructions are expressed by the prefixes “F” or “P” with numbers. For most of the high-level instructions, “F” and “P” types are available. The differences between the two types are explained as follows:

- Instructions with the prefix “F” are executed in every scan while its trigger is in the on.
- Instructions with the prefix “P” are executed only when the leading edge of its trigger is detected.

For the FP0/FP0R/FPΣ/FP-X, the P type high-level instructions are not available.

Number	Name	Boolean	Operand	Description	Steps	FP0/FP-e	FP0R	FPΣ	FP-X	FP2	FP2SH/FP10SH
Data transfer instructions											
F0 P0	16-bit data move	MV PMV	S, D	(S)→(D)	5	○	○	○	○	○	○
F1 P1	32-bit data move	DMV PDMV	S, D	(S+1, S)→(D+1, D)	7	○	○	○	○	○	○
F2 P2	16-bit data invert and move	MV PMV/	S, D	(S)→(D)	5	○	○	○	○	○	○
F3 P3	32-bit data invert and move	DMV/ PDMV/	S, D	(S+1, S)→(D+1, D)	7	○	○	○	○	○	○
F4 P4	Reading of head word No. of the specified slot	GETS PGETS	S, D	The head word No. of the specified slot is read.	5	×	×	×	×	△ ₁	△ ₁
F5 P5	Bit data move	BTM PBTM	S, n, D	The specified one bit in “S” is transferred to the specified one bit in “D”. The bit is specified by “n”.	7	○	○	○	○	○	○
F6 P6	Hexadecimal digit (4-bit) data move	DGT PDGT	S, n, d	The specified one digit in “S” is transferred to the specified one digit in “D”. The digit is specified by “n”.	7	○	○	○	○	○	○
F7 P7	Two 16-bit data move	MV2 PMV2	S1, S2, D	(S1)→(D), (S2)→(D+1)	7	×	○	○	○	○	○
F8 P8	Two 32-bit data move	DMV2 PDMV2	S1, S2, D	(S1+1, S1)→(D+1, D), (S2+1, S2)→(D+3, D+2)	11	×	○	○	○	○	○
F10 P10	Block move	BKMV PBKMV	S1, S2, D	The data between “S1” and “S2” is transferred to the area starting at “D”.	7	○	○	○	○	○	○
F11 P11	Block copy	COPY PCOPY	S, D1, D2	The data of “S” is transferred to the all area between “D1” and “D2”.	7	○	○	○	○	○	○
F12 P12	Data read from EEPROM	ICRD	S1, S2, D	The data stored in the expansion memory of the EEPROM specified by “S1” and “S2” are transferred to the area starting at “D”.	11	○ ₂	×	×	×	×	×
F12 P12	Data write to EEPROM	PICWT	S1, S2, D	The data specified by “S1” and “S2” are transferred to the EEPROM starting at “D”.	11	○ ₂	×	×	×	×	×
F12 P12	Data read from F-ROM	ICRD	S1, S2, D	The data stored in the expansion memory of the F-ROM specified by “S1” and “S2” are transferred to the area starting at “D”.	11	×	○	○	○	×	×
F12 P12	Data write to F-ROM	PICWT	S1, S2, D	The data specified by “S1” and “S2” are transferred to the F-ROM starting at “D”.	11	×	○	○	○	×	×
F12 P12	Data read from IC card	ICRD PICRD	S1, S2, D	The data stored in the expansion memory of the IC card specified by “S1” and “S2” are transferred to the area starting at “D”.	11	×	×	×	×	×	○
F13 P13	Data write to IC card	ICWT PICWT	S1, S2, D	The data specified by “S1” and “S2” are transferred to the IC card expansion memory area starting at “D”.	11	×	×	×	×	×	○
F14 P14	Program read from IC memory card	PGRD PPGRD	S	The program specified using “S” is transferred into the CPU from IC memory card and executes it.	3	×	×	×	×	×	○

○ : Available, × : Not available, △ : Not available partially

*1) This instruction is available for FP2/FP2SH Ver. 1.5 or later. FP10SH cannot be used

*2) This instruction is available for FP0 Ver. 2.0 or later and FP-e.

Number	Name	Boo-lean	Operand	Description	Steps	FP0/FP-e	FP0R	FP2	FP-X	FP2	FP2SH/FP10SH
F15 P15	16-bit data exchange	XCH PXCH	D1, D2	(D1)→(D2), (D2)→(D1)	5	○	○	○	○	○	○
F16 P16	32-bit data exchange	DXCH PDXCH	D1, D2	(D1+1, D1)→(D2+1, D2) (D2+1, D2)→(D1+1, D1)	5	○	○	○	○	○	○
F17 P17	Higher/lower byte in 16-bit data exchange	SWAP PSWAP	D	The higher byte and lower byte of "D" are exchanged.	3	○	○	○	○	○	○
F18 P18	16-bit data block exchange	BXCH PBXCH	D1, D2, D3	Exchange the data between "D1" and "D2" with the data specified by "D3".	7	×	○	○	○	○	○
Control instruction											
F19	Auxiliary jump	SJP	S	The program jumps to the label instruction specified by "S" and continues from there.	3	×	×	×	×	○	○
Binary arithmetic instructions											
F20 P20	16-bit data addition	+ P+	S, D	(D)+(S)→(D)	5	○	○	○	○	○	○
F21 P21	32-bit data addition	D+ PD+	S, D	(D+1, D)+(S+1, S)→(D+1, D)	7	○	○	○	○	○	○
F22 P22	16-bit data addition	+ P+	S1, S2, D	(S1)+(S2)→(D)	7	○	○	○	○	○	○
F23 P23	32-bit data addition	D+ PD+	S1, S2, D	(S1+1, S1)+(S2+1, S2)→(D+1, D)	11	○	○	○	○	○	○
F25 P25	16-bit data subtraction	- P-	S, D	(D)-(S)→(D)	5	○	○	○	○	○	○
F26 P26	32-bit data subtraction	D- PD-	S, D	(D+1, D)-(S+1, S)→(D+1, D)	7	○	○	○	○	○	○
F27 P27	16-bit data subtraction	- P-	S1, S2, D	(S1)-(S2)→(D)	7	○	○	○	○	○	○
F28 P28	32-bit data subtraction	D- PD-	S1, S2, D	(S1+1, S1)-(S2+1, S2)→(D+1, D)	11	○	○	○	○	○	○
F30 P30	16-bit data multiplication	* P*	S1, S2, D	(S1)X(S2)→(D+1, D)	7	○	○	○	○	○	○
F31 P31	32-bit data multiplication	D* PD*	S1, S2, D	(S1+1, S1)X(S2+1, S2)→(D+3, D+2, D+1, D)	11	○	○	○	○	○	○
F32 P32	16-bit data division	% P%	S1, S2, D	(S1)÷(S2)→quotient (D) remainder (DT9015)	7	○	○	○	○	○	○
F33 P33	32-bit data division	D% PD%	S1, S2, D	(S1+1, S1)÷(S2+1, S2)→quotient (D+1, D) remainder (DT9016, DT9015)	11	○	○	○	○	○	○
F34 P34	16-bit data multiplication (result in 16 bits)	*W P*W	S1, S2, D	(S1)X(S2)→(D)	7	×	○	○	○	○	○
F35 P35	16-bit data increment	+1 P+1	D	(D)+1→(D)	3	○	○	○	○	○	○
F36 P36	32-bit data increment	D+1 PD+1	D	(D+1, D)+1→(D+1, D)	3	○	○	○	○	○	○
F37 P37	16-bit data decrement	-1 P-1	D	(D)-1→(D)	3	○	○	○	○	○	○
F38 P38	32-bit data decrement	D-1 PD-1	D	(D+1, D)-1→(D+1, D)	3	○	○	○	○	○	○
F39 P39	32-bit data multiplication (result in 32 bits)	D*D PD*D	S1, S2, D	(S1+1, S1)X(S2+1, S2)→(D+1, D)	11	×	○	○	○	○	○

○ : Available, × : Not available, △ : Not available partially

Number	Name	Boolean	Operand	Description	Steps	FP0/FP-e	FP0R	FPΣ	FP-X	FP2	FP2SH/FP10SH
BCD arithmetic instructions											
F40 P40	4-digit BCD data addition	B+ PB+	S, D	$(D)+(S) \rightarrow (D)$	5	○	○	○	○	○	○
F41 P41	8-digit BCD data addition	DB+ PDB+	S, D	$(D+1, D)+(S+1, S) \rightarrow (D+1, D)$	7	○	○	○	○	○	○
F42 P42	4-digit BCD data addition	B+ PB+	S1, S2, D	$(S1)+(S2) \rightarrow (D)$	7	○	○	○	○	○	○
F43 P43	8-digit BCD data addition	DB+ PDB+	S1, S2, D	$(S1+1, S1)+(S2+1, S2) \rightarrow (D+1, D)$	11	○	○	○	○	○	○
F45 P45	4-digit BCD data subtraction	B- PB-	S, D	$(D)-(S) \rightarrow (D)$	5	○	○	○	○	○	○
F46 P46	8-digit BCD data subtraction	DB- PDB-	S, D	$(D+1, D)-(S+1, S) \rightarrow (D+1, D)$	7	○	○	○	○	○	○
F47 P47	4-digit BCD data subtraction	B- PB-	S1, S2, D	$(S1)-(S2) \rightarrow (D)$	7	○	○	○	○	○	○
F48 P48	8-digit BCD data subtraction	DB- PDB-	S1, S2, D	$(S1+1, S1)-(S2+1, S2) \rightarrow (D+1, D)$	11	○	○	○	○	○	○
F50 P50	4-digit BCD data multiplication	B* PB*	S1, S2, D	$(S1) \times (S2) \rightarrow (D+1, D)$	7	○	○	○	○	○	○
F51 P51	8-digit BCD data multiplication	DB* PDB*	S1, S2, D	$(S1+1, S1) \times (S2+1, S2) \rightarrow (D+3, D+2, D+1, D)$	11	○	○	○	○	○	○
F52 P52	4-digit BCD data division	B% PB%	S1, S2, D	$(S1) \div (S2) \rightarrow$ quotient (D) remainder (DT9015)	7	○	○	○	○	○	○
F53 P53	8-digit BCD data division	DB% PDB%	S1, S2, D	$(S1+1, S1) \div (S2+1, S2) \rightarrow$ quotient (D+1, D) remainder (DT9016, DT9015)	11	○	○	○	○	○	○
F55 P55	4-digit BCD data increment	B+1 PB+1	D	$(D)+1 \rightarrow (D)$	3	○	○	○	○	○	○
F56 P56	8-digit BCD data increment	DB+1 PDB+1	D	$(D+1, D)+1 \rightarrow (D+1, D)$	3	○	○	○	○	○	○
F57 P57	4-digit BCD data decrement	B-1 PB-1	D	$(D)-1 \rightarrow (D)$	3	○	○	○	○	○	○
F58 P58	8-digit BCD data decrement	DB-1 PDB-1	D	$(D+1, D)-1 \rightarrow (D+1, D)$	3	○	○	○	○	○	○
Data compare instructions											
F60 P60	16-bit data compare	CMP PCMP	S1, S2	$(S1) > (S2) \rightarrow R900A$: on $(S1) = (S2) \rightarrow R900B$: on $(S1) < (S2) \rightarrow R900C$: on	5	○	○	○	○	○	○
F61 P61	32-bit data compare	DCMP PDCMP	S1, S2	$(S1+1, S1) > (S2+1, S2) \rightarrow R900A$: on $(S1+1, S1) = (S2+1, S2) \rightarrow R900B$: on $(S1+1, S1) < (S2+1, S2) \rightarrow R900C$: on	9	○	○	○	○	○	○
F62 P62	16-bit data band compare	WIN PWIN	S1, S2, S3	$(S1) > (S3) \rightarrow R900A$: on $(S2) < \text{or} = (S1) < \text{or} = (S3) \rightarrow R900B$: on $(S1) < (S2) \rightarrow R900C$: on	7	○	○	○	○	○	○

○ : Available, × : Not available, △ : Not available partially

Number	Name	Boolean	Operand	Description	Steps	FP0/FP-e	FP0R	FPΣ	FP-X	FP2	FP2SH/FP10SH
F63 P63	32-bit data band compare	DWIN PDWIN	S1, S2, S3	(S1+1, S1)>(S3+1, S3)→R900A: on (S2+1, S2)< or=(S1+1, S1)< or=(S3+1, S3)→R900B: on (S1+1, S1)<(S2+1, S2)→R900C: on	13	○	○	○	○	○	○
F64 P64	Block data compare	BCMP PBCMP	S1, S2, S3	Compares the two blocks beginning with "S2" and "S3" to see if they are equal.	7	○	○	○	○	○	○
Logic operation instructions											
F65 P65	16-bit data AND	WAN PWAN	S1, S2, D	(S1) AND (S2)→(D)	7	○	○	○	○	○	○
F66 P66	16-bit data OR	WOR PWOR	S1, S2, D	(S1) OR (S2)→(D)	7	○	○	○	○	○	○
F67 P67	16-bit data exclusive OR	XOR PXOR	S1, S2, D	{(S1) AND (S2)} OR {(S1) AND (S2)}→(D)	7	○	○	○	○	○	○
F68 P68	16-bit data exclusive NOR	XNR PXNR	S1, S2, D	{(S1) AND (S2)} OR {(S1) AND (S2)}→(D)	7	○	○	○	○	○	○
F69 P69	16-bit data unite	WUNI PWUNI	S1, S2, S3, D	{[S1] AND [S3]} OR {[S2] AND [S3]}→(D) When (S3) is H0, (S2)→(D) When (S3) is HFFFF, (S1)→(D)	9	×	○	○	○	○	○
Data conversion instructions											
F70 P70	Block check code calculation	BCC PBCC	S1, S2, S3, D	Creates the code for checking the data specified by "S2" and "S3" and stores it in "D". The calculation method is specified by "S1".	9	○	○	○	○	○	○
F71 P71	Hexadecimal data → ASCII code	HEXA PHEXA	S1, S2, D	Converts the hexadecimal data specified by "S1" and "S2" to ASCII code and stores it in "D". Example: H <u>42</u> <u>41</u> <u>44</u> <u>43</u> B A D C	7	○	○	○	○	○	○
F72 P72	ASCII code → Hexadecimal data	AHEX PAHEX	S1, S2, D	Converts the ASCII code specified by "S1" and "S2" to hexadecimal data and stores it in "D". Example: H <u>44</u> <u>43</u> <u>42</u> <u>41</u> → HCDAB D C B A	7	○	○	○	○	○	○
F73 P73	4-digit BCD data → ASCII code	BCDA PBCDA	S1, S2, D	Converts the four digits of BCD data specified by "S1" and "S2" to ASCII code and stores it in "D". Example: H1234 → H <u>32</u> <u>31</u> <u>34</u> <u>33</u> 2 1 4 3	7	○	○	○	○	○	○
F74 P74	ASCII code → 4-digit BCD data	ABCD PABCD	S1, S2, D	Converts the ASCII code specified by "S1" and "S2" to four digits of BCD data and stores it in "D". Example: H <u>34</u> <u>33</u> <u>32</u> <u>31</u> → H3412 4 3 2 1	9	○	○	○	○	○	○
F75 P75	16-bit binary data → ASCII code	BINA PBINA	S1, S2, D	Converts the 16 bits of binary data specified by "S1" to ASCII code and stores it in "D" (area of "S2" bytes). Example: K-100 → H <u>30</u> <u>30</u> <u>31</u> <u>2D</u> <u>20</u> <u>20</u> 0 0 1 -	7	○	○	○	○	○	○

○ : Available, × : Not available, △ : Not available partially

Number	Name	Boolean	Operand	Description	Steps	FP0/FP-e	FP0R	FPΣ	FP-X	FP2	FP2SH/FP10SH
F76 P76	ASCII code → 16-bit binary data	ABIN PABIN	S1, S2, D	Converts the ASCII code specified by "S1" and "S2" to 16 bits of binary data and stores it in "D". Example: H <u>30 30 31 2D 20 20</u> → K-100 0 0 1 -	7	○	○	○	○	○	○
F77 P77	32-bit binary data → ASCII code	DBIA PDBIA	S1, S2, D	Converts the 32 bits of binary data (S1+1, S1) to ASCII code and stores it in D (area of "S2" bytes).	11	○	○	○	○	○	○
F78 P78	ASCII code → 32-bit binary data	DABI PDABI	S1, S2, D	Converts the ASCII code specified by "S1" and "S2" to 32 bits of binary data and stores it in (D+1, D).	11	○	○	○	○	○	○
F80 P80	16-bit binary data → 4-digit BCD data	BCD PBCD	S, D	Converts the 16 bits of binary data specified by "S" to four digits of BCD data and stores it in "D". Example: K100 → H100	5	○	○	○	○	○	○
F81 P81	4-digit BCD data → 16-bit binary data	BIN PBIN	S, D	Converts the four digits of BCD data specified by "S" to 16 bits of binary data and stores it in "D". Example: H100 → K100	5	○	○	○	○	○	○
F82 P82	32-bit binary data → 8-digit BCD data	DBCD PDBCD	S, D	Converts the 32 bits of binary data specified by (S+1, S) to eight digits of BCD data and stores it in (D+1, D).	7	○	○	○	○	○	○
F83 P83	8-digit BCD data → 32-bit binary data	DBIN PDBIN	S, D	Converts the eight digits of BCD data specified by (S+1, S) to 32 bits of binary data and stores it in (D+1, D).	7	○	○	○	○	○	○
F84 P84	16-bit data invert (complement of 1)	INV PINV	D	Inverts each bit of data of "D".	3	○	○	○	○	○	○
F85 P85	16-bit data complement of 2	NEG PNEG	D	Inverts each bit of data of "D" and adds 1 (inverts the sign).	3	○	○	○	○	○	○
F86 P86	32-bit data complement of 2	DNEG PDNEG	D	Inverts each bit of data of (D+1, D) and adds 1 (inverts the sign).	3	○	○	○	○	○	○
F87 P87	16-bit data absolute	ABS PABS	D	Gives the absolute value of the data of "D".	3	○	○	○	○	○	○
F88 P88	32-bit data absolute	DABS PDABS	D	Gives the absolute value of the data of (D+1, D).	3	○	○	○	○	○	○
F89 P89	16-bit data sign extension	EXT PEXT	D	Extends the 16 bits of data in "D" to 32 bits in (D+1, D).	3	○	○	○	○	○	○
F90 P90	Decode	DECO PDECO	S, n, D	Decodes part of the data of "S" and stores it in "D". The part is specified by "n".	7	○	○	○	○	○	○
F91 P91	7-segment decode	SEGT PSEGT	S, D	Converts the data of "S" for use in a 7-segment display and stores it in (D+1, D).	5	○	○	○	○	○	○
F92 P92	Encode	ENCO PENCO	S, n, D	Encodes part of the data of "S" and stores it in "D". The part is specified by "n".	7	○	○	○	○	○	○
F93 P93	16-bit data combine	UNIT PUNIT	S, n, D	The least significant digit of each of the "n" words of data beginning at "S" are stored (united) in order in "D".	7	○	○	○	○	○	○

○ : Available, × : Not available, △ : Not available partially

Number	Name	Boolean	Operand	Description	Steps	FP0/FP-e	FP0R	FPΣ	FP-X	FP2	FP2SH/FP10SH
F94 P94	16-bit data distribute	DIST PDIST	S, n, D	Each of the digits of the data of "S" are stored in (distributed to) the least significant digits of the areas beginning at "D".	7	○	○	○	○	○	○
F95 P95	Character→ ASCII code	ASC PASC	S, D	Twelve characters of the character constants of "S" are converted to ASCII code and stored in "D" to "D+5".	15	○	○	○	○	○	○
F96 P96	16-bit table data search	SRC PSRC	S1, S2, S3	The data of "S1" is searched for in the areas in the range "S2" to "S3" and the result is stored in DT9037 and DT9038	7	○	○	○	○	○	○
F97 P97	32-bit table data search	DSRC PDSRC	S1, S2, S3	The data of (S1+1, S1) is searched for in the 32-bit data designated by "S3", beginning from "S2", and the result if stored in DT90037 and DT90038.	11	×	○	○	○	○	○
Data shift instructions											
F98 P98	Data table shift-out and compress	CMPR PCMPR	D1, D2, D3	Transfer "D2" to "D3". Any parts of the data between "D1" and "D2" that are 0 are compressed, and shifted in order toward "D2".	7	×	○	○	○	○	○
F99 P99	Data table shift-in and compress	CMPW PCMPW	S, D1, D2	Transfer "S" to "D1". Any parts of the data between "D1" and "D2" that are 0 are compressed, and shifted in order toward "D2".	7	×	○	○	○	○	○
F100 P100	Right shift of multiple bits (n bits) in a 16-bit data	SHR PSHR	D, n	Shifts the "n" bits of "D" to the right.	5	○	○	○	○	○	○
F101 P101	Left shift of multiple bits (n bits) in a 16-bit data	SHL PSHL	D, n	Shifts the "n" bits of "D" to the left.	5	○	○	○	○	○	○
F102 P102	Right shift of n bits in a 32-bit data	DSHR PDSHR	D, n	Shifts the "n" bits of the 32-bit data area specified by (D+1, D) to the right.	5	×	○	○	○	○	○
F103 P103	Left shift of n bits in a 32-bit data	DSHL PDSHL	D, n	Shifts the "n" bits of the 32-bit data area specified by (D+1, D) to the left.	5	×	○	○	○	○	○
F105 P105	Right shift of one hexadecimal digit (4-bit)	BSR PBSR	D	Shifts the one digit of data of "D" to the right.	3	○	○	○	○	○	○
F106 P106	Left shift of one hexadecimal digit (4-bit)	BSL PBSL	D	Shifts the one digit of data of "D" to the left.	3	○	○	○	○	○	○
F108 P108	Right shift of multiple bits (n bits)	BITR PBITR	D1, D2, n	Shifts the "n" bits of data range by "D1" and "D2" to the right.	7	×	○	○	○	○	○
F109 P109	Left shift of multiple bits (n bits)	BITL PBITL	D1, D2, n	Shifts the "n" bits of data range by "D1" and "D2" to the left.	7	×	○	○	○	○	○
F110 P110	Right shift of one word (16-bit)	WSHR PWSHR	D1, D2	Shifts the one word of the areas by "D1" and "D2" to the right.	5	○	○	○	○	○	○
F111 P111	Left shift of one word (16-bit)	WSHL PWSHL	D1, D2	Shifts the one word of the areas by "D1" and "D2" to the left.	5	○	○	○	○	○	○
F112 P112	Right shift of one hexadecimal digit (4-bit)	WBSR PWBSR	D1, D2	Shifts the one digit of the areas by "D1" and "D2" to the right.	5	○	○	○	○	○	○
F113 P113	Left shift of one hexadecimal digit (4-bit)	WBSL PWBSL	D1, D2	Shifts the one digit of the areas by "D1" and "D2" to the left.	5	○	○	○	○	○	○

○ : Available, × : Not available, △ : Not available partially

Num-ber	Name	Boolean	Oper- and	Description	Steps	FP0/FP-9	FP0R	FPΣ	FP-X	FP2	FP2SH/FP10SH
FIFO instructions											
F115 P115	FIFO buffer define	FIFT PFIFT	n, D	The "n" words beginning from "D" are defined in the buffer.	5	×	○	○	○	○	○
F116 P116	Data read from FIFO buffer	FIFR PFIFR	S, D	The oldest data beginning from "S" that was written to the buffer is read and stored in "D".	5	×	○	○	○	○	○
F117 P117	Data write into FIFO buffer	FIFW PFIFW	S, D	The data of "S" is written to the buffer starting from "D".	5	×	○	○	○	○	○
Basic function instructions											
F118	UP/DOWN counter	UDC	S, D	Counts up or down from the value preset in "S" and stores the elapsed value in "D".	5	○	○	○	○	○	○
F119	Left/right shift register	LRSR	D1, D2	Shifts one bit to the left or right with the area between "D1" and "D2" as the register.	5	○	○	○	○	○	○
Data rotate instructions											
F120 P120	16-bit data right rotate	ROR PROR	D, n	Rotates the "n" bits in data of "D" to the right.	5	○	○	○	○	○	○
F121 P121	16-bit data left rotate	ROL PROL	D, n	Rotates the "n" bits in data of "D" to the left.	5	○	○	○	○	○	○
F122 P122	16-bit data right rotate with carry flag (R9009) data	RCR PRCR	D, n	Rotates the "n" bits in 17-bit area consisting of "D" plus the carry flag (R9009) data to the right.	5	○	○	○	○	○	○
F123 P123	16-bit data left rotate with carry flag (R9009) data	RCL PRCL	D, n	Rotates the "n" bits in 17-bit area consisting of "D" plus the carry flag (R9009) data to the left.	5	○	○	○	○	○	○
F125 P125	32-bit data right rotate	DROR PDROR	D, n	Rotates the number of bits specified by "n" of the double words data (32 bits) specified by (D+1, D) to the right.	5	×	○	○	○	○	○
F126 P126	32-bit data left rotate	DROL PDROL	D, n	Rotates the number of bits specified by "n" of the double words data (32 bits) specified by (D+1, D) to the left.	5	×	○	○	○	○	○
F127 P127	32-bit data right rotate with carry flag (R9009) data	DRCR PDCRCR	D, n	Rotates the number of bits specified by "n" of the double words data (32 bits) specified by (D+1, D) to the right together with carry flag (R9009) data.	5	×	○	○	○	○	○
F128 P128	32-bit data left rotate with carry flag (R9009) data	DRCL PDRCL	D, n	Rotates the number of bits specified by "n" of the double words data (32 bits) specified by (D+1, D) to the left together with carry flag (R9009) data.	5	×	○	○	○	○	○
Bit manipulation instructions											
F130 P130	16-bit data bit set	BTS PBTS	D, n	Sets the value of bit position "n" of the data of "D" to 1.	5	○	○	○	○	○	○
F131 P131	16-bit data bit reset	BTR PBTR	D, n	Sets the value of bit position "n" of the data of "D" to 0.	5	○	○	○	○	○	○
F132 P132	16-bit data invert	BTI PBTI	D, n	Inverts the value of bit position "n" of the data of "D".	5	○	○	○	○	○	○
F133 P133	16-bit data bit test	BTT PBTT	D, n	Tests the value of bit position "n" of the data of "D" and outputs the result to R900B.	5	○	○	○	○	○	○
F135 P135	Number of on (1) bits in 16-bit data	BCU PBCU	S, D	Stores the number of on bits in the data of "S" in "D".	5	○	○	○	○	○	○
F136 P136	Number of on (1) bits in 32-bit data	DBC PDBC	S, D	Stores the number of on bits in the data of (S+1, S) in "D".	7	○	○	○	○	○	○

○ : Available, × : Not available, △ : Not available partially

Num-ber	Name	Boo-lean	Ope-rand	Description	Steps	FP0/FP-e	FP0R	FPΣ	FP-X	FP2	FP2SH/FP10SH
Basic function instruction											
F137	Auxiliary timer (16-bit)	STMR	S, D	Turns on the specified output and R900D after 0.01 s × set value.	5	○	○	○	○	○	○
Special instructions											
F138 P138	Hours, minutes and seconds to seconds data	HMSS PHMSS	S, D	Converts the hour, minute and second data of (S+1, S) to seconds data, and the converted data is stored in (D+1, D).	5	△ *1	○	○	○	○	○
F139 P139	Seconds to hours, minutes and seconds data	SHMS PSHMS	S, D	Converts the seconds data of (S+1, S) to hour, minute and second data, and the converted data is stored in (D+1, D).	5	△ *1	○	○	○	○	○
F140 P140	Carry flag (R9009) set	STC PSTC	-	Turns on the carry flag (R9009).	1	○	○	○	○	○	○
F141 P141	Carry flag (R9009) reset	CLC PCLC	-	Turns off the carry flag (R9009).	1	○	○	○	○	○	○
F142 P142	Watching dog timer update	WDT PWDT	S	The time (allowable scan time for the system) of watching dog timer is changed to "S" × 0.1 (ms) for that scan.	3	×	×	×	×	×	○
F143 P143	Partial I/O update	IORF PIORF	D1, D2	Updates the I/O from the number specified by "D1" to the number specified by "D2".	5	○	○	○	○	○	○
F144	Serial data communication control	TRNS	S, n	The COM port received flag (R9038) is set to off to enable reception. Beginning at "S", "n" bytes of the data registers are sent from the COM port.	5	○ *2	×	×	×	○	○
F145 P145	Data send	SEND PSEND	S1, S2, D, N	Sends the data to another station in the network (MEWNET). (via link unit)	9	×	×	×	×	○	○
F146 P146	Data receive	RECV PRECV	S1, S2, N, D	Receives the data to another station in the network (MEWNET). (via link unit)	9	×	×	×	×	○	○
F145 P145	Data send	SEND	S1, S2, D, N	Sends the data to the slave station as the MOD bus master. (via COM port)	9	×	○	△ *3	○	×	×
F146 P146	Data receive	RECV	S1, S2, N, D	Receives the data from the slave station as the MOD bus master. (via COM port)	9	×	○	△ *3	○	×	×
F145 P145	Data send	SEND	S1, S2, D, N	Sends the data to the slave station of the MOD bus master, type II.	9	×	○	△ *4	△ *4	×	×
F146 P146	Data receive	RECV	S1, S2, N, D	Receives the data from the slave station of the MOD bus master, type II.	9	×	○	△ *4	△ *4	×	×
F145 P145	Data send	SEND	S1, S2, D, N	Sends the data to the slave station as the MEWTOCOL master. (via COM port)	9	×	○	△ *3	△ *3	×	×
F146 P146	Data receive	RECV	S1, S2, N, D	Receives the data from the slave station as the MEWTOCOL master. (via COM port)	9	×	○	△ *3	△ *3	×	×
F147	Printout	PR	S, D	Converts the ASCII code data in the area starting with "S" for printing, and outputs it to the word external output relay WY specified by "D".	5	○	○	○	○	○	○
F148 P148	Self-diagnostic error set	ERR PERR	n (n: k100 to K299)	Stores the self-diagnostic error number "n" in (DT9000), turns R9000 on, and turns on the ERROR LED.	3	○	○	○	○	○	○
F149 P149	Message display	MSG PMSG	S	Displays the character constant of "S" in the connected programming tool.	13	○	○	○	○	○	○

○ : Available, × : Not available, △ : Not available partially

*1) The instruction is available for FP0 T32 (V2.3 or later) and FP-e.

*2) This instruction is available for FP0 V1.20 or later and FP-e.

*3) This instruction is available for FP-X V1.20 or later and FPΣ 32k type.

*4) This instruction is available for FP-X V2.50 or later and FPΣ V3.20 or later.

Number	Name	Boolean	Operand	Description	Steps	FP0/FP-e	FP0R	FPΣ	FP-X	FP2	FP2SH/FP10SH
F150 P150	Data read from intelligent unit	READ PREAD	S1, S2, n, D	Reads the data from the intelligent unit.	9	×	×	△ *3	×	○	○
F151 P151	Data write into intelligent unit	WRT PWRT	S1, S2, n, D	Writes the data into the intelligent unit.	9	×	×	△ *3	×	○	○
F152 P152	Data read from MEWNET-F slave station	RMRD PRMRD	S1, S2, n, D	Reads the data from the intelligent unit at the MEWNET-F (remote I/O) slave station.	9	×	×	×	×	○	○
F153 P153	Data write into MEWNET-F slave station	RMWT PRMWT	S1, S2, n, D	Writes the data into the intelligent unit at the MEWNET-F (remote I/O) slave station.	9	×	×	×	×	○	○
F155 P155	Sampling	SMPL PSMPL	-	Starts sampling data.	1	×	○	△ *5	△ *4	○	○
F156 P156	Sampling trigger	STRG PSTRG	-	When the trigger of this instruction turns on, the sampling trace stops.	1	×	○	△ *5	△ *4	○	○
F157 P157	Time addition	CADD PCADD	S1, S2, D	The time after (S2+1, S2) elapses from the time of (S1+2, S1+1, S1) is stored in (D+2, D+1, D).	9	△ *1	○	○	○	○	○
F158 P158	Time subtraction	CSUB PCSUB	S1, S2, D	The time that results from subtracting (S2+1, S2) from the time (S1+2, S1+1, S1) is stored in (D+2, D+1, D).	9	△ *1	○	○	○	○	○
F159 P159	Serial port communication	MTRN PMTRN	S, n, D	This is used to send data to an external device through the specified CPU COM port or MCU COM port.	7	×	○	○	○	△ *2	△ *2
F161 P161	MCU serial port reception	MRCV PMRCV	S, D1, D2	Data is received from external equipment via the COM port of the specified MCU.	7	×	×	×	×	△ *2	△ *2
BIN arithmetic instruction											
F160 P160	Double word (32-bit) data square root	DSQR PDSQR	S, D	$\sqrt{(S)} \rightarrow (D)$	7	×	○	○	○	○	○
High speed counter/Pulse output instruction for FP0, FP-e											
F0	High-speed counter and Pulse output controls	MV	S, DT9052	Performs high-speed counter and Pulse output controls according to the control code specified by "S". The control code is stored in DT9052.	5	○					
1	Change and read of the elapsed value of high-speed counter and Pulse output	DMV	S, DT9044	Transfers (S+1, S) to high-speed counter and Pulse output elapsed value area.	7	○					
			DT9044, D	Transfers value in high-speed counter and Pulse output elapsed value area to (D+1, D).	7	○					
F166	High-speed counter output set (with channel specification)	HC1S	n, S, Yn	Turns output Yn on when the elapsed value of the built-in high-speed counter reaches the target value of (S+1, S).	11	○					

○ : Available, × : Not available, △ : Not available partially

*1) The instruction is available for FP0 T32 (V2.3 or later) and FP-e.

*2) The instruction is available for FP2/FP2SH Ver. 1.5 or later, and the pulse execution type can be specified. FP10SH cannot be used.

*3) This instruction is available for FPΣ Ver. 2.0 or later.

*4) This instruction is only available for FP-X Ver.2.0 or later.

*5) This instruction is available for FPΣ Ver. 3.10 or later.

Number	Name	Boolean	Operand	Description	Steps	FP0/FP-e	FP0R	FPΣ	FP-X	FP2	FP2SH/FP10SH
F167	High-speed counter output reset (with channel specification)	HC1R	n, S, Yn	Turns output Yn off when the elapsed value of the built-in high-speed counter reaches the target value of (S+1, S).	11	○	/	/	/	/	/
F168	Positioning control (with channel specification)	SPD1	S, n	Outputs a positioning pulse from the specified output (Y0 or Y1) according to the contents of the data table beginning at "S".	5	○	/	/	/	/	/
F169	Pulse output (with channel specification)	PLS	S, n	Outputs a pulse from the specified output (Y0 or Y1) according to the contents of the data table beginning at "S".	5	○	/	/	/	/	/
F170	PWM output (with channel specification)	PWM	S, n	Performs PWM output from the specified output (Y0 or Y1) according to the contents of the data table beginning at "S".	5	○	/	/	/	/	/
High speed counter/Pulse output instruction for FP0R											
F0	High-speed counter and Pulse output controls	MV	S, DT90052	Performs high-speed counter and Pulse output controls according to the control code specified by "S". The control code is stored in DT90052.	5	/	○	/	/	/	/
F1	Change and read of the elapsed value of high-speed counter and Pulse output	DMV	S, DT90300	Transfers (S+1, S) to high-speed counter and Pulse output elapsed value area (DT90045, DT90044).	7	/	○	/	/	/	/
			DT90300, D	Transfers value in high-speed counter and Pulse output elapsed value area (DT90045, DT90044) to (D+1, D).	7	/	○	/	/	/	/
F165	Cam control	CAM0	S	Controls cam operation (on/off patterns of each cam output) according to the elapsed value of the high-speed counter.	3	/	○	/	/	/	/
F166	Target value much on (with channel specification) (High-speed counter control/Pulse output control)	HC1S	n, S, D	Turns output Yn on when the elapsed value of the high-speed counter or pulse output reaches the target value of (S+1, S).	11	/	○	/	/	/	/
F167	Target value much off (with channel specification) (High-speed counter control/Pulse output control)	HC1R	n, S, D	Turns output Yn off when the elapsed value of the high-speed counter or pulse output reaches the target value of (S+1, S).	11	/	○	/	/	/	/
F171	Pulse output (JOG positioning type 0/1) (Trapezoidal control)	SPDH	S, n	Positioning pulses are output from the specified channel, in accordance with the contents of the data table that starts with S.	5	/	○	/	/	/	/
F172	Pulse output (JOG operation 0 and 1)	PLSH	S, n	Pulse strings are output from the specified output, in accordance with the contents of the data table that starts with S.	5	/	○	/	/	/	/
F173	PWM output (with channel specification)	PWMH	S, n	PWM output is output from the specified output, in accordance with the contents of the data table that starts with S.	5	/	○	/	/	/	/

Number	Name	Boolean	Operand	Description	Steps	FP0/FP-e	FP0R	FPΣ	FP-X	FP2	FP2SH/FP10SH
F174	Pulse output (Selectable data table control operation)	SP0H	S, n	Outputs the pulses from the specified channel according to the data table specified by S.	5	/	○	/	/	/	/
F175	Pulse output (Linear interpolation)	SPSH	S, n	Pulses are output from channel, in accordance with the designated data table, so that the path to the target position forms a straight line.	5	/	○	/	/	/	/
F176	Pulse output (Circular interpolation)	SPCH	S, n	Pulses are output from channel, in accordance with the designated data table, so that the path to the target position forms an arc.	5	/	×	/	/	/	/
F177	Pulse output (Home return)	HOME	S, n	Performs the home return according to the specified data table.	7	/	○	/	/	/	/
F178	Input pulse measurement (No. of pulses, cycle for input pulses)	PLSM	S1, S2, D	Measures the number of pulses and cycle of pulses to be input to the high-speed counter of the specified channel.	5	/	○	/	/	/	/

Number	Name	Boolean	Operand	Description	Steps	FP0/FP-e	FP0R	FPΣ	FP-X	FP2	FP2SH/FP10SH
High speed counter/Pulse output instruction for FPΣ/FP-X											
F0	High-speed counter and Pulse output controls	MV	S, DT90052	Performs high-speed counter and Pulse output controls according to the control code specified by "S". The control code is stored in DT90052.	5			○	○		
F1	Change and read of the elapsed value of high-speed counter and Pulse output	DMV	FPΣ: S, DT90044	Transfers (S+1, S) to high-speed counter and Pulse output elapsed value area (DT90045, DT90044).	7			○	○		
			FP-X: S, DT90300	Transfers value in high-speed counter and Pulse output elapsed value area (DT90045, DT90044) to (D+1, D).	7			○	○		
F166	Target value much on (with channel specification)	HC1S	n, S, D	Turns output Yn on when the elapsed value of the built-in high-speed counter reaches the target value of (S+1, S).	11			○	○		
F167	Target value much off (with channel specification)	HC1R	n, S, D	Turns output Yn off when the elapsed value of the built-in high-speed counter reaches the target value of (S+1, S).	11			○	○		
F171	Pulse output (with channel specification) (Trapezoidal control and home return)	SPDH	S, n	Positioning pulses are output from the specified channel, in accordance with the contents of the data table that starts with S.	5			○	○		
F172	Pulse output (with channel specification) (JOG operation)	PLSH	S, n	Pulse strings are output from the specified output, in accordance with the contents of the data table that starts with S.	5			○	○		
F173	PWM output (with channel specification)	PWMH	S, n	PWM output is output from the specified output, in accordance with the contents of the data table that starts with S.	5			○	○		
F174	Pulse output (with channel specification) (Selectable data table control operation)	SP0H	S, n	Outputs the pulses from the specified channel according to the data table specified by S.	5			○	○		
F175	Pulse output (Linear interpolation)	SPSH	S, n	Pulses are output from channel, in accordance with the designated data table, so that the path to the target position forms a straight line.	5			△*2	○		
F176	Pulse output (Circular interpolation)	SPCH	S, n	Pulses are output from channel, in accordance with the designated data table, so that the path to the target position forms an arc.	5			△*2	×		

○ : Available, × : Not available, △ : Not available partially

*1) The elapsed value area differs depending on used channels.

*2) This instruction is available for FPΣ C32T2, C28P2, C32T2H and C28P2H.

Num-ber	Name	Boolean	Ope-rand	Description	Steps	FP0/FP-e	FP0R	FPΣ	FP-X	FP2	FP2SH/FP10SH
Screen display instructions											
F180	FP-e screen display registration	SCR	S1, S2, S3, S4	Register the screen displayed on the FP-e.	9	△*1	×	×	×	×	×
F181	FP-e screen display switching	DSP	S	Specify the screen to be displayed on the FP-e.	3	△*1	×	×	×	×	×
Basic function instruction											
F182	Time constant processing	FILTR	S1, S2, S3, D	Executes the filter processing for the specified input.	9	×	○	△*2	△*3	×	×
F183	Auxiliary timer (32-bit)	DSTM	S, D	Turn on the specified output and R900D after 0.01 s. × set value.	7	○	○	○	○	○	△*4
Data transfer instructions											
F190	Three 16-bit data move	MV3	S1, S2, S3, D	(S1)→(D), (S2)→(D+1), (S3)→(D+2)	10	×	○	○	○	○	○
F191	Three 32-bit data move	DMV3	S1, S2, S3, D	(S1+1, S1)→(D+1, D), (S2+1, S2)→(D+3, D+2), (S3+1, S3)→(D+5, D+4)	16	×	○	○	○	○	○
Logic operation instructions											
F215	32-bit data AND	DAND	S1, S2, D	(S1+1, S1) AND (S2+1, S2)→(D+1, D)	7	×	○	○	○	○	○
F216	32-bit data OR	DOR	S1, S2, D	(S1+1, S1) OR (S2+1, S2)→(D+1, D)	12	×	○	○	○	○	○
F217	32-bit data XOR	DXOR	S1, S2, D	{(S1+1, S1) AND (S2+1, S2)} OR {(S1+1, S1) AND (S2+1, S2)}→(D+1, D)	12	×	○	○	○	○	○
F218	32-bit data XNR	DXNR	S1, S2, D	{(S1+1, S1) AND (S2+1, S2)} OR {(S1+1, S1) AND (S2+1, S2)}→(D+1, D)	12	×	○	○	○	○	○
F219	Double word (32-bit) data unites	DUNI	S1, S2, S3, D	{(S1+1, S1) AND (S3+1, S3)} OR {(S2+1, S2) AND (S3+1, S3)}→(D+1, D)	16	×	○	○	○	○	○
Data conversion instructions											
F230	Time data → second conversion	TMSEC	S, D	The specified time data (a date and time) is changed to the second data.	6	×	○	△*5	△*6	△*7	△*7
F231	Second data→ time conversion	SECTM	S, D	The specified second data is changed into time data (a date and time).	6	×	○	△*5	△*6	△*7	△*7

○ : Available, × : Not available, △ : Not available partially

- *1) This instruction is available for FP-e only.
- *2) This instruction is available for FPΣ Ver. 3.10 or later.
- *3) This instruction is only available for FP-X Ver.2.0 or later.
- *4) This instruction is available for FP10SH Ver. 3.10 or later.
- *5) This instruction is available for FPΣ 32k type.
- *6) This instruction is available for FP-X Ver. 1.13 or later.
- *7) This instruction is available for FP2/FP2SH Ver. 1.5 or later.FP10SH cannot be used.

Number	Name	Boolean	Operand	Description	Steps	FP0/FP-e	FP0R	FPΣ	FP-X	FP2	FP2SH/FP10SH
F235 P235	16-bit binary data → Gray code conversion	GRY PGRY	S, D	Converts the 16-bit binary data of "S" to gray codes, and the converted result is stored in the "D".	6	×	○	○	○	○	○
F236 P236	32-bit binary data → Gray code conversion	DGRY PDGRY	S, D	Converts the 32-bit binary data of (S+1, S) to gray code, and the converted result is stored in the (D+1, D).	8	×	○	○	○	○	○
F237 P237	16-bit gray code → binary data conversion	GBIN PGBIN	S, D	Converts the gray codes of "S" to binary data, and the converted result is stored in the "D".	6	×	○	○	○	○	○
F238 P238	32-bit gray code → binary data conversion	DGBIN PDGBIN	S, D	Converts the gray codes of (S+1, S) to binary data, and the converted result is stored in the (D+1, D).	8	×	○	○	○	○	○
F240 P240	Bit line to bit column conversion	COLM PCOLM	S, n, D	The values of bits 0 to 15 of "S" are stored in bit "n" of (D to DC+15).	8	×	○	○	○	○	○
F241 P241	Bit column to bit line conversion	LINE PLINE	S, n, D	The values of bit "n" of (S) to (S+15) are stored in bits 0 to 15 of "D".	8	×	○	○	○	○	○
F250	Binary data → ASCII conversion	BTOA	S1, S2, n, D	Converts multiple binary data to multiple ASCII data.	12	×	○	△ *1	○	×	×
F251	ASCII → binary data conversion	ATOB	S1, S2, n, D	Converts multiple ASCII data to multiple binary data.	12	×	○	△ *1	○	×	×
F252	ASCII data check	ACHK	S1, S2, n	Checks the ASCII data strings to be used in F251 (ATOB) instruction.	10	×	○	△ *2	△ *3	×	×
Character strings instructions											
F257 P257	Comparing character strings	SCMP	S1, S2	These instructions compare two specified character strings and output the judgment results to a special internal relay.	10	×	○	○	○	○	○
F258 P258	Character string coupling	SADD	S1, S2, D	These instructions couple one character string with another.	12	×	○	○	○	○	○
F259 P259	Number of characters in a character string	LEN	S, D	These instructions determine the number of characters in a character string.	6	×	○	○	○	○	○
F260 P260	Search for character string	SSRC	S1, S2, D	The specified character is searched in a character string.	10	×	○	○	○	○	○
F261 P261	Retrieving data from character strings (right side)	RIGHT	S1, S2, D	These instructions retrieve a specified number of characters from the right side of the character string.	8	×	○	○	○	○	○
F262 P262	Retrieving data from character strings (left side)	LEFT	S1, S2, D	These instructions retrieve a specified number of characters from the left side of the character string.	8	×	○	○	○	○	○
F263 P263	Retrieving a character string from a character string	MIDR	S1, S2, S3, D	These instructions retrieve a character string consisting of a specified number of characters from the specified position in the character string.	10	×	○	○	○	○	○
F264 P264	Writing a character string to a character string	MIDW	S1, S2, D, n	These instructions write a specified number of characters from a character string to a specified position in the character string.	12	×	○	○	○	○	○
F265 P265	Replacing character strings	SREP	S, D, p, n	A specified number of characters in a character string are rewritten, starting from a specified position in the character string.	12	×	○	○	○	○	○

○ : Available, × : Not available, △ : Not available partially

*1) This instruction is available for FPΣ 32k type.

*2) This instruction is available for FPΣ Ver. 3.10 or later.

*3) This instruction is only available for FP-X Ver.2.0 or later.

Number	Name	Boolean	Operand	Description	Steps	FP0/FP-e	FP0R	FPΣ	FP-X	FP2	FP2SH/FP10SH
Integer type data processing instructions											
F270 P270	Maximum value (word data (16-bit))	MAX PMAX	S1, S2, D	Searches the maximum value in the word data table between the "S1" and "S2", and stores it in the "D". The address relative to "S1" is stored in "D+1".	8	△ *1	○	○	○	○	○
F271 P271	Maximum value (double word data (32-bit))	DMAX PDMAX	S1, S2, D	Searches for the maximum value in the double word data table between the area selected with "S1" and "S2", and stores it in the "D". The address relative to "S1" is stored in "D+2".	8	△ *1	○	○	○	○	○
F272 P272	Minimum value (word data (16-bit))	MIN PMIN	S1, S2, D	Searches for the minimum value in the word data table between the area selected with "S1" and "S2", and stores it in the "D". The address relative to "S1" is stored in "D+1".	8	△ *1	○	○	○	○	○
F273 P273	Minimum value (double word data (32-bit))	DMIN PDMIN	S1, S2, D	Searches for the minimum value in the double word data table between the area selected with "S1" and "S2", and stores it in the "D". The address relative to "S1" is stored in "D+2".	8	△ *1	○	○	○	○	○
F275 P275	Total and mean values (word data (16-bit))	MEAN PMEAN	S1, S2, D	The total value and the mean value of the word data with sign from the area selected with "S1" to "S2" are obtained and stored in the "D".	8	△ *1	○	○	○	○	○
F276 P276	Total and mean values (double word data (32-bit))	DMEAN PDMEAN	S1, S2, D	The total value and the mean value of the double word data with sign from the area selected with "S1" to "S2" are obtained and stored in the "D".	8	△ *1	○	○	○	○	○
F277 P277	Sort (word data (16-bit))	SORT PSORT	S1, S2, S3	The word data with sign from the area specified by "S1" to "S2" are sorted in ascending order (the smallest word is first) or descending order (the largest word is first).	8	△ *1	○	○	○	○	○
F278 P278	Sort (double word data (32-bit))	DSORT PDSORT	S1, S2, S3	The double word data with sign from the area specified by "S1" to "S2" are sorted in ascending order (the smallest word is first) or descending order (the largest word is first).	8	△ *1	○	○	○	○	○
F282 P282	Scaling of 16-bit data	SCAL PSCAL	S1, S2, D	The output value Y is found for the input value X by performing scaling for the given data table.	8	△ *1	○	○	○	○	○
F283 P283	Scaling of 32-bit data	DSCAL PDSCAL	S1, S2, D	The output value Y is found for the input value X by performing scaling for the given data table.	10	×	○	○	○	○	○
F284 P284	Inclination output of 16-bit data	RAMP	S1, S2, S3, D	Executes the linear output for the specified time from the specified initial value to the target value.	10	×	○	△ *2	△ *2	×	×
Integer type non-linear function instructions											
F285 P285	Upper and lower limit control (16-bit data)	LIMIT PLIMIT	S1, S2, S3, D	When S1>S3, S1→D When S1<S3, S2→D When S1<or = S3<or = S2, S3→D	10	△ *1	○	○	○	○	○

○ : Available, × : Not available, △ : Not available partially

*1) This instruction is only available for FP-e Ver.1.2 or later.

*2) This instruction is only available for FP-X Ver.2.0 or later, and FPΣ Ver. 3.10 or later.

Number	Name	Boolean	Operand	Description	Steps	FP0/FP-e	FP0R	FPΣ	FP-X	FP2	FP2SH/FP10SH
F286 P286	Upper and lower limit control (32-bit data)	DLIMIT PDLIMIT	S1, S2, S3, D	When $(S1+1, S1) > (S3+1, S3)$, $(S1+1, S1) \rightarrow (D+1, D)$ When $(S2+1, S2) < (S3+1, S3)$, $(S2+1, S2) \rightarrow (D+1, D)$ When $(S1+1, S1) <_{or} = (S3+1, S3) <_{or} = (S2+1, S2)$, $(S3+1, S3) \rightarrow (D+1, D)$	16	Δ *1	○	○	○	○	○
F287 P287	Deadband control (16-bit data)	BAND PBAND	S1, S2, S3, D	When $S1 > S3$, $S3 - S1 \rightarrow D$ When $S2 < S3$, $S3 - S2 \rightarrow D$ When $S1 <_{or} = S3 <_{or} = S2$, $0 \rightarrow D$	10	Δ *1	○	○	○	○	○
F288 P288	Deadband control (32-bit data)	DBAND PDBAND	S1, S2, S3, D	When $(S1+1, S1) > (S3+1, S3)$, $(S3+1, S3) - (S1+1, S1) \rightarrow (D+1, D)$ When $(S2+1, S2) < (S3+1, S3)$, $(S3+1, S3) - (S2+1, S2) \rightarrow (D+1, D)$ When $(S1+1, S1) <_{or} = (S3+1, S3) <_{or} = (S2+1, S2)$, $0 \rightarrow (D+1, D)$	16	Δ *1	○	○	○	○	○
F289 P289	Zone control (16-bit data)	ZONE PZONE	S1, S2, S3, D	When $S3 < 0$, $S3 + S1 \rightarrow D$ When $S3 = 0$, $0 \rightarrow D$ When $S3 > 0$, $S3 + S2 \rightarrow D$	10	Δ *1	○	○	○	○	○
F290 P290	Zone control (32-bit data)	DZONE PDZONE	S1, S2, S3, D	When $(S3+1, S3) < 0$, $(S3+1, S3) + (S1+1, S1) \rightarrow (D+1, D)$ When $(S3+1, S3) = 0$, $0 \rightarrow (D+1, D)$ When $(S3+1, S3) > 0$, $(S3+1, S3) + (S2+1, S2) \rightarrow (D+1, D)$	16	Δ *1	○	○	○	○	○
BCD type real number operation instructions											
F300 P300	BCD type sine operation	BSIN PBSIN	S, D	$SIN(S1+1, S1) \rightarrow (D+1, D)$	6	×	×	×	×	○	○
F301 P301	BCD type cosine operation	BCOS PBCOS	S, D	$COS(S1+1, S1) \rightarrow (D+1, D)$	6	×	×	×	×	○	○
F302 P302	BCD type tangent operation	BTAN PBTAN	S, D	$TAN(S1+1, S1) \rightarrow (D+1, D)$	6	×	×	×	×	○	○
F303 P303	BCD type arcsine operation	BASIN PBASIN	S, D	$SIN^{-1}(S1+1, S1) \rightarrow (D+1, D)$	6	×	×	×	×	○	○
F304 P304	BCD type arccosine operation	BACOS PBACOS	S, D	$COS^{-1}(S1+1, S1) \rightarrow (D+1, D)$	6	×	×	×	×	○	○
F305 P305	BCD type arctangent operation	BATAN PBATAN	S, D	$TAN^{-1}(S1+1, S1) \rightarrow (D+1, D)$	6	×	×	×	×	○	○
Floating-point type real number operation instructions											
F309 P309	Floating-point type data move	FMV PFMV	S, D	$(S+1, S) \rightarrow (D+1, D)$	8	Δ *2	○	○	○	○	○
F310 P310	Floating-point type data addition	F+ PF+	S1, S2, D	$(S1+1, S1) + (S2+1, S2) \rightarrow (D+1, D)$	14	Δ *2	○	○	○	○	○
F311 P311	Floating-point type data subtraction	F- PF-	S1, S2, D	$(S1+1, S1) - (S2+1, S2) \rightarrow (D+1, D)$	14	Δ *2	○	○	○	○	○
F312 P312	Floating-point type data multiplication	F* PF*	S1, S2, D	$(S1+1, S1) \times (S2+1, S2) \rightarrow (D+1, D)$	14	Δ *2	○	○	○	○	○
F313 P313	Floating-point type data division	F% PF%	S1, S2, D	$(S1+1, S1) \div (S2+1, S2) \rightarrow (D+1, D)$	14	Δ *2	○	○	○	○	○

○ : Available, × : Not available, Δ : Not available partially

*1) This instruction is only available for FP-e Ver.1.2 or later.

*2) This instruction is available for FP-e Ver.1.21 or later, and FP0 V2.1 or later.

Number	Name	Boolean	Operand	Description	Steps	FP0/FP-e	FP0R	FP2	FP-X	FP2	FP2SH/FP10SH
F314 P314	Floating-point type data sine operation	SIN PSIN	S, D	$\text{SIN}(S+1, S) \rightarrow (D+1, D)$	10	Δ *1	○	○	○	○	○
F315 P315	Floating-point type data cosine operation	COS PCOS	S, D	$\text{COS}(S+1, S) \rightarrow (D+1, D)$	10	Δ *1	○	○	○	○	○
F316 P316	Floating-point type data tangent operation	TAN PTAN	S, D	$\text{TAN}(S+1, S) \rightarrow (D+1, D)$	10	Δ *1	○	○	○	○	○
F317 P317	Floating-point type data arcsine operation	ASIN PASIN	S, D	$\text{SIN}^{-1}(S+1, S) \rightarrow (D+1, D)$	10	Δ *1	○	○	○	○	○
F318 P318	Floating-point type data arccosine operation	ACOS PACOS	S, D	$\text{COS}^{-1}(S+1, S) \rightarrow (D+1, D)$	10	Δ *1	○	○	○	○	○
F319 P319	Floating-point type data arctangent operation	ATAN PATAN	S, D	$\text{TAN}^{-1}(S+1, S) \rightarrow (D+1, D)$	10	Δ *1	○	○	○	○	○
F320 P320	Floating-point type data natural logarithm	LN PLN	S, D	$\text{LN}(S+1, S) \rightarrow (D+1, D)$	10	Δ *1	○	○	○	○	○
F321 P321	Floating-point type data exponent	EXP PEXP	S, D	$\text{EXP}(S+1, S) \rightarrow (D+1, D)$	10	Δ *1	○	○	○	○	○
F322 P322	Floating-point type data logarithm	LOG PLOG	S, D	$\text{LOG}(S+1, S) \rightarrow (D+1, D)$	10	Δ *1	○	○	○	○	○
F323 P323	Floating-point type data power	PWR PPWR	S1, S2, D	$(S1+1, S1) ^ (S2+1, S2) \rightarrow (D+1, D)$	14	Δ *1	○	○	○	○	○
F324 P324	Floating-point type data square root	FSQR PFSQR	S, D	$\sqrt{(S+1, S)} \rightarrow (D+1, D)$	10	Δ *1	○	○	○	○	○
F325 P325	16-bit integer data to floating-point type data conversion	FLT PFLT	S, D	Converts the 16-bit integer data with sign specified by "S" to real number data, and the converted data is stored in "D".	6	Δ *1	○	○	○	○	○
F326 P326	32-bit integer data to floating-point type data conversion	DFLT PDFLT	S, D	Converts the 32-bit integer data with sign specified by (S+1, S) to real number data, and the converted data is stored in (D+1, D).	8	Δ *1	○	○	○	○	○
F327 P327	Floating-point type data to 16-bit integer conversion (the largest integer not exceeding the floating-point type data)	INT PINT	S, D	Converts real number data specified by (S+1, S) to the 16-bit integer data with sign (the largest integer not exceeding the floating-point data), and the converted data is stored in "D".	8	Δ *1	○	○	○	○	○
F328 P328	Floating-point type data to 32-bit integer conversion (the largest integer not exceeding the floating-point type data)	DINT PDINT	S, D	Converts real number data specified by (S+1, S) to the 32-bit integer data with sign (the largest integer not exceeding the floating-point data), and the converted data is stored in (D+1, D).	8	Δ *1	○	○	○	○	○

○ : Available, × : Not available, Δ : Not available partially

*1) This instruction is available for FP-e Ver.1.21 or later, and FP0 V2.1 or later.

Number	Name	Boolean	Operand	Description	Steps	FP0/FP-e	FP0R	FPΣ	FP-X	FP2	FPΣH/FP10SH
F329 P329	Floating-point type data to 16-bit integer conversion (rounding the first decimal point down to integer)	FIX PFIIX	S, D	Converts real number data specified by (S+1, S) to the 16-bit integer data with sign (rounding the first decimal point down), and the converted data is stored in "D".	8	△ *1	○	○	○	○	○
F330 P330	Floating-point type data to 32-bit integer conversion (rounding the first decimal point down to integer)	DFIX PDFIIX	S, D	Converts real number data specified by (S+1, S) to the 32-bit integer data with sign (rounding the first decimal point down), and the converted data is stored in (D+1, D).	8	△ *1	○	○	○	○	○
F331 P331	Floating-point type data to 16-bit integer conversion (rounding the first decimal point off to integer)	ROFF PROFF	S, D	Converts real number data specified by (S+1, S) to the 16-bit integer data with sign (rounding the first decimal point off), and the converted data is stored in "D".	8	△ *1	○	○	○	○	○
F332 P332	Floating-point type data to 32-bit integer conversion (rounding the first decimal point off to integer)	DROFF PDROFF	S, D	Converts real number data specified by (S+1, S) to the 32-bit integer data with sign (rounding the first decimal point off), and the converted data is stored in (D+1, D).	8	△ *1	○	○	○	○	○
F333 P333	Floating-point type data rounding the first decimal point down	FINT PFINT	S, D	The decimal part of the real number data specified in (S+1, S) is rounded down, and the result is stored in (D+1, D).	8	△ *1	○	○	○	○	○
F334 P334	Floating-point type data rounding the first decimal point off	FRINT PFRINT	S, D	The decimal part of the real number data stored in (S+1, S) is rounded off, and the result is stored in (D+1, D).	8	△ *1	○	○	○	○	○
F335 P335	Floating-point type data sign changes	F+/- PF+/-	S, D	The real number data stored in (S+1, S) is changed the sign, and the result is stored in (D+1, D).	8	△ *1	○	○	○	○	○
F336 P336	Floating-point type data absolute	FABS PFABS	S, D	Takes the absolute value of real number data specified by (S+1, S), and the result (absolute value) is stored in (D+1, D).	8	△ *1	○	○	○	○	○
F337 P337	Floating-point type data degree → radian	RAD PRAD	S, D	The data in degrees of an angle specified in (S+1, S) is converted to radians (real number data), and the result is stored in (D+1, D).	8	△ *1	○	○	○	○	○
F338 P338	Floating-point type data radian → degree	DEG PDEG	S, D	The angle data in radians (real number data) specified in (S+1, S) is converted to angle data in degrees, and the result is stored in (D+1, D).	8	△ *1	○	○	○	○	○
Floating-point type real number data processing instructions											
F345 P345	Floating-point type data compare	FCMP PFCMP	S1, S2	(S1+1, S1)>(S2+1, S2)→ R900A: on (S1+1, S1)=(S2+1, S2)→ R900B on (S1+1, S1)<(S2+1, S2)→ R900C: on	10	×	○	○	○	○	○
F346 P346	Floating-point type data band compare	FWIN PFWIN	S1, S2, S3	(S1+1, S1)>(S3+1, S3)→ R900A: on (S2+1, S2)<or=(S1+1, S1)<or =(S3+1, S3)→ R900B on (S1+1, S1)<(S2+1, S2)→ R900C: on	14	×	○	○	○	○	○

○ : Available, × : Not available, △ : Not available partially

*1) This instruction is available for FP-e Ver.1.21 or later, and FP0 V2.1 or later.

Number	Name	Boolean	Operand	Description	Steps	FP0/FP-e	FP0R	FPΣ	FP-X	FP2	FP2SH/FP10SH
F347 P347	Floating-point type data upper and lower limit control	FLIMIT PFLIMIT	S1, S2, S3, D	When (S1+1, S1)>(S3+1, S3), (S1+1, S1)→(D+1, D) When (S2+1, S2)<(S3+1, S3), (S2+1, S2)→(D+1, D) When (S1+1, S1)<or=(S3+1, S3)<or=(S2+1, S2), (S3+1, S3)→(D+1, D)	17	×	○	○	○	○	○
F348 P348	Floating-point type data dead-band control	FBAND PFBAND	S1, S2, S3, D	When (S1+1, S1)>(S3+1, S3), (S3+1, S3)-(S1+1, S1)→(D+1, D) When (S2+1, S2)<(S3+1, S3), (S3+1, S3)-(S2+1, S2)→(D+1, D) When (S1+1, S1)<or=(S3+1, S3)<or=(S2+1, S2), 0.0→(D+1, D)	17	×	○	○	○	○	○
F349 P349	Floating-point type data zone control	FZONE PFZONE	S1, S2, S3, D	When (S3+1, S3)<0.0, (S3+1, S3)+(S1+1, S1)→(D+1, D) When (S3+1, S3)=0.0, 0.0→(D+1, D) When (S3+1, S3)>0.0, (S3+1, S3)+(S2+1, S2)→(D+1, D)	17	×	○	○	○	○	○
F350 P350	Floating-point type data maximum value	FMAX PFMAX	S1, S2, D	Searches the maximum value in the real number data table between the area selected with "S1" and "S2", and stores it in the (D+1, D). The address relative to "S1" is stored in (D+2).	8	×	×	×	×	○	○
F351 P351	Floating-point type data minimum value	FMIN PFMIN	S1, S2, D	Searches the minimum value in the real number data table between the area selected with "S1" and "S2", and stores it in the (D+1, D). The address relative to "S1" is stored in (D+2).	8	×	×	×	×	○	○
F352 P352	Floating-point type data total and mean values	FMEAN PFMEAN	S1, S2, D	The total value and the mean value of the real number data from the area selected with "S1" to "S2" are obtained. The total value is stored in the (D+1, D) and the mean value is stored in the (D+3, D+2).	8	×	×	×	×	○	○
F353 P353	Floating-point type data sort	FSORT PFSORT	S1, S2, S3	The real number data from the area specified by "S1" to "S2" are stored in ascending order (the smallest word is first) or descending order (the largest word is first).	8	×	×	×	×	○	○
F354 P354	Scaling of real number data	FSCAL PFSCAL	S1, S2, D	Scaling (linearization) on a real number data table is performed, and the output (Y) to an input value (X) is calculated.	12	×	○	△ ^{*1}	△ ^{*2}	△ ^{*3}	△ ^{*3}

○ : Available, × : Not available, △ : Not available partially

*1) This instruction is available for FPΣ 32k type.

*2) This instruction is available for FP-X Ver. 1.13 or later.

*3) This instruction is available for FP2/FP2SH Ver. 1.5 or later. FP10SH cannot be used.

Number	Name	Boolean	Operand	Description	Steps	FP0/FP-e	FP0R	FPΣ	FP-X	FP2	FP2SH/FP10SH
Time series processing instruction											
F355	PID processing	PID	S	PID processing is performed depending on the control value (mode and parameter) specified by (S to S+2) and (S+4 to S+10), and the result is stored in the (S+3).	4	△ ^{*1}	○	○	○	○	○
F356	Easy PID	EZPID	S1, S2, S3, S4	Temperature control (PID) can be easily performed using the image of a temperature controller.	10	×	○	△ ^{*2}	△ ^{*2}	×	×
Compare instructions											
F373 P373	16-bit data revision detection	DTR PDTR	S, D	If the data in the 16-bit area specified by "S" has changed since the previous execution, internal relay R9009 (carry flag) will turn on. "D" is used to store the data of the previous execution.	6	×	○	○	○	○	○
F374 P374	32-bit data revision detection	DDTR PDDTR	S, D	If the data in the 32-bit area specified by (S+1, S) has changed since the previous execution, internal relay R9009 (carry flag) will turn on. (D+1, D) is used to store the data of the previous execution.	6	×	○	○	○	○	○
Index register bank processing instructions											
F410 P410	Setting the index register bank number	SETB PSETB	n	Index register (I0 to ID) bank number change over.	4	×	×	×	×	×	○
F411 P411	Changing the index register bank number	CHGB PCHGB	n	Index register (I0 to ID) bank number change over with remembering preceding bank number.	4	×	×	×	×	×	○
F412 P412	Restoring the index register bank number	POPB PPOPB	-	Changes index register (I0 to ID) bank number back to the bank before F411 (CHGB)/P411 (PCHGB) instruction.	2	×	×	×	×	×	○
File register bank processing instructions											
F414 P414	Setting the file register bank number	SBFL PSBFL	n	File register bank number change over.	4	×	×	×	×	×	△ ^{*3}
F415 P415	Changing the file register bank number	CBFL PCBFL	n	File register bank number change over with remembering preceding bank number.	4	×	×	×	×	×	△ ^{*3}
F416 P416	Restoring the file register bank number	PBFL PPBFL	-	Changes file register bank number back to the bank before F415 (CBFL)/P415 (PCBFL) instruction.	2	×	×	×	×	×	△ ^{*3}

○ : Available, × : Not available, △ : Not available partially

*1) This instruction is available for FP0 (V2.1 or later) only.

*2) This instruction is available for FP-X V.1.20 or later, and FPΣ 32k type.

*3) This instruction is not available for FP10SH.

15.4 Table of Error codes

■ Difference in ERROR display

There are differences in the way errors are displayed depending on the model.

Model	Display		Display method
FP1,FP-M,FP2,FP3,FP10SH	LED	ERROR.	Continually lit
FP Σ ,FP0, FP0R, FP-X	LED	ERROR/ALARM	Flashes/continually lit
FP-e	Screen display	ERR.	Continually lit

■ Error Confirmation When ERROR Turns ON

When the “ERROR” on the control unit (CPU unit) turns on or flashes, a self-diagnostic error or syntax check error has occurred. Confirm the contents of the error and take the appropriate steps.

-Error Confirmation Method

Procedure:1.Use the programming tool software to call up the error code.

By executing the “STATUS DISPLAY”, the error code and content of error are displayed.

2.Check the error contents in the table of error codes using the error code ascertained above.

-Syntax check error

This is an error detected by the total check function when there is a syntax error or incorrect setting written in the program. When the mode selector is switched to the RUN mode, the total check function automatically activates and eliminates the possibility of incorrect operation from syntax errors in the program.

When a syntax check error is detected

-ERROR turns on or flashes.

-Operation will not begin even after switching to the RUN mode.

-Remote operation cannot be used to change to RUN mode.

Clearing a syntax check error

By changing to the PROG. mode, the error will clear and the ERROR will turn off.

Steps to take for syntax error

Change to the PROG. mode, and then execute the total check function while online mode with the programming tool connected. This will call up the content of error and the address where the error occurred.

Correct the program while referring to the content of error.

-Self-diagnostic Error

This error occurs when the control unit (CPU unit) self-diagnostic function detects the occurrence of an abnormality in the system. The self-diagnostic function monitors the memory abnormal detection, I/O abnormal detection, and other devices.

When a self-diagnostic error occurs

- The ERROR turns on or flashes.
- The operation of the control unit (CPU unit) might stop depending on the content of error and the system register setting.
- The error codes will be stored in the special data register DT9000(DT90000).
- In the case of operation error, the error address will be stored in the DT9017(DT90017) and DT9018(DT90018).

Clearing the self-diagnostic error

At the "STATUS DISPLAY", execute the "error clear". Error codes 43 and higher can be cleared.

- You can use the initialize/test switch to clear an error. However, this will also clear the contents of operation memory.
- Errors can also be cleared by turning off and on the power while in the PROG. mode. However, the contents of operation memory, not stored with the hold type data, will also be cleared.
- The error can also be cleared depending on the self-diagnostic error set instruction F148(ERR).

Steps to take for self-diagnostic error

The steps to be taken will differ depending on the error contents. For more details, use the error code obtained above and consult the table of self-diagnostic error codes.

■ MEWTOCOL-COM Transmission Errors

These are error codes from a PC or other computer device that occur during an abnormal response when communicating with a PLC using MEWTOCOL-COM.

15.4.1 Table of Syntax Check Error

Error code	Name	Operation status	Description and steps to take	FP-e	FP0	FP0R	FP $\bar{2}$	FP-X	FP2	FP2SH	FP10SH
E1	Syntax error	Stops	A program with a syntax error has been written. ⇒ Change to PROG. mode and correct the error.	A	A	A	A	A	A	A	A
E2 (Note)	Duplicated output error	Stops	Two or more OT(Out) instructions and KP(Keep) instructions are programmed using the same relay. Also occurs when using the same timer/counter number. ⇒ Change to PROG. mode and correct the program so that one relay is not used for two or more OT instructions. Or, set the duplicated output to "enable" in system register 20. A timer/counter instruction double definition error will be detected even if double output permission has been selected.	A	A	A	A	A	A	A	A
E3	Not paired error	Stops	For instructions which must be used in a pair such as jump (JP and LBL), one instruction is either missing or in an incorrect position. ⇒ Change to PROG. mode and enter the two instructions which must be used in a pair in the correct positions.	A	A	A	A	A	A	A	A
E4	Parameter mismatch error	Stops	An instruction has been written which does not agree with system register settings. For example, the number setting in a program does not agree with the timer/counter range setting. ⇒ Change to PROG. mode, check the system register settings, and change so that the settings and the instruction agree.	A	A	A	A	A	A	A	A
E5 (Note)	Program area error	Stops	An instruction which must be written in a specific area (main program area or subprogram area) has been written to a different area (for example, a subroutine SUB to RET is placed before an ED instruction). ⇒ Change to PROG. mode and enter the instruction into the correct area.	A	A	A	A	A	A	A	A

A: Available

Note) This error is also detected if you attempt to execute a rewrite containing a syntax error during RUN. In this case, nothing will be written to the CPU and operation will continue.

Error code	Name	Operation status	Description and steps to take	FP-e	FP0	FP0R	FPΣ	FP-X	FP2	FP2SH	FP10SH
E6	Compile memory full error	Stops	The program is too large to compile in the program memory. ⇒ Change to PROG. mode and reduce the total number of steps for the program. -FP10SH If memory expansion is possible, compilation will become possible when the memory is expanded.	A	A	A	A	A		A	A
E7	High-level instruction type error	Stops	In the program, high-level instructions, which execute in every scan and at the leading edge of the trigger, are programmed to be triggered by one contact. (e.g. F0 (MV) and P0 (PMV) are programmed using the same trigger continuously.) ⇒ Correct the program so that the high-level instructions executed in every scan and only at the leading edge are triggered separately.			A	A	A	A	A	A
E8	High-level instruction operand combination error	Stops	There is an incorrect operand in an instruction which requires a specific combination of operands (for example, the operands must all be of a certain type). ⇒ Enter the correct combination of operands.	A	A	A	A	A	A	A	A
E9	No program error	Stops	Program may be damaged. ⇒ Try to send the program again.							A	A
E10	Rewrite during RUN syntax error	Continues	When inputting with the programming tool software, a deletion, addition or change of order of an instruction(ED, LBL, SUB, RET, INT, IRET, SSTOP, and STPE) that cannot perform a rewrite during RUN is being attempted. Nothing is written to the CPU.						A	A	A

A: Available

15.4.2 Table of Self-Diagnostic Error

Error code	Name	Operation status	Description and steps to take	FP-e	FP0	FP0R	FPΣ	FP-X	FP2	FP2SH	FP10SH
E20	CPU error	Stops	Probably a hardware abnormality ⇒Please contact your dealer.						A	A	A
E21	RAM error1	Stops	Probably an abnormality in the internal RAM. ⇒Please contact your dealer.						A	A	A
E22	RAM error2										
E23	RAM error3										
E24	RAM error4										
E25	RAM error5										
E25	Master memory model unmatch error	Stops	The models of master memories are different. Use the master memories created with the same model.					A ^{*1)}			
E26	User's ROM error	Stops	FP-e,FP0,FP0R,FPΣ, and FP1 C14,C16:Probably a hardware abnormality. ⇒ Please contact your dealer.	A	A	A	A	A	A	A	A
			FP-X: When the master memory cassette is mounted, the master memory cassette may be damaged. Remove the master memory, and check whether the ERROR turns off. When the ERROR turned off, rewrite the master memory as its contents are damaged, and use it again. When the ERROR does not turn off, please contact your dealer.								
			FP1 C24,C40,C56,C72,and FP-M: Probably an abnormality in the memory unit ⇒Program the memory unit again and try to operate. If the same error is detected, try to operate with another memory unit.								
			FP2,FP2SH,FP10SH,and FP3: There may be a problem with the installed ROM. -ROM is not installed. -ROM contents are damaged. -Program size stored on the ROM is larger than the capacity of the ROM ⇒Check the contents of the ROM								
E27	Unit installation error	Stops	Units installed exceed the limitations.(i.e.,4 or more link units) ⇒ Turn off the power and re-configure units referring to the hardware manual.			A	A	A	A	A	A
E28	System register error	Stops	Probably an abnormality in the system register. ⇒ Check the system register setting or initialize the system registers.						A		

*1) This error occurs on FP-X Ver2.0 or later.

A: Available

Error code	Name	Operation status	Description and steps to take	FP-e	FP0	FP0R	FPΣ	FP-X	FP2	FP2SH	FP10SH
E29	Configuration parameter error	Stops	A parameter error was detected in the MEWNET-W2 configuration area. Set a correct parameter.						A	A	
E30	Interrupt error 0	Stops	Probably a hardware abnormality. ⇒ Please contact your dealer.								
E31	Interrupt error 1	Stops	An interrupt occurred without an interrupt request . A hardware problem or error due to noise is possible. ⇒ Turn off the power and check the noise conditions.	A	A	A	A	A	A	A	A
E32	Interrupt error 2	Stops	There is no interrupt program for an interrupt which occurred. ⇒ Check the number of the interrupt program and change it to agree with the interrupt request..	A	A	A	A	A	A	A	A
E33	Multi-CPU data unmatch error	CPU2 Stops	This error occurs when a FP3/FP10SH is used as CPU2 for a multi-CPU system. ⇒Refer to "Multi-CPU system Manual".							A	A
E34	I/O status error	Stops	An abnormal unit is installed. -FPΣ, FP0R(FP0R mode),FP-X, FP2,FP2SH and FP10SH: Check the contents of special data register DT90036 and locate the abnormal unit. Then turn off the power and replace the unit with a new one. -FP3: Check the contents of special data register DT9036 and locate the abnormal unit. Then turn off the power and replace the unit with a new one.			A	A	A		A	A
E35	MEWNET-F slave illegal unit error	Stops	A unit, which cannot be installed on the slave station of the MEWNET-F link system, is installed on the slave station. ⇒Remove the illegal unit from the slave station.						A	A	A
E36	MEWNET-F (remote I/O) limitation error	Stops	The number of slots or I/O points used for MEWNET-F(remote I/O) system exceeds the limitation. ⇒Re-configure the system so that the number of slots and I/O points is within the specified range.						A	A	A
E37	MEWNET-F I/O mapping error	Stops	I/O overlap or I/O setting that is over the range is detected in the allocated I/O and MEWNET-F I/O map. ⇒Re-configure the I/O map correctly						A	A	A

A: Available

Error code	Name	Operation status	Description and steps to take	FP-e	FP0	FP0R	FPΣ	FP-X	FP2	FP2SH	FP10SH
E38	MEWNET-F slave I/O terminal mapping error	Stops	I/O mapping for remote I/O terminal boards, remote I/O terminal units and I/O link is not correct. ⇒Re-configure the I/O map for slave stations according to the I/O points of the slave stations.						A	A	A
E39	IC card read error	Stops	When reading in the program from the IC memory card(due to automatic reading because of the dip switch setting or program switching due to F14(PGRD) instruction): - IC memory card is not installed. - There is no program file or it is damaged. - Writing is disabled. - There is an abnormality in the AUTOEXEC.SPG file. - Program size stored on the card is larger than the capacity of the CPU. ⇒Install an IC memory card that has the program properly recorded and execute the read once again.							A	A
E40	I/O error	Selectable	Abnormal I/O unit. FPΣ, FP-X: Check the contents of special data register DT90002 and abnormal FPΣ expansion unit (application cassette for FP-X). Then check the unit. FP2 and FP2SH: Check the contents of special data registers DT90002,DT90003 and abnormal I/O unit. Then check the unit. Selection of operation status using system register21: -to continue operation, set 1 -to stop operation, set 0 Verification is possible in FPWIN GR/Pro at "I/O error" in the status display function.				A	A	A	A	A
			MEWNET-TR communication error FP3 and FP10SH: Check the contents of special data registers(FP3:DT9002,DT9003,FP10SH:DT90002,DT90003) and the erroneous master unit and abnormal I/O unit. Then check the unit. Selection of operation status using system register21: -to continue operation, set 1 -to stop operation, set 0 Verification is possible in FPWIN GR/Pro at "I/O error" in the status display function.								

A: Available

Error code	Name	Operation status	Description and steps to take	FP-e	FP0	FP0R	FPΣ	FP-X	FP2	FP2SH	FP10SH
E41	Intelligent unit error	Selectable	<p>An abnormality in an intelligent unit.</p> <p>FPΣ, FP-X: Check the contents of special data register "DT90006" and locate the abnormal FP intelligent unit (application cassette for FP-X).</p> <p>FP2,FP2SH,and FP10SH: Check the contents of special data registers DT90006,DT90007 and locate the abnormal intelligent unit. Then check the unit referring to its manual..</p> <p>Selection of operation status using system register22: -to continue operation, set 1 -to stop operation, set 0</p> <p>FP3: Check the contents of special data registers DT9006,DT9007 and locate the abnormal intelligent unit. Then check the unit referring to its manual..</p> <p>Selection of operation status using system register22: -to continue operation, set 1 -to stop operation, set 0</p> <p>Verification is possible in FPWIN GR/Pro at "I/O error" in the status display function.</p>				A	A	A	A	A
E42	I/O unit verify error	Selectable	<p>I/O unit(Expansion unit) wiring condition has changed compared to that at time of power-up.</p> <p>⇒ Check the contents of special data register (FP0: DT9010, FPΣ, FP-X: DT90010,DT90011) and locate the erroneous expansion unit.</p> <p>It checks whether an expansion connector is in agreement.</p> <p>⇒ Check the contents of special data register (FP2,FP2SH,and FP10SH:DT90010,DT90011,FP3 DT9010,DT9011)</p> <p>Selection of operation status using system register23: -to continue operation, set 1 -to stop operation, set 0</p> <p>Verification is possible in FPWIN GR/Pro at "I/O error" in the status display function.</p>		A	A	A	A	A	A	A

A: Available

Error code	Name	Operation status	Description and steps to take	FP-e	FP0	FP0R	FPΣ	FP-X	FP2	FP2SH	FP10SH
E43	System watching dog timer error	Selectable	Scan time required for program execution exceeds the setting of the system watching dog timer. ⇒ Check the program and modify it so that the program can execute a scan within the specified time. Selection of operation status using system register24: -to continue operation, set 1 -to stop operation, set 0							A	A
E44	Slave station connecting time error for MEWNET-F system	Selectable	The time required for slave station connection exceeds the setting of the system register 35. Selection of operation status using system register25: -to continue operation, set 1 -to stop operation, set 0						A	A	A
E45	Operation error	Selectable	Operation became impossible when a high-level instruction was executed. Selection of operation status using system register26: -to continue operation, set K1 -to stop operation, set K0 The address of operation error can be confirmed in either special data registers DT9017 and DT9018, or DT90017 and DT90018. (It varies according to the model to be used.) DT9017, DT9018: FP-e, FP0, FP0R(FP0 mode) DT90017, DT90018: FPΣ, FP-X, FP0R(FP0R mode), FP2, FP2SH, FP10SH Verification is possible in FPWIN GR/Pro at "I/O error" in the status display function.	A	A	A	A	A	A	A	A

A: Available

Error code	Name	Operation status	Description and steps to take	FP-e	FP0	FP0R	FPΣ	FP-X	FP2	FP2SH	FP10SH
E46	Remote I/O communication error	Selectable	S-LINK error Occurs only in FP0-SL1 When one of the S-LINK errors (ERR1, 3 or 4) has been detected, error code E46 (remote I/O (S-LINK) communication error) is stored. Selection of operation status using system register27: -to continue operation, set K1 -to stop operation, set K0		A						
		Selectable	MEWNET-F communication error A communication abnormally was caused by a transmission cable or during the power-down of a slave station. FP2, FP2SH, and FP10SH: Check the contents of special data registers DT90131 to DT90137 and locate the abnormal slave station and recover the communication condition. FP3: Check the contents of special data registers DT9131 to DT9137 and locate the abnormal slave station and recover the communication condition. Selection of operation status using system register27: -to continue operation, set K1 -to stop operation, set K0					A	A	A	
E47	MEW-NET-F attribute error	Selectable	In the unit on the slave station, an abnormality such as: -missing unit -abnormal intelligent unit was detected. FP2, FP2SH, and FP10SH: Check the contents of special data registers DT90131 to DT90137 and locate the abnormal slave station and recover the slave condition. FP3: Check the contents of special data registers DT9131 to DT9137 and locate the abnormal slave station and recover the slave condition. Selection of operation status using system register28: -to continue operation, set 1 -to stop operation, set 0						A	A	A
E49	Expansion unit power supply sequence error	Stops	The power supply for the expansion unit was turned on after the control unit. Turn on the power supply for the expansion unit at the same time or before the control unit is turned on.					A			
E50	Backup battery error	Continues	The voltage of the backup battery lowered or the backup battery of control unit is not installed. ⇒ Check the installation of the backup battery and then replace battery if necessary. By setting the system register 4, you can disregard this self-diagnostic error.				A	A	A	A	A

Error code	Name	Operation status	Description and steps to take	FP-e	FP0	FP0R	FPΣ	FP-X	FP2	FP2SH	FP10SH
E51	MEWNET-F terminal station error	Continues	Terminal station setting was not properly performed. Check stations at both ends of the communication path, and set them in the terminal station using the dip switches.						A	A	A
E52	MEWNET-F I/O update synchronous error	Continues	Set the INITIALIZE/TEST selecto1 inmjvbgycfrde892 r to the INITIALIZE position while keeping the mode selector in the RUN position. If the same error occurs after this, please contact your dealer.						A	A	A
E53	Multi-CPU I/O registration error (CPU2 only)	Continues	Abnormality was detected when the multi-CPU system was used. Please contact your dealer.								A
E54	IC memory card backup battery error	Continues	The voltage of the backup battery for the IC memory card lowered. The BATT.LED does not turn on. Charge or replace the backup battery of IC memory card.(The contents of the IC memory card cannot be guaranteed.)							A	A
E55	IC memory card backup battery error	Continues	The voltage of the backup battery for IC memory card lowers. The BATT.LED does not turn on. Charge or replace the backup battery of IC memory card. (The contents of the IC memory card cannot be guaranteed.)							A	A
E56	Incompatible IC memory card error	Continues	The IC memory card installed is not compatible. Replace the IC memory card compatible with FP2SH/FP10SH.							A	A
E57	No unit for the configuration	Continues	MEWNET-W2/MCU The MEWNET-W2 link unit or MCU(Multi communication unit) is not installed in the slot specified using the configuration data. Either install a unit in the specified slot or change the parameter.						A	A	
E100 to E199	Self-diagnostic error set by F148 (ERR)/P148 (PERR) instruction	Stop	The error specified by the F148 (ERR)/P148(PERR) instruction is occurred. ⇒ Take steps to clear the error condition according to the specification you chose.	A	A	A	A	A	A		
E200 to E299		Continues		A	A	A	A	A	A		

A :Available

15.4.3 Table of MEWTOCOL-COM Communication Error

Error code	Name	Description
I21	NACK error	Link system error
I22	WACK error	Link system error
I23	Unit No. overlap	Link system error
I24	Transmission format error	Link system error
I25	Link unit hardware error	Link system error
I26	Unit No. setting error	Link system error
I27	No support error	Link system error
I28	No response error	Link system error
I29	Buffer closed error	Link system error
I30	Time-out error	Link system error
I32	Transmission impossible error	Link system error
I33	Communication stop	Link system error
I36	No destination error	Link system error
I38	Other communication error	Link system error
I40	BCC error	A transfer error occurred in the received data.
I41	Format error	A command was received that does not fit the format.
I42	No support error	A command was received that is not supported.
I43	Multiple frames procedure error	A different command was received when processing multiple frames.
I50	Link setting error	A route number that does not exist was specified. Verify the route number by designating the transmission station.
I51	Transmission time-out error	Transmission to another device not possible because transmission buffer is congested.
I52	Transmit disable error	Transmission processing to another device is not possible.(Link unit runaway, etc.)
I53	Busy error	Command process cannot be received because of multiple frame processing. Or, cannot be received because command being processed is congested.
I60	Parameter error	Content of specified parameter does not exist or cannot be used.
I61	Data error	There was a mistake in the contact, data area, data number designation, size designation, range, or format designation.
I62	Registration over error	Operation was does when number of registrations was exceeded or when there was no registration.
I63	PC mode error	PC command that cannot be processed was executed during RUN mode.

Error code	Name	Description
!64	External memory error	<p>An abnormality occurred when loading RAM to ROM/IC memory card. There may be a problem with the ROM or IC memory card.</p> <ul style="list-style-type: none"> -When loading, the specified contents exceeded the capacity. -Write error occurs. -ROM or IC memory card is not installed. -ROM or IC memory card does not conform to specifications -ROM or IC memory card board is not installed.
!65	Protect error	<p>A program or system register write operation was executed when the protect mode (password setting or DIP switch, etc.) or ROM operation mode was being used.</p>
!66	Address error	<p>There was an error in the code format of the address data. Also, when exceeded or insufficient of address data, there was a mistake in the range designation.</p>
!67	No program error and No data error	<p>Cannot be read because there is no program in the program area or the memory contains an error. Or, reading was attempted of data that was not registered.</p>
!68	Rewrite during RUN error	<p>When inputting with programming tool software, editing of an instruction (ED, SUB, RET, INT, IRET, SSTP, and STPE) that cannot perform a rewrite during RUN is being attempted. Nothing is written to the CPU.</p>
!70	SIM over error	<p>Program area was exceeded during a program write process.</p>
!71	Exclusive access control error	<p>A command that cannot be processed was executed at the same time as a command being processed.</p>

15.5 MEWTOCOL-COM Communication Commands

Table of MEWTOCOL-COM commands

Command name	Code	Description
Read contact area	RC (RCS) (RCP) (RCC)	Reads the on and off status of contact. - Specifies only one point. - Specifies multiple contacts. - Specifies a range in word units.
Write contact area	WC (WCS) (WCP) (WCC)	Turns contacts on and off. - Specifies only one point. - Specifies multiple contacts. - Specifies a range in word units.
Read data area	RD	Reads the contents of a data area.
Write data area	WD	Writes data to a data area.
Read timer/counter set value area	RS	Reads the value set for a timer/counter.
Write timer/counter set value area	WS	Writes a timer/counter setting value.
Read timer/counter elapsed value area	RK	Reads the timer/counter elapsed value.
Write timer/counter elapsed value area	WK	Writes the timer/counter elapsed value.
Register or Reset contacts monitored	MC	Registers the contact to be monitored.
Register or Reset data monitored	MD	Registers the data to be monitored.
Monitoring start	MG	Monitors a registered contact or data using the code "MC or MD".
Preset contact area (fill command)	SC	Embeds the area of a specified range in a 16-point on and off pattern.
Preset data area (fill command)	SD	Writes the same contents to the data area of a specified range.
Read system register	RR	Reads the contents of a system register.
Write system register	WR	Specifies the contents of a system register.
Read the status of PLC	RT	Reads the specifications of the programmable controller and error codes if an error occurs.
Remote control	RM	Switches the operation mode of the programmable controller.
Abort	AB	Aborts communication.

15.6 Hexadecimal/Binary/BCD

Decimal	Hexadecimal	Binary data	BCD data (Binary Coded Decimal)
0	0000	00000000 00000000	0000 0000 0000 0000
1	0001	00000000 00000001	0000 0000 0000 0001
2	0002	00000000 00000010	0000 0000 0000 0010
3	0003	00000000 00000011	0000 0000 0000 0011
4	0004	00000000 00000100	0000 0000 0000 0100
5	0005	00000000 00000101	0000 0000 0000 0101
6	0006	00000000 00000110	0000 0000 0000 0110
7	0007	00000000 00000111	0000 0000 0000 0111
8	0008	00000000 00001000	0000 0000 0000 1000
9	0009	00000000 00001001	0000 0000 0000 1001
10	000A	00000000 00001010	0000 0000 0001 0000
11	000B	00000000 00001011	0000 0000 0001 0001
12	000C	00000000 00001100	0000 0000 0001 0010
13	000D	00000000 00001101	0000 0000 0001 0011
14	000E	00000000 00001110	0000 0000 0001 0100
15	000F	00000000 00001111	0000 0000 0001 0101
16	0010	00000000 00010000	0000 0000 0001 0110
17	0011	00000000 00010001	0000 0000 0001 0111
18	0012	00000000 00010010	0000 0000 0001 1000
19	0013	00000000 00010011	0000 0000 0001 1001
20	0014	00000000 00010100	0000 0000 0010 0000
21	0015	00000000 00010101	0000 0000 0010 0001
22	0016	00000000 00010110	0000 0000 0010 0010
23	0017	00000000 00010111	0000 0000 0010 0011
24	0018	00000000 00011000	0000 0000 0010 0100
25	0019	00000000 00011001	0000 0000 0010 0101
26	001A	00000000 00011010	0000 0000 0010 0110
27	001B	00000000 00011011	0000 0000 0010 0111
28	001C	00000000 00011100	0000 0000 0010 1000
29	001D	00000000 00011101	0000 0000 0010 1001
30	001E	00000000 00011110	0000 0000 0011 0000
31	001F	00000000 00011111	0000 0000 0011 0001
.	.	.	.
.	.	.	.
.	.	.	.
63	003F	00000000 00111111	0000 0000 0110 0011
.	.	.	.
.	.	.	.
.	.	.	.
255	00FF	00000000 11111111	0000 0010 0101 0101
.	.	.	.
.	.	.	.
.	.	.	.
9999	270F	00100111 00001111	1001 1001 1001 1001

15.7 ASCII Codes

								b7								
								b6	0	0	0	0	1	1	1	1
								b5	0	0	1	1	0	0	1	1
								b4	0	1	0	1	0	1	0	1
b7	b6	b5	b4	b3	b2	b1	b0	R \ C	0	1	2	3	4	5	6	7
0	0	0	0	0	0	0	0	0	NUL	DEL	SPACE	0	@	P	`	p
0	0	0	0	1	1	1	1	1	SOH	DC1	!	1	A	Q	a	q
0	0	1	0	0	0	0	0	2	STX	DC2	"	2	B	R	b	r
0	0	1	1	1	1	1	1	3	ETX	DC3	#	3	C	S	c	s
0	1	0	0	0	0	0	0	4	EOT	DC4	\$	4	D	T	d	t
0	1	0	1	1	1	1	1	5	ENQ	NAK	%	5	E	U	e	u
0	1	1	0	0	0	0	0	6	ACK	SYN	&	6	F	V	f	v
0	1	1	1	1	1	1	1	7	BEL	ETB	'	7	G	W	g	w
1	0	0	0	0	0	0	0	8	BS	CAN	(8	H	X	h	x
1	0	0	1	1	1	1	1	9	HT	EM)	9	I	Y	i	y
1	0	1	0	0	0	0	0	A	LF	SUB	*	:	J	Z	j	z
1	0	1	1	1	1	1	1	B	VT	ESC	+	;	K	[k	{
1	1	0	0	0	0	0	0	C	FF	FS	,	<	L	¥	l	
1	1	0	1	1	1	1	1	D	CR	GS	-	=	M]	m	}
1	1	1	0	0	0	0	0	E	SO	RS	.	>	N	^	n	~
1	1	1	1	1	1	1	1	F	SI	US	/	?	O	_	o	DEL

Record of changes

Manual No.	Date	Description of changes
ARCT1F475E	May.2009	First Edition
ARCT1F475E-1	Sep.2009	2nd Edition
ARCT1F475E-2	Aug.2011	3rd Edition Addition -FP0R Control Unit(RS485 Type) -FP0R Expansion Unit Error correction
ARCT1F475E-3	Jul.2013	4th Edition

Please contact

Panasonic Industrial Devices SUNX Co., Ltd.

■ Overseas Sales Division (Head Office): 2431-1 Ushiyama-cho, Kasugai-shi, Aichi, 486-0901, Japan

■ Telephone: +81-568-33-7861 ■ Facsimile: +81-568-33-8591

panasonic.net/id/pidsx/global

About our sale network, please visit our website.