

Programmable Controller  
FP0H Control Unit  
**User's Manual**

---

Positioning/PWM Output/High-Speed Counter

(MEMO)

## Introduction

Thank you for purchasing a Panasonic product. Before you use the product, please carefully read through the user's manual, and understand it in detail to use the product properly.

## Types of Manual

- This manual describes the "positioning function (table setting mode) / PWM output and high-speed counter function" implemented in FP0H Control Unit.
- There are different types of user's manual for the FP0H series. Please refer to a relevant manual for the unit and purpose of your use.
- The manuals can be downloaded on our website: <https://industry.panasonic.com/global/en/downloads/?tab=manual>.

Unit name or purpose of use	Manual name	Manual code
FP0H Control Unit	FP0H User's Manual (Basic)	WUME-FP0HBAS
	FP0H Programming Manual	WUME-FP0HPGR
	FP0H Programming Manual (SD Card Access Instructions)	WUME-FP0HSD
Positioning Function/PWM Output/High-speed Counter Function	FP0H User's Manual (Positioning/PWM Output/High-speed Counter)	WUME-FP0HPOS
Serial Communication Function	FP0H User's Manual (COM Communication)	WUME-FP0HCOM
Ethernet Communication Function	FP0H User's Manual (Ethernet Communication)	WUME-FP0HET
EtherNet/IP Communication Function	FP0H User's Manual (EtherNet/IP)	WUME-FP0HEIP
Logging trace function	FP0H User's Manual (Logging/Trace Function)	WUME-FP0HLOG
FP0H Extension (Communication) Cassette	FP0H User's Manual (COM Communication)	WUME-FP0HCOM
FP0H Positioning Unit	FP0H Positioning Unit User's Manual	WUME-FP0HPG
FP0H Positioning Unit RTEX	FP0H Positioning Unit RTEX User's Manual (FPWIN GR7)	WUME-FP0HRTEXGR7

## SAFETY PRECAUTIONS

- To prevent accidents or personal injuries, please be sure to comply with the following items.
- Prior to installation, operation, maintenance and check, please read this manual carefully for proper use.
- Before using, please fully understand the knowledge related to the equipment, safety precautions and all other precautions.
- Safety precautions are divided into two levels in this manual: Warning and Caution.

 **WARNING** Incorrect operation may lead to death or serious injury.

- Take appropriate safety measures to the external circuit of the product to ensure the security of the whole system in case of abnormalities caused by product failure or external.
- Do not use this product in areas with inflammable gases.  
Otherwise it may lead to an explosion.
- Do not put this product into a fire.  
Otherwise it could cause damage to the battery or other electronic parts.

 **CAUTION** Incorrect operation may lead to injury or material loss.

- To prevent the excessive exothermic heat or smoke generation of the product, a certain margin is required for guaranteed characteristics and performance ratings of relative products.
- Do not decompose or transform it.  
Otherwise it will lead to the excessive exothermic heat or smoke generation of the product.
- Do not touch terminal blocks during power-on.  
Otherwise it may result in an electric shock.
- Set an emergency stop and interlock circuit in the external devices.
- Connect wires and connectors reliably.  
Otherwise it may lead to the excessive exothermic heat or smoke generation of the product.
- Do not undertake construction (such as connection and disconnection) while the power supply is on.  
It could lead to an electric shock.
- If the equipment is used in a manner not specified by the Panasonic, the protection provided by the equipment may be impaired.
- This product has been developed/produced for industrial use only.

## Description on Copyright and Trademarks

- The copyright of this manual is owned by **Panasonic Industry Co., Ltd.**
- Unauthorized reproduction of this manual is strictly prohibited.
- Windows is a registered trademark of Microsoft Corporation in the U.S. and other countries.
- Ethernet is a registered trademark of FUJIFILM Business Innovation Corp. and Xerox Corporation.
- EtherNet/IP is a registered trademark of ODVA (Open DeviceNet Vendor Association).
- SDHC and SD logos are trademarks of LLC.
- Other company and product names are trademarks or registered trademarks of their respective companies.

# Table of Contents

<b>1 Functions of Unit and Restrictions on Combination</b> .....	<b>1-1</b>
1.1 Functions of Unit.....	1-2
1.1.1 Overview of FP0H Positioning Function .....	1-2
1.1.2 Compatibility Function with FPsigma .....	1-3
1.2 Restrictions on Combinations and Functions .....	1-4
1.2.1 Applicable Versions of Unit and Software .....	1-4
1.2.2 Restrictions on I/O Allocation.....	1-4
1.3 Comparison of Pulse Output Function .....	1-6
1.3.1 Types of Positioning Control Modes .....	1-6
1.3.2 Selection of Positioning Control Mode .....	1-6
1.3.3 Comparison of Two Control Modes.....	1-7
<b>2 Wiring</b> .....	<b>2-1</b>
2.1 Connections with Servo Motor Amplifier .....	2-2
2.1.1 Connection Example .....	2-2
2.1.2 Precautions on Connection.....	2-3
2.2 Connection with Stepping Motor Driver .....	2-4
2.2.1 Precautions on Connection.....	2-4
<b>3 Power ON and OFF, and Items to Check</b> .....	<b>3-1</b>
3.1 Safety Circuit Design .....	3-2
3.2 Before Turning On the Power .....	3-3
3.3 Procedure for Turning On the Power .....	3-4
3.3.1 Procedure for Turning On the Power .....	3-4
3.3.2 Procedure for Turning Off the Power .....	3-4
3.4 Confirming while the Power is ON .....	3-5
3.4.1 Items to check after turning on the power .....	3-5
3.4.2 Checking the Installation of the External Safety Circuit .....	3-6
3.4.3 Checking the Safety Circuit Based on the Unit.....	3-6
3.4.4 Checking the Operation of the Near Home Switch and Home Switch .....	3-6
3.4.5 Checking Rotating and Moving Directions and Moving Distance ....	3-7
<b>4 Settings of Control Unit</b> .....	<b>4-1</b>
4.1 Confirming I/O Allocation .....	4-2
4.1.1 When Using Pulse Output Table Setting Mode .....	4-2
4.1.2 When Using Pulse Output Function (FPsigma Compatible Instruction Mode) .....	4-3
4.1.3 When Using PWM Output Function .....	4-5
4.1.4 When Using High-speed Counter Function .....	4-6
4.2 Settings in Configurator PMX.....	4-8
4.2.1 Allocating Channels to be Used .....	4-8
4.2.2 Setting Parameters .....	4-9
4.2.3 Creating Positioning Data Table.....	4-11
4.2.4 Saving Positioning Parameters .....	4-13

4.2.5	Export and Import .....	4-14
4.2.6	Check on Parameter Data .....	4-14
4.2.7	Writing Parameters to Unit (1).....	4-15
4.2.8	Writing Parameters to Unit (2).....	4-15
4.3	System Register Settings.....	4-17
4.3.1	Confirming and Selecting Functions to be Used .....	4-17
4.4	Reading Elapsed Values .....	4-19
4.4.1	Elapsed Value (Current Value) Area .....	4-19
4.4.2	Reading Elapsed Value (Current Value) Area .....	4-19
<b>5</b>	<b>Operation Patterns.....</b>	<b>5-1</b>
5.1	Stop Operation.....	5-2
5.1.1	Type of Stop Operations .....	5-2
5.1.2	Characteristics of Stop Operations .....	5-3
5.2	JOG Operation.....	5-4
5.2.1	Settings and Operations of JOG Operation .....	5-4
5.2.2	Settings and Operation of JOG Operation (Speed Changes).....	5-6
5.2.3	Changing the Speed During JOG Operation .....	5-8
5.3	Home Return.....	5-9
5.3.1	Types of Home Return .....	5-9
5.3.2	Operation Patterns of Home Return .....	5-10
5.3.3	Settings and Operations of Home Return .....	5-12
5.4	Positioning Control.....	5-16
5.4.1	Types of Positioning Control .....	5-16
5.4.2	E-point Control (First Speed Positioning).....	5-17
5.4.3	P-point Control (Second Speed Positioning) .....	5-18
5.4.4	C-point Control.....	5-20
5.4.5	J-point Control (JOG Positioning Control).....	5-22
5.4.6	J-point Control (JOG Positioning: Speed Changes) .....	5-23
5.4.7	Programming Cautions .....	5-26
5.5	Repeat Operation.....	5-28
5.5.1	Overview of Repeat Operation.....	5-28
5.5.2	Settings and Operations of Repeat Operation .....	5-29
5.5.3	Stop Operation During Repeat Operation .....	5-31
5.6	Linear Interpolation Control.....	5-33
5.6.1	Overview .....	5-33
5.6.2	Settings and Operations of Linear Interpolation.....	5-33
<b>6</b>	<b>Operating Characteristics .....</b>	<b>6-1</b>
6.1	Operational Difference Between Parameters .....	6-2
6.1.1	Startup speed.....	6-2
6.1.2	When Target Speed/Startup Speed is Less Than 50Hz .....	6-2
6.1.3	Operation Patterns and Start Speed Settings .....	6-3
6.2	Other Characteristics .....	6-5
6.2.1	Backup of Positioning Memory .....	6-5
6.2.2	Activation of Each Operation .....	6-5
6.2.3	Operation When PLC Mode Changes From RUN To PROG .....	6-5
<b>7</b>	<b>Instruction References .....</b>	<b>7-1</b>

7.1 Table Setting Mode Control Instruction .....	7-2
7.1.1 F380 POSST (Positioning Table Start) .....	7-2
7.1.2 F381 JOGST (JOG Operation Start).....	7-3
7.1.3 F382 ORGST (Home Return Start).....	7-4
7.1.4 F383 MPOST (Positioning Simultaneous Start).....	7-5
7.1.5 F384 PTBLR (Positioning Parameter Read).....	7-6
7.1.6 F385 PTBLW (Positioning Parameter Write).....	7-8
7.2 FPsigma Compatible Instruction Mode Control Instruction.....	7-10
7.2.1 [F171(SPDH)] Pulse Output (Trapezoidal Control) .....	7-10
7.2.2 [F171(SPDH)] Pulse Output (Home Return).....	7-15
7.2.3 [F172(PSLH)] Pulse Output (JOG Operation).....	7-20
7.2.4 [F174(SPOH)] Pulse Output (Selectable Data Table Control Operation).....	7-22
7.2.5 [F175(SPSH)] Pulse Output (Linear Interpolation).....	7-27
<b>8 Troubleshooting .....</b>	<b>8-1</b>
8.1 Self-diagnostic Function.....	8-2
8.1.1 Operation Monitor LEDs of Control Unit .....	8-2
8.2 What to Do If an Error Occurs.....	8-4
8.2.1 ERR/ALM LED Flashes .....	8-4
8.2.2 What to Do When Positioning Error Occurs.....	8-5
8.2.3 Motor Does Not Rotate/Move (Output LED Flashes or is ON) .....	8-7
8.2.4 Motor Does Not Rotate/Move (Output LED is OFF) .....	8-7
8.2.5 Rotation/Movement Direction is Reversed.....	8-8
<b>9 PWM Output Function .....</b>	<b>9-1</b>
9.1 PWM Output Function.....	9-2
9.1.1 Overview of PWM Output Function.....	9-2
9.1.2 System Register Settings.....	9-2
9.1.3 [F173 PWMH] PWM Output Instruction (Frequency Specification) .	9-3
9.1.4 [F173 PWMH] PWM Output Instruction (Control Code Specification) .....	9-5
<b>10 High-speed Counter Function .....</b>	<b>10-1</b>
10.1 Overview of High-speed Counter Function.....	10-2
10.1.1 Overview of High-speed Counter Function .....	10-2
10.1.2 Counting Range and Elapsed Value (Current Value) Area .....	10-2
10.1.3 Areas Used For High-speed Counter Function.....	10-3
10.1.4 Input Mode Type .....	10-4
10.1.5 Minimum Input Pulse Width .....	10-5
10.2 System Register Settings.....	10-7
10.2.1 System Register Settings.....	10-7
10.3 High-speed Counter Instruction .....	10-9
10.3.1 [F0 MV] High-speed Counter Control Instruction .....	10-9
10.3.2 F1 DMV (Pulse Output Elapsed Value Write/Read).....	10-10
10.3.3 [F166 HC1S] High-speed Counter Target Value Match ON Instruction [F167 HC1R] High-speed Counter Target Value Match OFF Instruction .....	10-11
10.3.4 Sample Program (Positioning Operation With Inverter: First Speed) .....	10-13

10.3.5	Sample Program (Positioning Operation With Inverter: Second Speed) .....	10-15
10.4	High-speed Counter Cam Control Instruction .....	10-18
10.4.1	[F165 CAM0] High-speed Counter Cam Control Instruction .....	10-18
10.4.2	Sample Program (Upper Limit Control, Reset, Addition) .....	10-22
10.4.3	Sample Program (Upper Limit Control, Instruction Clear, Addition).....	10-24
10.4.4	Sample Program (Upper Limit Control, Subtraction) .....	10-26
10.5	Interrupt Program Activation .....	10-29
10.5.1	Overview of Function .....	10-29
10.5.2	Interrupt Activation When F165 (CAM0) is Executed .....	10-29
<b>11</b>	<b>FPsigma Mode .....</b>	<b>11-1</b>
11.1	Overview of FPsigma Mode .....	11-2
11.2	Converting Projects for FPsigma to Projects for FP0H (FPsigma Mode).....	11-4
11.3	Converting Projects for FP0H (FPsigma Mode) to Projects for FP0H (FP0H Mode) .....	11-5
11.4	Differences in Positioning Instructions with FPsigma.....	11-6
11.4.1	High-speed Counter/Pulse Output Control Instruction F0(MV) .....	11-6
11.4.2	High-speed Counter Instructions F165 (CAM0), F166 (HC1S), F167 (HC1R).....	11-7
11.4.3	Pulse/PWM Output Control Instructions.....	11-8
<b>12</b>	<b>Specifications.....</b>	<b>12-1</b>
12.1	Specifications.....	12-2
12.1.1	General Specifications .....	12-2
12.1.2	Performance Specifications .....	12-2
12.2	Allocation of Memory Areas .....	12-4
12.2.1	When Using Pulse Output Table Setting Mode .....	12-4
12.2.2	When Using Pulse Output Function (FPsigma Compatible Instruction Mode) .....	12-5
12.2.3	When Using PWM Output Function .....	12-6
12.2.4	When Using High-speed Counter Function .....	12-7
12.3	Positioning Memory .....	12-9
12.3.1	Configuration of Memory Map.....	12-9
12.3.2	Common area (Memory Area No. 0).....	12-10
12.3.3	Axis Information Area (Memory Area No. 1) .....	12-11
12.3.4	Axis Setting Area (Memory Area No. 2).....	12-12
12.3.5	Positioning Table Area (Memory Area No. 3).....	12-14



# 1 Functions of Unit and Restrictions on Combination

---

1.1 Functions of Unit.....	1-2
1.1.1 Overview of FP0H Positioning Function .....	1-2
1.1.2 Compatibility Function with FPsigma .....	1-3
1.2 Restrictions on Combinations and Functions .....	1-4
1.2.1 Applicable Versions of Unit and Software .....	1-4
1.2.2 Restrictions on I/O Allocation.....	1-4
1.3 Comparison of Pulse Output Function .....	1-6
1.3.1 Types of Positioning Control Modes .....	1-6
1.3.2 Selection of Positioning Control Mode .....	1-6
1.3.3 Comparison of Two Control Modes.....	1-7

## 1.1 Functions of Unit

### 1.1 Functions of Unit

#### 1.1.1 Overview of FP0H Positioning Function

■ **Up to 4-axis position control is available by combining with a driver of pulse string input type.**

- The pulse output can be performed up to 100 kHz, and servo motors can be controller.
- It is also available for a stepping motor connected by open collector output.

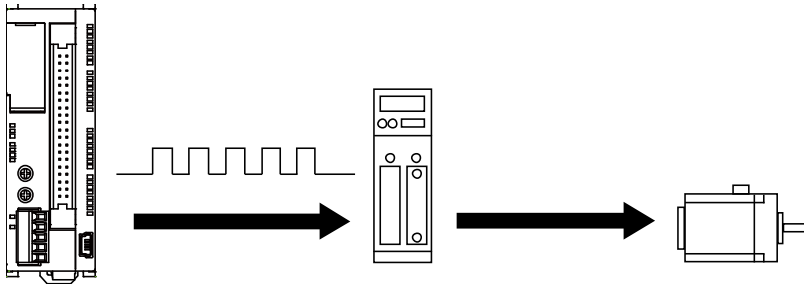

■ **Programs can be simplified by adopting the table setting mode.**

- The dedicated software "Configurator PMX" is available, which allows ease of setting a variety of parameters and positioning tables required for positioning control. "Configurator PMX" is started from the "Options" menu of tool software "FPWIN GR7".
- In user programs, positioning control is executed only by specifying axis numbers (channel numbers) and table numbers, and executing instructions.

The screenshot shows the Configurator PMX software window. The main area displays a table with the following data:

Table number	Operation p...	Control method	X axis (CH0)	Accelerati...	Acceleration ..	Deceleration ..	Target ...	Dwell time (ms)
1	E End point	I Increment	0	L Linear	100	100	1000	0
2	E End point	I Increment	0	L Linear	100	100	1000	0
3	E End point	I Increment	0	L Linear	100	100	1000	0
4	E End point	I Increment	0	L Linear	100	100	1000	0
5	E End point	I Increment	0	L Linear	100	100	1000	0

■ **Four kinds of position control patterns (Table setting mode)**

- Four patterns, which are E-point control (first speed automatic trapezoidal acceleration/ deceleration), P-point control (second speed automatic trapezoidal acceleration/ deceleration), C-point control (continuance point control) and J-point control (from speed control to position control), can be selected. They are created as tables on "Configurator PMX".

■ **Five kinds of home return operations are supported. (Table setting mode)**

- Five kinds of home return methods including home search are available. The most appropriate home return method can be selected in accordance with the system such as home input, near home input and the type of driver.

### 1.1.2 Compatibility Function with FPsigma

"FP0H mode" or "FPsigma mode" can be selected to retain compatibility with FPsigma. Usable functions and performances vary according to each mode.

Each mode is selected in the system register no. 3 by the tool software.

#### ■ Comparison of functions and performances

Item		Specifications	
		FP0H mode (Default)	FPsigma mode
High-speed counter	Single-phase	Max. 4 channels (CH0-3) Max. 100 kHz×4	Max. 4 channels (CH0-3) Max. 100 kHz×4
	2-phase	Max. 2 channels (CH0, CH2) Max. 50kHz×2	Max. 2 channels (CH0, CH2) Max. 50kHz×2
	I/O allocation	Independent from pulse/PWM output.	Shared with pulse/PWM output.
Pulse output	Independent	Max. 4 channels (CH0-3) Max. 100 kHz	Max. 2 channels (CH0, CH2), Max. 100 kHz
	Interpolation	Max. 2 channels (CH0, CH2) Max. 100 kHz (Composite speed)	Max. 1 channel (CH0) Max. 100 kHz (Composite speed)
	I/O allocation	Independent from high-speed counter input.	Shared with high-speed counter input.
PWM output		Max. 4 points (CH0-3)	Max. 2 points (CH0, CH2)
	I/O allocation	Independent from high-speed counter input.	Shared with high-speed counter input.
Pulse output function		Table setting mode FPsigma compatible instruction mode	FPsigma compatible instruction mode
Explanation of each mode		Default setting for FP0H project. There is no restriction on each function.	Automatically selected when executing "Convert PLC Type" from FP sigma program.  The above functions and I/O allocation are same as those of FPsigma.

(Note 1) Functions, channel numbers and I/O numbers used are set in the tool software.

(Note 2) I/O numbers used for each function should be allocated so that they do not overlap.

#### **i** Info.

- For details of the FPsigma mode, refer to "11 FPsigma Mode".

## 1.2 Restrictions on Combinations and Functions

### 1.2 Restrictions on Combinations and Functions

#### 1.2.1 Applicable Versions of Unit and Software

For using FP0H, the software of the following versions is necessary.

Item	Applicable versions
Programming Software Control FPWIN GR7	FPWIN GR7 Ver.2.19 or later
Configurator PMX	It is used for using the pulse output function in the table setting mode. It is implemented in FPWIN GR7/Pro7 and activated from the option menu.
Programming Software Control FPWIN Pro7	FPWIN PRO7 Ver.7.2.0 or later

(Note 1) The latest version is provided free of charge at our website(<https://industry.panasonic.com/global/en/downloads/?tab=software>). Use the latest version.

#### 1.2.2 Restrictions on I/O Allocation

- I/O signals used for each function are set in the tool software. They are allocated automatically when set by Configurator PMX.
- Allocate the I/O numbers used for the pulse output function, high-speed counter function and PWM function so that they do not overlap.

##### ■ Examples of unusable combinations

Example	When using the output Y0 as CH0 for the pulse output function, the PWM output CH0 cannot be used.
---------	---

##### ■ Input signals of Control Unit

I/O no.	Pulse output function	High-speed counter function		
		Count input		Reset input
		Single-phase	2-phase	
X0:	CH0 J-point positioning start input	CH0 Count input	CH0 Count input	-
X1	CH1 J-point positioning start input	CH1 Count input		-
X2	CH0 Home input	-	-	CH0, CH1 Reset input
X3	CH2 J-point positioning start input	CH2 Count input	CH2 Count input	-
X4	CH3 J-point positioning start input	CH3 Count input		-
X5	CH1 Home input	-	-	CH2, CH3 Reset input
X6	CH2 Home input	-	-	-
X7	CH3 Home input	-	-	-

## 1.2 Restrictions on Combinations and Functions

(Note 1) When the reset input settings of reset input for the single-phase input overlap at CH0 and CH1 or CH2 and CH3, the setting of CH1 or CH3 has priority.

### ■ Output signals of Control Unit

I/O no.	Pulse output function		PWM output
	Pulse output	Deviation counter clear	
Y0	CH0 CW or pulse output	-	CH0
Y1	CH0 CCW or sign output	-	(Note 1)
Y2	-	CH0	-
Y3	CH1 CW or pulse output	-	CH1
Y4	CH1 CCW or sign output	-	(Note 1)
Y5	-	CH1	-
Y6	-	-	-
Y7	-	-	-
Y8	CH2 CW or pulse output	-	CH2
Y9	CH2 CCW or sign output	-	(Note 1)
YA	-	CH2	-
YB	CH3 CW or pulse output	-	CH3
YC	CH3 CCW or sign output	-	(Note 1)
YD	-	CH3	-
YE	-	-	-
YF	-	-	-

(Note 1) When using the PWM output, the output numbers to be paired are normal output.

(Note 2) When using the target value match ON instruction (F166) or target value match OFF instruction (F167) in the high-speed counter function, arbitrary output is specified in the range of Y0 to Y1F in a user program so that it does not overlap the above functions.

## 1.3 Comparison of Pulse Output Function

### 1.3 Comparison of Pulse Output Function

#### 1.3.1 Types of Positioning Control Modes

For using the FP0H pulse output function, the following two control modes are available.

##### ■ Table setting mode

- Positioning parameters such as position command and speed command are created as data tables by tool software Configurator PMX in advance.
- As parameters are set in advance, programs can be simplified.
- Four patterns of position control modes and five patterns of home return modes are available.
- Dedicated instructions F380 to F385 are used for the control.
- Set positioning parameters and information on positioning tables can be exported as a setup file of Configurator PMX and reused between multiple units and projects.
- This function can be selected only in the FP0H mode.

##### ■ FPsigma compatible instruction mode

- Positioning parameters such as position command and speed command are set as operands of instructions.
- Dedicated instructions F171 to F175 and instructions F0 to F1 are used for the control.
- This method is similar to the pulse output function of the existing model FPsigma.
- This function can be selected in both the FP0H mode and FPsigma mode.

#### 1.3.2 Selection of Positioning Control Mode

- The positioning control mode is selected in the system register no. 407 by the tool software.

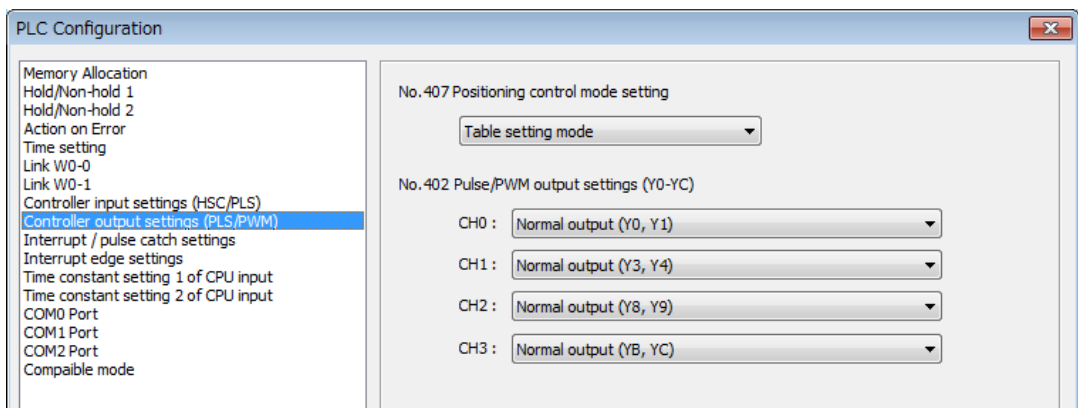

### 1.3.3 Comparison of Two Control Modes

There are following differences between the table setting mode and FPsigma compatible instruction mode.

#### ■ Comparison of Two Control modes

Item		Table setting mode	FPsigma compatible instruction mode
Stop control	Type	Four patterns (System stop, Emergency stop, Limit stop, and Deceleration stop)	Emergency stop only
	Start	Turns on the output contact allocated to each axis for each stop method.	Turns on the bit 3 of the special data register DT90052 using F0 instruction in a user program.
JOG operation	Set	Set in the positioning parameters of Configurator PMX.	Set using the operands of instructions.
	Start	F381 instruction	F172 instruction
Home return	Type	Five patterns (DOG methods x 3, Home position method x 1, Data set method x 1)	Two patterns (DOG methods x 1, Home position method x 1)
	Set	Set in the positioning parameters of Configurator PMX.	Set using the operands of instructions.
	Start	F382 instruction	F171 instruction
Positioning operation	Type	Four patterns (E-point control, P-point control, C-point control and J-point control)	E-point control (First speed acceleration/ deceleration), Multistep acceleration/ deceleration control
	Set	Set in the positioning data table of Configurator PMX.	Set using the operands of instructions.
	Start	F380 instruction	F171 instruction
Positioning operation interpolation	Type	Three patterns (E-point control, P-point control, C-point control)	E-point control (First speed acceleration/ deceleration)
	Set	Set in the positioning data table of Configurator PMX.	Set using the operands of instructions.
	Start	F380 instruction	F175 instruction
Others		Dwell time setting, Repeat control (Positioning parameter setting) Multiple table simultaneous start (F383 instruction)	Data table control (F174 instruction)

#### ■ Comparison in programming

Item		Table setting mode	FPsigma compatible instruction mode		
Read/Write of elapsed value	Area	Positioning memory	Special data registers		
			FP0H mode	CH0	DT90348 to DT90349
				CH1	DT90352 to DT90353
				CH2	DT90356 to DT90357

## 1.3 Comparison of Pulse Output Function

Item		Table setting mode	FPsigma compatible instruction mode	
				CH3 DT90360 to DT90361
			FPsigma mode	CH0 DT90044 to DT90045
				CH2 DT90200 to DT90201
Execute	F384 instruction (Read), F385 instruction (Write)	F1 instruction (Both Read and Write)		
Confirmation of BUSY state	Input contacts X808 to X80B	Special relays		
		FP0H mode	R911C to R911F	
		FPsigma mode	R903A, R903C	
Confirmation of positioning completion	Input contacts X810 to X813	Instead detects the fall of the above BUSY signal by a user program.		
Confirmation of home return completion	Input contacts X828 to X82B			
Near home input	Allocate arbitrary input contacts and turn on the outputs Y850 to Y853 by user programs.	Allocate arbitrary input contacts and turn on the bit 4 of the special data register DT90052 by user programs.		



## 2 Wiring

---

2.1 Connections with Servo Motor Amplifier .....	2-2
2.1.1 Connection Example .....	2-2
2.1.2 Precautions on Connection .....	2-3
2.2 Connection with Stepping Motor Driver .....	2-4
2.2.1 Precautions on Connection .....	2-4

## 2.1 Connections with Servo Motor Amplifier

### 2.1 Connections with Servo Motor Amplifier

#### 2.1.1 Connection Example

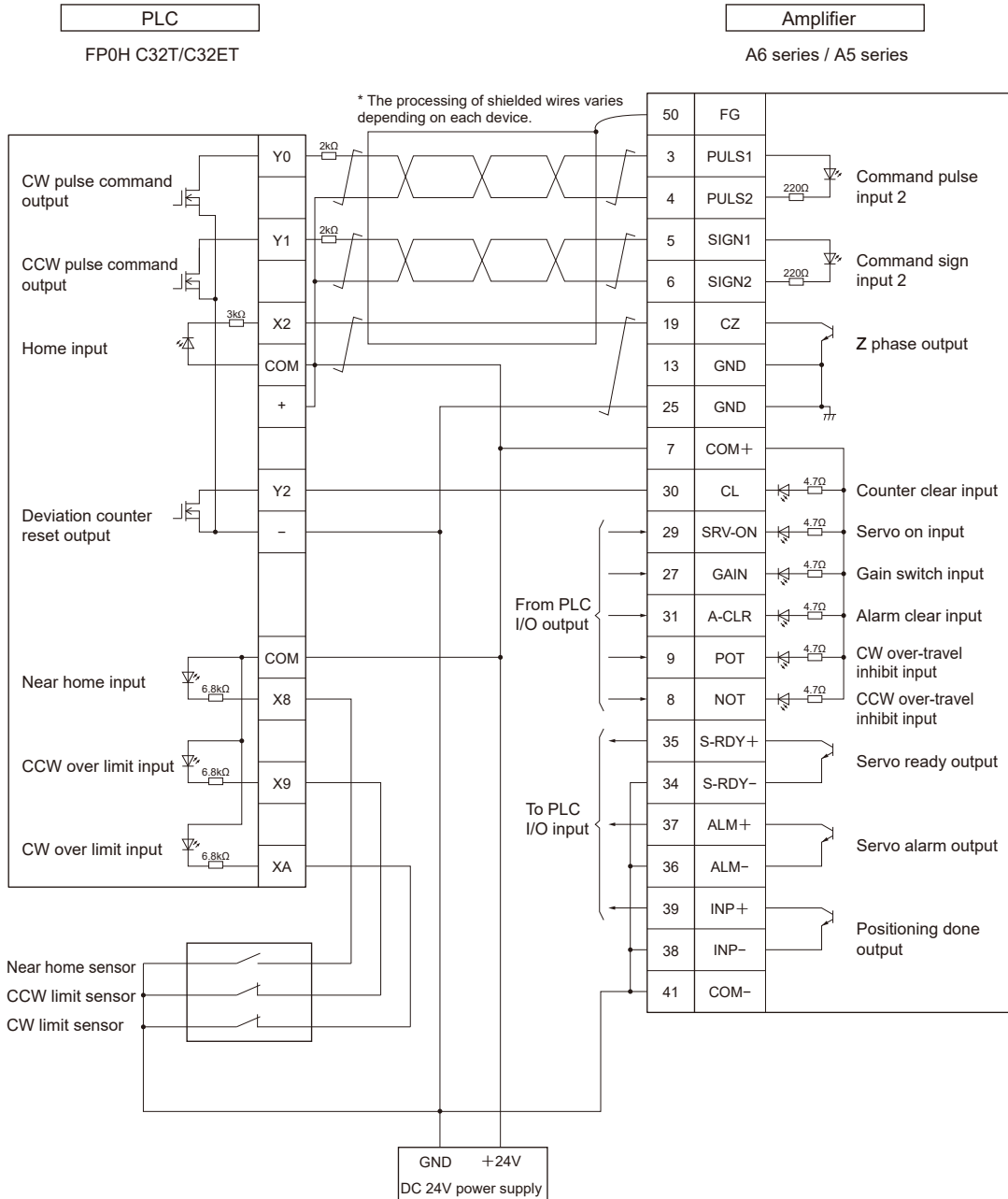

(Note 1) The allocation of I/O numbers on the controller side depends on channel numbers.

### 2.1.2 Precautions on Connection

#### ■ Connections of various signals

Signal type	Point
Pulse command output	<ul style="list-style-type: none"> <li>• Connect the output allocated to each channel and the command pulse input of servo amplifier.</li> <li>• Connect a resistor (2 kΩ) for limiting currents.</li> <li>• Use twisted-pair cables for the connection.</li> </ul>
Home input	<ul style="list-style-type: none"> <li>• Connect the input allocated to each channel and the Z phase input of servo amplifier.</li> <li>• Use twisted-pair cables for the connection.</li> </ul>
Near home input	<ul style="list-style-type: none"> <li>• Connect the near home sensor to an arbitrary input.</li> <li>• It will be valid when the outputs (Y850 to Y853) allocated to each channel in user programs turn ON.</li> </ul>
CCW over limit input	<ul style="list-style-type: none"> <li>• Connect the over limit switches to arbitrary inputs.</li> <li>• It will be valid when the outputs (Y860 to Y867) allocated to each channel in user programs turn ON.</li> </ul>
CW over limit input	
Deviation counter clear output	<ul style="list-style-type: none"> <li>• Connect the output allocated to each channel and the counter clear input of servo amplifier.</li> <li>• The length of a deviation counter clear signal is specified in the range of 1 to 100 ms in the "Parameter setting" dialog box of Configurator PMX.</li> </ul>
Servo on output	<ul style="list-style-type: none"> <li>• Connect an arbitrary output of PLC to the servo on input of servo amplifier.</li> </ul>

#### **i** Info.

- Use twisted-pair cables for the connection between the unit and servo amplifiers.

## 2.2 Connection with Stepping Motor Driver

### 2.2 Connection with Stepping Motor Driver

#### 2.2.1 Precautions on Connection

##### ■ Connections of various signals

Signal type	Point
Pulse command output	<ul style="list-style-type: none"><li>• Connect the output allocated to each channel and the command pulse input of motor driver.</li><li>• Use twisted-pair cables for the connection.</li><li>• Use a 24 V DC input for the input on the driver side. When the input interface of the driver is 5 V DC input, insert a resistor for limiting currents externally.</li></ul>
Home input	<ul style="list-style-type: none"><li>• Connect the input allocated to each channel and the home sensor.</li><li>• Use twisted-pair cables for the connection.</li></ul>
Near home input	<ul style="list-style-type: none"><li>• Connect the near home sensor to an arbitrary input.</li><li>• It will be valid when the outputs (Y850 to Y853) allocated to each channel in user programs turn ON.</li></ul>
CCW over limit input	<ul style="list-style-type: none"><li>• Connect the over limit switches to arbitrary inputs.</li><li>• It will be valid when the outputs (Y860 to Y867) allocated to each channel in user programs turn ON.</li></ul>
CW over limit input	

##### Info.

- Use twisted-pair cables for the connection between the unit and motor driver.

# 3 Power ON and OFF, and Items to Check

---

3.1 Safety Circuit Design .....	3-2
3.2 Before Turning On the Power .....	3-3
3.3 Procedure for Turning On the Power .....	3-4
3.3.1 Procedure for Turning On the Power .....	3-4
3.3.2 Procedure for Turning Off the Power .....	3-4
3.4 Confirming while the Power is ON .....	3-5
3.4.1 Items to check after turning on the power .....	3-5
3.4.2 Checking the Installation of the External Safety Circuit .....	3-6
3.4.3 Checking the Safety Circuit Based on the Unit .....	3-6
3.4.4 Checking the Operation of the Near Home Switch and Home Switch .....	3-6
3.4.5 Checking Rotating and Moving Directions and Moving Distance ....	3-7

**3.1 Safety Circuit Design**

■ **System configuration example**

Installation of the over limit switch

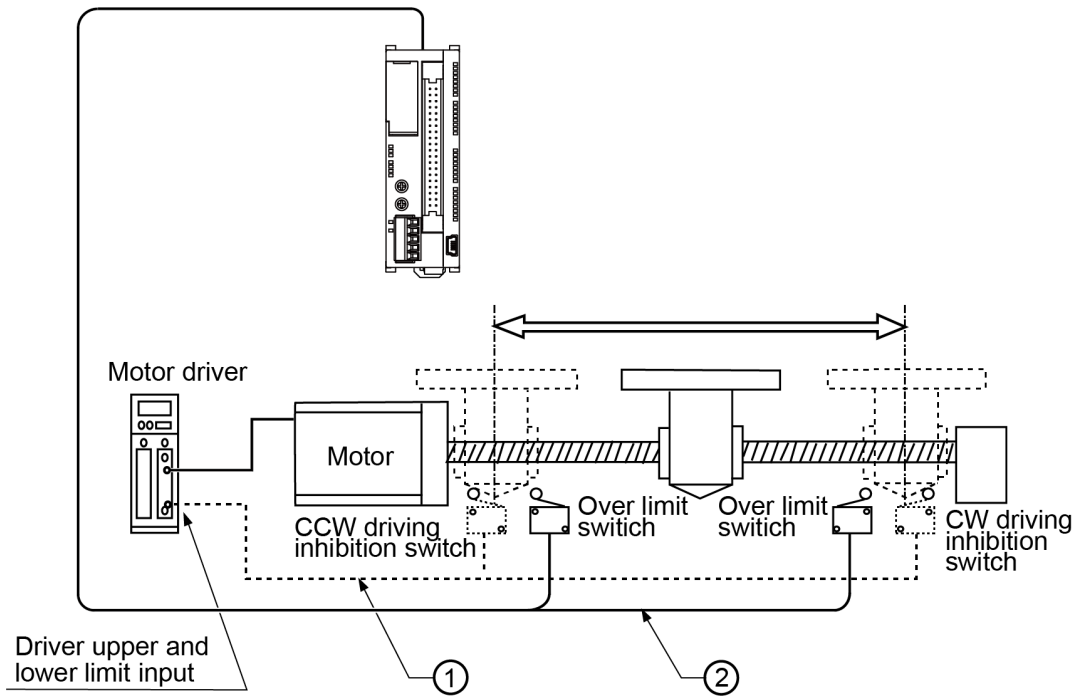

■ **Confirmation of safety circuit**

Number	Item	Description
(1)	Safety circuit based on external circuit	Install the safety circuit recommended by the manufacturer of the motor being used.
(2)	Safety circuit based on the unit	Install over limit switches as shown above. Connect the over limit switches on the (+) and (-) sides to the input circuit of PLC.

## 3.2 Before Turning On the Power

### ■ System configuration example

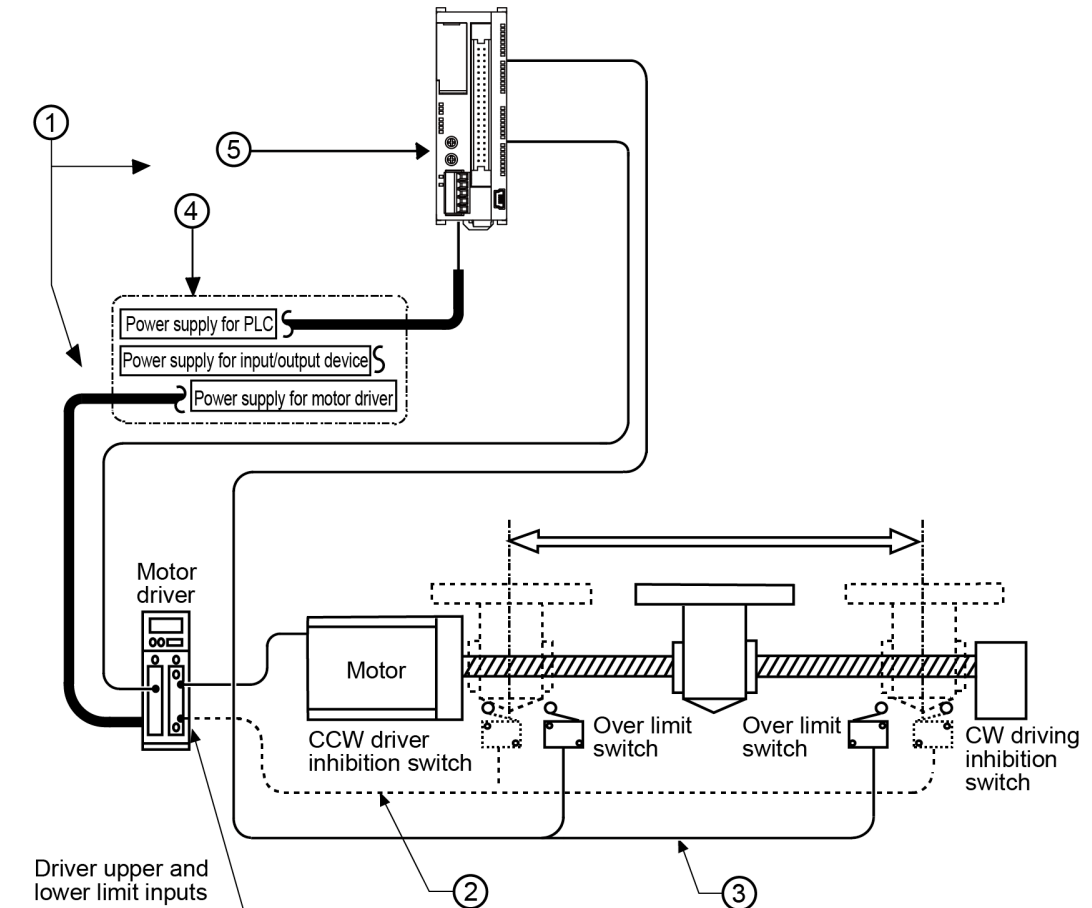

### ■ Items to check before turning on the power

Number	Item	Description
(1)	Checking connections to the various devices	Check to make sure the various devices have been connected as indicated by the design.
(2)	Checking the installation of the external safety circuit	Check to make sure the safety circuit (wiring and installation of over limit switch) based on an external circuit has been installed securely.
(3)	Checking the installation of the safety circuit based on the unit	Check the connection between the unit and over limit switches. Check the installation condition of the over limit switches.
(4)	Checking the procedure settings for turning ON the power supplies	Make sure settings have been entered so that power supplies will be turned on according to the procedure outlined in section "Procedure for Turning On the Power".
(5)	Checking the CPU mode selection switch	Set the CPU unit to PROG. mode. Setting it in the RUN mode can cause inadvertent operation.

## 3.3 Procedure for Turning On the Power

---

### 3.3 Procedure for Turning On the Power

#### 3.3.1 Procedure for Turning On the Power

When turning on the power to the system incorporating the unit, consider the nature and states of any external devices connected to the system, and take sufficient care so that turning on the power will not initiate unexpected movements.

#### **1 2** Procedure

1. Turn on the power supplies for the input and output devices connected to the PLC.
2. Turn ON the power supply for the PLC.
3. Turn ON the power supply for the motor driver.

#### 3.3.2 Procedure for Turning Off the Power

#### **1 2** Procedure

1. Check to make sure the rotation of the motor has stopped, and then turn OFF the power supply for the motor driver.
2. Turn off the power supply for the PLC.
3. Turn off the power supplies for the input and output devices connected to the PLC.



## 3.4 Confirming while the Power is ON

### 3.4.1 Items to check after turning on the power

#### ■ System configuration example

Check each item in the following four major steps.

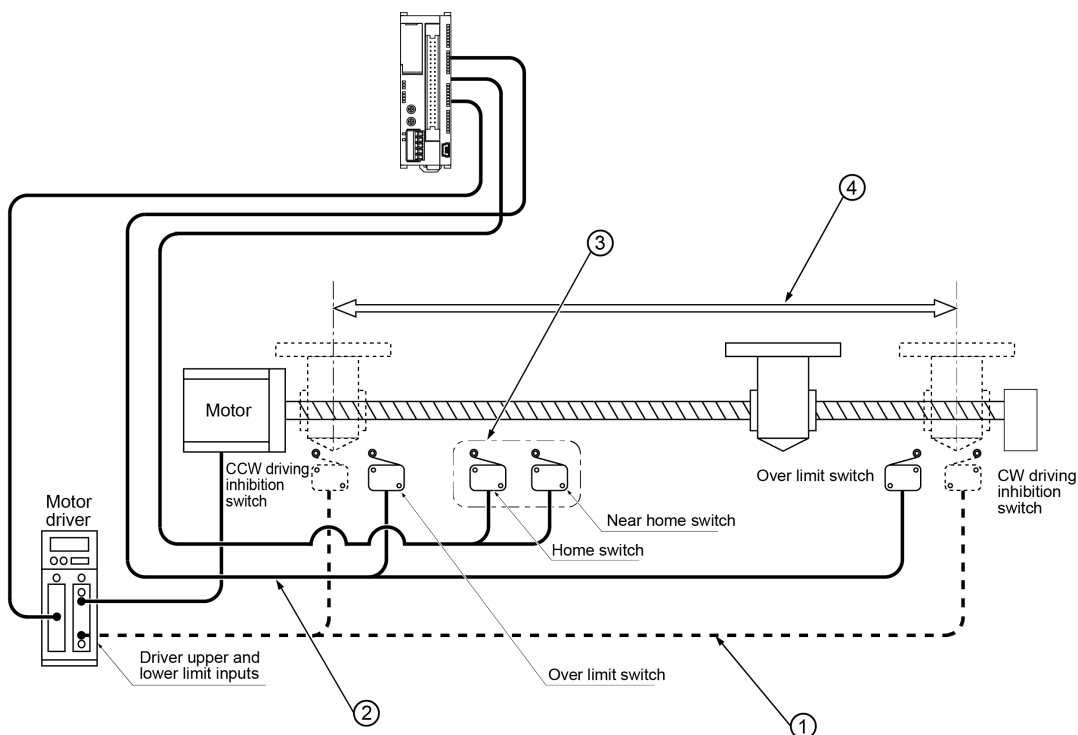

#### ■ Items to check before turning on the power

Number	Item	Description
(1)	Checking the installation of the external safety circuit	Check to make sure the safety circuit (wiring and installation of over limit switch) based on an external circuit has been installed securely.
(2)	Checking the safety circuit by the PLC unit	Check the connection between the unit and over limit switches. Check the installation condition of the over limit switches.
(3)	Checking the near home input and home input	Check if the near home input and home are loaded as the inputs of the PLC and activated properly by performing JOG operation or home return operation.
(4)	Checking the rotation, moving direction, and moving distance.	Check the rotation, moving direction and moving distance by performing JOG operation or positioning operation.

## 3.4 Confirming while the Power is ON

### 3.4.2 Checking the Installation of the External Safety Circuit

Make a check on the safety circuit recommended by the motor manufacturer, which includes a check on the disconnection of the power supply to the motor driver with CW and CCW drive inhibition switch input from an external circuit.

### 3.4.3 Checking the Safety Circuit Based on the Unit

#### 1 2 Procedure

1. Using forced operation of the over limit switch, check to see if the over limit input is being properly taken into the PLC side.
2. If necessary, input a program to start the JOG operation. Then operate the over limit input to check whether the motor will stop. The limit stop will be effective when output signals (Y860 to Y867) allocated to each axis turn ON in user programs. The valid logic of limit input can be changed in the parameter setting menu of "Configurator PMX".
3. Using the JOG operation, check to see if the over limit switch is functioning properly.

#### Operation at limit input

Conditions	Direction	Limit status	Operation
When JOG operation is started	Forward	Over limit input (+): ON	Not executable, Error occurs.
		Over limit input (-): ON	Executable
	Reverse	Over limit input (+): ON	Executable
		Over limit input (-): ON	Not executable, Error occurs.
During JOG operation	Forward	Over limit input (+): ON	Limit stops, Error occurs.
		Over limit input (-): ON	Limit stops, Error occurs.
	Reverse	Over limit input (+): ON	Limit stops, Error occurs.
		Over limit input (-): ON	Limit stops, Error occurs.

### 3.4.4 Checking the Operation of the Near Home Switch and Home Switch

#### 1 2 Procedure

1. Check if the near home input is loaded as input signals on the PLC properly by operating the home input and near home input forcibly.
2. Start the home return by inputting the home return program, and check if the operation transits to the deceleration operation by the near home input.

#### Points to check

Set the valid logic which enables the home input and near home input in the parameter setting menu of "Configurator PMX".

3. Check if the home stop position shifts by repeating the JOG and home return operations.

**Points to check**

A shift may result depending on the position of near home input or home input and the return speed.

4. If the home stopping position is shifted, change the position of near home input or reduce the home return speed.

### 3.4.5 Checking Rotating and Moving Directions and Moving Distance

#### 1 2 Procedure

1. Execute the JOG operation to confirm the rotating direction and moving direction of the motor.

**Points to check**

The rotating direction is determined according to the installation of the ball screw or the "CW/CCW direction setting" of the parameter.

2. Check if the moving distance is that as designed by performing the JOG operation or positioning operation.

**Points to check**

The moving distance is determined according to the pitch of the ball screw, deceleration gear ratio or setting movement amount of the positioning data.

(MEMO)

# 4 Settings of Control Unit

---

4.1	Confirming I/O Allocation .....	4-2
4.1.1	When Using Pulse Output Table Setting Mode .....	4-2
4.1.2	When Using Pulse Output Function (FPsigma Compatible Instruction Mode) .....	4-3
4.1.3	When Using PWM Output Function .....	4-5
4.1.4	When Using High-speed Counter Function .....	4-6
4.2	Settings in Configurator PMX.....	4-8
4.2.1	Allocating Channels to be Used .....	4-8
4.2.2	Setting Parameters .....	4-9
4.2.3	Creating Positioning Data Table.....	4-11
4.2.4	Saving Positioning Parameters .....	4-13
4.2.5	Export and Import .....	4-14
4.2.6	Check on Parameter Data .....	4-14
4.2.7	Writing Parameters to Unit (1).....	4-15
4.2.8	Writing Parameters to Unit (2).....	4-15
4.3	System Register Settings.....	4-17
4.3.1	Confirming and Selecting Functions to be Used .....	4-17
4.4	Reading Elapsed Values.....	4-19
4.4.1	Elapsed Value (Current Value) Area .....	4-19
4.4.2	Reading Elapsed Value (Current Value) Area .....	4-19

## 4.1 Confirming I/O Allocation

### 4.1 Confirming I/O Allocation

#### 4.1.1 When Using Pulse Output Table Setting Mode

- The home input signal and positioning completion signal is allocated to I/O signals.
- The pulse output table setting mode can be used only in the FPOH mode.

##### ■ Allocation of I/O signals (Input)

Signal name	I/O number			
	Axis 1	Axis 2	Axis 3	Axis 4
	CH0	CH1	CH2	CH3
J-point control positioning start input	X0	X1	X3	X4
Home input (Note 1)	X2	X5	X6	X7
Near home input (Note 1)(Note 2)	(Y850)	(Y851)	(Y852)	(Y853)
Over limit input (+) (Note 2)	(Y860)	(Y862)	(Y864)	(Y866)
Over limit input (-) (Note 2)	(Y861)	(Y863)	(Y865)	(Y867)
BUSY	X808	X809	X80A	X80B
Operation done	X810	X811	X812	X813
Home return done	X828	X829	X82A	X82B

(Note 1) Even when setting the linear interpolation, the interpolation operation is not performed for the home return. Execute the operation for X axes and Y axes separately.

(Note 2) The near home input, over limit input (+) and over limit input (-) will be valid when an arbitrary input is allocated and the output relay indicated in the above table turns ON.

##### ■ Sample program

The following sample shows the program when the near home input, over limit input (+) and over limit input (-) are allocated to XA to XC.

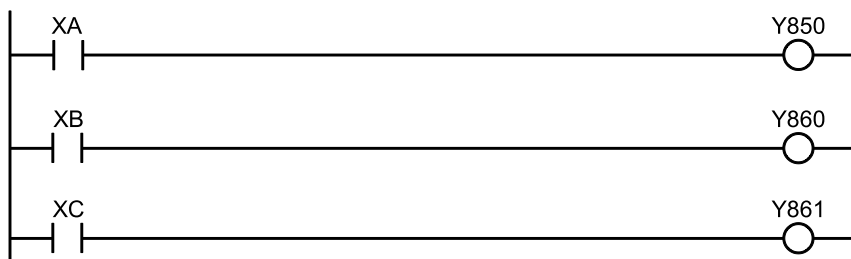

##### **i** Info.

- When selecting the table setting mode, the control active flags (R911C to R911F) are not activated. Confirm that other instructions for the table setting mode (F380 to F383) are not activated using the above BUSY flags (X808 to X80B), and execute each instruction.

### ■ Allocation of I/O signals (Output)

Signal name	I/O number			
	Axis 1	Axis 2	Axis 3	Axis 4
	CH0	CH1	CH2	CH3
CW output or Pulse output	Y0	Y3	Y8	YB
CCW output or Sign output	Y1	Y4	Y9	YC
Deviation counter clear output	Y2	Y5	YA	YD
System stop	Y800			
Error clear request	Y801			
Warning clear request	Y802			
Emergency stop	Y830	Y831	Y832	Y833
Deceleration stop	Y838	Y839	Y83A	Y83B
J-point control speed change	Y840	Y841	Y842	Y843
Near home input <small>(Note 1)</small>	(Y850)	(Y851)	(Y852)	(Y853)
Over limit input (+) <small>(Note 1)</small>	(Y860)	(Y862)	(Y864)	(Y866)
Over limit input (-) <small>(Note 1)</small>	(Y861)	(Y863)	(Y865)	(Y867)

(Note 1) The near home input, over limit input (+) and over limit input (-) will be valid when an arbitrary input is allocated and the output relay indicated in the above table turns ON.

#### 4.1.2 When Using Pulse Output Function (FPsigma Compatible Instruction Mode)

- The following reserved areas are allocated to the home input and control active flag.
- Arbitrary inputs are allocated to the near home input and pulse output stop signal (emergency stop).

### ■ Allocation of I/O signals (Input)

#### FP0H mode

Signal name	I/O number			
	Axis 1	Axis 2	Axis 3	Axis 4
	CH0	CH1	CH2	CH3
Home input <small>(Note 1)</small>	X2	X5	X6	X7
Near home input	<small>(Note 2)</small>			
Control active flag (BUSY)	R911C	R911D	R911E	R911F
Operation done	<small>(Note 3)</small>			
Home return done				

## 4.1 Confirming I/O Allocation

### FPsigma mode

Signal name	I/O number	
	Axis 1	Axis 2
	CH0	CH2
Home input (Note 1)	X2	X5
Near home input	(Note 2)	
Control active flag (BUSY)	903A	903C
Operation done	(Note 3)	
Home return done		

(Note 1) Even when setting the linear interpolation, the interpolation operation is not performed for the home return. Execute the operation for X axes and Y axes separately.

(Note 2) The near home input will be enabled by allocating an arbitrary input and turning on the bit 4 of the special data register DT90052 by the pulse output control instruction (F0).

(Note 3) The falling edge (on to off) of the control flag (BUSY) after the execution of the pulse output instruction (F171) is used in place of the operation done flag or home return done flag.

### ■ Allocation of I/O signals (Output)

#### FP0H mode

Signal name	I/O number			
	Axis 1	Axis 2	Axis 3	Axis 4
	CH0	CH1	CH2	CH3
CW output or Pulse output	Y0	Y3	Y8	YB
CCW output or Sign output	Y1	Y4	Y9	YC
Deviation counter clear output (Note 1)	Y2	Y5	YA	YD
Emergency stop (Pulse output stop)	(Note 2)			

#### FPsigma mode

Signal name	I/O number	
	Axis 1	Axis 2
	CH0	CH2
CW output or Pulse output	Y0	Y3
CCW output or Sign output	Y1	Y4
Deviation counter clear output (Note 1)	Y2	Y5
Emergency stop (Pulse output stop)	(Note 2)	

(Note 1) Even when setting the linear interpolation, the interpolation operation is not performed for the home return. Execute the operation for X axes and Y axes separately.

(Note 2) The emergency stop will be enabled by specifying channel numbers and turning on the bit 3 of the special data register DT90052 by the pulse output control instruction (F0). In case of the emergency stop in the FPsigma compatible instruction mode, pulses stop immediately.



■ **Allocation of I/O relating to pulse output control (Only in FPsigma compatible instruction mode)**

- By using the special data register DT90052 by the pulse output control instruction (F0), operations such as loading the near home input and stopping the pulse output forcibly can be performed.

FP0H mode

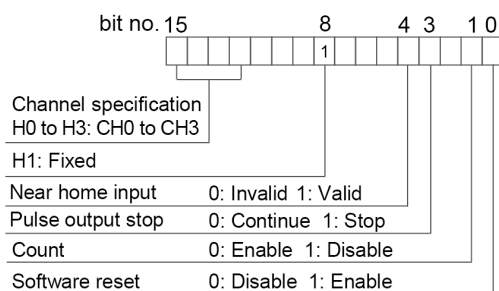

FPsigma mode

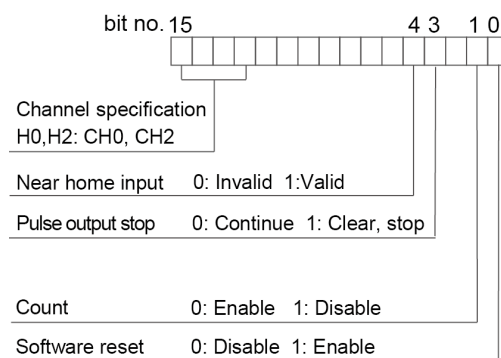

- When controlling the above functions using external inputs, arbitrary inputs can be allocated. The following program is for loading the near home input of CH1 using the input X10.

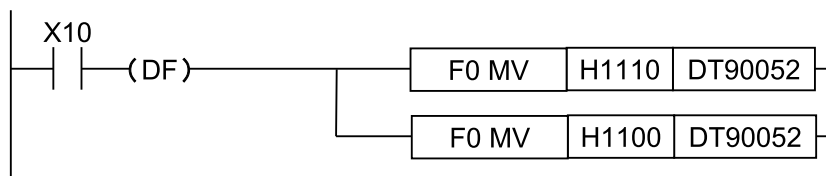

**i Info.**

- In the FPsigma compatible instruction mode, the allocations of J-point control and limit inputs are not available.
- In the FPsigma compatible instruction mode, the allocations of system stop, error clear request, deceleration stop and J-point speed change are not available.
- For details of the FPsigma mode, refer to "[11 FPsigma Mode](#)".

### 4.1.3 When Using PWM Output Function

- The following reserved areas are allocated to the PWM output and control active flag.
- Allocate them so that they do not overlap the I/O used for the pulse output function.

## 4.1 Confirming I/O Allocation

### ■ Allocation of I/O signals

#### FP0H mode

Signal name	I/O number			
	CH0	CH1	CH2	CH3
PWM output	Y0	Y3	Y8	YB
Control active flag (BUSY)	R911C	R911D	R911E	R911F

#### FPsigma mode

Signal name	I/O number	
	CH0	CH2
PWM output	Y0	Y3
Control active flag (BUSY)	R903A	R903C

#### Info.

- For details of the FPsigma mode, refer to "11 FPsigma Mode".

### 4.1.4 When Using High-speed Counter Function

- The following reserved areas are allocated to the hardware reset input and control active flag.

### ■ Allocation of I/O signals (When using internal input)

#### FP0H mode

Signal name		I/O number			
		CH0	CH1	CH2	CH3
Count input	Single-phase input	X0	X1	X3	X4
	2-phase input	X0/X1	-	X3/X4	-
Hardware reset input	Single-phase input	X2	X2	X5	X5
	2-phase input	X2	-	X5	-
Control active flag (BUSY)	Single-phase input	R9110	R9111	R9112	R9113
	2-phase input	R9110	-	R9112	-

#### FPsigma mode

Signal name		I/O number			
		CH0	CH1	CH2	CH3
Count input	Single-phase input	X0	X1	X3	X4

Signal name		I/O number			
		CH0	CH1	CH2	CH3
	2-phase input	X0/X1	-	X3/X4	-
Hardware reset input	Single-phase input	X2	X2	X5	X5
	2-phase input	X2	-	X5	-
Control active flag (BUSY)	Single-phase input	R903A	R903B	R903C	R903D
	2-phase input	R903A	-	R903C	-

(Note 1) When the reset input settings of reset input for the single-phase input overlap at CH0 and CH1 or CH2 and CH3, the setting of CH0 or CH2 has priority.

■ Allocation of I/O relating to High-speed counter control

- By using the special data register DT90052 by the high-speed counter control instruction (F0), operations such as the software reset of the high-speed counter and disabling/enabling the count can be performed.

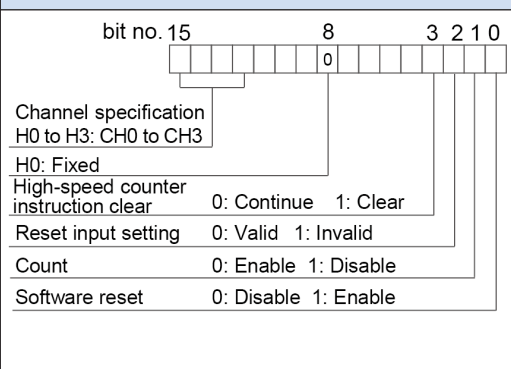
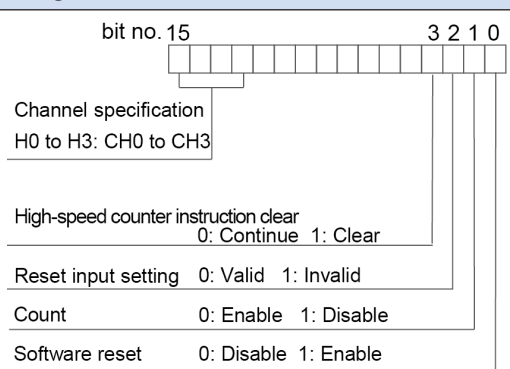
FP0H mode	FPsigma mode
<p>bit no. 15 8 3 2 1 0</p>  <p>Channel specification H0 to H3: CH0 to CH3</p> <p>H0: Fixed</p> <p>High-speed counter instruction clear 0: Continue 1: Clear</p> <p>Reset input setting 0: Valid 1: Invalid</p> <p>Count 0: Enable 1: Disable</p> <p>Software reset 0: Disable 1: Enable</p>	<p>bit no. 15 3 2 1 0</p>  <p>Channel specification H0 to H3: CH0 to CH3</p> <p>High-speed counter instruction clear 0: Continue 1: Clear</p> <p>Reset input setting 0: Valid 1: Invalid</p> <p>Count 0: Enable 1: Disable</p> <p>Software reset 0: Disable 1: Enable</p>

- When controlling the above functions using external inputs, arbitrary inputs can be allocated. The following program is for performing the software reset of CH0 using the input X7.

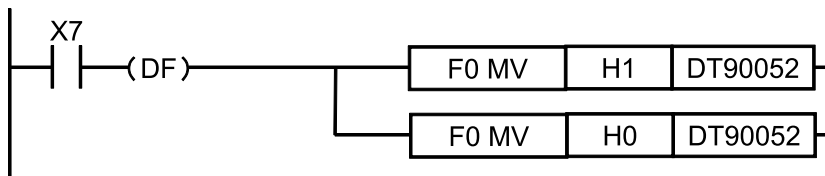

**i** Info.

- For details of the FPsigma mode, refer to "11 FPsigma Mode".

## 4.2 Settings in Configurator PMX

### 4.2 Settings in Configurator PMX

#### 4.2.1 Allocating Channels to be Used

Use the Configurator PMX to allocate used channels and applications. The following procedure is explained on the condition that the FPWIN GR7 has already started.

### 1 2 Procedure

1. Select **Options>Positioning Table Settings** from the menu bar.  
"Configurator PMX" will be activated.

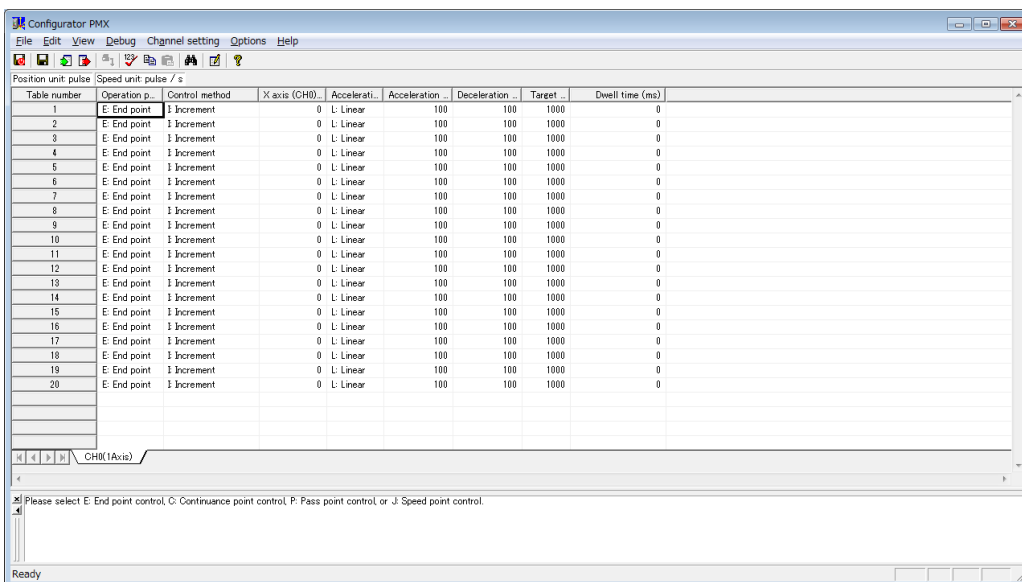

2. Select **Channel setting>Used channel setting** from the menu bar.  
The "Used channel setting" dialog box appears.

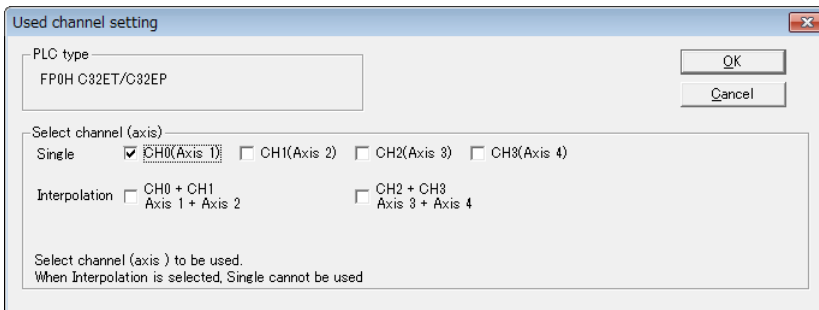

3. Select the axes to be used and the usage, and press the [Yes] button.  
When the setting is changed, a confirmation message box appears.

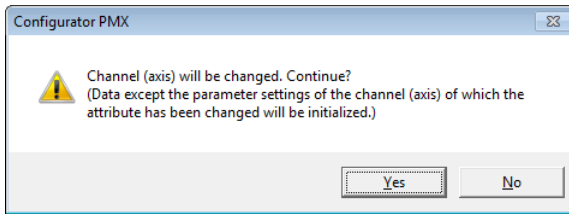

4. Confirm the change and press the [OK] button.  
A data table tab each is created for the groups set.

17	E: End point	I: Increment	0	L: Linear
18	E: End point	I: Increment	0	L: Linear

Navigation: << < > >>

CH0(1Axis) / CH1(2Axis) / CH2(3Axis)

### **i** Info.

- When interpolation control is selected, the data table of the channel numbers of X and Y axes will be added, and [Interpolation] will be displayed on the tab.

17	E: End point	0: Linear (composit...	I: Increment
18	E: End point	0: Linear (composit...	I: Increment

Navigation: << < > >>

[Interpolation]CH0,CH1(1,2Axis) / CH2(3Axis)

- When changing "Used channel setting" in Configurator PMX, the system registers no. 400 to 402 and 407 corresponding to the I/O used for the positioning control will be automatically updated. For details, refer to "[4.3 System Register Settings](#)".

### 4.2.2 Setting Parameters

Use the Configurator PMX to allocate the most fundamental parameters for positioning control, such as the motor rotation direction, pulse output method (CW/CCW and Pulse/Sign), home input, limit input logic, and positioning control. The following procedure is explained on the condition that the Configurator PMX has already started.

#### **1 2** Procedure

1. Select **Channel setting>Parameter settings** from the menu bar.  
The "Parameter settings" dialog box appears.

## 4.2 Settings in Configurator PMX

Parameter settings		Channel0 (1 axis)	Channel1 (2 axis)	Channel2 (3 axis)	Channel3 (4 axis)
Basic	Pulse output method	Pulse/Sign	Pulse/Sign	Pulse/Sign	Pulse/Sign
	Pulse output rotation direction	CW direction +	CW direction +	CW direction +	CW direction +
	Startup speed	100	100	100	100
	Positioning repeat count	0	0	0	0
Input	Home position logic	Normal Open	Normal Open	Normal Open	Normal Open
	Home position proximity logic	Normal Open	Normal Open	Normal Open	Normal Open
	Limit + switch logic	Normal Open	Normal Open	Normal Open	Normal Open
	Limit - switch logic	Normal Open	Normal Open	Normal Open	Normal Open
Home return	Home return method	Not use	Not use	Not use	Not use
	Home return direction	Limit (-) direction	Limit (-) direction	Limit (-) direction	Limit (-) direction
	Home return acceleration time (ms)	100	100	100	100
	Home return deceleration time (ms)	100	100	100	100
	Home return target speed	1000	1000	1000	1000
	Home return creep speed	100	100	100	100
	Deviation counter clear time (ms)	1	1	1	1
	Coordinate origin	0	0	0	0
JOG operation	JOG acceleration time (ms)	0	0	0	0
	JOG deceleration time (ms)	0	0	0	0
	JOG target speed	1000	1000	1000	1000
	J point change target speed	1000	1000	1000	1000
Stop	Emergency stop deceleration time (ms)	100	100	100	100
	Limit stop deceleration time (ms)	100	100	100	100

Set the output method for pulse output.  
Select from the followings.  
Pulse/Sign method, CW/CCW method

OK Cancel Channel copy Initialize

- Make necessary parameter settings according to the application and press the [OK] button. The settings will be stored as part of positioning parameter data.

### Parameters

Parameter name	Default (unit)	Settings
Basic	Pulse output method	Pulse/Sign
	Pulse output rotation direction	CW direction +
	Startup speed	100 (pps)
	Positioning repeat count	0
		Pulse/Sign, CW/CCW  When selecting Pulse/Sign mode: CW direction +: Select this setting for the case that the elapsed value is increased when Sign output turns off. CCW direction +: Select this setting for the case that the elapsed value is increased when Sign output turns on.  When selecting CW/CCW mode: CW direction +: Select this setting for the case that the elapsed value is increased at the time of CW output. CCW direction +: Select this setting for the case that the elapsed value is increased at the time of CCW output.  Set the startup speed common to each operation. This setting is common to JOG operation, home return, E-point control, P-point control, C-point control and J-point control. Setting range: 1 to 100,000  Specify this setting for performing repetitive controls when using E-point/P-point/C-point control.

Parameter name		Default (unit)	Settings
			0, 1: Not repeat 2 to 254: Repeat for the specified number of times. 255: Repeat infinitely until the execution of stop control.
Input	Home position logic	Normal Open	Select the input logic for each switch. Normal Open, Normal Close
	Home position proximity logic	Normal Open	
	Limit + switch logic	Normal Open	
	Limit - switch logic	Normal Open	
Home return	Home return method	Not use	DOG method 1, DOG method 2, DOG method 3, Home position method, Data set method, Not use
	Home return direction	Limit (-) direction	Limit (-) direction, Limit (+) direction
	Home return acceleration time	100 (ms)	Setting range: 1 to 10,000
	Home return deceleration time	100 (ms)	Setting range: 1 to 10,000
	Home return target speed	1000 (pps)	Setting range: 1 to 100,000
	Home return creep speed	100 (pps)	Setting range: 1 to 100,000
	Deviation counter clear time	1 (ms)	Setting range: 1 to 100
	Coordinate origin	0 (pulse)	When the home return method is Data set method, specify a coordinate origin. Setting range: -1,073,741,824 to 1,073,741,823 For the interpolation control, the range is as follows. Setting range: -8,388,608 to 8,388,607
JOG operation	JOG acceleration time	0 (ms)	Setting range: 0 to 10,000
	JOG deceleration time	0 (ms)	Setting range: 0 to 10,000
	JOG target speed	1000 (pps)	Setting range: 1 to 100,000
	J point change target speed	1000 (pps)	Set this setting for changing the speed during J-point control. Setting range: 1 to 100,000
Stop	Emergency stop deceleration time	100 (ms)	Setting range: 1 to 10,000
	Limit stop deceleration time	100 (ms)	Setting range: 1 to 10,000

### 4.2.3 Creating Positioning Data Table

- The positioning data tables are divided into sheets for each axis, and 20 tables ranging no. 1 to no. 20 can be set.

## 4.2 Settings in Configurator PMX

### ■ For independent axis control

Parameter name	Default (unit)	Description
Operation pattern	E: End point	Select one from the following operation patterns. E: End point, P: Pass point, C: Continuance point, J: Speed point
Control method	I: Increment	Select either. I: Increment or A: Absolute.
X-axis movement amount	0 (pulse)	Input a movement amount. Setting range: -1,073,741,824 to +1,073,741,823
Acceleration/ deceleration method	L: Linear	For FP0H, only L: Linear can be selected.
Acceleration time	100 (ms)	Set an acceleration time. Setting range: 1 to 10,000
Deceleration time	100 (ms)	Set a deceleration time. Setting range: 1 to 10,000
Target speed	1000 (pps)	Set a target speed. Setting range: 1 to 100,000
Dwell time	0 (ms)	Set the time from the completion of the positioning instruction in the E-point control until the positioning done flag turns ON. For the C-point control, it is the wait time between each table. Also, the dwell time setting is invalid for the P-point control.

### ■ For interpolation control

Parameter name	Default (unit)	Description
Operation pattern	E: End point	Select one from the following operation patterns. E: End point, P: Pass point, C: Continuance point
Interpolation operation	Linear (composite speed)	Select a specification method of speed. Linear (composite speed): Specify the speed combining the speed of X and Y axes. Linear (major axis speed): Specify the speed on the long axis side whose movement amount is large.
Control method	I: Increment	Select either. I: Increment or A: Absolute.
X-axis movement amount	0 (pulse)	Input a movement amount. Setting range: -8,388,608 to +8,388,607
Y-axis movement amount	0 (pulse)	Input a movement amount. Setting range: -8,388,608 to +8,388,607
Acceleration/ deceleration method	L: Linear	For FP0H, only L: Linear can be selected.
Acceleration time	100 (ms)	Set an acceleration time. Setting range: 1 to 10,000
Deceleration time	100 (ms)	Set a deceleration time. Setting range: 1 to 10,000



Parameter name	Default (unit)	Description
Interpolation speed	1000 (pps)	Set either composite speed or major axis speed in accordance with the selection of interpolation operation. Setting range: 1 to 100,000
Dwell time	0 (ms)	Set the time from the completion of the positioning instruction in the E-point control until the positioning done flag turns ON. For the C-point control, it is the wait time between each table. Also, the dwell time setting is invalid for the P-point control.

### ■ Selection of positioning operation patterns

- For the E-point control, enter settings in one row.
- For P-point control (speed change control), C-point control (continuance point control) and J-point control (JOG positioning control), they should be combined with E-point control of the next step as a pair and the settings should be input in two rows.

Table number	Operation p...	Control method	X axis (CH0)	Accelerati...	Acceleration ..	Deceleration ..	Target ..	Dwell time (ms)
1	E: End point	I: Increment	0	L: Linear	100	100	1000	0
2	E: End point	I: Increment	0	L: Linear	100	100	1000	0
3	E: End point	I: Increment	0	L: Linear	100	100	1000	0
4	E: End point	I: Increment	0	L: Linear	100	100	1000	0
5	E: End point	I: Increment	0	L: Linear	100	100	1000	0
6	E: End point	I: Increment	0	L: Linear	100	100	1000	0
7	E: End point	I: Increment	0	L: Linear	100	100	1000	0
8	E: End point	I: Increment	0	L: Linear	100	100	1000	0
9	E: End point	I: Increment	0	L: Linear	100	100	1000	0

### ■ Table numbers and activation of positioning

- Execute the positioning start instruction (F380) in the user program to specify table numbers in the Configurator PMX.
- The unit executes the control under the conditions set in the table by turning on the positioning start contact corresponding to a desired channel number (axis number) and table number. Specify the first data table number for each control in the program.

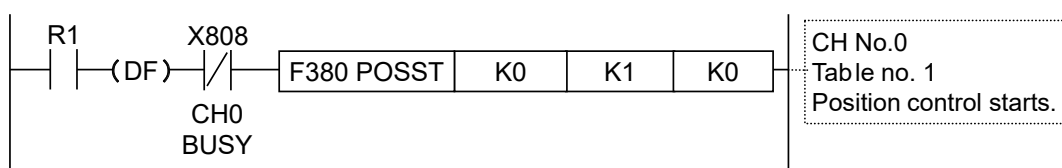

### **i** Info.

- For details, refer to "5 Operation Patterns". For details of instructions, refer to "7 Instruction References".

## 4.2.4 Saving Positioning Parameters

Information on positioning parameters and positioning data tables set on Configurator PMX is saved as part of program files.

## 4.2 Settings in Configurator PMX

---

### 1 2 Procedure

1. Select **File>Save changes and exit** from the menu bar.  
A confirmation message box appears.

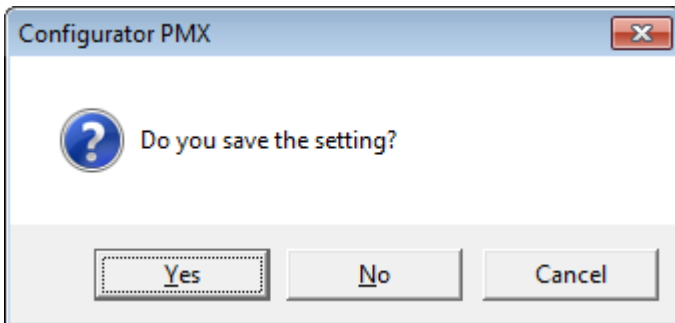

2. Press [Yes].
  - The set information will be saved as part of project files.
  - When selecting [No], the changes made immediately before will be discarded. When selecting [Cancel], it will return to the setting screen of Configurator PMX with the changes made immediately before still in place.

### 4.2.5 Export and Import

- Basic parameters and positioning parameters set can be exported to and imported from the Configurator PMX.
- Information on positioning parameters and positioning tables saved by using the export function can be reused between projects.

### 1 2 Procedure

1. Select **File>Export** from the menu bar.  
The saving destination and file names appear.
2. Enter a saving destination and file name, and press [Save] button.  
Information on the parameters and positioning data tables will be saved in a file with a “.pmx” extension.

#### **i** Info.

- When export is executed, information on the positioning data tables will be saved along with parameters set in the parameter setting menu.

### 4.2.6 Check on Parameter Data

- The following procedure is explained on the condition that the Configurator PMX has already started.

## 1 2 Procedure

1. Select **Debug>Check Parameter and Data Values** from the menu bar.

A message box appears to show the check result. If there is an error in the settings for the positioning data tables, an error message will appear and the cursor will move to the corresponding error position.

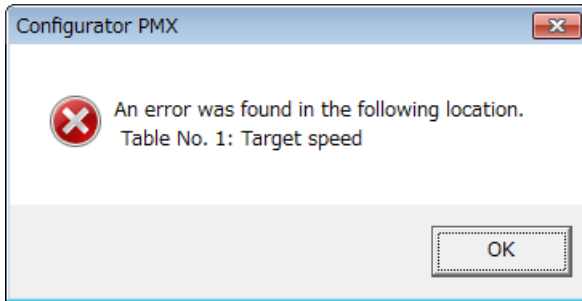

### 4.2.7 Writing Parameters to Unit (1)

- Information on parameters that have been set is transferred to the unit along with information on programs, comments and system registers.
- The following procedure is explained on the condition that the Configurator PMX has already started.

## 1 2 Procedure

1. Select **File>Save changes and exit** from the menu bar of the Configurator PMX.
2. When "Do you save the setting?" appears, press [Yes (Y)].
3. Select **Online>Download To PLC (Entire project)** from the FPCWIN GR7 menu bar. Positioning data will also be downloaded to the control unit along with information on programs, comments and system registers.

### 4.2.8 Writing Parameters to Unit (2)

- Information on parameters that have been set can also be downloaded to the unit in the Configurator PMX.
- The following procedure is explained on the condition that the Configurator PMX has already started.

## 1 2 Procedure

1. Select **File>Download positioning data** from the menu bar of the Configurator PMX. A message box for confirming the saving appears.

## 4.2 Settings in Configurator PMX

---

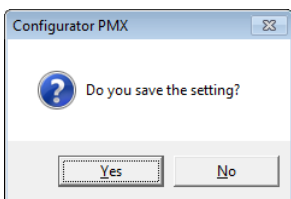

2. Press the [Yes] button.

A message confirming the download to the PLC appears. In the RUN mode, a message confirming that the mode is switched to the PROG. mode also appears.

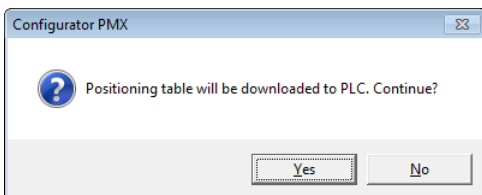

3. Press the [Yes] button.

A message confirming the switching of the operation mode appears.

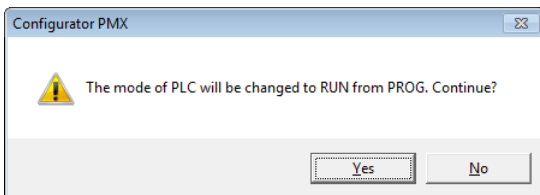

4. Press the [Yes] button to switch the operation mode.

## 4.3 System Register Settings

### 4.3.1 Confirming and Selecting Functions to be Used

The set condition can be confirmed by the following procedure. The following procedure is explained on the condition that the FPWIN GR7 has already started.

#### 1 2 Procedure

1. Select **Option>System register settings** from the menu bar.  
The "PLC Configuration " dialog box appears.
2. Select "Controller output setting (PLS/PWM)" from the left pane.

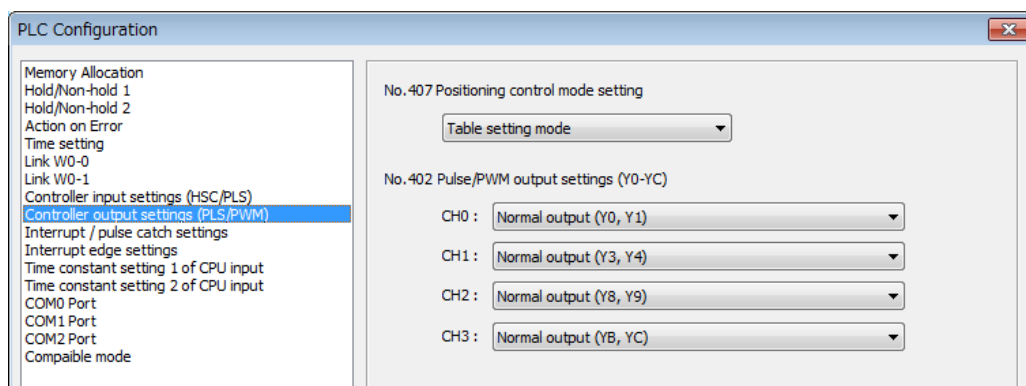

3. Confirm the functions to be used and change the settings as necessary.
4. Press the [OK] button.  
The screen returns to the ladder edit screen. The settings will be downloaded to the PLC together with programs.

#### **i** Info.

- When the settings are saved in the Configurator PMX, the system registers corresponding to the I/O used for the positioning function will be automatically set.
- Change the settings of the corresponding system registers when the home input is not used or the PWM output is allocated to other channels.

#### Settings when using table setting mode

Parameter name	No. and setting item	Settings
Controller input settings (HSC/PLS)	400 HSC operation mode setting (X0 to X2)	CH0 Not Set X0 as High Speed Counter 2 phase input (X0, X1) 2 phase input (X0, X1) Reset input (X2) Addition input (X0) Addition input (X0) Reset input (X2) Subtraction input (X0) Subtraction input (X0) Reset input (X2)

## 4.3 System Register Settings

Parameter name	No. and setting item		Settings
			Individual input (X0, X1) Individual input (X0, X1) Reset input (X2) Direction distinction (X0, X1) Direction distinction (X0, X1) Reset input (X2) J-point positioning start input of pulse output CH0 (X0)
		CH1	Not Set X1 as High Speed Counter Addition input (X1) Addition input (X1) Reset input (X2) Subtraction input (X1) Subtraction input (X1) Reset input (X2) J-point positioning start input of pulse output CH1 (X1)
	401 HSC operation mode setting (X3 to X5)	CH2	Not Set X3 as High Speed Counter 2 phase input (X3, X4) 2 phase input (X3, X4) Reset input (X5) Addition input (X3) Addition input (X3) Reset input (X5) Subtraction input (X3) Subtraction input (X3) Reset input (X5) Individual input (X3, X4) Individual input (X3, X4) Reset input (X5) Direction distinction (X3, X4) Direction distinction (X3, X4) Reset input (X5) J-point positioning start input of pulse output CH2 (X3)
			CH3
	Controller output settings (PLS/PWM)	407 Positioning control mode setting	
402 Pulse/PWM output setting (Y0 to YC)		CH0	Select the output allocated to each channel.
		CH1	Normal output, PWM output, Pulse output [Table setting mode],
		CH2	Pulse output [FPsigma compatible instruction mode]
		CH3	This setting cannot be selected in the FPsigma mode.

(Note 1) Displayed items vary according to models.

(Note 2) Select "Normal input" and "Normal output" for the input and output that is not used for the pulse output function or high-speed counter function.

(Note 3) "J-point positioning start input" for each channel can be selected only when "Table setting mode" is set in the system register no. 407.

### Info.

- For details of the FPsigma mode, refer to "11 FPsigma Mode".

## 4.4 Reading Elapsed Values

### 4.4.1 Elapsed Value (Current Value) Area

- They are stored as 2-word 32-bit data in the axis information area of positioning memory.
- The elapsed value area will be reset when the power supply turns off. It will be held when switching the mode from RUN to PROG.

#### ■ Counting range of elapsed value (current value) area

Section	Range
For single axis control	-1,073,741,824 to 1,073,741,823
For interpolation axis control	-8,388,608 to +8,388,607

### 4.4.2 Reading Elapsed Value (Current Value) Area

Use [F384 PTBLR] positioning parameter read instruction for reading elapsed values.

#### ■ Instruction format



Operand	Settings	Specification for reading the elapsed value area
S1	Specification of channel numbers and positioning memory area	H1 Specify the axis information area of CH0. H101 Specify the axis information area of CH1. H201 Specify the axis information area of CH2. H301 Specify the axis information area of CH3.
S2	Starting address of positioning memory (Offset address)	K2 Specify the offset address.
n	No. of read words	K2 Specify two words.
D	Operation memory storing read data	Specify an arbitrary memory.

#### ■ Sample program

The following sample shows the program when reading the elapsed value (current value) of CH3 to the data registers DT300 to DT301. For details of instructions, refer to ["7 Instruction References"](#).

## 4.4 Reading Elapsed Values

---





# 5 Operation Patterns

---

5.1 Stop Operation.....	5-2
5.1.1 Type of Stop Operations .....	5-2
5.1.2 Characteristics of Stop Operations .....	5-3
5.2 JOG Operation.....	5-4
5.2.1 Settings and Operations of JOG Operation .....	5-4
5.2.2 Settings and Operation of JOG Operation (Speed Changes).....	5-6
5.2.3 Changing the Speed During JOG Operation .....	5-8
5.3 Home Return.....	5-9
5.3.1 Types of Home Return .....	5-9
5.3.2 Operation Patterns of Home Return .....	5-10
5.3.3 Settings and Operations of Home Return .....	5-12
5.4 Positioning Control.....	5-16
5.4.1 Types of Positioning Control .....	5-16
5.4.2 E-point Control (First Speed Positioning).....	5-17
5.4.3 P-point Control (Second Speed Positioning) .....	5-18
5.4.4 C-point Control .....	5-20
5.4.5 J-point Control (JOG Positioning Control).....	5-22
5.4.6 J-point Control (JOG Positioning: Speed Changes) .....	5-23
5.4.7 Programming Cautions .....	5-26
5.5 Repeat Operation.....	5-28
5.5.1 Overview of Repeat Operation.....	5-28
5.5.2 Settings and Operations of Repeat Operation .....	5-29
5.5.3 Stop Operation During Repeat Operation.....	5-31
5.6 Linear Interpolation Control.....	5-33
5.6.1 Overview .....	5-33
5.6.2 Settings and Operations of Linear Interpolation.....	5-33

## 5.1 Stop Operation

### 5.1 Stop Operation

#### 5.1.1 Type of Stop Operations

##### ■ Type of stop operations

Name	Time chart	Occurrence condition and operation
System stop		<ul style="list-style-type: none"> <li>Once the system stop contact (Y800) turns on, an active operation will stop and the pulse outputs of all channels will immediately stop.</li> <li>The similar operation is performed when the operation mode of the control unit is switched from RUN to PROG.</li> </ul>
Emergency stop		<ul style="list-style-type: none"> <li>Once an emergency stop contact (Y830 to Y833) turns on, an active operation will stop and the pulse outputs of corresponding channels will stop.</li> <li>Performs a deceleration stop in the deceleration time specified in the positioning parameter setting menu of Configurator PMX.</li> </ul>
Limit stop:		<ul style="list-style-type: none"> <li>Once an over limit input (+) and over limit input (-) (Y860 to Y867) turns on, an active operation will stop and the pulse outputs of corresponding channels will stop.</li> <li>Performs a deceleration stop in the "limit stop deceleration time" specified in the positioning parameter settings.</li> </ul>
Deceleration stop		<ul style="list-style-type: none"> <li>Once a deceleration stop contact (Y838 to Y83B) turns on, an active operation will stop and the pulse outputs of corresponding channels will stop.</li> <li>Performs a deceleration stop in the deceleration time specified for the active positioning operation.</li> </ul>

##### ■ Execution of stop operations

Stop controls are executed when the following I/O signals turn on.

##### ■ Allocation of I/O signals (Output)

Signal name	I/O number			
	Axis 1	Axis 2	Axis 3	Axis 4
	CH0	CH1	CH2	CH3
System stop	Y800			

Signal name	I/O number			
	Axis 1	Axis 2	Axis 3	Axis 4
	CH0	CH1	CH2	CH3
Emergency stop	Y830	Y831	Y832	Y833
Over limit input (+) (Note 1)	(Y860)	(Y862)	(Y864)	(Y866)
Over limit input (-) (Note 1)	(Y861)	(Y863)	(Y865)	(Y867)
Deceleration stop	Y838	Y839	Y83A	Y83B

(Note 1) The over limit input (+) and over limit input (-) will be valid when arbitrary inputs are allocated and the output relays indicated in the above table turn ON.

### 5.1.2 Characteristics of Stop Operations

#### ■ Priority of stop operations

When stop control requests are made simultaneously, the stop operations are executed according to the following priority.

1. System stop > 2. Emergency stop > 3. Limit stop > 4. Deceleration stop

#### ■ Dwell time setting

The dwell time setting is invalid in the stop operations regardless of patterns.

#### ■ Flag processing

- In the case of system stop, the busy signal turns off and the operation done signal turns on.
- In the cases of emergency stop, limit stop and deceleration stop, the busy signal turns off and the operation done signal turns on after the completion of the pulse output during deceleration.

#### ■ Elapsed value area (Current value coordinate)

- Even in a stop operation, the elapsed value area is always updated.
- After the emergency stop, limit stop or deceleration stop, deceleration is performed with each specified deceleration time, and the value when the pulse output stops is stored.
- In the case of system stop, the value when the pulse output stops is stored.

#### **i** Info.

- For details of the deceleration stop operations when repetitive control is executed, refer to "[5.5.3 Stop Operation During Repeat Operation](#)".

## 5.2 JOG Operation

### 5.2 JOG Operation

#### 5.2.1 Settings and Operations of JOG Operation

The parameters for JOG operations are specified in the positioning parameter setting menus of Configuration PMX.

Pulses are output while the JOG operation start instruction (F381 JOGST) is executed.

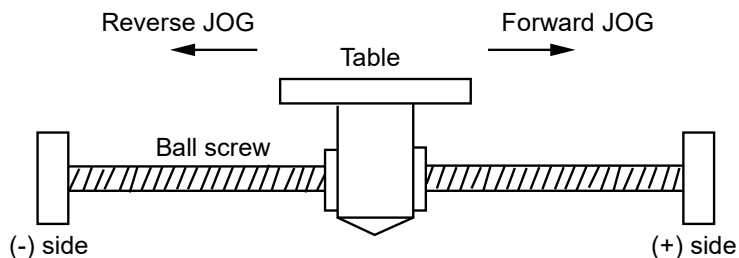

#### ■ Operation diagram

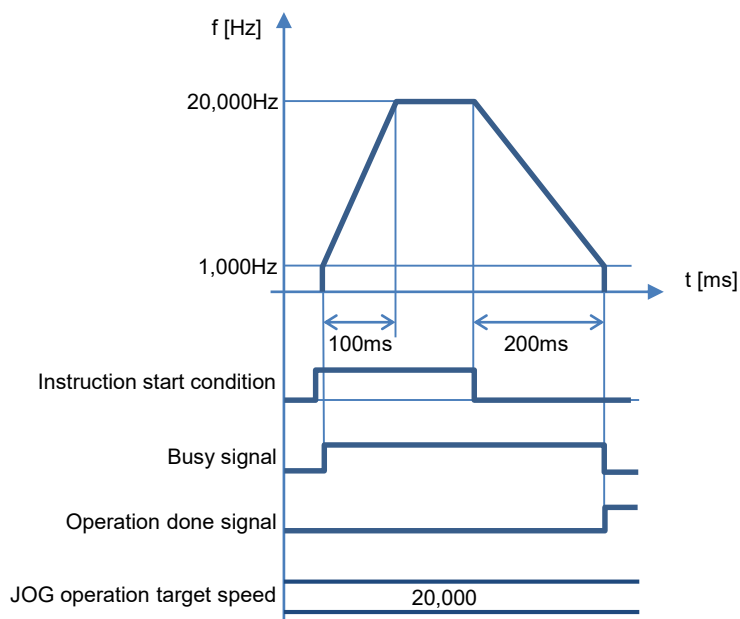

#### ■ Operations of each contact

- The BUSY flags (X808 to X80B), which indicate that the motor is running, will turn on when the JOG operation starts, and they will turn off when the operation completes.
- The operation done flags (X810 to X813), which indicate the completion of operation, will turn on when the current operation is completed, and they will be held until the next positioning control, JOG operation or home return operation starts.

#### ■ Programming cautions

- The startup contact and flag numbers vary depending on channel numbers (axis numbers).

## ■ Settings

Item	Setting example	
Axis setting area	Startup speed	1,000 Hz
	JOG operation acceleration time	100 ms
	JOG operation deceleration time	200 ms
	JOG operation target speed	20,000 Hz

## ■ Configurator PMX settings

Parameter settings		Channel0 (1 axis)
	Home return creep speed	100
	Deviation counter clear time (ms)	1
	Coordinate origin	0
JOG operation	JOG acceleration time (ms)	100
	JOG deceleration time (ms)	200
	JOG target speed	20000
	J point change target speed	1000

## ■ Sample program

The execution condition is set to be always executed. For details of instructions, refer to "7 Instruction References".

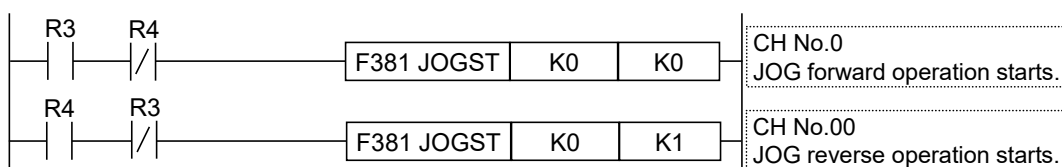

## ■ Operation at limit input

Conditions	Direction	Limit status	Operation
At startup	Forward	Over limit input (+): ON	Not executable, Error occurs.
		Over limit input (-): ON	Executable
	Reverse	Over limit input (+): ON	Executable
		Over limit input (-): ON	Not executable, Error occurs.
During operation	Forward	Over limit input (+): ON	Limit stops, Error occurs. (Note 1)
		Over limit input (-): ON	Limit stops, Error occurs. (Note 1)
	Reverse	Over limit input (+): ON	Limit stops, Error occurs. (Note 1)

## 5.2 JOG Operation

Conditions	Direction	Limit status	Operation
		Over limit input (-): ON	Limit stops, Error occurs. (Note 1)

(Note 1) Create a program as below if you do not want to restart the instruction when the limit error occurs during an operation when the execution condition has been set to be always executed.

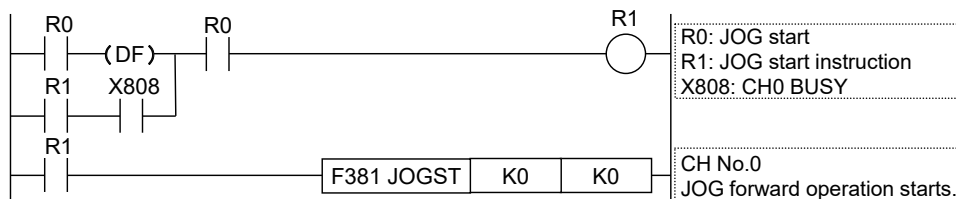

### 5.2.2 Settings and Operation of JOG Operation (Speed Changes)

It is possible to change a target speed during the JOG operation. The target speed is changed by rewriting the positioning memory using a user program.

#### ■ Operation diagram

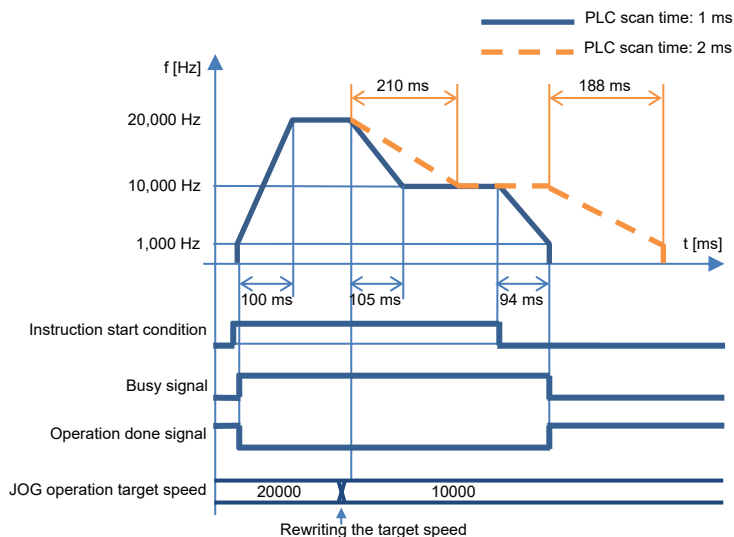

The operation diagram example represents theoretical values for when the PLC scan time is set to a fixed value.

The acceleration / deceleration time after the JOG operation target speed is changed shows an operation example when the PLC scan time is set to a fixed value of 1 ms or 2 ms.

#### ■ Operations of each flag

- The BUSY flags (X808 to X80B), which indicate that the motor is running, will turn ON when the JOG operation starts, and they will turn OFF when the operation completes.

- The operation done flags (X810 to X813), which indicate the completion of operation, will turn ON when the current operation is completed, and they will be held until the next positioning control, JOG operation or home return operation starts.

#### ■ Characteristics of acceleration / deceleration zone when changing speeds

- When the JOG operation speed is changed, the time required to reach the target speed becomes different from the time set in “JOG acceleration time” or “JOG deceleration time”. The actual acceleration / deceleration time can be obtained from the “JOG target speed”, “Startup speed”, and “JOG acceleration time” or “JOG deceleration time”.

When the JOG operation target speed is changed, the unit operates according to the acceleration / deceleration time obtained from the following formula.

Speed variation = (JOG operation target speed at startup - Startup speed) / (JOG acceleration time or JOG deceleration time)

Acceleration/deceleration time after the JOG operation target speed is changed = [ (Target speed after the change - Target speed before the change / Speed variation)] x PLC scan time

#### ■ Settings

Item	Setting example	
Axis setting area	Startup speed	1,000 Hz
	JOG operation acceleration time	100 ms
	JOG operation deceleration time	200 ms
	JOG operation target speed	20,000 Hz → 10,000 Hz

#### ■ Configurator PMX settings

Parameter settings		Channel0 (1 axis)
	Home return creep speed	100
	Deviation counter clear time (ms)	1
	Coordinate origin	0
JOG operation	JOG acceleration time (ms)	100
	JOG deceleration time (ms)	200
	JOG target speed	20000
	J point change target speed	1000

#### ■ Sample program

The execution condition is set to be always executed. For details of instructions, refer to "7 Instruction References".

## 5.2 JOG Operation

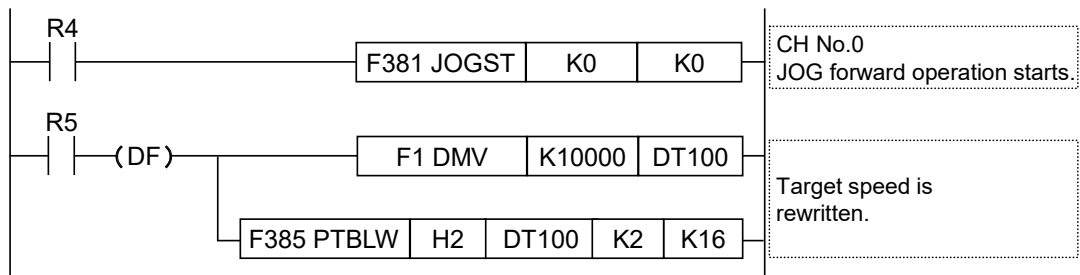

### ■ Notes on programming

- To change a speed during the JOG operation, rewrite the value of the positioning memory (axis setting area) using a user program.
- The startup contact and flag numbers vary depending on channel numbers (axis numbers).

### 5.2.3 Changing the Speed During JOG Operation

- Execute the speed change only after acceleration or deceleration is completed.
- The speed range where JOG operation can be set is 50 Hz to 100 kHz. When a value of less than 50 Hz is set, it is corrected to 50 Hz.



## 5.3 Home Return

### 5.3.1 Types of Home Return

The home return is specified in the positioning parameter setting dialog box for each axis.

Name	Operation diagram	Operation and application
DOG method 1		<ul style="list-style-type: none"> <li>• The leading edge of the first home input is set as a home position after the detection of the leading edge of the near home input.</li> <li>• Even when the limit input turns on, the motor rotation will be automatically reversed and the home return operation will continue.</li> <li>• This method is used when the home switch exists in the range that the near home switch is enabled, such as a system using a servo motor. This method can also be used when no home switch exists in the range that the near home switch is enabled.</li> </ul>
DOG method 2		<ul style="list-style-type: none"> <li>• The leading edge of a near home input is detected and it is set as a home position.</li> <li>• Even when the limit input turns on, the motor rotation will be automatically reversed and the home return operation will continue.</li> <li>• This method is used for performing the home return with the near home switch only.</li> </ul>
DOG method 3		<ul style="list-style-type: none"> <li>• The leading edge of the first home input in the home return direction set as a home position after the detection of a trailing edge (back end) of the near home input.</li> <li>• Even when the limit input turns on, the motor rotation will be automatically reversed and the home return operation will continue.</li> <li>• This method is used when no home switch exists in the range that the near home switch is enabled.</li> </ul>
Home position method		<ul style="list-style-type: none"> <li>• Moves the current position to the home return direction, and stops at the position where the leading edge of the home input is detected. This coordinate is set as the starting point.</li> <li>• When no home input exists in the home return direction, the limit input turns on and the operation stops.</li> <li>• This method is used for performing the home return with the home switch only. This method is compatible with the F171 instruction of the existing model FPsigma.</li> </ul>

## 5.3 Home Return

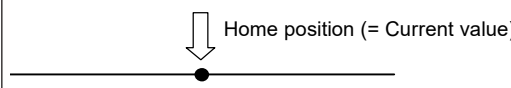
Name	Operation diagram	Operation and application
Data set method		<ul style="list-style-type: none"> <li>• Performs the home return based on the home coordinate values in the axis setting area of positioning memory.</li> <li>• Performs the home return toward the home coordinate on the software.</li> <li>• When the starting point is within the limit switch, it cannot be started.</li> </ul>

### 5.3.2 Operation Patterns of Home Return

The operations vary according to selected home return methods and the difference in current positions.

#### ■ DOG method 1 (Edge detection of near home switch + Home switch, based on front end)

The leading edge of the first home switch is set as a home position after the detection of the leading edge of the near home switch.

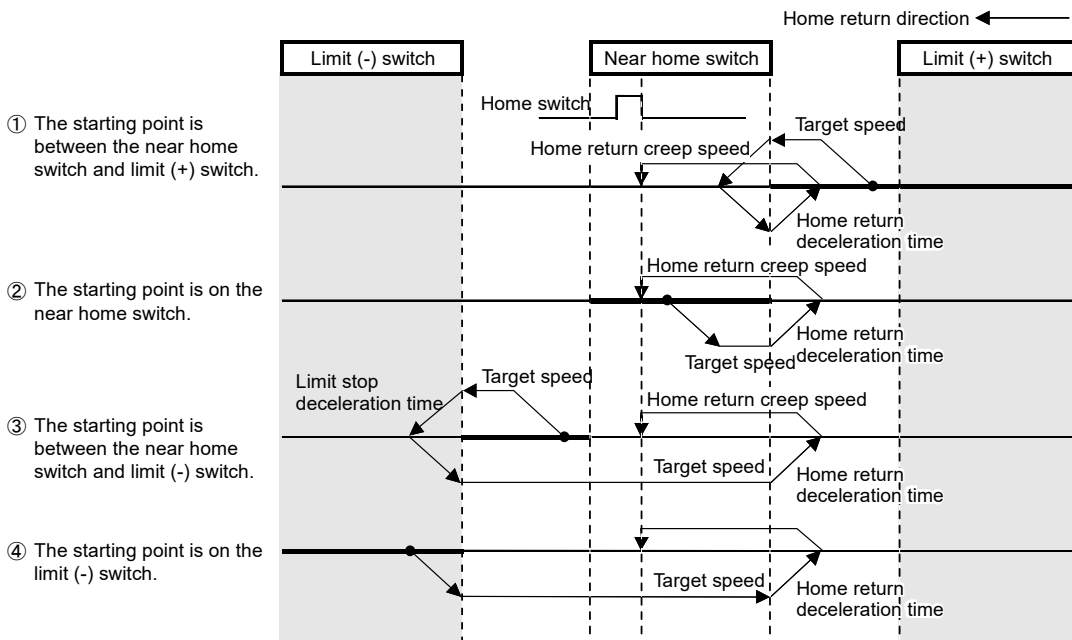

#### ■ DOG method 2 (Edge detection of near home switch)

The leading edge of the near home switch is detected and it is set as a home position.

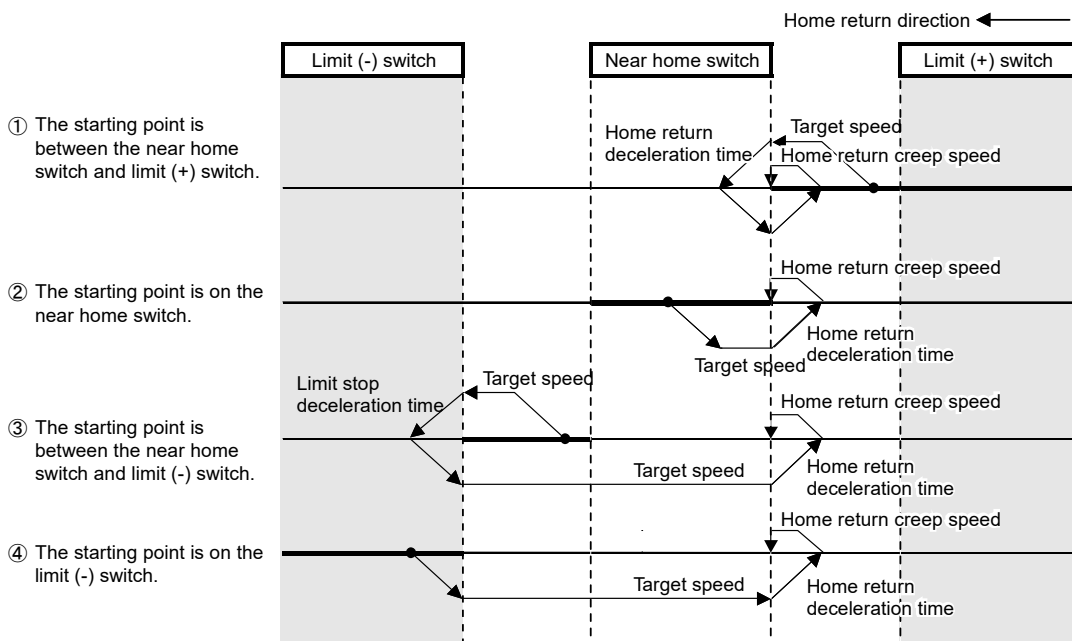

■ **DOG method 3 (Edge detection of near home switch + Home switch, based on back end)**

The leading edge of the first home switch in the home return direction is set as a home position after the detection of the trailing edge (back end) of the near home switch.

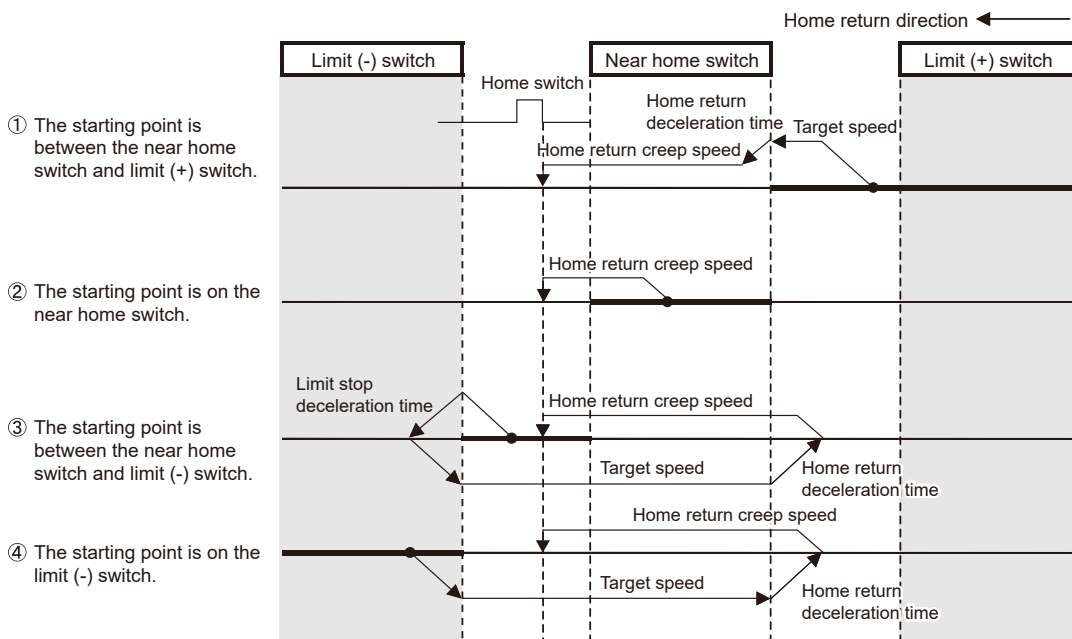

## 5.3 Home Return

### ■ Home position method (Edge detection of home switch)

Moves the current position to the home return direction, and stops at the position where the leading edge of the first home switch is detected. This coordinate is set as a home position.

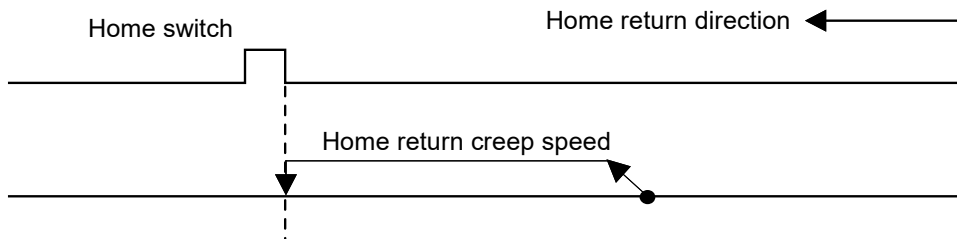

### ■ Data set method

Performs the home return based on the home coordinate values in the axis setting area of positioning memory.

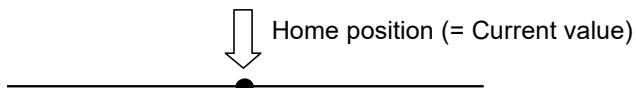

### **i** Info.

- For details of addresses and settings of positioning memory, refer to "[12.3 Positioning Memory](#)".

### 5.3.3 Settings and Operations of Home Return

- The parameters for home return operations are specified in the positioning parameter setting menus of Configuration PMX.
- When the home return start instruction (F382 ORGST) is executed, the pulse output will start and the home return operation will be performed.
- In the following example, the DOG1 method is selected. After the start, it moves at a target speed and reverses at the time of near home detection. After the redetection of near home input, it moves at a creep speed until the home position is detected.

### ■ Operation diagram

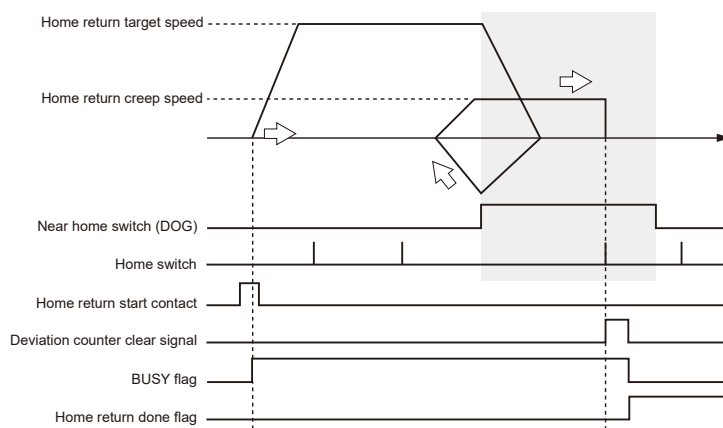

### ■ Operations of each contact

- The BUSY flags (X808 to X80B), which indicate that the motor is running, will turn on when the home return operation starts, and they will turn off when the operation completes.
- The deviation counter clear signal will turn on after the completion of the home return operation. The ON time is set in the axis setting area of the positioning memory.
- The home return done flags (X828 to X82B), which indicate the completion of home return operation, will turn on when the current operation is completed, and they will be held until any operation of the positioning control, JOG operation and home return operation starts. The timing of turning on the flags is on the completion of the home return.

### ■ Settings

Item	Setting example	
Axis setting area	Home return setting code	DOG method 1
	Home return direction	Limit (-) direction
	Home return acceleration time (ms)	100 ms
	Home return deceleration time (ms)	100 ms
	Home return target speed	10000 pps
	Home return creep speed	1000 pps
	Deviation counter clear signal ON time	1 ms

## 5.3 Home Return

### ■ Configurator PMX settings

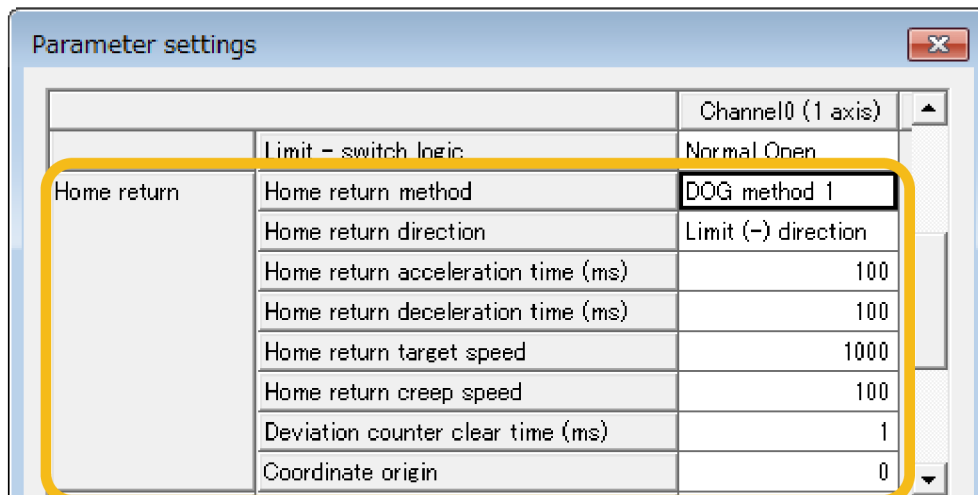

### ■ Sample program

The execution condition is differential execution. For details of instructions, refer to "7 Instruction References".

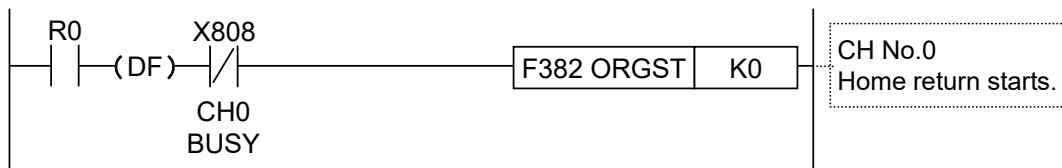

### ■ Operation at limit input

Conditions	Direction	Limit status	Operation
At startup	Forward	Over limit input (+): ON	Executable (Note 2)(Note 3)
		Over limit input (-): ON	Executable (Note 3)
	Reverse	Over limit input (+): ON	Executable (Note 3)
		Over limit input (-): ON	Executable (Note 2)(Note 3)
During operation	Forward	Over limit input (+): ON	Automatic reverse operation (Note 4)
		Over limit input (-): ON edge (Note 1)	Limit stops, Error occurs.
	Reverse	Over limit input (+): ON edge (Note 1)	Limit stops, Error occurs.
		Over limit input (-): ON	Automatic reverse operation (Note 4)

(Note 1) Only when an edge signal is detected, the limit stop is performed.

(Note 2) In the case of home position method, it cannot be executed.

(Note 3) In the case of data set method, it cannot be executed.

(Note 4) In accordance with situations, "Limit stops or Error occurs" (Example) When the limit input is enabled during deceleration, the limit stop is performed without reverse operation.

## 5.4 Positioning Control

### 5.4 Positioning Control

#### 5.4.1 Types of Positioning Control

##### ■ Operation pattern

Name	Time chart	Operation and application	Repeat	Interpolation
E-point control		<ul style="list-style-type: none"> <li>This is a method of control which is initiated up to an end point, and is referred to as "E-point control".</li> <li>This method is used for a first speed acceleration/deceleration.</li> </ul>	•	•
P-point control		<ul style="list-style-type: none"> <li>This refers to control which passes through a "Pass Point", and is called "P-point control".</li> <li>This method is used for a second speed acceleration/deceleration.</li> <li>After the pulse output is performed for a specified movement amount, it shifts to the E-point control.</li> </ul>	•	•
C-point control		<ul style="list-style-type: none"> <li>This refers to control which passes through a "Continuance Point", and is called "C-point control".</li> <li>This method is used for performing two successive first speed positioning control with different target speeds or acceleration/deceleration times.</li> <li>The time taken for transmitting from the C-point control to E-point control is specified as a dwell time.</li> </ul>	•	•
J-point control	<p>No speed change</p>	<ul style="list-style-type: none"> <li>This refers to control which passes through a speed point "JOG Operation Point", and is called "J-point control".</li> <li>After the start, it is controlled at specified speeds.</li> <li>Once the J-point positioning contact turns on, the positioning control starts.</li> <li>When the J-point control speed change flag is set, the speed changes.</li> </ul>	—	—
	<p>Speed changes</p>			

##### ■ Selection of positioning operation modes

Positioning operation modes are selected on Configurator PMX.



- For the E-point control, enter settings in one row.
- For P-point, C-point and J-point controls, they should be combined with E-point control of the next step as a pair and the setting should be input in two rows.

Table number	Operation p...	Control method	X axis (CH)	Accelerati...	Acceleration...	Deceleration...	Target...	Dwell time (ms)
1	E: End point	I: Increment	0	L: Linear	100	100	1000	0
2	E: End point	I: Increment	0	L: Linear	100	100	1000	0
3	E: End point	I: Increment	0	L: Linear	100	100	1000	0
4	E: End point	I: Increment	0	L: Linear	100	100	1000	0
5	E: End point	I: Increment	0	L: Linear	100	100	1000	0

### **i** Info.

- When E: End point is not selected in the next row of P: Pass point, C: Continuance point or J: Speed point, the self-diagnostic error (error code 44: positioning error) is detected.

### ■ Settings of J-point control

- For J-point control, only "Increment" can be selected as a control method.
- For changing speed during J-point control, set the target speed after the change in the positioning parameter dialog box.

## 5.4.2 E-point Control (First Speed Positioning)

- The parameters for position control operations are specified in the positioning parameter setting menus and data tables of Configuration PMX.
- When the positioning table start instruction (F380 POSST) or positioning simultaneous start instruction (F383 MPOST) is executed, the pulse output will start and the positioning control operation will be performed.

### ■ Operation diagram

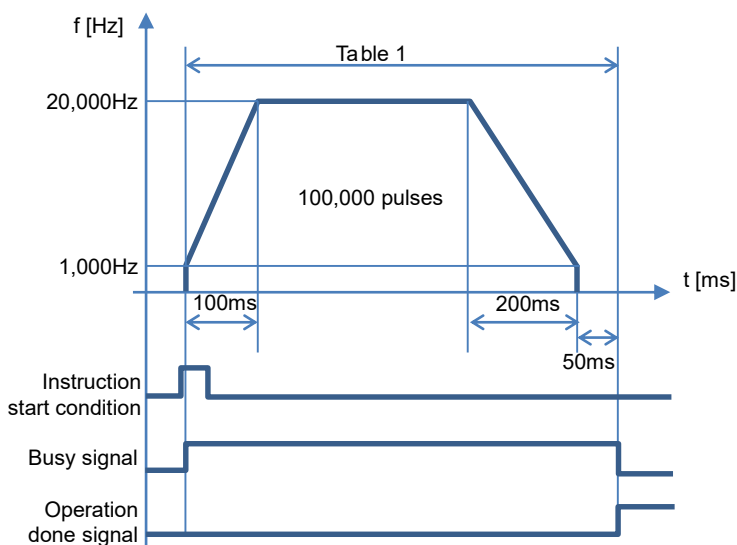

## 5.4 Positioning Control

### ■ Operations of each contact

- The BUSY flags (X808 to X80B), which indicates that the motor is running, will turn on when the positioning control starts, and it will turn off when the operation completes.
- The operation done flags (X810 to X813), which indicate the completion of operation, will turn on when the current operation is completed, and they will be held until the next positioning control, JOG operation or home return operation starts.

### ■ Settings

Item		Setting example
Axis setting area	Startup speed	1,000 Hz
Table area	Table number	Table 1
	Control code	Increment mode
	Operation pattern	E-point control (End point control)
	Positioning acceleration time	100 ms
	Positioning deceleration time	200 ms
	Positioning target speed	20,000 Hz
	Positioning movement amount	100,000 pulses
	Dwell time	50 ms

### ■ Configurator PMX settings

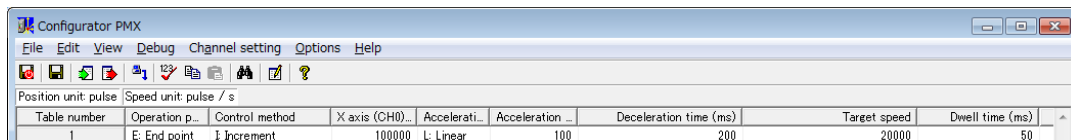
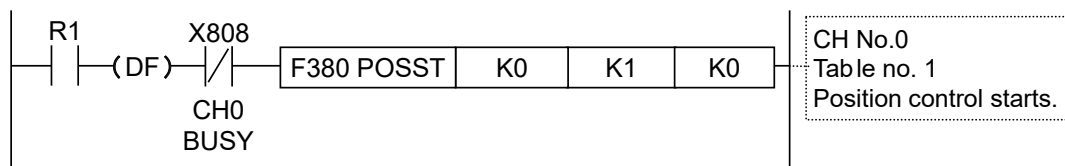

Table number	Operation p...	Control method	X axis (CH0)	Accelerati...	Acceleration ...	Deceleration time (ms)	Target speed	Dwell time (ms)
1	E: End point	I: Increment	100000	L: Linear	100	200	20000	50

### ■ Sample program

The execution condition is differential execution. For details of instructions, refer to "7 Instruction References".



### 5.4.3 P-point Control (Second Speed Positioning)

- The parameters for position control operations are specified in the positioning parameter setting menus and data tables of Configuration PMX.

- When the positioning table start instruction (F380 POSST) or positioning simultaneous start instruction (F383 MPOST) is executed, the pulse output will start and the positioning control operation will be performed.

### ■ Operation diagram

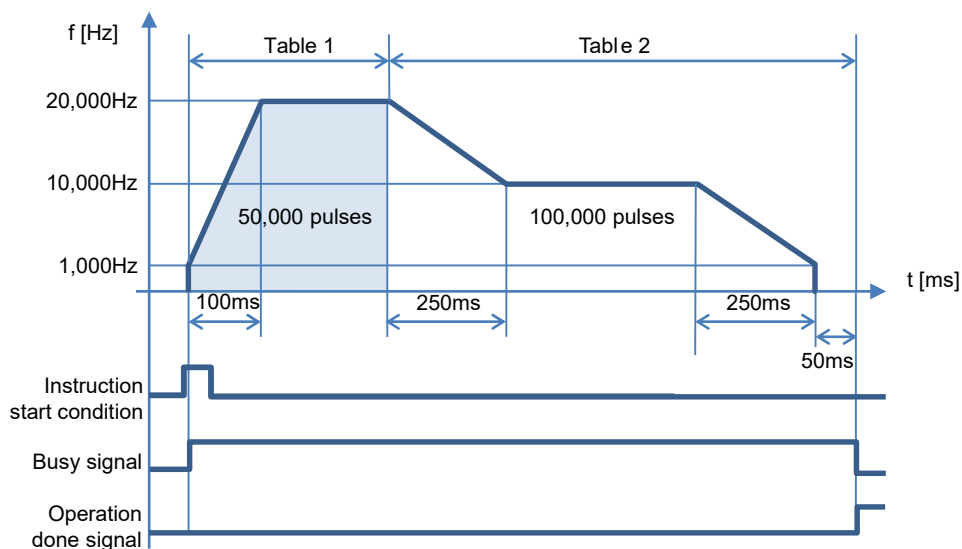

### ■ Operations of each contact

- The BUSY flags (X808 to X80B), which indicates that the motor is running, will turn on when the positioning control starts, and it will turn off when the operation completes.
- The operation done flags (X810 to X813), which indicate the completion of operation, will turn on when the current operation is completed, and they will be held until the next positioning control, JOG operation or home return operation starts.

### ■ Settings

Item		Setting example	
Axis setting area	Startup speed	1,000 Hz	
Table area	Table number	Table 1	Table 2
	Control code	Increment mode	Increment mode
	Operation pattern	P-point control (Pass point control)	E-point control (End point control)
	Positioning acceleration time	100 ms	150 ms
	Positioning deceleration time	200 ms	250 ms
	Positioning target speed	20,000 Hz	10,000 Hz
	Positioning movement amount	50,000 pulses	100,000 pulses
	Dwell time	—	50 ms

## 5.4 Positioning Control

### ■ Configurator PMX settings

Table number	Operation p...	Control method	X axis (CH0) ...	Acceler...	Acceleration time...	Deceleration time ...	Target speed	Dwell time (ms)
1	P: Pass point	I Increment	50000	L: Linear	100	200	20000	0
2	E: End point	I Increment	100000	L: Linear	150	250	10000	50

### ■ Sample program

The execution condition is differential execution. For details of instructions, refer to "7 Instruction References".

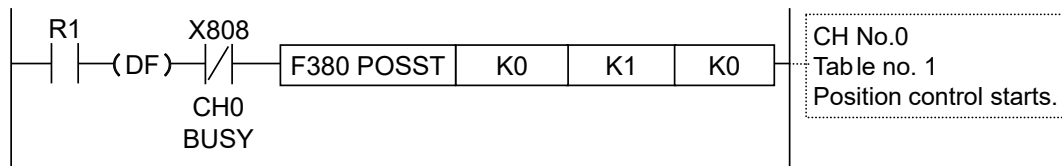

### 5.4.4 C-point Control

- The parameters for position control operations are specified in the positioning parameter setting menus and data tables of Configuration PMX.
- When the positioning table start instruction (F380 POSST) or positioning simultaneous start instruction (F383 MPOST) is executed, the pulse output will start and the positioning control operation will be performed.

### ■ Operation diagram

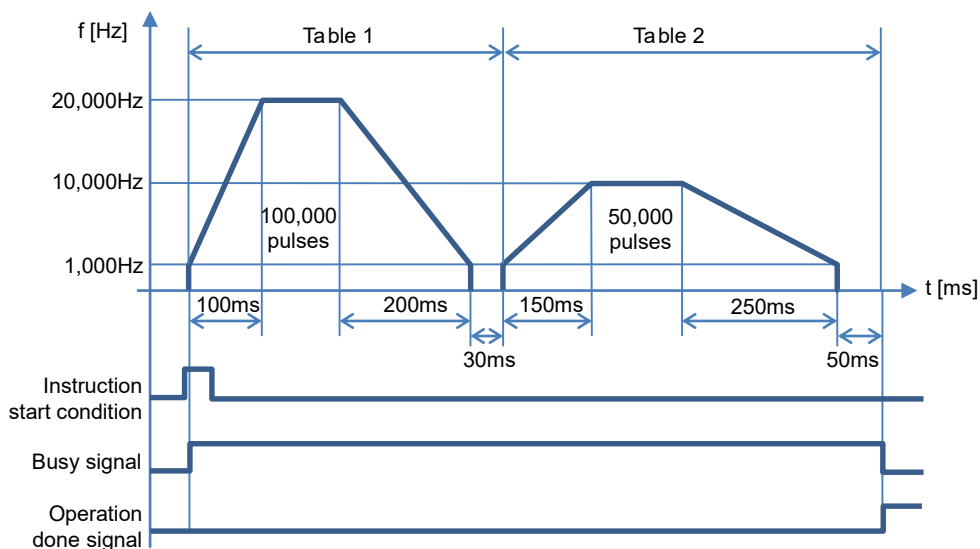

### ■ Operations of each contact

- The BUSY flags (X808 to X80B), which indicates that the motor is running, will turn on when the positioning control starts, and it will turn off when the operation completes.
- The operation done flags (X810 to X813), which indicate the completion of operation, will turn on when the current operation is completed, and they will be held until the next positioning control, JOG operation or home return operation starts.

### ■ Settings

Item		Setting example	
Axis setting area	Startup speed	1,000 Hz	
Table area	Table number	Table 1	Table 2
	Control code	Increment mode	Increment mode
	Operation pattern	C-point control (Continuance point control)	E-point control (End point control)
	Positioning acceleration time	100 ms	150 ms
	Positioning deceleration time	200 ms	250 ms
	Positioning target speed	20,000 Hz	10,000 Hz
	Positioning movement amount	100,000 pulses	50,000 pulses
	Dwell time	30 ms	50 ms

### ■ Configurator PMX settings

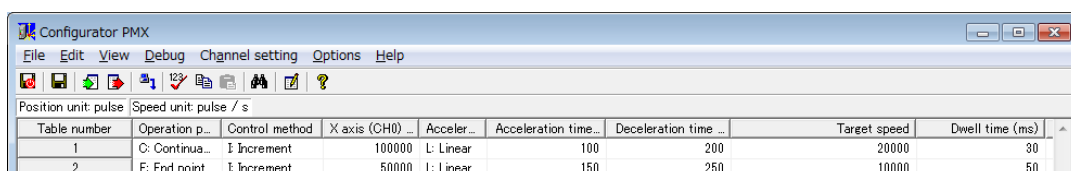
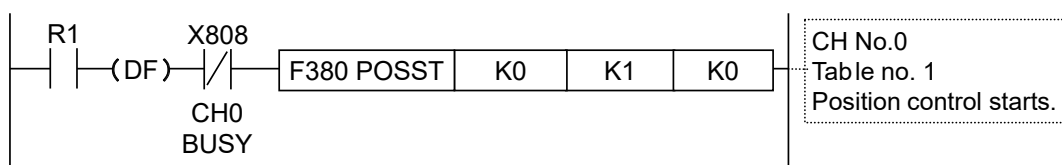

Table number	Operation p...	Control method	X axis (CH0) ...	Acceler...	Acceleration time...	Deceleration time ...	Target speed	Dwell time (ms)
1	C: Continua...	I: Increment	100000	L: Linear	100	200	20000	30
2	E: End point	I: Increment	50000	L: Linear	150	250	10000	50

### ■ Sample program

The execution condition is differential execution. For details of instructions, refer to "[7 Instruction References](#)".



## 5.4 Positioning Control

### 5.4.5 J-point Control (JOG Positioning Control)

- The parameters for position control operations are specified in the positioning parameter setting menus and data tables of Configuration PMX.
- When the positioning table start instruction (F380 POSST) or positioning simultaneous start instruction (F383 MPOST) is executed, the pulse output will start. In the J-point control, the unit operates at a target speed after the startup, and will start the position control when the J-point positioning start contacts (X0, X1, X3, X4) turn on.

#### **i** Info.

- In the system registers no. 400 and 401, select "J-point positioning start input of pulse output CH\*" of the channel to perform the J-point control.

#### ■ Operation diagram

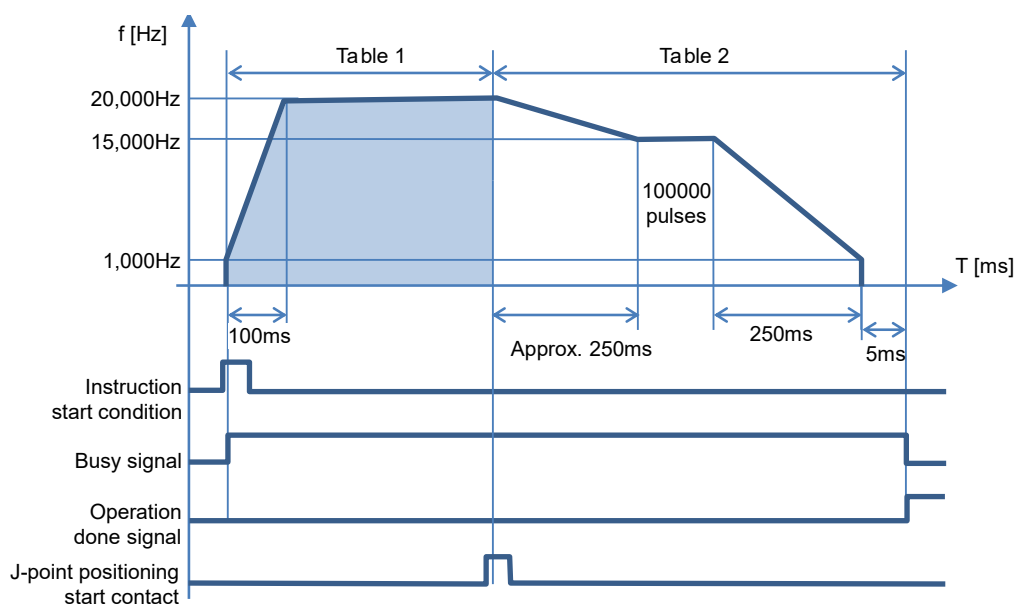

#### ■ Operations of each contact

- The BUSY flags (X808 to X80B) will turn on when the operation starts and turn off when the operation is completed.
- The operation done flags (X810 to X813) will turn on when the JOG operation is completed, and it will be held until the next positioning control, JOG operation, or home return operation starts.
- Positioning control will start when J-point positioning start contacts (X0, X1, X3, X4) turn on.

#### ■ Settings

Item		Setting example	
Axis setting area	Startup speed	1,000 Hz	
	J-point change speed	10,000 Hz	
Table area	Table number	Table 1	Table 2

Item		Setting example	
	Control code	Increment mode	Increment mode
	Operation pattern	J-point control (Speed control)	E-point control (End point control)
	Positioning acceleration time	100 ms	150 ms
	Positioning deceleration time	200 ms	250 ms
	Positioning target speed	20,000 Hz	15,000 Hz
	Positioning movement amount	—	100,000 pulses
	Dwell time	30 ms	5 ms

### ■ Configurator PMX settings

Table number	Operation p...	Control method	X axis (CH0) ...	Accelera...	Acceleration time...	Deceleration time ...	Target speed	Dwell time (ms)
1	J: Speed poi...	I: Increment	0	L: Linear	100	200	20000	30
2	E: End point	I: Increment	100000	L: Linear	150	250	10000	50

### ■ Sample program

The execution condition is differential execution. For details of instructions, refer to "7 Instruction References".

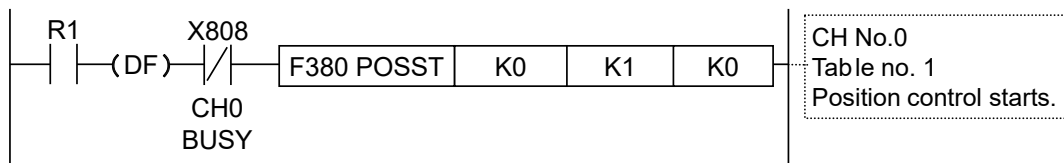

## 5.4.6 J-point Control (JOG Positioning: Speed Changes)

- In the J-point control, the speed can be changed while controlling the speed after the start.
- After starting the J-point control, the unit operates at the speed specified in the positioning parameters of Configurator PMX.
- The speed changes when the J-point control speed change flag (Y840 to Y843) turns on.

### **i** Info.

- In the system registers no. 400 and 401, select "J-point positioning start input of pulse output CH\*" of the channel to perform the J-point control.

## 5.4 Positioning Control

### ■ Operation diagram

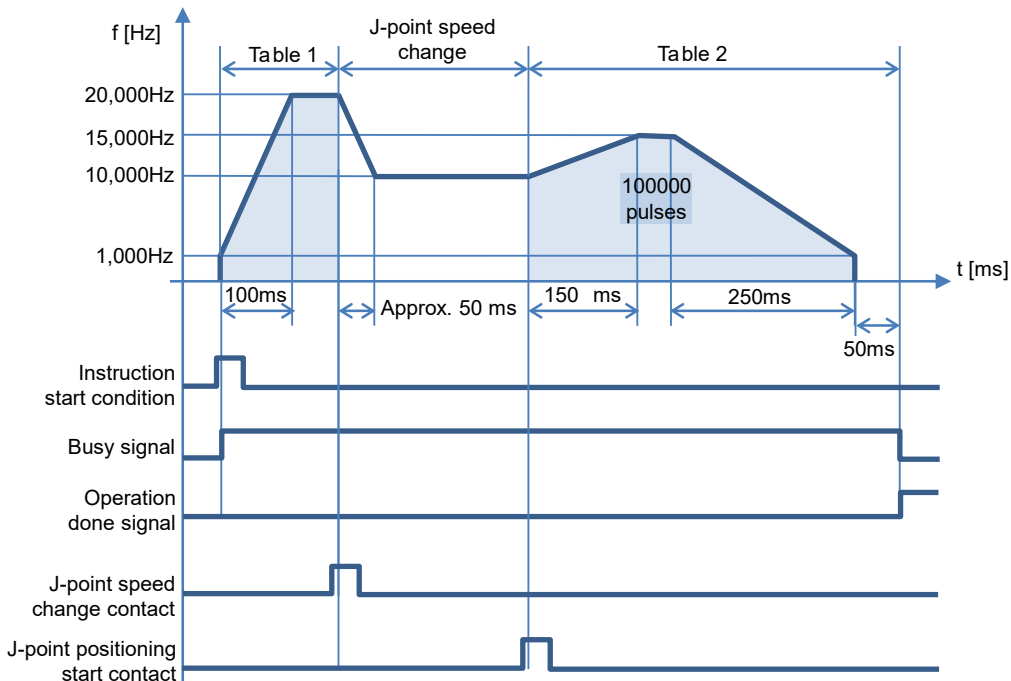

### ■ Operations of each contact

- The BUSY flags (X808 to X80B) will turn on when the operation starts and turn off when the operation is completed.
- The operation done flags (X810 to X813) will turn on when the JOG operation is completed, and it will be held until the next positioning control, JOG operation, or home return operation starts.
- The target speed will be changed when the J-point speed change contacts (Y840 to Y843) turn on. The change will be enabled at the edge where the contact turns on.
- Positioning control will start when J-point positioning start contacts (X0, X1, X3, X4) turn on.

### ■ Characteristics of acceleration/deceleration zone when changing speeds

- The speed of speed change zone changes for each scan when changing the speed in the J-point control. The speed variation is obtained by the following formula.  

$$(J\text{-point table target speed} - \text{Startup speed}) / (J\text{-point table acceleration time or } J\text{-point table deceleration time})$$

### ■ Settings

Item		Setting example	
Axis setting area	Startup speed	1,000 Hz	
	J-point change speed	10,000 Hz	
Table area	Table number	Table 1	Table 2
	Control code	Increment mode	Increment mode



Item		Setting example	
	Operation pattern	J-point control (Speed control)	E-point control (End point control)
	Positioning acceleration time	100 ms	150 ms
	Positioning deceleration time	200 ms	250 ms
	Positioning target speed	20,000 Hz	15,000 Hz
	Positioning movement amount	—	100,000 pulses
	Dwell time	30 ms	50 ms

(Note 1) For the J-point control, the set acceleration time and deceleration time is converted as a time between 0 Hz to 100 kHz, and the speed tables in the acceleration and deceleration sections are calculated. Therefore, when the target speed is below 100 kHz, the actual acceleration/deceleration time is shorter than the set values.

### ■ Configurator PMX settings

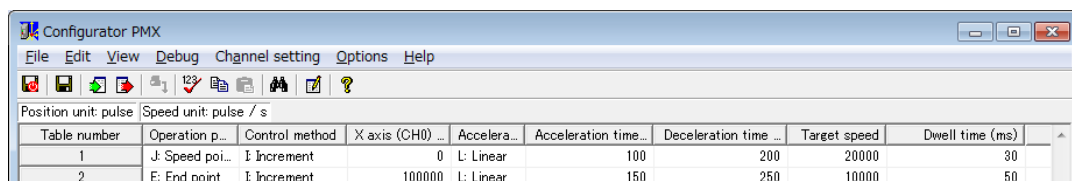
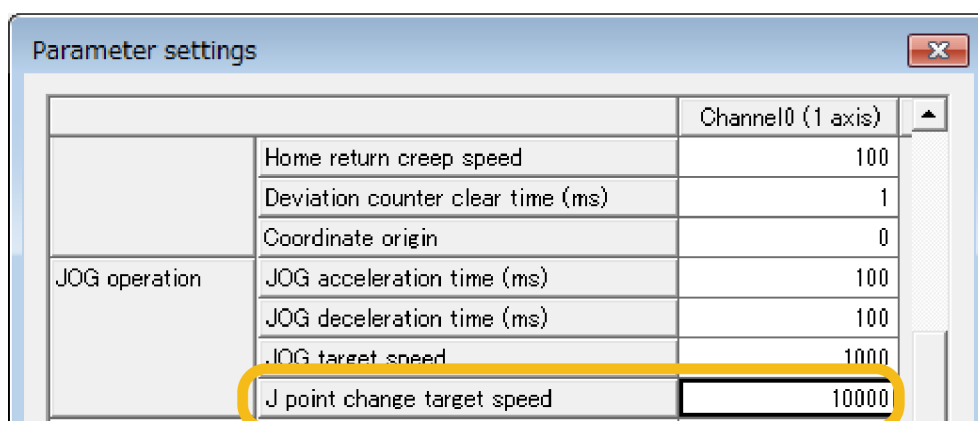

Table number	Operation p...	Control method	X axis (CH0) ...	Accelera...	Acceleration time...	Deceleration time ...	Target speed	Dwell time (ms)
1	J: Speed poi...	I: Increment	0	L: Linear	100	200	20000	30
2	E: End point	I: Increment	100000	L: Linear	150	250	10000	50



Parameter settings		Channel0 (1 axis)
	Home return creep speed	100
	Deviation counter clear time (ms)	1
	Coordinate origin	0
JOG operation	JOG acceleration time (ms)	100
	JOG deceleration time (ms)	100
	JOG target speed	10000
	J point change target speed	10000

### ■ Sample program

The execution condition is differential execution. For details of instructions, refer to "7 Instruction References".

## 5.4 Positioning Control

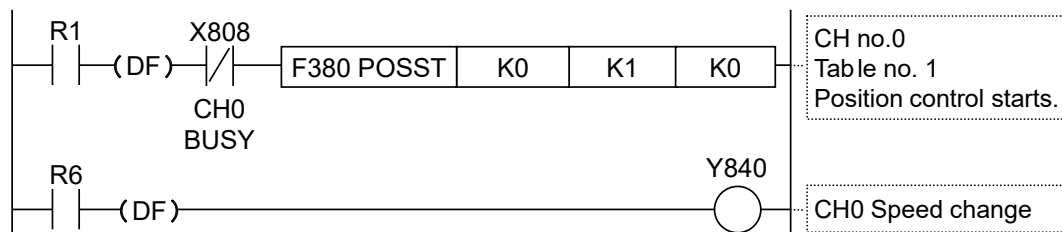

### ■ Behaviors when the speed change contact turns ON while the positioning unit is accelerating or decelerating the speed

- A speed change is possible during J-point control, but impossible during acceleration or deceleration.
- A speed change will be made after the unit goes to constant speed when the speed change signal turns ON during acceleration or deceleration.

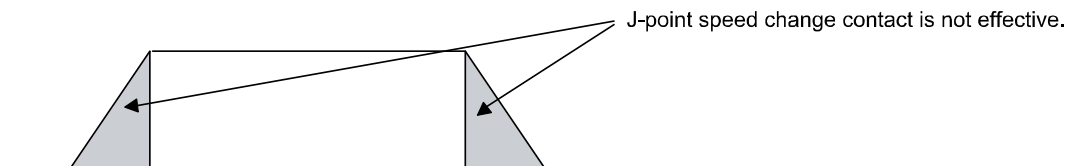

### **i** Info.

- Specify parameters for the start of operation in the positioning data table. The parameters for changing speeds are specified in “Channel setting” > “Parameter settings” menu.
- J-point control can be used for single-axis control only. It is not available for interpolation control.
- Set the unit to increment mode to implement E-point control with positions specified after J-point control is implemented.
- Speed control is performed while the positioning unit is in J-point control, in which case, be sure to input the amount of movement for positioning with a value that can secure a target constant-speed area.

## 5.4.7 Programming Cautions

### ■ Programming cautions

- The last table should be set to E: End point.
- If any value such as a movement amount, acceleration time, deceleration time or target speed is out of the specified range, a positioning error will occur when the position control starts.
- The startup contact and flag numbers vary depending on channel numbers (axis numbers).

### ■ Operation at limit input

Conditions	Direction	Limit status	Operation
When each control starts	Forward	Over limit input (+): ON	Not executable, Error occurs.
		Over limit input (-): ON	Not executable, Error occurs.

Conditions	Direction	Limit status	Operation
When each control is performed	Reverse	Over limit input (+): ON	Not executable, Error occurs.
		Over limit input (-): ON	Not executable, Error occurs.
	Forward	Over limit input (+): ON	Limit stops, Error occurs.
		Over limit input (-): ON	Limit stops, Error occurs.
	Reverse	Over limit input (+): ON	Limit stops, Error occurs.
		Over limit input (-): ON	Limit stops, Error occurs.

## 5.5 Repeat Operation

### 5.5 Repeat Operation

#### 5.5.1 Overview of Repeat Operation

- The repeat count is specified for executing the repeat control in Configurator PMX.
- When the position control start instruction F380 is executed, the unit repeats the operation set in the positioning table.

#### ■ Conditions of repeat control

Item	Repeat control is available	Repeat control is unavailable
Operation pattern	E-point control, P-point control + E-point control C-point control + E-point control	JOG operation, J-point control, Interpolation control
Control method	Increment mode	Absolute mode
Dwell time setting	Set the table of E-point control to 1 ms or more.	When setting 0 ms.

#### ■ Operation diagram (Setting operation on the table)

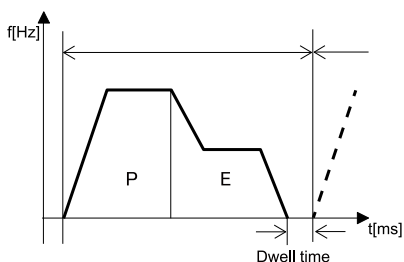

#### ■ Operation diagram (Repeat operation)

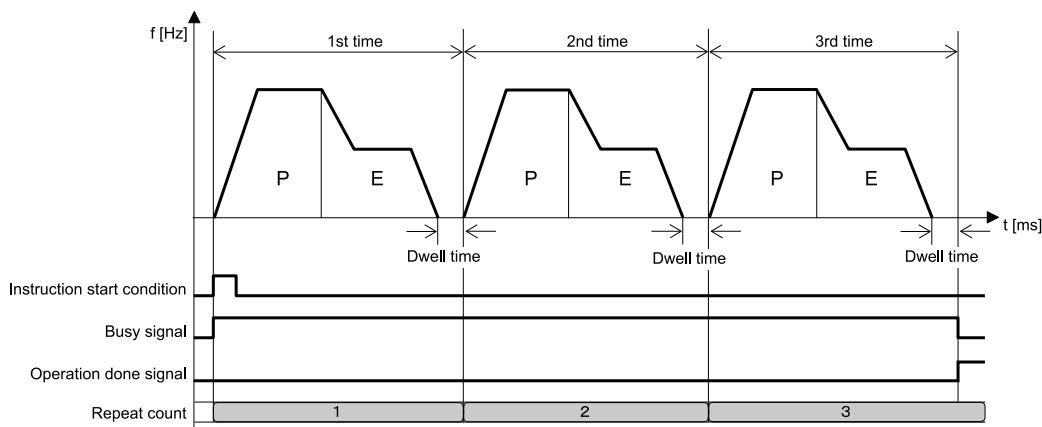

#### ■ Configurator PMX setting items

Parameter name	Unit	Default	Settings	
Positioning repeat count	times	0	0 or 1	Not repeat an operation.

Parameter name	Unit	Default	Settings
			2 to 254
			255
			Repeat an operation for a specified number of times.
			Repeat an operation infinitely.

### ■ Configurator PMX settings

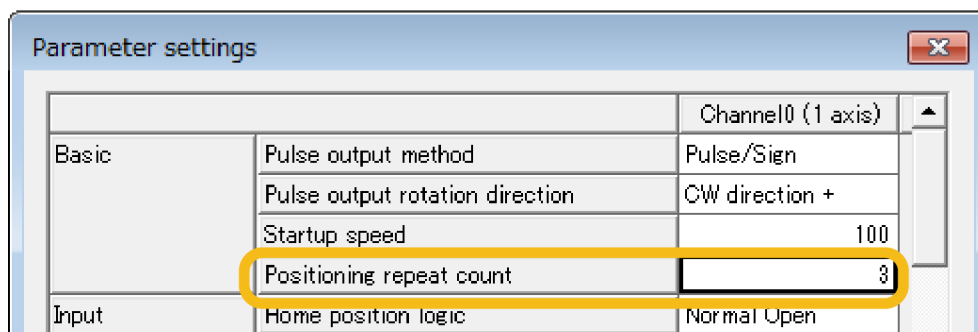

### **i** Info.

- When selecting “255: Repeat infinitely” in the parameter of positioning repeat count, create a program to stop the operation using the deceleration stop function.

## 5.5.2 Settings and Operations of Repeat Operation

- The parameter for the repeat count is specified in the positioning parameter setting menus of Configuration PMX.
- When the positioning table start instruction (F380 POSST) or positioning simultaneous start instruction (F383 MPOST) is executed, the pulse output will start.
- After starting the instruction, the unit executes the pulse output for a specified repeat count and then stops the operation. For setting to execute the operation infinitely, use this function in combination with the deceleration stop function.

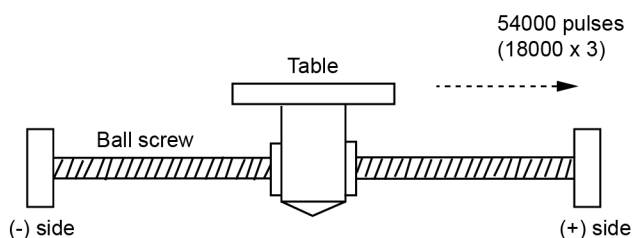

## 5.5 Repeat Operation

### ■ Operation diagram

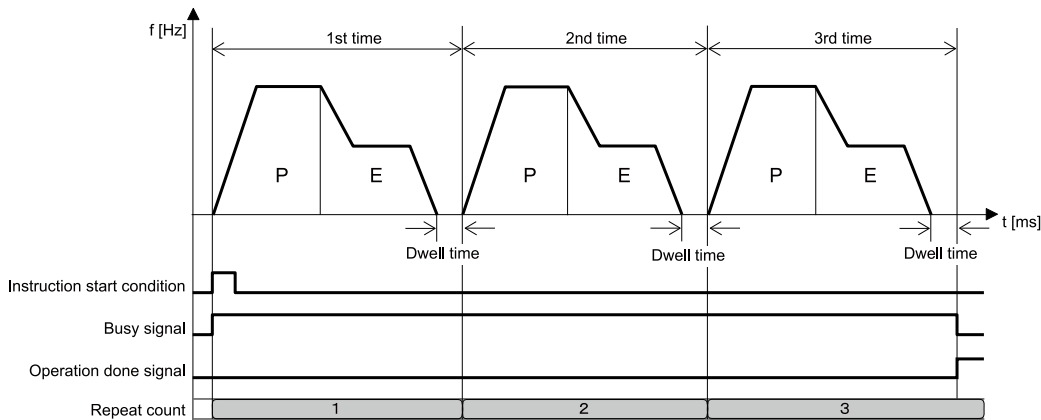

### ■ Operations of each contact

- The BUSY flags (X808 to X80B), which indicate that the motor is running, will turn on when the position control starts, and they will turn off when the set repeat operation completes.
- The operation done flags (X810 to X813), which indicate the completion of operation, will turn on when the current operation is completed, and they will be held until the next positioning control, JOG operation or home return operation starts. Those flags do not turn off in the middle of the repeat operation.

### ■ Settings

Item		Setting example	
Common area	Axis setting	Turn on the single axis setting for an appropriate axis.	
	Positioning repeat count	3	
Axis setting area	Pulse output control code	Set in accordance with system configuration.	
	Startup speed	1,000 Hz	
Table area	Table number	Table 1	Table 2
	Control code	Increment mode	Increment mode
	Operation pattern	P-point control (Pass point control)	E-point control (End point control)
	Positioning acceleration time	100 ms	150 ms
	Positioning deceleration time	200 ms	250 ms
	Positioning target speed	20,000 Hz	10,000 Hz
	Positioning movement amount	5,000 pulses	10,000 pulses
	Dwell time	—	50 ms

## ■ Configurator PMX settings

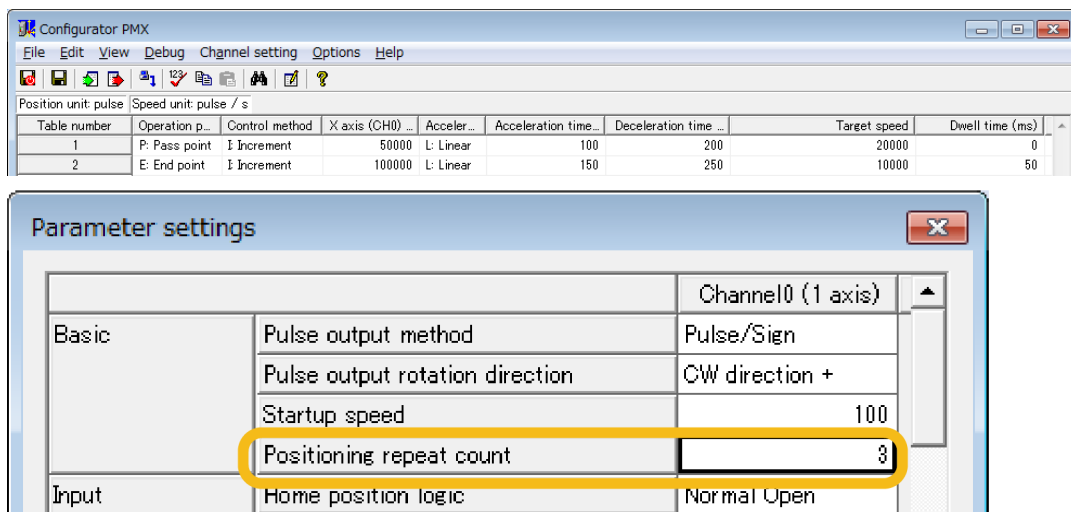

## ■ Sample program

The execution condition is differential execution. For details of instructions, refer to "7 Instruction References".

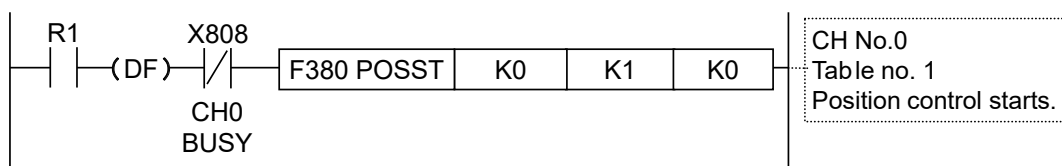

### 5.5.3 Stop Operation During Repeat Operation

- When setting the repeat function, the operation at the time of deceleration stop varies as follows.

#### ■ Operation at the time of deceleration stop (Repeating E-point control)

When the unit detects a deceleration stop, the unit will come to a stop after repeating positioning control N+2 times. However, the unit will stop the control when reaching the set repeat count.

## 5.5 Repeat Operation

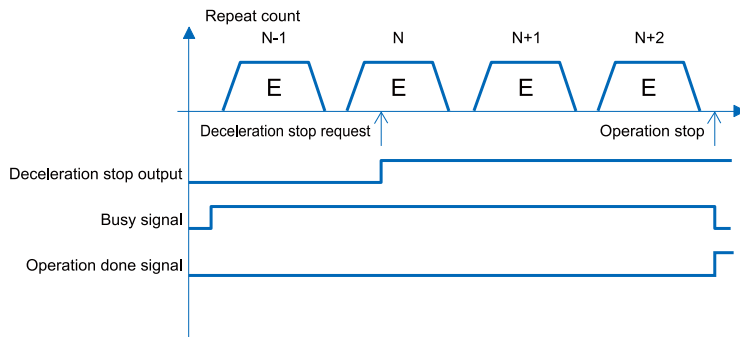

### ■ Operation at the time of deceleration stop (Repeating P-point control, C-point control)

When the unit detects a deceleration stop, it stops the operation after repeating the positioning control N+1 times. However, the unit will stop the control when reaching the set repeat count.

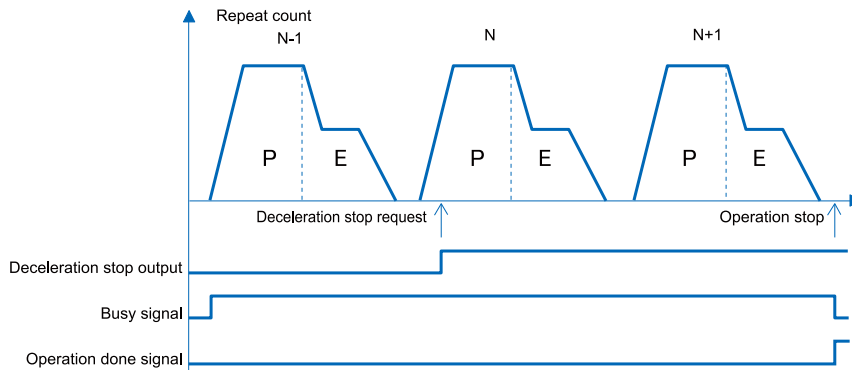

### **i** Info.

- When a system stop is executed, the unit will stop the pulse output immediately without repetitive operations.
- When an emergency stop is executed, the unit will stop the pulse output after a specified emergency stop setting time without repetitive operations.



## 5.6 Linear Interpolation Control

### 5.6.1 Overview

The interpolation control is available under the following conditions.

#### ■ Combinations of interpolation control

Interpolation axis 1		Interpolation axis 2	
X-axis	Y-axis	X-axis	Y-axis
CH0	CH1	CH2	CH3

#### ■ Conditions of interpolation control

Item	Condition under which interpolation control is executable	
	Available	Not available
Operation pattern	E-point control P-point control + E-point control C-point control + E-point control	JOG operation Home return (Note 1) J-point control
Control method	Increment mode, Absolute mode	-
Dwell time setting	Set the E-point control to 1 ms or more	When set to 0 ms, the positioning error occurs.

(Note 1) In the home return operation, the home return start instruction (F382 ORGST) is executed for each channel corresponding to X and Y axes. The trajectory is not linear interpolation.

#### ■ Setting method of speed

Item	Composite speed	Long axis
Operation		
Setting method	Specify the speed combining the speed of X and Y axes.	Specify the speed for the axis whose movement amount is large.

(Note 1) When specifying the same value, the major axis speed is faster than the composite speed.

### 5.6.2 Settings and Operations of Linear Interpolation

The example below is a case of E-point control with the unit installed in slot 1. The X axis is set to the 1st axis and the Y axis is set to the 2nd axis. The movement amount setting is the increment method, and the unit is set to pulse.

## 5.6 Linear Interpolation Control

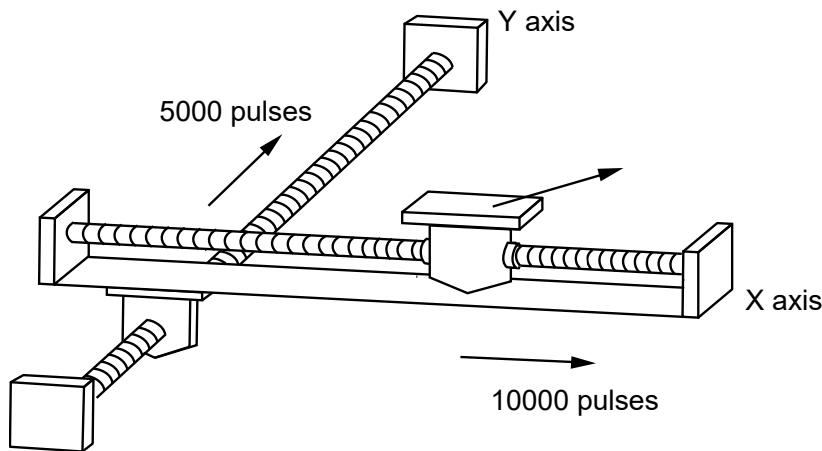

### ■ Operation diagram

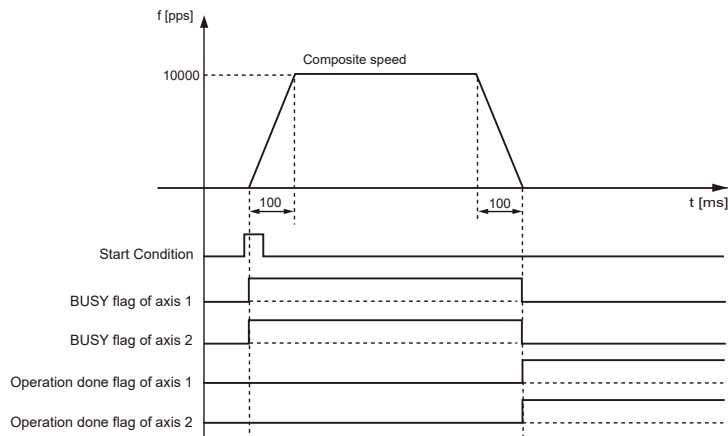

### ■ Operations of each contact

- The BUSY flags (X808, X809), which indicates that the motor is running, will turn on when the positioning control starts, and it will turn off when the operation completes.
- The operation done flags of axes 1 and 2 (X810, X811), which indicates the completion of operation, will turn on when the current operation is completed, and it will be held until the next positioning control, JOG operation or home return operation starts.

### ■ Settings

Item		Setting example
Common area	Axis setting	Turn on the single axis setting for an appropriate axis.
	Positioning repeat count	0
Axis setting area	Pulse output control code	Set in accordance with system configuration.
	Startup speed	1,000Hz
Table	Operation pattern	E: End point

Item	Setting example	
area	Interpolation operation	0: Linear (composite speed)
	Control method	I: Increment
	X-axis movement amount	10000 pulses
	Y-axis movement amount	5000 pulses
	Acceleration/ deceleration method	L: Linear
	Acceleration time (ms)	100 ms
	Deceleration time (ms)	100 ms
	Interpolation speed	10000 pps
	Dwell time	0 ms

### ■ Sample program

The execution condition is differential execution. For details of instructions, refer to "7 Instruction References".

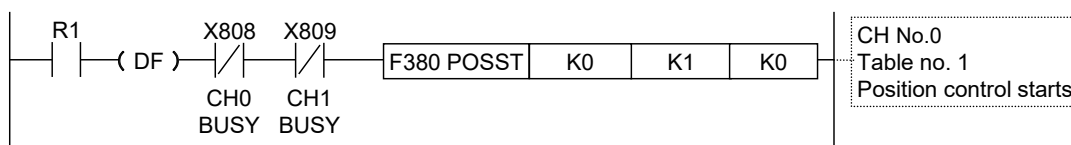

### ■ Programming cautions

- Specify a smaller channel number in the same group for starting the interpolation control.
- If any value such as a movement amount, acceleration time, deceleration time or target speed is out of the specified range, a positioning error will occur when the position control starts.
- The startup contact and flag numbers vary depending on channel numbers (axis numbers).

(MEMO)

# 6 Operating Characteristics

---

6.1 Operational Difference Between Parameters .....	6-2
6.1.1 Startup speed.....	6-2
6.1.2 When Target Speed/Startup Speed is Less Than 50Hz .....	6-2
6.1.3 Operation Patterns and Start Speed Settings.....	6-3
6.2 Other Characteristics .....	6-5
6.2.1 Backup of Positioning Memory .....	6-5
6.2.2 Activation of Each Operation .....	6-5
6.2.3 Operation When PLC Mode Changes From RUN To PROG.....	6-5

## 6.1 Operational Difference Between Parameters

### 6.1 Operational Difference Between Parameters

#### 6.1.1 Startup speed

- The startup speed is the parameter for setting the initial speed when starting each operation and the speed when finishing each operation.
- The startup speed is common to each control of the JOG operation, home return, E-point control, P-point control, C-point control and J-point control operations. It is set for each channel number (axis number).

#### ■ Setting method of startup speed

It is set in the “Parameter settings” dialog box of Configurator PMX.

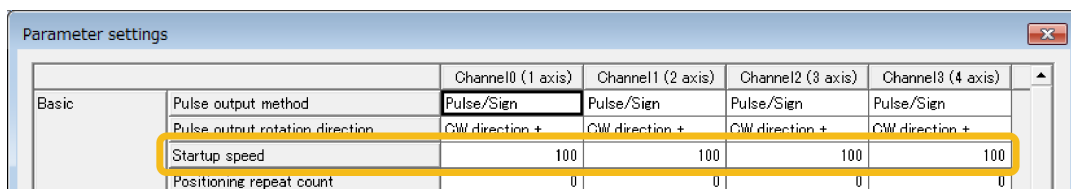

#### ■ Precautions when setting the startup speed

- The home return creep speed setting is not influenced by the startup speed in the home return operation.
- The target speed of each operation is not influenced by the startup speed. Each operation is performed at each specified target speed regardless of the setting of startup speed.

#### 6.1.2 When Target Speed/Startup Speed is Less Than 50Hz

#### ■ Operation

Operation pattern	Speed setting	Operation
E-point control	When target speed is less than 50 Hz	Operation is performed with the set target speed. The startup speed setting is invalid and the acceleration/deceleration operation is not performed.
	When startup speed is less than 50 Hz	When the target speed is set to 50 Hz or more, the startup speed is corrected to 50 Hz and the table operation is performed.
P-point control C-point control	When target speed is less than 50 Hz	The target speed is corrected to 50 Hz and the table operation is performed.
J-point control JOG operation	When startup speed is less than 50 Hz	The startup speed is corrected to 50 Hz and the table operation is performed.

6.1.3 Operation Patterns and Start Speed Settings

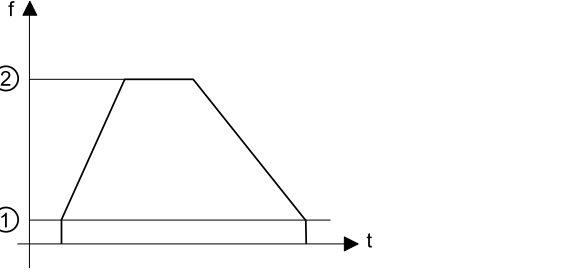
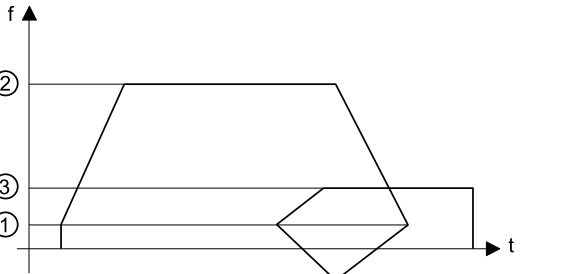
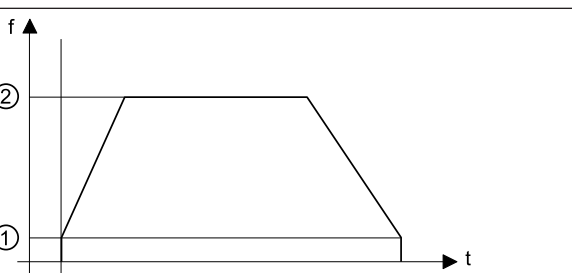
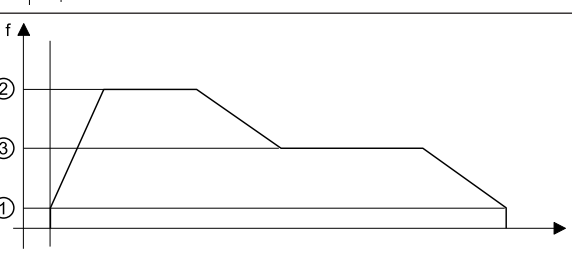
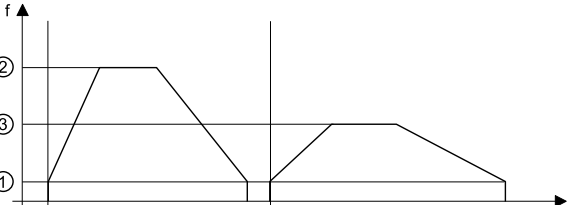
Operation pattern	Startup speed setting		
JOG operation		(1)	Startup speed
		(2)	Target speed
Home return		(1)	Startup speed
		(2)	Target speed
		(3)	Creep speed
E-point control		(1)	Startup speed
		(2)	Target speed
P-point control		(1)	Startup speed
		(2)	P-point target speed
		(3)	E-point target speed
C-point control		(1)	Startup speed
		(2)	C-point target speed
		(3)	E-point target speed

## 6.1 Operational Difference Between Parameters

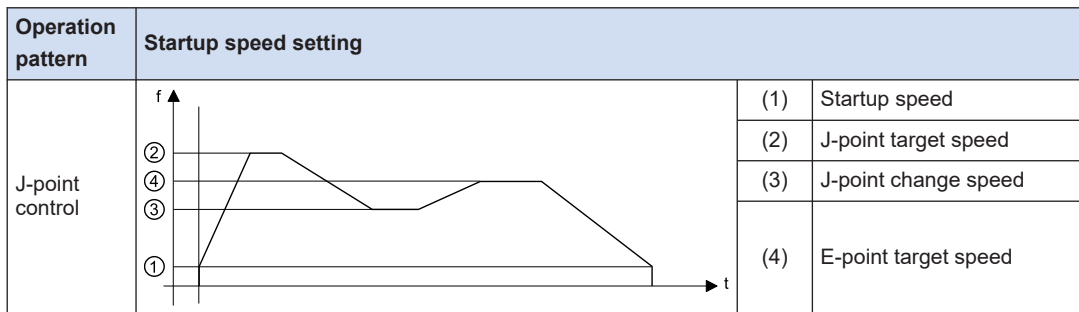



### 6.2 Other Characteristics

#### 6.2.1 Backup of Positioning Memory

- The positioning parameters and positioning table data set in the unit will be also held in the memories of the control unit when the control unit is powered off. They will be also held when the mode is switched from RUN to PROG.
- The elapsed value area (current value of position data) in the axis information area will be reset to zero when the unit is powered off. However, when the RUN mode is switched to PROG. mode, the latest value will be held.

#### 6.2.2 Activation of Each Operation

- When any of the JOG operation, home return and position control is activated, it does not transit to other operation even if an instruction to activate the other instruction turns on. Create a program to confirm the busy signals (X808 to X80B) allocated to each axis and to start instructions.
- Stop operations (system stop, emergency stop, limit stop, deceleration stop) have priority even during other operations. Each operation is executed by turning on the stop signal allocated to each axis.

#### 6.2.3 Operation When PLC Mode Changes From RUN To PROG.

- When the mode of CPU Unit changes from RUN to PROG. after starting the JOG operation, home return or position control (E-point control, P-point control, C-point control, J-point control), each operation stops.
- As well as the execution of the system stop, the unit stops the pulse output immediately.

(MEMO)

# 7 Instruction References

---

7.1 Table Setting Mode Control Instruction .....	7-2
7.1.1 F380 POSST (Positioning Table Start) .....	7-2
7.1.2 F381 JOGST (JOG Operation Start).....	7-3
7.1.3 F382 ORGST (Home Return Start).....	7-4
7.1.4 F383 MPOST (Positioning Simultaneous Start).....	7-5
7.1.5 F384 PTBLR (Positioning Parameter Read).....	7-6
7.1.6 F385 PTBLW (Positioning Parameter Write).....	7-8
7.2 FPsigma Compatible Instruction Mode Control Instruction.....	7-10
7.2.1 [F171(SPDH)] Pulse Output (Trapezoidal Control) .....	7-10
7.2.2 [F171(SPDH)] Pulse Output (Home Return).....	7-15
7.2.3 [F172(PSLH)] Pulse Output (JOG Operation).....	7-20
7.2.4 [F174(SP0H)] Pulse Output (Selectable Data Table Control Operation) .....	7-22
7.2.5 [F175(SPSH)] Pulse Output (Linear Interpolation).....	7-27

## 7.1 Table Setting Mode Control Instruction

### 7.1 Table Setting Mode Control Instruction

#### 7.1.1 F380 POSST (Positioning Table Start)

Starts the positioning operation according to the data specified in the positioning memory (positioning table area). This instruction is used to start the E point control, P point control, C point control, J point control or linear interpolation control.

##### ■ Instruction format

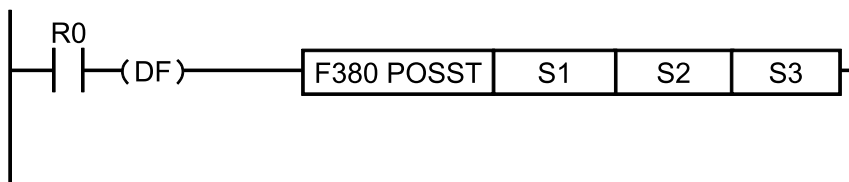

##### ■ Operand

Operand	Settings	Setting range
S1	Channel number to start the positioning operation (Unsigned 16-bit integer)	0 to 3
S2	Table number to start (Unsigned 16-bit integer)	1 to 20
S3	Output assignment	0 (Pulse output), 1 (Calculation only)

##### ■ Memory area type that can be specified

Operand	WX	WY	WR	WL	SV	EV	DT	LD	I	Constant		Index modifier
										K	H	
S1	•	•	•	•	•	•	•	•	•	•	•	•
S2	•	•	•	•	•	•	•	•	•	•	•	•
S3	•	•	•	•	•	•	•	•	•	•	•	•

##### ■ Outline of operation

- Starts the positioning operation according to the data specified in the positioning memory (positioning table area).
- When Calculation only is specified for [S3], only the table calculation is executed. When starting the positioning operation for the same channel and the same table from the next scan after executing the calculation, the startup time of the positioning control is reduced.

##### ■ Precautions during programming

- If an operand is an out-of-range value, an operation error occurs.
- The stop operation has priority when the conditions of system stop, emergency stop, limit stop and deceleration stop are satisfied.
- An operation error occurs when the system register of a specified channel is other than "Pulse output [Table operation]".

## 7.1 Table Setting Mode Control Instruction

- A self-diagnostic error (positioning operation error) occurs when the set value or the value of the positioning memory (axis setting area) is abnormal.
- When the channel to be started has been already operating, the positioning control does not start and it terminates.

### ■ Flag operations

Name	Explanation
R9007 R9008 (ER)	When the area is exceeded at the time of index modification
	When the [S1] value is outside the set range
	When the [S2] value is outside the set range
	When the pulse output (table operation) has not been set in the system register

### 7.1.2 F381 JOGST (JOG Operation Start)

Starts the JOG operation according to the parameters specified in the positioning memory (axis setting area).

#### ■ Instruction format

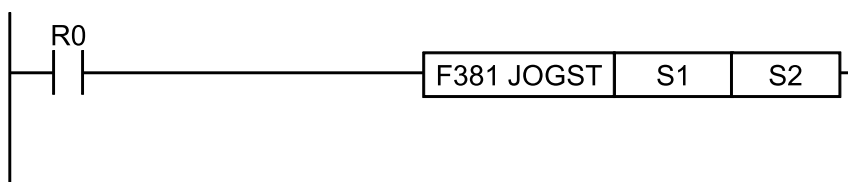

#### ■ Operand

Operand	Settings	Setting range
S1	Channel number to start the JOG operation (Unsigned 16-bit integer)	0 to 3
S2	Operating direction (Unsigned 16-bit integer)	0 (Forward), 1 (Reverse)

#### ■ Memory area type that can be specified

Operand	WX	WY	WR	WL	SV	EV	DT	LD	I	Constant		Index modifier
										K	H	
S1	•	•	•	•	•	•	•	•	•	•	•	•
S2	•	•	•	•	•	•	•	•	•	•	•	•

#### ■ Outline of operation

- Executes the JOG operation according to the JOG operation parameters specified in the positioning memory (axis setting area). While the execution condition is valid, the JOG operation continues.

## 7.1 Table Setting Mode Control Instruction

- The target speed can be changed by rewriting the positioning parameter area with a user program. The change is executed after it becomes a constant speed.

### ■ Precautions during programming

- If an operand is an out-of-range value, an operation error occurs.
- The stop operation has priority when the conditions of system stop, emergency stop, limit stop and deceleration stop are satisfied.
- An operation error occurs when the system register of a specified channel is other than “Pulse output [Table operation]”.
- A self-diagnostic error (positioning operation error) occurs when the set value or the value of the positioning memory (axis setting area) is abnormal.
- The JOG operation needs to be stopped for switching between the forward rotation and reverse rotation.
- In case of changing a speed, when the target speed after the change is an out-of-range value, the speed change is not executed and the operation continues.

### ■ Flag operations

Name	Explanation
R9007 R9008 (ER)	When the area is exceeded at the time of index modification
	When the [S1] value is outside the set range
	When the [S2] value is outside the set range
	When the pulse output (table operation) has not been set in the system register

### 7.1.3 F382 ORGST (Home Return Start)

Starts the home return operation according to the parameters specified in the positioning memory (axis setting area).

#### ■ Instruction format

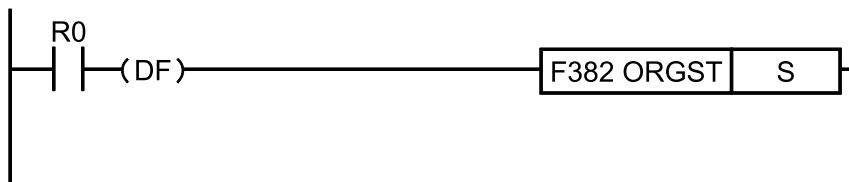

#### ■ Operand

Operand	Settings	Setting range
S	Channel number to start the home return (Unsigned 16-bit integer)	0 to 3

### ■ Memory area type that can be specified

Operand	WX	WY	WR	WL	SV	EV	DT	LD	I	Constant		Index modifier
										K	H	
S	•	•	•	•	•	•	•	•	•	•	•	•

### ■ Outline of operation

- Starts the home return operation according to the home return parameters specified in the positioning memory (axis setting area).

### ■ Precautions during programming

- If an operand is an out-of-range value, an operation error occurs.
- The stop operation has priority when the conditions of system stop, emergency stop, limit stop and deceleration stop are satisfied.
- An operation error occurs when the system register of a specified channel is other than "Pulse output [Table operation]".

### ■ Flag operations

Name	Explanation
R9007	When the area is exceeded at the time of index modification
R9008	When the value of [S] exceeds the set range
(ER)	When the pulse output (table operation) has not been set in the system register

## 7.1.4 F383 MPOST (Positioning Simultaneous Start)

Starts the positioning tables for multiple axes specified on Configurator PMX. The tables of the E point control, P point control and C point control can be started.

### ■ Instruction format

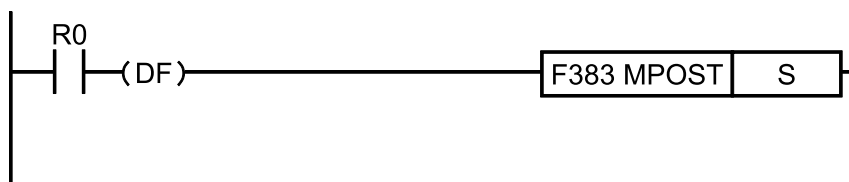

### ■ Operand

Operand	Settings
S	The starting area of the data register storing the data table numbers (unsigned 16-bit integer) to be started simultaneously

## 7.1 Table Setting Mode Control Instruction

### ■ Memory area type that can be specified

Operand	WX	WY	WR	WL	SV	EV	DT	LD	I	Constant		Index modifier
										K	H	
S	—	—	—	—	—	—	•	—	—	—	—	•

### ■ Outline of operation

- Starts the positioning table numbers of the channels specified in the area starting with [S] simultaneously.
- Positioning tables that can be specified are those for the single-axis control only.
- Table numbers are specified in the range of 0 to 20. In the case of 0, the table is not executed simultaneously with other tables.

S	Output specification (0: Pulse output, 1: Calculation only)
S+1	CH0 Positioning table number (0 to 20)
S+2	CH1 Positioning table number (0 to 20)
S+3	CH2 Positioning table number (0 to 20)
S+4	CH3 Positioning table number (0 to 20)

### ■ Precautions during programming

- If an operand is an out-of-range value, an operation error occurs.
- The stop operation has priority when the conditions of system stop, emergency stop, limit stop and deceleration stop are satisfied.
- An operation error occurs when the system register of a specified channel is other than “Pulse output [Table operation]”.
- Only when all the specified channels can be started, they are executed simultaneously. When the BUSY flag of any channel is on, tables are not started simultaneously and the process is terminated.
- Use F380 POSST instruction to start linear interpolation. When the table of the interpolation axis control has been specified with F383 MPOST instruction, a self-diagnostic error (positioning operation error) occurs.

### ■ Flag operations

Name	Explanation
R9007 R9008 (ER)	When the area is exceeded at the time of index modification
	When the [S] data table exceeds the area
	When the value of [S] exceeds the set range
	When the pulse output (table operation) has not been set in the system register

#### 7.1.5 F384 PTBLR (Positioning Parameter Read)

Reads the positioning parameter data stored in the positioning memory of the unit to the operation memory area.



### ■ Instruction format



### ■ Operand

Operand	Settings			
S1	Specification of channel numbers and positioning memory area			
	<table border="1"> <tr> <td>(Higher 8 bits) channel no.:</td> <td>H0 to H3</td> </tr> <tr> <td>(Lower 8 bits) Area no.:</td> <td>H00 (Common area), H01 (Axis information area), H02 (Axis setting area), H03 (Positioning table area)</td> </tr> </table>	(Higher 8 bits) channel no.:	H0 to H3	(Lower 8 bits) Area no.:
(Higher 8 bits) channel no.:	H0 to H3			
(Lower 8 bits) Area no.:	H00 (Common area), H01 (Axis information area), H02 (Axis setting area), H03 (Positioning table area)			
S2	Starting address of the positioning memory storing read data (offset address) or operation memory area storing the starting address			
n	No. of read words			
D	Operation memory storing read data			

(Note 1) When reading the common area, the setting of channel numbers is invalid.

(Note 2) The operand S1 is specified using a combination of hexadecimal numbers. For the axis information area of channel number 3, specify H301.

### ■ Memory area type that can be specified

Operand	WX	WY	WR	WL	SV	EV	DT	LD	I	Constant		Index modifier
										K	H	
S1	•	•	•	•	•	•	•	•	•	•	•	•
S2	•	•	•	•	•	•	•	•	•	•	•	•
n	•	•	•	•	•	•	•	•	•	•	•	•
D	—	•	•	•	•	•	•	•	•	—	—	•

### ■ Outline of operation

- Reads [n] words of the data stored in the positioning memory starting with [S2], and stores it in the operation memory area starting with [D].
- Channel numbers and the type of positioning memory is specified by [S1].

### ■ Precautions during programming

- If an operand is an out-of-range value, an operation error occurs.

### ■ Flag operations

Name	Explanation
R9007 R9008	When the [S1] value is outside the set range

## 7.1 Table Setting Mode Control Instruction

Name	Explanation
(ER)	When the [S2] value exceeds the positioning area specified by [S1]
	When the no. of read words is "0"
	When the read data exceeds the area of [D]

### 7.1.6 F385 PTBLW (Positioning Parameter Write)

This instruction is used to write positioning parameters and positioning table data with user programs.

#### ■ Instruction format

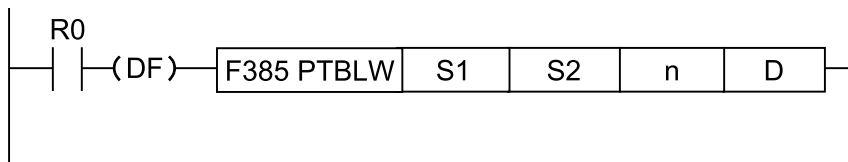

#### ■ Operand

Operand	Settings			
S1	Specification of channel numbers and positioning memory area			
	<table border="1"> <tr> <td>(Higher 8 bits) channel no.:</td> <td>H0 to H3 (Not save in FROM), H80 to H83 (Save in FROM)</td> </tr> <tr> <td>(Lower 8 bits) Area no.:</td> <td>H00 (Common area), H01 (Axis information area), H02 (Axis setting area), H03 (Positioning table area)</td> </tr> </table>	(Higher 8 bits) channel no.:	H0 to H3 (Not save in FROM), H80 to H83 (Save in FROM)	(Lower 8 bits) Area no.:
(Higher 8 bits) channel no.:	H0 to H3 (Not save in FROM), H80 to H83 (Save in FROM)			
(Lower 8 bits) Area no.:	H00 (Common area), H01 (Axis information area), H02 (Axis setting area), H03 (Positioning table area)			
S2	Operation memory area storing written data			
n	No. of written data			
D	Starting address of the positioning memory storing data (offset address) or operation memory area storing the starting address			

(Note 1) When writing data to the common area, the setting of channel numbers is invalid.

(Note 2) The operand S1 is specified using a combination of hexadecimal numbers. For the axis setting area of channel number 3, specify H302.

#### ■ Memory area type that can be specified

Operand	WX	WY	WR	WL	SV	EV	DT	LD	I	Constant		Index modifier
										K	H	
S1	•	•	•	•	•	•	•	•	•	•	•	•
S2	•	•	•	•	•	•	•	•	•	-	-	•
n	•	•	•	•	•	•	•	•	•	•	•	•
D	•	•	•	•	•	•	•	•	•	•	•	•

### ■ Outline of operation

- Reads [n] words of the data stored in the area starting with [S2], and stores it in the positioning memory area starting with [D].
- Channel numbers and the type of positioning memory are specified by [S1].

### ■ Precautions during programming

- If an operand is an out-of-range value, an operation error occurs.
- When specifying [H80 to H83 (Save in FROM)] for the higher 8 bits of operand [S1] (the most significant bit is 1), specified data is written into the F-ROM of the control unit. Writing to F-ROM can be performed up to 10000 times. We recommend using differential execution to prevent the writing from being executed continuously.

### ■ Flag operations

Name	Explanation
R9007 R9008 (ER)	When the [S1] value is outside the set range
	When the [D] value exceeds the positioning area specified by [S1]
	When the range of the data written from [D] exceeds the positioning area specified by [S1]
	When the no. of written data is "0"
	When the written data exceeds the area of [S2]

## 7.2 FPsigma Compatible Instruction Mode Control Instruction

### 7.2 FPsigma Compatible Instruction Mode Control Instruction

#### 7.2.1 [F171(SPDH)] Pulse Output (Trapezoidal Control)

This instruction outputs pulses from a specified pulse output channel according to specified parameters.

##### ■ Instruction format

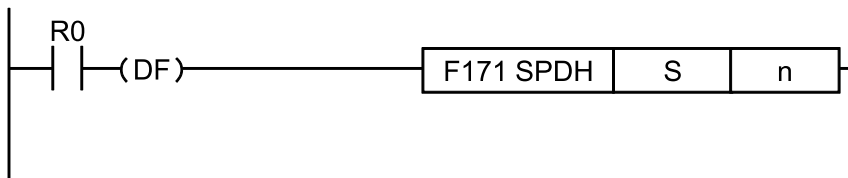

##### ■ Operand

Operand	Settings
S	Starting number of the area in which data tables are registered
n	Target channel for pulse output

##### ■ Memory area type that can be specified

Operand	WX	WY	WR	WL	SV	EV	DT	LD	I	Constant		Index modifier
										K	H	
S	-	-	-	-	-	-	•	-	-	-	-	•
n	-	-	-	-	-	-	-	-	-	•	•	-

##### ■ Outline of operation

- Outputs pulses from a specified channel when a corresponding control active flag is OFF and the execution condition is ON.
- The control code, initial speed, maximum speed, acceleration/deceleration time, and target value are specified by creating data tables [S] to [S+11] described on the next page using a user program.
- Switches the frequency from the initial speed to the maximum speed in the specified acceleration/deceleration time. At the time of deceleration, switches the frequency with the same inclination as that for acceleration.
- For setting the frequency to 50 kHz or more, specify the duty of 1/4 (25%).

##### ■ Operation mode

###### Incremental <Relative value control>

Outputs the pulses set with the target value.

## 7.2 FPsigma Compatible Instruction Mode Control Instruction

	Selection			
Target value	CW/CCW	PLS+SIGN Forward OFF Reverse ON	PLS+SIGN Forward ON Reverse OFF	Elapsed value
When plus	Pulse output from CW	Pulse output when direction output is OFF	Pulse output when direction output is ON	Addition
When minus	Pulse output from CCW	Pulse output when direction output is ON	Pulse output when direction output is OFF	Subtraction

### Absolute <Absolute value control>

Outputs the pulses of the difference between the set target value and current value.

	Selection			
Target value	CW/CCW	PLS+SIGN Forward OFF Reverse ON	PLS+SIGN Forward ON Reverse OFF	Elapsed value
When target value is larger than current value	Pulse output from CW	Pulse output when direction output is OFF	Pulse output when direction output is ON	Addition
When target value is smaller than current value	Pulse output from CCW	Pulse output when direction output is ON	Pulse output when direction output is OFF	Subtraction

### ■ Data table settings

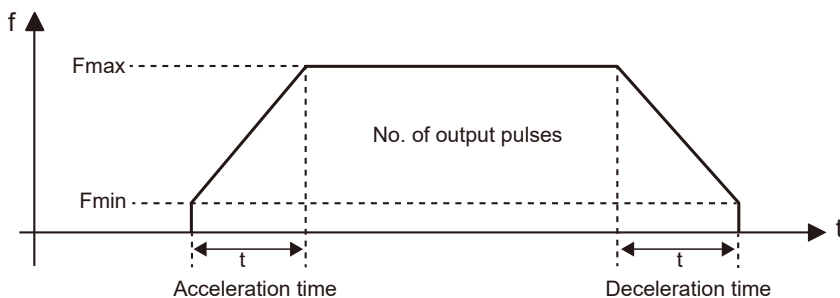

## 7.2 FPsigma Compatible Instruction Mode Control Instruction

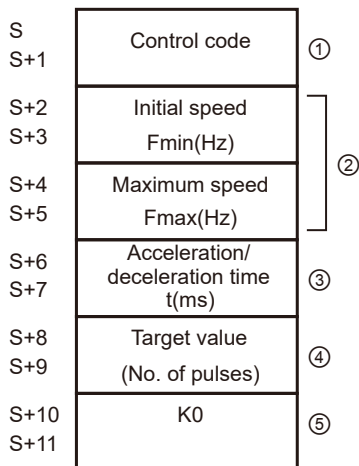

	Operand	Settings	Description									
(1)	S, S+1	Control code	<p>Specify the control code by setting the H constant.</p> <p style="text-align: right;">H <input type="checkbox"/><input type="checkbox"/><input type="checkbox"/><input type="checkbox"/><input type="checkbox"/><input type="checkbox"/><input type="checkbox"/><input type="checkbox"/></p> <p>0: Fixed</p> <p>Acceleration/deceleration time setting 0: Normal 1: Acceleration/deceleration time priority</p> <p>Output setting 0: Pulse output 1: Calculate only</p> <p>Acceleration/deceleration steps 0: 30 steps 1: 60 steps</p> <p>Duty (on width) 0: Duty 1/2 (50%) 1: Duty 1/4 (25%)</p> <p>Frequency range Not used</p> <p>Operation mode and output method 0: Incremental CW/CCW 2: Incremental PLS+SIGN (forward off/reverse on) 3: Incremental PLS+SIGN (forward on/reverse off) 10: Absolute CW/CCW 12: Absolute PLS+SIGN (forward off/reverse on) 13: Absolute PLS+SIGN (forward on/reverse off)</p>									
(2)	S+2, S+3	Initial speed Fmin(Hz)	<p>The setting range of the settable maximum speed varies according to the setting of the initial speed as shown in the table below.</p> <table border="1"> <thead> <tr> <th>Range</th> <th>Initial speed</th> <th>Maximum speed</th> </tr> </thead> <tbody> <tr> <td>Low speed</td> <td>K1 to K49 (1 to 49Hz)</td> <td>Initial speed to K22000 (to 22kHz)</td> </tr> <tr> <td>High speed</td> <td>K50 to K100000 (50Hz to 100kHz)</td> <td>Initial speed to K100000 (to 100kHz)</td> </tr> </tbody> </table>	Range	Initial speed	Maximum speed	Low speed	K1 to K49 (1 to 49Hz)	Initial speed to K22000 (to 22kHz)	High speed	K50 to K100000 (50Hz to 100kHz)	Initial speed to K100000 (to 100kHz)
	Range	Initial speed		Maximum speed								
	Low speed	K1 to K49 (1 to 49Hz)		Initial speed to K22000 (to 22kHz)								
High speed	K50 to K100000 (50Hz to 100kHz)	Initial speed to K100000 (to 100kHz)										
S+4, S+5	Maximum speed Fmax(Hz)											

## 7.2 FPsigma Compatible Instruction Mode Control Instruction

	Operand	Settings	Description
			(Note 1) If the initial speed is set to a value less than K1 or if the maximum speed is set to a value exceeding K100000, an operation error occurs. (Note 2) If the initial speed is set to the low-speed range and if the maximum speed is set to a value exceeding K22000, an operation error occurs.
(3)	S+6, S+7	Acceleration/ deceleration time t(ms)	Acceleration/deceleration time (ms)  With 30 steps: K30 to K32760 (Specify in 30 ms increments.)  With 60 steps: K60 to K32760 (Specify in 60 ms increments.)  (Note 1) When the time is not specified in 30 ms nor 60 ms increments, it will be automatically corrected to the multiple value (larger value) of 30 ms or 60 ms.
(4)	S+8, S+9	Target value	Target value K-2147483648 to K2147483647 pulses
(5)	S+10, S+11	K0	Set K0 to the last two words of the data table.

### ■ Example of program

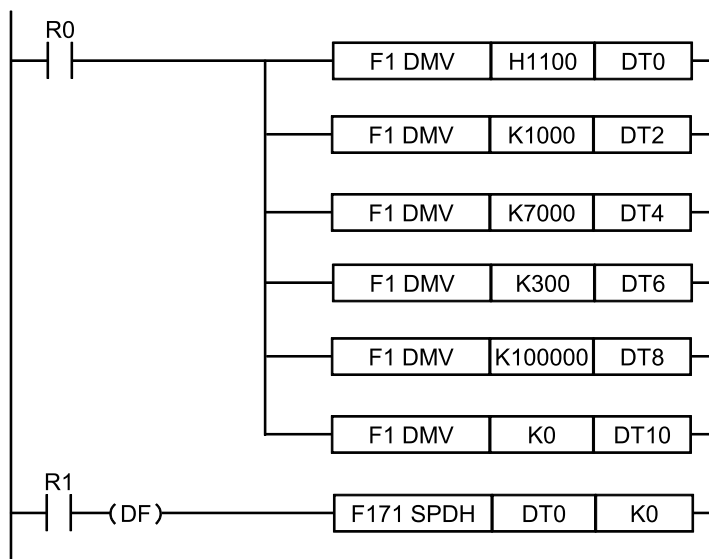

## 7.2 FPsigma Compatible Instruction Mode Control Instruction

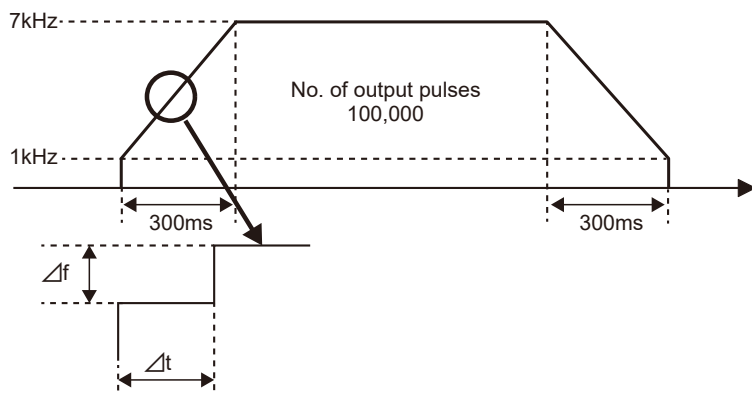

- With 30 steps
  - $\Delta f = (7000-1000)/30 \text{ steps} = 200 \text{ (Hz)}$
  - $\Delta t = 300 \text{ ms}/30 \text{ steps} = 10 \text{ ms}$
- With 60 steps
  - $\Delta f = (7000-1000)/60 \text{ steps} = 100 \text{ (Hz)}$
  - $\Delta t = 300 \text{ ms}/60 \text{ steps} = 5 \text{ ms}$

### ■ Regarding the specification of acceleration/deceleration time

For specifying acceleration/deceleration time, No. of steps and initial speed, set the value to be calculated by the formula below. Specify acceleration/deceleration time in 30 ms increments with 30 steps, and in 60 ms increments with 60 steps. When the time is not specified in 30 ms nor 60 ms increments, it will be automatically corrected to the multiple values (larger value) of 30 ms or 60 ms.

Acceleration/deceleration time  $t$  [ms] (No. of steps  $\times$  1000)/Initial speed  $f_0$  [Hz]

- When "Acceleration/deceleration time priority" is specified for the control code, the initial speed is corrected according to the time.
 

The corrected speed is stored in the correction speed area of initial speed of special data registers (from DT90400).

(Example): When the initial speed is 10 Hz, and acceleration/deceleration time is 1 msec, the initial speed is corrected to 1000 Hz.
- When the corrected initial speed exceeds the maximum speed, the initial speed is corrected to the maximum speed.
 

(Example): When the initial speed is 10 Hz, the maximum speed is 500 Hz, acceleration/deceleration time is 1 msec, and acceleration/deceleration time priority is specified, it takes 100 msec for outputting one pulse at the initial speed and it exceeds 1 msec of acceleration/deceleration time.

Although the initial speed is corrected to 1000 Hz as "Acceleration/deceleration time priority" is specified, it is corrected to 500 Hz because it exceeds the maximum speed.

### ■ Supplement to pulse output operation

When outputting pulses with the PLS+SIGN (direction output) method, pulses will be output approx. 300 $\mu$ s later after the output of direction signal (SIGN). (The characteristics of a motor driver are considered.)



### ■ Precautions during programming

- When describing the same channel in both the normal program and the interrupt program, be sure to program not to execute them simultaneously.
- This instruction cannot be executed when a control flag corresponding to each channel is on.
- For the FP0H mode, select "Pulse output" for the channel setting corresponding to the system register no. 402.
- For the FPsigma mode, select "Do not use high-speed counter" for the channel setting corresponding to the system register nos. 400 and 401.
- By performing the rewriting during RUN while outputting pulses, more pulses than the setting may be output.

### **i** Info.

- For details of the allocations of I/O and flags, refer to "12.2.2 When Using Pulse Output Function (FPsigma Compatible Instruction Mode)".
- For details of the FP mode, refer to "11 FPsigma Mode".

### 7.2.2 [F171(SPDH)] Pulse Output (Home Return)

This instruction outputs pulses from a specified pulse output channel according to specified parameters.

### ■ Instruction format

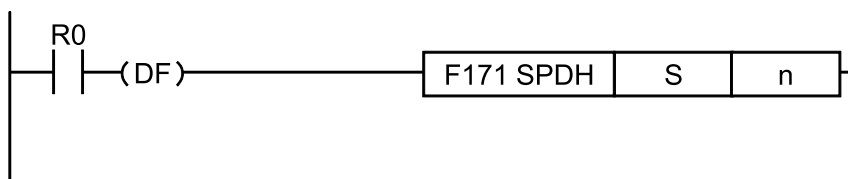

### ■ Operand

Operand	Settings
S	Starting number of the area in which data tables are registered
n	Target channel for pulse output

### ■ Memory area type that can be specified

Operand	WX	WY	WR	WL	SV	EV	DT	LD	I	Constant		Index modifier
										K	H	
S	-	-	-	-	-	-	•	-	-	-	-	•
n	-	-	-	-	-	-	-	-	-	•	•	-

### ■ Outline of operation

- Outputs pulses from a specified channel when a corresponding control active flag is OFF and the execution condition is ON.

## 7.2 FPsigma Compatible Instruction Mode Control Instruction

- The control code, initial speed, maximum speed, acceleration/deceleration time, and deviation counter clear signal are specified by creating data table described on the next page using a user program.
- Switches the frequency from the initial speed to the maximum speed in the specified acceleration/deceleration time. At the time of deceleration, switches the frequency with the same inclination as that for acceleration.
- For setting the frequency to 50 kHz or more, specify the duty of 1/4 (25%).

### ■ Explanation of operation mode

#### Home return

The pulses are continuously output until the home input (X2 or X5) is enabled. To shift to deceleration operation when detecting the near home, turn the corresponding bit of special data register DT90052 to OFF ON OFF by the near home input. The value in the elapsed value area during the home return operation differs from the current value.

#### Home return mode I (Home return by home input only)

When the home input is enabled, the pulse output will stop. Set the control code (low byte) on the next page to H20 to H27.

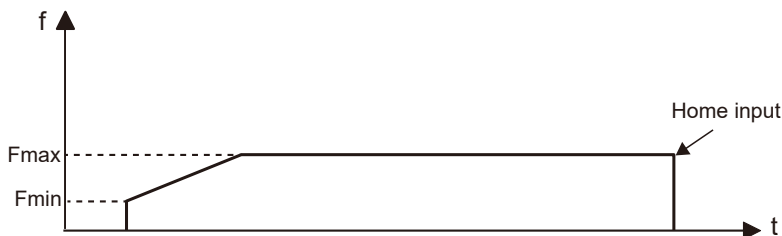

#### Home return mode II (Home return by near home input and home input)

When the near home input is enabled, deceleration will be performed, and the pulse output will stop after the home input. The operation varies according to the setting of the control code (low byte) described on the next page to H30 to H37.

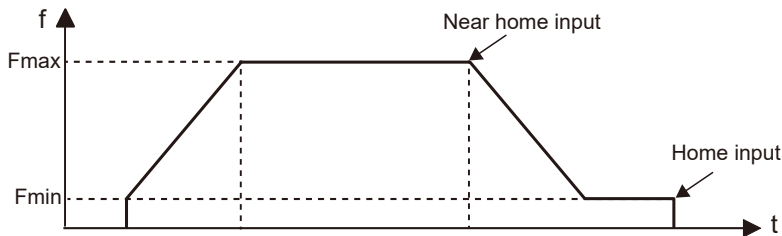

## 7.2 FPsigma Compatible Instruction Mode Control Instruction

### ■ Data table settings

S	Control code	①
S+1		
S+2	Initial speed Fmin(Hz)	②
S+3		
S+4	Maximum speed Fmax(Hz)	②
S+5		
S+6	Acceleration/ deceleration time t(ms)	③
S+7		
S+8	Deviation counter clear signal output time tr(ms)	④
S+9		

	Operand	Settings	Description
(1)	S, S+1	Control code	<p>Specify the control code by setting the H constant.</p> <p style="text-align: right;">H <input type="checkbox"/><input type="checkbox"/><input type="checkbox"/><input type="checkbox"/><input type="checkbox"/><input type="checkbox"/><input type="checkbox"/><input type="checkbox"/><input type="checkbox"/><input type="checkbox"/><input type="checkbox"/></p> <p>0: Fixed</p> <p>Acceleration/deceleration time setting 0: Normal 1: Acceleration/deceleration time priority</p> <p>Output setting 0: Pulse output 1: Calculate only</p> <p>Acceleration/deceleration steps 0: 30 steps 1: 60 steps</p> <p>Duty (on width) 0: Duty 1/2 (50%) 1: Duty 1/4 (25%)</p> <p>Frequency range Not used</p> <p>Operation mode and output method 20: Homing mode 1 CW 21: Homing mode 1 CCW 22: Homing mode 1 Directional output off 23: Homing mode 1 Directional output on 24: Homing mode 1 CW + deviation counter reset 25: Homing mode 1 CCW + deviation counter reset 26: Homing mode 1 Direction output off + deviation counter reset 27: Homing mode 1 Direction output on + deviation counter reset 30: Homing mode 2 CW 31: Homing mode 2 CCW 32: Homing mode 2 Directional output off 33: Homing mode 2 Direction output on 34: Homing mode 2 CW + deviation counter reset 35: Homing mode 2 CCW + deviation counter reset 36: Homing mode 2 Direction output off + deviation counter reset 37: Homing mode 2 Direction output on + deviation counter reset</p>
(2)	S+2, S+3	Initial speed Fmin(Hz)	The setting range of the settable maximum speed varies according to the setting of the initial speed as shown in the table below.
	S+4, S+5	Maximum speed Fmax(Hz)	

## 7.2 FPsigma Compatible Instruction Mode Control Instruction

	Operand	Settings	Description		
			Range	Initial speed	Maximum speed
			Low speed	K1 to K49 (1 to 49Hz)	Initial speed to K22000 (to 22kHz)
			High speed	K50 to K100000 (50Hz to 100kHz)	Initial speed to (to 100kHz)
			(Note 1) If the initial speed is set to a value less than K1 or if the maximum speed is set to a value exceeding K100000, an operation error occurs.		
			(Note 2) If the initial speed is set to the low-speed range and if the maximum speed is set to a value exceeding K22000, an operation error occurs.		
(3)	S+6, S+7	Acceleration/ deceleration time t(ms)	Acceleration/deceleration time (ms) With 30 steps: K30 to K32760 With 60 steps: K60 to K32760		
(4)	S+8, S+9	Deviation counter clear signal output time tr(ms)	Set the output time of the deviation counter clear signal. 0.5 ms to 100 ms [K0 to K100] Setting value + error (0.5 ms or less) When this signal is not used or the time is set to less than 0.5 ms, specify K0.		

### ■ Example of program

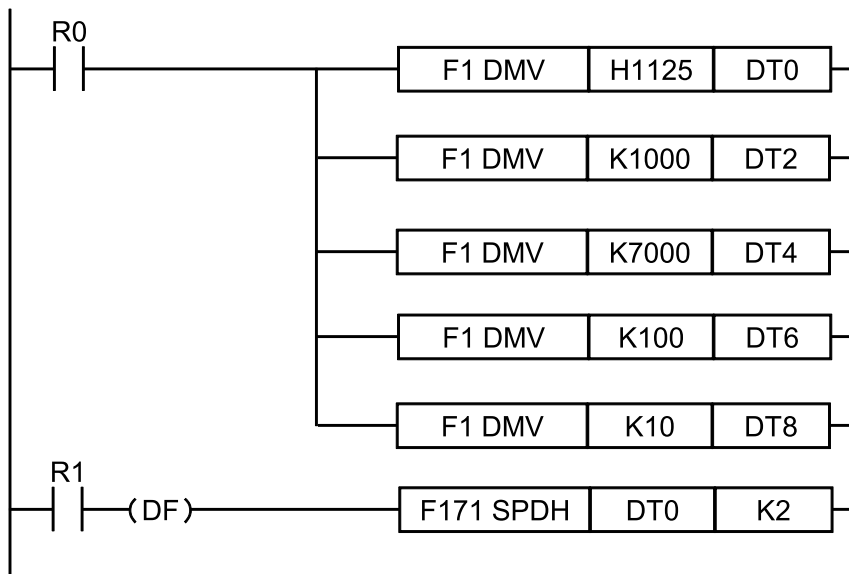

### ■ Regarding the specification of acceleration/deceleration time

For specifying acceleration/deceleration time, No. of steps and initial speed, set the value to be calculated by the formula below. Specify acceleration/deceleration time in 30 ms increments with 30 steps, and in 60 ms increments with 60 steps. When the time is not specified in 30 ms nor 60 ms increments, it will be automatically corrected to the multiple values (larger value) of 30 ms or 60 ms.

Acceleration/deceleration time  $t$ [ms] (No. of steps x 1000)/Initial speed  $f_0$ [Hz]

- When "Acceleration/deceleration time priority" is specified for the control code, the initial speed is corrected according to the time.  
The corrected speed is stored in the correction speed area of initial speed of special data registers (from DT90400).  
(Example): When the initial speed is 10 Hz, and acceleration/deceleration time is 1 msec, the initial speed is corrected to 1000 Hz.
- When the corrected initial speed exceeds the maximum speed, the initial speed is corrected to the maximum speed.  
(Example): When the initial speed is 10 Hz, the maximum speed is 500 Hz, acceleration/deceleration time is 1 msec, and acceleration/deceleration time priority is specified, it takes 100 msec for outputting one pulse at the initial speed and it exceeds 1 msec of acceleration/deceleration time.  
Although the initial speed is corrected to 1000 Hz as "Acceleration/deceleration time priority" is specified, it is corrected to 500 Hz because it exceeds the maximum speed.

### ■ Supplement to pulse output operation

When outputting pulses with the PLS+SIGN (direction output) method, pulses will be output approx. 300 $\mu$ s later after the output of direction signal (SIGN). (The characteristics of a motor driver are considered.)

### ■ Precautions during programming

- When the control code (low byte) is H20 to H27 (home return mode I), the home input is enabled even after the near home input, the completion of deceleration, or in the middle of deceleration.
- When the control code (low byte) is H30 to H37 (home return mode II), the home input is enabled only after the near home input and the completion of deceleration up to the value of initial speed.
- Even when the home input is enabled, the pulse output starts by the execution of this instruction.
- When the near home input is enabled during acceleration, the deceleration operation will start.
- When describing the same channel in both the normal program and the interrupt program, be sure to program not to execute them simultaneously.
- This instruction cannot be executed when a control flag corresponding to each channel is on.
- For the FP0H mode, select "Pulse output" for the channel setting corresponding to the system register no. 402.
- For the FPsigma mode, select "Do not use high-speed counter" for the channel setting corresponding to the system register nos. 400 and 401.
- By performing the rewriting during RUN while outputting pulses, more pulses than the setting may be output.
- For performing the software reset, disabling the counting, stopping the pulse output or near home processing, refer to the F0(MV) instruction, pulse output control.

### Info.

- For the details of the allocations of I/O and flags, refer to "[12.2.2 When Using Pulse Output Function \(FPsigma Compatible Instruction Mode\)](#)".
- For details of the FPsigma mode, refer to "[11 FPsigma Mode](#)".

## 7.2 FPsigma Compatible Instruction Mode Control Instruction

### 7.2.3 [F172(PSLH)] Pulse Output (JOG Operation)

Outputs the pulse of a specified parameter from a specified channel.

#### ■ Instruction format

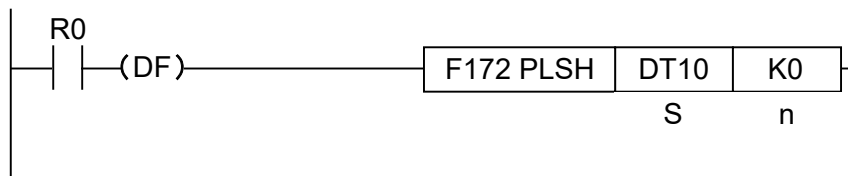

#### ■ Operand

Operand	Settings
S	Starting number of the area in which data tables are registered
n	Target channel for pulse output

#### ■ Memory area type that can be specified

Operand	WX	WY	WR	WL	SV	EV	DT	LD	I	Constant		Index modifier
										K	H	
S	-	-	-	-	-	-	•	-	-	-	-	•
n	-	-	-	-	-	-	-	-	-	•	•	-

#### ■ Outline of operation

- Outputs pulses from a specified channel when a corresponding control active flag is OFF and the execution condition is ON. The output is performed when the trigger (execution condition) is on.
- By specifying the addition counting or subtraction counting mode for the control code, it can be used for the instruction for activating JOG operation.
- The frequency can be changed in each scan, or the target value can be changed asynchronously. However, the control code cannot be changed during the execution of an instruction.
- For setting the frequency to 50 kHz or more, specify the duty of 1/4 (25%).

#### ■ Data table settings

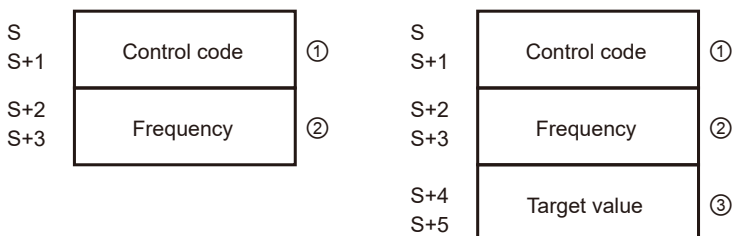

	Operand	Settings	Description
(1)	S, S+1	Control code	Specify the control code by setting the H constant.

## 7.2 FPsigma Compatible Instruction Mode Control Instruction

Operand	Settings	Description									
		<div style="text-align: right;">           H <input type="checkbox"/> <input type="checkbox"/> <input type="checkbox"/> <input type="checkbox"/> <input type="checkbox"/> <input type="checkbox"/> <input type="checkbox"/> <input type="checkbox"/> </div> <p>0: Fixed</p> <p>Acceleration/deceleration steps            0: Mode with no target value            1: Target value match stop mode</p> <p>Duty (on width)            0: Duty 1/2 (50%)            1: Duty 1/4 (25%)</p> <p>Frequency range            Not used</p> <p>Output method            00: No counting CW            01: No counting CCW            10: Addition counting CW            12: Addition counting Directional output off            13: Addition counting Directional output on            21: Subtraction counting CW            22: Subtraction counting Directional output off            23: Subtraction counting Directional output on</p>									
(2)	S+2, S+3	Frequency <table border="1" style="width: 100%; margin-top: 10px;"> <thead> <tr> <th>Range</th> <th>Initial speed</th> <th>Change the speed setting range</th> </tr> </thead> <tbody> <tr> <td>Low speed</td> <td>K1 to K49 (1 to 49Hz)</td> <td>K1 to K22000 (1Hz to 22kHz)</td> </tr> <tr> <td>High speed</td> <td>K50 to K100000 (50Hz to 100kHz)</td> <td>K50 to K100000 (50Hz to 100kHz)</td> </tr> </tbody> </table> <p>(Note 1) If the initial speed is set to a value less than K1 or exceeding K100000, an operation error occurs.</p> <p>(Note 2) When the initial speed is set to the low-speed range, if the frequency is set to a value less than K1, it is corrected to 1 Hz and, if the frequency is set to a value exceeding K22000, it is corrected to 22 KHz.</p> <p>(Note 3) When the initial speed is set to the high-speed range, if the frequency is set to a value less than K50, it is corrected to 50 Hz and, if the frequency is set to a value exceeding K100000, it is corrected to 100 KHz.</p>	Range	Initial speed	Change the speed setting range	Low speed	K1 to K49 (1 to 49Hz)	K1 to K22000 (1Hz to 22kHz)	High speed	K50 to K100000 (50Hz to 100kHz)	K50 to K100000 (50Hz to 100kHz)
Range	Initial speed	Change the speed setting range									
Low speed	K1 to K49 (1 to 49Hz)	K1 to K22000 (1Hz to 22kHz)									
High speed	K50 to K100000 (50Hz to 100kHz)	K50 to K100000 (50Hz to 100kHz)									
(3)	S+4, S+5	Target value <p>Target value (absolute value)            It is used when setting the target value match stop mode. (Absolute only)</p> <p>Specify the target value in the following range. If a value outside of the range is specified, the number of pulses different from the specified value is output. When specifying the no counting mode, the target value setting is ignored.</p> <table border="1" style="width: 100%; margin-top: 10px;"> <thead> <tr> <th>Output method</th> <th>Settable range of target value</th> </tr> </thead> <tbody> <tr> <td>Addition counting</td> <td>Values larger than the current value</td> </tr> </tbody> </table>	Output method	Settable range of target value	Addition counting	Values larger than the current value					
Output method	Settable range of target value										
Addition counting	Values larger than the current value										

## 7.2 FPsigma Compatible Instruction Mode Control Instruction

	Operand	Settings	Description	
			Output method	Settable range of target value
			Subtraction counting	Values smaller than the current value

### ■ Supplement to pulse output operation

When outputting pulses with the PLS+SIGN (direction output) method, pulses will be output approx. 300μs later after the output of direction signal (SIGN). (The characteristics of a motor driver is considered.)

### ■ Precautions during programming

- This instruction cannot be executed when a control flag corresponding to each channel is on.
- When describing the same channel in both the normal program and the interrupt program, be sure to program not to execute them simultaneously.
- For the FP0H mode, select "Pulse output" for the channel setting corresponding to the system register no. 402.
- For the FPsigma mode, select "Do not use high-speed counter" for the channel setting corresponding to the system register nos. 400 and 401.
- When rewriting during RUN is performed during the operation, the pulse output stops while a program is being rewritten.
- Even if the control code is changed after starting the instruction, the change is invalid. It does not affect on the operation.
- When the frequency is changed to a value outside of the settable range after executing the instruction, the operation is performed with the minimum or maximum value in the specification range without causing an operation error.

### **i** Info.

- For the details of the allocations of I/O and flags, refer to "[12.2.2 When Using Pulse Output Function \(FPsigma Compatible Instruction Mode\)](#)".
- For details of the FPsigma mode, refer to "[11 FPsigma Mode](#)".

### 7.2.4 [F174(SP0H)] Pulse Output (Selectable Data Table Control Operation)

Outputs pulses from a specified pulse output channel according to a specified data table.

#### ■ Instruction format

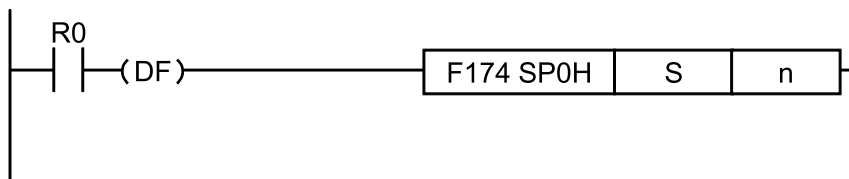



### ■ Operand

Operand	Settings
S	Starting number of the area in which data tables are registered
n	Target channel for pulse output

### ■ Memory area type that can be specified

Operand	WX	WY	WR	WL	SV	EV	DT	LD	I	Constant		Index modifier
										K	H	
S	-	-	-	-	-	-	•	-	-	-	-	•
n	-	-	-	-	-	-	-	-	-	•	•	-

### ■ Outline of operation

- Outputs pulses from a specified channel according to the settings specified in the data table starting with the address specified by [S] when a corresponding control active flag is OFF and the execution condition is ON.
- Switches the pulse frequency when the elapsed value of the high-speed counter reaches the target value set in the data table. (It is performed by the interrupt processing.)
- Stops the pulse output when the elapsed value reaches the final target value.
- For setting the frequency to 50 kHz or more, specify the duty of 1/4 (25%).

### ■ Data table settings

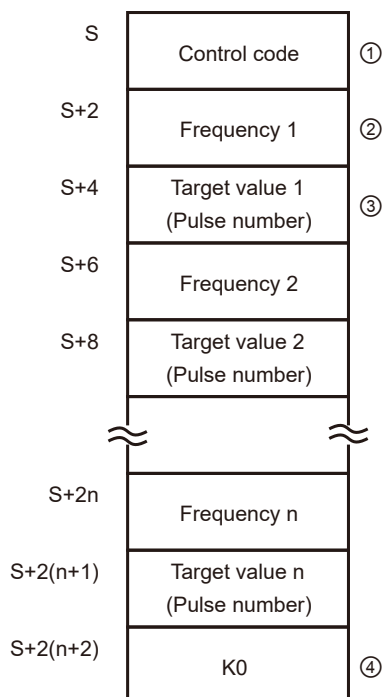

## 7.2 FPsigma Compatible Instruction Mode Control Instruction

	Operand	Settings	Description															
(1)	S	Control code	<p>Specify the control code by setting the H constant.</p> <p style="text-align: center;">H <input type="checkbox"/><input type="checkbox"/><input type="checkbox"/><input type="checkbox"/><input type="checkbox"/><input type="checkbox"/><input type="checkbox"/><input type="checkbox"/></p> <p>0: Fixed</p> <p>Duty (on width)            0: Duty 1/2 (50%)            1: Duty 1/4 (25%)</p> <p>Frequency range            Not used</p> <p>Operation mode            0: Specify Incremental movement amount (pulse no.).            1: Specify Absolute target value (absolute value).</p> <p>Output method            0: Addition counting CW            1: Subtraction counting CCW            2: Addition counting PLS+SIGN (forward off)            3: Subtraction counting PLS+SIGN (reverse on)            4: Addition counting PLS+SIGN (forward on)            5: Subtraction counting PLS+SIGN (reverse off)</p>															
(2)	S+2, S+2n	Frequency n	<p>The setting range of the settable maximum speed varies according to the setting of the initial speed as shown in the table below.</p> <table border="1"> <thead> <tr> <th>Range</th> <th>Initial speed</th> <th>Maximum speed</th> </tr> </thead> <tbody> <tr> <td>Low speed</td> <td>K1 to K49 (1 to 49Hz)</td> <td>K1 to K22000 (1Hz to 22kHz)</td> </tr> <tr> <td>High speed</td> <td>K50 to K100000 (50Hz to 100kHz)</td> <td>K50 to K100000 (50Hz to 100kHz)</td> </tr> </tbody> </table> <p>When the frequency 1 (initial speed) is the low speed range and the frequency n is not in the range between 1 Hz to 22 kHz, the pulse output stops.</p> <p>When the frequency 1 (initial speed) is the high speed range and the frequency n is not in the range between 50 Hz to 100 kHz, the pulse output stops.</p>	Range	Initial speed	Maximum speed	Low speed	K1 to K49 (1 to 49Hz)	K1 to K22000 (1Hz to 22kHz)	High speed	K50 to K100000 (50Hz to 100kHz)	K50 to K100000 (50Hz to 100kHz)						
Range	Initial speed	Maximum speed																
Low speed	K1 to K49 (1 to 49Hz)	K1 to K22000 (1Hz to 22kHz)																
High speed	K50 to K100000 (50Hz to 100kHz)	K50 to K100000 (50Hz to 100kHz)																
(3)	S+4, S+2(n+1)	Target value n	<p>Target value (K-2147483648 to K2147483647)</p> <p>The values of 32-bit data specified as target values should be within the range as shown in the table below.</p> <table border="1"> <thead> <tr> <th colspan="2">Control code setting</th> <th rowspan="2">Settable range of target value</th> </tr> <tr> <th>Operation mode</th> <th>Output method</th> </tr> </thead> <tbody> <tr> <td rowspan="2">Incremental</td> <td>Addition counting</td> <td>Positive values</td> </tr> <tr> <td>Subtraction counting</td> <td>Negative values</td> </tr> <tr> <td rowspan="2">Absolute</td> <td>Addition counting</td> <td>Values larger than the current value</td> </tr> <tr> <td>Subtraction counting</td> <td>Values smaller than the current value</td> </tr> </tbody> </table>	Control code setting		Settable range of target value	Operation mode	Output method	Incremental	Addition counting	Positive values	Subtraction counting	Negative values	Absolute	Addition counting	Values larger than the current value	Subtraction counting	Values smaller than the current value
Control code setting		Settable range of target value																
Operation mode	Output method																	
Incremental	Addition counting	Positive values																
	Subtraction counting	Negative values																
Absolute	Addition counting	Values larger than the current value																
	Subtraction counting	Values smaller than the current value																
(4)	S+2(n+2)	K0	End of table (Pulse output stop setting)															

### ■ Example of program

#### [Operation]

- (1) Starts the pulse output at 1000 Hz from the specified channel ch0 when the execution condition R10 of F174 (SP0H) instruction turns ON.
- (2) Switches the frequency to 2500 Hz when 1000 pulses are counted at 1000 Hz.
- (3) Switches the frequency to 5000 Hz when 3000 pulses are counted at 2500 Hz.
- (4) Switches the frequency to 1000 Hz when 8000 pulses are counted at 5000 Hz.
- (5) Stops the pulse output when 10000 pulses are counted.

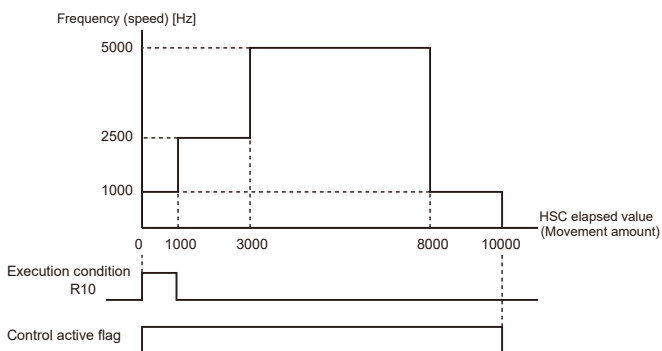

- (Note 1) When the execution condition R10 of F174(SP0H) instruction turns ON, the control active flag will turn ON. When the elapsed value reaches 10000 and the pulse output stops, the control active flag will turn OFF. For details of the allocation of control active flags, refer to ["12.2.2 When Using Pulse Output Function \(FPsigma Compatible Instruction Mode\)"](#).

#### [Settings and program]

Set the frequency range to 191 Hz to 100 kHz and duty 1/4 (25%), and the operation mode to Incremental and the output method to CW.

## 7.2 FPsigma Compatible Instruction Mode Control Instruction

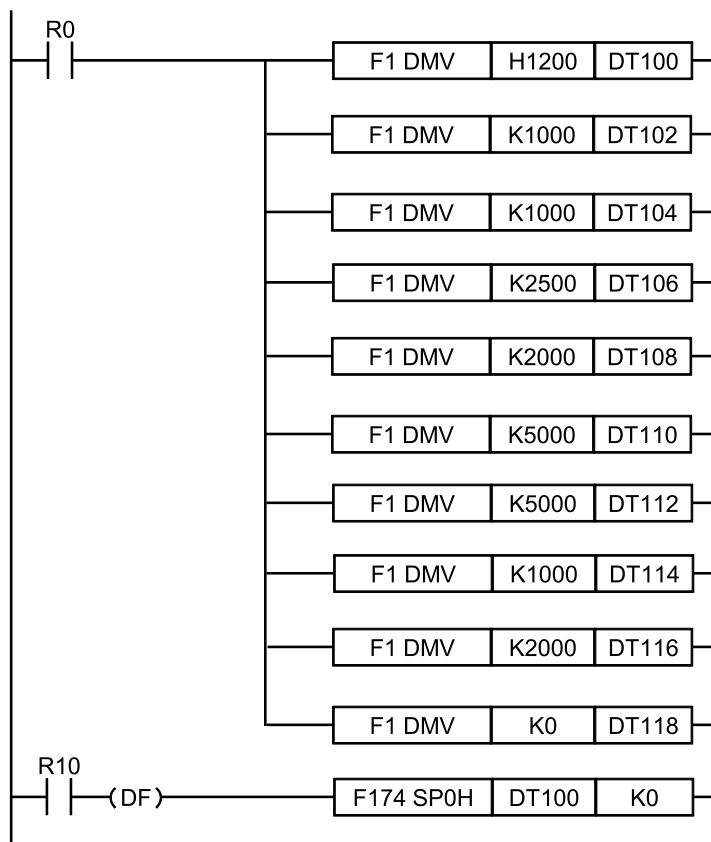

### ■ Supplement to pulse output operation

When outputting pulses with the PLS+SIGN (direction output) method, pulses will be output approx. 300 $\mu$ s later after the output of direction signal (SIGN). (The characteristics of a motor driver is considered.)

### ■ Precautions during programming

- The control active flag turns ON until the pulse output stops after the execution condition of F174(SP0H) instruction has turned ON.
- This instruction cannot be executed when a control flag corresponding to each channel is ON.
- For the FP0H mode, select "Pulse output" for the channel setting corresponding to the system register no. 402.
- For the FPsigma mode, select "Do not use high-speed counter" for the channel setting corresponding to the system register nos. 400 and 401.
- When the control code or frequency 1 is any value outside of the settable range, an operation error occurs. (When the data of the frequency 1 is 0, nothing is executed and the operation ends.)
- When the frequency after the second step is 0 or outside of the settable range, the pulse output stops.
- When the table pointer exceeds the area of data registers DT during the pulse output, the pulse output control will be canceled and the control active flag will turn OFF.

## 7.2 FPsigma Compatible Instruction Mode Control Instruction

- The target values should be set in the range shown on the next page. If a value outside of the range is specified, the number of pulses different from the specified value is output.

### **i** Info.

- For the details of the allocations of I/O and flags, refer to "12.2.2 When Using Pulse Output Function (FPsigma Compatible Instruction Mode)".
- For details of the FPsigma mode, refer to "11 FPsigma Mode".

### 7.2.5 [F175(SPSH)] Pulse Output (Linear Interpolation)

Pulses are output from channel for 2 pulse output, in accordance with the parameters in the designated data table, so that the path to the target position forms a straight line.

#### ■ Instruction format

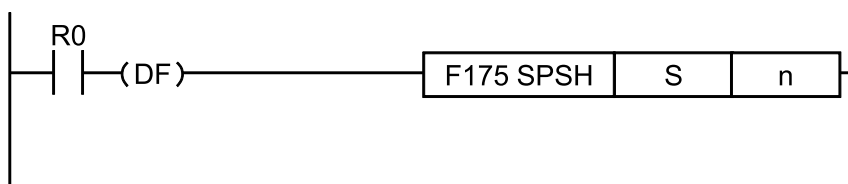

#### ■ Operand

Operand	Settings
S	Starting number of the area in which data tables are registered
n	FP0H mode: 0 or 2, FPsigma mode: 0 (Fixed)

#### ■ Memory area type that can be specified

Operand	WX	WY	WR	WL	SV	EV	DT	LD	I	Constant		Index modifier
										K	H	
S	-	-	-	-	-	-	•	-	-	-	-	•
n	-	-	-	-	-	-	-	-	-	•	•	-

#### ■ Outline of operation

- Outputs pulses from a specified channel when a corresponding control active flag is OFF and the execution condition is ON.
- The control code, initial speed, maximum speed, acceleration/deceleration time, and target value are specified by creating data tables [S] to [S+11] described on the next page using a user program.
- For setting the frequency to 40kHz or more, specify the duty of 1/4 (25%).

## 7.2 FPsigma Compatible Instruction Mode Control Instruction

### ■ Data table settings

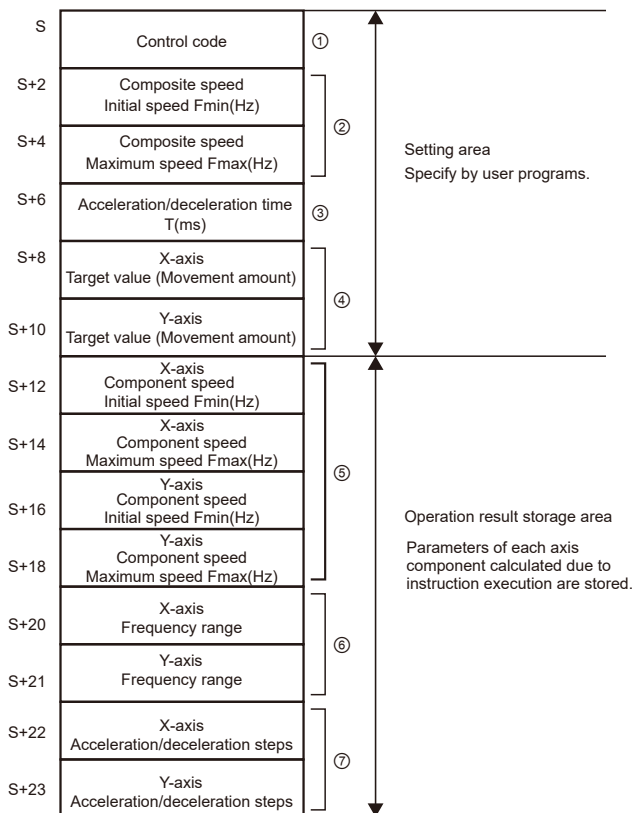

### Setting area

	Operand	Settings	Description
(1)	S	Control code	<p>Specify the control code by setting the H constant.</p> <p>0: Fixed</p> <p>Duty (on width)</p> <p>0: Duty 1/2 (50%)</p> <p>1: Duty 1/4 (25%)</p> <p>0: Fixed</p> <p>Operation mode and output method</p> <p>00: Incremental CW/CCW</p> <p>02: Incremental PLS+SIGN (forward off/reverse on)</p> <p>03: Incremental PLS+SIGN (forward on/reverse off)</p> <p>10: Absolute CW/CCW</p> <p>12: Absolute PLS+SIGN (forward off/reverse on)</p> <p>13: Absolute PLS+SIGN (forward on/reverse off)</p>
(2)	S+2	Composite speed Initial speed	Composite speed (Initial speed, maximum speed) (Hz) <K constant> 1.5 Hz to 100 kHz [k1 to K100000]

## 7.2 FPsigma Compatible Instruction Mode Control Instruction

	Operand	Settings	Description
	S+4	Fmin(Hz)  Composite speed Maximum speed Fmax(Hz)	<p>(However, for 1.5 Hz, the angle is 0 degree or 90 degrees only. Also, for specifying 1.5 Hz, specify K1.)</p> <ul style="list-style-type: none"> <li>When the component speed becomes lower than the minimum speed in each frequency range, it will be a corrected component speed.</li> <li>Do not set 60 kHz or more when using any two of the high-speed counter, periodical interrupt and PLC link are used simultaneously.</li> <li>When the initial speed is set to the maximum speed, the pulse output is performed without acceleration and deceleration.</li> <li>Specify the composite speed to make the component speed of each axis be 1.5Hz or more.</li> <li>Composite speed (Initial speed): 30 kHz or less</li> </ul> <p>Notes on the specification of composite speed (initial speed) When each initial component speed of CH0 and CH2 is not 1.5 Hz or more by the following arithmetic expression, the path may not be linear. (When the following formula is not satisfied)</p> $f \geq \frac{1.5 \sqrt{(\Delta X^2 + \Delta Y^2)}}{\Delta X}$ <p><math>\Delta x</math>: Channel whose distance of (target value - current value) is short <math>\Delta y</math>: Channel whose distance of (target value - current value) is long</p>
(3)	S+6	Acceleration/ deceleration time T(ms)	<p>Acceleration/deceleration time (ms) &lt;K constant&gt; K0 to K32767</p> <p>In the case of 0, the pulse output is performed at the initial speed (composite speed) without acceleration and deceleration.</p>
(4)	S+8	X-axis Target value (Movement amount)	<p>K-8388608 to K8388607</p> <p>When only one axis is activated;</p> <ol style="list-style-type: none"> <li>For the incremental mode, set the target value of the axis that is not activated to 0.</li> <li>For the absolute mode, set the target value of the axis that is not activated to the same as the current value.</li> </ol> <p>(Note): In the case of linear interpolation, infinite rotation cannot be performed.</p>
	S+10	Y-axis Target value (Movement amount)	

### Operation result storage area

	Operand	Settings	Description
(5)	S+12	X-axis Component speed Initial speed Fxmin	<p>The component speed (initial speed and maximum speed of each axis) is stored as 2 words in real type.</p> $\text{X-axis component speed} = \frac{(\text{Composite speed}) \times (\text{X-axis movement amount})}{\sqrt{((\text{X-axis movement amount})^2 + (\text{Y-axis movement amount})^2)}}$ $\text{Y-axis component speed} = \frac{(\text{Composite speed}) \times (\text{Y-axis movement amount})}{\sqrt{((\text{X-axis movement amount})^2 + (\text{Y-axis movement amount})^2)}}$ <p>Example) Even when the initial speed is corrected, the calculated value is stored as is in the operation result storage area.</p>
	S+14	X-axis Component speed Maximum speed Fxmax	

## 7.2 FPsigma Compatible Instruction Mode Control Instruction

	Operand	Settings	Description
	S+16	Y-axis Component speed Initial speed Fymin	
	S+18	Y-axis Component speed Maximum speed Fymax	
(6)	S+20	X-axis Frequency range	The frequency ranges are automatically selected by the system for the components of each axis. 0: Low speed range (1 Hz to 22 kHz) 1: High speed range (50Hz to 100 kHz)
	S+21	Y-axis Frequency range	When the initial speed (X/Y axis) is the low speed range and the maximum speed (X/Y axis) exceeds 22 kHz, the initial speed (X/Y axis) is corrected to 50 Hz. When the initial speed (X/Y axis) is less than 1Hz and the maximum speed (X/Yaxis) exceeds 22 kHz or less, the initial speed (X/Y axis) is corrected to 1 Hz.
(7)	S+22	X-axis Acceleration/deceleration steps	The acceleration/deceleration steps are automatically calculated by the system in the range of 0 to 60 steps. <ul style="list-style-type: none"> <li>When the operation result is 0, the pulse output is performed at the initial speed (composite speed) without acceleration and deceleration.</li> <li>The acceleration/deceleration steps are calculated by the following formula; Acceleration/deceleration time (ms) x Initial component speed (Hz).</li> </ul>
	S+23	Y-axis Acceleration/deceleration steps	Example) When the settings are as follows; Incremental, Initial speed=5 kHz, Acceleration/deceleration time=0.5 s, CH0 target value=1000, and CH2 target value=50. $\text{CH0 Initial component speed} = \frac{300 \times 1000}{\sqrt{(1000^2 + 50^2)}} = 299.626 \text{ Hz}$ $\text{CH2 Initial component speed} = \frac{300 \times 50}{\sqrt{(1000^2 + 50^2)}} = 14.981 \text{ Hz}$ CH0 Acceleration/deceleration steps = $500 \times 10^{-3} \times 299.626 \approx 147.8 \rightarrow 60$ steps CH2 Acceleration/deceleration steps = $500 \times 10^{-3} \times 14.981 \approx 7.4 \rightarrow 7$ steps

### ■ Supplement to pulse output operation

When outputting pulses with the PLS+SIGN (direction output) method, pulses will be output approx. 300μs later after the output of direction signal (SIGN). (The characteristics of a motor driver is considered.)

### ■ Precautions during programming

- Set the target value and movement amount to be within the following range.



## 7.2 FPsigma Compatible Instruction Mode Control Instruction

---

-8,388,608 to +8,388,607

When using this instruction in combination with other positioning instructions such as F171, also set the target values for those instructions to be within the above range.

- When using this instruction for a purpose for which high accuracy is required, confirm the operation using a real machine.
- When describing the same channel in both the normal program and the interrupt program, be sure to program not to execute them simultaneously.
- For the FP0H mode, select "Pulse output" for the channel setting corresponding to the system register no. 402.
- For the FPsigma mode, select "Do not use high-speed counter" for the channel setting corresponding to the system register nos. 400 and 401.
- By performing the rewriting during RUN while outputting pulses, more pulses than the setting may be output.

### Info.

- For the details of the allocations of I/O and flags, refer to "[12.2.2 When Using Pulse Output Function \(FPsigma Compatible Instruction Mode\)](#)".
- For details of the FPsigma mode, refer to "[11 FPsigma Mode](#)".

(MEMO)

# 8 Troubleshooting

---

8.1 Self-diagnostic Function.....	8-2
8.1.1 Operation Monitor LEDs of Control Unit .....	8-2
8.2 What to Do If an Error Occurs.....	8-4
8.2.1 ERR/ALM LED Flashes .....	8-4
8.2.2 What to Do When Positioning Error Occurs.....	8-5
8.2.3 Motor Does Not Rotate/Move (Output LED Flashes or is ON) .....	8-7
8.2.4 Motor Does Not Rotate/Move (Output LED is OFF) .....	8-7
8.2.5 Rotation/Movement Direction is Reversed.....	8-8

## 8.1 Self-diagnostic Function

### 8.1 Self-diagnostic Function

#### 8.1.1 Operation Monitor LEDs of Control Unit

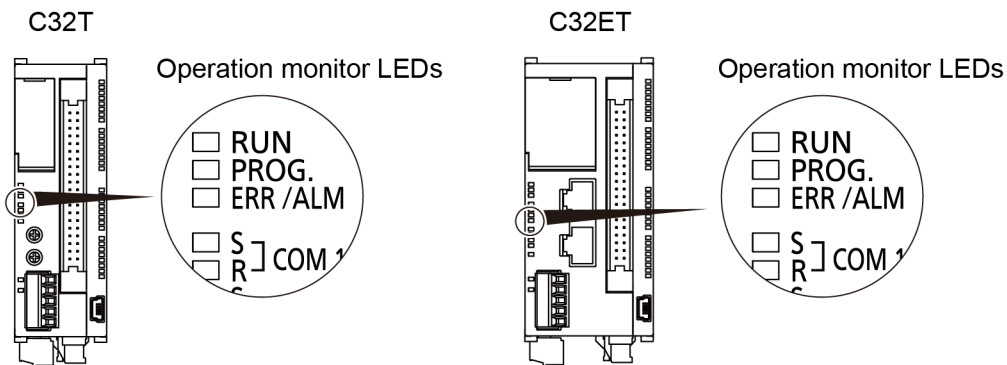

- The control unit has a self-diagnostic function which identifies errors and stops operation if necessary.
- When an error occurs, the status of the status indicator LEDs on the control unit vary, as shown in the table above.

#### ■ LEDs related to self-diagnostic errors

	LED display			Description	Operation status
	RUN (Green)	PROG (Green)	ERR/ALM (Red)		
In normal condition	ON	OFF	OFF	Normal operation	Operating
	OFF	ON	OFF	Program mode LED does not flash even if the forcing output is performed in program mode.	Stop
	Flashes (Note 1)	Flashes (Note 1)	OFF	Forcing input/output in RUN mode RUN and PROG. LEDs flash alternately.	Operating
	Flashes (Note 2)	Flashes (Note 2)	OFF	During version upgrade	Stop
In abnormal condition	ON	OFF	Flashes	Self-diagnostic error (During operation)	Operating
	OFF	ON	Flashes	Self-diagnostic error (During stop)	Stop
	OFF	ON	ON	System watchdog timer has been activated	Stop

(Note 1) The flashing is repeated every 1 second. (ON for 0.5 seconds ⇔ OFF for 0.5 seconds)

(Note 2) The LEDs flash quickly while upgrading the version. The flashing changes to a slow flashing while rewriting the version.

#### ■ Operation Mode When an Error Occurs

- Normally, when an error occurs, the operation stops.
- For some errors, the user may select whether operation is to be continued or stopped by setting the system registers.

### ■ "PLC Configuration" dialog box of FPWIN GR7

To specify the steps to be taken by the FPWIN GR7 if a PLC error occurs, select "System register settings" under "Option" on the menu bar, and click on the "Action on Error" tab. The screen shown below is displayed.

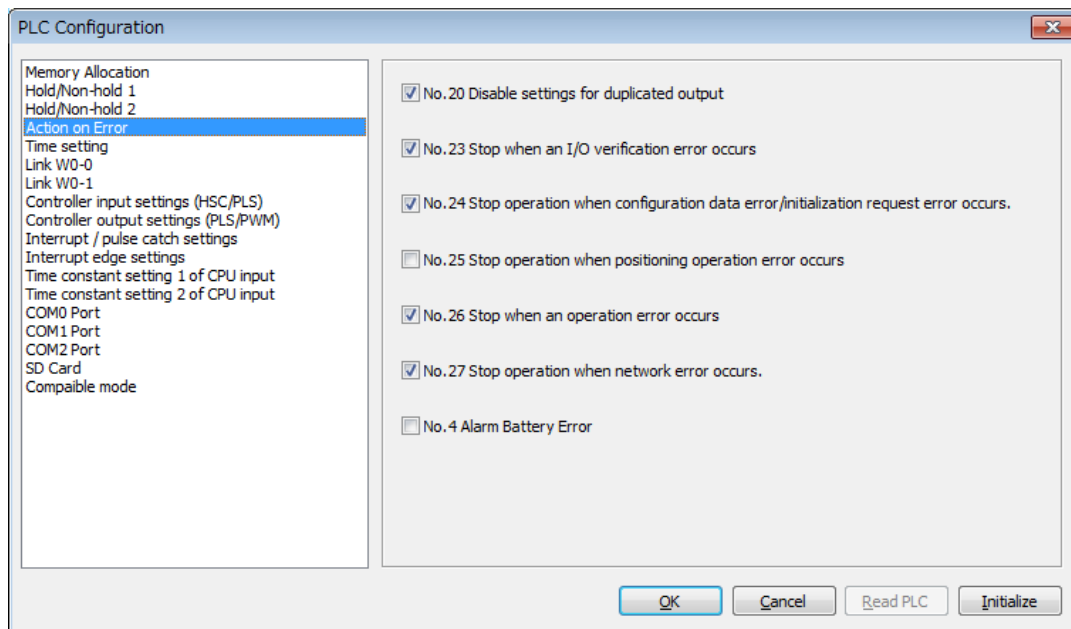

#### **i** Info.

- When the checkbox of the system register no. 25 "Stop operation when positioning operation error occurs" is unchecked, only the operation of the axis in which the positioning error occurs stops and the operations of other axes continue.

### 8.2 What to Do If an Error Occurs

#### 8.2.1 ERR/ALM LED Flashes

##### ■ Situation

A syntax error or self-diagnostic error has occurred. The following shows the procedure when a positioning error has occurred.

##### ■ Solution

1. Check the error code using the programming tool.

If a PLC error occurs during programming or debugging, the "Status Display" dialog box will appear automatically.

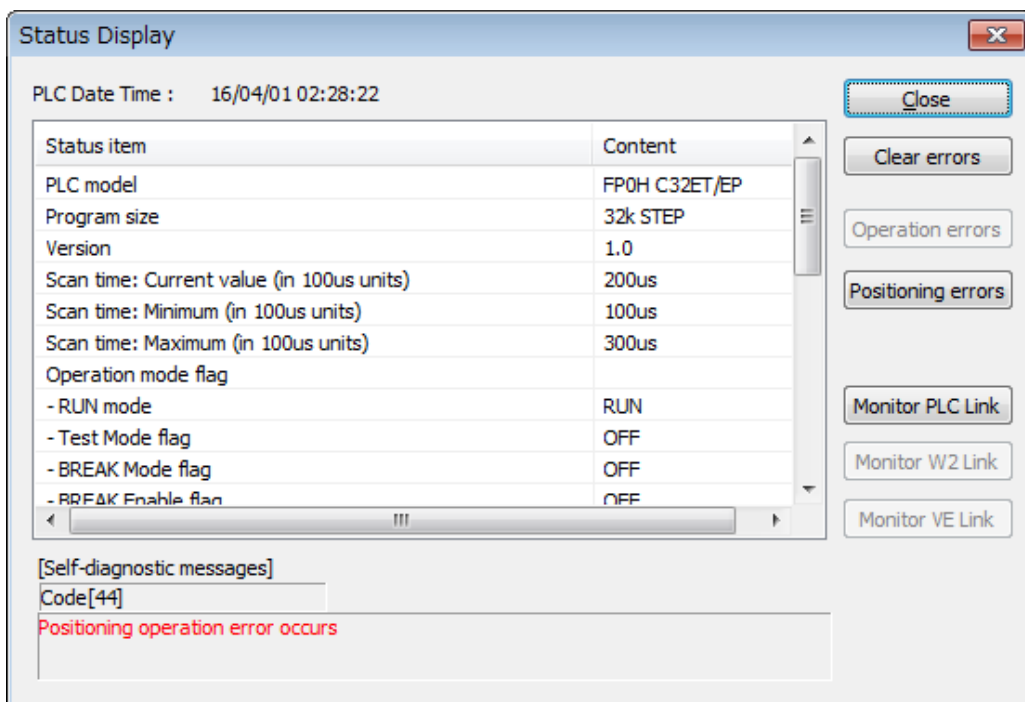

2. In the case of the positioning operation error, press the [Positioning errors] button. The channel number where the positioning error has occurred and the error code occurred when using the table setting mode appears.

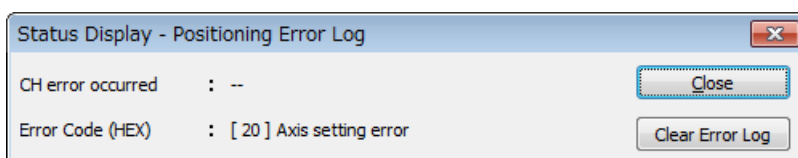

3. Press the [Clear Error Log] button. A confirmation message appears.

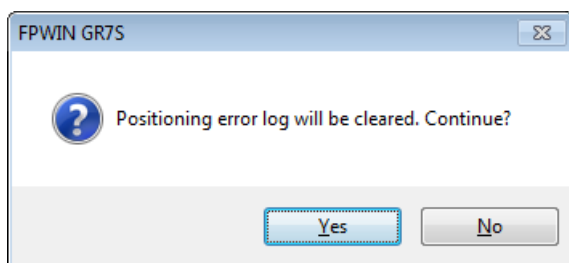

4. Press the [Yes] button.  
The positioning error log will be cleared.
5. Press the [Close] button.  
It returns to the "Status Display" dialog box.
6. Press the [Clear errors] button.  
The display of the self-diagnostic error message will be cleared.
7. Correct the positioning parameters or positioning tables according to the positioning error code confirmed in step 2.
8. Download the corrected positioning parameters or positioning table data.

#### Error Codes and How to Handle Them

Error code	Situation	Solution
1 to 9	Syntax error occurs.	<ul style="list-style-type: none"> <li>• Change to PROG. mode and clear the error.</li> <li>• Execute a total-check function using FPWIN GR7 to determine the location of the syntax error and correct the program.</li> </ul>
20 or more	Self-diagnostic error occurs.	<ul style="list-style-type: none"> <li>• Refer to the list of error codes and correct the settings or programs.</li> <li>• Use the programming tool in PROG. mode to clear the error.</li> </ul>

#### **i** Info.

- In the case of an error code 43 or higher, the error can be cleared by pressing the [Clear errors] button in the "Status Display" dialog box. In the PROG. mode, the power supply can be turned off and then on again to clear the error, but all of the contents of the operation memory except hold type data will be cleared.
- When the positioning error (error code 44) occurs, the detailed information on the error can be confirmed. Press the [Positioning errors] button to check the error code.
- When an operation error (error code 45) occurs, the address at which the error occurred is stored in special data registers DT90017 and DT90018. If this happens, click on the "Operation errors" button in the "Status display dialog box" and confirm the address at which the error occurred before canceling the error.
- The error can also be cleared using the self-diagnostic error set instruction F148 (ERR).

### 8.2.2 What to Do When Positioning Error Occurs

The following are the solutions when the self-diagnostic error (error code 44: positioning error) occurs.

## 8.2 What to Do If an Error Occurs

### ■ Positioning error code

Error code	Error name	Description	Operation when an error occurs and solution
10H	Limit + signal detection	The input on the plus side of the limit turned on. (Note 1)	The operation stops in the limit stop time specified in the axis setting area. After the stop, execute the home return or JOG operation in the reverse direction. Correct the setting of the parameter.
11H	Limit - signal detection	The input on the minus side of the limit turned on. (Note 1)	
12H	Limit signal error	Both inputs on the plus and minus sides of the limit turned on.	
20H	Axis setting error	The axis setting is incorrect.	Each control operation does not start. Correct the setting of the parameter.
21H	Limit stop deceleration time error	The set value of the limit stop deceleration time is out of the range.	
22H	Emergency stop deceleration time error	The set value of the emergency stop deceleration time is out of the range.	
23H	Startup speed error	The set value of the startup speed is out of the range.	
24H	Home return setting code error	The set value of the home return setting code is out of the range.	
25H	Home return target speed error	The set value of the home return target speed is out of the range.	
26H	Home return acceleration time error	The set value of the home return acceleration time is out of the range.	
27H	Home return deceleration time error	The set value of the home return deceleration time is out of the range.	
28H	Home return creep speed error	The set value of the home return creep speed is out of the range.	
29H	Home return direction error	The set value of the home return direction is out of the range.	
30H	JOG operation target speed error	The set value of the JOG operation target speed is out of the range.	
31H	JOG operation acceleration time error	The set value of the JOG operation acceleration time is out of the range.	
32H	JOG operation deceleration time error	The set value of the JOG operation deceleration time is out of the range.	
41H	Table setting error	The combination of tables is incorrect.	
42H	Operation pattern error	The set value of the operation pattern is incorrect.	
43H	Positioning acceleration time error	The set value of the positioning acceleration time is out of the range.	
44H	Positioning deceleration time error	The set value of the positioning deceleration time is out of the range.	
45H	Positioning target speed error	The set value of the positioning target speed is out of the range.	
46H	Positioning movement amount error	The set value of the positioning movement amount is out of the range.	



Error code	Error name	Description	Operation when an error occurs and solution
47H	Dwell time error	The set value of the dwell time is out of the range.	
48H	J point control setting error	The J-point control is set on the interpolation axis table.	
60H	Repeat operation dwell time setting error	The dwell time of the E table which performs repetitive operations is 0 ms.	

(Note 1) The error occurs only when the condition of the limit stop is satisfied.

#### ■ Error code 41: Occurrence condition of table setting error

- The last table of the positioning setting tables is not the E point. (e.g. The P point, C point and J point are set continuously.)
- The control method of the J-point control table is absolute.
- The tables whose control method is absolute are set repeatedly.
- The opposite pulse output directions (forward/reverse) are set on the consecutive tables of P +E points.
- Axes to which the interpolation operation setting is made are selected for the F383 simultaneous start instruction.

### 8.2.3 Motor Does Not Rotate/Move (Output LED Flashes or is ON)

#### ■ Solution 1: For servo motor

Check to make sure the servo on input is set to "ON".

#### ■ Solution 2

Check to make sure the power supplies for the servo amplifier and motor driver are ON.

#### ■ Solution 3

Check to make sure the servo amplifier and motor driver are connected to the unit correctly.

#### ■ Solution 4

Check to make sure the settings for the pulse output method (CW/CCW method or Pulse/Sign method) are appropriate.

### 8.2.4 Motor Does Not Rotate/Move (Output LED is OFF)

#### ■ Solution

Review the program.

## 8.2 What to Do If an Error Occurs

---

### **i** Info.

#### Point to check

- Check to make sure the I/O numbers are appropriate.
- Check non-rewriting of the start flag in the program.
- Check the input valid logic of the over limit switch. In this case, the error LED flashes.

### 8.2.5 Rotation/Movement Direction is Reversed

■

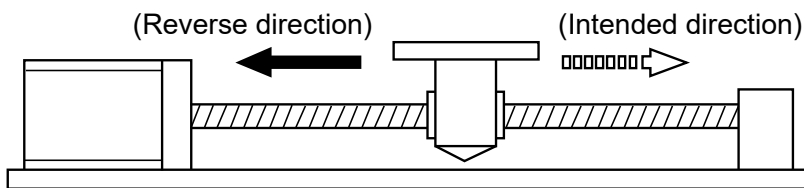

#### ■ Solution 1

Check to make sure the servo amplifier and motor driver are connected to the unit correctly.

### **i** Info.

#### Point to check

Check to make sure the CW/CCW output or the Pulse/Sign output is connected to the pertinent input of the servo amplifier and motor driver.

#### ■ Solution 2

Change the pulse output rotation direction of the parameters for each axis, and set it to the reverse direction.

# 9 PWM Output Function

---

9.1 PWM Output Function.....	9-2
9.1.1 Overview of PWM Output Function.....	9-2
9.1.2 System Register Settings.....	9-2
9.1.3 [F173 PWMH] PWM Output Instruction (Frequency Specification) .	9-3
9.1.4 [F173 PWMH] PWM Output Instruction (Control Code Specification) .....	9-5

## 9.1 PWM Output Function

### 9.1 PWM Output Function

#### 9.1.1 Overview of PWM Output Function

The pulse output of an arbitrary duty ratio can be performed.

- When you increase the pulse width...

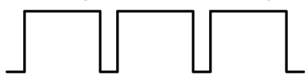

Heating increases.

- When you decrease it...



Heating decreases.

#### ■ Comparison of functions and performances

##### FP0H mode

Channel no.	Output no.	Control flag
CH0	Y0	R911C
CH1	Y3	R911D
CH2	Y8	R911E
CH3	YB	R911F

##### FPsigma mode

Channel no.	Output no.	Control flag
CH0	Y0	R903A
CH2	Y3	R903C

(Note 1) Functions, channel numbers and I/O numbers used are set in the tool software.

(Note 2) I/O numbers used for each function should be allocated so that they do not overlap.

#### **i** Info.

- For details of the FPsigma mode, refer to "[11 FPsigma Mode](#)".

#### 9.1.2 System Register Settings

Functions to be used are allocated in the system register settings dialog box. The following procedure is explained on the condition that the FPWIN GR7 has already started.

### **1** Procedure

1. Select **Option>System register settings** from the menu bar.

The "PLC Configuration " dialog box appears.

2. Select "Controller output setting (PLS/PWM)" from the left pane.  
The menu for setting "System register no. 402" appears.

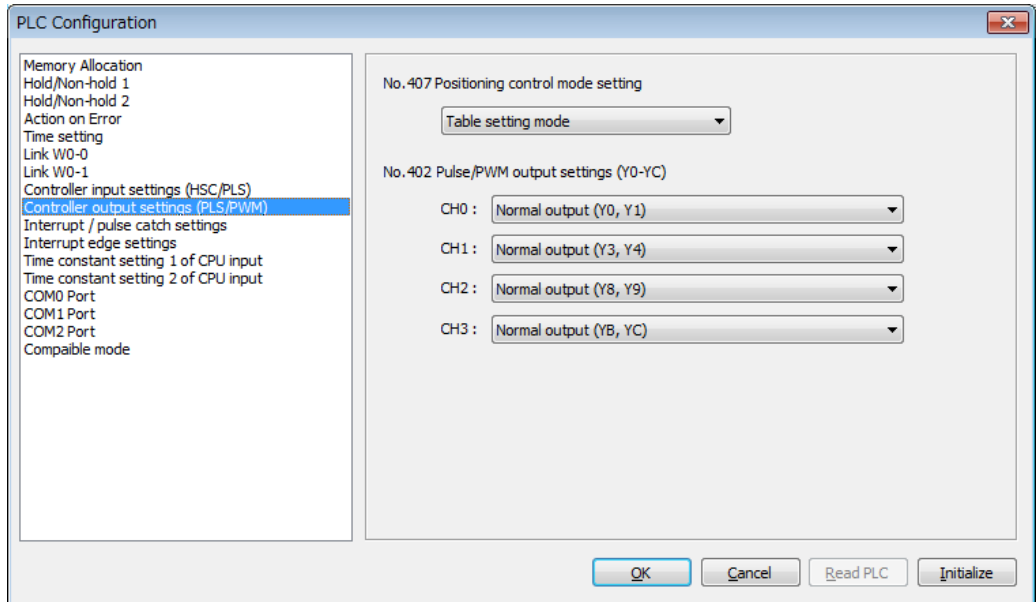

3. Change the settings for the channels used for the PWM output.
4. Press the [OK] button.

The screen returns to the ladder edit screen. The settings will be downloaded to the PLC together with programs and comments.

### System register relating to PWM output

Classification	No. and setting item	Settings
Controller output settings (PLS/PWM)	402 Pulse PWM output setting (Y0 to YC)	CH0 Set the PWM output (Y0) and normal output (Y1).
		CH1 Set the PWM output (Y3) and normal output (Y4).
		CH2 Set the PWM output (Y8) and normal output (Y9).
		CH3 Set the PWM output (YB) and normal output (YC).

(Note 1) Select "Normal output" for the output that is not used for the pulse output function or PWM output function.

(Note 2) For the FPsigma mode, the output settings by the system register is not available.

### 9.1.3 [F173 PWMH] PWM Output Instruction (Frequency Specification)

Performs the PWM output according to the set parameters.

## 9.1 PWM Output Function

### ■ Instruction format

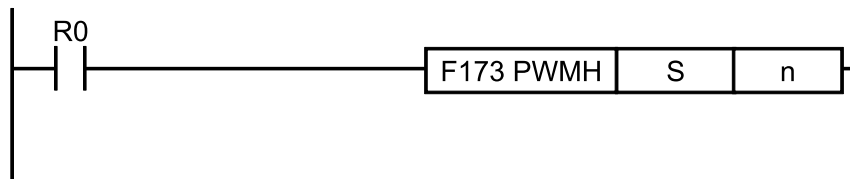

### ■ Operand

Operand	Settings	
	Starting address the memory area storing the parameters of the PWM output.	
S	S	Specify the control code HFF.
	S+1	Specify the output frequency in 2-word 32-bit data.
	S+2	Setting range: K1 to K100000 (1 Hz to 100 kHz: in 1 Hz increments)
	S+3	Duty ratio (Resolution of 1000 or 100) For the output frequencies 1 to K70000, Setting range: K0 to K1000 (0.0% to 100.0%) For the output frequencies K70001 to K100000, Setting range: K0 to K1000 (0% to 100%)
n	Channel nos. used for PWM output: FP0H mode: 0 (CH0: Y0), 1 (CH1: Y3), 2 (CH2: Y8), 3 (CH3: YB) FPsigma mode: 0 (CH0: Y0), 2 (CH2: Y3)	

### ■ Memory area type that can be specified

Operand	WX	WY	WR	WL	SV	EV	DT	LD	I	Constant		Index modifier
										K	H	
S	-	-	-	-	-	-	•	-	-	-	-	•
n	-	-	-	-	-	-	-	-	-	•	•	-

### ■ Outline of operation

- The PWM output is performed from a specified output. The output is performed when the trigger (execution condition) is on.
- The output frequency and duty ratio is specified in the operands [S+1] to [S+3].

### ■ Precautions during programming

- This instruction cannot be executed when a control flag corresponding to each channel is on.
- The duty may be different from the set ratio according to the load voltage and load current especially in the vicinity of minimum and maximum values. The duty can be changed for each scan. However, the control code cannot be changed during the execution of an instruction.
- When rewriting during RUN is performed during the operation, the PWM output stops while a program is being rewritten.

### ■ Example of program

The following sample shows the program for performing the PWM output with 10 kHz and the duty ratio of 50% from CH0 (Y0).

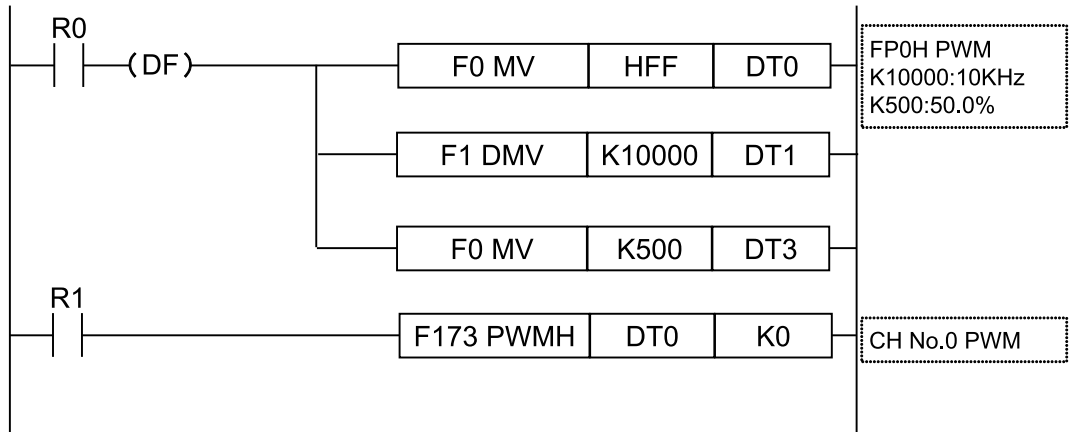

### **i** Info.

- For details of the allocations of I/O and flags, refer to "[12.2.3 When Using PWM Output Function](#)".
- For details of the FPsigma mode, refer to "[11 FPsigma Mode](#)".

### 9.1.4 [F173 PWMH] PWM Output Instruction (Control Code Specification)

The PWM output is performed according to the set parameters.

### ■ Instruction format

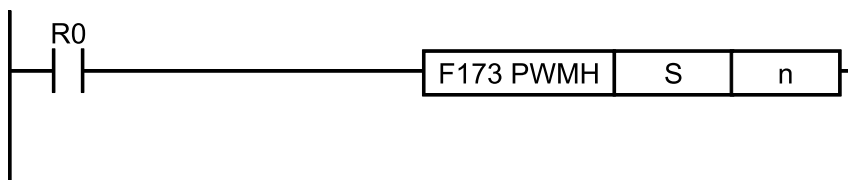

### ■ Operand

Operand	Settings
S	Starting address the memory area storing the parameters of the PWM output.
	S Specify the control code. K0 to K30
	S+1 Duty ratio (Resolution of 1000 or 100) For the control codes K0 to K27, Setting range: K0 to K1000 (0.0% to 100.0%) For the control codes K28 to K30, Setting range: K0 to K1000 (0% to 100%)
n	Channel nos. used for PWM output:

## 9.1 PWM Output Function

Operand	Settings
	FP0H mode: 0 (CH0: Y0), 1 (CH1: Y3), 2 (CH2: Y8), 3 (CH3: YB) FPsigma mode: 0 (CH0: Y0), 2 (CH2: Y3)

### ■ Memory area type that can be specified

Operand	WX	WY	WR	WL	SV	EV	DT	LD	I	Constant		Index modifier
										K	H	
S	-	-	-	-	-	-	•	-	-	-	-	•
n	-	-	-	-	-	-	-	-	-	•	•	-

### ■ Outline of operation

- The PWM output is performed from a specified output. The output is performed when the trigger (execution condition) is on.
- The output frequency and cycle are determined by a specified control code. The duty ratio is specified in the operand [S1+1].

### ■ Precautions during programming

- This instruction cannot be executed when a control flag corresponding to each channel is on.
- The duty may be different from the set ratio according to the load voltage and load current especially in the vicinity of minimum and maximum values. The duty can be changed for each scan. However, the control code cannot be changed during the execution of an instruction.
- When rewriting during RUN is performed during the operation, the PWM output stops while a program is being rewritten.

### ■ Control code

S	Frequency (Hz)	Cycle (ms)	Resolution	S	Frequency (Hz)	Cycle (ms)	Resolution
K0	1.5	666.67	1000	K16	2000.0	0.50	1000
K1	2.0	500.00		K17	3000.0	0.33	
K2	4.0	250.00		K18	6000.0	0.17	
K3	6.0	166.67		K19	12500.0	0.08	
K4	8.0	125.00		K20	15000.0	0.067	
K5	10.0	100.00		K21	20000.0	0.050	
K6	20.0	50.00		K22	25000.0	0.040	
K7	50.0	20.00		K23	30000.0	0.033	
K8	100.0	10.00		K24	40000.0	0.025	
K9	200.0	5.00		K25	50000.0	0.020	
K10	400.0	2.50		K26	60000.0	0.017	
K11	500.0	2.00		K27	70000.0	0.0143	
K12	700.0	1.48	K28	80000.0	0.0125	100	
K13	1000.0	1.00	K29	90000.0	0.0111		



S	Frequency (Hz)	Cycle (ms)	Resolution	S	Frequency (Hz)	Cycle (ms)	Resolution
K14	1300.0	0.77		K30	100000.0	0.010	
K15	1600.0	0.625		-			

### ■ Example of program

The following sample shows the program for performing the PWM output with 1kHz and the duty ratio of 50% from CH0 (Y0).

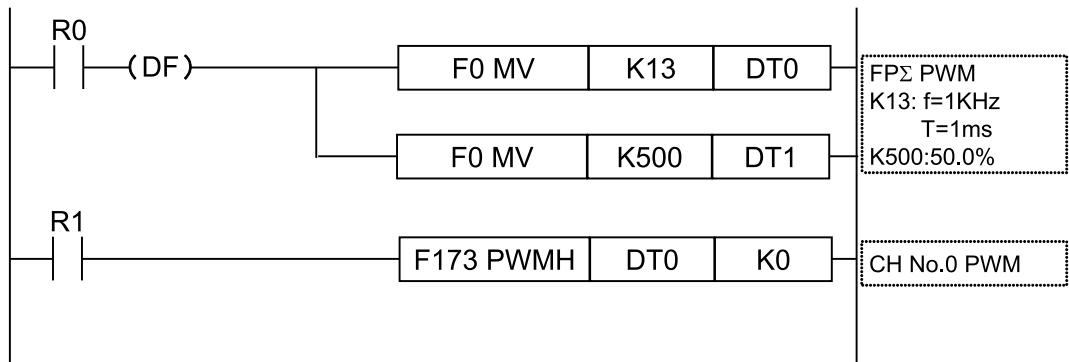

### **i** Info.

- For details of the allocations of I/O and flags, refer to "[12.2.3 When Using PWM Output Function](#)".
- For details of the FPsigma mode, refer to "[11 FPsigma Mode](#)".

(MEMO)

# 10 High-speed Counter Function

---

10.1 Overview of High-speed Counter Function .....	10-2
10.1.1 Overview of High-speed Counter Function .....	10-2
10.1.2 Counting Range and Elapsed Value (Current Value) Area .....	10-2
10.1.3 Areas Used For High-speed Counter Function .....	10-3
10.1.4 Input Mode Type .....	10-4
10.1.5 Minimum Input Pulse Width .....	10-5
10.2 System Register Settings.....	10-7
10.2.1 System Register Settings.....	10-7
10.3 High-speed Counter Instruction .....	10-9
10.3.1 [F0 MV] High-speed Counter Control Instruction .....	10-9
10.3.2 F1 DMV (Pulse Output Elapsed Value Write/Read).....	10-10
10.3.3 [F166 HC1S] High-speed Counter Target Value Match ON Instruction [F167 HC1R] High-speed Counter Target Value Match OFF Instruction .....	10-11
10.3.4 Sample Program (Positioning Operation With Inverter: First Speed) .....	10-13
10.3.5 Sample Program (Positioning Operation With Inverter: Second Speed) .....	10-15
10.4 High-speed Counter Cam Control Instruction .....	10-18
10.4.1 [F165 CAM0] High-speed Counter Cam Control Instruction .....	10-18
10.4.2 Sample Program (Upper Limit Control, Reset, Addition) .....	10-22
10.4.3 Sample Program (Upper Limit Control, Instruction Clear, Addition).....	10-24
10.4.4 Sample Program (Upper Limit Control, Subtraction) .....	10-26
10.5 Interrupt Program Activation .....	10-29
10.5.1 Overview of Function .....	10-29
10.5.2 Interrupt Activation When F165 (CAM0) is Executed .....	10-29

## 10.1 Overview of High-speed Counter Function

### 10.1 Overview of High-speed Counter Function

#### 10.1.1 Overview of High-speed Counter Function

- This function allows the counting of input signals from external devices at high speed such as a sensor and encoder.
- Exclusive instructions (F166 and F167) are provided for turning on or off arbitrary outputs (Y0 to Y1F) in the interrupt processing when the elapsed value matches the target value. The output turned ON/OFF by an instruction is used by presetting with an instruction such as the SET/RET instructions. The instruction (F165) which enables the cam output up to 32 points to be acquired according to the elapsed value.
- Channels and inputs to be used are specified by system registers. The output when the values match is specified by the operand of the instruction.

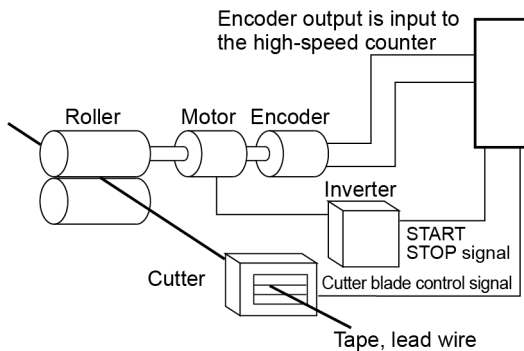

#### 10.1.2 Counting Range and Elapsed Value (Current Value) Area

- The elapsed value of the high-speed counter is stored in a special data register as 2-word 32-bit data.
- The elapsed value area will be reset when the power supply turns off. It will be held when switching the mode from RUN to PROG.
- The high-speed counter is a ring counter. When the counted value exceeds the maximum value, it returns to the minimum value. When the counted value exceeds the minimum value, it returns to the maximum value.

## ■ Counting range of elapsed value (current value) area

Section	Range	
High-speed counter control	K-2,147,483,648 to K2,147,483,647	

### 10.1.3 Areas Used For High-speed Counter Function

The usable combinations vary according to the unit type.

#### ■ List of used areas

##### FP0H mode

Channel no.	Input no.		Control flag	Elapsed value area	Target value area
	Single-phase	2-phase			
CH0	X0	X0, X1	R9110	DT90300 DT90301	DT90302 DT90303
CH1	X1	-	R9111	DT90302 DT90303	DT90306 DT90307
CH2	X3	X3, X4	R9112	DT90308 DT90309	DT90310 DT90311
CH3	X4	-	R9113	DT90312 DT90313	DT90314 DT90315

##### FPsigma mode

Channel no.	Input no.		Control flag	Elapsed value area	Target value area
	Single-phase	2-phase			
CH0	X0	X0, X1	R903A	DT90044 DT90045	DT90046 DT90047

# 10.1 Overview of High-speed Counter Function

Channel no.	Input no.		Control flag	Elapsed value area	Target value area
	Single-phase	2-phase			
CH1	X1	-	R903B	DT90048 DT90049	DT90050 DT90051
CH2	X3	X3, X4	R903C	DT90200 DT90201	DT90202 DT90203
CH3	X4	-	R903D	DT90204 DT90205	DT90206 DT90207

(Note 1) Functions, channel numbers and I/O numbers used are set in the tool software.

(Note 2) I/O numbers used for each function should be allocated so that they do not overlap. Refer to "1.2 Restrictions on Combinations and Functions".

**i Info.**

- For details of the FP mode, refer to "11 FPsigma Mode".

## 10.1.4 Input Mode Type

### Input Modes and Count Operations

Mode	Range
Addition input	
Subtraction input	

## 10.1 Overview of High-speed Counter Function

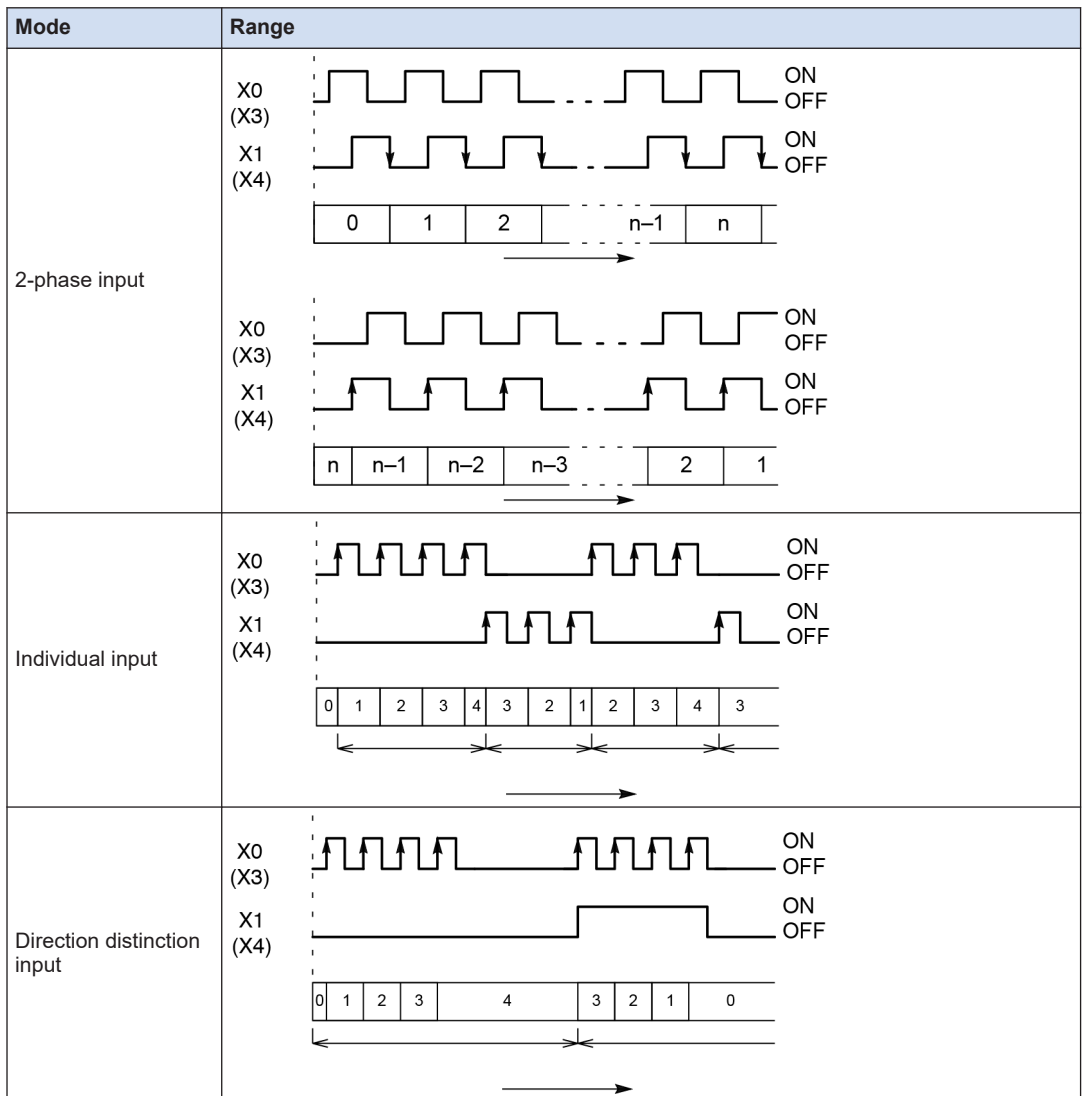

### 10.1.5 Minimum Input Pulse Width

For the period T, the following minimum input pulse width is required.

# 10.1 Overview of High-speed Counter Function

## ■ Min. input pulse width

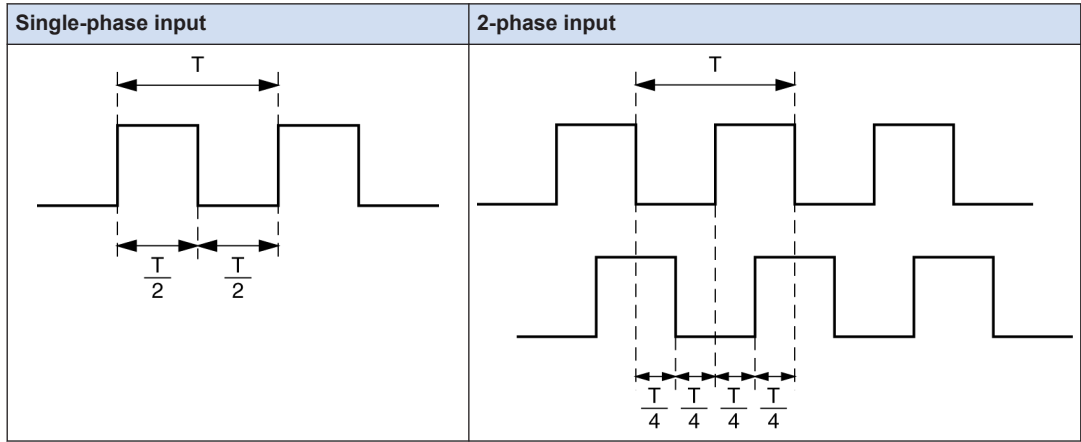



## 10.2 System Register Settings

### 10.2.1 System Register Settings

Functions to be used are allocated in the system register settings dialog box. The following procedure is explained on the condition that the FPWIN GR7 has already started.

#### 1 2 Procedure

1. Select **Options>System register settings** from the menu bar.  
The "PLC Configuration" dialog box appears.
2. Select "Controller input setting (HSC/PLS)" from the left pane.  
The menu for setting "System register no. 400 or 401" appears.
3. Change the settings for the channels used for the high-speed counter.  
The following figure shows the case when 2-phase input (X0, X1) is allocated to CH0.

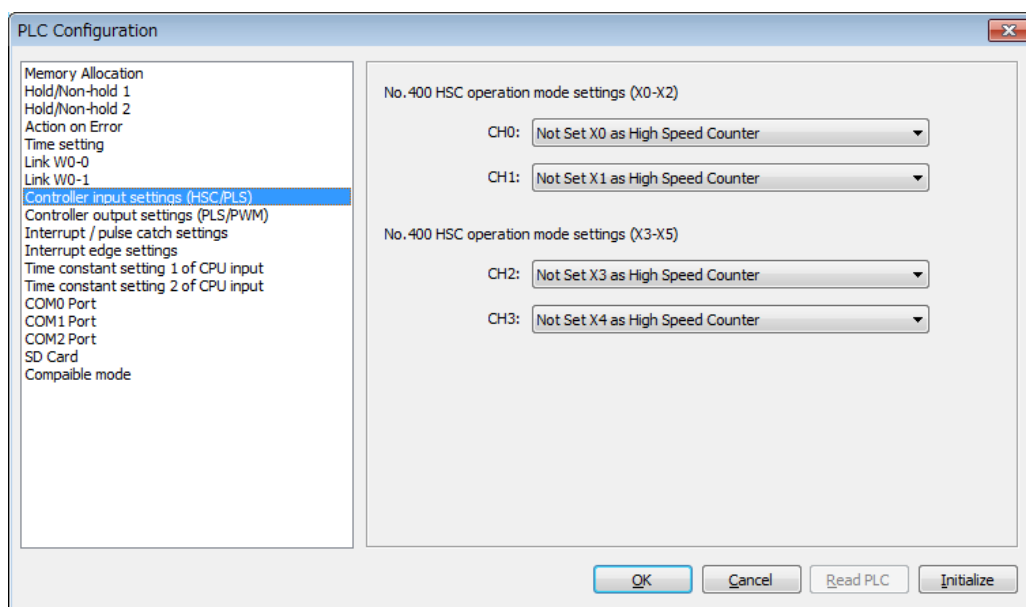

4. Press the [OK] button.  
The screen returns to the ladder edit screen. The settings will be downloaded to the PLC together with programs and comments.

#### System register relating to high-speed counter output

Classification	No. and setting item	Settings
Controller input settings (HSC/PLS)	400 HSC operation mode setting (X0 to X2)	CH0 Not set X0 as High-speed counter 2-phase input (X0, X1) 2-phase input (X0, X1) Reset input (X2) Addition input (X0) Addition input (X0) Reset input (X2)

## 10.2 System Register Settings

Classification	No. and setting item	Settings
		Subtraction input (X0) Subtraction input (X0) Reset input (X2) Individual input (X0, X1) Individual input (X0, X1) Reset input (X2) Direction distinction (X0, X1) Direction distinction (X0, X1) Reset input (X2) J-point positioning start input of pulse output CH0 (X0)
		CH1 Not set X1 as High-speed counter Addition input (X1) Addition input (X1) Reset input (X2) Subtraction input (X1) Subtraction input (X1) Reset input (X2) J-point positioning start input of pulse output CH1 (X1)
		CH2 Not set X3 as High-speed counter 2-phase input (X3, X4) 2-phase input (X3, X4) Reset input (X5) Addition input (X3) Addition input (X3) Reset input (X5) Subtraction input (X3) Subtraction input (X3) Reset input (X5) Individual input (X3, X4) Individual input (X3, X4) Reset input (X5) Direction distinction (X3, X4) Direction distinction (X3, X4) Reset input (X5) J-point positioning start input of pulse output CH2 (X3)
	401 HSC operation mode setting (X3 to X5)	CH3 Not set X4 as High-speed counter Addition input (X4) Addition input (X4) Reset input (X5) Subtraction input (X4) Subtraction input (X4) Reset input (X5) J-point positioning start input of pulse output CH3 (X4)

(Note 1) Displayed item names and ranges vary according to the types of control unit.

(Note 2) Select "Not set XX as High Speed Counter" for the input that is not used for the high-speed counter function.

## 10.3 High-speed Counter Instruction

### 10.3.1 [F0 MV] High-speed Counter Control Instruction

Performs the controls such as the software reset, disabling the count and clearing the high-speed counter instruction.

#### ■ Instruction format

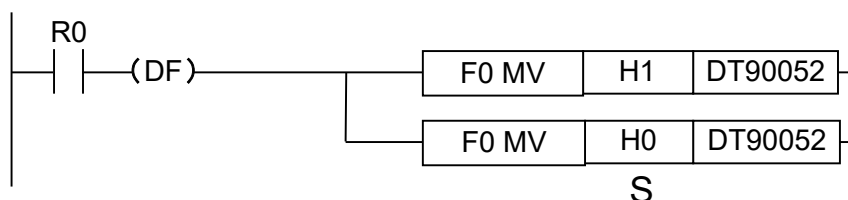

#### ■ Operand

Operand	Settings
S	Area storing the control code of the high-speed counter or constant data

#### ■ Memory area type that can be specified

Operand	WX	WY	WR	WL	SV	EV	DT	LD	I	Constant		Index modifier
										K	H	
S	•	•	•	•	•	•	•	•	•	•	•	•

#### ■ Outline of operation

- Performs the high-speed counter control according to the control code specified by [S].
- This instruction is used when performing the following operations with the high-speed counter.
  1. When performing the software reset
  2. When disabling the count
  3. When disabling the reset input by an external input temporarily
  4. When canceling the control executed by the high-speed counter instruction F165 (CAM0) / F166 (HC1S) / F167 (HC1R), when clearing the target value match interrupt
- The control codes once written are held until the next writing.
- The control code written by the F0 (MV) instruction is written to the special data register DT90052. At the same time, it is written to the control code monitor area. The written data is the data for lower 8 bits only.

#### ■ Precautions during programming

- The setting of disabling the rest input is valid only when allocating the reset input in the system register.
- In the external reset input setting, the reset input (X2 or X5) allocated to the internal input is switched between enable and disable.

## 10.3 High-speed Counter Instruction

### Allocation of control codes

- The following bits are allocated according to the specified channel and functions.

FP0H mode	FPsigma mode
<p>bit no. 15                      8                      3 2 1 0</p> <p>Channel specification H0 to H3: CH0 to CH3</p> <p>H0: Fixed</p> <p>High-speed counter instruction clear    0: Continue    1: Clear</p> <p>Reset input setting    0: Valid    1: Invalid</p> <p>Count    0: Enable    1: Disable</p> <p>Software reset    0: Disable    1: Enable</p>	<p>bit no. 15                      3 2 1 0</p> <p>Channel specification H0 to H3: CH0 to CH3</p> <p>High-speed counter instruction clear 0: Continue    1: Clear</p> <p>Reset input setting    0: Valid    1: Invalid</p> <p>Count    0: Enable    1: Disable</p> <p>Software reset    0: Disable    1: Enable</p>

- When controlling the above functions using external inputs, arbitrary inputs can be allocated.

### Example of program

The following example shows the program for performing the software reset of the high-speed counter CH0 using the input X7.

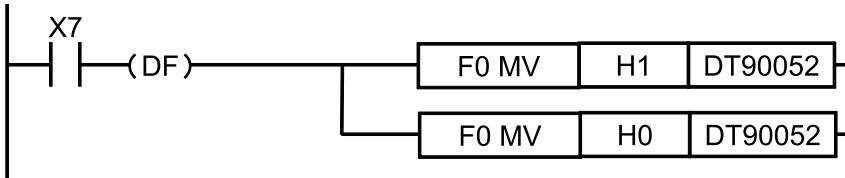

### **i** Info.

- For details of the allocations of I/O and flags, refer to "[12.2.4 When Using High-speed Counter Function](#)".
- For details of the FPsigma mode, refer to "[11 FPsigma Mode](#)".

### 10.3.2 F1 DMV (Pulse Output Elapsed Value Write/Read)

Writes and reads the elapsed value of the high-speed counter.

### ■ Instruction format

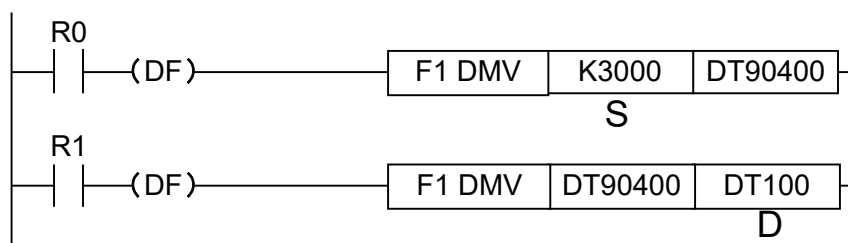

### ■ Operand

Operand	Settings
S	When setting: Area storing the elapsed value (32-bit) set in the high-speed counter or constant data K-2,147,483,648 to K2,147,483,647
D	When reading: Area reading the elapsed value of the high-speed counter

### ■ Memory area type that can be specified

Operand	WX	WY	WR	WL	SV	EV	DT	LD	I	Constant		Index modifier
										K	H	
S	•	•	•	•	•	•	•	•	•	•	•	•
D	-	•	•	•	•	•	•	•	•	-	-	•

### ■ Outline of operation (Reading elapsed value)

- Reads the content of the special data register storing the elapsed value of the high-speed counter and writes to the area specified by [D].

### ■ Outline of operation (Setting elapsed value)

- At the same time as writing the value to the elapsed value area of the high-speed counter which uses 32-bit data specified by [S], sets it in the elapsed value area of the high-speed counter used within the system.

### ■ Precautions during programming

- Only F1 (DMV) instruction can perform the writing. The writing cannot be performed by other high-level instructions such as transfer instruction F0 (MV) and arithmetic instructions.
- Specify the memory area of [S] or [D] with the memory area number for the lower 16 bits.

### 10.3.3 [F166 HC1S] High-speed Counter Target Value Match ON Instruction [F167 HC1R] High-speed Counter Target Value Match OFF Instruction

Turns on or off the specified output when the elapsed value of the high-speed counter matches the target value set by the operand.

## 10.3 High-speed Counter Instruction

### ■ Instruction format

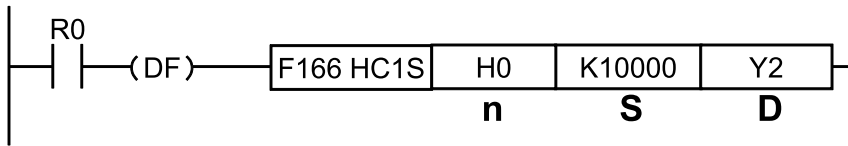

### ■ Operand

Operand	Settings
n	Target channel number of the high-speed counter for the match output
S	Target value data of the high-speed counter or the starting number of the area storing data
D	Output coil which turns on or off when the values match (Y0 to Y1F)

### ■ Memory area type that can be specified

Operand	WX	WY	WR	WL	SV	EV	DT	LD	I	Constant		Index modifier
										K	H	
n	-	-	-	-	-	-	-	-	-	•	•	-
S	•	•	•	•	•	•	•	•	•	•	•	•
D	-	-	-	-	-	-	-	-	-	-	-	-

### ■ Outline of operation

- Sets the value specified by [S] as the target value of the high-speed counter, and controls the specified output [Yn] when the elapsed value matches the target value. This operation is executed as an interrupt processing.
- In the case of [F166 HC1S] instruction, the output turns on from off. In the case of [F167 HC1R] instruction, the output turns off from on.
- Stores the value of [S] in the target value area when the instruction is executed.
- Clears the setting of the target value and the control of the target value match output when the value matches the target value.
- For resetting the output turned ON/OFF when the values match, use the RST instruction or F0 (MV) instruction, or use the F166 (HC1R) instruction and F167 (HC1R) instruction in a pair.

### ■ Example of program

The following example shows the program for setting the output Y0 when the elapsed value of the high-speed counter CH0 matches K10000.

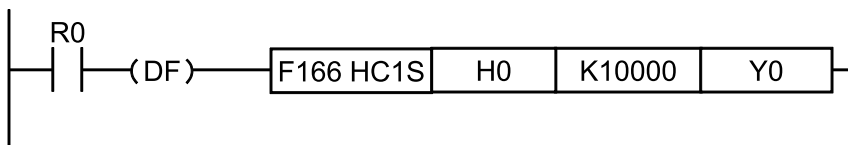

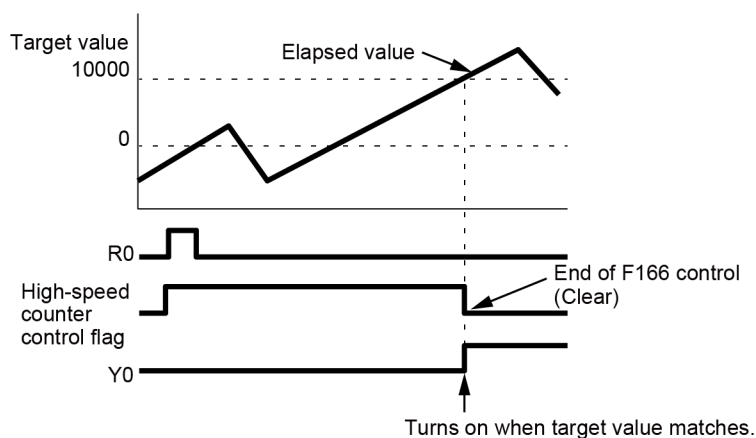

### ■ Precautions during programming

- The high-speed counter control flag turns on until the value matches the target value after the execution condition of the instruction has turned on. During this processing, the high-speed counter instruction F165 (CAM0)/F166 (HC1S)/F167 (HC1R) cannot be executed for the high-speed counter of the same channel.
- When the hardware reset is performed before the elapsed value matches the target value, the elapsed value will be reset. However, the settings of the target value and the target value match output will not be cleared.
- For the output Y specified for the target value match output, it is not checked whether the output is overlapped with the OT, KP and other high-level instructions.
- When describing the same channel in both the normal program and the interrupt program, be sure to program not to execute them simultaneously.

### **i** Info.

- For details of the allocations of I/O and flags, refer to "[12.2.4 When Using High-speed Counter Function](#)".
- For details of the FPsigma mode, refer to "[11 FPsigma Mode](#)".

### 10.3.4 Sample Program (Positioning Operation With Inverter: First Speed)

Counts the feedback signals from the encoder with the high-speed counter. The operation of the inverter stops when the count value reaches 5000.

## 10.3 High-speed Counter Instruction

### ■ Wiring example

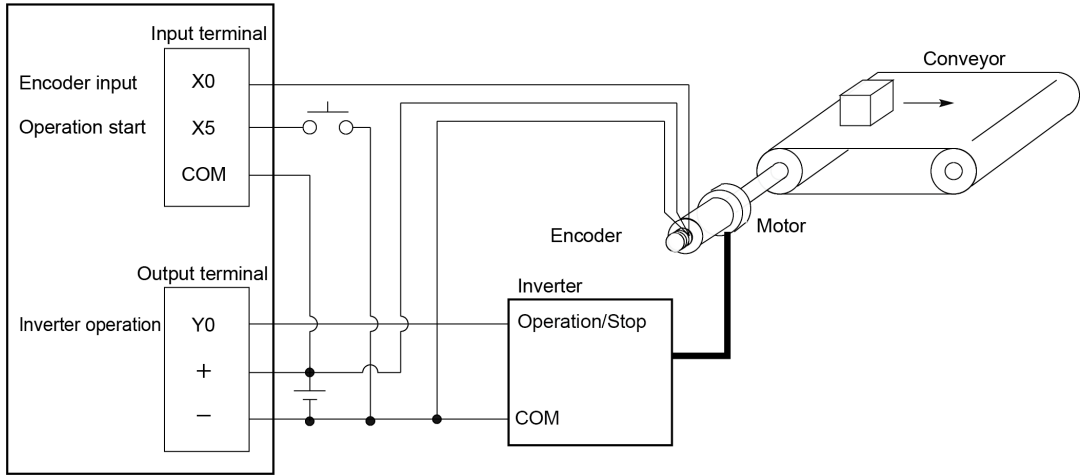

### ■ Operation chart

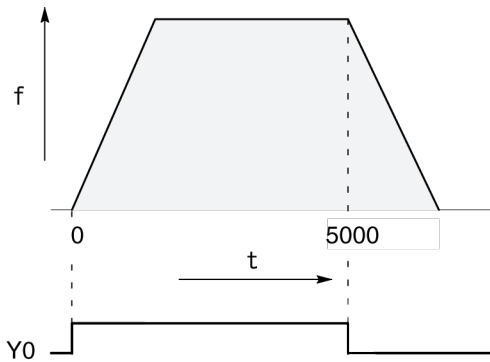

### ■ I/O allocation table

I/O no.	Description	I/O no.	Description
X0	Encoder input	R100	Positioning operation is running.
X5	Operation start signal	R101	Positioning operation start.
Y0	Inverter operation signal	R102	Positioning done pulse
-		R9110	High-speed counter CH0 control flag



### ■ Sample program

#### For FP0H mode

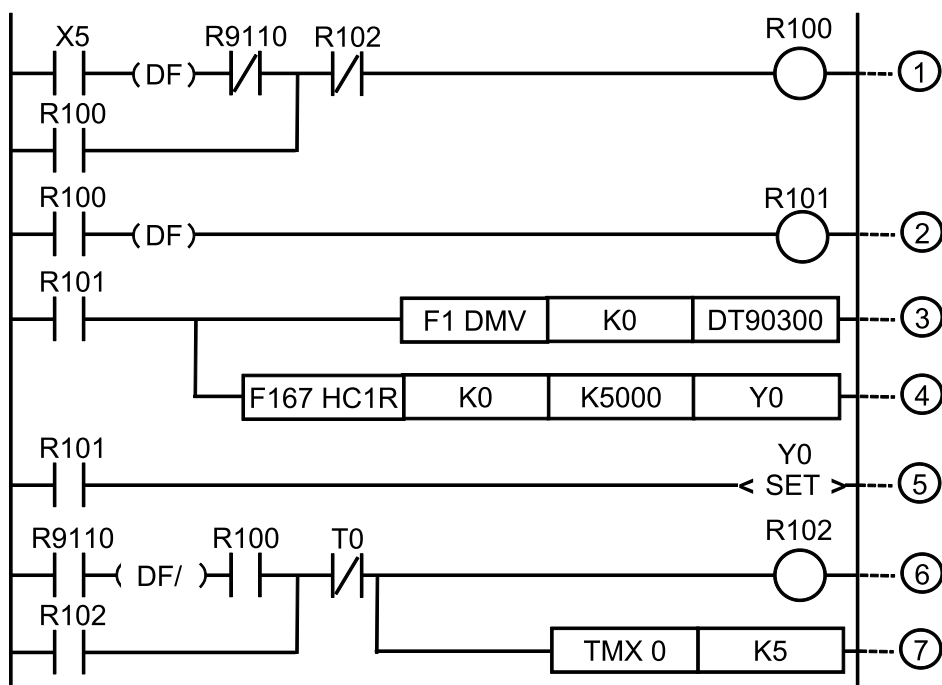

(1)	Positioning operation is running.
(2)	Positioning operation starts.
(3)	Resets the elapsed value of the high-speed counter CH0.
(4)	Target value match OFF instruction: Y0 turns off when the elapsed value of the high-speed counter reaches 5000 pulses.
(5)	Sets the inverter operation signal Y0.
(6)	Positioning done pulse (0.5 sec)
(7)	Sets 0.5 sec with 0.1-second timer.

(Note 1) The allocations of control active flags and elapsed value areas for the FPsigma mode are different. For details of the allocation of flags, refer to "12.2.4 When Using High-speed Counter Function".

### 10.3.5 Sample Program (Positioning Operation With Inverter: Second Speed)

Counts the feedback signals from the encoder with the high-speed counter. Switches the inverter operation to low speed operation when the count value reaches 4500. The operation of the inverter stops when the count value reaches 5000.

## 10.3 High-speed Counter Instruction

### ■ Wiring example

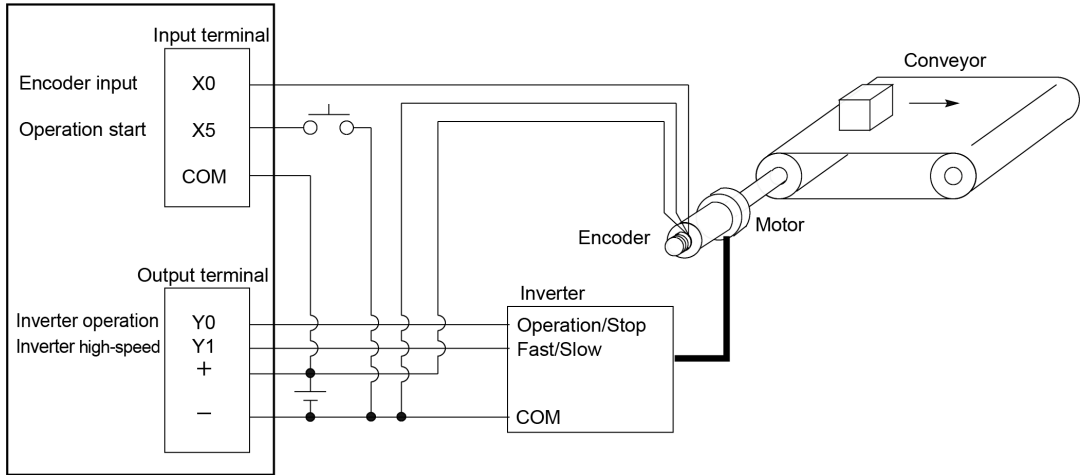

### ■ Operation chart

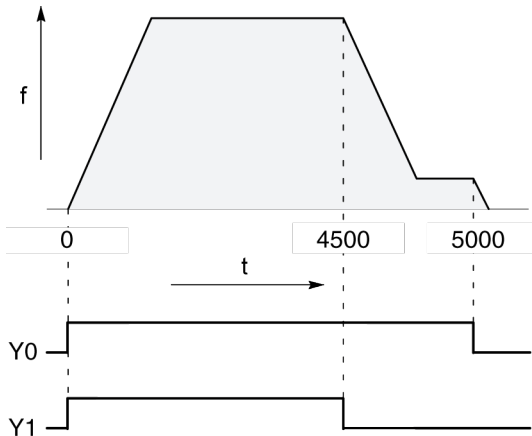

### ■ I/O allocation table

I/O no.	Description	I/O no.	Description
X0	Encoder input	R100	Positioning operation is running.
X5	Operation start signal	R101	Arrival at deceleration point
Y0	Inverter operation signal	R102	Positioning operation starts.
Y1	Inverter high-speed signal	R103	Positioning done pulse
-		R900C	Comparison instruction < Flag

## ■ Sample program

### For FP0H mode

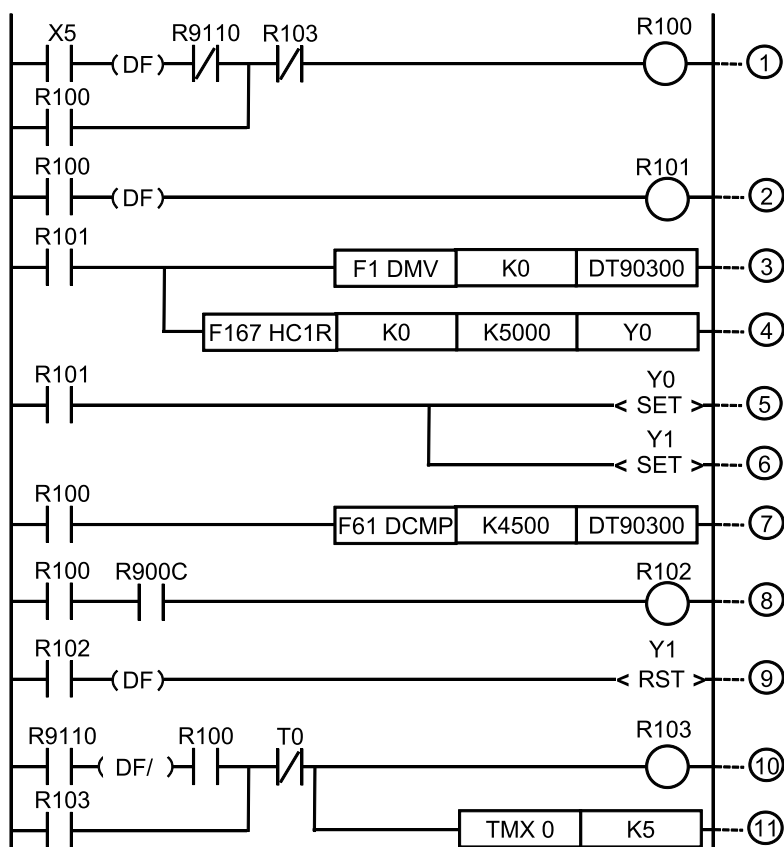

(1)	Positioning operation is running.
(2)	Positioning operation starts.
(3)	Resets the elapsed value of the high-speed counter CH0.
(4)	Target value match OFF instruction: Y0 turns off when the elapsed value of the high-speed counter CH0 reaches 5000 pulses.
(5)	Sets Y0 (inverter operation signal).
(6)	Sets Y1 (inverter high-speed signal).
(7)	32-bit data comparison instruction: R900C turns on when the elapsed value of the high-speed counter CH0 is larger than 4500 pulses.
(8)	Arrival at deceleration point
(9)	Resets Y1 (inverter high-speed signal).
(10)	Positioning done pulse (0.5 sec)
(11)	0.1-second timer: Sets K5. It is used as 0.5-second timer.

(Note 1) The allocations of control active flags and elapsed value areas for the FPsigma mode are different.  
For details of the allocation of flags, refer to "12.2.4 When Using High-speed Counter Function".

## 10.4 High-speed Counter Cam Control Instruction

### 10.4 High-speed Counter Cam Control Instruction

#### 10.4.1 [F165 CAM0] High-speed Counter Cam Control Instruction

Performs the cam output up to a maximum of 32 points (ON/OFF) according to the elapsed value of the high-speed counter.

##### ■ Instruction format

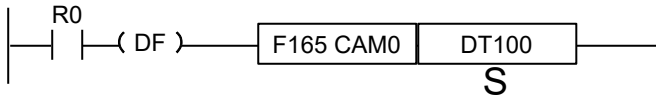

##### ■ Operand

Operand	Settings
S	Starting number of data table

##### ■ Memory area type that can be specified

Operand	WX	WY	WR	WL	SV	EV	DT	LD	I	Constant		Index modifier
										K	H	
S	-	-	-	-	-	-	•	-	-	-	-	•

##### ■ Outline of operation

- Performs the cam output up to a maximum of 32 points (ON/OFF) according to the elapsed value of the high-speed counter in the pattern specified for the data table starting with [S]. The output device can be selected from internal relay, output relay and link relay.
- The ON set value and OFF set value can be arbitrarily specified as a paired target values for a single cam output regardless of the magnitude of target values or the order for one cam output. The pattern of ON/OFF varies according to the setting.

## 10.4 High-speed Counter Cam Control Instruction

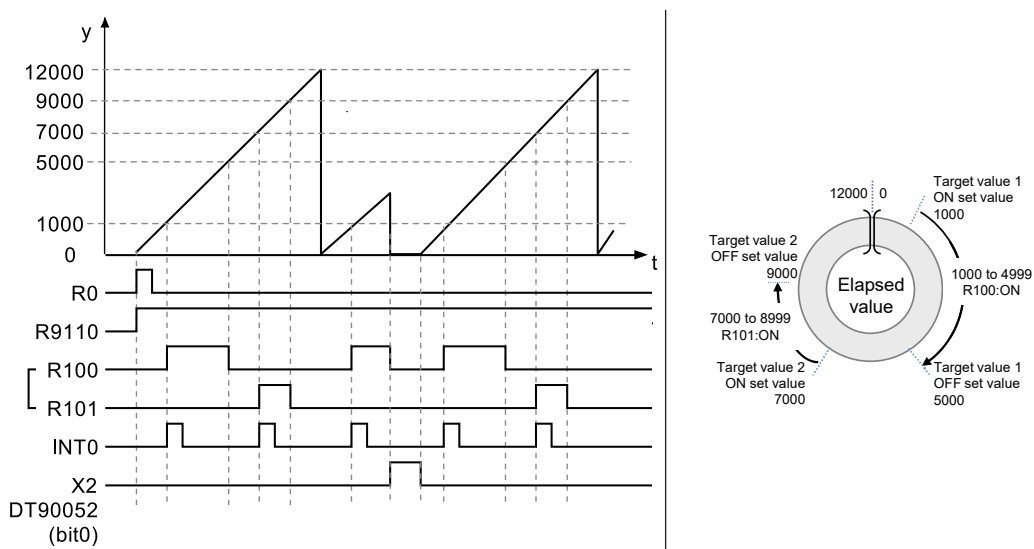

### ■ Upper limit control

With the F165 (CAM0) instruction, the control with a specified upper limit can be performed. The settings for enabling/disabling the upper limit control and the upper limit are specified in the data table.

		Upper limit control: Enable	Upper limit control: Disable
Counting range		0 to Upper limit	Negative min. value to Positive max. value
Operation when exceeding the counting range	When added	When the elapsed value exceeds the upper limit, it returns to 0.	When the elapsed value exceeds the positive maximum value, it returns to the negative minimum value.
	When subtracted	When the elapsed value falls below 0, it returns to the upper limit.	When the elapsed value falls below the negative minimum value, it returns to the positive maximum value.

### ■ Data table settings

Operand	Settings	Description
S, S+1	High-speed counter channel Upper and lower limit control	Specify the high-speed counter channel where the cam control is performed and whether or not to execute the upper and lower limit control as a hexadecimal constant.  <div style="text-align: center;"> </div> H0000: Fixed H00: Fixed Upper limit control 0: Disable, 1: Enable Channel specification H0 to H3: CH0 to CH3
S+2, S+3	Output device type (Note 1)	Specify the device type set for the cam output. H0: Link relay (L), H1: Internal relay (R), H2: Output relay (Y)

## 10.4 High-speed Counter Cam Control Instruction

Operand	Settings	Description
S+4, S+5	Starting word no. of output device	Specify the starting word number of the device set for the cam output. (Note 2)
S+6, S+7	No. of target values	Settable range: K1 to K32 (Note 2)
S+8, S+9	Target value 1: ON set value	Set the ON set value and OFF set value according to the number of target values. (Note 3) Settable range: K-2147483647 to K2147483646 (H80000001 to H7FFFFFFE) The cam output described in the next page is acquired according to the magnitude of the ON set values and elapsed value.
S+10, S+11	Target value 1: OFF set value	
S+12, S+13	Target value 2: ON set value	
S+14, S+15	Target value 2: OFF set value	
-----	-----	
S+(m-1)x4+8 S+(m-1)x4+9	Target value m: ON set value	
S+(m-1)x4+10 S+(m-1)x4+11	Target value m: OFF set value	
S+(m-1)x4+12 S+(m-1)x4+13	Upper limit (Note 4)	Settable range: K1 to K2147483646 (H1 to H7FFFFFFE)

(Note 1) When specifying the output relay (Y), values are also output to the CPU output as well as operation memories.

(Note 2) When the number of target values [S+6, S+7] is set to 1-16, the cam output is allocated to one word of output device. When set to 17-32, it is allocated to two words of output device. Refer to the next page for details.

(Note 3) The number of target values specified after [S+8, S+9] varies according to the number of target values specified in [S+6, S+7].

(Note 4) The upper limit of the data table end is valid only when the upper limit control is set to "Yes" in [S, S+1]. This setting can be omitted when the upper limit control is set to "No".

(Note 5) The data table varies in the range of 12 to 138 words according to the number of target values and the specified upper limit setting.

### ■ Specification of output device: [S+2] to [S+5]

- When the number of target values is set to 1-16, one word is used. When the number of target values is set to 17-32, two words are used.
- One device is allocated to a paired target values (ON set value and OFF set value).

(Example): When the output device type is set to "Internal relay", the starting word number of output device is set to "0", and the number of target values is set to "32", R0 to R1F are allocated as the device for the cam output.

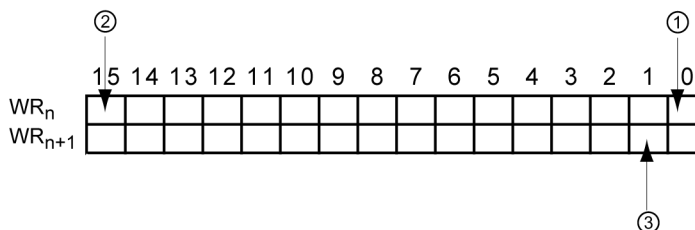

(1)	When the elapsed value reaches the target value 1, R0 turns on or off.
(2)	When the elapsed value reaches the target value 16, RF turns on or off.
(3)	When the elapsed value reaches the target value 18, R11 turns on or off.

### ■ Specification of target values: From [S+8]

The acquired output varies according to the ON set value and OFF set value.

	ON set value < OFF set value	ON set value > OFF set value	ON set value = OFF set value
When added			
When subtracted			
Description	When the elapsed value is larger than or equal to the ON set value and smaller than the OFF set value, the corresponding output bit turns on. When the elapsed value is out of the range, the corresponding bit turns off.	When the elapsed value is smaller than the ON set value and larger than or equal to the OFF set value, the corresponding output bit turns off. When the elapsed value is out of the range, the corresponding bit turns on.	When the elapsed value is out of the range, the corresponding bit turns off.

### ■ Precautions during programming

- This instruction cannot be used when the high-speed counter function is not used. Allocate arbitrary channels and contacts in the system register "high-speed counter setting".
- The high-speed counter control flag corresponding to the specified channel turns on until the execution of the high-speed counter control instruction F0 (MV) is cleared after the execution condition of the F165 (CAM0) instruction has turned on. When the high-speed counter control flag is on, the high-speed counter control instruction F165 (CAM0)/F166 (HC1S)/F167 (HC1R) for which the same channel is specified cannot be executed.
- This instruction can be activated for up to two channels simultaneously.
- To stop the control of this instruction, execute "Clear high-speed counter instruction" by the high-speed counter control instruction F0 (MV). Even when executing "Clear high-speed counter instruction", the output allocated to the cam output is held. Also, the counting of the high-speed counter continues and the upper limit control becomes disabled.
- Reset or preset the high-speed counter elapsed value before activating the instruction.
- Do not rewrite the elapsed value for the control using the F1 (DMV) instruction after the execution of the instruction. After the execution of the instruction, the setting of the active target values do not change even if the operation memory of the specified target values (ON set value/OFF set value) is changed.

## 10.4 High-speed Counter Cam Control Instruction

- When controlling the output device using the main program, set each target value so that "minimum moving time between each target value" is larger than "1 scan time".
- When controlling the output device using an interrupt program, set each target value so that "minimum moving time between each target value" is larger than "maximum execution time of interrupt program".
- When the maximum value control and the hardware/software reset is used at the same time, do not operate them intensively in a short time.
- When hardware/software reset is used, set the minimum target value to an integer value that is 1 or more.
- When the hardware reset or software reset is executed during the high-speed counter control, the high-speed counter elapsed value is reset to 0. The output allocated to the cam output will be the output according to the elapsed value 0.
- It is also possible to start the interrupt program INTn every time the elapsed value reaches each target value. For this operation, the activation of the interrupt program should be permitted by the interrupt control instruction ICTL.

### **i** Info.

- For details of the allocations of I/O and flags, refer to "12.2.4 When Using High-speed Counter Function".
- For details of the FPsigma mode, refer to "11 FPsigma Mode".

### 10.4.2 Sample Program (Upper Limit Control, Reset, Addition)

The following shows the program for performing two cam outputs (R100, R101) according to the elapsed value of the high-speed counter CH0. When the elapsed value reaches the target value (ON set value), the cam output turns on, and when it reaches the target value (OFF set value), it turns off. When it reaches the target value (ON set value), the interrupt program is started. When the elapsed value exceeds the upper limit, it returns to 0.

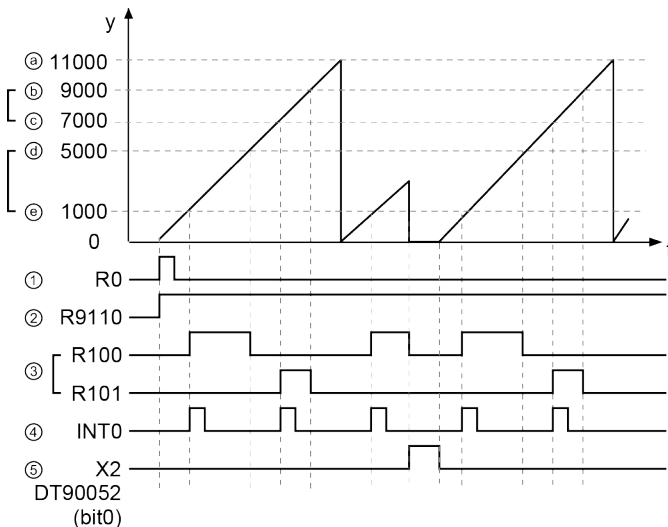

Code	Value	Description
(a)	Upper limit	When the elapsed value exceeds the upper limit, it returns to 0.



## 10.4 High-speed Counter Cam Control Instruction

Code	Value	Description
(b)	Target value 2: OFF set value	<p>The cam output is performed according to the target values.</p> <p>In this example, the ON set value is smaller than the OFF set value for each target value.</p> <p>Therefore, When added: When the elapsed value reaches the ON set value, the cam output turns ON, and when it reaches the OFF set value, it turns OFF.</p> <p>When subtracted: When the elapsed value falls below the OFF set value, the cam output turns ON, and when it falls below the ON set value, it turns OFF.</p>
(c)	Target value 2: ON set value	
(d)	Target value 1: OFF set value	
(e)	Target value 1: ON set value	
(1)	Execution condition	
(2)	High-speed counter instruction active flag	The high-speed counter instruction active flag turns ON during the execution of the instruction. Even when the reset signal exists, the execution of the instruction continues.
(3)	Cam output	The output turns ON/OFF according the set values.
(4)	Interrupt	When the elapsed value reaches the ON set value, the interrupt program starts.
(5)	Reset signal	When the hardware reset (X2) or software reset DT90052 (bit 0) turns ON, the elapsed value of the high-speed counter is rest to 0. The outputs corresponding to the elapsed value 0 which both R100 and R101 become OFF in the above example.

(Note 1) It shows the hardware reset input (X2) for the high-speed counter CH0.

### ■ Sample program

#### For FP0H mode

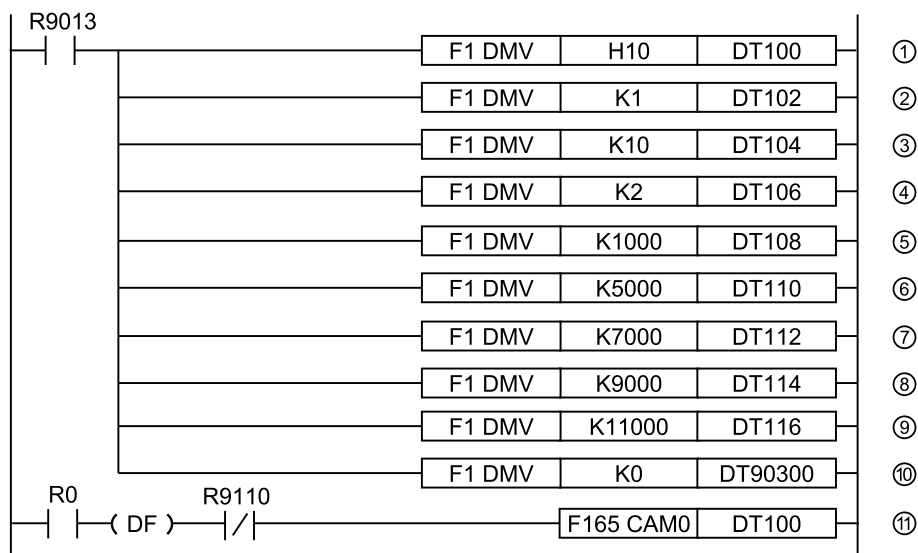

Code	Description
(1)	High-speed counter channel H10: Performs the upper limit control. CH0
(2)	Cam output device type K1: Internal relay (R)
(3)	Word number of cam output device K10

## 10.4 High-speed Counter Cam Control Instruction

Code	Description
(4)	Specification of the number of target values K2
(5)	Target value 1: ON set value K1000
(6)	Target value 1: OFF set value K5000
(7)	Target value 2: ON set value K7000
(8)	Target value 2: OFF set value K9000
(9)	Upper limit value K11000
(10)	Presets 0 as the elapsed value.
(11)	Executes the F165 (CAM0) instruction and starts the cam control.

(Note 1) The allocations of control active flags and elapsed value areas for the FPsigma mode are different. For details of the allocation of flags, refer to "12.2.4 When Using High-speed Counter Function".

### 10.4.3 Sample Program (Upper Limit Control, Instruction Clear, Addition)

The following shows the program for performing two cam outputs (R100, R101) according to the elapsed value of the high-speed counter CH0. In the case of addition, when the elapsed value reaches the target value (ON set value), the cam output turns on, and when it reaches the target value (OFF set value), it turns off. When it reaches the target value (ON set value), the interrupt program is started. When the elapsed value exceeds the upper limit, it returns to 0. The instruction is cleared by the high-speed counter control instruction F0 (MV).

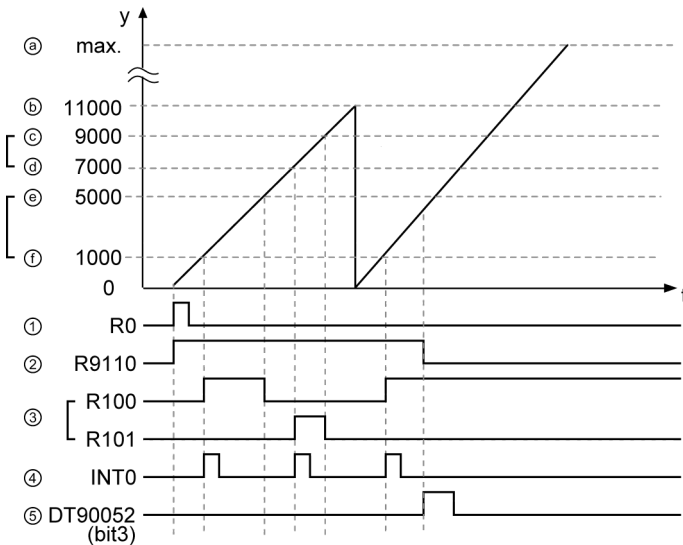

Code	Value	Description
(a)	Positive maximum value	When the instruction clear is executed, the upper limit control is canceled and the counting continues up to the positive maximum value.
(b)	Upper limit	When the elapsed value exceeds the upper limit, it returns to 0.
(c)	Target value 2: OFF set value	The cam output is performed according to the target values. In this example, the ON set value is smaller than the OFF set value for each target value. Therefore,

## 10.4 High-speed Counter Cam Control Instruction

Code	Value	Description
(d)	Target value 2: ON set value	When added: When the elapsed value reaches the ON set value, the cam output turns ON, and when it reaches the OFF set value, it turns OFF. When subtracted: When the elapsed value falls below the OFF set value, the cam output turns ON, and when it falls below the ON set value, it turns OFF.
(e)	Target value 1: OFF set value	
(f)	Target value 1: ON set value	
(1)	Execution condition	When the execution condition turns ON from OFF, the instruction is executed and the cam control starts.
(2)	High-speed counter instruction active flag	The high-speed counter instruction active flag turns ON during the execution of the instruction. When the high-speed counter control instruction F0 (MV) is executed, it turns OFF.
(3)	Cam output	The output turns ON/OFF according the set values.
(4)	Interrupt	In the case of addition, when the elapsed value reaches the ON set value, the interrupt program is started.
(5)	Clear high-speed counter instruction	By the high-speed counter control instruction F0 (MV), when the bit 3 of the special data register DT90052 turns ON from OFF, the executed F165 (CAM0) instruction is cleared.

### ■ Sample program

#### For FP0H mode

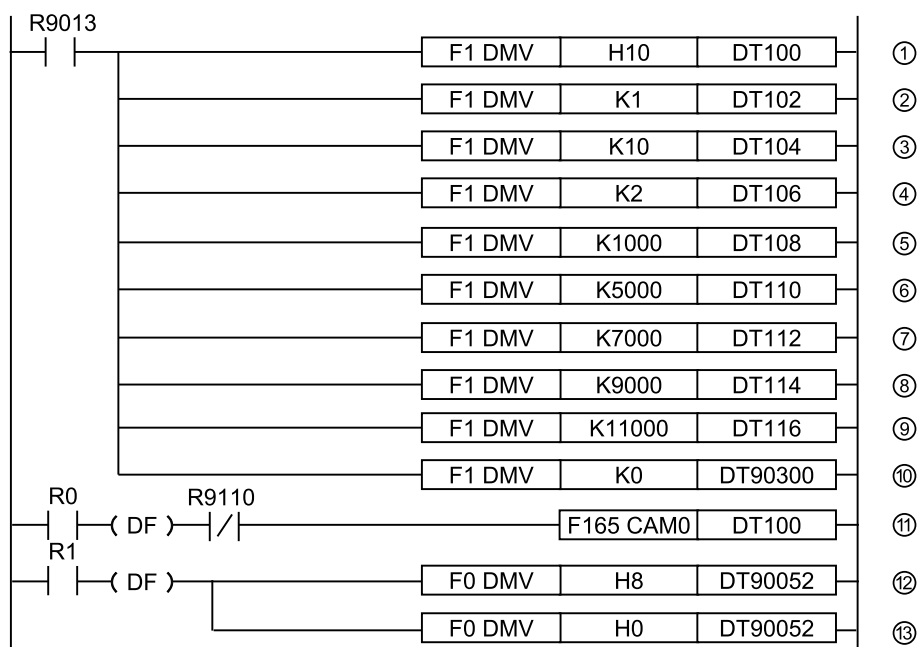

Code	Description
(1)	High-speed counter channel H10: Performs the upper limit control. CH0
(2)	Cam output device type K1: Internal relay (R)
(3)	Word number of cam output device K10

## 10.4 High-speed Counter Cam Control Instruction

Code	Description
(4)	Specification of the number of target values K2
(5)	Target value 1: ON set value K1000
(6)	Target value 1: OFF set value K5000
(7)	Target value 2: ON set value K7000
(8)	Target value 2: OFF set value K9000
(9)	Upper limit value K11000
(10)	Presets 0 as the elapsed value.
(11)	Executes the F165 (CAM0) instruction and starts the cam control.
(12)	Clears the executed F165 (CAM0) instruction by turning the DT90052 (bit 3) off -> on -> off.

(Note 1) The allocations of control active flags and elapsed value areas for the FPsigma mode are different. For details of the allocation of flags, refer to "12.2.4 When Using High-speed Counter Function".

### 10.4.4 Sample Program (Upper Limit Control, Subtraction)

The following shows the program for performing three cam outputs (R100-R102) according to the elapsed value of the high-speed counter CH0. In the case of subtraction, when the elapsed value falls below the target value (OFF set value), the cam output turns off, and when it falls below the target value (ON set value) the cam output turns on. When it falls below the target value (OFF set value), the interrupt program is started. When the elapsed value falls below 0, it returns to the upper limit.

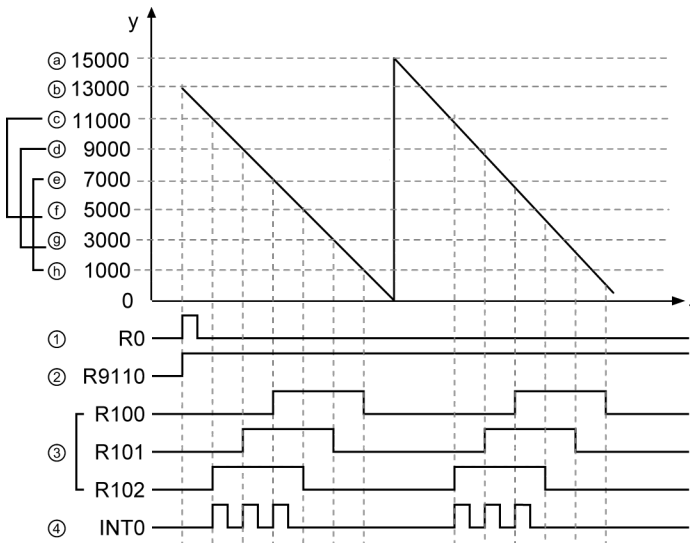

Code	Value	Description
(a)	Upper limit	When the elapsed value falls below 0, it returns to the upper limit.
(b)	Elapsed value	The control is started from the elapsed value when executed. In this example, the elapsed value 13000 is preset.

## 10.4 High-speed Counter Cam Control Instruction

Code	Value	Description
(c)	Target value 3: OFF set value	<p>The cam output is performed according to the target values.</p> <p>In this example, the ON set value is smaller than the OFF set value for each target value. Therefore,</p> <p>When subtracted: When the elapsed value falls below the OFF set value, the cam output turns ON, and when it falls below the ON set value, it turns OFF.</p> <p>When added: When the elapsed value reaches the ON set value, the cam output turns ON, and when it reaches the OFF set value, it turns OFF.</p>
(d)	Target value 2: OFF set value	
(e)	Target value 1: OFF set value	
(f)	Target value 3: ON set value	
(g)	Target value 2: ON set value	
(h)	Target value 1: ON set value	
(1)	Execution condition	
(2)	High-speed counter instruction active flag	The high-speed counter instruction active flag turns ON during the execution of the instruction.
(3)	Cam output	The output turns ON/OFF according the set values.
(4)	Interrupt program activation	In the case of subtraction, when the elapsed value falls below the OFF set value, the interrupt program is started.

### ■ Sample program

#### For FP0H mode

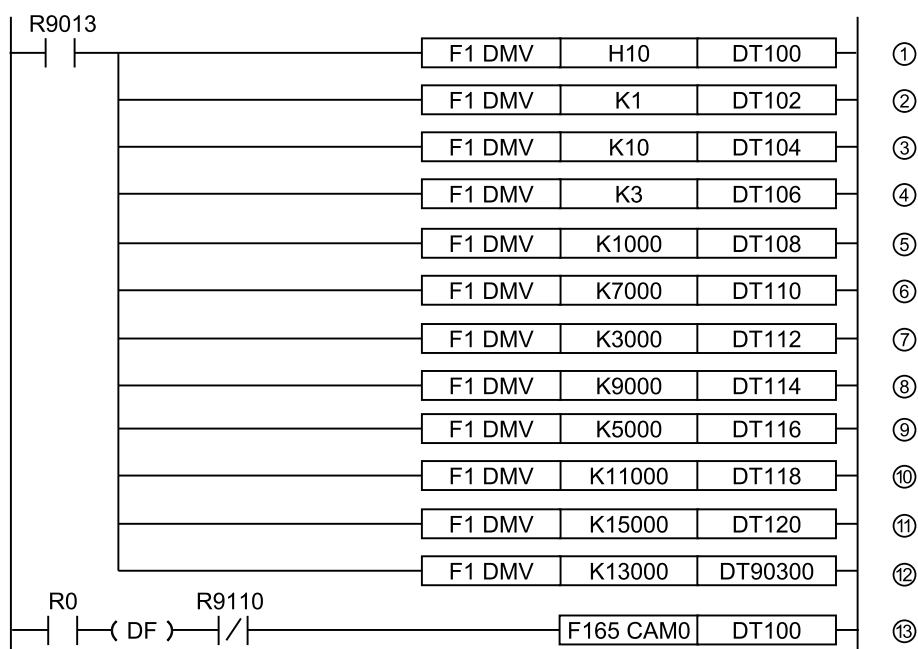

Code	Description
(1)	High-speed counter channel H10: Performs the upper limit control. CH0

## 10.4 High-speed Counter Cam Control Instruction

---

Code	Description
(2)	Cam output device type K1: Internal relay (R)
(3)	Word number of cam output device K10
(4)	Specification of the number of target values K3
(5)	Target value 1: ON set value K1000
(6)	Target value 1: OFF set value K7000
(7)	Target value 2: ON set value K3000
(8)	Target value 2: OFF set value K9000
(9)	Target value 3: ON set value K5000
(10)	Target value 3: OFF set value K11000
(11)	Upper limit value K15000
(12)	Presets 13000 as the elapsed value.
(13)	Executes the F165 (CAM0) instruction and starts the cam control.

(Note 1) The allocations of control active flags and elapsed value areas for the FPsigma mode are different. For details of the allocation of flags, refer to "[12.2.4 When Using High-speed Counter Function](#)".

## 10.5 Interrupt Program Activation

### 10.5.1 Overview of Function

When the elapsed value reaches the target value while the high-speed counter instruction F165 (CAM0)/F166 (HC1S)/F167 (HC1R) is being executed, the interrupt program can be activated.

#### ■ Execution method

- Make the setting for the high-speed counter by system registers. There is no need to make the setting of interrupt input.
- Describe the interrupt program as a sub program.
- Allow the execution of a corresponding interrupt program number by the ICTL instruction in the main program.
- Execute the F165 (CAM0)/F166 (HC1S)/F167 (HC1R) instruction. When the elapsed value of the high-speed counter reaches the target value, the interrupt program is activated.

#### For FP0H mode

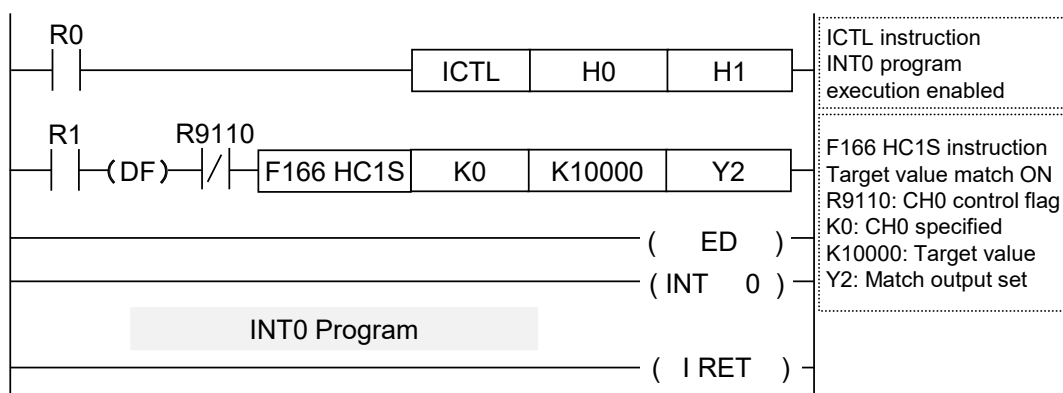

#### ■ Corresponding channel numbers and interrupt program numbers

Channel No.	INT number
CH0	INT0
CH1	INT1
CH2	INT3
CH3	INT4

(Note 1) The allocations of control active flags and elapsed value areas for the FPsigma mode are different. For details of the allocation of flags, refer to "12.2.4 When Using High-speed Counter Function".

### 10.5.2 Interrupt Activation When F165 (CAM0) is Executed

For the cam control instruction F165 (CAM0), the start condition varies according to the magnitude of the ON set value and OFF set value. Also, the interrupt program is activated with each target value of up to 32 points.

## 10.5 Interrupt Program Activation

### ■ Activation of interrupt program

	ON set value < OFF set value	ON set value > OFF set value	ON set value = OFF set value
When added			
When subtracted			
Description	When the elapsed value is larger than or equal to the ON set value and smaller than the OFF set value, the interrupt program is activated.	When the elapsed value is smaller than the ON set value and larger than or equal to the OFF set value, the interrupt program is activated.	When the elapsed value reaches the ON set value (= OFF set value), the interrupt program is activated.



# 11 FPsigma Mode

---

11.1 Overview of FPsigma Mode .....	11-2
11.2 Converting Projects for FPsigma to Projects for FP0H (FPsigma Mode).....	11-4
11.3 Converting Projects for FP0H (FPsigma Mode) to Projects for FP0H (FP0H Mode) .....	11-5
11.4 Differences in Positioning Instructions with FPsigma.....	11-6
11.4.1 High-speed Counter/Pulse Output Control Instruction F0(MV) .....	11-6
11.4.2 High-speed Counter Instructions F165 (CAM0), F166 (HC1S), F167 (HC1R).....	11-7
11.4.3 Pulse/PWM Output Control Instructions.....	11-8

## 11.1 Overview of FPsigma Mode

### 11.1 Overview of FPsigma Mode

FPsigma mode is a mode for using projects for the existing model FPsigma series in FP0H. Although some functions of FP0H are limited, compatibility with FPsigma is maintained.

#### ■ Comparison of specifications

Item	Specifications			
		Conventional model FPsigma series	FP0H series	
			FPsigma mode	FP0H mode Values in [ ] are for C32E only.
Program capacity <sup>(Note 1)</sup>		32K steps	24K / 32K steps	24K / 32K / [40K / 64K] steps
Data register capacity <sup>(Note 1)</sup>		32765 words	65533 / 32765 words	65533 / 32765 / [24573 / 12285] words
Automatic backup in case of power outage <sup>(Note 2)</sup>	Internal relay	R2480 to R255F (Fixed)	R2480 to R255F (Fixed)	R5040 to R511F [R2480 to R255F]
	Data register	DT32710 to DT32764 (Fixed)	DT32710 to DT32764 (Fixed)	[DT11970 to DT12284 DT24258 to DT24572] DT32450 to DT32764 DT65218 to DT65532
Pulse/PWM output setting (System register no. 402)		No setting	Cannot be set.	Can be set.
Positioning control mode (System register no. 407)		Cannot be set.	FPsigma compatible instruction mode (Fixed)	Select from table setting mode or FPsigma compatible instruction mode.
Value when system registers are initialized	No.7	248 (Fixed)	248 (Fixed)	[C32] Initialize according to system register no. 1. [C32E] 504 (Fixed)
	No.8	32710 (Fixed)	32710 (Fixed)	Initialize according to system register no. 0.
	No.407	Cannot be set.	FPsigma compatible instruction mode	Table setting mode
	No.430 to No.433	Cannot be set.	No setting	1 ms

(Note 1) The program capacity and data register capacity can be changed according to the setting of system register no. 0.

(Note 2) In the FP0H mode, the automatic backup areas for internal relays and data registers vary according to the settings of system register nos. 0 and 1.

Item	Specifications		
	Conventional model FPsigma series	FP0H series	
		FPsigma mode	FP0H mode Values in [ ] are for C32E only.
Potentiometer input (DT90040/90041)	K0 to K1000	K0 to K1000 (C32 only)	K0 to K4000 (C32 only)

Item	Specifications		
	Conventional model FPsigma series	FP0H series	
		FPsigma mode	FP0H mode Values in [ ] are for C32E only.
High-speed counter/Pulse output <sup>(Note 1)</sup>	4 ch / 2 ch High-speed counter and pulse output share the same memory area	4 ch / 2 ch High-speed counter and pulse output share the same memory area	4 ch / 4 ch High-speed counter and pulse output use independent memory areas

(Note 1) for the details of the high-speed counter/pulse output functions, refer to *FP0H User's Manual (Positioning/PWM Output/High-speed Counter)*.

## 11.2 Converting Projects for FPsigma to Projects for FP0H (FPsigma Mode)

### 11.2 Converting Projects for FPsigma to Projects for FP0H (FPsigma Mode)

Projects for the conventional model FPsigma can be converted to projects for FP0H (FPsigma mode) by the "Convert PLC Type" function. The following procedure is explained on the condition that a project for FPsigma has been already started on FPWIN GR7.

#### 12 Procedure

1. Select **Tools>Convert PLC Type** in the menu bar.
2. Select "FP0H" from the list on the left.

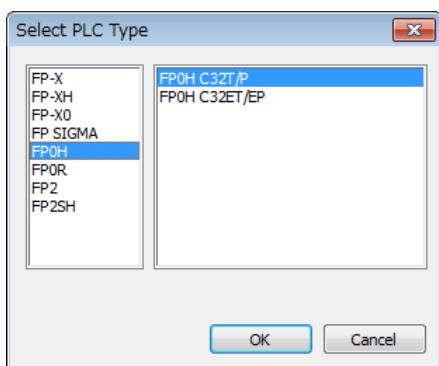

3. Select "FP0H C32T/P" or "FP0H C32ET/EP" and press the [OK] button.
4. The "Convert PLC Type" function will be executed and the project for FPsigma will be converted to the project for FP0H.

#### **i** Info.

- Whether the project file is in FP0H mode or FPsigma mode can be confirmed by using system register no. 3 "Compatible mode setting".
- For details of how to confirm this, refer to "11.3 Converting Projects for FP0H (FPsigma Mode) to Projects for FP0H (FP0H Mode)".

### 11.3 Converting Projects for FP0H (FPsigma Mode) to Projects for FP0H (FP0H Mode)

Projects for FP0H (FPsigma mode) can be converted to projects for FP0H (FP0H mode) by setting the system register number 3. The following procedure is explained on the condition that a project for FP0H (FPsigma mode) has been already started on FPWIN GR7.

#### **i** Info.

- Please change the system registers number 3 offline.

#### **1 2** Procedure

1. Select **Options>System register settings** from the menu bar.
2. Select "Compatible mode" from the list on the left.

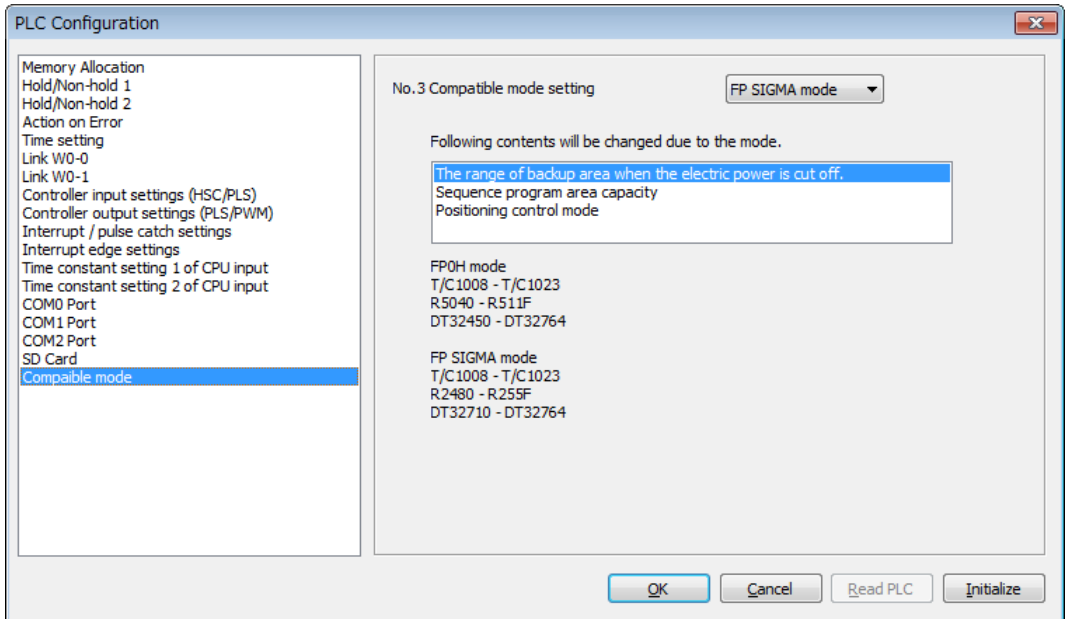

3. Change "No.3 Compatible mode setting" to "FP0H mode" and press the [OK] button.
4. Select **Online>Download to PLC (Entire Project)** from the menu bar.

# 11.4 Differences in Positioning Instructions with FPsigma

## 11.4 Differences in Positioning Instructions with FPsigma

### 11.4.1 High-speed Counter/Pulse Output Control Instruction F0(MV)

For the FPsigma mode, the following contents are common to FPsigma.

- Control code monitor area
- Allocation of control codes

■ Control code monitor area

Channel no.	Conventional model FPsigma series	FP0H series	
		FPsigma mode	FP0H mode
CH0	DT90190	DT90190	DT90380
CH1	DT90191	DT90191	DT90381
CH2	DT90192	DT90192	DT90382
CH3	DT90193	DT90193	DT90383

■ Allocation of control codes

#### Conventional model FPsigma and FP0H series (FPsigma mode)

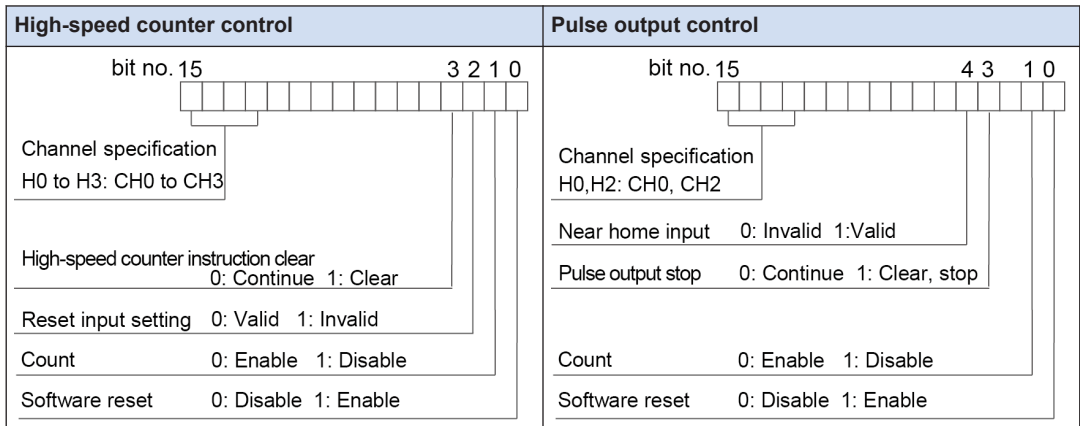

#### FP0H series (FP0H mode)

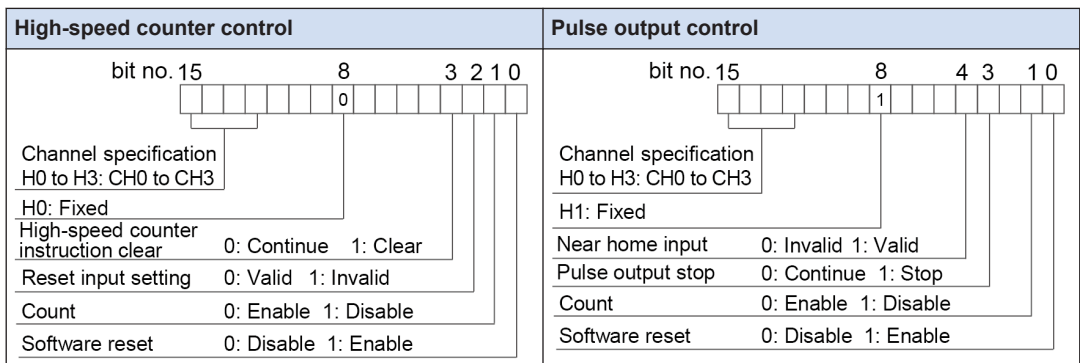

### 11.4.2 High-speed Counter Instructions F165 (CAM0), F166 (HC1S), F167 (HC1R)

For the FPsigma mode, the following contents are common to FPsigma.

- Operations when instructions are executed
- Allocation of memory areas

#### ■ Operations when instructions are executed

In the FP0H mode, operations vary according to the system register no. 402 "Pulse/PWM output settings".

Instruction	Conventional model FPsigma series	FP0H series	
		FPsigma mode	FP0H mode
F165(CAM0)	No instruction	No system register setting	When the destination Y* when the target value matches is other than the normal output setting, an operation error occurs.
F166(HC1S) F167(HC1R)	No system register setting	No system register setting	When the destination Y* when the target value matches is other than the normal output setting, an operation error occurs.

#### ■ Allocation of memory areas

##### Conventional model FPsigma series and FP0H series (FPsigma mode)

Channel no.	Input	Reset input	Elapsed value	Target value	Control flag
CH0	X0	X2	DT90044 DT90045	DT90046 DT90047	R903A
CH1	X1	X2	DT90048 DT90049	DT90050 DT90051	R903B
CH2	X3	X5	DT90200 DT90201	DT90202 DT90203	R903C
CH3	X4	X5	DT90204 DT90205	DT90206 DT90207	R903D

##### FP0H series (FP0H mode)

Channel no.	Input	Reset input	Elapsed value	Target value	Control flag
CH0	X0	X2	DT90300 DT90301	DT90302 DT90303	R9110
CH1	X1	X2	DT90304 DT90305	DT90306 DT90307	R9111
CH2	X3	X5	DT90308 DT90309	DT90310 DT90311	R9112
CH3	X4	X5	DT90312 DT90313	DT90314 DT90315	R9113

## 11.4 Differences in Positioning Instructions with FPsigma

### 11.4.3 Pulse/PWM Output Control Instructions

For the FPsigma mode, the following contents are common to FPsigma. However, the designation of PWM control codes is different.

- Operations when instructions are executed
- Allocation of memory areas

#### ■ Operations when instructions are executed

Item	Conventional model	FP0H series		Instruction
	FPsigma series	FPsigma Mode	FP0H mode	
Channel specification	CH0/CH2	CH0/CH2	CH0 to CH3	F171(SPDH) F172(PLSH) F174(SPOH) F173(PWMH)
	CH0	CH0	CH0/CH2	F175(SPSH)
System register no. 402 "Pulse/PWM output settings"	No setting	No setting	When the specified channel is other than "Pulse output (Y*, Y*)", an operation error occurs.	F171(SPDH) F172(PLSH) F174(SPOH) F175(SPSH)
	No setting	No setting	When the specified channel is "Normal output (Y*)", an operation error occurs.	F173(PWMH)
PLC system register nos. 400 and 401 "HSC operation mode settings"	When the specified channel is other than "Not Set X* as High Speed Counter", pulse output is not performed.	When the specified channel is other than "Not Set X* as High Speed Counter", pulse output is not performed.	Not check	F171(SPDH) F172(PLSH) F174(SPOH) F175(SPSH)
Specification of acceleration/ deceleration time by initial speed correction	No setting	The initial speed is set in the initial speed area (special DT).	The initial speed is set in the initial speed area (special DT).	F171(SPDH)
Specification of calculation only (internal table creation only)	Not available	Available by the specification of control code	Available by the specification of control code	F171(SPDH)
Quick start	Not available Calculation (internal table creation) is performed every time.	Available When the setting is the same as the previous setting, calculation (internal table creation) is not performed.	Available When the setting is the same as the previous setting, calculation (internal table creation) is not performed.	F171(SPDH)



## 11.4 Differences in Positioning Instructions with FPsigma

### ■ Allocation of memory areas

#### Conventional model FPsigma series and FP0H series (FPsigma mode)

Channel no.	CW or pulse output	CCW or sign output	Deviation counter clear output	Home input	Elapsed value area	Target value area	Control flag	Correction speed area of initial speed
CH0	Y0	Y1	Y2	X2	DT90044 DT90045	DT90046 DT90047	R903A	DT90400 DT90401
CH2	Y3	Y4	Y5	X5	DT90200 DT90201	DT90202 DT90203	R903C	DT90404 DT90405

#### FP0H series (FP0H mode)

Channel no.	CW or pulse output	CCW or sign output	Deviation counter clear output	Home input	Elapsed value area	Target value area	Control flag	Correction speed area of initial speed
CH0	Y0	Y1	Y2	X2	DT90348 DT90349	DT90350 DT90351	R911C	DT90400 DT90401
CH1	Y3	Y4	Y5	X5	DT90352 DT90353	DT90354 DT90355	R911D	DT90402 DT90403
CH2	Y8	Y9	YA	X6	DT90356 DT90357	DT90358 DT90359	R911E	DT90404 DT90405
CH3	YB	YC	YD	X7	DT90360 DT90361	DT90362 DT90363	R911F	DT90406 DT90407

### ■ Operation of PWM output instruction (F173 PWMH)

Item	Conventional mode FPsigma series	FP0H series (FP0H mode/FPsigma mode)			
Frequency	1.5 Hz to 41.7 kHz	1 Hz to 100 kHz			
Duty ratio	0 to 99.9%	0 to 100%			
Frequency setting	Specify by integers.				
	Not available	Specify the output frequency in 2-word 32-bit data. Setting range: K1 to K100000 (1 Hz to 100 kHz: in 1 Hz increments)			
	Specify by control codes.				
	It can be set to any of 25 levels in the table below by control codes.	It can be set to any of 31 levels in the table below by control codes.			
	Setting	Frequency (Hz)	Resolution	Setting	Frequency (Hz)
K0	1.5	1000	K0	1.5	1000
K1	2.0	1000	K1	2.0	1000

## 11.4 Differences in Positioning Instructions with FPsigma

Item	Conventional mode			FP0H series		
	FPsigma series			(FP0H mode/FPsigma mode)		
	K2	4.1	1000	K2	4.0	1000
	K3	6.1	1000	K3	6.0	1000
	K4	8.1	1000	K4	8.0	1000
	K5	9.8	1000	K5	10.0	1000
	K6	19.5	1000	K6	20.0	1000
	K7	48.8	1000	K7	50.0	1000
	K8	97.7	1000	K8	100.0	1000
	K9	201.6	1000	K9	200.0	1000
	K10	403.2	1000	K10	400.0	1000
	K11	500.0	1000	K11	500.0	1000
	K12	694.4	1000	K12	700.0	1000
	K13	1.0k	1000	K13	1.0k	1000
	K14	1.3k	1000	K14	1.3k	1000
	K15	1.6k	1000	K15	1.6k	1000
	K16	2.1k	1000	K16	2.0k	1000
	K17	3.1k	1000	K17	3.0k	1000
	K18	6.3k	1000	K18	6.0k	1000
	K19	12.5k	1000	K19	12.5k	1000
	K20	15.6k	100	K20	15.0k	1000
	K21	20.8k	100	K21	20.0k	1000
	K22	25.0k	100	K22	25.0k	1000
	K23	31.3k	100	K23	30.0k	1000
	K24	41.7k	100	K24	40.0k	1000
	-			K25	50.0k	1000
	-			K26	60.0k	1000
	-			K27	70.0k	1000
	-			K28	80.0k	100
	-			K29	90.0k	100
	-			K30	100.0k	100

(Note 1) For details of the operation of PWM output instructions, refer to "9.1.3 [F173 PWMH] PWM Output Instruction (Frequency Specification)" and "9.1.4 [F173 PWMH] PWM Output Instruction (Control Code Specification)".

# 12 Specifications

---

12.1 Specifications.....	12-2
12.1.1 General Specifications .....	12-2
12.1.2 Performance Specifications .....	12-2
12.2 Allocation of Memory Areas.....	12-4
12.2.1 When Using Pulse Output Table Setting Mode.....	12-4
12.2.2 When Using Pulse Output Function (FPsigma Compatible Instruction Mode) .....	12-5
12.2.3 When Using PWM Output Function .....	12-6
12.2.4 When Using High-speed Counter Function .....	12-7
12.3 Positioning Memory .....	12-9
12.3.1 Configuration of Memory Map.....	12-9
12.3.2 Common area (Memory Area No. 0).....	12-10
12.3.3 Axis Information Area (Memory Area No. 1).....	12-11
12.3.4 Axis Setting Area (Memory Area No. 2).....	12-12
12.3.5 Positioning Table Area (Memory Area No. 3).....	12-14

## 12.1 Specifications

### 12.1 Specifications

#### 12.1.1 General Specifications

For details of the general specifications, refer to FP0H User's Manual (Basic).

#### 12.1.2 Performance Specifications

##### ■ High-speed counter/Pulse output/PWM output specifications

Item		Specifications	
		FP0H mode	FPsigma mode
High-speed counter	Single-phase	Max. 4 channels (CH0 to CH3) Max. 100 kHz x 4	Max. 4 channels (CH0 to CH3) Max. 100 kHz x 4
	2-phase	Max. 2 channels (CH0, CH2) Max. 50 kHz x 2	Max. 2 channels (CH0, CH2) Max. 50 kHz x 2
Pulse output	Single-phase	Max. 4 channels (CH0 to 3) Max. 100 kHz	Max. 2 channels (CH0, CH2) Max. 100 kHz
	Interpolation	Max. 2 channels (CH0, CH2) Max. 100 kHz (Composite speed)	Max. 1 channel (CH0) Max. 100 kHz (Composite speed)
PWM output		Max. 4 points (CH0 to CH3)	Max. 2 points (CH0, CH2)
		Output frequency: Max. 100 kHz Duty ratio (0 to 100%, Resolution of 1000 or 100)	

(Note 1) For details of combinations, refer to "1.2 Restrictions on Combinations and Functions".

##### ■ Pulse output function specifications

Item		Specifications	
		Table setting mode	FPsigma compatible instruction mode
Compatible mode		FP0H mode	FP0H mode      FPsigma mode
Number of axes controlled		Max. 4 axes	Max. 4 axes      Max. 2 axes
Common specifications	Position setting mode	Increment, Absolute	
	Output interface	Transistor open collector output	
	Pulse output method	Pulse + Sign, CW+CCW	
	Max. output frequency	100,000Hz	
	Output pulse duty ratio	25% (Fixed)	25% / 50% (Select by instruction)
	Control unit	Pulse	
	Position setting range	-1,073,741,824 to 1,073,741,823 pulses For the interpolation control, -8,388,608 to +8,388,607 pulses	
	Speed reference range	Pulse: 1 to 100,000 pulse/s	

Item		Specifications		
		Table setting mode	FPsigma compatible instruction mode	
	Acceleration/deceleration method	Linear acceleration/deceleration		
	Acceleration time/ Deceleration time	0 to 10,000 ms (Settable by 1 ms. Acceleration time and deceleration time can be set separately.)	30 to 32760 ms (Specify by instruction. Acceleration time and deceleration time cannot be set separately.)	
Position control	No. of positioning tables	20 tables for each axis	Arbitrary (Set by user program)	
	Control method	Single axis	PTP control (E-point control, C-point control), CP control (P-point control), JOG positioning control (J-point control) (Note 1)	PTP control (E-point control: F171 instruction), Multistep acceleration/deceleration control (F174 instruction)
		2-axis linear interpolation	E-, P-, C-point control; composite speed or major axis speed specification	E-point control, composite speed specification (175 instruction)
	Dwell time	0 to 32,767 ms (Settable by 1 ms)	No setting	
JOG operation		Acceleration/deceleration can be specified.	Acceleration/deceleration cannot be specified. (F172 instruction)	
Home return	Return method	DOG methods (3 types), Home position method, Data set method	DOG method x 1, Home return method x 1 (Select by F171 instruction)	
Stop function	Deceleration stop	Each axis stops in the deceleration time of a running operation.	Each axis stops in the deceleration time of a running operation. (Execute by F0 instruction)	
	Emergency stop	Each axis stops in the deceleration time specified in the positioning parameter.		
	Limit stop	Each axis stops in the deceleration time specified for the limit input.		
	System stop	All axes stop.		
Memory backup		Positioning parameters and positioning table data are stored in F-ROM (without battery).	Data is stored in arbitrary data registers by user programs.	

(Note 1) When performing the J-point control or JOG operation, the speed can be changed after the startup.

## 12.2 Allocation of Memory Areas

### 12.2 Allocation of Memory Areas

#### 12.2.1 When Using Pulse Output Table Setting Mode

##### ■ Control unit

Channel no.		Input/output contact number used							Memory area used		
		CW or Pulse output	CCW or Sign output	Deviation counter clear output	Home input (Note 1)	Near home input (Note 2)	Over limit input (Note 3)	J-point positioning start input	Busy flag	Elapsed value area	
Independent	CH0	Y0	Y1	Y2	X2	(Y850)	(Y860) (Y861)	X0	(X808)	(Note 4)	
	CH1	Y3	Y4	Y5	X5	(Y851)	(Y862) (Y863)	X1	(X809)		
	CH2	Y8	Y9	YA	X6	(Y852)	(Y864) (Y865)	X3	(X80A)		
	CH3	YB	YC	YD	X7	(Y853)	(Y866) (Y867)	X4	(X80B)		
Linear interpolation (Note 1)	CH0	X-axis	Y0	Y1	Y2	X2	(Y850)	(Y860) (Y861)	-	(X808)	(Note 4)
		Y-axis	Y3	Y4	Y5	X5	(Y851)	(Y862) (Y863)		(X809)	
	CH2	X-axis	Y8	Y9	YA	X6	(Y852)	(Y864) (Y865)		(X80A)	
		Y-axis	YB	YC	YD	X7	(Y853)	(Y866) (Y867)		(X80B)	

(Note 1) Even when setting the linear interpolation, the interpolation operation is not performed for the home return. Execute the operation for X axes and Y axes separately.

(Note 2) The near home input will be valid when arbitrary inputs are allocated and the output relays indicated in the above table turn ON.

(Note 3) The over limit input (+) and over limit input (-) will be valid when arbitrary inputs are allocated and the output relays indicated in the above table turn ON. The I/O numbers in the upper rows (Y860 to Y866) in the above table are over limit input (+), the I/O numbers in the lower rows (Y861 to Y867) are over limit input (-).

(Note 4) The elapsed values are stored in the axis information area of the positioning memory. They can be read by user programs using the F384 instruction.

**12.2.2 When Using Pulse Output Function (FPsigma Compatible Instruction Mode)**

■ **Related instructions**

F0 (MV), F1 (DMV), F171 (SPDH), F172 (PLSH), F174 (SP0H), F175 (SPSH)

■ **Control unit**

**FP0H mode**

Channel no.		Input/output contact number used					Memory area used				Max. output frequency (Note 4)	
		CW or Pulse output	CCW or Sign output	Deviation counter clear output	Home input (Note 1)	Near home input (Note 2)	Control flag	Elapsed value area (Note 3)	Target value area	Correction on speed area of initial speed		
Independent	CH0	Y0	Y1	Y2	X2	DT 90052 bit 4	R911 C	DT9034 8 DT9034 9	DT9035 0 DT9035 1	DT9040 0 DT9040 1	100kHz	
	CH1	Y3	Y4	Y5	X5		R911 D	DT9035 2 DT9035 3	DT9035 4 DT9035 5	DT9040 2 DT9040 3	100kHz	
	CH2	Y8	Y9	YA	X6		R911 E	DT9035 6 DT9035 7	DT9035 8 DT9035 9	DT9040 4 DT9040 5	100kHz	
	CH3	YB	YC	YD	X7		R911F	DT9036 0 DT9036 1	DT9036 2 DT9036 3	DT9040 6 DT9040 7	100kHz	
Linear interpolation	CH0	X-axis	Y0	Y1	Y2	-	R911 C	DT9034 8 DT9034 9	DT9035 0 DT9035 1	DT9040 0 DT9040 1	Composite speed 100kHz	
		Y-axis	Y3	Y4	Y5		X5	R911 D	DT9035 2 DT9035 3	DT9035 4 DT9035 5		DT9040 2 DT9040 3
	CH2	X-axis	Y8	Y9	YA		X6	R911 E	DT9035 6 DT9035 7	DT9035 8 DT9035 9		DT9040 4 DT9040 5
		Y-axis	YB	YC	YD		X7	R911F	DT9036 0 DT9036 1	DT9036 2 DT9036 3		DT9040 6 DT9040 7

## 12.2 Allocation of Memory Areas

### FPsigma mode

Channel no.		Input/output contact number used					Memory area used				Max. output frequency (Note 4)
		CW or Pulse output	CCW or Sign output	Deviation counter clear output	Home input (Note 1)	Near home input (Note 2)	Control flag	Elapsed value area (Note 3)	Target value area	Correction speed area of initial speed	
Independent	CH0	Y0	Y1	Y2	X2	DT90052 bit4	R903 A	DT9004 4 DT9004 5	DT9004 6 DT9004 7	DT9040 0 DT9040 1	100kHz
	CH2	Y3	Y4	Y5	X5		R903 C	DT9020 0 DT9020 1	DT9020 2 DT9020 3	DT9040 4 DT9040 5	
Linear interpolation	CH0	X-axis	Y0	Y1	-	-	R903 A	DT9004 4 DT9004 5	DT9004 6 DT9004 7	DT9040 0 DT9040 1	Composite speed 100kHz
		Y-axis	Y3	Y4	-		R903 C	DT9020 0 DT9020 1	DT9020 2 DT9020 3	DT9040 4 DT9040 5	

(Note 1) Even when setting the linear interpolation, the interpolation operation is not performed for the home return. Execute the operation for X axes and Y axes separately.

(Note 2) The near home input will be valid when an arbitrary input is allocated and the bit 4 of the special data register DT90052 turns on.

(Note 3) Only F1 (DMV) instruction can perform the reading and writing of elapsed value area.

(Note 4) These values are available only when the conditions of each item (such as output method or No. of channels) are executed.

These values are not available if executing the HSC match ON/OFF instruction, other pulse I/O process simultaneously or executing the interrupt program.

### 12.2.3 When Using PWM Output Function

#### ■ Related instructions

F171 (PWMH)

#### ■ Control unit

#### FP0H mode

Channel no.	Output no.	Control flag	Output frequency (Duty)
CH0	Y0	R911C	1.0 Hz to 70 kHz: Resolution of 1000 (0.0% to 100.0%) 70001 Hz to 100 kHz: Resolution of 100 (0% to 100%)
CH1	Y3	R911D	
CH2	Y8	R911E	



Channel no.	Output no.	Control flag	Output frequency (Duty)
CH3	YB	R911F	

### FPsigma mode

Channel no.	Output no.	Control flag	Output frequency (Duty)
CH0	Y0	R903A	1.0 Hz to 70 kHz: Resolution of 1000 (0.0% to 100.0%)
CH2	Y3	R903C	70001 Hz to 100 kHz: Resolution of 100 (0% to 100%)

#### ■ Maximum output frequency of pulse output/PWM output

These values are available only when the conditions of each item (such as output method or channels) are executed. These values are available when the operations such as the high-speed counter, pulse output function or other interrupt controls are not performed.

### 12.2.4 When Using High-speed Counter Function

#### ■ Related instructions

F0 (MV), F1 (DMV), F165 (CAM0), F166 (HC1S), F167 (HC1R)

#### ■ Memory allocation

##### FP0H mode

Channel no.	Count input	Hardware reset input	Memory area used			Performance Specifications		
			Control flag	Elapsed value area	Target value area	Min. input pulse width	Max. counting speed	
[Single-phase] Addition input Subtraction input	CH0	X0	X2	R9110	DT90300 DT90301	DT90302 DT90303	High-speed input 5 μs	100kHz
	CH1	X1	X2	R9111	DT90304 DT90305	DT90306 DT90307		
	CH2	X3	X5	R9112	DT90308 DT90309	DT90310 DT90311		
	CH3	X4	X5	R9113	DT90312 DT90313	DT90314 DT90315		
[2-phase input] Phase difference input Individual input Direction distinction	CH0	X0 X1	X2	R9110	DT90300 DT90301	DT90302 DT90303	High-speed input 10 μs	50 kHz
	CH2	X3 X4	X5	R9112	DT90308 DT90309	DT90310 DT90311		

## 12.2 Allocation of Memory Areas

### FPsigma mode

Channel no.		Count input	Hardware reset input	Memory area used			Performance Specifications	
				Control flag	Elapsed value area	Target value area	Min. input pulse width	Max. counting speed
[Single-phase] Addition input Subtraction input	CH0	X0	X2	R903A	DT90044 DT90045	DT90046 DT90047	High-speed input 5 $\mu$ s	100kHz
	CH1	X1	X2	R903B	DT90048 DT90049	DT90050 DT90051		
	CH2	X3	X5	R903C	DT90200 DT90201	DT90202 DT90203		
	CH3	X4	X5	R903D	DT90204 DT90205	DT90206 DT90207		
[2-phase input] Phase difference input Individual input Direction distinction	CH0	X0 X1	X2	R903A	DT90044 DT90045	DT90046 DT90047	High-speed input 10 $\mu$ s	50 kHz
	CH2	X3 X4	X5	R903C	DT90200 DT90201	DT90202 DT90203		

(Note 1) When the reset input settings of reset input for the single-phase input overlap at CH0 and CH1 or CH2 and CH3, the setting of CH0 or CH2 has priority.

(Note 2) Only F1 (DMV) instruction can perform the reading and writing of elapsed value area.

#### ■ Maximum counting speed

These values are available only when the conditions of each item (such as counting method or channels) are executed. These values are available when the high-speed counter match ON (F166) instruction, high-speed counter match OFF (F167) instruction, pulse output function or other interrupt controls are not performed.

## 12.3 Positioning Memory

### 12.3.1 Configuration of Memory Map

The positioning memory consists of four areas.

#### ■ Whole memory map

Area		Absolute (Decimal)	No. of words and configuration		
No.	Name				
0	Common area	0000-0029	30 words		
1	Axis information area	0030-0039	For CH0	10 words for each channel	
		0040-0049	For CH1		
		0050-0059	For CH2		
		0060-0069	For CH3		
		0070-0099	Reserved for system		
2	Axis setting area	0100-0129	For CH0	30 words for each channel	
		0130-0159	For CH1		
		0160-0189	For CH2		
		0190-0219	For CH3		
		0220-0299	Reserved for system		
3	Positioning Table area	0300-0549	For CH0	250 words for each channel	
			0300-0309	Table 1	10 words for each table
			0490-0499	Table 20	
		0500-0549	Reserved area for the system		
		0550-0799	For CH1	250 words for each channel	
		0800-1049	For CH2		
		1050-1299	For CH3		
1300-1799	Reserved for system				

(Note 1) The addresses in the table are the addresses which indicate the configurations in the positioning memory. For reading/writing data using user programs, use an area number and offset address in combination for specification.

#### ■ Reading from positioning memory

- It is possible to read the areas which are shown with "Available" in the "R" column in the following table using the F384 (PTBLR) instruction in user programs during RUN. The operand of the instruction is specified using the combination of an area number and offset address.

## 12.3 Positioning Memory

### ■ Writing to positioning memory

- When the mode changes from PROG. to RUN, the contents set by the tool software Configurator PMX will be stored.
- It is possible to rewrite the areas which are shown with "Available" in the "W" column in the following table using the F385 (PTBLW) instruction in user programs during RUN. The operand of the instruction is specified using the combination of an area number and offset address.
- Be sure not to execute writing in the reserved areas for the system.

#### 12.3.2 Common area (Memory Area No. 0)

•: Available, -: Not available

Address	Name	Default	Description	R	W																								
0000	Axis setting	H0	Stores used channels (axes) and usage methods. Monitor using binary display.	•	•																								
			<table border="1"> <thead> <tr> <th>bit no.</th> <th>Settings</th> </tr> </thead> <tbody> <tr> <td>0</td> <td>Not use CH0 (0) / Use CH0 (1)</td> </tr> <tr> <td>1</td> <td>Not use CH1 (0) / Use CH1 (1)</td> </tr> <tr> <td>2</td> <td>Not use CH2 (0) / Use CH2 (1)</td> </tr> <tr> <td>3</td> <td>Not use CH3 (0) / Use CH3 (1)</td> </tr> <tr> <td>4-7</td> <td>Disable the setting</td> </tr> <tr> <td>8</td> <td>As interpolation axis, Not use CH0/CH1 (0) / Use CH0/CH1 (1)</td> </tr> <tr> <td>9</td> <td>As interpolation axis, Not use CH2/CH3 (0) / Use CH2/CH3</td> </tr> <tr> <td>10-11</td> <td>Disable the setting</td> </tr> <tr> <td>12<sup>(Note 1)</sup></td> <td>Use the interpolation control of CH0 and CH1 based on the axis setting of CH0: Use (0) / Not use (1)</td> </tr> <tr> <td>13<sup>(Note 1)</sup></td> <td>Use the interpolation control of CH2 and CH3 based on the axis setting of CH2: Use (0) / Not use (1)</td> </tr> <tr> <td>14-15</td> <td>Disable the setting</td> </tr> </tbody> </table>			bit no.	Settings	0	Not use CH0 (0) / Use CH0 (1)	1	Not use CH1 (0) / Use CH1 (1)	2	Not use CH2 (0) / Use CH2 (1)	3	Not use CH3 (0) / Use CH3 (1)	4-7	Disable the setting	8	As interpolation axis, Not use CH0/CH1 (0) / Use CH0/CH1 (1)	9	As interpolation axis, Not use CH2/CH3 (0) / Use CH2/CH3	10-11	Disable the setting	12 <sup>(Note 1)</sup>	Use the interpolation control of CH0 and CH1 based on the axis setting of CH0: Use (0) / Not use (1)	13 <sup>(Note 1)</sup>	Use the interpolation control of CH2 and CH3 based on the axis setting of CH2: Use (0) / Not use (1)	14-15	Disable the setting
			bit no.			Settings																							
			0			Not use CH0 (0) / Use CH0 (1)																							
			1			Not use CH1 (0) / Use CH1 (1)																							
			2			Not use CH2 (0) / Use CH2 (1)																							
			3			Not use CH3 (0) / Use CH3 (1)																							
			4-7			Disable the setting																							
			8			As interpolation axis, Not use CH0/CH1 (0) / Use CH0/CH1 (1)																							
			9			As interpolation axis, Not use CH2/CH3 (0) / Use CH2/CH3																							
			10-11			Disable the setting																							
12 <sup>(Note 1)</sup>	Use the interpolation control of CH0 and CH1 based on the axis setting of CH0: Use (0) / Not use (1)																												
13 <sup>(Note 1)</sup>	Use the interpolation control of CH2 and CH3 based on the axis setting of CH2: Use (0) / Not use (1)																												
14-15	Disable the setting																												
0001	Positioning repeat count (CH0)	K0	Stores the repeat count in decimal when using the repeat control in the position control.	•	•																								
0002	Positioning repeat count (CH1)	K0	<table border="1"> <thead> <tr> <th>Set value</th> <th>Operation</th> </tr> </thead> <tbody> <tr> <td>0 or 1</td> <td>Not repeat an operation.</td> </tr> <tr> <td>2-254</td> <td>Repeat an operation for a specified number of times.</td> </tr> </tbody> </table>	Set value	Operation	0 or 1	Not repeat an operation.	2-254	Repeat an operation for a specified number of times.	•	•																		
			Set value	Operation																									
0 or 1	Not repeat an operation.																												
2-254	Repeat an operation for a specified number of times.																												

Address	Name	Default	Description	R	W	
0003	Positioning repeat count (CH2)	K0		•	•	
			<b>Set value</b>	<b>Operation</b>		
0004	Positioning repeat count (CH3)	K0	255 or more	Repeat an operation infinitely.	•	•
0005 -0006	Reserved for system	-	-	-	-	
0007	Error code	H0	Stores a generated positioning error code in Hex format (hexadecimal) when using the pulse output function (table setting mode). The higher 8 bits indicate channel number. The lower 8 bits indicate error code.	•	-	
0008 -0029	Reserved for system	-	-	-	-	

(Note 1) The bit nos. 12 and 13 can be with the unit firmware Ver. 1.7 or later.

If "Use (0)" is selected, the Y axis (CH1 / CH3) uses the axis settings set for the X axis (CH0 / CH2). The target axis settings are the following parameters under Axis Setting Area (Memory Area No. 2).

Pulse output method, Pulse output rotation direction, Limit (+) switch logic, Limit (-) switch logic, Startup speed, Emergency stop deceleration time, and Limit stop deceleration time

### 12.3.3 Axis Information Area (Memory Area No. 1)

•: Available, -: Not available

Offset address	Name	Default	Description	R	W
0000	Active or execution done table	K0	Stores the monitor values of the positioning table numbers during the execution or on the completion of each channel. Stored value: 0-20	•	-
0001	Repeat count current value	K0	Stores the repeat count during the operation of each channel. The execution start time is counted as "1". When the repeat count exceeds the upper limit, it returns to "0". When the repeat operation is not enabled, "0" is stored at the positioning control start time. Stored value: 0-65535	•	-
0002 -0003	Elapsed value (Current value coordinate)	K0	Stores the elapsed values (current value coordinate) of each channel. Range: -1,073,741,824 to 1,073,741,823 For the interpolation control, the setting range is as follows. -8,388,608 to +8,388,607	•	•
0004 -0009	Reserved for system	-	-	-	-

## 12.3 Positioning Memory

### 12.3.4 Axis Setting Area (Memory Area No. 2)

●: Available, -: Not available

Offset address	Name	Default	Description	R	W																					
0000	Pulse output control code	H0	Stores the settings of pulse output, home position, near home position, and limit signal of each channel. Monitor in binary format.	●	●																					
			<table border="1"> <thead> <tr> <th>bitno.</th> <th>Item</th> <th>Settings</th> </tr> </thead> <tbody> <tr> <td>0</td> <td>Pulse output method</td> <td>0 : Pulse/Sign 1 : CW/CCW</td> </tr> <tr> <td>1</td> <td>Pulse output rotation direction</td> <td>0: Elapsed value + Direction is CW (Forward OFF/Reverse ON) 1: Elapsed value + Direction is CCW (Forward ON/Reverse OFF)</td> </tr> <tr> <td>2</td> <td>Home position logic</td> <td rowspan="4">0: Normal Open (A contact) 1: Normal Close (B contact)</td> </tr> <tr> <td>3</td> <td>Home position proximity logic</td> </tr> <tr> <td>4</td> <td>Limit (+) switch logic</td> </tr> <tr> <td>5</td> <td>Limit (-) switch logic</td> </tr> <tr> <td>6-15</td> <td>Disable the setting</td> <td></td> </tr> </tbody> </table>			bitno.	Item	Settings	0	Pulse output method	0 : Pulse/Sign 1 : CW/CCW	1	Pulse output rotation direction	0: Elapsed value + Direction is CW (Forward OFF/Reverse ON) 1: Elapsed value + Direction is CCW (Forward ON/Reverse OFF)	2	Home position logic	0: Normal Open (A contact) 1: Normal Close (B contact)	3	Home position proximity logic	4	Limit (+) switch logic	5	Limit (-) switch logic	6-15	Disable the setting	
			bitno.			Item	Settings																			
			0			Pulse output method	0 : Pulse/Sign 1 : CW/CCW																			
			1			Pulse output rotation direction	0: Elapsed value + Direction is CW (Forward OFF/Reverse ON) 1: Elapsed value + Direction is CCW (Forward ON/Reverse OFF)																			
			2			Home position logic	0: Normal Open (A contact) 1: Normal Close (B contact)																			
			3			Home position proximity logic																				
			4			Limit (+) switch logic																				
5	Limit (-) switch logic																									
6-15	Disable the setting																									
0001-0002	Startup speed	K100	Stores the settings of the startup speed for each operation of each channel in decimal. Setting range: 1 to 100,000	●	●																					
0003	Home return method	HFF	Stores the settings of home return patterns of each channel. H0: DOG method 1 H1: DOG method 2 H2: DOG method 3 H3: Setting error H4: Setting error H5: Home position method (Z phase method) H6: Data set method HFF: Not use	●	●																					
0004	Home return direction	K0	Stores the settings of home return operation direction in decimal. 0: Elapsed value decreasing direction (Limit - direction) 1: Elapsed value increasing direction (Limit + direction)	●	●																					
0005	Home return acceleration time	K100	Stores the settings of the acceleration time for the home return of each channel in decimal. It indicates the time from the startup speed to the home return target speed. Setting range: 1-10,000 (ms)	●	●																					

## 12.3 Positioning Memory

Offset address	Name	Default	Description	R	W
0006	Home return deceleration time	K100	Stores the settings of the deceleration time for the home return of each channel in decimal. It indicates the time from the home return target speed to the startup speed. Setting range: 1-10,000 (ms)	•	•
0007 -0008	Home return target speed	K1000	Stores the settings of the target speed for the home return of each channel in decimal. Setting range: 1 to 100,000	•	•
0009 -0010	Home return creep speed	K100	Stores the settings of the creep speed for the home return of each channel in decimal. Setting range: 1 to 100,000	•	•
0011	Deviation counter clear time	K1	Stores the settings of the deviation counter clear signal ON time after the completion of home return of each channel in decimal. Setting range: 1 to 100 (ms) In the case of 0, no deviation counter clear signal is output. In the case of 100 or more, the ON time is set to 100 ms.	•	•
0012 -0013	Coordinate origin	K0	Stores the elapsed values (current value) after the home return. Range: -1,073,741,824 to 1,073,741,823 For the interpolation control, the setting range is as follows. -8,388,608 to +8,388,607	•	•
0014	JOG acceleration time	K0	Stores the settings of the acceleration time for the JOG operation of each channel in decimal. It indicates the acceleration time from startup speed to JOG operation target speed. Setting range: 0 to 10,000 (ms)	•	•
0015	JOG deceleration time	K0	Stores the settings of the deceleration time for the JOG operation of each channel in decimal. It indicates the deceleration time from JOG operation target speed to startup speed. Setting range: 0 to 10,000 (ms)	•	•
0016 -0017	JOG target speed	K1000	Stores the settings of the target speed for the JOG operation of each channel in decimal. Setting range: 1 to 100,000	•	•
0018 -0019	J point change target speed	K1000	Stores the settings of the target speed for changing the J-point control speed for each channel in decimal. Setting range: 1 to 100,000	•	•
0020	Emergency stop deceleration time	K100	Stores the settings of the deceleration time for the emergency stop operation of each channel in decimal. It indicates the deceleration time from 100 kHz to 0 Hz. Setting range: 0 to 10,000 (ms)	•	•
0021	Limit stop deceleration time	K100	Stores the settings of the deceleration time for the limit stop operation of each channel in decimal. It indicates the deceleration time from 100 kHz to 0 Hz. Setting range: 0 to 10,000 (ms)	•	•
0022 -0029	Reserved for system	-	-	-	-

## 12.3 Positioning Memory

(Note 1) The emergency stop deceleration time and limit stop deceleration time indicates the deceleration time in the section from 100 kHz to 0 Hz. When the speed during the operation is less than 100 kHz, the actual deceleration time is shorter than the set time.

### 12.3.5 Positioning Table Area (Memory Area No. 3)

●: Available, -: Not available

Offset address	Name	Default	Description	R	W									
0000	Control code	H0	Stores the settings of the position specification method for the positioning operation.	●	●									
			<table border="1"> <thead> <tr> <th>bit no.</th> <th>Item</th> <th>Settings</th> </tr> </thead> <tbody> <tr> <td>0</td> <td>Control method</td> <td>0 : Increment mode 1 : Absolute mode</td> </tr> <tr> <td>1-15</td> <td>Disable the setting</td> <td></td> </tr> </tbody> </table>			bit no.	Item	Settings	0	Control method	0 : Increment mode 1 : Absolute mode	1-15	Disable the setting	
			bit no.			Item	Settings							
0	Control method	0 : Increment mode 1 : Absolute mode												
1-15	Disable the setting													
0001	Control pattern	H0	Stores the settings of single axis and interpolation operation pattern of positioning operation. In the interpolation operation, the setting for the axis with the smallest number in an axis group is effective.	●	●									
			<p>Channel specification            H00: Linear interpolation (composite speed)            H01: Linear interpolation (major axis speed)</p> <p>Control pattern            H00: E-point control (End point control)            H01: P-point control (Pass point control)            H02: C-point control (Continuance point control)            H03: J-point control (Speed point control)</p>											
0002	Positioning acceleration time	K100	Stores the settings of the acceleration time for the positioning operation. It indicates the acceleration time from the startup speed to the target speed. Setting range: 1 to 10,000 (ms)	●	●									
0003	Positioning deceleration time	K100	Stores the settings of the deceleration time for the positioning operation. It indicates the deceleration time from the target speed to the startup speed. Setting range: 1 to 10,000 (ms)	●	●									
0004 -0005	Positioning target speed	K1000	Stores the settings of the target speed for the positioning operation. In the interpolation operation, the setting for the axis with the smallest number in an axis group is effective. Setting range: 1 to 100,000	●	●									
0006 -0007	Positioning movement amount	K0	Stores the settings of the movement amount for the positioning operation. Setting range: -1,073,741,824 to 1,073,741,823 For the interpolation control, the setting range is as follows.	●	●									



Offset address	Name	Default	Description	R	W
			-8,388,608 to +8,388,607		
0008	Dwell time	K0	Stores the setting of dwell time. Setting range: 0 to 32,767ms	•	•
0009	Reserved for system	-	-	-	-

(Note 1) The offset addresses in the above table are for the table no. 0. They vary according to the table numbers as described on the next page.

### ■ Offset addresses

Table no.	Control code	Control pattern	Positioning acceleration time	Positioning deceleration time	Positioning target speed	Positioning movement amount	Dwell time
1	0	1	2	3	4-5	6-7	8
2	10	11	12	13	14-15	16-17	18
3	20	21	22	23	24-25	26-27	28
4	30	31	32	33	34-35	36-37	38
5	40	41	42	43	44-45	46-47	48
6	50	51	52	53	54-55	56-57	58
7	60	61	62	63	64-65	66-67	68
8	70	71	72	73	74-75	76-77	78
9	80	81	82	83	84-85	86-87	88
10	90	91	92	93	94-95	96-97	98
11	100	101	102	103	104-105	106-107	108
12	110	111	112	113	114-115	116-117	118
13	120	121	122	123	124-125	126-127	128
14	130	131	132	133	134-135	136-137	138
15	140	141	142	143	144-145	146-147	148
16	150	151	152	153	154-155	156-157	158
17	160	161	162	163	164-165	166-167	168
18	170	171	172	173	174-175	176-177	178
19	180	181	182	183	184-185	186-187	188
20	190	191	192	193	194-195	196-197	198

(Note 1) For the positioning target speed and positioning movement amount, specify the lower address number of 2-word area.

(MEMO)

## Record of changes

Manual numbers can be found at the bottom of the manual cover.

Date	Manual No.	Record of Changes
Nov. 2017	WUME-FP0HPOS-01	1st Edition
Feb. 2018	WUME-FP0HPOS-02	2nd Edition Version upgrade of the unit firmware (Ver.1.1) Added the descriptions of supported functions. <ul style="list-style-type: none"> <li>• FPsigma mode</li> </ul> Added the specifications of FPsigma compatible instruction. <ul style="list-style-type: none"> <li>• F171(SPDH) / F171(SPDH) / F172(PLSH) / F174(SP0H)</li> </ul> Error correction
Mar. 2020	WUME-FP0HPOS-03	3rd Edition Changed manual format Error correction
Feb. 2021	WUME-FP0HPOS-04	4th Edition Version upgrade of the unit firmware (Ver. 1.7) <ul style="list-style-type: none"> <li>• Added optional settings to the positioning memory (Memory Area No. 0"Axis setting").</li> </ul>
Nov. 2022	WUME-FP0HPOS-05	5th Edition Changed "Settings and Operation of JOG Operation (Speed Changes)".
Apr. 2023	WUME-FP0HPOS-06	6th Edition "7.2 FPsigma Compatible Instruction Mode Control Instruction" <ul style="list-style-type: none"> <li>• Changed the description on the frequency.</li> </ul>
Apr. 2024	WUME-FP0HPOS-07	7th Edition Change in Corporate name

## Order Placement Recommendations and Considerations

The Products and Specifications listed in this document are subject to change (including specifications, manufacturing facility and discontinuing the Products) as occasioned by the improvements of Products. Consequently, when you place orders for these Products, Panasonic Industry Co., Ltd. asks you to contact one of our customer service representatives and check that the details listed in the document are commensurate with the most up-to-date information.

### [Safety precautions]

Panasonic Industry Co., Ltd. is consistently striving to improve quality and reliability. However, the fact remains that electrical components and devices generally cause failures at a given statistical probability. Furthermore, their durability varies with use environments or use conditions. In this respect, check for actual electrical components and devices under actual conditions before use. Continued usage in a state of degraded condition may cause the deteriorated insulation. Thus, it may result in abnormal heat, smoke or fire. Carry out safety design and periodic maintenance including redundancy design, design for fire spread prevention, and design for malfunction prevention so that no accidents resulting in injury or death, fire accidents, or social damage will be caused as a result of failure of the Products or ending life of the Products.

The Products are designed and manufactured for the industrial indoor environment use. Make sure standards, laws and regulations in case the Products are incorporated to machinery, system, apparatus, and so forth. With regard to the mentioned above, confirm the conformity of the Products by yourself.

Do not use the Products for the application which breakdown or malfunction of Products may cause damage to the body or property.

- i) usage intended to protect the body and ensure security of life
- ii) application which the performance degradation or quality problems, such as breakdown, of the Products may directly result in damage to the body or property

It is not allowed the use of Products by incorporating into machinery and systems indicated below because the conformity, performance, and quality of Products are not guaranteed under such usage.

- i) transport machinery (cars, trains, boats and ships, etc.)
- ii) control equipment for transportation
- iii) disaster-prevention equipment / security equipment
- iv) control equipment for electric power generation
- v) nuclear control system
- vi) aircraft equipment, aerospace equipment, and submarine repeater
- vii) burning appliances
- viii) military devices
- ix) medical devices (except for general controls)
- x) machinery and systems which especially require the high level of reliability and safety

### [Acceptance inspection]

In connection with the Products you have purchased from us or with the Products delivered to your premises, please perform an acceptance inspection with all due speed and, in connection with the handling of our Products both before and during the acceptance inspection, please give full consideration to the control and preservation of our Products.

### [Warranty period]

Unless otherwise stipulated by both parties, the warranty period of our Products is three years after the purchase by you or after their delivery to the location specified by you. The consumable items such as battery, relay, filter and other supplemental materials are excluded from the warranty.

### [Scope of warranty]

In the event that Panasonic Industry Co., Ltd. confirms any failures or defects of the Products by reasons solely attributable to Panasonic Industry Co., Ltd. during the warranty period, Panasonic Industry Co., Ltd. shall supply the replacements of the Products, parts or replace and/or repair the defective portion by free of charge at the location where the Products were purchased or delivered to your premises as soon as possible.

However, the following failures and defects are not covered by warranty and we are not responsible for such failures and defects.

- (1) When the failure or defect was caused by a specification, standard, handling method, etc. which was specified by you.
- (2) When the failure or defect was caused after purchase or delivery to your premises by an alteration in construction, performance, specification, etc. which did not involve us.
- (3) When the failure or defect was caused by a phenomenon that could not be predicted by the technology at purchasing or contracted time.
- (4) When the use of our Products deviated from the scope of the conditions and environment set forth in the instruction manual and specifications.
- (5) When, after our Products were incorporated into your products or equipment for use, damage resulted which could have been avoided if your products or equipment had been equipped with the functions, construction, etc. the provision of which is accepted practice in the industry.
- (6) When the failure or defect was caused by a natural disaster or other force majeure.
- (7) When the equipment is damaged due to corrosion caused by corrosive gases etc. in the surroundings.

The above terms and conditions shall not cover any induced damages by the failure or defects of the Products, and not cover your production items which are produced or fabricated by using the Products. In any case, our responsibility for compensation is limited to the amount paid for the Products.

### [Scope of service]

The cost of delivered Products does not include the cost of dispatching an engineer, etc. In case any such service is needed, contact our sales representative.

Panasonic Industry Co., Ltd.

(MEMO)

---

## Panasonic Industry Co., Ltd.

1006, Oaza Kadoma, Kadoma-shi, Osaka 571-8506, Japan  
<https://industry.panasonic.com/>

Please visit our website for inquiries and about our sales network.

© Panasonic Industry Co., Ltd. 2017-2024

April, 2024

WUME-FP0HPOS-07