

Programmable Controller

FP0H Control Unit User's Manual

Logging/Trace Function

(MEMO)

Introduction

Thank you for purchasing a Panasonic product. Before you use the product, please carefully read through the user's manual, and understand it in detail to use the product properly.

Types of Manual

- There are different types of user's manual for the FP0H series. Please refer to a relevant manual for the unit and purpose of your use.
- The manuals can be downloaded on our website: <https://industry.panasonic.com/global/en/downloads/?tab=manual>.

Unit name or purpose of use	Manual name	Manual code
FP0H Control Unit	FP0H User's Manual (Basic)	WUME-FP0HBAS
	FP0H Programming Manual	WUME-FP0HPGR
	FP0H Programming Manual (SD Card Access Instructions)	WUME-FP0HSD
Positioning Function/PWM Output/High-speed Counter Function	FP0H User's Manual (Positioning/PWM Output/High-speed Counter)	WUME-FP0HPOS
Serial Communication Function	FP0H User's Manual (COM Communication)	WUME-FP0HCOM
Ethernet Communication Function	FP0H User's Manual (Ethernet Communication)	WUME-FP0HET
EtherNet/IP Communication Function	FP0H User's Manual (EtherNet/IP)	WUME-FP0HEIP
Logging trace function	FP0H User's Manual (Logging/Trace Function)	WUME-FP0HLOG
FP0H Extension (Communication) Cassette	FP0H User's Manual (COM Communication)	WUME-FP0HCOM
FP0H Positioning Unit	FP0H Positioning Unit User's Manual	WUME-FP0HPG
FP0H Positioning Unit RTEX	FP0H Positioning Unit RTEX User's Manual (FPWIN GR7)	WUME-FP0HRTEXGR7

SAFETY PRECAUTIONS

- To prevent accidents or personal injuries, please be sure to comply with the following items.
- Prior to installation, operation, maintenance and check, please read this manual carefully for proper use.
- Before using, please fully understand the knowledge related to the equipment, safety precautions and all other precautions.
- Safety precautions are divided into two levels in this manual: Warning and Caution.

⚠ WARNING Incorrect operation may lead to death or serious injury.

- Take appropriate safety measures to the external circuit of the product to ensure the security of the whole system in case of abnormalities caused by product failure or external.
- Do not use this product in areas with inflammable gases.
Otherwise it may lead to an explosion.
- Do not put this product into a fire.
Otherwise it could cause damage to the battery or other electronic parts.

⚠ CAUTION Incorrect operation may lead to injury or material loss.

- To prevent the excessive exothermic heat or smoke generation of the product, a certain margin is required for guaranteed characteristics and performance ratings of relative products.
- Do not decompose or transform it.
Otherwise it will lead to the excessive exothermic heat or smoke generation of the product.
- Do not touch terminal blocks during power-on.
Otherwise it may result in an electric shock.
- Set an emergency stop and interlock circuit in the external devices.
- Connect wires and connectors reliably.
Otherwise it may lead to the excessive exothermic heat or smoke generation of the product.
- Do not undertake construction (such as connection and disconnection) while the power supply is on.
It could lead to an electric shock.
- If the equipment is used in a manner not specified by the Panasonic, the protection provided by the equipment may be impaired.
- This product has been developed/produced for industrial use only.

Description on Copyright and Trademarks

- The copyright of this manual is owned by **Panasonic Industry Co., Ltd.**
- Unauthorized reproduction of this manual is strictly prohibited.
- Windows is a registered trademark of Microsoft Corporation in the U.S. and other countries.
- Ethernet is a registered trademark of FUJIFILM Business Innovation Corp. and Xerox Corporation.
- EtherNet/IP is a registered trademark of ODVA (Open DeviceNet Vendor Association).
- SDHC and SD logos are trademarks of LLC.
- Other company and product names are trademarks or registered trademarks of their respective companies.

Contents of This Manual

This manual describes the "logging/trace function" and "sampling trace function" implemented in FP0H Control Unit.

■ Functional comparison

Item	Logging/trace function	Sampling trace function
Applicable model	Type with Ethernet function only AFP0HC32ET/AFP0HC32EP	All FP0H models

Item	Logging/trace function	Sampling trace function
Description	Operation information of arbitrary contacts and data is saved in the buffer memory in the control unit together with time stamp information. With the logging function, they can also be recorded in an SD memory card. In comparison with the sampling trace function, the number of devices that can be registered and trigger condition has been extended.	This function can be used by similar operations to those of the sampling trace function of existing models FP0R/FPsigma/FP-X.
No. of devices	Max. 128 devices (Max. 256 words)	16 contacts (for 1 word) + 3 words
Memory capacity	Max. 64 K words	For 1000 samples
Trigger condition	Bit device ON Cycle: Hour, minute, second Time: Per minute, Per hour, Every day, Every week, Every month, Every year Instruction: F420 (LOGST) instruction	Cycle (10 ms to 30 s) Instruction: F155 (SMPL) instruction

i Info.

- For details of the logging/trace function, refer to "[1 Overview of Logging/Trace Function](#)" to "[6 Logging/Trace Troubleshooting](#)".
- For details of the sampling trace function, refer to "[7 Sampling Trace Function](#)".

(MEMO)

Table of Contents

1 Overview of Logging/Trace Function	1-1
1.1 For Using Logging/Trace Function.....	1-2
1.1.1 Applicable model.....	1-2
1.1.2 Precautions on Using This Function	1-2
1.1.3 Selection of SD Memory Cards.....	1-2
1.2 Overview of Functions	1-4
1.2.1 Overview of Logging Function	1-4
1.2.2 Overview of Trace Function	1-5
1.3 Format of Saved Files.....	1-7
1.3.1 File Format (For Logging Function)	1-7
1.3.2 File Name (For Logging Function)	1-7
1.3.3 File Format (For Trace Function)	1-8
1.3.4 File Name (For Trace Function).....	1-8
1.4 Data Format.....	1-9
2 Configuration of Logging/Trace Function	2-1
2.1 Definition of Buffer Memory	2-2
2.1.1 Setting Method.....	2-2
2.2 Logging Information Setting.....	2-3
2.2.1 Confirmation and Settings of File Information.....	2-3
2.2.2 LOG File Setting Items (For Logging).....	2-4
2.3 Trace Information Setting.....	2-7
2.3.1 Confirmation and Settings of File Information.....	2-7
2.3.2 LOG File Setting Items (For Trace).....	2-8
2.4 Registration of Device Information.....	2-11
2.5 Operation When Setting Cycle for Logging Trigger	2-13
2.6 Downloading Setting Data to Control Unit	2-15
2.6.1 Downloading to Non-volatile Memory	2-15
3 Logging/Trace Start, Stop and Monitor	3-1
3.1 Start and Stop of Logging/Trace Operation	3-2
3.1.1 Start and Stop by Tool Software	3-2
3.1.2 Start and Stop by Instructions.....	3-3
3.1.3 Automatic Start by Setting	3-3
3.2 Operation Check Using Logging/Trace Monitor.....	3-4
3.2.1 Logging/Trace Monitor	3-4
3.2.2 Special Internal Relays Relating to Logging/Trace Operation	3-5
3.2.3 Special Data Registers Relating to Logging/Trace Operation.....	3-6
3.2.4 Checking Logging Speed (When Selecting Logging For Application).....	3-6
4 Logging Operation	4-1
4.1 Flow of Logging Operation.....	4-2
4.1.1 Operation Flow.....	4-2

4.2	Operation When Logging is Selected for Application	4-4
4.2.1	Operation When Logging Operation is Started	4-4
4.2.2	Operation When Logging Operation Stops	4-4
4.2.3	Operation When Power Supply Turns Off	4-4
4.2.4	Operation When the Battery Cover of Control Unit is Open	4-4
4.2.5	Operation When the Number of Determination Files Reaches the Maximum Number of Generations	4-5
4.3	System Management Information Relating to Logging Function	4-7
4.3.1	System Management Information and Operation	4-7
4.3.2	Clearing Management Information	4-7
5	Trace Operation and Time Chart	5-1
5.1	Flow of Trace Operation	5-2
5.1.1	Flow of Trace Operation	5-2
5.2	Operation When Trace is Selected for Application	5-4
5.2.1	Operation When Trace Operation is Started	5-4
5.2.2	Operation When Logging Operation Stops	5-4
5.2.3	Operation When Power Supply Turns Off	5-4
5.2.4	Operation When the Battery Cover of Control Unit is Open	5-4
5.3	Trace Monitor (Time Chart)	5-6
5.3.1	Display Method of Time Chart	5-6
5.3.2	Explanation of Time Chart Monitor	5-7
5.3.3	Settings for Time Chart Display Area	5-9
5.3.4	Register Device	5-12
5.3.5	Sampling Condition Setting	5-13
6	Logging/Trace Troubleshooting	6-1
6.1	Operations When Errors Occur	6-2
6.1.1	Operation When Power Supply Turns Off	6-2
6.1.2	Operation When Errors Occur (Only When Selecting Logging for Application)	6-2
6.1.3	Operations When Inserting/Removing SD Memory Card During Logging/Trace	6-3
6.2	Troubleshooting	6-4
6.2.1	Errors When Start/Stop Operation was Executed Using FPWIN GR7	6-4
6.2.2	Errors When Operation was Executed Using LOGST, LOGED or LOGSMPL Instruction	6-4
6.2.3	Error of Logging/Trace	6-5
6.2.4	Error When Copying Data in SD Memory Card	6-5
7	Sampling Trace Function	7-1
7.1	Operation of Sampling Trace Function	7-2
7.2	Details of Sampling Trace Function	7-3
7.3	How to Use Sampling Trace	7-4
7.3.1	Sampling by free run	7-4
7.3.2	Sampling at regular time intervals	7-4
7.3.3	Sampling by instruction	7-5

1 Overview of Logging/Trace Function

1.1 For Using Logging/Trace Function.....	1-2
1.1.1 Applicable model.....	1-2
1.1.2 Precautions on Using This Function	1-2
1.1.3 Selection of SD Memory Cards.....	1-2
1.2 Overview of Functions	1-4
1.2.1 Overview of Logging Function	1-4
1.2.2 Overview of Trace Function	1-5
1.3 Format of Saved Files.....	1-7
1.3.1 File Format (For Logging Function)	1-7
1.3.2 File Name (For Logging Function)	1-7
1.3.3 File Format (For Trace Function)	1-8
1.3.4 File Name (For Trace Function).....	1-8
1.4 Data Format.....	1-9

1.1 For Using Logging/Trace Function

1.1 For Using Logging/Trace Function

1.1.1 Applicable model

The logging/trace function is available for the models of Ethernet type (SD card). However, this function and the sampling trace function cannot be used concurrently.

■ Applicable models (●: Available, Blank: Not available)

Item	Ethernet type	Non-Ethernet type
	C32ET/C32EP	C32T/C32P
Logging/trace function	●	
Sampling trace function	●	●

1.1.2 Precautions on Using This Function

As an SD memory card is used for the logging function, there are risks of loss of data or data damage depending on usage conditions. Consider possible risks, design a system and make an evaluation of the system before using the function.

■ Precautions when powering off the PLC

If the PLC is powered off during logging or accessing an SD memory card, the following problems may occur.

- Data accumulated in the buffer memory are lost.
- Files may be damaged.
- The SD memory card may be damaged.

Take necessary measures such as the use of an uninterruptible power system (UPS) as necessary.

■ Logging speed and writing speed into an SD memory card

If the speed to accumulate data is normally faster than that to write to the SD memory card, data saving or file determination may not operate properly.

Check logging over-speed relays (R9183, R9193, R9203, R9213, etc.) and buffer overflow relays (R9184, R9194, R9204, R9214, etc.) to thoroughly evaluate the system before using the function.

1.1.3 Selection of SD Memory Cards

For the Control Units with the Ethernet function (AFP0HC32ET/AFP0HC32EP), SD memory cards can be used for copying projects and logging/trace applications. Note the following points when selecting and using SD memory cards

■ Usable SD memory cards

We recommend SLC SD memory cards and SLC SDHC memory cards.

For details on operation confirmed SD memory card and SDHC memory card, visit <https://industry.panasonic.com/global/en/products/fasys/information/sd-card/>.

Control Unit printed logo	Usable SD memory cards	
	Card type	Capacity
	SD memory card	2GB
	SDHC memory card	4GB to 32GB

■ Cautions on handling an SD memory card

The data saved in the SD memory card may be lost in the following cases. We assume no responsibility whatsoever for the loss of saved data.

- The user or a third party has misused the SD memory card.
- When the SD memory card was affected by any static electricity or electrical noise.
- The SD memory card was taken out, or the PLC body was powered off, while the card was being accessed.

■ Formatting an SD memory card

In principle, SD memory cards have been formatted by the time of purchase, and no formatting by the user is required. If formatting becomes necessary, download formatting software for SD memory cards from the SD Association site.



- A file system formatted by PC's standard formatting software does not satisfy the SD memory card specifications. Please use the dedicated formatting software.
- It is recommended to save important data in another media for backup.
- Never remove the card or power off the PLC while accessing the card. Data may be damaged.
- Do not use an SD memory card the memory capacity of which is more than the usable capacity. Data in the card may be damaged.

1.2 Overview of Functions

1.2 Overview of Functions

1.2.1 Overview of Logging Function

■ Overview

- The logging function is used to record arbitrary contacts and data information together with time stamp information at any time, and save them in an SD memory card inserted in the control unit.
- Log data is saved as CSV format files.
- Use the **Logging/Trace Settings** menu of tool software to set the conditions.
- The settings are downloaded to the PLC as a part of project data, and stored in the non-volatile memory.
- The logging operation is executed by any of those operations; (1) tool software, (2) dedicated instructions or (3) Autostart by the setting.
- To perform data logging at high speed, the buffer memory in the control unit is used.

■ Specifications

Item	Specifications	Remarks
Max. number of records	60000 records	-
Number of file generations	Max. 2,000 generations per log	-
Number of logs	Max. 128 devices (Max. 256 words) per record	-
Buffer memory	Max. 64 K words Can be divided into max. 4 (LOG0 to LOG3) areas for use. Capacity per division: 4K words to 64K words	Shared with the trace function.
Logging start-stop	Selectable from the tool software, instructions or autostart.	-
Logging trigger condition	Bit device ON (Note 1) Cycle: Hour, minute, second (Note 1) Time: Per minute, Per hour, Every day, Every week, Every month, Every year (Note 1) Instruction: Executes F420 (LOGST) instruction with an arbitrary condition and starts logging.	-
File determination condition (Logging stop trigger condition)	Bit device ON (Note 2) Time: Per minute, Per hour, Every day, Every week, Every month, Every year Max. number of records	-
File format	Data is saved in CSV format.	Arbitrary comments can be given. The upper limit of the capacity on the file system is 4 GB.

(Note 1) Logging is executed when the condition is met at the end of scan.

(Note 2) Use it together with the (DF) instruction to turn ON only for one scan.

(Note 3) Data stored in the buffer memory will be cleared when the power turns off.

■ Image of logging function

When the set conditions (bit device ON, cycle, time, and instruction) are met, the values of operation devices will be saved in the logging buffer memory (RAM). The logging operation continues until the file determination condition is met. Writing data to an SD memory card from the logging buffer memory is automatically performed by PLC. It is not possible to perform this operation by users.

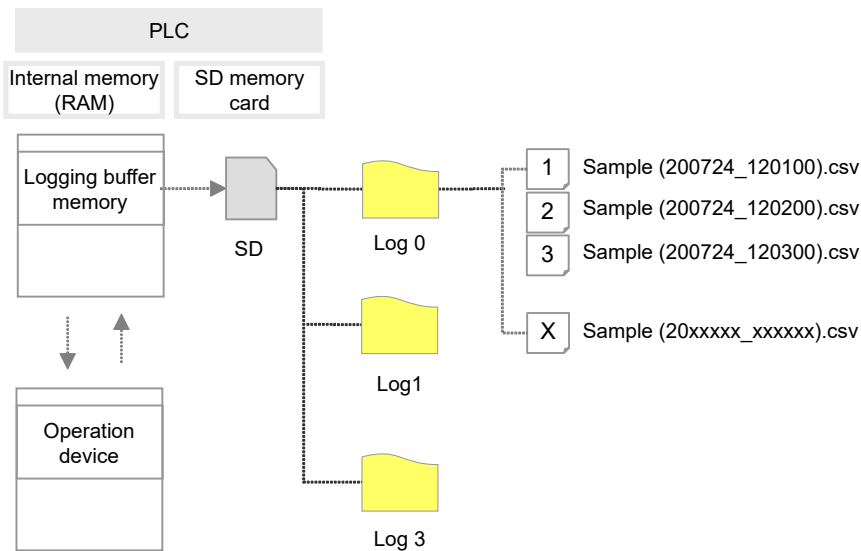

1.2.2 Overview of Trace Function

■ Overview

- The trace function is used to record arbitrary contacts and data information together with time stamp information in the buffer memory in the control unit at any time.
- Logging data can be uploaded from the buffer memory to the tool software after the trace operation, and can be displayed as a time chart. Traced data can be saved in SD memory cards as CSV format files.
- When the trace stop condition is set to bit device, the operation can be stopped after logging data of the specified number of samplings after the stop condition has been met.
- Use the **Logging/Trace Settings** menu of tool software to set the conditions.
- The settings are downloaded to the PLC as part of project data, and stored in the non-volatile memory.
- The trace operation is executed by any of those operations; (1) tool software, (2) dedicated instructions or (3) Autostart by the setting.

■ Specifications

Item	Specifications	Remarks
Number of logs	Max. 128 devices (Max. 256 words) per record	-

1.3 Format of Saved Files

1.3.1 File Format (For Logging Function)

- Files are saved in CSV format.
- For the details of setting methods, refer to "2.2 Logging Information Setting".

■ CSV format

- Time stamp information (year/month/day/hour/minute/second) and information of registered devices are saved.
- The data length varies depending on the types of specified devices.
- Comments can be given at the beginning of data.

	1st line	2nd line	3rd line	4th line	5th line	
			1	2	3	-
			Data name 1	Data name 2	Data name 3	-
Comment part (Note 1)			Arbitrary comment	Arbitrary comment	Arbitrary comment	-
			MOMENT	MOMENT	MOMENT	-
			Data format 1	Data format 2	Data format 3	-
			Unit 1	Unit 2	Unit 3	-
(Note 2)	date format	time format	Data 1	Data 2	Data 3	-
	date format	time format	Data 1	Data 2	Data 3	-
	date format	time format	Data 1	Data 2	Data 3	-
	-	-	-	-	-	-
			←----- (Note 3) -----→			

(Note 1) The contents of comment part vary depending on the settings of configuration data.

(Note 2) The number of records varies depending on the settings of file determination condition. Max. 60000 records.

(Note 3) The number of data varies depending on the setting of the number of devices. Max. 128 devices

1.3.2 File Name (For Logging Function)

- A file name to be saved is an arbitrary file name (date_hour-minute-second data of the first record).
 - Enter a desired file name in the "Logging/Trace Settings" dialog box for each LOG number.
- Example) When the file name is "Sample", and the time stamp of the first record is 12:00:00 on July 24, 2020;
 Sample(200724_120000).csv

1.3 Format of Saved Files

1.3.3 File Format (For Trace Function)

- Files are saved in CSV format.
- For the details of setting methods, refer to "2.3 Trace Information Setting".

■ **CSV format**

- Time stamp information (year/month/day/hour/minute/second), obtaining interval and information of registered devices are saved.
- Comments can be given at the beginning of data.
- The unit for the obtaining interval is 10μs. The intervals of obtaining data are saved. The time from the previous obtainment of data is saved in the line of stop trigger (STOP TRG).
- The data length varies depending on the types of specified devices.

		1st line	2nd line	3rd line	4th line	5th line
Comment part (Note 1)		Date	Time	Obtaining interval	1	2
					Data name 1	Data name 2
					Arbitrary comment	Arbitrary comment
					MOMENT	MOMENT
					Data format 1	Data format 2
					Unit 1	Unit 2
(Note 2)		date format	time format	0	Data 1	Data 2
		date format	time format	Interval	Data 1	Data 2
		date format	time format	Interval	Data 1	Data 2
		date format	time format	Interval	STOP TRG	
		date format	time format	Interval	Data 1	Data 2
		-	-	-	-	-

(Note 4)

- (Note 1) The contents of comment part vary depending on the settings of configuration data.
- (Note 2) The number of records varies depending on the settings of file determination condition. Max. 60000 records.
- (Note 3) The number of records after the stop trigger varies depending on the settings of configuration data.
- (Note 4) The number of data varies depending on the setting of the number of devices. Max. 128 devices

1.3.4 File Name (For Trace Function)

- A file name to be saved is an arbitrary file name (date_hour-minute-second data of the stop trigger).
- Enter a desired file name in the "Logging/Trace Settings" dialog box for each LOG number.
Example) When the file name is "Sample", and the time stamp of the stop trigger is 12:00:00 on Friday, July 24, 2020;
Sample(200724_120000_TRACE).csv

1.4 Data Format

- The format of the data to be output as logging data and saved in a file varies according to the type of devices.
- For the details of setting methods, refer to "2.4 Registration of Device Information".

■ Device type and output format

Bit data

Data type	Bit data
Data size	1 word
Number of characters to be saved	1
Data range	0 or 1

Decimal integer (unsigned)

Data type	Unsigned 16-bit integer type	Unsigned 32-bit integer type
Data size	1 word	2 words
Number of characters to be saved (number of digits)	5 digits when a specified decimal point output position value is 0, 6 digits when it is 1-4, and 7 digits when it is 5.	10 digits when a specified decimal point output position value is 0, 11 digits when it is 1-9, and 12 digits when it is 10.
Data range	0 to 65536	0 to 4294967295
Remarks	Output in zero suppression format.	

Decimal integer (signed)

Data type	Signed 16-bit integer type	Signed 32-bit integer type
Data size	1 word	2 words
Number of characters to be saved (number of digits)	6 digits when a specified decimal point output position value is 0, 7 digits when it is 1-4, and 8 digits when it is 5.	11 digits when a specified decimal point output position value is 0, 12 digits when it is 1-9, and 13 digits when it is 10.
Data range	-32768 to 32767	-2147483648 to 2147483647
Remarks	Output in zero suppression format. A sign is output at the beginning and "+" is replaced with a space.	

Single-precision floating point real number

Data type	Single-precision real number
Data size	2 words
Data type	Decimal or exponential form (auto)
Number of characters to be saved	13
Data range	-1.175494E-38

1.4 Data Format

Hexadecimal integer (unsigned)

Data type	HEX (1 word)	HEX (2 words)
Data size	1 word	2 words
Number of characters to be saved	4	8
Data range	0 to FFFF	0 to FFFF FFFF
Remarks	Output in zero suppression format.	

Character string

Data type	Character string
Data size (Number of characters)	Specified in the range of 1 to 20 bytes (1 to 20 characters).
Number of characters to be saved	Outputs the specified number of characters plus two characters. (Note 1)
Output sample	"ABCD"

(Note 1) Double quotation marks " " are added before and after character string data when a file is output.

Character string (with header)

- Available on FP0H Ver.1.9 or later

Data type	String (with 1 word header)	String (with 2 words header)
Description	You can specify the character string stored with the F253 SSET instruction. <ul style="list-style-type: none"> When S1 (storage area size) is K1 to K32767, select "String (with 1 word header)". When S1 (storage area size) is H8000, select "String (with 2 words header)". 	
Data size (Number of characters)	Specified in the range of 1 to 256 bytes (1 to 256 characters).	
Number of characters to be saved	Outputs the number of characters stored with the F253 SSET instruction plus two characters. Its upper limit is the number of characters as specified. (Note 1)	
Output examples	When specifying the character string stored with the F253 SSET instruction: <div style="text-align: center; margin: 10px 0;"> </div> <ul style="list-style-type: none"> Device registration example 	

Data type	String (with 1 word header)	String (with 2 words header)
	<div data-bbox="440 266 1009 649" style="border: 1px solid gray; padding: 5px;"> <div style="text-align: right; font-size: small;">×</div> Register devices <div style="margin-top: 5px;"> Device type: DT (data register) OK </div> <div style="margin-top: 5px;"> No.: 0 (0-32764,90000-90999) Cancel </div> <div style="margin-top: 5px;"> Data type: String (with 2 words header) </div> <div style="margin-top: 5px;"> No. of characters: 11 [1-256] </div> <div style="margin-top: 5px;"> Number of continuous registrations: 1 (1-128) </div> <div style="margin-top: 5px;"> Register comment: <div style="margin-left: 20px;"> Data name: ... </div> <div style="margin-left: 20px;"> Arbitrary application: </div> <div style="margin-left: 20px;"> Unit: </div> </div> </div> <div data-bbox="415 653 814 683" style="margin-top: 5px;"> <ul style="list-style-type: none"> • Saved character string: "ABC1230DEF" </div>	

(Note 1) Double quotation marks “ ” are added before and after character string data when a file is output.

(Note 2) For detailed operations of the **F253 SSET** instruction, refer to the *FP0H Programming Manual*.

(MEMO)

2 Configuration of Logging/ Trace Function

2.1 Definition of Buffer Memory	2-2
2.1.1 Setting Method	2-2
2.2 Logging Information Setting	2-3
2.2.1 Confirmation and Settings of File Information	2-3
2.2.2 LOG File Setting Items (For Logging)	2-4
2.3 Trace Information Setting	2-7
2.3.1 Confirmation and Settings of File Information	2-7
2.3.2 LOG File Setting Items (For Trace)	2-8
2.4 Registration of Device Information	2-11
2.5 Operation When Setting Cycle for Logging Trigger	2-13
2.6 Downloading Setting Data to Control Unit	2-15
2.6.1 Downloading to Non-volatile Memory	2-15

2.1 Definition of Buffer Memory

2.1 Definition of Buffer Memory

2.1.1 Setting Method

Setting method

- Define the buffer memory of the control unit used for the logging/trace function.
- The buffer memory is set with the tool software FPLWIN GR7.

1 2 Procedure

1. Select "Tool">"Logging/Trace Settings" in the menu bar.
The "Logging/Trace Settings" dialog box appears.

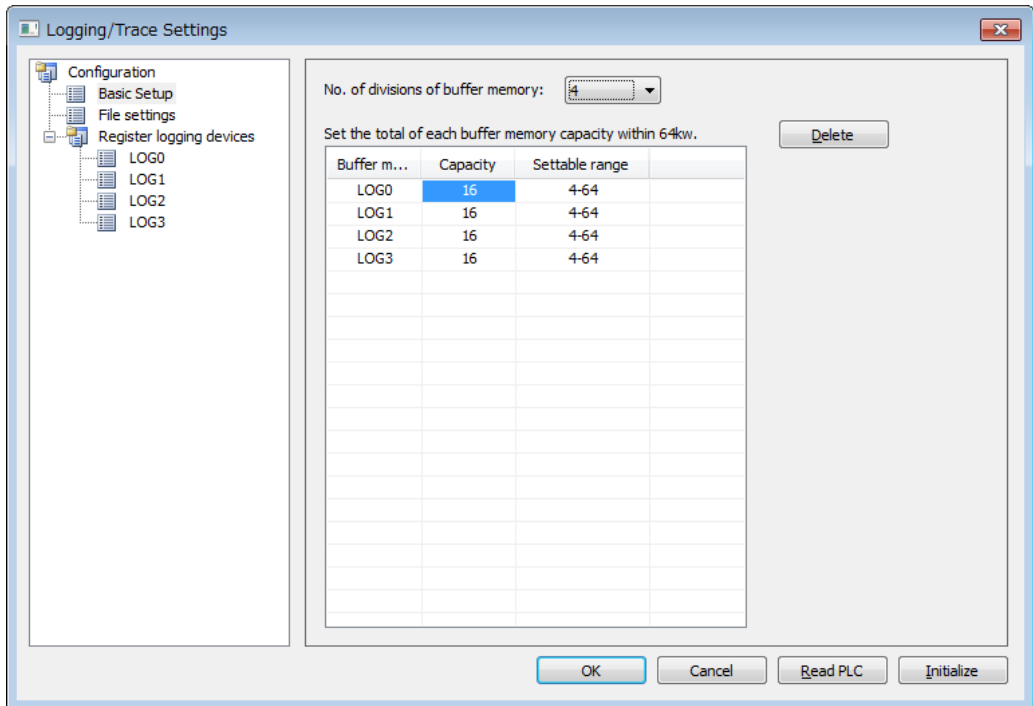

2. Select "No. of divisions of buffer memory" from the range of 1 to 4.
3. Double-click on the field of Capacity, and input a desired capacity.
Capacity is allocated to each buffer memory.

Setting range

Item	Default	Setting range
No. of divisions of buffer memory	4	1-4
LOG0-LOG3 Buffer memory capacity (unit: k word)	16	4-64

2.2 Logging Information Setting

2.2.1 Confirmation and Settings of File Information

Overview

- After completing the definition of buffer memory, set the data to be logged and the format of saved files.
- File formats and logged device data are set for each buffer memory (LOG0 to LOG3).

1 2 Procedure

1. Select "**Tool**">"**Logging/Trace Settings**" in the menu bar.
The "Logging/Trace Settings" dialog box appears.
2. Select "File settings" from the list on the left.

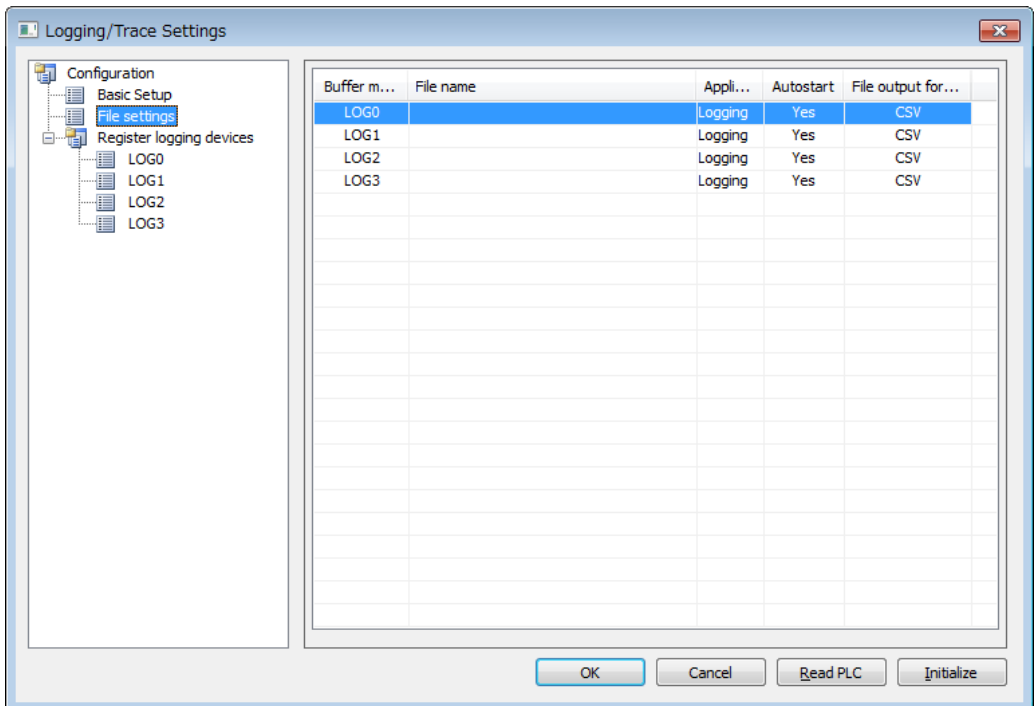

3. Double-click a desired buffer memory from the list on the right.
The LOG0 to LOG3 file settings dialog box appears.

2.2 Logging Information Setting

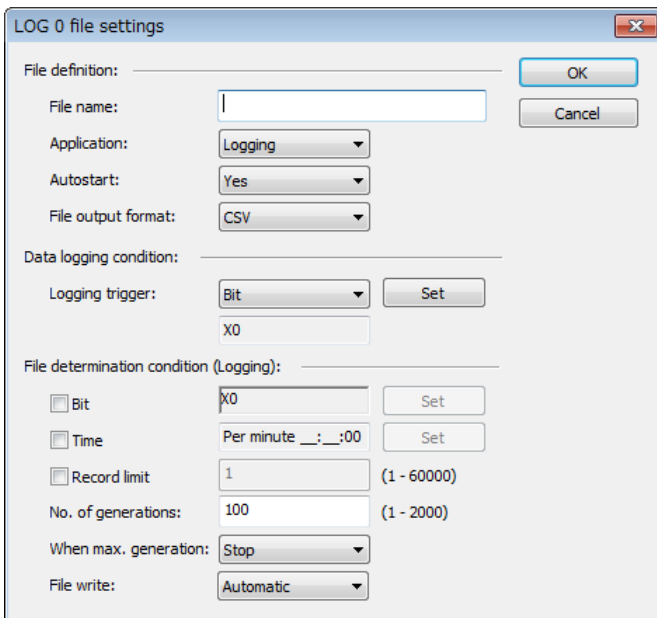

LOG file settings dialog box

4. Set information in each field of File definition, Data logging condition and File determination condition.
For the details of setting methods, refer to "2.2.2 LOG File Setting Items (For Logging)".
5. Press the [OK] button.
This returns to the Logging/Trace Settings dialog box.

i Info.

- More than one file determination condition can be set for logging application.
- Even when active logging stops, a file is determined.
- For the bit device of file determination condition, select a bit which turns on for only one scan at the end of scan.

2.2.2 LOG File Setting Items (For Logging)

The following items are set in the LOG file settings dialog box.

■ Setting item

	Item	Setting range	Settings
File definition	File name	Within 32 one-byte characters	Enter a file name to be saved in a selected LOG number.
	Application	Logging	Select Logging.
	Autostart	Yes / No	Yes: Logging operation starts when changing to the RUN mode.

	Item	Setting range	Settings
			No: Logging operation is started or stopped by the operation of programming tool or the F420(LOGST) instruction/ F421(LOGED) instruction in user programs.
	File output format	CSV	Select CSV.
Data logging condition	Logging trigger		Select a condition to start logging data.
	Bit	Specify an arbitrary bit device.	Select this for setting bit conditions as logging trigger. Press the [Set] button, and select a device type and a number. (Note 1)
	Cycle	Time data	Select this for setting time as logging trigger. Input a cycle for executing logging. (Note 2) 1 second, 2 seconds, 3 seconds, 4 seconds, 5 seconds, 6 seconds, 10 seconds, 15 seconds, 30 seconds, 1 minute, 2 minutes, 3 minutes, 4 minutes 5 minutes, 6 minutes, 10 minutes, 15 minutes, 30 minutes, 1 hour, 2 hours, 3 hours, 4 hours, 6 hours, 12 hours, 24 hours
	Time	Clock data	Select this for setting clock time as logging trigger. Specify the time for starting logging. Per minute, Per hour, Every day, Every week, Every month, Every year
	Instruction	-	Trigger conditions occur by executing the F422(LOGSMPL) instruction under arbitrary conditions in user programs.
	File determination condition	Bit	Specify an arbitrary bit device.
Time		Per minute, Per hour, Every day, Every week, Every month, Every year	Select this for setting a fixed time as file determination condition. Specify a time for determining files.
		Clock data	
Record limit		1 to 60000	Select this for setting the number of records as file determination condition. Specify the upper limit.
No. of generations		1 to 2000	Set the number of files (generations) to be saved in folder.
When max. generation		Stop, Continue	Stop: Stops logging. Continue: Determines a file, and deletes the oldest file in the PLC. After that, creates a new file.
File write		Automatic, 1 record unit	Automatic: Once a file is determined, executes writing it into an SD memory card. 1 record unit: Writes data to a file every time one record is written.

(Note 1) For the bit device of file determination condition, select a bit which turns on for only one scan at the end of scan.

(Note 2) When the logging trigger is cycle and setting per second or per minute, adjust to occur a trigger at 0 min. 0 sec. of every hour. When the unit of cycle is time, adjust to occur a trigger at 00:00:00 of every day. For details, refer to "2.5 Operation When Setting Cycle for Logging Trigger".

■ "Logging trigger" - "Trigger device" setting dialog box

- Set this for using bit device for the condition to start logging.

2.2 Logging Information Setting

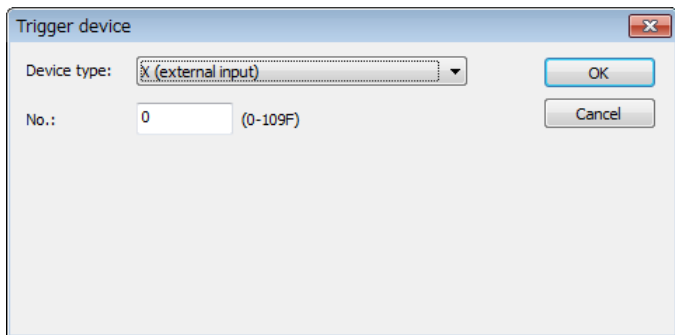

■ "Logging trigger" - "Periodic Trigger" setting dialog box

- Set this for performing logging periodically.

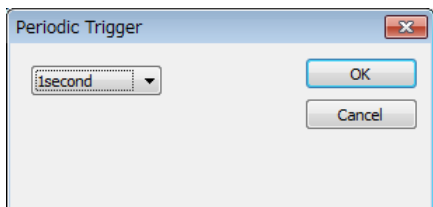

■ "Logging trigger" - "Time Trigger" setting dialog box

- Set this for performing logging at fixed intervals.

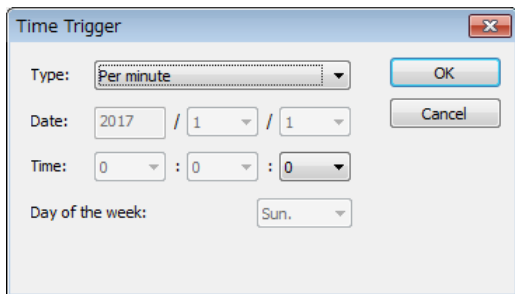

■ "Logging trigger" - Trigger condition setting with F422 (LOGSMPL) instruction

- Specify a logging number with the dedicated instruction, and execute with an arbitrary condition.

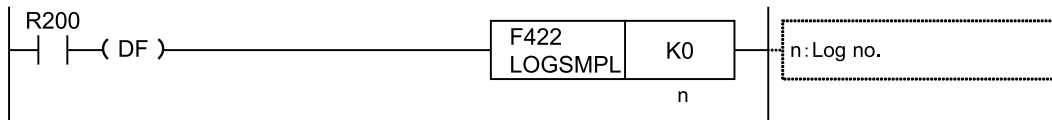

2.3 Trace Information Setting

2.3.1 Confirmation and Settings of File Information

- The following items are set in the LOG file settings dialog box.

Overview

- After completing the definition of buffer memory, set the data to be traced and the format of saved files.
- File formats and traced device data are set for each buffer memory (LOG0 to LOG3).

1 2 Procedure

1. Select **Tool>Logging/Trace Settings** in the menu bar.
The "Logging/Trace Settings" dialog box appears.
2. Select "File settings" from the list on the left.

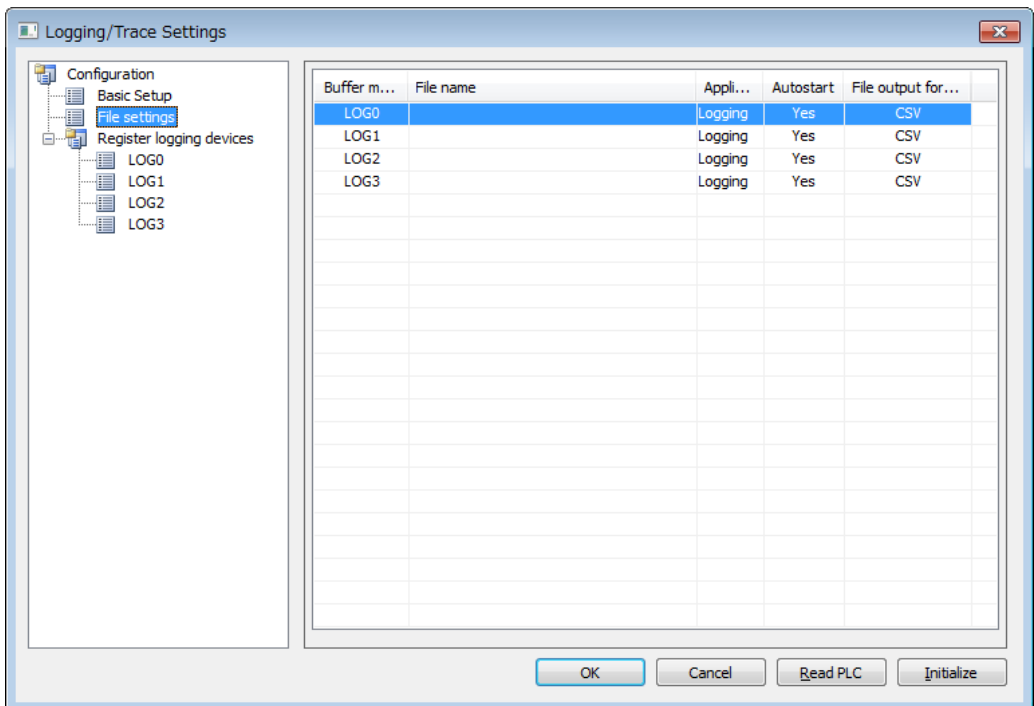

3. Double-click a desired buffer memory from the list on the right.
The LOG0 to LOG3 file settings dialog box appears.

2.3 Trace Information Setting

4. Set information in each field of File definition, Data logging condition and Trace stop. For the details of setting methods, refer to "2.3.2 LOG File Setting Items (For Trace)".
5. Press the [OK] button.
This returns to the Logging/Trace Settings dialog box.

i Info.

- "No. of samplings after stop trigger" is available only when the stop trigger is set to Bit.
- Check the box of [Write file after completion of trace] to create a file in a SD memory card after the completion of trace.

2.3.2 LOG File Setting Items (For Trace)

- The following items are set in the LOG file settings dialog box.

■ Setting item

	Item	Setting range	Settings
File definition	File name	Within 32 characters	Enter a file name to be saved in a selected LOG number.
	Application	Trace	Select Trace.
	Autostart	Yes / No	Yes: Trace operation starts when changing to the RUN mode. No: Trace operation is started by the operation of programming tool or the LOGST instruction in user programs.
	File output format	CSV	Select CSV.

	Item	Setting range	Settings
Data logging condition	Logging trigger		Select a condition to start logging data.
	Bit	Specify an arbitrary bit device.	Select this for setting bit conditions as logging trigger. Press the [Set] button, and select a device type and a number.
	Cycle	Time data	Select this for setting time as logging trigger. Input a cycle for executing trace. 1 second, 2 seconds, 3 seconds, 4 seconds, 5 seconds, 6 seconds, 10 seconds, 15 seconds, 30 seconds, 1 minute, 2 minutes, 3 minutes, 4 minutes 5 minutes, 6 minutes, 10 minutes, 15 minutes, 30 minutes, 1 hour, 2 hours, 3 hours, 4 hours, 6 hours, 12 hours, 24 hours Specify in msec: 1 to 1000
	Instruction	-	Trigger conditions occur by executing the F422(LOGSMPL) instruction under arbitrary conditions in user programs.
Trace stop condition	Stop trigger		Stops Trace.
		Bit	Press the [Set] button to specify a device type, a number and the number of samplings after the detection of stop trigger.
		Buffer full	Trace operation stops once the buffer is full.
	No. of samplings after stop trigger detection	0 to 65536	Specify the number of samplings after the detection of stop trigger.
	File write	Auto	On completion of trace operation, executes writing data into an SD memory card.

■ "Logging trigger" - "Trigger device" setting dialog box

Set this for using bit device for the condition to start tracing.

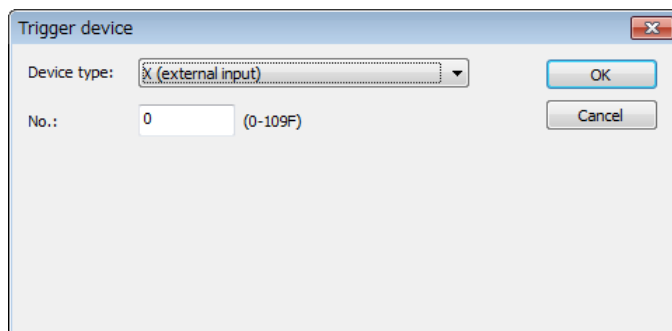

■ "Logging trigger" - "Periodic Trigger" setting dialog box

Set this for performing tracing periodically. When selecting Trace for Application, it can be specified in msec.

2.3 Trace Information Setting

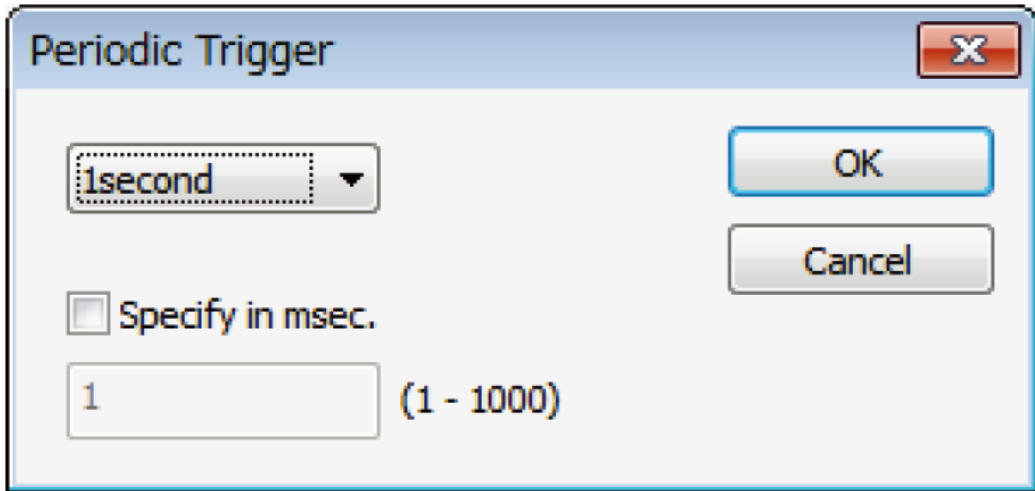

■ "Logging trigger" - Trigger condition setting with F422(LOGSMPL) instruction

Specify a logging number with the dedicated instruction, and execute with an arbitrary condition.

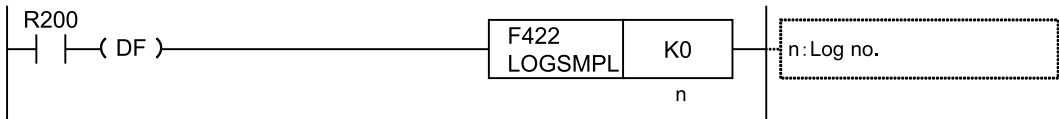

2.4 Registration of Device Information

Overview

- Devices on which logging/trace is performed are registered in "Register logging devices".

1 2 Procedure

1. Select a desired LOG number of Register logging devices from the list on the left side.

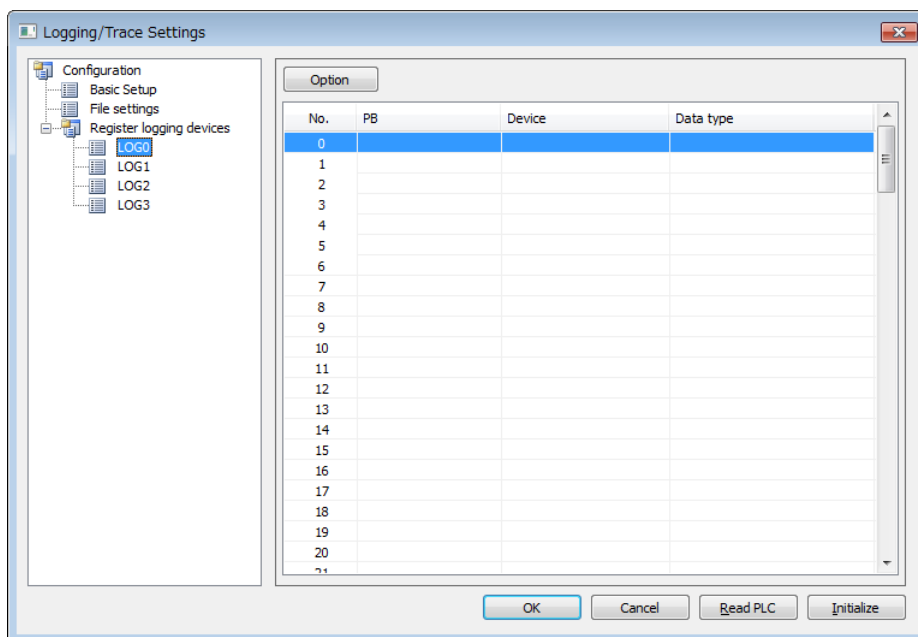

2. Double-click a desired buffer memory from the list on the right. The "Register devices" dialog box appears.

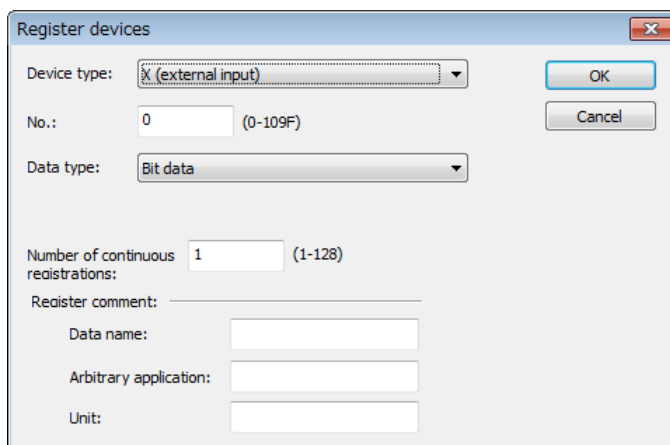

3. Enter a desired device number and comments, and press the [OK] button. The device on which logging is performed is registered in the LOG number.

2.4 Registration of Device Information

- Repeat the registration of devices for each LOG number.

i Info.

- The number of devices that can be registered in one LOG number is up to 128 devices.
- Press the <INS> key to insert items in the device list, and press the key to delete them.

Setting items ("Register devices" dialog box)

Item	Setting range	Settings	
Device type	X, Y, R, L, T, C	Specify a device type to be logged.	
	WX, WY, WR, WL, DT, LD, I, SV, EV		
No.	Device no.	Specify a device number to be logged.	
Data type	Bit data	Specify a data format to be output. The settable range varies according to the number of selected devices.	
	Unsigned 16-bit integer		
	Signed 16-bit integer		
	Unsigned 32-bit integer		
	Signed 32-bit integer		
	Single-precision real		
	HEX (1 word)		
	HEX (2 words)		
	String		
String (with 1 word header)			
String (with 2 words header)			
Decimal point	0 to 11	The position of decimal point can be set when an integer type is selected for Data type. The settable range varies according to the selected data type.	
No. of continuous registrations	1 to max. 128	Input a number for specifying the same type of devices all at once. The settable range varies according to the number of selected devices.	
Register comment	Data name	Within 16 characters	Output to the comment area when saving data in CSV format.
	Arbitrary application	Within 8 characters	
	Unit	Within 8 characters	

2.5 Operation When Setting Cycle for Logging Trigger

When setting Cycle for logging triggers, the time of the first trigger is adjusted to perform subsequent logging at good timing.

- When the unit of cycle is second or minute, adjust to occur a trigger at 0 min. 0 sec. of every hour.
- When the unit of cycle is time, adjust to occur a trigger at 00:00:00 of every day.

■ Example of timing of trigger occurrence (when the unit of cycle is second)

Time at which logging trigger condition is met	Set cycle	Time at which the 1st trigger occurs after adjustment	Time at which subsequent triggers occur
12:01:05	1 seconds	12:01:06	12:01:07, 12:01:08
12:01:05	2 seconds	12:01:06	12:01:08, 12:01:10
12:01:05	3 seconds	12:01:06	12:01:09, 12:01:12
12:01:05	4 seconds	12:01:08	12:01:12, 12:01:16
12:01:05	5 seconds	12:01:10	12:01:15, 12:01:20
12:01:05	10 seconds	12:01:10	12:01:20, 12:01:30
12:01:05	15 seconds	12:01:15	12:01:30, 12:01:45
12:01:05	30 seconds	12:01:30	12:02:00, 12:02:30

■ Example of timing of trigger occurrence (when the unit of cycle is minute)

Time at which logging trigger condition is met	Set cycle	Time at which the 1st trigger occurs after adjustment	Time at which subsequent triggers occur
12:01:00	1 minutes	12:02:00	12:03, 12:04, 12:05
12:03:00	2 minutes	12:04:00	12:04, 12:06, 12:08
12:05:00	3 minutes	12:06:00	12:09, 12:12, 12:15
12:05:00	4 minutes	12:08:00	12:12, 12:16, 12:20
12:05:00	5 minutes	12:10:00	12:15, 12:20, 12:25
12:01:00	10 minutes	12:10:00	12:20, 12:30, 12:40

2.5 Operation When Setting Cycle for Logging Trigger

Time at which logging trigger condition is met	Set cycle	Time at which the 1st trigger occurs after adjustment	Time at which subsequent triggers occur
12:59:00	15 minutes	13:00:00	13:15, 13:30, 13:45
12:10:00	30 minutes	12:30:00	13:00, 13:30, 14:00

■ Example of timing of trigger occurrence (when the unit of cycle is hour)

Time at which logging trigger condition is met	Set cycle	Time at which the 1st trigger occurs after adjustment	Time at which subsequent triggers occur
12:59:00	1 hours	13:00:00	14, 15, 16 o'clock ...
12:59:00	2 hours	14:00:00	16, 18, 20 o'clock ...
12:30:00	3 hours	15:00:00	18, 21, 24 o'clock ...
12:30:00	4 hours	16:00:00	20, 24, 28 o'clock ...
12:30:00	6 hours	18:00:00	24, 30, 36 o'clock ...
12:30:00	12 hours	24:00:00	36, 48, 60 o'clock ...
12:30:00	24 hours	24:00:00	48, 72, 96 o'clock ...

2.6 Downloading Setting Data to Control Unit

2.6.1 Downloading to Non-volatile Memory

■ Overview

Parameters set in the logging/trace settings menu are downloaded together with programs and configuration data as project data.

(MEMO)

3 Logging/Trace Start, Stop and Monitor

3.1 Start and Stop of Logging/Trace Operation	3-2
3.1.1 Start and Stop by Tool Software	3-2
3.1.2 Start and Stop by Instructions	3-3
3.1.3 Automatic Start by Setting	3-3
3.2 Operation Check Using Logging/Trace Monitor	3-4
3.2.1 Logging/Trace Monitor	3-4
3.2.2 Special Internal Relays Relating to Logging/Trace Operation	3-5
3.2.3 Special Data Registers Relating to Logging/Trace Operation.....	3-6
3.2.4 Checking Logging Speed (When Selecting Logging For Application)	3-6

3.1 Start and Stop of Logging/Trace Operation

3.1 Start and Stop of Logging/Trace Operation

3.1.1 Start and Stop by Tool Software

Overview

The logging/trace operation can be started and stopped by the tool software.

1 2 Procedure

1. Select "Tool">"Logging/Trace Monitor" in the menu bar.
The "Logging/Trace Monitor" dialog box appears.

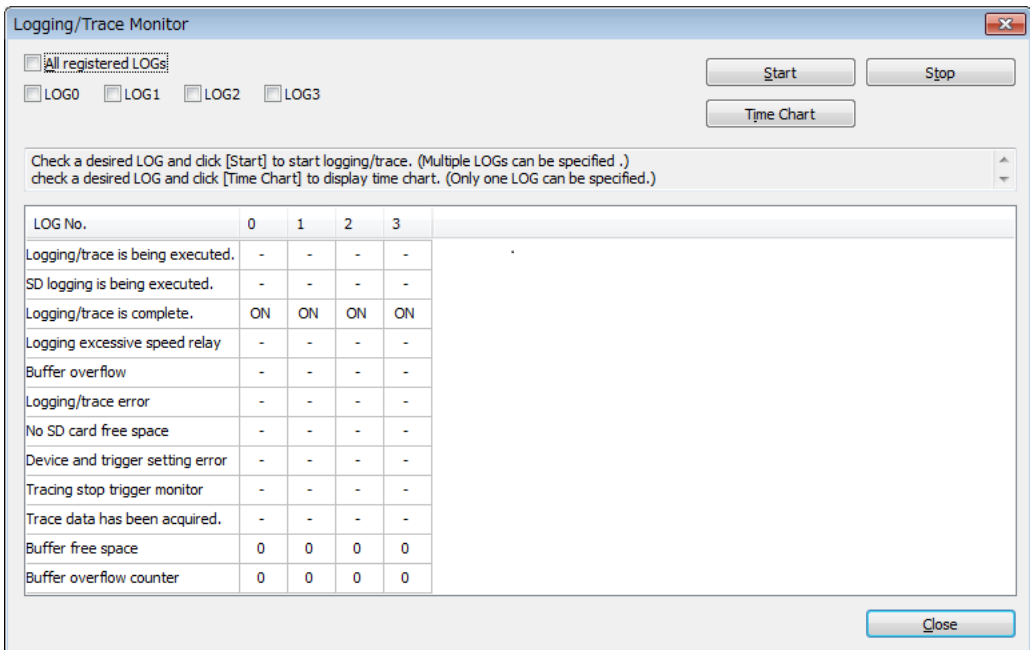

2. Check the box of a desired LOG number, and press the [Start] button.
A confirmation message appears.
3. Press the [Yes] button.
Starting the logging operation is requested by the operation specified in the "Logging/Trace Settings" dialog box. System relays relating to the execution of logging/trace can be monitored in the above dialog box. Once the operation is started normally, the "Logging/Trace is being executed" and "SD logging is being executed" flags turn on.
4. For stopping the logging/trace operation, check the box of a desired LOG number and press the [Stop] button.
Stopping the logging/trace operation is requested. Once the logging/trace operation ends normally, the "Logging/trace is complete" flag turns on.

3.1.2 Start and Stop by Instructions

■ Overview

- The logging/trace operation can be started and stopped by user programs for each logging/trace number.
- Specify a logging/trace number (0 to 3) using the dedicated instruction, and execute with arbitrary conditions.

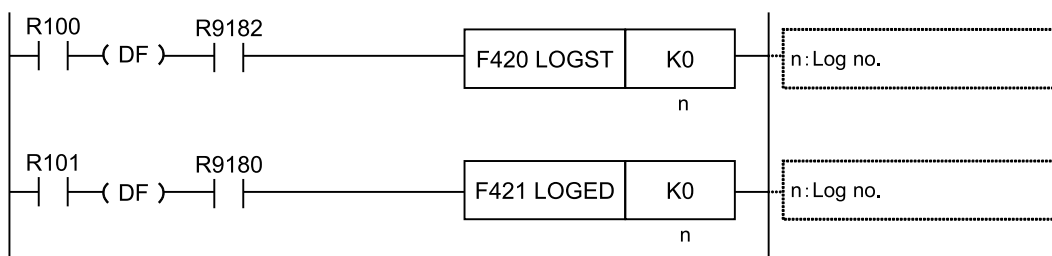

- It takes a few milliseconds to a few seconds to start or stop the logging/trace operation.
- For stopping the logging/trace operation with instructions, request the stop after confirming that the execution active flag (R9180/R9190/R9200/R9210) turns on. If requesting to stop LOG n during the start operation, the operation error flag (R9007/R9008) or the logging/trace error flag (R9185/R9195/R9205/R9215) turns on.
- For starting the logging/trace operation with instructions, request the start after confirming that the logging/trace completed flag (R9182/R9192/R9202/R9212) turns on. If requesting to stop LOG n during the start operation, the operation error flag (R9007/R9008) or the logging/trace error flag (R9185/R9195/R9205/R9215) turns on.
- There is no problem if a start request is made for LOG n that is activated or during the startup operation.
- There is no problem if a stop request is made for LOG n that is stopped or during the stop operation.

3.1.3 Automatic Start by Setting

- When "Autostart" has been selected in the "LOG file settings" dialog box, the start request of the logging/trace operation is made immediately after the mode is switched to RUN mode.



- The trace operation stops when the trace stop condition (bit device ON or buffer full) is met. If the operation is forcibly stopped with the tool software or instruction while the trace stop condition has not been satisfied, the trace operation is canceled and the data is not saved.

3.2 Operation Check Using Logging/Trace Monitor

3.2 Operation Check Using Logging/Trace Monitor

3.2.1 Logging/Trace Monitor

The progress situation can be confirmed with the logging/trace monitor.

■ Example of monitoring in logging operation

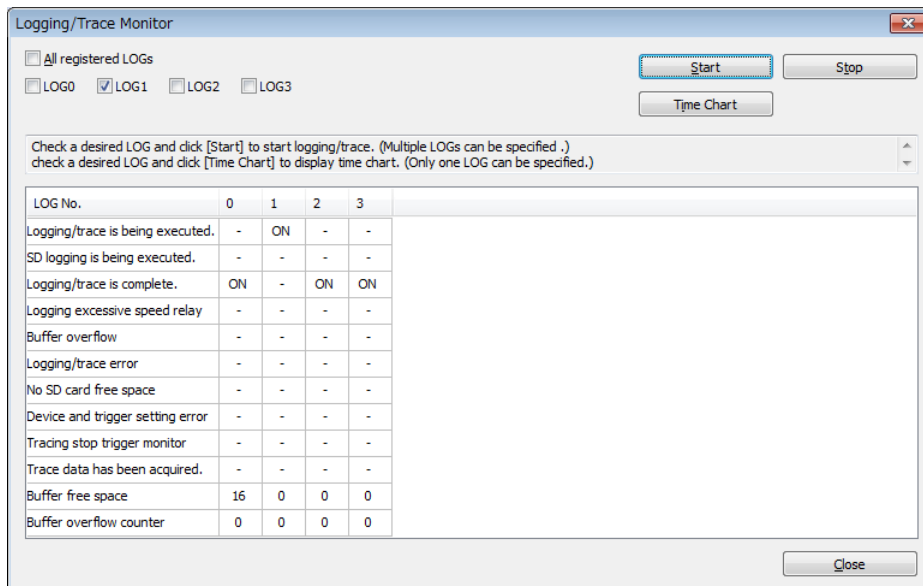

The screenshot shows the 'Logging/Trace Monitor' window. At the top, there are checkboxes for 'All registered LOGs', 'LOG0', 'LOG1' (checked), 'LOG2', and 'LOG3'. To the right are 'Start', 'Stop', and 'Time Chart' buttons. Below these is a text box with instructions: 'Check a desired LOG and click [Start] to start logging/trace. (Multiple LOGs can be specified.)' and 'check a desired LOG and click [Time Chart] to display time chart. (Only one LOG can be specified.)'. The main area contains a table with the following data:

LOG No.	0	1	2	3
Logging/trace is being executed.	-	ON	-	-
SD logging is being executed.	-	-	-	-
Logging/trace is complete.	ON	-	ON	ON
Logging excessive speed relay	-	-	-	-
Buffer overflow	-	-	-	-
Logging/trace error	-	-	-	-
No SD card free space	-	-	-	-
Device and trigger setting error	-	-	-	-
Tracing stop trigger monitor	-	-	-	-
Trace data has been acquired.	-	-	-	-
Buffer free space	16	0	0	0
Buffer overflow counter	0	0	0	0

A 'Close' button is located at the bottom right of the window.

■ Example of monitoring on the completion of trace operation

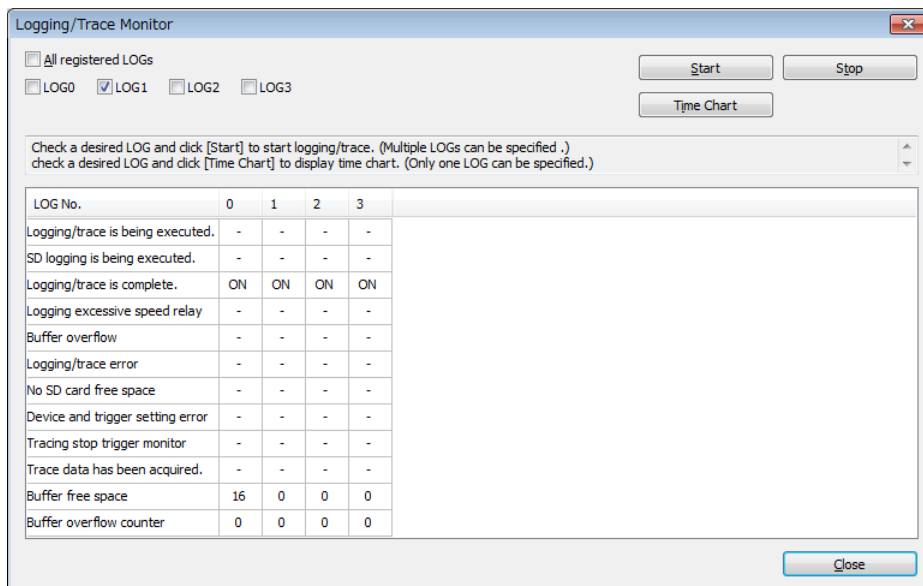

The screenshot shows the 'Logging/Trace Monitor' window. The 'LOG1' checkbox is still checked. The 'Start' and 'Stop' buttons are now disabled. The 'Time Chart' button is also disabled. The text box contains the same instructions as in the previous screenshot. The table data is as follows:

LOG No.	0	1	2	3
Logging/trace is being executed.	-	-	-	-
SD logging is being executed.	-	-	-	-
Logging/trace is complete.	ON	ON	ON	ON
Logging excessive speed relay	-	-	-	-
Buffer overflow	-	-	-	-
Logging/trace error	-	-	-	-
No SD card free space	-	-	-	-
Device and trigger setting error	-	-	-	-
Tracing stop trigger monitor	-	-	-	-
Trace data has been acquired.	-	-	-	-
Buffer free space	16	0	0	0
Buffer overflow counter	0	0	0	0

A 'Close' button is located at the bottom right of the window.

3.2.2 Special Internal Relays Relating to Logging/Trace Operation

■ Special Internal Relay

Device no.	Name	Operation
R9180	Logging/trace is being executed.	Turns on while the logging/trace function is activated. Another system relay allocated to the same LOG number is reset during the start operation. The logging/trace function is activated by any of the following methods; 1: Autostart, 2: Start by instruction, 3: Start by tool software. Storing data in the buffer memory is executed while this relay is on.
R9181	Logging/trace buffer storage/File being written	Turns on when writing files into an SD memory card becomes enabled after turning on the logging/trace active relay and enabling the logging in the buffer. This relay is always off when selecting Trace for the application.
R9182	Logging/trace completed	Turns on after the completion of file writing when requesting to stop the logging trace operation or performing the automatic stop.
R9183	Logging over-speed relay	Turns on when the buffer logging speed exceeds the writing speed to an SD memory card in the logging processing. Turns on when the number of data previously stored and the number of data stored this time increase. Turns on at the timing of buffer logging, and turns off at the timing of buffer logging or the end of scan.
R9184	Buffer overflow	Turns on when the buffer memory has been exhausted. The buffer overflow counter (DT90620) is incremented by one. At that time, new data cannot be stored. Also, writing data into the SD memory card does not stop. The buffer overflow relay turns off at the end of scan when a vacancy occurs in the buffer as writing data into an SD memory card progresses, and the buffer overflow counter is cleared to 0. Also, after the occurrence of vacancy in the buffer, data logging is executed once the logging trigger condition is met. This relay is always on when buffer full occurs as the stop condition when selecting Trace for the application.
R9185	Logging/trace error	Turns on when an error is detected during the logging/trace operation and stops the operation.
R9186	No SD card free space	Turns on when one of the following conditions is met during the logging/trace operation and stops the logging/trace operation. When an SD memory card is running out of free space When an error in accessing an SD memory card occurs.
R9187	Device/trigger setting error	Turns on when an error is detected in setting values during the startup operation. The logging/trace error relay R9185 also turns on. At that time, the active relay does not turn on because the logging/trace function cannot be activated.
R9188	Trace stop trigger monitor	Monitors a registered trace stop trigger when executing tracing. Turns on when the condition is met. This relay is always off when selecting Logging for the application.
R9189	Trace data acquisition completed	Turns on after logging data for a specified number of times after detecting the trace stop trigger during the execution of trace. This relay is always off when selecting Logging for the application.

(Note 1) The above device numbers are those for LOG0. Special internal relay numbers vary depending on LOG numbers as shown in the table below.

LOG no.	0	1	2	3
Relay no.	R9180 to R9189	R9190 to R9199	R9200 to R9209	R9210 to R9219

3.2 Operation Check Using Logging/Trace Monitor

3.2.3 Special Data Registers Relating to Logging/Trace Operation

■ Special data registers

Device no.	Name	Operation
DT90600	Buffer free space	Stores free space of buffer memory during logging. This is always zero when selecting Trace for the application.
DT90620	Buffer overflow counter	Increments the value by one when the buffer overflow occurs. This is always zero when selecting Trace for the application.
DT90640	No. of written records of current file	Stores the number of written records in a current file as 16-bit data. Increments the number by one every time data is written in the current file. It is reset to zero when a new file is created.
DT90660	No of files (generations) stored in folder	Stores the number of files stored in a folder (number of generations) as 16-bit data.
DT90680 -DT90681	Oldest clock data of file stored in folder	Stores the oldest clock data of a file stored in a folder as 32-bit data in seconds. The clock data is the number of seconds accumulated from 00:00:00 on January 1, 2001.

(Note 1) The above device numbers are those for LOG0. Special data register numbers vary depending on LOG numbers as shown in the table below.

LOG no.	0	1	2	3
Buffer free space	DT90600	DT90601	DT90602	DT90603
Buffer overflow counter	DT90620	DT90621	DT90622	DT90623
No. of written records of current file	DT90640	DT90641	DT90642	DT90643
No of files (generations) stored in folder	DT90660	DT90661	DT90662	DT90663
Oldest clock data of file stored in folder	DT90680 -DT90681	DT90682 -DT90683	DT90684 -DT90685	DT90686 -DT90687

3.2.4 Checking Logging Speed (When Selecting Logging For Application)

- When the logging speed to the buffer memory of the control unit is faster than the writing speed into an SD memory card, the logging over-speed relay turns on. The logging over-speed relay turns on at the timing of logging trigger, and turns off if the speed does not exceed at the end of scan.
- If overspeed occurs frequently, the buffer memory will be full and data cannot be accumulated.
- Once the buffer memory is full, the buffer overflow flag turns on, and the buffer overflow counter is incremented by one.
- If the buffer overflow occurs continuously, revise the logging conditions to decrease the logging speed.
- To know how much logging data was lost at the time of buffer overflow, register the buffer overflow counter as logging data.
- Even if the buffer overflow occurs, recording data into an SD memory card goes on, and logging continues when free space becomes available in the buffer.

3.2 Operation Check Using Logging/Trace Monitor

- The free space of buffer memory can be checked with the system data registers DT90600 to DT90603.
- The system relays (R9184/R9194/R9204/R9214) give a warning when the buffer memory of each LOG number is full.

(MEMO)

4 Logging Operation

4.1 Flow of Logging Operation.....	4-2
4.1.1 Operation Flow.....	4-2
4.2 Operation When Logging is Selected for Application	4-4
4.2.1 Operation When Logging Operation is Started	4-4
4.2.2 Operation When Logging Operation Stops	4-4
4.2.3 Operation When Power Supply Turns Off.....	4-4
4.2.4 Operation When the Battery Cover of Control Unit is Open	4-4
4.2.5 Operation When the Number of Determination Files Reaches the Maximum Number of Generations	4-5
4.3 System Management Information Relating to Logging Function	4-7
4.3.1 System Management Information and Operation	4-7
4.3.2 Clearing Management Information.....	4-7

4.1 Flow of Logging Operation

4.1 Flow of Logging Operation

4.1.1 Operation Flow

■ Triggers of logging operation and file contents

Step	Operation	Trigger of operation	File in LOG folder	File contents
(1)	Start	<ul style="list-style-type: none"> • Tool software operation • Instruction • Auto start by setting 		
(2)	Logging	<ul style="list-style-type: none"> • Bit device ON • Cycle • Instruction • Time 	Sample (-----current-----) .csv"	Comment file part First record
		<ul style="list-style-type: none"> • Bit device ON • Cycle • Instruction • Time 	Sample (-----current-----) .csv"	Comment file part First record Second record
Logging operation continues until the file determination condition is met. (Note 1)				
(3)	File determination	<ul style="list-style-type: none"> • Bit device ON • Time • Record limit 	Sample (130401_120000) .csv"	Comment file part Records up to file determination
			Sample (-----current-----) .csv"	Comment file part
(2)	Logging	<ul style="list-style-type: none"> • Bit device ON • Cycle • Instruction • Time 	Sample (130401_120000) .csv"	Comment file part Records up to file determination
			Sample (-----current-----) .csv"	Comment file part First record
Logging operation continues until the file determination condition is met. (Note 1)				
(3)	File determination	<ul style="list-style-type: none"> • Bit device ON • Time • Record limit 	Sample (130401_120000) .csv" Sample (130401_130000) .csv"	Comment file part Records up to file determination
			Sample (-----current-----) .csv"	Comment file part
Logging, file determination, and logging operation continues until the stop condition is met. (Note 1)				
(4)	Stop	<ul style="list-style-type: none"> • Tool software operation • Instruction • Max. generation 	Sample (130401_120000) .csv" Sample (130401_130000) .csv"	Comment file part Records up to file determination
			Sample (130401_140000) .csv"	Comment file part Records up to stop

(Note 1) "Logging in the logging buffer (RAM)" and "writing to an SD memory card from the logging buffer" are controlled on the system side. They cannot be controlled by user programs.

■ Flow of Logging Operation

Step (1) Startup of logging operation

- The logging operation is started by any of the following methods; Tool software operation, Instruction in a user program, and Autostart setting.

Step (2)-a: Data logging into logging buffer memory (RAM)

- After the startup of logging operation, logging data is executed with a specified condition once the specified trigger condition (bit device ON, cycle, or time) is met.
- Logged data is stored once in the logging buffer memory (RAM) of the control unit.

Step (2)-b: Data transfer to SD memory card from logging buffer memory (RAM)

- Data is stored in the logging buffer memory (RAM) sequentially, and automatically written to a file in an SD memory card by the control unit. It cannot be controlled by user programs.
- A LOG folder is created in an SD memory card for the LOG number that a file name is set.
- A file "specified file name (-----current-----).csv" for saving logging data is created in the LOG folder.
- After that, the control unit continues saving data into the same file until the file determination condition is met.

Step (3): Determination of file

- The file is determined when the specified file determination condition (bit device ON, time, record limit) is met.
- The file determination is to rename the file "specified file name (-----current-----).csv" created in step (2) after writing all the data stored in the buffer into the SD memory card.
- The time data of the oldest record is added to the specified file name.
Example) When the file name is Sample, and the oldest record was recorded in 12 o'clock on April 1, 2013, it is saved as "specified file name (130401_120000).csv".
- Once the file is determined, a new file "specified file name (-----current-----).csv" for saving the next logged data is created. The logging operation restarts when the logging trigger condition is met.

Step (4): Stop of logging operation

- The logging operation is stopped by either of instruction in user programs or tool software operation.
- Once the logging operation stop is requested, all the data in the buffer memory in the control unit is written into the file in the SD memory card and determined. While the logging operation is continuing, the records logged so far are saved and the file is determined even if the specified file determination condition has not been satisfied.
- The time data of the oldest record is added to the specified file name.

Info.

- When the logging trigger setting is "Bit", "Cycle" or "Time", data is stored in the buffer memory at the end of the scan time. In the case of Instruction, it is stored when the F422 LOGSMPL instruction is executed.

4.2 Operation When Logging is Selected for Application

4.2 Operation When Logging is Selected for Application

4.2.1 Operation When Logging Operation is Started

The following operations are executed when the start operation is requested.

- Registered data is confirmed.
- Once the logging/trace becomes executable, the logging/trace execution active flag (R9180/R9190/R9200/R9210) turns on. When the logging trigger condition is met under this condition, the logging/trace operation starts.
- All logging/trace control relays other than the logging/trace execution active flags for LOG n (R9180/R9190/R9200/R9210) are cleared once during the start request operation.
- Once writing data into an SD memory card becomes enabled after the logging/trace execution active flag (R9180/R9190/R9200/R9210) turned on, the SD card buffer logging/file writing active flag (R9181/R9191/R9201/R9211) turns on.
- When an SD memory card that can be normally read and written is not inserted, or the battery cover is open, an operation error occurs.

4.2.2 Operation When Logging Operation Stops

■ Operation when switching from RUN mode to PROG. mode

- All logging operations stop.
- All information saved in the buffer memory of the control unit is written into a file, and the file is determined.

4.2.3 Operation When Power Supply Turns Off

■ Operation When Power Supply Turns Off

- When activating the logging/trace function, the power off flag during SD memory card access (R917F) turns on.
- The data stored in the logging buffer of the control unit will be discarded.



- In case of the middle of file writing, written data or files may be damaged, or the SD memory itself may not be read.

4.2.4 Operation When the Battery Cover of Control Unit is Open

The following operations are performed when the battery cover is open during the logging operation.

4.2 Operation When Logging is Selected for Application

■ Operation of system relays

- The logging/trace execution active flag and the SD card logging execution active flag (R9180/R9190/R9200/R9210) stays on while the battery cover is open.
- The logging/trace execution active flag (R9180/R9190/R9200/R9210) turns off when the condition to stop the logging operation is met. The SD card buffer logging/file writing active flag (R9181/R91919/R9201/R9211) is kept in the on state.
- The logging operation into the logging buffer (RAM) continues even when no SD memory card is inserted. Once the logging buffer (RAM) becomes full, the buffer overflow flag turns on.
- When the battery cover is closed, the SD card buffer logging/file writing active flag (R9181/R91919/R9201/R9211) also turns off.

■ File status in SD memory card

- The file "specified file name (-----current-----).csv" in which logging data was saved before opening the cover is held in the SD memory card.
- Once the battery cover is closed, saving data into files starts again.

4.2.5 Operation When the Number of Determination Files Reaches the Maximum Number of Generations

■ Operation when the number of determination files reaches the maximum number of generations

- The operation when the number of determination files reaches the maximum number of generations varies depending on the log file settings.

File determination condition Setting of "When max. generation"	Operation
Stop	<ol style="list-style-type: none">1. Determines a current file "specified file name (-----current-----).csv", gives the time data of the oldest record, and renames it.2. Creates a new current file "specified file name (-----current-----).csv".
Continue	<ol style="list-style-type: none">1. Determines a current file "specified file name (-----current-----).csv", gives the time data of the oldest record, and renames it.2. Deletes the oldest file. After deleting it, updates the data of the oldest file displayed in the system monitor area (SM).3. Creates a new current file "specified file name (-----current-----).csv".

4.2 Operation When Logging is Selected for Application

LOG 0 file settings

File definition:

File name:

Application: Logging

Autostart: Yes

File output format: CSV

Data logging condition:

Logging trigger: Bit

X0

File determination condition (Logging):

Bit

Time

Record limit (1 - 60000)

No. of generations: (1 - 2000)

When max. generation: Stop

File write: Stop
Continue

"Logging File Settings" dialog box

4.3 System Management Information Relating to Logging Function

4.3.1 System Management Information and Operation

- Files are managed in the PLC as follows. The PLC performs operations based on the stored management information even if an SD memory card is removed during logging, and another SD memory card in different conditions from the conditions managed in the PLC is inserted.
- Writing data into an undetermined file "specified file name (-----current-----).csv" is executed every time specified records are stored. The number of written records can be confirmed in the special data registers (DT90640 to DT90643).
- The number of determined files (generations) of determined files is managed during the logging operation. The number of determined files can be confirmed in the special data registers (DT90660 to DT90663).
- When the file is determined, the determined date is managed in the internal memory. The time data of the oldest file is stored in the special data registers (DT90680 to DT90687). The clock data is the number of seconds accumulated from 00:00:00 on January 1, 2001.

4.3.2 Clearing Management Information

■ Clearing management information

Log file management information of the PLC is cleared in the following cases.

- When LOG n settings are deleted or all log settings are initialized from the tool software FPWIN GR7
- When a buffer allocation different from stored data is downloaded, all log settings are initialized.
- When a LOG n definition different from stored data is downloaded, only the different LOG n is cleared.

i Info.

- If the above clearing operation is performed, log file management information is initialized, and files remained in the SD memory card are regarded as non-existent. Delete files beforehand, and use it.
- When restarting logging with the same condition without changing the settings, the operation continues with the previous system information, the number of generations and the oldest time data of the file. After restarting logging, the number of generations is added to the data before the restart, and the existing value is held for the oldest time data.

(MEMO)

5 Trace Operation and Time Chart

5.1	Flow of Trace Operation	5-2
5.1.1	Flow of Trace Operation.....	5-2
5.2	Operation When Trace is Selected for Application	5-4
5.2.1	Operation When Trace Operation is Started.....	5-4
5.2.2	Operation When Logging Operation Stops	5-4
5.2.3	Operation When Power Supply Turns Off.....	5-4
5.2.4	Operation When the Battery Cover of Control Unit is Open	5-4
5.3	Trace Monitor (Time Chart).....	5-6
5.3.1	Display Method of Time Chart.....	5-6
5.3.2	Explanation of Time Chart Monitor.....	5-7
5.3.3	Settings for Time Chart Display Area.....	5-9
5.3.4	Register Device.....	5-12
5.3.5	Sampling Condition Setting.....	5-13

5.1 Flow of Trace Operation

5.1 Flow of Trace Operation

5.1.1 Flow of Trace Operation

■ Triggers of trace operation and file contents

Step	Operation	Trigger of operation	File in LOG folder	File contents	
(1)	Start	Tool software operation Instruction Auto start by setting	—	—	
(2)	Logging	Bit device ON Cycle Instruction	—	—	
		Bit device ON Cycle Instruction	—	—	
Logging operation continues until the trace stop condition is met.					
(3)	Trace stop	When buffer full is set for stop trigger	Sample (130401_120000_TRACE) .csv"	Comment file part First record Second record STOP TRG	
	Trace stop	When bit device ON is set for stop trigger	Sample (-----current-----) .csv"	Comment file part First record Second record STOP TRG	
		Logging operation continues for the number of samplings after the detection of stop trigger.			
		Completion of logging for the number of samplings	Sample (130401_120030_TRACE) .csv"	Comment file part First record Second record STOP TRG XXX records	

■ Flow of Trace Operation

Step (1) Startup of trace operation

- The trace operation is started by any of the following methods; Tool software operation, Instruction in a user program, and Autostart setting.

Step (2): Data logging

- After the startup of the trace operation, tracing data is executed with a specified condition when the specified trigger condition (bit device ON, cycle, or instruction) is met.
- Traced data is stored in the logging buffer memory (RAM) in the control unit.
- After that, the trace operation continues until the trace stop condition is met.

Step (3): Stop of trace operation

- The trace operation stops when either condition is met, bit or buffer full.
- When the trace stop condition is bit, the trace operation stops after the logging performed for the specified number of samplings after the condition was met.
- When the trace stop condition is buffer full, the trace operation stops immediately.
- When the trace operation is complete successfully, the trace data acquisition done flag (R9189/R9199/R9209/R9219) turns on. At that time, a time chart can be displayed on the programming tool FPWIN GR7 by reading the logged data.
- When "Write file after completion of trace" is set, all the data in the buffer memory in the control unit is written into the file in the SD memory card and determined. The time stamp information is the time data at the time of the occurrence of stop trigger.

Info.

- In the data logging process into the buffer memory, when Bit or Cycle has been specified, the bit or the cycle is checked at the end of scan, and data is stored in the buffer memory when the condition is met. When Instruction has been set, data is stored into the buffer memory when the instruction is executed.
- If the trace operation is stopped by the tool software operation or the F421 (LOGED) instruction while the trace stop condition has not been met, logged data is not saved in either the buffer memory (RAM) or an SD memory card.

5.2 Operation When Trace is Selected for Application

5.2 Operation When Trace is Selected for Application

5.2.1 Operation When Trace Operation is Started

The following operations are executed when the start operation is requested.

- Registered data is confirmed.
- The logging/trace execution active flag (R9180/R9190/R9200/R9210) turns on.
- All other flags than the logging/trace execution active flag for LOG n are cleared during the start request operation.
- Once writing data into an SD memory card becomes enabled after the logging/trace execution active flag (R9180/R9190/R9200/R9210) turned on, the SD card buffer logging/file writing active flag (R9181/R9191/R9201/R9211) turns on.
- When the box of [Write file after completion of trace] has been checked in the LOG file settings dialog box, an operation error occurs if no SD memory card that is normally readable and writable is inserted, or the battery cover is open.

5.2.2 Operation When Logging Operation Stops

■ Operation when switching from RUN mode to PROG. mode

- All logging operations stop.
- The data stored in the buffer memory of the control unit will be discarded.

5.2.3 Operation When Power Supply Turns Off

■ Operation When Power Supply Turns Off

- When activating the logging/trace function, the power off flag during SD memory card access (R917F) turns on.
- The data stored in the logging buffer (RAM) of the control unit will be discarded.



- In case of the middle of file writing into an SD memory card, written data or files may be damaged, or the SD memory itself may not be read.

5.2.4 Operation When the Battery Cover of Control Unit is Open

The following operations are performed when the battery cover is open during the trace operation.

■ Operation of system relays

- The logging/trace execution active flag (R9180/R9190/R9200/R9210) stays on while the battery cover is open.

5.2 Operation When Trace is Selected for Application

- The logging operation into the logging buffer (RAM) continues even when no SD memory card is inserted. Once the logging buffer (RAM) becomes full, the buffer overflow flag (R9184/R9194/R9204/R9214) turns on.
 - The logging/trace execution active flag (R9180/R9190/R9200/R9210) turns off when the condition to stop the trace operation is met. The SD card buffer logging/file writing active flag (R9181/R9191/R9201/R9211) turns on.
 - Irrespective of whether writing data to an SD card is successful or not, when the condition to stop the trace operation is met and writing data to the SD card is performed, the SD card buffer logging/file writing active flag (R9181/R9191/R9201/R9211) turns off.
- **File status in SD memory card**
- If data cannot be written into the SD memory card after the completion of trace, the data stored in the logging buffer (RAM) will be discarded.

5.3 Trace Monitor (Time Chart)

5.3 Trace Monitor (Time Chart)

5.3.1 Display Method of Time Chart

Overview

- Time chart is a function to read the data stored in the PLC using the trace function and display them in graph form.
- By setting the trace function, the change in contacts/data can be checked by one scan.

1 2 Procedure

1. Select "Tool">"Logging/Trace Monitor" in the menu bar.
The "Logging/Trace Monitor" dialog box appears.

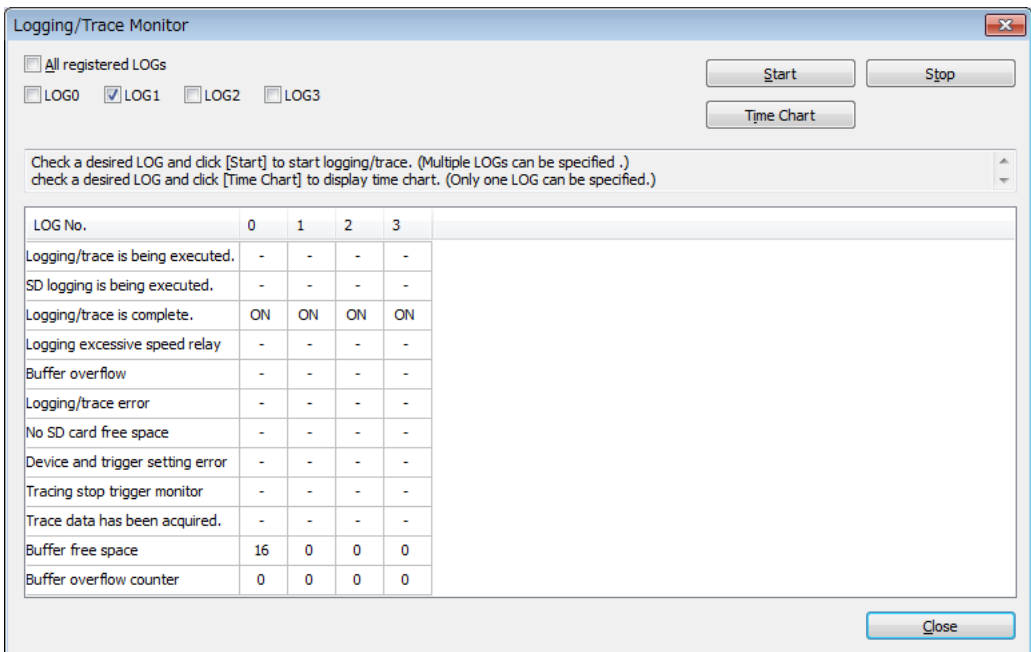

2. Check the box of one LOG number, and press the [Time Chart] button.
Select "Yes" in the following message box to read trace data from the PLC and display the time chart.

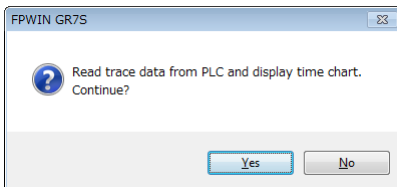

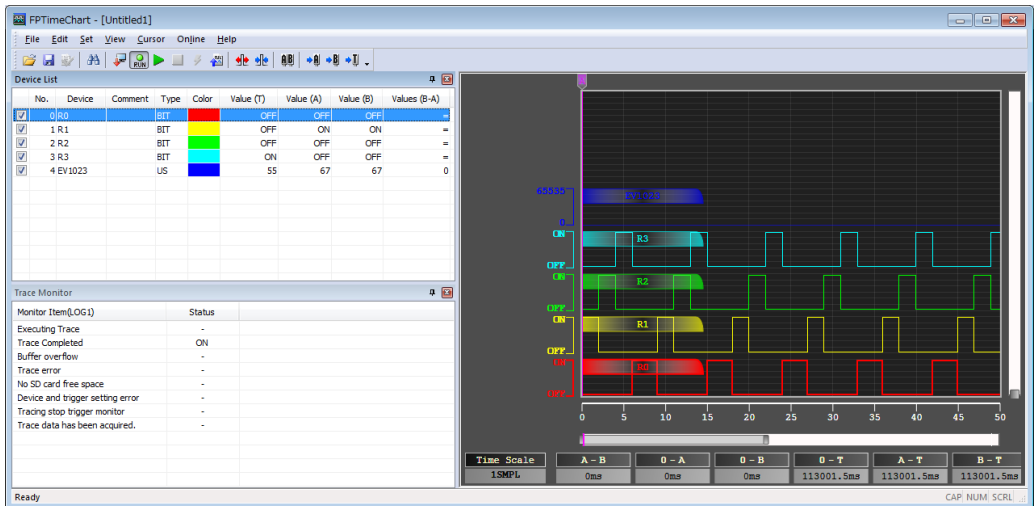

Info.

- The following conditions are required to display a time chart.
 - Only one LOG number is selected.
 - The target LOG is set to "Trace".
 - The logging/trace done flag of the target LOG is "ON".

When the stop trigger is detected, the "Trace stop trigger monitor flag" and "Trace data acquisition done flag" turn on.
- The time chart cannot be activated during executing the logging/trace operation.
- The indication of the "Buffer free space" of the LOG that has been set to Trace is always zero.

5.3.2 Explanation of Time Chart Monitor

The time chart window is composed of the following parts.

5.3 Trace Monitor (Time Chart)

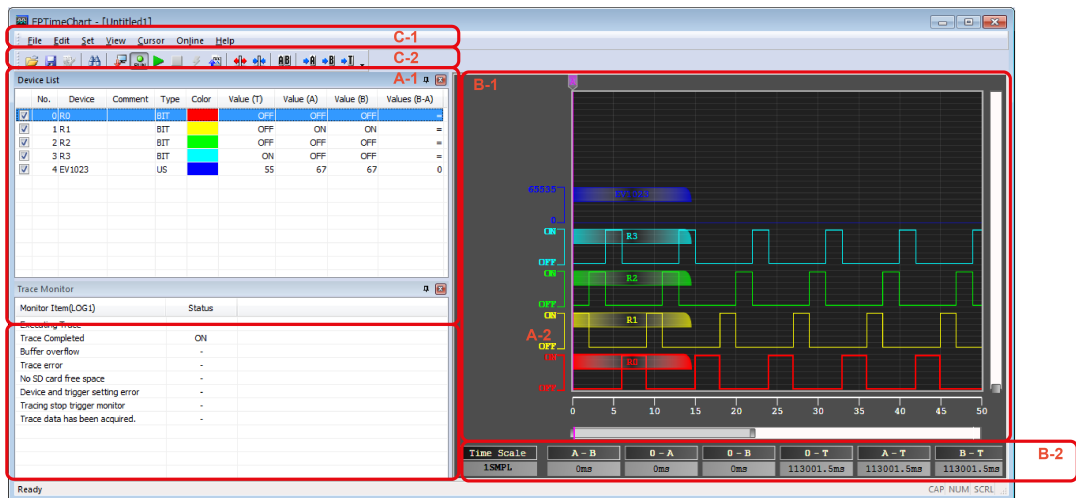

Names and Functions of Parts

Code	Name	Function
A-1	Device List	<p>Displays all the devices registered in the target LOG for the time chart display.</p> <ul style="list-style-type: none"> Select the device to be displayed in graphs from this list. Data corresponding to the range specified by the scroll bar at the bottom of the graph display area is displayed. By double-clicking a line in the device list, registering and editing devices can be performed.
A-2	Trace Monitor	<ul style="list-style-type: none"> The execution state of the race operation is monitored in this area. The contents of occurred errors can be confirmed.
B-1	Graph display area	<ul style="list-style-type: none"> Trace data is displayed as line graphs in chronological order. (The on/off state of contacts is displayed with rectangular wave form.) The vertical line with a [T] mark is displayed at the point where a trigger occurs.
B-2	Time scale display area	<p>Displays the time between arbitrary two points of B-1 or the time between the point where a trigger occurs and an arbitrary point.</p> <p>However, time is not displayed when the selected trigger type is other than "cycle".</p>

Info.

- The time scale display area is available only when the logging trigger is "Cycle". This area is not displayed when the logging trigger is "Bit" or "Instruction".

Code	Name	Function
C-1	Menu bar	<p>① ② ③ ④ ⑤ ⑥ ⑦</p> <p><u>F</u>ile <u>E</u>dit <u>S</u>et <u>V</u>iew <u>C</u>ursor <u>O</u>nline <u>H</u>elp</p>
		(1) Menus for operating time chart configuration files are collected here.
		(2) Menus for searching devices specified on the time chart are collected here.

Code	Name	Function
		(3) Menus for registering devices and setting sampling conditions.
		(4) Menus for setting the display of time chart.
		(5) Menus for displaying, selecting and moving a cursor.
		(6) Menus for configuring settings relating to the trace operations such as starting the trace operation and uploading trace data.
		(7) Shows the version information on the time chart monitor.
C-2	Toolbar	 <p>The toolbar contains 16 icons, each with a circled number above it. The icons are: 1. Folder icon, 2. Save icon, 3. Apply icon, 4. Search icon, 5. Download icon, 6. Run/Stop icon, 7. Stop icon, 8. Refresh icon, 9. PLC mode icon, 10. Upload icon, 11. Zoom in icon, 12. Zoom out icon, 13. Cursor selection icon, 14. Move cursor A icon, 15. Move cursor B icon, 16. Move cursor T icon.</p>
		(1) Opens a time chart configuration file.
		(2) Saves the time chart configuration file.
		(3) Applies the setting configured by FP Time Chart monitor to FPWIN GR7.
		(4) Searches a device specified on the Time Chart.
		(5) Downloads the trace setting to FPWIN GR7.
		(6) Switches the PLC mode to "RUN" or "PROG."
		(7) Starts Trace/Free run.
		(8) Stops Trace/Free run.
		(9) Generate a trigger. (Available in the sampling trace mode.)
		(10) Uploads trace data from the PLC, and displays the time chart.
		(11) Enlarges the time scale.
		(12) Reduces the time scale.
		(13) Switches whether to select cursors AB simultaneously or not.
		(14) Moves to cursor A.
		(15) Moves to cursor B.
		(16) Moves to cursor T.

5.3.3 Settings for Time Chart Display Area

■ Display setting (Common tabs)

Set the graph display area. Select "View" > "View Setting" in the menu bar to display the setting screen.

5.3 Trace Monitor (Time Chart)

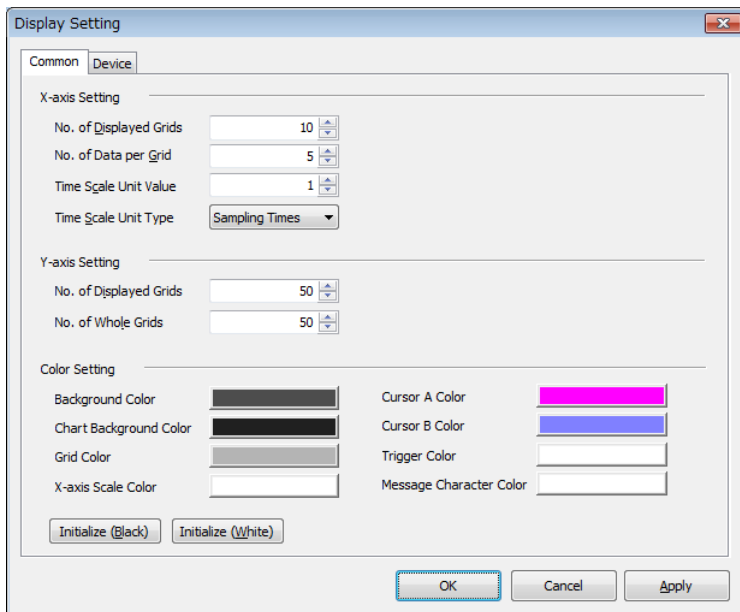

	Item	Range	Description
X-axis Setting	No. of Displayed Grids	10 to 1000	Set the number of displayed grids in the X-axis direction of the chart display part.
	No. of Data per Grid	1 to 100	Set the number of trace data displayed within one grid.
	Time Scale Unit Value	Sampling Times: 1 to 1000 msec: 1 to 1000 second: 1 to 6,10,15,30 minute: 1 to 6,10,15,30 hour: 1 to 6,12,24	Set the unit value for the time scale. The values in the setting range vary according to the specified unit for the time scale.
	Time Scale Unit Type	Sampling Times, msec, second, minute, hour	Set the unit type for the time scale.
Y-axis Setting	No. of Displayed Grids	10 to 999	Set the number of displayed grids in the Y-axis direction of the chart display part.
	No. of Whole Grids	10 to 100000	Set the number of displayed grids in the Y-axis direction of the whole chart.
Color Setting	Background Color	—	Set the background color of the areas other than the chart display part.
	Chart Background Color	—	Set the background color in the chart display part.
	Grid Color	—	Set the color of grid lines.
	X-axis Scale Color	—	Set the color of the X-axis scale.
	Cursor A Color	—	Set the color of the cursor A.
	Cursor B Color	—	Set the color of the cursor B.

Item	Range	Description
Trigger Color	—	Set the color of the trigger cursor.
Message Character Color	—	Set the color of messages displayed in the chart area.
Initialize (Black) button	—	Initializes the colors of the chart and cursors to the colors based on black.
Initialize (White) button	—	Initializes the colors of the chart and cursors to the colors based on white.

■ Display Setting (Device tab)

Make the display setting of devices used for the time chart.

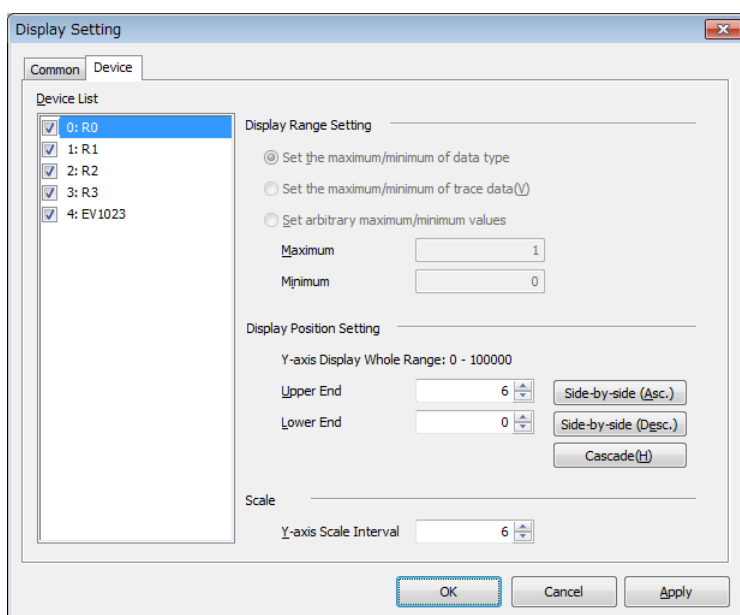

Item	Range	Description
Device List	-	Registered devices are listed. Check the check box of a device for which the setting is made.
Display Range Setting	Set the maximum/minimum of data type	Set the maximum and minimum values of the data type of the selected device.
	Set the maximum/minimum of trace data	Set the maximum and minimum values of trace data of the selected device.
	Set arbitrary maximum/minimum values	Maximum and minimum values are set by a user.

5.3 Trace Monitor (Time Chart)

Item	Range	Description	
Display Position Setting	Y-axis Display Whole Range:	-	The whole range of the displayed grids of Y axis is displayed.
	Upper End	1 to 99999	Set the upper end of the display position of the selected device.
	Lower End	0 to 99998	Set the lower end of the display position of the selected device.
	Side-by-side (Asc.)	-	All checked devices are displayed side by side in ascending order from the base line.
	Side-by-side (Desc.)	-	All checked devices are displayed side by side in descending order from the base line.
	Cascade	-	All checked devices are displayed in cascading view.
Scale	Y-axis Scale Interval	1-Upper end of display position-Lower end	The interval to display the scale next to the Y axis of the selected device is set. When the upper and lower ends of the display position are smaller than the Y-axis scale interval, this set value also becomes smaller.

5.3.4 Register Device

■ Register Device

Register a device displayed on the chart. Select "Set" > "Register Device" in the menu bar to display the setting screen. It can also be displayed by double-clicking a line of the device list.

Item	Setting range	Settings
Device type	X, Y, R, L, T, C	Select a device type.
	WX, WY, WR, WL, DT, LD, I, SV, EV	
No.	Device no.	Specify a device number. The settable range varies according to the selected device type.
Data type	Bit data	Select a data type (display format) of the device.
	Unsigned 16-bit integer	
	Signed 16-bit integer Unsigned 32-bit integer	

Item		Setting range	Settings
		Signed 32-bit integer Single-precision real HEX (1 word) HEX (2 words) Character string String (with 1 word header) String (with 2 words header)	
Decimal point position		0 to 11	The position of decimal point can be set when an integer type is selected for Data type. The settable range varies according to the selected data type.
No. of continuous registrations		1 to max. 128	Input a number for specifying the same type of devices all at once. The settable range varies according to the number of selected devices.
Comment registration	Data name	Within 16 characters	Set a data name.
	Arbitrary application	Within 8 characters	Set an arbitrary application.
	Unit	Within 8 characters	Set a unit.

5.3.5 Sampling Condition Setting

■ Sampling condition setting

Set the sampling condition. Select "Set" > "Sampling Configurations" in the menu bar to display the setting screen.

Sampling Configurations

Mode:

Trace Start Condition: _____

Auto (Starts when PLC is in RUN mode)
 Manual (Starts trace from menu)

Data Logging Condition: _____

Logging Trigger:

Trace Stop Condition: _____

Stop Trigger:

No. of samplings after stop trigger detection:
 (0 - 65536)

Write file after completion of trace

File Name:

5.3 Trace Monitor (Time Chart)

Item	Setting range	Settings
Mode	Trace/Free run	Set a sampling mode.
Trace Start Condition	Auto (Starts when PLC is in RUN mode)	The trace start condition is automatically set. The trace operation starts automatically when the PLC enters RUN mode.
	Manual (Starts trace from menu)	The trace start condition is manually set. The trace operation starts when the trace start button on the time chart monitor is pressed.
Data logging condition	Logging trigger	Select a condition to start logging data.
	Bit	Select this for setting bit conditions as logging trigger. Press the [Set] button, and select a device type and a number.
	Cycle	Select this for setting time as logging trigger. Input a cycle for executing logging. 1 second, 2 seconds, 3 seconds, 4 seconds, 5 seconds, 6 seconds, 10 seconds, 15 seconds, 30 seconds, 1 minute, 2 minutes, 3 minutes, 4 minutes 5 minutes, 6 minutes, 10 minutes, 15 minutes, 30 minutes, 1 hour, 2 hours, 3 hours, 4 hours, 6 hours, 12 hours, 24 hours
	Instruction	Trigger conditions occur by executing the F422(LOGSMPL) instruction under arbitrary conditions in user programs.
Trace stop condition	Bit	Set the trigger condition to stop the trace operation.
	Buffer full	
No. of samplings after stop trigger detection	0-65536	Set the number of data to be sampled after the detection of the stop trigger.
Write file after completion of trace	ON/OFF	Set whether to write data to a file after the completion of the trace operation or not.
File name	Up to 32 characters can be set.	Set a file name in which logged data is stored.

■ Restrictions on Time Chart Monitor

The restrictions on the time chart are as follows.

- Although a maximum of 4 patterns of trace operation can be executed (in the case all LOGs are operated for trace application), only one LOG can be displayed on the time chart.
- A maximum of 128 devices can be registered for one LOG, however, there are restrictions on devices to be graphically displayed on the time chart.
 - For contacts: Depends on the resolution of a used display
 - For data: Up to 6 devices
- Time cannot be measured with the cursors (C, R) on graphs when the LOG displayed as a time chart is the data that was traced with logging triggers other than "Cycle".

6 Logging/Trace Troubleshooting

6.1 Operations When Errors Occur.....	6-2
6.1.1 Operation When Power Supply Turns Off.....	6-2
6.1.2 Operation When Errors Occur (Only When Selecting Logging for Application).....	6-2
6.1.3 Operations When Inserting/Removing SD Memory Card During Logging/Trace.....	6-3
6.2 Troubleshooting.....	6-4
6.2.1 Errors When Start/Stop Operation was Executed Using FPWIN GR7.....	6-4
6.2.2 Errors When Operation was Executed Using LOGST, LOGED or LOGSMPL Instruction.....	6-4
6.2.3 Error of Logging/Trace.....	6-5
6.2.4 Error When Copying Data in SD Memory Card.....	6-5

6.1 Operations When Errors Occur

6.1 Operations When Errors Occur

6.1.1 Operation When Power Supply Turns Off

■ Operation When Power Supply Turns Off

- While the logging/trace buffer logging/file writing is performed (R9179 is on), the power off flag during SD memory card access flag (R917F) turns on.
- The data stored in the buffer of the control unit will be discarded.



- In case of the middle of file writing, written data or files may be damaged, or the SD memory itself may not be read.

6.1.2 Operation When Errors Occur (Only When Selecting Logging for Application)

■ Operations when determined files with the same time data are created

State	Operation
When multiple data are logged in one second	Create an error file with the following file name, and exclude them from the target for generation management. File name (Date_Time_ERR).csv If the same file is created, discard the current file and continue the logging operation.
When time data was turned back	If detecting that time is turned back from the previous record in logging operation, it is regarded as a file determination trigger, and a file with the following file name is created and excluded from the target for generation management. File name (Date_Time_TIM).csv The logging operation continues.

■ Operations when reactivating the power supply

State	Operation
When a current file with 0 record exists	Newly create a current file based on the file definition.
When a current file with N records exists	Newly create a current file based on the file definition after determining the current file. The determined file name is "file name (date_time_POW).csv, and it is excluded from the target for generation management.

■ Operation when log data is zero and file determination is requested

The request for file determination is ignored.

■ Operation when the F422(LOGSMPL) instructions in main program and interrupt program are executed simultaneously

The F422(LOGSMPL) instruction in the interrupt program is not executed.

6.1.3 Operations When Inserting/Removing SD Memory Card During Logging/Trace

- **Operations when inserting/removing an SD memory card**
 - If the cover is opened during the execution of logging/trace, all open files are closed and access stops after the completion of active file access.
 - Once the access stops, the SD memory card access LED turns off, and the SD memory card can be removed.
 - As the logging into the buffer memory in the control unit continues even after removing the SD memory card, pay attention to buffer overflow.
 - A file in the middle of logging when the cover was opened is saved as "specified file name (-----current-----).csv". Once the SD memory card is inserted again, writing into the file in the SD memory card restarts adding data to the "specified file name (-----current-----).csv".

6.2 Troubleshooting

6.2 Troubleshooting

6.2.1 Errors When Start/Stop Operation was Executed Using FPCWIN GR7

This section describes the messages displayed when the start or stop operation is performed on the "Logging/Trace Monitor" dialog box, and countermeasures.

■ List of error messages

Error message	Situation	Countermeasures
60 From PLC : Application error - Parameter error	Any box of LOG number is not checked.	Check the box of the LOG number to be started.
62 From PLC: Application error - Registration error	An unregistered LOG number was activated.	Check if the settings matches the LOG number to be activated.
78 From PLC: Application error - No SD error	No SD memory card is inserted, or the battery cover is open.	Check if an SD memory card is inserted, and close the battery cover.
90 From PLC: Application error - Logging error	An attempt was made to download logging setting parameters during logging operation.	Depending on the situation, wait for the completion of logging operation, or download the setting parameters again after performing the logging stop operation.
	An attempt was made to display data on a time chart during trace operation.	Depending on the situation, wait for the completion of trace operation, or press the [Time Chart] button after performing the trace stop operation.

6.2.2 Errors When Operation was Executed Using LOGST, LOGED or LOGSMPL Instruction

This section describes the situations and countermeasures when logging operation starts or stops, or logging trigger operation is performed with instructions in user programs.

■ List of errors

Situation or Error message	Situation	Countermeasures
ERR/ALM LED Flashes	A self-diagnostic error such as an operation error occurs.	When an operation error occurs in the address of LOGST, LOGED, or LOGSMPL instruction, check the followings.
An operation error occurred in the address of LOGST or LOGED instruction.	The instruction might have been executed for an unregistered LOG number.	Check if the settings match the LOG number for which the instruction is executed.
	There is a possibility that no SD memory card is inserted, or the battery cover is open.	Check if an SD memory card is inserted, and close the battery cover.

Situation or Error message	Situation	Countermeasures
An operation error occurred in the address of LOGSMPL instruction.	The instruction was executed for the LOG number the logging trigger of which is not set to "Instruction".	Check if the settings of logging trigger match the LOG number for which the instruction is executed.
Logging/Trace operation is not executed with LOGSMPL instruction.	There is a possibility that the LOG number does not match.	Check if the settings match the LOG number for which the instruction is executed.

6.2.3 Error of Logging/Trace

Other assumed situation and countermeasure are as follows.

■ List of errors

Situation or Error message	Situation	Countermeasures
Logging/trace starts or is complete right after the execution.	Autostart might be set.	Set Autostart to "No" in the logging/trace setting menu.

6.2.4 Error When Copying Data in SD Memory Card

Other assumed situation and countermeasure are as follows.

■ List of errors

Error message	Situation	Countermeasures
43 From PLC : Copy failed.	Data in an SD memory card cannot be copied into the control unit.	Create an "AUTO" folder in the SD memory card. Check if the setting file is saved in the SD memory card.

(MEMO)

7 Sampling Trace Function

7.1 Operation of Sampling Trace Function	7-2
7.2 Details of Sampling Trace Function	7-3
7.3 How to Use Sampling Trace	7-4
7.3.1 Sampling by free run	7-4
7.3.2 Sampling at regular time intervals	7-4
7.3.3 Sampling by instruction	7-5

7.1 Operation of Sampling Trace Function

7.1 Operation of Sampling Trace Function

■ What is Sampling Trace Function?

- Using the sampling trace function makes it possible to take samplings, record, and collect the state of arbitrary 16 bits + 3 words data registered in the PLC unit at arbitrary timing and to analyze changes in the bits and data in detail after stopping sampling at arbitrary timing.
- The sampling trace function is used in the time chart monitor function under the online menu of FPWIN GR7.
- The logging/trace function and sampling trace function cannot be used simultaneously. Either one of them can be used.

■ Instructions, special relays and special registers used for Sampling trace function

Number	Name	Operation
F155(SMPL)	Sampling instruction	Performs sampling of set data.
F156(STRG)	Sampling stop trigger instruction	Stops sampling.
R902C	Sample point flag	Sampling by instruction=0, Sampling at regular time intervals=1
R902D	Sampling trace end flag	When sampling trace starts=0 stops=1
R902E	Sampling stop trigger flag	Turns on when sampling stop trigger is on.
R902F	Sampling enable flag	Turns on when sampling operation starts.
DT90028	Interval of sampling trace	K0: Sampling by SMPL instruction K1 to K3000: (10 ms to 30 seconds) For sampling at regular time intervals

7.2 Details of Sampling Trace Function

■ No. of data collectable at one sampling

16 bits + 3 words

■ Sampling capacity

1000 samples

■ Types of sampling timing

1. Sampling at regular time intervals (sampling interval: 10 to 30,000 ms)
2. Sampling by F155(SMPL) instruction
 - Sampling for every scan can be executed by the instruction. Also, more than one samplings can be executed in one scan.
 - Timing for the execution of the F155 (SMPL) instruction can be set by the ladder sequence.
 - It is not possible to activate the sampling at regular time intervals and the sampling by the F155(SMPL) instruction simultaneously.

■ How to stop sampling

The following two methods are available for the stop trigger (request):

1. Deactivate request by the tool software
2. Deactivate request by the F156 (STRG) instruction
 - If the stop trigger is activated, the PLC will continue sampling by the specified number of delays and then stop the sampling operation.
 - Once the sampling operation stops, the data will be automatically retrieved by the tool software and will be indicated in a time chart.
 - The number of samplings before and after the trigger point can be adjusted by the number of delays. For the initial settings (number of samplings: 1,000, number of delays: 100), the respective numbers of samplings before and after the trigger point are 900 and 100.

■ Operation image of sampling trace

Performs the trace operation for the number of samples specified in Sampling Configuration.

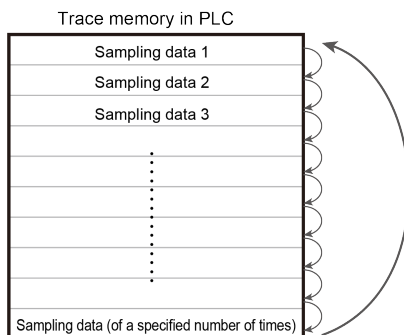

7.3 How to Use Sampling Trace

7.3 How to Use Sampling Trace

7.3.1 Sampling by free run

1 2 Procedure

1. Select **Tools>Time Chart** from the menu bar of FPWIN GR7.
2. Select "Sampling trace mode".

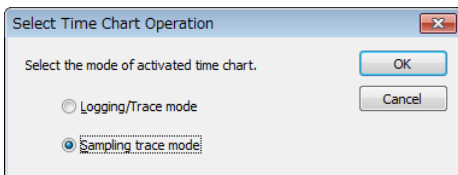

The time chart monitor screen appears.

3. Select **Set>Register Device** to register a bit/word device monitored.
4. Select **Set>Sampling Configurations**.
5. Set "Mode" to "Free run", and set "Sampling Times" and "Sampling Rate".

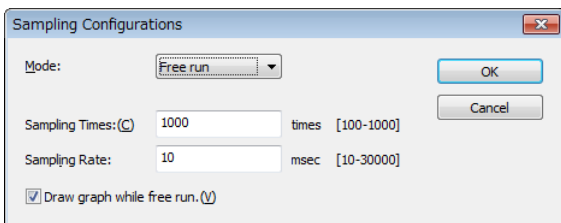

6. Press the [Start Trace/Free run] button.
Drawing a chart starts, and sampling data for the specified number of samples is performed.
7. Press the [Stop Trace/Free run] button to stop the trace.

7.3.2 Sampling at regular time intervals

1 2 Procedure

1. Select **Tools>Time Chart** from the menu bar of FPWIN GR7.
2. Select "Sampling trace mode".

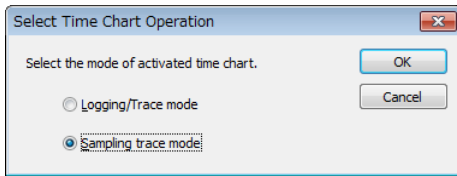

The time chart monitor screen appears.

3. Select **Set>Register Device** to register a bit/word device monitored.
4. Select **Set>Sampling Configuration**.
5. Set "Mode" to "Trace", and set "Sampling Times" and "Sampling Rate".

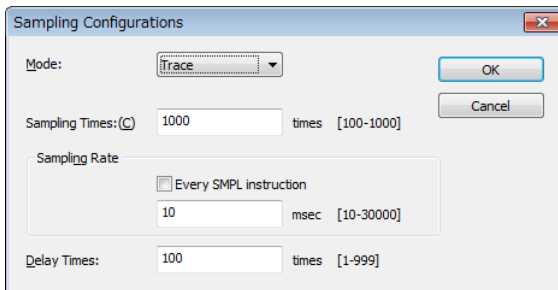

6. Press the "Start Trace/Free run" button.

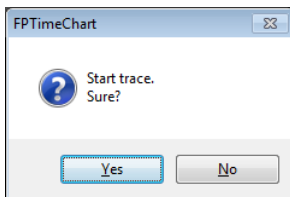

7. A message box appears. Select "Yes".
The trace operation begins.
8. Press the [Stop Trace/Free Run] button.
The time chart will be displayed after stopping the trace operation.

7.3.3 Sampling by instruction

1 2 Procedure

1. Select **"Tools">"Time Chart"** from the menu bar of FPWIN GR7.
2. Select "Sampling trace mode".
The time chart monitor screen appears.
3. Select **"Set">"Register Device"** to register a bit/word device monitored.
4. Set "Mode" to "Trace", and set "Sampling Rate".

7.3 How to Use Sampling Trace

5. Check the check box of "Every SMPL instruction".

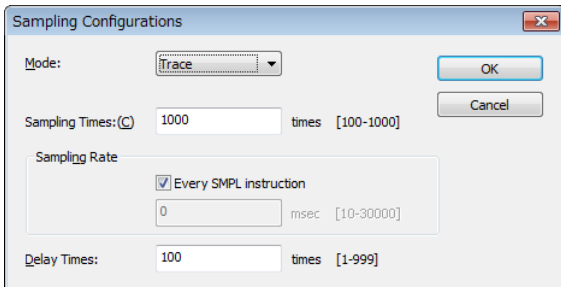

The sampling rate is automatically set to 0.

6. Press the "Start Trace/Free run" button.
7. A message box appears. Select "Yes".

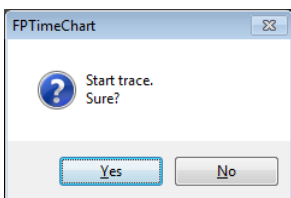

The trace operation begins.

8. Press the [Stop Trace/Free Run] button.
The time chart will be displayed after stopping the trace operation.

Record of changes

Date	Manual No.	Record of Changes
Oct. 2017	WUME-FP0HLOG-01	1st Edition
Jun. 2018	WUME-FP0HLOG-02	2nd Edition Added the description of supported functions for the Added the descriptions of supported functions. <ul style="list-style-type: none"> Added the explanation of special data registers (DT90680-DT90687). Error correction
Mar. 2020	WUME-FP0HLOG-03	3rd Edition Changed the manual format. Corrected errors.
Mar. 2021	WUME-FP0HLOG-04	4th Edition Revised description due to discontinuation of the Panasonic SD memory cards and SDHC memory cards.
Dec. 2021	WUME-FP0HLOG-05	5th Edition Version upgrade of the FP0H firmware (Ver. 1.9) <ul style="list-style-type: none"> Added data type of the logging data. <ul style="list-style-type: none"> String (with 1 word header) String (with 2 words header)
Jul. 2023	WUME-FP0HLOG-06	6th Edition Added notes on using the loggingtrace function. "1.1.2 Precautions on Using This Function"
Apr. 2024	WUME-FP0HLOG-07	7th Edition Change in Corporate name

Order Placement Recommendations and Considerations

The Products and Specifications listed in this document are subject to change (including specifications, manufacturing facility and discontinuing the Products) as occasioned by the improvements of Products. Consequently, when you place orders for these Products, Panasonic Industry Co., Ltd. asks you to contact one of our customer service representatives and check that the details listed in the document are commensurate with the most up-to-date information.

[Safety precautions]

Panasonic Industry Co., Ltd. is consistently striving to improve quality and reliability. However, the fact remains that electrical components and devices generally cause failures at a given statistical probability. Furthermore, their durability varies with use environments or use conditions. In this respect, check for actual electrical components and devices under actual conditions before use. Continued usage in a state of degraded condition may cause the deteriorated insulation. Thus, it may result in abnormal heat, smoke or fire. Carry out safety design and periodic maintenance including redundancy design, design for fire spread prevention, and design for malfunction prevention so that no accidents resulting in injury or death, fire accidents, or social damage will be caused as a result of failure of the Products or ending life of the Products.

The Products are designed and manufactured for the industrial indoor environment use. Make sure standards, laws and regulations in case the Products are incorporated to machinery, system, apparatus, and so forth. With regard to the mentioned above, confirm the conformity of the Products by yourself.

Do not use the Products for the application which breakdown or malfunction of Products may cause damage to the body or property.

- i) usage intended to protect the body and ensure security of life
- ii) application which the performance degradation or quality problems, such as breakdown, of the Products may directly result in damage to the body or property

It is not allowed the use of Products by incorporating into machinery and systems indicated below because the conformity, performance, and quality of Products are not guaranteed under such usage.

- i) transport machinery (cars, trains, boats and ships, etc.)
- ii) control equipment for transportation
- iii) disaster-prevention equipment / security equipment
- iv) control equipment for electric power generation
- v) nuclear control system
- vi) aircraft equipment, aerospace equipment, and submarine repeater
- vii) burning appliances
- viii) military devices
- ix) medical devices (except for general controls)
- x) machinery and systems which especially require the high level of reliability and safety

[Acceptance inspection]

In connection with the Products you have purchased from us or with the Products delivered to your premises, please perform an acceptance inspection with all due speed and, in connection with the handling of our Products both before and during the acceptance inspection, please give full consideration to the control and preservation of our Products.

[Warranty period]

Unless otherwise stipulated by both parties, the warranty period of our Products is three years after the purchase by you or after their delivery to the location specified by you. The consumable items such as battery, relay, filter and other supplemental materials are excluded from the warranty.

[Scope of warranty]

In the event that Panasonic Industry Co., Ltd. confirms any failures or defects of the Products by reasons solely attributable to Panasonic Industry Co., Ltd. during the warranty period, Panasonic Industry Co., Ltd. shall supply the replacements of the Products, parts or replace and/or repair the defective portion by free of charge at the location where the Products were purchased or delivered to your premises as soon as possible.

However, the following failures and defects are not covered by warranty and we are not responsible for such failures and defects.

- (1) When the failure or defect was caused by a specification, standard, handling method, etc. which was specified by you.
- (2) When the failure or defect was caused after purchase or delivery to your premises by an alteration in construction, performance, specification, etc. which did not involve us.
- (3) When the failure or defect was caused by a phenomenon that could not be predicted by the technology at purchasing or contracted time.
- (4) When the use of our Products deviated from the scope of the conditions and environment set forth in the instruction manual and specifications.
- (5) When, after our Products were incorporated into your products or equipment for use, damage resulted which could have been avoided if your products or equipment had been equipped with the functions, construction, etc. the provision of which is accepted practice in the industry.
- (6) When the failure or defect was caused by a natural disaster or other force majeure.
- (7) When the equipment is damaged due to corrosion caused by corrosive gases etc. in the surroundings.

The above terms and conditions shall not cover any induced damages by the failure or defects of the Products, and not cover your production items which are produced or fabricated by using the Products. In any case, our responsibility for compensation is limited to the amount paid for the Products.

[Scope of service]

The cost of delivered Products does not include the cost of dispatching an engineer, etc. In case any such service is needed, contact our sales representative.

Panasonic Industry Co., Ltd.

(MEMO)

Panasonic Industry Co., Ltd.

1006, Oaza Kadoma, Kadoma-shi, Osaka 571-8506, Japan
<https://industry.panasonic.com/>

Please visit our website for inquiries and about our sales network.

© Panasonic Industry Co., Ltd. 2017-2024

April, 2024

WUME-FP0HLOG-07