

Programmable Controller

**FP0H Control Unit
Programming Manual**

(MEMO)

Introduction

Thank you for purchasing a Panasonic product. Before you use the product, please carefully read through the user's manual, and understand it in detail to use the product properly.

Types of Manuals

- There are different types of users manuals for the FP0H series. Please refer to a relevant manual for the unit and purpose of your use.
- The manuals can be downloaded on our website: <https://industry.panasonic.com/global/en/downloads/?tab=manual>.

Unit name or purpose of use	Manual name	Manual code
FP0H Control Unit	FP0H User's Manual (Basic)	WUME-FP0HBAS
	FP0H Programming Manual	WUME-FP0HPGR
	FP0H Programming Manual (SD Card Access Instructions)	WUME-FP0HSD
Positioning Function/PWM Output/High-speed Counter Function	FP0H User's Manual (Positioning/PWM Output/High-speed Counter)	WUME-FP0HPOS
Serial Communication Function	FP0H User's Manual (COM Communication)	WUME-FP0HCOM
Ethernet Communication Function	FP0H User's Manual (Ethernet Communication)	WUME-FP0HET
EtherNet/IP Communication Function	FP0H User's Manual (EtherNet/IP)	WUME-FP0HEIP
Logging trace function	FP0H User's Manual (Logging/Trace Function)	WUME-FP0HLOG
FP0H Extension (Communication) Cassette	FP0H User's Manual (COM Communication)	WUME-FP0HCOM
FP0H Positioning Unit	FP0H Positioning Unit User's Manual	WUME-FP0HPG
FP0H Positioning Unit RTEX	FP0H Positioning Unit RTEX User's Manual (FPWIN GR7)	WUME-FP0HRTEXGR7

(MEMO)

Table of Contents

1 List of Instruction Words	1-1
1.1 List of Basic Instruction Words.....	1-2
1.2 List of High-level Instructions.....	1-8
2 Sequence Basic Instructions	2-1
2.1 ST, ST/ and OT (Start, Start Not and Out).....	2-2
2.2 DST, DST/ (Direct start, direct start Not).....	2-4
2.3 DOT (direct out).....	2-7
2.4 / (Not).....	2-10
2.5 AN, AN/ (AND, AND Not).....	2-11
2.6 DAN, DAN/ (Direct AND, Direct AND NOT).....	2-13
2.7 OR, OR/ (OR, OR Not).....	2-16
2.8 DOR, DOR/ (Direct OR, Direct OR Not).....	2-18
2.9 ST \uparrow , ST \downarrow , AN \uparrow , AN \downarrow , OR \uparrow , OR \downarrow (Rise Detection, Fall Detection).....	2-21
2.10 ALT (Alternate Out).....	2-23
2.11 ANS (And Stack).....	2-25
2.12 ORS (OR Stack).....	2-27
2.13 PSHS, RDS, POPS (Push stack, Read stack, Pop stack).....	2-29
2.14 DF, DF/ (Rise Differential, Fall Differential).....	2-33
2.15 DFI [Rise Differential (initial execution type)].....	2-38
2.16 SET, RST (Set, Reset).....	2-40
2.17 DSET/DRST (Direct Set/Direct Reset).....	2-43
2.18 KP (Keep).....	2-47
2.19 DKP (Direct Keep).....	2-49
2.20 NOP.....	2-52
3 Basic Function Instructions	3-1
3.1 TML/TMR/TMX/TMY (0.001 s, 0.01 s, 0.1 s, 1 s On-delay Timer).....	3-2
3.2 F137 STMR (16-bit, 0.01 s On-delay Timer).....	3-9
3.3 F183 DSTM (32-bit, 0.01 s On-delay Timer).....	3-12
3.4 CT [Counter (Preset Subtraction Expression)].....	3-16
3.5 F118 UDC (Up/Down Counter).....	3-23
3.6 SR (Shift Register).....	3-26
3.7 F119 LRSR (Left/Right Shift Register).....	3-29
3.8 F182 FILTR (Time Literal Process).....	3-32
4 Control Instructions	4-1
4.1 MC/MCE (Master Control Relay / Master Control Relay End).....	4-2

4.2 JP/LBL (Jump/Label)	4-7
4.3 LOOP, LBL (Loop, Label).....	4-11
4.4 ED (End).....	4-15
4.5 CNDE (Conditional End).....	4-16
4.6 EJECT.....	4-18
5 Step ladder Instructions	5-1
5.1 SSTP, NSTL (NSTP), CSTP, STPE (Start Step, Next Step, Clear Step, Step End).....	5-2
5.2 SCLR (Clear Multiple Processes)	5-17
6 Subroutine Instructions	6-1
6.1 CALL/SUB/RET (Subroutine Call, Subroutine Entry, Subroutine Return).....	6-2
7 Interrupt Instructions.....	7-1
7.1 INT/IRET (Interrupt / Interrupt Return).....	7-2
7.2 ICTL (Interrupt Control).....	7-8
7.2.1 How to start the interrupt program when executing the high-speed counter match ON / match OFF instruction	7-15
8 Special Setting Instructions.....	8-1
8.1 SYS1 (Communication Condition Setting).....	8-2
8.2 SYS1 (Password setting).....	8-8
8.3 SYS1 (Interrupt setting)	8-10
8.4 SYS1 [PC (PLC) Link Time Setting].....	8-12
8.5 SYS1 (MEWTOCOL-COM response control).....	8-14
8.6 SYS1 (Change high-speed counter operation mode).....	8-16
8.7 SYS2 [System Register (No.40 to No.48, No.50 to 57) Change]	8-18
9 Compare Contact Instructions	9-1
9.1 ST=, ST <>, ST>, ST>=, ST<, ST<= [16-bit Data Comparison (Start)].....	9-2
9.2 AN=, AN<>, AN>, AN>=, AN<, AN<= [16-bit Data Comparison (AND)].....	9-4
9.3 OR= OR <> OR > OR >= OR < OR <= [16-bit Data Comparison (OR)]	9-6
9.4 STD=, STD<>, STD>, STD>=, STD<, STD<= [32-bit Data Comparison(start)]	9-8
9.5 AND=, AND<>, AND>, AND>=, AND<, AND<= [32-bit Data Comparison (AND)].....	9-10
9.6 ORD=, ORD<>, ORD>, ORD>=, ORD<, ORD<= [32-bit Data Comparison (OR)].....	9-12
9.7 STF=, STF<>, STF>, STF>=, STF< and STF<= [Floating point real number data comparison (start)].....	9-14

9.8 ANF=, ANF<>, ANF>, ANF>=, ANF<, ANF<= [Floating point real number data comparison (AND)]	9-16
9.9 ORF=, ORF<>, ORF>, ORF>=, ORF<, ORF<= [floating point real number data comparison (OR)]	9-18
10 Transfer Instructions	10-1
10.1 F0 MV (16-bit Data Transfer)	10-2
10.2 F0 MV (10 μ sec Ring Counter Read)	10-4
10.3 F1 DMV (32-bit Data Transfer)	10-5
10.4 F2 MV/ (16-bit Data Inversion and Transfer)	10-7
10.5 F3 DMV/ (32-bit Data Inversion and Transfer).....	10-9
10.6 F5 BTM (Bit Data Transfer).....	10-11
10.7 F6 DGT (Digit Data Transfer).....	10-16
10.8 F7 MV2 (Two 16-bit Data Transfer to Single Area).....	10-20
10.9 F8 DMV2 (32-bit 2 Data Transfer)	10-22
10.10 F10 BKMV (Data Block Transfer)	10-24
10.11 F11 COPY (16-bit Data Block Copy).....	10-27
10.12 F12 ICRD (Data Read from F-ROM)	10-29
10.13 P13 ICWT (Writing to F-ROM).....	10-31
10.14 F15 XCH (16-bit Data Exchange)	10-33
10.15 F16 DXCH (32-bit Data Exchange).....	10-35
10.16 F17 SWAP (Higher/Lower Byte Exchange)	10-37
10.17 F18 BXCH (Block Exchange).....	10-39
10.18 F190 MV3 (Three 16-bit Data Transfer to Single Area).....	10-41
10.19 F191 DMV3 (32-Bit 3-Data Batch Transfer).....	10-43
11 Binary Arithmetic Instructions.....	11-1
11.1 F20 + (16-bit Data Addition [D+S=D])	11-2
11.2 F21 D+ (32-bit Data Addition [D+S=D])	11-4
11.3 F22 + (16-bit Data Addition [S1+S2=D])	11-6
11.4 F23 D+ (32-bit Data Addition [S1+S2=D]).....	11-8
11.5 F25 - (16-bit Data Subtraction [D-S=D]).....	11-10
11.6 F26 D-(32-bit Data Subtraction [D-S=D]).....	11-13
11.7 F27 - (16-bit Data Subtraction [S1-S2=D]).....	11-15
11.8 F28 D- (32-bit Data Subtraction [S1-S2=D])	11-18
11.9 F30 * (16-bit Data Multiplication [S1*S2=D+1, D])	11-20
11.10 F31 D* (32-bit Data Multiplication [S1*S2=D+3, D+2, D+1, D]	11-22
11.11 F32 % (16-bit Data Subtraction [S1/S2=D])	11-24
11.12 F33 D% (32-bit Data Subtraction [S1/S2=D+1, D]).....	11-26
11.13 F34 *W (16-bit Data Multiplication [S1*S2=D])	11-28
11.14 F35 +1 (16-bit Data Increment).....	11-30

11.15	F36 D+1 (32-bit Data Increment)	11-32
11.16	F37 -1 (16-bit Data Decrement)	11-34
11.17	F38 D-1 (32-bit Data Decrement)	11-36
11.18	F39 D*D (32-bit Data Multiplication [S1*S2=D+1, D])	11-38
12	BCD Data Arithmetic Instructions	12-1
12.1	F40 B+ (4-digit BCD Data Addition [D+S=D])	12-2
12.2	F41 DB+ (8-digit BCD Data Addition [D+S=D])	12-4
12.3	F42 B+ (4-digit BCD Data Addition [S1+S2=D])	12-6
12.4	F43 DB+ (8-digit BCD Data Addition [S1+S2=D])	12-8
12.5	F45 B- (4-digit BCD Data Subtraction [D-S=D])	12-10
12.6	F46 DB- (8-digit BCD Data Subtraction [D-S=D])	12-12
12.7	F47 B- (4-digit BCD Data Subtraction [S1-S2=D])	12-14
12.8	F48 DB- (8-digit BCD Data Subtraction [S1-S2=D])	12-16
12.9	F50 B* (4-digit BCD Data Multiplication [S1*S2=D+1, D])	12-18
12.10	F51 DB* (8-Digit BCD Data Multiplication [S1*S2=D+3, D+2, D+1, D])	12-20
12.11	F52 B% (4-digit BCD Data Subtraction [S1/S2=D])	12-22
12.12	F53 DB% (8-digit BCD Data Subtraction [S1/S2=D+1, D])	12-24
12.13	F55 B+1 (4-digit BCD Data Increment)	12-26
12.14	F56 DB+1 (8-digit BCD Data Increment)	12-28
12.15	F57 B-1 (4-digit BCD Data Decrement)	12-30
12.16	F58 DB-1 (8-digit BCD Data Decrement)	12-32
13	Data Comparison Instructions	13-1
13.1	F60 CMP (16-bit Data Comparison)	13-2
13.2	F61 DCMP (32-bit Data Comparison)	13-8
13.3	F62 WIN (16-bit Data Band Comparison)	13-12
13.4	F63 DWIN (32-bit Data Band Comparison)	13-14
13.5	F64 BCMP (Block Data Comparison)	13-16
13.6	F373 DTR (16-bit Data Change Detection)	13-19
13.7	F374 DDTR (32-bit Data Change Detection)	13-21
14	Boolean Instructions	14-1
14.1	F65 WAN (16-bit Data AND)	14-2
14.2	F66 WOR (16-bit Data OR)	14-4
14.3	F67 XOR (16-bit Data Exclusive OR)	14-6
14.4	F68 XNR (16-bit Data Exclusive NOR)	14-8
14.5	F69 WUNI [(S1 AND S3) OR (S2 AND S3) = D] (16-bit)	14-10
14.6	F215 DAND (32-bit Data AND)	14-12
14.7	F216 DOR (32-bit Data OR)	14-14

14.8	F217 DXOR (32-bit Data Exclusive OR).....	14-16
14.9	F218 DXNR (32-bit Data Exclusive NOR)	14-18
14.10	F219 DUNI [(S1 AND S3) OR (S2 AND S3) = D] (32-bit).....	14-20

15 Data Conversion Instructions 15-1

15.1	F70 BCC [Block Check Code (ADD, SUB, XOR, CRC)].....	15-3
15.2	F71 HEXA (Hexadecimal Data to ASCII Code Conversion).....	15-7
15.3	F72 AHEX (ASCII Code to Hexadecimal Data Conversion).....	15-10
15.4	F73 BCDA (BCD Data to ASCII Code Conversion).....	15-14
15.5	F74 ABCD (ASCII Code to BCD Data Conversion).....	15-18
15.6	F75 BINA (16-bit Binary Data to ASCII Code Conversion).....	15-22
15.7	F76 ABIN (ASCII Code to 16-bit Binary Data Conversion).....	15-25
15.8	F77 DBIA (32-bit Binary Data to ASCII Code Conversion).....	15-29
15.9	F78 DABI (ASCII Code to 32-bit Binary Data Conversion).....	15-32
15.10	F80 BCD (16-bit Binary Data to BCD Data Conversion).....	15-36
15.11	F81 BIN (BCD Data to 16-bit Binary Data Conversion)	15-38
15.12	F82 DBCD (32-bit Binary Data to BCD Data Conversion).....	15-40
15.13	F83 DBIN (BCD Data to 32-bit Binary Data Conversion).....	15-41
15.14	F84 INV (16-bit Data Invert).....	15-42
15.15	F85 NEG (16-bit Data Sign Inversion)	15-43
15.16	F86 DNEG (32-bit Data Sign Inversion).....	15-44
15.17	F87 ABS (Absolute Value of 16-bit Data).....	15-46
15.18	F88 DABS (Absolute Value of 32-bit Data).....	15-47
15.19	F89 EXT (Sign Extension)	15-48
15.20	F90 DECO (Decode).....	15-50
15.21	F91 SEGT (7-segment).....	15-53
15.22	F92 ENCO (Encode).....	15-55
15.23	F93 UNIT (Digit Combine)	15-58
15.24	F94 DIST (Digit Distribute).....	15-60
15.25	F96 SRC (16-bit Data Search).....	15-62
15.26	F97 DSRC (32-bit Data Search)	15-64
15.27	F230 TMSEC (Time data to second conversion).....	15-66
15.28	F231 SECTM (Second to Time Data Conversion).....	15-69
15.29	F235 GRY (16-bit Data to Gray Code Conversion)	15-72
15.30	F236 DGRY (32-bit Data to Gray Code Conversion).....	15-73
15.31	F237 GBIN (Gray Code to 16-bit Data Conversion)	15-74
15.32	F238 DGBIN (Gray Code to 32-bit Data Conversion).....	15-75
15.33	F240 COLM (Bit Line to Bit Column Conversion)	15-77
15.34	F241 LINE (Bit Column to Bit Line Conversion)	15-79

16 Data Shift Instruction.....	16-1
16.1 F100 SHR (16-bit Data Right Shift).....	16-2
16.2 F101 SHL (16-bit Data Left Shift).....	16-4
16.3 F102 DSHR (32-bit Data Right Shift).....	16-6
16.4 F103 DSHL (32-bit Data Left Shift).....	16-8
16.5 F105 BSR (16-bit Data 1-Digit Right Shift).....	16-10
16.6 F106 BSL (16-bit Data 1-Digit Left Shift).....	16-12
16.7 F108 BITR (Block Area Bitwise Right Shift).....	16-14
16.8 F109 BITL (Block Area Bitwise Left Shift).....	16-16
16.9 F110 WSHR (Block Area 1 Word Right Shift).....	16-18
16.10 F111 WSHL (Block Area 1 Word Left Shift).....	16-20
16.11 F112 WBSR (Block Area 1 Digit Right Shift).....	16-22
16.12 F113 WBSL (Block Area 1 Digit Left Shift).....	16-24
17 Data Rotation Instructions	17-1
17.1 F120 ROR (16-Bit Data Rotation to the Right).....	17-2
17.2 F121 ROL (16-Bit Data Rotation to the Left).....	17-4
17.3 F122 RCR (16-bit Data Right Rotation with Carry).....	17-6
17.4 F123 RCL (16-bit Data Left Rotation with Carry).....	17-8
17.5 F125 DROR [32-Bit Data Right Rotation].....	17-10
17.6 F126 DROL (32-bit data left rotation).....	17-12
17.7 F127 DROR (32-bit Data Right Rotation with Carry).....	17-14
17.8 F128 DRCL (32-bit Data Left Rotation with Carry).....	17-16
18 Data Buffer Instruction	18-1
18.1 F98 CMPR (Compress Shift Read).....	18-2
18.2 F99 CMPW (Compress Shift Write).....	18-6
18.3 How to Use the FIFO (First-in First-out) Buffer.....	18-10
18.4 F115 FIFT (FIFO Buffer Definition).....	18-11
18.5 F116 FIFR (FIFO Data Read).....	18-14
18.6 F117 FIFW (FIFO Data Write).....	18-18
19 Bit Manipulation Instructions	19-1
19.1 F130 BTS (Specified Bit Set).....	19-2
19.2 F131 BTR (Specified Bit Reset).....	19-4
19.3 F132 BTI (Specified Bit Inversion).....	19-6
19.4 F133 BTT (Specified Bit Test).....	19-8
19.5 F135 BCU (Count ON Bits in 16-bit Data).....	19-10
19.6 F136 DBCU (Count ON Bits in 32-bit Data).....	19-12
20 Special Instructions	20-1

20.1 F138 HMSS (Hour, Minute, Second Data to Second Data Conversion).....	20-2
20.2 F139 SHMS (Second Data to Hour, Minute, Second Data Conversion).....	20-4
20.3 F140 STC (Cy Flag Set)	20-6
20.4 F141 CLC (Cy Flag Clear)	20-7
20.5 F143 IORF (Partial I/O refresh).....	20-8
20.6 F147 PR (Printout)	20-9
20.7 F148 ERR (Self-Diagnostic Error Set)	20-14
20.8 F149 MSG (Character Send to Programming Tool).....	20-16
20.9 F150 READ (Shared Memory Read)	20-17
20.10 F151 WRT (Write to Shared Memory)	20-20
20.11 F157 CADD (Calendar Data Addition)	20-23
20.12 F158 CSUB (Calendar Data Subtraction).....	20-26
20.13 F160 DSQR (32-bit Data Square Root)	20-31
21 Serial Communication Instructions	21-1
21.1 F145 SEND / F146 RECV Instructions: Common Items (Serial Communication).....	21-2
21.2 F145 SEND [MEWTOCOL Master Send (Serial Communication)]...]	21-4
21.3 F146 REC [MEWTOCOL Master Receiver (Serial Communication)].....	21-8
21.4 F145 SEND [MODBUS Master Send: Function Code Specification (Serial Communication)]	21-12
21.5 F146 RECV [MODBUS Master Receiver: Function Code Specification (Serial Communication)]	21-17
21.6 F145 SEND [MODBUS Master Send: No Function Code Specification (Serial Communication)]	21-22
21.7 F146 RECV [MODBUS Master Receiver: No Function Code Specification (Serial Communication)]	21-28
21.8 F159 MTRN [General-purpose Communication Instructions (Serial Communication)].....	21-36
22 Ethernet Communication Instructions.....	22-1
22.1 F145 SEND/F146 RECV Common Instruction Items (Ethernet Communication).....	22-2
22.2 F145 SEND [Data Send Instruction (MEWTOCOL Master)].....	22-4
22.3 F146 RECV [Data Receive Instruction (MEWTOCOL Master)]	22-7
22.4 F145 SEND [Data Send Instruction (MODBUS Master: Function Code Specification)]	22-10
22.5 F146 RECV [Data Receive Instruction (MODBUS Master: Function Code Specification)]	22-12
22.6 F145 SEND [Data Send Instruction (MODBUS Master: No Function Code Specification)]	22-14

22.7	F146 RECV [Data Receive Instruction (MODBUS Master: No Function Code Specification)]	22-17
22.8	F145 SEND [Data Send Instruction (MC Protocol Master)]	22-20
22.9	F146 RECV [Data Receive Instruction (MC Protocol Master)]	22-23
22.10	F159 MTRN (General-purpose Communication Instruction)	22-26
23	Sampling Trace Instructions	23-1
23.1	Sampling Trace	23-2
23.2	F155 SMPL (Sample Set Data)	23-3
23.3	F156 STRG (Sampling Stop Trigger).....	23-4
24	High-speed Counter / PWM Output Instructions	24-1
24.1	[F0 MV] High-speed Counter Control Instruction	24-2
24.2	F1 DMV (Pulse Output Elapsed Value Write/Read).....	24-4
24.3	[F165 CAM0] High-speed Counter Cam Control Instruction.....	24-5
24.4	[F166 HC1S] High-speed Counter Target Value Match ON Instruction [F167 HC1R] High-speed Counter Target Value Match OFF Instruction	24-10
24.5	[F173 PWMH] PWM Output Instruction (Frequency Specification) ..	24-12
24.6	[F173 PWMH] PWM Output Instruction (Control Code Specification)	24-14
25	Character String Instructions	25-1
25.1	F95 ASC (Character Constant to ASCII Code Conversion)	25-2
25.2	F250 BTOA (Multiple Binary Data to ASCII Data String Conversion).....	25-5
25.3	F251 ATOB (Multiple ASCII Data Strings to Binary Data Conversion).....	25-11
25.4	F252 ACHK (Multiple ASCII Data Strings ASCII Code Check).....	25-18
25.5	F253 SSET (Character Constant → ASCII Code Conversion: with Storage Area Size).....	25-20
25.6	F254 PRINT (Create Text)	25-24
25.6.1	F254 PRINT Instruction Conversion Form Table	25-32
25.7	Overview of String Instructions F257 SCMP to F265 SREP.....	25-37
25.8	F257 SCMP (Comparing Character Strings)	25-38
25.9	F258 SADD (Character String Addition)	25-40
25.10	F259 LEN (Character String Length)	25-42
25.11	F260 SSRC (Search for Character String).....	25-44
25.12	F261 RIGHT (Right Retrieve from Character String).....	25-46
25.13	F262 LEFT (Left Retrieve from Character String).....	25-48
25.14	F263 MIDR (Read from Any Position in Character String)	25-50
25.15	F264 MIDW (Write to Any Position in Character String).....	25-52
25.16	F265 SREP (Replace Character Strings)	25-54

26	Data Manipulation Instructions	26-1
26.1	F270 MAX (Search Maximum Value from 16-bit Data Block)	26-2
26.2	F271 DMAX (Search Maximum Value from 32-bit Data Block)	26-4
26.3	F272 MIN (Search Minimum Value from 16-bit Data Block)	26-6
26.4	F273 DMIN (Search Minimum Value from 32-bit Data Block)	26-8
26.5	F275 MEAN (16-bit Data Sum and Average)	26-10
26.6	F276 DMEAN (32-bit Data Sum and Average)	26-12
26.7	F277 SORT (16-bit Data Block Sort)	26-14
26.8	F278 DSORT (32-bit Data Block Sort)	26-16
26.9	F282 SCAL (16-bit Data Linearization)	26-18
26.10	F283 DSCAL (32-bit Data Linearization)	26-21
26.11	F284 RAMP (16-bit Data Ramp Output)	26-24
26.12	F285 LIMT (16-bit Data Upper and Lower Limit Control)	26-26
26.13	F286 DLIMIT (32-bit Data Upper and Lower Limit Control)	26-28
26.14	F287 BAND (16-bit Data Deadband Control)	26-30
26.15	F288 DBAND (32-bit Data Deadband Control)	26-32
26.16	F289 ZONE (16-bit Data Zone Control)	26-34
26.17	F290 DZONE (32-bit Data Zone Control)	26-36
27	Floating-point Instruction	27-1
27.1	F309 FMV (Floating Point Data Move)	27-3
27.2	F310 F+ (Floating Point Data Addition)	27-5
27.3	F311 F- (Floating Point Data Subtraction)	27-7
27.4	F312 F* (Floating Point Data Multiplication)	27-9
27.5	F313 F% (Floating Point Data Division)	27-11
27.6	F314 SIN (Floating Point Data Sine Operation)	27-13
27.7	F315 COS (Floating Point Data Cosine Operation)	27-15
27.8	F316 TAN (Floating Point Data Tangent Operation)	27-17
27.9	F317 ASIN (Floating Point Data Arcsine Operation)	27-19
27.10	F318 ACOS (Floating Point Data Arccosine Operation)	27-21
27.11	F319 ATAN (Floating Point Data Arctangent Operation)	27-23
27.12	F320 LN (Floating Point Data Natural Logarithmic Operation)	27-25
27.13	F321 EXP (Floating Point Data Exponent Operation)	27-27
27.14	F322 LOG (Floating Point Data Logarithm Operation)	27-29
27.15	F323 PWR (Floating Point Data Power Operation)	27-31
27.16	F324 FSQR (Floating Point Data Square Root Operation)	27-33
27.17	F325 FLT (16-bit Integer to Floating Point Data Conversion)	27-35
27.18	F326 DFLT (32-bit Integer to Floating Point Data Conversion)	27-36
27.19	F327 INT [Floating Point Data to 16-bit Integer Conversion (Largest Integer Not Exceeding the Floating-point Data)]	27-38

27.20	F328 DINT [Floating Point Data to 32-bit Integer Conversion (Largest Integer Not Exceeding the Floating-point Data)]	27-40
27.21	F329 FIX [Floating Point Data to 16-bit Integer Conversion (Round-down)]	27-42
27.22	F330 DFIX [Floating Point Data to 32-bit Integer Conversion (Round-down)]	27-44
27.23	F331 ROFF [Floating Point Data to 16-bit Integer Conversion (Round-off)]	27-46
27.24	F332 DROFF [Floating Point Data to 16-bit Integer Conversion (Round-off)]	27-48
27.25	F333 FINT (Floating Point Data Round-down)	27-50
27.26	F334 FRINT (Floating Point Data Round-off)	27-52
27.27	F335 F+/- (Floating Point Data Sign Conversion)	27-54
27.28	F336 FABS (Floating Point Data Absolute Value Conversion)	27-56
27.29	F337 RAD (Degree to Radian Conversion)	27-58
27.30	F338 DEG (Radian to Degree Conversion)	27-60
28	Real Number Data Processing Instructions	28-1
28.1	F345 FCMP (Floating Point Data Comparison)	28-2
28.2	F346 FWIN (Floating Point Data Band Comparison)	28-4
28.3	F347 FLIMIT (Floating Point Data Upper/Lower Limit Control)	28-6
28.4	F348 FBAND (Floating Point Data Deadband Control)	28-8
28.5	F349 FZONE (Floating Point Data Zone Control)	28-10
28.6	F354 FSCAL (Scaling of real number data)	28-12
29	Process Control Instructions	29-1
29.1	F355 PID (PID Operation)	29-2
29.2	F356 EZPID (PID Operation: PWM Output Possible)	29-9
30	Positioning Control Instructions (Table Setting Mode)	30-1
30.1	F380 POSST (Positioning Table Start)	30-2
30.2	F381 JOGST (JOG Operation Start)	30-4
30.3	F382 ORGST (Home Return Start)	30-6
30.4	F383 MPOST (Positioning Simultaneous Start)	30-7
30.5	F384 PTBLR (Positioning Parameter Read)	30-9
30.6	F385 PTBLW (Positioning Parameter Write)	30-11
31	Positioning Control Instructions	31-1
31.1	F1 DMV (Pulse Output Elapsed Value Write/Read)	31-2
31.2	[F171(SPDH)] Pulse Output (Trapezoidal Control)	31-3
31.3	[F171(SPDH)] Pulse Output (Home Return)	31-9
31.4	[F172(PSLH)] Pulse Output (JOG Operation)	31-14

31.5 [F174(SP0H)] Pulse Output (Selectable Data Table Control Operation)	31-17
31.6 [F175(SPSH)] Pulse Output (Linear Interpolation)	31-22
32 Logging/Trace Control Instruction	32-1
32.1 F420 LOGST (Logging trace start request)	32-2
32.2 F421 LOGED (Logging trace stop request)	32-3
32.3 F422 LOGSMPL (Sampling Trace).....	32-4
33 SD Card Access Instructions.....	33-1
33.1 Common Precautions for SD Memory Card Access Instructions	33-2
33.2 F425 CDTWT (File Write of Operation Memory in BIN Format)	33-6
33.3 F426 CDTRD (Read from BIN Format File to Operation Memory) ...	33-8
33.4 F427 CWT (File Data Write Instruction).....	33-10
33.5 F428 CRD (Read File Data).....	33-23
33.6 F429 CMKDIR (create directory)	33-32
33.7 F430 CRMDIR/F431 CRMDIRFL (Directory Deletion).....	33-35
33.8 F432 CFDEL (delete file)	33-39
33.9 F433 CPR (ASCII Data Write into File).....	33-41
33.10 F434 CRD1 (Read one line from file).....	33-44
33.11 F435 CREN (Rename File).....	33-50
33.12 F436 CCOPY (File Copy)	33-52
33.13 F437 CMV (File Transfer)	33-55
33.14 F438 CFREE (SD memory card free space acquisition: byte units)	33-58
33.15 F439 CFREEK (SD Memory Card Free Space Acquisition: Kilobyte Units).....	33-60
33.16 F440 CFLS (File status acquisition).....	33-62
33.17 F441 PanaSD (Read of lifetime information of Panasonic SD card).....	33-65
34 Ethernet Instructions	34-1
34.1 F460 IPv4SET (Ipv4 Address Setting).....	34-2
34.2 F461 CONSET (Connection Setting).....	34-7
34.3 F462 OPEN (Connection Open)	34-14
34.4 F463 CLOSE (Connection Close).....	34-16
34.5 F464 RDET (Ethernet Status Read)	34-18
34.6 F465 ETSTAT (EtherNet Information Acquisition)	34-21
34.7 P466 NTPcREQ (Time Adjustment Request).....	34-25
34.8 F467 NTPcSV (NTP Destination Server Setting).....	34-31
34.9 P468 PINGREQ (PING Send Request).....	34-36
34.10 F469 UNITSEL (Specify Communication Unit Slot Port)	34-40

35 EtherNet/IP Instructions	35-1
35.1 F465 ETSTAT (EtherNet/IP Information Acquisition)	35-2
35.2 F490 EIPNDST (EtherNet/IP node status acquisition instruction)	35-9
35.3 F495 EIPMSATT (EIP message destination settings)	35-13
35.4 F496 EIPMBODY (EIP message body setting).....	35-16
35.5 F497 EIPMSEND (EIP message sending).....	35-19
35.6 F498 CIPMSET [CIP message data generation (combination)]	35-23
35.7 F499 CIPMGET (data acquisition from CIP message)	35-28
35.8 CIP Status Codes	35-34
36 FTP Instructions.....	36-1
36.1 F465 ETSTAT (Acquire Ethernet Unit Information: FTP)	36-2
36.2 F470 FTPcSV (FTP Client Connected Server Setting).....	36-8
36.3 F471 FTPcSET (FTP Client Transfer Setting)	36-14
36.4 F472 FTPcLOG (Logging / Trace Transfer Setting).....	36-22
36.5 F473 FTPcREQ (FTP Client Transfer Request)	36-25
36.6 F474 FTPcCTL (FTP Client Transfer Control)	36-29
37 Precautions for Programming	37-1
37.1 Changing the Set Value of Timer/Counter During RUN	37-2
37.1.1 How to Rewrite Constants in the Program	37-2
37.1.2 Methods Used to Rewrite a Value in the Set Value Area	37-2
37.2 Use of Duplicate Output.....	37-5
37.2.1 Duplicate Output	37-5
37.2.2 Processing When Output Is Duplicated with OT, KP, SET, and RST Instructions	37-5
37.3 Rise Detection Method.....	37-7
37.3.1 Rise Detection Instructions	37-7
37.3.2 Operation and Precautions at Run Start Time	37-8
37.3.3 Precautions When Using Control Instructions	37-10
37.4 Operation Errors	37-13
37.4.1 What is an operation error?	37-13
37.4.2 Operation Mode when an Operation Error Occurs	37-13
37.4.3 Handling the Occurrence of Operation Errors.....	37-14
37.4.4 Points to Review in Program.....	37-14
37.5 How to Use the Index Register	37-16
37.5.1 Index Registers	37-16
37.5.2 Index Modification Applicable Areas	37-16
37.5.3 Example of Using an Index Register.....	37-17
37.6 Handling BCD Data.....	37-19
37.7 Precautions for Programming	37-21
37.8 Rewrite Function During RUN.....	37-23
37.8.1 Operation of Rewrite During RUN.....	37-23
37.8.2 When Rewriting During RUN is not Possible	37-23
37.8.3 Method and Operation of Rewriting during RUN	37-25

37.9 Processing During Forced Input/Output	37-26
38 Reference Material	38-1
38.1 Operation Memory Area.....	38-3
38.2 List of System Registers	38-5
38.3 List of Special Relays.....	38-13
38.4 List of Special Data Registers.....	38-34
38.5 Allocation of Memory Areas	38-54
38.5.1 When Using Pulse Output Table Setting Mode	38-54
38.5.2 When Using Pulse Output Function (FPsigma Compatible Instruction Mode)	38-55
38.5.3 When Using PWM Output Function	38-56
38.5.4 When Using High-speed Counter Function	38-57
38.6 FPsigma Mode.....	38-59
38.6.1 Overview of FPsigma Mode	38-59
38.6.2 Converting Projects for FPsigma to Projects for FP0H (FPsigma Mode).....	38-60
38.6.3 Converting Projects for FP0H (FPsigma Mode) to Projects for FP0H (FP0H Mode)	38-61
38.6.4 Differences in Positioning Instructions with FPsigma.....	38-62
38.7 Positioning Memory	38-68
38.7.1 Configuration of Memory Map.....	38-68
38.7.2 Common area (Memory Area No. 0).....	38-69
38.7.3 Axis Information Area (Memory Area No. 1).....	38-70
38.7.4 Axis Setting Area (Memory Area No. 2).....	38-71
38.7.5 Positioning Table Area (Memory Area No. 3).....	38-73
38.8 Configuration Concerning Open Processing	38-75
38.8.1 IP Address Setting Specification	38-75
38.9 FTP File Transfer Settings	38-77
38.9.1 Basic Setup.....	38-77
38.9.2 Overwrite Method and Rename Method	38-79
38.9.3 FTP File Transfer Settings (Sending Files)	38-79
38.9.4 FTP File Transfer Settings (Getting Files).....	38-81
38.9.5 FTP File Transfer Settings (Sending Files)	38-83
38.9.6 FTP File Transfer Settings (Getting Device)	38-85
38.10 How to Set Logging / Trace Transfer	38-88
38.10.1 Basic Setup.....	38-88
38.10.2 Logging / Trace Transfer Settings	38-88
38.11 Communication Commands.....	38-90
38.11.1 List of MEWTOCOL Supported Commands.....	38-90
38.11.2 List of MODBUS Supported Commands	38-91
38.11.3 MC Protocol Communication Commands	38-94
38.12 Error code	38-96
38.12.1 List of Syntax Check Errors	38-96
38.12.2 Self-diagnostic Errors.....	38-97
38.12.3 List of MEWTOCOL-COM/DAT Communication Error Codes	38-99
38.12.4 List of MODBUS Communication Error Codes	38-100
38.12.5 List of MC Protocol Communication Error Codes	38-100
38.12.6 List of Ethernet Communication Error Codes	38-101

38.13 BIN/HEX/BCD Code Correspondence Table38-103
38.14 ASCII Code Table, JIS8 Code Table38-104

1 List of Instruction Words

1.1 List of Basic Instruction Words.....	1-2
1.2 List of High-level Instructions.....	1-8

1.1 List of Basic Instruction Words

1.1 List of Basic Instruction Words

■ Sequence basic instructions

Mnemonic	Name	Steps	Reference page:
ST	Begins a logic operation with a Form A (normally open) contact ^(Note 1)	1 (2)	"P.2-2"
DST	Begins a logic operation with a Form A (normally open) contact: Direct input ^(Note 1)	2	"P.2-4"
ST/	Begins a logic operation with a Form B (normally closed) contact ^(Note 1)	1 (2)	"P.2-2"
DST/	Begins a logic operation with a Form B (normally closed) contact: Direct input ^(Note 1)	2	"P.2-4"
OT	Outputs the operation result ^(Note 1)	1 (2)	"P.2-2"
DOT	Outputs the operation result: Direct input ^(Note 1)	2	"P.2-7"
/	Inverts the operation result	1	"P.2-10"
AN	Connects a Form A (normally open) contact serially ^(Note 2)	1 (2)	"P.2-11"
DAN	Connects a Form A (normally open) contact serially: Direct input ^(Note 1)	2	"P.2-13"
AN/	Connects a Form B (normally closed) contact serially ^(Note 2)	1 (2)	"P.2-11"
DAN/	Connects a Form B (normally closed) contact serially: Direct input ^(Note 1)	2	"P.2-13"
OR	Connects a Form A (normally open) contact in parallel ^(Note 2)	1 (2)	"P.2-16"
DOR	Connects a Form A (normally open) contact in parallel: Direct input ^(Note 1)	2	"P.2-18"
OR/	Connects a Form B (normally closed) contact in parallel ^(Note 2)	1 (2)	"P.2-16"
DOR/	Connects a Form B (normally closed) contact in parallel: Direct input ^(Note 1)	2	"P.2-18"
ST↑	Begins a rise contact logic operation	2	"P.2-21"
ST↓	Begins fall contact logic operation	2	"P.2-21"
AN↑	Connects a contact serially when a rise is detected	2	"P.2-21"
AN↓	Connects a contact serially when a fall is detected	2	"P.2-21"
OR↑	Connects a contact in parallel when a rise is detected	2	"P.2-21"
OR↓	Connects a contact in parallel when a fall is detected	2	"P.2-21"
ALT	Alternate out	3	"P.2-23"
ANS	Connects multiple instruction blocks serially	1	"P.2-25"
ORS	Connects multiple instruction blocks in parallel	1	"P.2-27"
PSHS	Stores the operation result	1	"P.2-29"
RDS	Reads the operation result stored by PSHS	1	"P.2-29"

1.1 List of Basic Instruction Words

Mnemonic	Name	Steps	Reference page:
POPS	Reads and clears the operation result stored by PSHS	1	"P.2-29"
DF	Rise detection	1	"P.2-33"
DF/	Fall detection	1	"P.2-33"
DFI	Rise detection (possible on the first scan)	1	"P.2-38"
SET	Turns ON the output and holds it ON ^(Note 1)	3	"P.2-40"
DSET	Turns ON the output and holds it ON: Direct input ^(Note 1)	3	"P.2-43"
RST	Turns OFF the output and holds it OFF ^(Note 1)	3	"P.2-40"
DRST	Turns OFF the output and holds it OFF: Direct input ^(Note 1)	3	"P.2-43"
KP	Outputs with set and reset inputs	1	"P.2-47"
DKP	Outputs with set and reset inputs: Direct output	2	"P.2-49"
NOP	No operation	1	"P.2-52"

(Note 1) Indicates an instruction for which bit index modification is possible.

(Note 2) Numbers in parentheses in the Steps column indicate the number of steps when index modification is performed or when the device number is large (R1120 or higher, T256 or higher, and C256 or higher).

■ Basic function instructions

Mnemonic	Name	Steps	Reference page:
TML	On-delay timer set in 0.001-s units	3 (4)	"P.3-2"
TMR	On-delay timer set in 0.01-s units	3 (4)	"P.3-2"
TMX	On-delay timer set in 0.1-s units	3 (4)	"P.3-2"
TMY	On-delay timer set in 1-s units	4 (5)	"P.3-2"
F137 STMR	On-delay timer set to 0.01 s	5	"P.3-9"
F183 DSTM	32-bit on-delay timer set to 0.01 s	7	"P.3-12"
CT	Down counter	3 (4)	"P.3-16"
F118 UDC	Up/down counter	5	"P.3-23"
SR	Shift register	1	"P.3-26"
F119 LRSR	Left/right shift register	5	"P.3-29"
F182 FILTR	Time constant processing instruction S1, S2, S3, D	9	"P.3-32"

(Note 1) Numbers in parentheses in the Steps column indicate the number of steps when index modification is performed or when the device number is large (R1120 or higher, T256 or higher, and C256 or higher).

1.1 List of Basic Instruction Words

■ Control instructions

Mnemonic	Name	Steps	Reference page:
MC	Master control relay	2	"P.4-2"
MCE	Master control relay end	2	"P.4-2"
JP	Jumps to specified label	2	"P.4-7"
LOOP	Jumps to the specified label the number of times specified by D	4	"P.4-11"
LBL	Labels subject to the processing of instructions such as JP and LOOP	1	"P.4-7" "P.4-11"
ED	Main program area end	1	"P.4-15"
CNDE	Conditional program end	1	"P.4-16"
EJECT	Page break when printing	2	"P.4-18"

(Note 1) Numbers in parentheses in the Steps column indicate the number of steps when index modification is performed or when the device number is large (R1120 or higher, T256 or higher, and C256 or higher).

■ Step ladder instructions

Mnemonic	Name	Steps	Reference page:
SSTP	Process start	3	"P.5-2"
NSTL	Specified process start-up (every scan execution type)	3	"P.5-2"
NSTP	Specified process start-up (differential execution type)	3	"P.5-2"
CSTP	Clears the specified process	3	"P.5-2"
STPE	Step ladder area end	1	"P.5-2"
SCLR	Clears multiple processes	5	"P.5-17"

■ Subroutine instructions

Mnemonic	Name	Steps	Reference page:
CALL	Calls the specified subroutine	2	"P.6-2"
SUB	Subroutine definition	1 (2)	"P.6-2"
RET	Ends the subroutine program and returns to the main program	1	"P.6-2"

■ Interrupt instructions

Mnemonic	Name	Steps	Reference page:
INT	Interrupt program definition	1	"P.7-2"
IRET	Ends the interrupt program and returns to the main program	1	"P.7-2"

Mnemonic	Name	Steps	Reference page:
ICTL	Interrupt control specification	5	"P.7-8"

■ Program block control instructions

Mnemonic	Name	Steps	Reference page:
EDPB ^(Note 1)	Final point of PBN program	1	

(Note 1) Cannot be input with a programming tool.

■ Special setting instructions

Mnemonic	Name	Steps	Reference page:
SYS1	Communication conditions setting, end code time setting for setting communication conditions, password setting, interrupt setting, PLC link setting, MEWTOCOL-COM response control, high-speed counter operation mode change, direct station number setting, indirect station number setting, firmware version number read	13	"P.8-2" "P.8-8" "P.8-10" "P.8-12" "P.8-14" "P.8-16"
SYS2	System register change instruction	7	"P.8-18"

■ Compare contact instructions

Mnemonic	Name	Steps	Reference page:
ST=	Begins a logical operation to compare 16-bit data	5	"P.9-2"
ST<>	Begins a logical operation to compare 16-bit data	5	"P.9-2"
ST>	Begins a logical operation to compare 16-bit data	5	"P.9-2"
ST>=	Begins a logical operation to compare 16-bit data	5	"P.9-2"
ST<	Begins a logical operation to compare 16-bit data	5	"P.9-2"
ST<=	Begins a logical operation to compare 16-bit data	5	"P.9-2"
AN =	16-bit data compare serial connection	5	"P.9-4"
AN <>	16-bit data compare serial connection	5	"P.9-4"
AN >	16-bit data compare serial connection	5	"P.9-4"
AN >=	16-bit data compare serial connection	5	"P.9-4"
AN <	16-bit data compare serial connection	5	"P.9-4"
AN <=	16-bit data compare serial connection	5	"P.9-4"
OR=	16-bit data compare parallel connection	5	"P.9-6"
OR<>	16-bit data compare parallel connection	5	"P.9-6"

1.1 List of Basic Instruction Words

Mnemonic	Name	Steps	Reference page:
OR>	16-bit data compare parallel connection	5	"P.9-6"
OR>=	16-bit data compare parallel connection	5	"P.9-6"
OR<	16-bit data compare parallel connection	5	"P.9-6"
OR<=	16-bit data compare parallel connection	5	"P.9-6"
STD=	Begins a logical operation to compare 32-bit data	9	"P.9-8"
STD<>	Begins a logical operation to compare 32-bit data	9	"P.9-8"
STD>	Begins a logical operation to compare 32-bit data	9	"P.9-8"
STD>=	Begins a logical operation to compare 32-bit data	9	"P.9-8"
STD<	Begins a logical operation to compare 32-bit data	9	"P.9-8"
STD<=	Begins a logical operation to compare 32-bit data	9	"P.9-8"
AND=	32-bit data compare serial connection	9	"P.9-10"
AND<>	32-bit data compare serial connection	9	"P.9-10"
AND>	32-bit data compare serial connection	9	"P.9-10"
AND>=	32-bit data compare serial connection	9	"P.9-10"
AND<	32-bit data compare serial connection	9	"P.9-10"
AND<=	32-bit data compare serial connection	9	"P.9-10"
ORD=	32-bit data compare parallel connection	9	"P.9-12"
ORD<>	32-bit data compare parallel connection	9	"P.9-12"
ORD>	32-bit data compare parallel connection	9	"P.9-12"
ORD>=	32-bit data compare parallel connection	9	"P.9-12"
ORD<	32-bit data compare parallel connection	9	"P.9-12"
ORD<=	32-bit data compare parallel connection	9	"P.9-12"

■ Compare contact instructions

Mnemonic	Name	Steps	Reference page:
STF=	Begins a logical operation to compare single-precision floating point data	10	"P.9-14"
STF<>	Begins a logical operation to compare single-precision floating point data	10	"P.9-14"
STF>	Begins a logical operation to compare single-precision floating point data	10	"P.9-14"
STF>=	Begins a logical operation to compare single-precision floating point data	10	"P.9-14"
STF<	Begins a logical operation to compare single-precision floating point data	10	"P.9-14"
STF<=	Begins a logical operation to compare single-precision floating point data	10	"P.9-14"

1.1 List of Basic Instruction Words

Mnemonic	Name	Steps	Reference page:
ANF=	Single-precision floating point data compare serial connection	10	"P.9-16"
ANF<>	Single-precision floating point data compare serial connection	10	"P.9-16"
ANF>	Single-precision floating point data compare serial connection	10	"P.9-16"
ANF>=	Single-precision floating point data compare serial connection	10	"P.9-16"
ANF<	Single-precision floating point data compare serial connection	10	"P.9-16"
ANF<=	Single-precision floating point data compare serial connection	10	"P.9-16"
ORF=	Single-precision floating point data compare parallel connection	10	"P.9-18"
ORF<>	Single-precision floating point data compare parallel connection	10	"P.9-18"
ORF>	Single-precision floating point data compare parallel connection	10	"P.9-18"
ORF>=	Single-precision floating point data compare parallel connection	10	"P.9-18"
ORF<	Single-precision floating point data compare parallel connection	10	"P.9-18"
ORF<=	Single-precision floating point data compare parallel connection	10	"P.9-18"

1.2 List of High-level Instructions

1.2 List of High-level Instructions

■ Transfer instructions

Fun no.	Mnemonic	Operands	Name	Steps	Reference page:
F0	MV	S, D	16-bit data transfer	5	"P. 10-2"
F0	MV	DT90020, D	10 μ s ring counter read	5	"P. 10-4"
F1	DMV	S, D	32-bit data transfer	7	"P. 10-5"
F2	MV/	S, D	16-bit data invert and transfer	5	"P. 10-7"
F3	DMV/	S, D	32-bit data invert and transfer	7	"P. 10-9"
F5	BTM	S, n, D	Bit data transfer	7	"P. 10-11"
F6	DGT	S, n, D	Digit data transfer	7	"P. 10-16"
F7	MV2	S1, S2, D	Two 16-bit data transfer to single area	7	"P. 10-20"
F8	DMV2	S1, S2, D	Two 32-bit data transfer to single area	11	"P. 10-22"
F10	BKMV	S1, S2, D	Data block transfer	7	"P. 10-24"
F11	COPY	S, D1, D2	16-bit data block copy	7	"P. 10-27"
F12	ICRD	S1, S2, D	F-ROM read	11	"P. 10-29"
P13	PICWT	S1, S2, D	Write to F-ROM	11	"P. 10-31"
F15	XCH	D1, D2	16-Bit data exchange	5	"P. 10-33"
F16	DXCH	D1, D2	32-bit data exchange	5	"P. 10-35"
F17	SWAP	D	High byte and low byte exchange	3	"P. 10-37"
F18	BXCH	D1, D2, D3	Data block exchange	7	"P. 10-39"
F190	MV3	S1, S2, S3, D	Three 16-bit data transfer to single area	10	"P. 10-41"
F191	DMV3	S1, S2, S3, D	Three 32-bit data transfer to single area	16	"P. 10-43"

■ Binary arithmetic instructions

Fun no.	Mnemonic	Operands	Name	Steps	Reference page:
F20	+	S, D	16-bit data addition [D+S=D]	5	"P. 11-2"
F21	D+	S, D	32-bit data addition [D+S=D]	7	"P. 11-4"
F22	+	S1, S2, D	16-bit data addition [S1+S2=D]	7	"P. 11-6"
F23	D+	S1, S2, D	32-bit data addition [S1+S2=D]	11	"P. 11-8"
F25	-	S, D	16-bit data subtraction [D-S=D]	5	"P. 11-10"
F26	D-	S, D	32-bit data subtraction [D-S=D]	7	"P. 11-13"
F27	-	S1, S2, D	16-bit data subtraction [S1-S2=D]	7	"P. 11-15"
F28	D-	S1, S2, D	32-bit data subtraction [S1-S2=D]	11	"P. 11-18"
F30	*	S1, S2, D	16-bit data multiplication [S1*S2=D+1, D]	7	"P. 11-20"
F31	D*	S1, S2, D	32-bit data multiplication [S1*S2=D+3, D+2, D+1, D]	11	"P. 11-22"
F32	%	S1, S2, D	16-bit data division [S1/S2=D]	7	"P. 11-24"
F33	D%	S1, S2, D	32-bit data division [S1/S2=D+1, D]	11	"P. 11-26"
F34	*W	S1, S2, D	16-bit data multiplication [S1*S2=D]	7	"P. 11-28"
F35	+1	D	16-bit data increment	3	"P. 11-30"
F36	D+1	D	32-bit data increment	3	"P. 11-32"
F37	-1	D	16-bit data decrement	3	"P. 11-34"
F38	D-1	D	32-bit data decrement	3	"P. 11-36"
F39	D*D	S1, S2, D	32-bit data multiplication [S1 × S2 = D+1, D]	11	"P. 11-38"

■ BCD data arithmetic instructions

Fun no.	Mnemonic	Operands	Name	Steps	Reference page:
F40	B+	S, D	4-digit BCD data addition [D+S=D]	5	"P. 12-2"

1.2 List of High-level Instructions

Fun no.	Mnemonic	Operands	Name	Steps	Reference page:
F41	DB+	S, D	8-digit BCD data addition [D+S=D]	7	"P. 12-4"
F42	B+	S1, S2, D	4-digit BCD data addition [S1+S2=D]	7	"P. 12-6"
F43	DB+	S1, S2, D	8-digit BCD data addition [S1+S2=D]	11	"P. 12-8"
F45	B-	S, D	4-digit BCD data subtraction [D-S=D]	5	"P. 12-10"
F46	DB-	S, D	8-digit BCD data subtraction [D-S=D]	7	"P. 12-12"
F47	B-	S1, S2, D	4-digit BCD data subtraction [S1-S2=D]	7	"P. 12-14"
F48	DB-	S1, S2, D	8-digit BCD data subtraction [S1-S2=D]	11	"P. 12-16"
F50	B*	S1, S2, D	4-digit BCD data multiplication [S1*S2=D+1, D]	7	"P. 12-18"
F51	DB*	S1, S2, D	8-Digit BCD data multiplication [S1*S2=D+3,D+2,D+1,D]	11	"P. 12-20"
F52	B%	S1, S2, D	4-digit BCD data division [S1/S2=D]	7	"P. 12-22"
F53	DB%	S1, S2, D	8-digit BCD data division [S1/S2=D+1, D]	11	"P. 12-24"
F55	B+1	D	4-digit BCD data increment	3	"P. 12-26"
F56	DB+1	D	8-digit BCD data increment	3	"P. 12-28"
F57	B-1	D	4-digit BCD data decrement	3	"P. 12-30"
F58	DB-1	D	8-digit BCD data decrement	3	"P. 12-32"

■ Data comparison instructions

Fun no.	Mnemonic	Operands	Name	Steps	Reference page:
F60	CMP	S1, S2	16-bit data comparison	5	"P. 13-2"
F61	DCMP	S1, S2	32-bit data comparison	9	"P. 13-8"
F62	WIN	S1, S2, S3	16-bit data band comparison	7	"P. 13-12"
F63	DWIN	S1, S2, S3	32-bit data band comparison	13	"P. 13-14"
F64	BCMP	S1, S2, S3	Block data comparison	7	"P. 13-16"

1.2 List of High-level Instructions

Fun no.	Mnemonic	Operands	Name	Steps	Reference page:
F373	DTR	S, D	16-bit data revision detection	6	"P. 13-19"
F374	DDTR	S, D	32-bit data revision detection	6	"P. 13-21"

■ Boolean instructions

Fun no.	Mnemonic	Operands	Name	Steps	Reference page:
F65	WAN	S1, S2, D	16-bit data AND	7	"P. 14-2"
F66	WOR	S1, S2, D	16-bit data OR	7	"P. 14-4"
F67	XOR	S1, S2, D	16-bit data exclusive OR	7	"P. 14-6"
F68	XNR	S1, S2, D	16-bit data exclusive NOR	7	"P. 14-8"
F69	WUNI	S1, S2, S3, D	[(S1 AND S3) OR (S2 AND S3) = D] (16-bit)	9	"P. 14-10"
F215	DAND	S1, S2, D	32-bit data AND	12	"P. 14-12"
F216	DOR	S1, S2, D	32-bit data OR	12	"P. 14-14"
F217	DXOR	S1, S2, D	32-bit data exclusive OR	12	"P. 14-16"
F218	DXNR	S1, S2, D	32-bit data exclusive NOR	12	"P. 14-18"
F219	DUNI	S1, S2, S3, D	[(S1 AND S3) OR (S2 AND S3) = D] (32-bit)	16	"P. 14-20"

■ Data conversion instructions

Fun no.	Mnemonic	Operands	Name	Steps	Reference page:
F70	BCC	S1, S2, S3, D	Block check code (ADD.SUB,XOR,CRC)	9	"P. 15-3"
F71	HEXA	S1, S2, D	Convert hexadecimal data to ASCII code	7	"P. 15-7"
F72	AHEX	S1, S2, D	Convert ASCII code to hexadecimal data	7	"P. 15-10"
F73	BCDA	S1, S2, D	Convert BCD data to ASCII code	7	"P. 15-14"
F74	ABCD	S1, S2, D	Convert ASCII code to BCD data	7	"P. 15-18"

1.2 List of High-level Instructions

Fun no.	Mnemonic	Operands	Name	Steps	Reference page:
F75	BINA	S1, S2, D	Convert 16-bit binary data to ASCII code	7	"P. 15-22"
F76	ABIN	S1, S2, D	Convert ASCII code to 16-bit binary data	7	"P. 15-25"
F77	DBIA	S1, S2, D	Convert 32-bit binary data to ASCII code	11	"P. 15-29"
F78	DABI	S1, S2, D	Convert ASCII code to 32-bit binary data	11	"P. 15-32"
F80	BCD	S, D	Convert 16-bit binary data to BCD data	5	"P. 15-36"
F81	BIN	S, D	Convert BCD data to 16-bit binary data	5	"P. 15-38"
F82	DBCD	S, D	Convert 32-bit binary data to BCD data	7	"P. 15-40"
F83	DBIN	S, D	Convert BCD data to 32-bit binary data	7	"P. 15-41"
F84	INV	D	16-bit data inversion	3	"P. 15-42"
F85	NEG	D	16-bit data sign inversion	3	"P. 15-43"
F86	DNEG	D	32-bit data sign inversion	3	"P. 15-44"
F87	ABS	D	16-bit data absolute value	3	"P. 15-46"
F88	DABS	D	32-bit data absolute value	3	"P. 15-47"
F89	EXT	D	Sign extension	3	"P. 15-48"
F90	DECO	S, n, D	Decode	7	"P. 15-50"
F91	SEGT	S, D	7-segment	5	"P. 15-53"
F92	ENCO	S, n, D	Encode	7	"P. 15-55"
F93	UNIT	S, n, D	Digit combine	7	"P. 15-58"
F94	DIST	S, n, D	Digit distribute	7	"P. 15-60"
F96	SRC	S1, S2, S3	16-bit data search	7	"P. 15-62"
F97	DSRC	S1, S2, S3, S4	32-bit data search	9	"P. 15-64"
F230	TMSEC	S, D	Time to second conversion	6	"P. 15-66"

1.2 List of High-level Instructions

Fun no.	Mnemonic	Operands	Name	Steps	Reference page:
F231	SECTM	S, D	Second to time conversion	6	"P. 15-69"
F235	GRY	S, D	16-bit data to gray code conversion	6	"P. 15-72"
F236	DGRY	S, D	32-bit data to gray code conversion	8	"P. 15-73"
F237	GBIN	S, D	Gray code to 16-bit data conversion	6	"P. 15-74"
F238	DGBIN	S, D	Gray code to 32-bit data conversion	8	"P. 15-75"
F240	COLM	S1, S2, D	Bit line to bit column conversion	8	"P. 15-77"
F241	LINE	S1, S2, D	Bit column to bit line conversion	8	"P. 15-79"

■ Data shift instruction

Fun no.	Mnemonic	Operands	Name	Steps	Reference page:
F100	SHR	D, n	16-bit data right shift	5	"P. 16-2"
F101	SHL	D, n	16-bit data left shift	5	"P. 16-4"
F102	DSHR	D, n	32-bit data right shift	5	"P. 16-6"
F103	DSHL	D, n	32-bit data left shift	5	"P. 16-8"
F105	BSR	D	16-bit data 1 digit right shift	3	"P. 16-10"
F106	BSL	D	16-bit data 1 digit left shift	3	"P. 16-12"
F108	BITR	D1, D2, n	Block area bitwise right shift	7	"P. 16-14"
F109	BITL	D1, D2, n	Block area bitwise left shift	7	"P. 16-16"
F110	WSHR	D1, D2	Block area one-word right shift	5	"P. 16-18"
F111	WSHL	D1, D2	Block area one-word left shift	5	"P. 16-20"
F112	WBSR	D1, D2	Block area 1 digit right shift	5	"P. 16-22"
F113	WBSL	D1, D2	Block area 1 digit left shift	5	"P. 16-24"

1.2 List of High-level Instructions

■ Data rotation instructions

Fun no.	Mnemonic	Operands	Name	Steps	Reference page:
F120	ROR	D, n	16-bit data right rotation	5	"P. 17-2"
F121	ROL	D, n	16-bit data left rotation	5	"P. 17-4"
F122	RCR	D, n	16-bit data right rotation with carry	5	"P. 17-6"
F123	RCL	D, n	16-bit data left rotation with carry	5	"P. 17-8"
F125	DROR	D, n	32-bit data right rotation	5	"P. 17-10"
F126	DROL	D, n	32-bit data left rotation	5	"P. 17-12"
F127	DRCR	D, n	32-bit data right rotation with carry	5	"P. 17-14"
F128	DRCL	D, n	32-bit data left rotation with carry	5	"P. 17-16"

■ Data buffer instruction

Fun no.	Mnemonic	Operands	Name	Steps	Reference page:
F98	CMPR	D1, D2, D3	Compress shift read	7	"P. 18-2"
F99	CMPW	S1, D, S2	Compress shift write	7	"P. 18-6"
F115	FIFT	n, D	FIFO buffer definition	5	"P. 18-11"
F116	FIFR	S, D	FIFO data read	5	"P. 18-14"
F117	FIFW	S, D	FIFO data write	5	"P. 18-18"

■ Bit manipulation instructions

Fun no.	Mnemonic	Operands	Name	Steps	Reference page:
F130	BTS	D, n	Specified bit set	5	"P. 19-2"
F131	BTR	D, n	Specified bit reset	5	"P. 19-4"
F132	BTI	D, n	Specified bit inversion	5	"P. 19-6"

1.2 List of High-level Instructions

Fun no.	Mnemonic	Operands	Name	Steps	Reference page:
F133	BTT	S, n	Specified bit test	5	"P. 19-8"
F135	BCU	S, D	Count ON bits in 16-bit data	5	"P. 19-10"
F136	DBCUC	S, D	Count ON bits in 32-bit data	7	"P. 19-12"

■ Special instructions

Fun no.	Mnemonic	Operands	Name	Steps	Reference page:
F138	HMSS	S, D	Hour, minute, second data to second data conversion	5	"P. 20-2"
F139	SHMS	S, D	Second data to hour, minute, second data conversion	5	"P. 20-4"
F140	STC		Cy flag set	1	"P. 20-6"
F141	CLC		Cy flag clear	1	"P. 20-7"
F143	IORF	D1, D2	Partial I/O refresh	5	"P. 20-8"
F147	PR	S, D	Print out	5	"P. 20-9"
F148	ERR	n	Self-diagnostic error code set	3	"P. 20-14"
F149	MSG	S	Character send to programming tool	13	"P. 20-16"
F150	READ	S1, S2, n, D	Shared memory read	9	"P. 20-17"
F151	WRT	S1, S2, n, D	Write to shared memory	9	"P. 20-20"
F157	CADD	S1, S2, D	Calendar data addition	9	"P. 20-23"
F158	CSUB	S1, S2, D	Calendar data subtraction	9	"P. 20-26"
F160	DSQR	S, D	32-bit data square root	7	"P. 20-31"

■ Serial communication instructions

Fun no.	Mnemonic	Operand	Name	Step	Reference page
F145	SEND	S1, S2, D, N	Data send instruction [MEWTOCOL master]	9	"P.21-4"
F146	RECV	S1, S2, N, D	Data receive instruction [MEWTOCOL master]	9	"P.21-8"

1.2 List of High-level Instructions

Fun no.	Mnemonic	Operand	Name	Step	Reference page
F145	SEND	S1, S2, D, N	Data send instruction [MODBUS master: Function code specification]	9	"P.21-12"
F146	RECV	S1, S2, N, D	Data receive instruction [MODBUS master: Function code specification]	9	"P.21-17"
F145	SEND	S1, S2, D, N	Data send instruction [MODBUS master: No function code specification]	9	"P.21-22"
F146	RECV	S1, S2, N, D	Data receive instruction [MODBUS master: No function code specification]	9	"P.21-28"
F159	MTRN	S, n, D	General-purpose communication instructions	7	"P.21-36"

■ Ethernet communication instructions (C32ET only)

Fun no.	Mnemonic	Operand	Name	Step	Reference page
F145	SEND	S1, S2, D, N	Data send instruction [MEWTOCOL master]	9	"P.22-4"
F146	RECV	S1, S2, N, D	Data receive instruction [MEWTOCOL master]	9	"P.22-7"
F145	SEND	S1, S2, D, N	Data send instruction [MODBUS master: Function code specification]	9	"P.22-10"
F146	RECV	S1, S2, N, D	Data receive instruction [MODBUS master: Function code specification]	9	"P.22-12"
F145	SEND	S1, S2, D, N	Data send instruction [MODBUS master: No function code specification]	9	"P.22-14"
F146	RECV	S1, S2, N, D	Data receive instruction [MODBUS master: No function code specification]	9	"P.22-17"
F145	SEND	S1, S2, D, N	Data send instruction [MC protocol master].	9	"P.22-20"
F146	RECV	S1, S2, N, D	Data receive instruction [MC protocol master]	9	"P.22-23"
F159	MTRN	S, n, D	General-purpose communication instructions	7	"P.22-26"

■ Sampling trace instructions

Fun no.	Mnemonic	Operand	Name	Step	Reference page
F155	SMPL		Sample set data	1	"P.23-3"
F156	STRG		Sampling stop trigger	1	"P.23-4"

■ High-speed counter instructions

Fun no.	Mnemonic	Operand	Name	Step	Reference page
F0	MV	S, DT90052	High-speed counter control	5	"P.24-2"
F1	DMV	S, DT90300	High-speed counter elapsed value read	7	"P.24-4"
F1	DMV	DT90300, D	High-speed counter elapsed value write	7	"P.24-4"
F166	HC1S	n, S, D	Target value match ON (with channel specification)	11	"P.24-10"

1.2 List of High-level Instructions

Fun no.	Mnemonic	Operand	Name	Step	Reference page
F167	HC1R	n, S, D	Target value match OFF (with channel specification))	11	"P.24-10"

■ High-speed counter cam control instruction

Fun no.	Mnemonic	Operand	Name	Step	Reference page
F165	CAM0	S	Cam control	3	"P.24-5"

■ PWM output instructions

Fun no.	Mnemonic	Operand	Name	Step	Reference page
F173	PWMH	S, n	PWM output instruction (Frequency specification)	5	"P.24-12"
F173	PWMH	S, n	PWM output instruction (Control code specification)	5	"P.24-14"

■ Character String Instructions

Fun no.	Mnemonic	Operands	Name	Steps	Reference page:
F95	ASC	M, D	Convert character constant to ASCII code	15	"P. 25-2"
F250	BTOA	S1, S2, S3, D	Convert multiple binary data to ASCII data string	12	"P. 25-5"
F251	ATOB	S1, S2, S3, D	Convert multiple ASCII data strings to binary data	12	"P. 25-11"
F252	ACHK	S1, S2, S3	ASCII code check of multiple ASCII data strings	10	"P. 25-18"
F253	SSET	S1, S2, D	Character constant → ASCII code conversion (with storage area size)	8-264 (Note 1)	"P. 25-20"
F254	PRINT ^(Note 2)	S1, S2, S3, D	Text creation	10-266 (Note 1)	"P. 25-24"
F257	SCMP	S1, S2, D	Character string comparison	10	"P. 25-38"
F258	SADD	S1, S2, D	Character string addition	12	"P. 25-40"
F259	LEN	S, D	Character string length	6	"P. 25-42"
F260	SSRC	S1, S2, D	Character string search	10	"P. 25-44"
F261	RIGHT	S1, S2, D	Right retrieve from character string	8	"P. 25-46"
F262	LEFT	S1, S2, D	Left retrieve from character string	8	"P. 25-48"

1.2 List of High-level Instructions

Fun no.	Mnemonic	Operands	Name	Steps	Reference page:
F263	MIDR	S1, S2, S3, D	Read from any position in character string	10	"P. 25-50"
F264	MIDW	S1, S2, S3, D	Write to any position in character string	12	"P. 25-52"
F265	SREP	S, D, P, n	Replace character string	12	"P. 25-54"

(Note 1) For instructions F253/F254, the number of steps varies depending on the contents specified in the operand.

(Note 2) The F254 instruction can be used with the unit firmware Ver. 1.7 or later.

■ Data manipulation instructions

Fun no.	Mnemonic	Operands	Name	Steps	Reference page:
F270	MAX	S1, S2, D	Search maximum value from 16-bit data block	8	"P. 26-2"
F271	DMAX	S1, S2, D	Search maximum value from 32-bit data block	8	"P. 26-4"
F272	MIN	S1, S2, D	Search minimum value from 16-bit data block	8	"P. 26-6"
F273	DMIN	S1, S2, D	Search minimum value from 32-bit data block	8	"P. 26-8"
F275	MEAN	S1, S2, D	16-bit data sum and average	8	"P. 26-10"
F276	DMEAN	S1, S2, D	32-bit data sum and average	8	"P. 26-12"
F277	SORT	S1, S2, S3	16-bit data block sort	8	"P. 26-14"
F278	DSORT	S1, S2, S3	32-bit data block sort	8	"P. 26-16"
F282	SCAL	S1, S2, D	16-bit data linearization	8	"P. 26-18"
F283	DSCAL	S1, S2, D	32-bit data linearization	10	"P. 26-21"
F284	RAMP	S1, S2, S3, D	16-bit data ramp output	10	"P. 26-24"
F285	LIMIT	S1, S2, S3, D	16-bit data upper and lower limit control	10	"P. 26-26"
F286	DLIMIT	S1, S2, S3, D	32-bit data upper and lower limit control	16	"P. 26-28"
F287	BAND	S1, S2, S3, D	16-bit data deadband control	10	"P. 26-30"
F288	DBAND	S1, S2, S3, D	32-bit data deadband control	16	"P. 26-32"

1.2 List of High-level Instructions

Fun no.	Mnemonic	Operands	Name	Steps	Reference page:
F289	ZONE	S1, S2, S3, D	16-bit data zone control	10	"P. 26-34"
F290	DZONE	S1, S2, S3, D	32-bit data zone control	16	"P. 26-36"

■ Floating-point instruction

Fun no.	Mnemonic	Operands	Name	Steps	Reference page:
F309	FMV	S, D	Floating point data move	8	"P. 27-3"
F310	F+	S1, S2, D	Floating point data addition	14	"P. 27-5"
F311	F-	S1, S2, D	Floating point data subtraction	14	"P. 27-7"
F312	F*	S1, S2, D	Floating point data multiplication	14	"P. 27-9"
F313	F%	S1, S2, D	Floating point data division	14	"P. 27-11"
F314	SIN	S, D	Floating point data sine operation	10	"P. 27-13"
F315	COS	S, D	Floating point data cosine operation	10	"P. 27-15"
F316	TAN	S, D	Floating point data tangent operation	10	"P. 27-17"
F317	ASIN	S, D	Floating point data arcsine operation	10	"P. 27-19"
F318	ACOS	S, D	Floating point data arccosine operation	10	"P. 27-21"
F319	ATAN	S, D	Floating point data arctangent operation	10	"P. 27-23"
F320	LN	S, D	Floating point data natural logarithmic operation	10	"P. 27-25"
F321	EXP	S, D	Floating point data exponent operation	10	"P. 27-27"
F322	LOG	S, D	Floating point data logarithm operation	10	"P. 27-29"
F323	PWR	S1, S2, D	Floating point data power operation	14	"P. 27-31"
F324	FSQR	S, D	Floating point data square root operation	10	"P. 27-33"
F325	FLT	S, D	16-bit integer to floating point data conversion	6	"P. 27-35"
F326	DFLT	S, D	32-bit integer to floating point data conversion	8	"P. 27-36"

1.2 List of High-level Instructions

Fun no.	Mnemonic	Operands	Name	Steps	Reference page:
F327	INT	S, D	Convert to largest 16-bit integer that does not exceed floating point data	8	"P. 27-38"
F328	DINT	S, D	Convert to largest 32-bit integer that does not exceed floating point data	8	"P. 27-40"
F329	FIX	S, D	Convert floating point data to truncated 16-bit integer	8	"P. 27-42"
F330	DFIX	S, D	Convert floating point data to truncated 32-bit integer	8	"P. 27-44"
F331	ROFF	S, D	Convert floating point data to rounded 16-bit integer	8	"P. 27-46"
F332	DROFF	S, D	Convert floating point data to rounded 32-bit integer	8	"P. 27-48"
F333	FINT	S, D	Truncate floating point data after decimal	8	"P. 27-50"
F334	FRINT	S, D	Round floating point data after decimal	8	"P. 27-52"
F335	F+/-	S, D	Floating point data sign conversion	8	"P. 27-54"
F336	FABS	S, D	Floating point data absolute value conversion	8	"P. 27-56"
F337	RAD	S, D	Degree to radian conversion	8	"P. 27-58"
F338	DEG	S, D	Radian to degree conversion	8	"P. 27-60"

■ Real number data processing instructions

Fun no.	Mnemonic	Operands	Name	Steps	Reference page:
F345	FCMP	S1, S2	Floating point data comparison	10	"P. 28-2"
F346	FWIN	S1, S2, S3	Floating point data band comparison	14	"P. 28-4"
F347	FLIMIT	S1, S2, S3, D	Floating point data lower limit and upper limit control	18	"P. 28-6"
F348	FBAND	S1, S2, S3, D	Floating point data deadband control	18	"P. 28-8"
F349	FZONE	S1, S2, S3, D	Floating point data zone control	18	"P. 28-10"
F354	FSCAL	S1, S2, D	Real number data scaling	12	"P. 28-12"

■ Process control instructions

Fun no.	Mnemonic	Operands	Name	Steps	Reference page:
F355	PID	S	PID operation	4	"P. 29-2"
F356	EZPID	S1, S2, S3, S4	PID operation: PWM output possible	10	"P. 29-9"

■ Positioning control instructions (Table setting mode)

Fun no.	Mnemonic	Operands	Name	Steps	Reference page:
F380	POSST	S1, S2, S3	Positioning table start	8	"P. 30-2"
F381	JOGST	S1, S2	JOG operation start	6	"P. 30-4"
F382	ORGST	S	Home return start	4	"P. 30-6"
F383	MPOST	S	Positioning simultaneous start	4	"P. 30-7"
F384	PTBLR	S1, S2, n, D	Positioning parameter read	10	"P. 30-9"
F385	PTBLW	S1, S2, n, D	Positioning parameter write	10	"P. 30-11"

■ Positioning control instructions (FPsigma compatible instruction mode)

Fun no.	Mnemonic	Operand	Name	Step	Reference page
F1	DMV	S, DT90348	Pulse output elapsed value read	7	"P.24-4"
F1	DMV	DT90348, D	Pulse output elapsed value write	7	"P.24-4"
F171	SPDH	S, n	Pulse output (Trapezoidal control)	5	"P.31-3"
F171	SPDH	S, n	Pulse output (Home return)	5	"P.31-9"
F172	PLSH	S, n	Pulse output (JOG operation)	5	"P.31-14"
F174	SP0H	S, n	Pulse output (Selectable data table control operation)	5	"P.31-17"
F175	SPSH	S, n	Pulse output (linear interpolation)	5	"P.31-22"

■ Logging/trace control instruction

Fun no.	Mnemonic	Operands	Name	Steps	Reference page:
F420	LOGST	n	Logging trace start request	4	"P. 32-2"

1.2 List of High-level Instructions

Fun no.	Mnemonic	Operands	Name	Steps	Reference page:
F421	LOGED	n	Logging trace stop request	4	"P. 32-3"
F422	LOGSMPL	n	Sampling trace	4	"P. 32-4"

■ SD card access instructions

Fun no.	Mnemonic	Operands	Name	Steps	Reference page:
F425	CDTWT	S, n, D	Write file to operation memory in BIN format	8	"P. 33-6"
F426	CDTRD	S, n, D	Read from BIN format file to operation memory	8	"P. 33-8"
F427	CWT	S, n, D1, D2	File data write	10-266	"P. 33-10"
F428	CRD	S1, S2, n, D	File data read	10-266	"P. 33-23"
F429	CMKDIR	S	Directory creation	4-260	"P. 33-32"
F430	CRMDIR	S	Directory deletion	4-260	"P. 33-35"
F431	CRMDIRFL	S	Directory deletion (valid with files)	4-260	"P. 33-35"
F432	CFDEL	S	File deletion	4-260	"P. 33-39"
F433	CPR	S, D	ASCII data write to file	6-518	"P. 33-41"
F434	CRD1	S, D1, D2	One line read from file	8-264	"P. 33-44"
F435	CREN	S1, S2	File rename	6-518	"P. 33-50"
F436	CCOPY	S1, S2, S3	File copy	8-520	"P. 33-52"
F437	CMV	S1, S2, S3	File move	8-520	"P. 33-55"
F438	CFREE	D	SD memory card free capacity acquisition: byte unit	4	"P. 33-58"
F439	CFREEK	D	SD memory card free capacity acquisition: kilobyte unit	4	"P. 33-60"
F440	CFLS	S, D	File status acquisition	6-262	"P. 33-62"
F441	PanaSD	D1, D2, D3	Panasonic SD card lifetime information read	8	"P. 33-65"

(Note 1) For instructions F427/F428/F429/F430/F431/F432/F433/F434/F435/F436/F437/F440, the number of steps varies depending on the contents specified in the operand.

■ Ethernet communication instructions (C32ET only)

Fun no.	Mnemonic	Operands	Name	Steps	Reference page:
F460	IPv4SET	S	Ipv4 address setting	4-260	"P. 34-2"
F461	CONSET	S1, S2, D1, D2	Connection setting	10-522	"P. 34-7"
F462	OPEN	S	Connection open	4	"P. 34-14"
F463	CLOSE	S	Connection close	4	"P. 34-16"
F464	RDET	D	Ethernet Status Read	4	"P. 34-18"
F465	ETSTAT	S1, S2, D	Ethernet Information Acquisition	8-520	"P. 34-21"
P466	NTPcREQ	S1, S2, D	Time adjustment request	8	"P. 34-25"
F467	NTPcSV	S1, S2, S3	NTP destination server settings	8-776	"P. 34-31"
P468	PINGREQ	S, D	PING send request	6	"P. 34-36"
F469	UNITSEL	S1, S2	Specify communication unit slot port	6	"P. 34-40"

(Note 1) For instructions F460/F461/F465/F467, the number of steps varies depending on the contents specified in the operand.

(Note 2) The P466/F467/P468 instructions can be used with the unit firmware Ver. 1.8 or later.

■ EtherNet/IP instructions (C32ET only)

Fun no.	Mnemonic	Operand	Name	Step	Reference page
F465	ETSTAT	S1, S2, D	Information acquisition of EtherNet/IP	8-520	"P. 35-2"
F490	EIPNDST	S, D1, D2	EtherNet/IP node status acquisition instruction	8	"P. 35-9"
F495	EIPMSATT	S	EIP message destination setting	4	"P. 35-13"
F496	EIPMBODY	S	EIP message body setting	4	"P. 35-16"
F497	EIPMSEND	D1, D2	EIP message transmission	6	"P. 35-19"
F498	CIPMSET	S1, S2, D	CIP message data generation (combination)	8	"P. 35-23"
F499	CIPMGET	S1, S2, D1, D2	Data acquisition from CIP message	10	"P. 35-28"

(Note 1) For instruction F465, the number of steps varies depending on the contents specified in the operand.

1.2 List of High-level Instructions

(Note 2) The F490/F495/F496/F497/F498/F499 instructions can be used with the unit firmware Ver. 1.8 or later.

■ FTP instruction (C32ET only)

Fun no.	Mnemonic	Operand	Name	Step	Reference page:
F465	ETSTAT	S1, S2, D	EtherNet/IP information acquisition: FTP	8-520	"P. 36-2"
F470	FTPcSV	S1, S2, S3	FTP client connected server setting	8-776	"P. 36-8"
F471	FTPcSET	S1, S2, S3, S4	FTP client transfer setting	10-1034	"P. 36-14"
F472	FTPcLOG	S1, S2, S3	Logging/Trace transfer settings	8-776	"P. 36-22"
F473	FTPcREQ	S	FTP client transfer request	4	"P. 36-25"
F474	FTPcCTL	S1, S2	FTP client transfer control	6-518	"P. 36-29"

(Note 1) For instructions F470, F471, F472, and F474, the number of steps varies depending on the contents specified in the operand.

2 Sequence Basic Instructions

2.1 ST, ST/ and OT (Start, Start Not and Out).....	2-2
2.2 DST, DST/ (Direct start, direct start Not).....	2-4
2.3 DOT (direct out)	2-7
2.4 / (Not).....	2-10
2.5 AN, AN/ (AND, AND Not).....	2-11
2.6 DAN, DAN/ (Direct AND, Direct AND NOT).....	2-13
2.7 OR, OR/ (OR, OR Not)	2-16
2.8 DOR, DOR/ (Direct OR, Direct OR Not)	2-18
2.9 ST \uparrow , ST \downarrow , AN \uparrow , AN \downarrow , OR \uparrow , OR \downarrow (Rise Detection, Fall Detection)	2-21
2.10 ALT (Alternate Out).....	2-23
2.11 ANS (And Stack)	2-25
2.12 ORS (OR Stack)	2-27
2.13 PSHS, RDS, POPS (Push stack, Read stack, Pop stack).....	2-29
2.14 DF, DF/ (Rise Differential, Fall Differential)	2-33
2.15 DFI [Rise Differential (initial execution type)].....	2-38
2.16 SET, RST (Set, Reset).....	2-40
2.17 DSET/DRST (Direct Set/Direct Reset).....	2-43
2.18 KP (Keep)	2-47
2.19 DKP (Direct Keep)	2-49
2.20 NOP	2-52

2.1 ST, ST/ and OT (Start, Start Not and Out)

2.1 ST, ST/ and OT (Start, Start Not and Out)

■ Instruction format

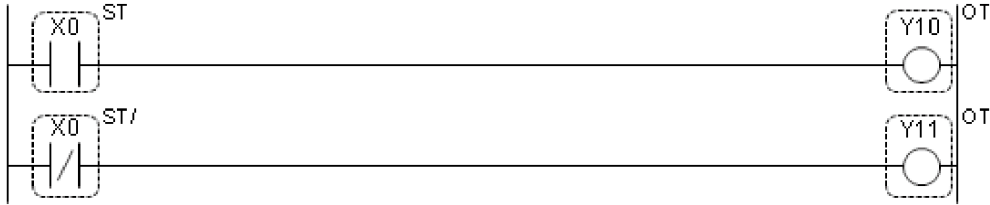

■ Instruction list

Instruction	Description
ST	Input contact starting logical operation as Form A (normally open)
ST/	Input contact starting logical operation as Form B (normally closed)
OT	Coil that outputs logical operation

■ Devices that can be specified (indicated by ●)

Operands	X	Y	R	T	C	L	Index modifier
ST	●	●	●	●	●	●	●
ST/	●	●	●	●	●	●	●
OT		●	●			●	●

■ Outline of operation

Instruction	Operation
ST	Handles input contact as Form A (normally open) and begins a logical operation.
ST/	Handles input contact as Form B (normally closed) and begins a logical operation.
OT	Outputs operation results to the specified coil.

■ Operation example

Operation of instruction format description program

- Execution results are output to Y10 when X0 is ON, and to Y11 when X0 is OFF.

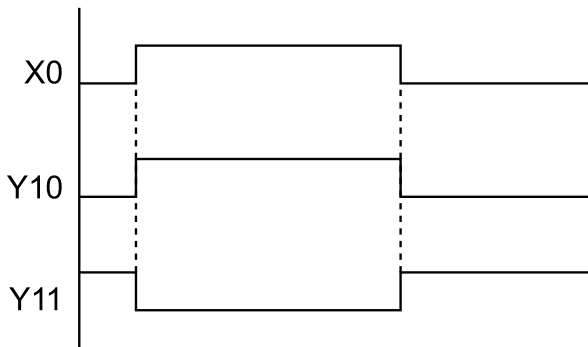

■ Precautions for programming

- **ST** instructions begin from the bus bar. (This is the same for **ST/** instructions)

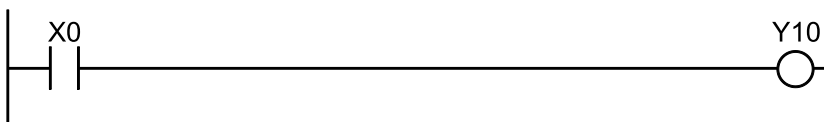

- **OT** instructions cannot begin directly from the bus bar.

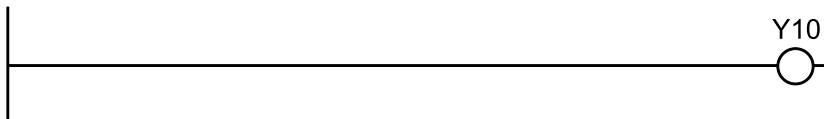

- **OT** instructions can be used consecutively.

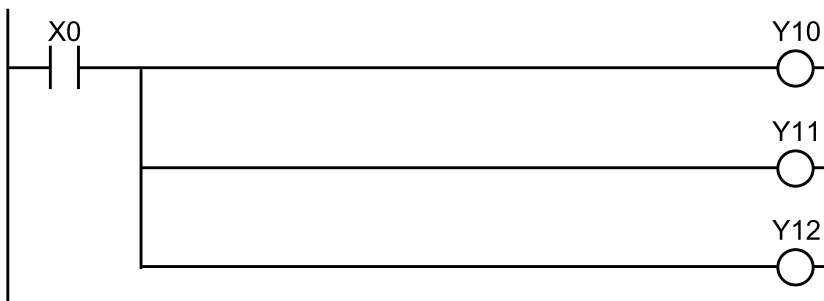

- When an external switch is Form B (normally closed), such as an emergency stop switch, take care to use **ST** instructions in programming.

2.2 DST, DST/ (Direct start, direct start Not)

2.2 DST, DST/ (Direct start, direct start Not)

■ Instruction format

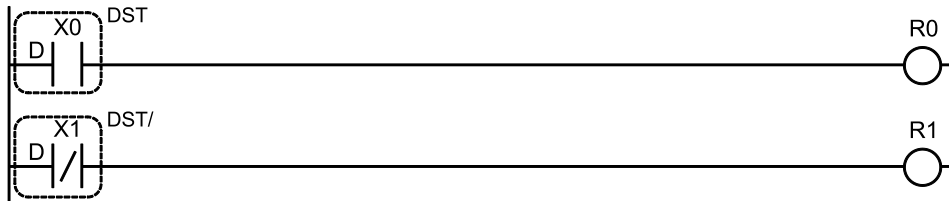

■ Instruction list

Instruction	Description
DST	Input contact starting logical operation as Form A (normally open)
DST/	Input contact starting logical operation as Form B (normally closed)

■ Devices that can be specified (indicated by ●)

Operands	X	Y	R	T	C	L	Index modifier
DST	●						●
DST/	●						●

■ Outline of operation

Instruction	Operation
DST	The specified external contact is read and reflected in the input contact, that input contact is handled as a Form A (normally open) contact, and the logical operation begins.
DST/	The specified external contact is read and reflected in the input contact, that input contact is handled as a Form B (normally closed) contact, and the logical operation begins.

■ Operation example

Operation of instruction format description program

- When external input X0 turns ON, R0 turns ON.
- When external input X1 turns OFF, R1 turns ON.

■ Precautions for programming

- If the contact is outside the permissible range, an operation error will result.
- When the time is set using the controller input time constant setting system register, the time constant is invalid.

■ Comparison of ST instruction and DST instruction

- Compared to the ST instruction, the DST instruction is capable of a high-speed response.

<For ST instruction>

• Ladder diagram

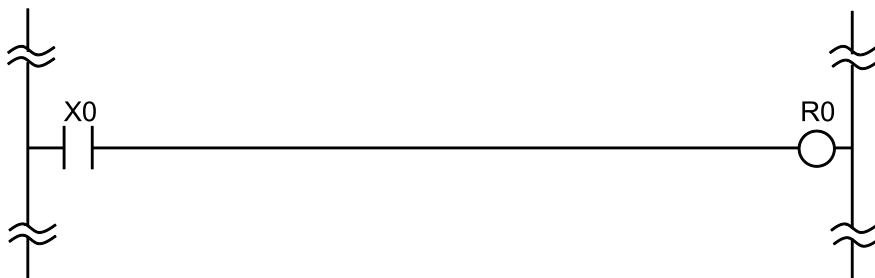

• Timing chart

*Main unit input constant setting: None

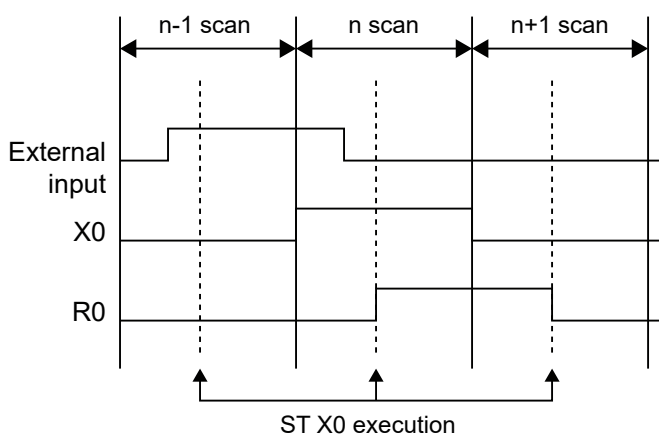

<For DST instruction>

• Ladder diagram

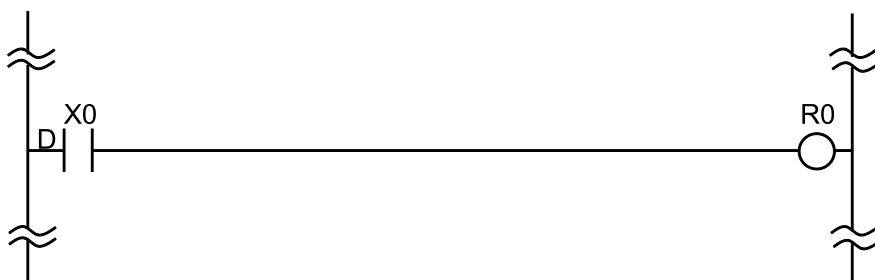

• Timing chart

*Main unit input constant setting: None

2.2 DST, DST/ (Direct start, direct start Not)

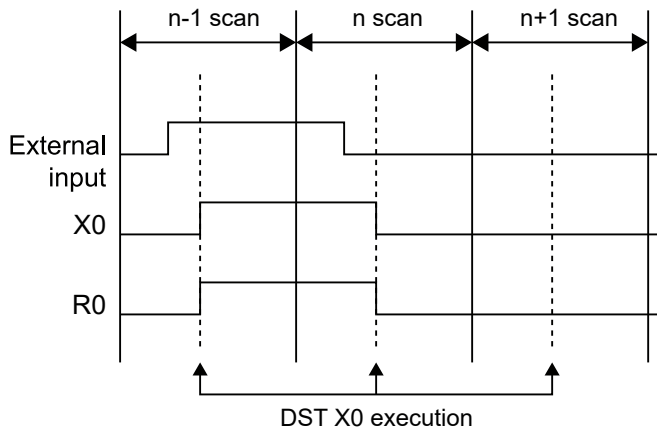

2.3 DOT (direct out)

■ Instruction format

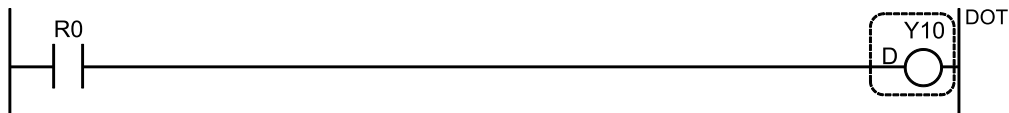

■ Instruction list

Instruction	Description
DOT	Coil that outputs logical operation

■ Devices that can be specified (indicated by ●)

Operands	X	Y	R	T	C	L	Index modifier
DOT		●					●

■ Outline of operation

Instruction	Operation
DOT	Reflects the operation result to the specified output contact, and outputs ON/OFF to the external output.

■ Operation example

Operation of instruction format description program

- If R0 is ON, Y0 turns ON.
- If R0 is OFF, Y0 turns OFF.

■ Precautions for programming

- If the contact is outside the permissible range, an operation error will result.
- If the same output coil is specified, a syntax error (duplicate output) will occur.

■ Comparison of OT instructions and DOT instructions

- Compared to OT instructions, DOT instructions are capable of high-speed responses.

<OT instruction>

2.3 DOT (direct out)

- Ladder diagram

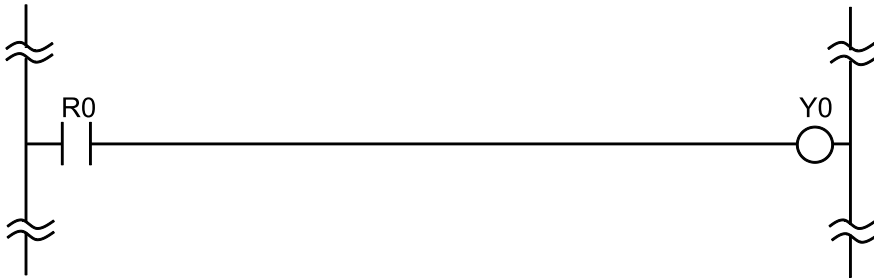

- Timing chart

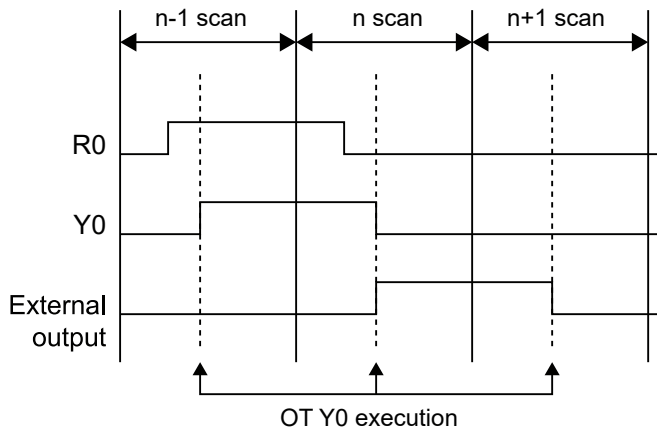

<DOT instruction>

- Ladder diagram

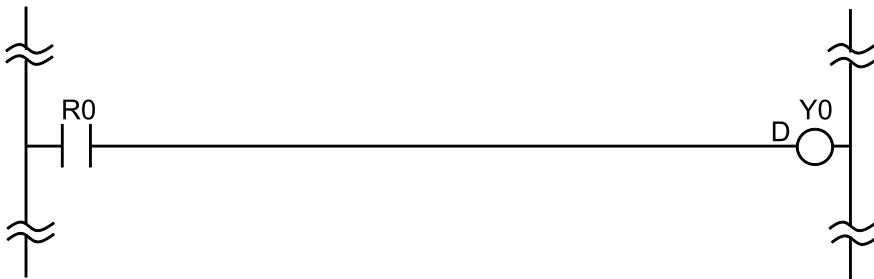

- Timing chart

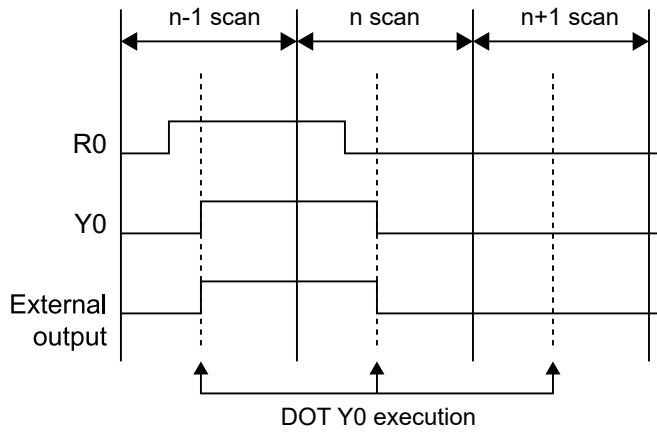

2.4 / (Not)

■ Instruction format

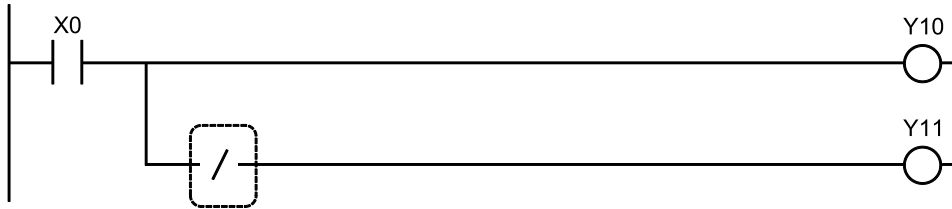

■ Outline of operation

- The **NOT** instruction inverts the operation result up to immediately before this instruction.

■ Operation example

Operation of instruction format description program

- When X0 turns ON, Y10 turns ON and Y11 turns OFF.
- When X0 turns OFF, Y10 turns OFF and Y11 turns ON.

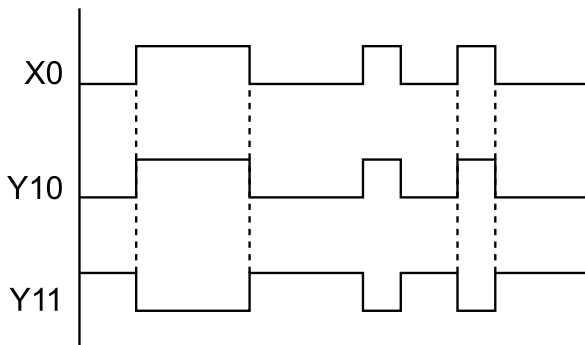

2.5 AN, AN/ (AND, AND Not)

■ Instruction format

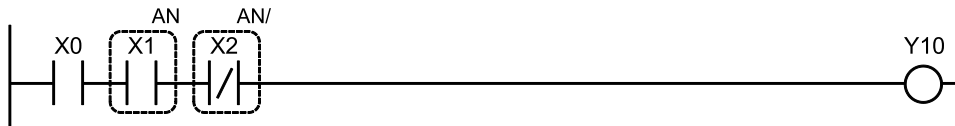

■ Instruction list

Instruction	Description
AN	Form A (normally open) contacts connected in series
AN/	Form B (normally closed) contacts connected in series

■ Devices that can be specified (indicated by ●)

Operands	X	Y	R	T	C	L	Index modifier
AN	●	●	●	●	●	●	●
AN/	●	●	●	●	●	●	●

■ Outline of operation

- A logical conjunction is executed with the immediately preceding serially connected operation result.

■ Operation example

Operation of instruction format description program

- When X0 and X1 turn ON and X2 turns OFF, the result is output to Y10.

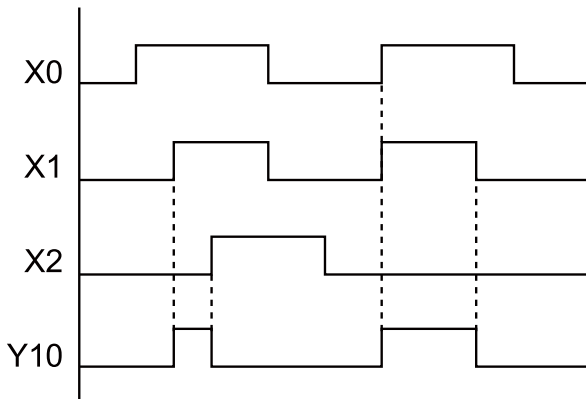

■ Precautions for programming

- Use the **AN** instruction when Form A (normally open) contacts are serially connected.
- Use the **AN/** instruction when Form B (normally closed) contacts are serially connected.

2.5 AN, AN/ (AND, AND Not)

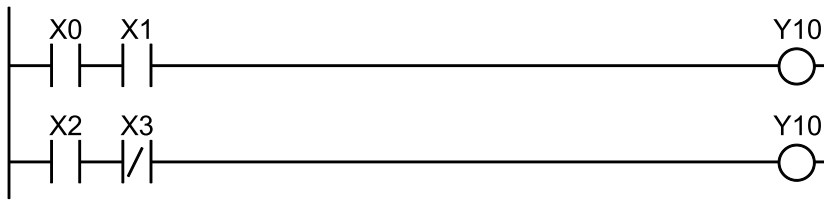

- The **AN** and **AN/** instructions can be used consecutively.

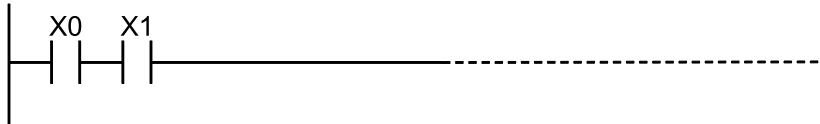

2.6 DAN, DAN/ (Direct AND, Direct AND NOT)

■ Instruction format

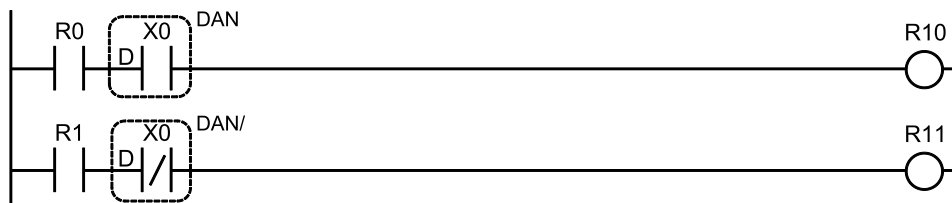

■ Instruction list

Instruction	Description
DAN	Form A (normally open) contacts connected in series
DAN/	Form B (normally closed) contacts connected in series

■ Devices that can be specified (indicated by ●)

Operands	X	Y	R	T	C	L	Index modifier
DAN	●						●
DAN/	●						●

■ Outline of operation

- Reads the specified external input, reflects this in the input contact, and performs a logical conjunction with the calculation results of the immediately preceding operation connected in series.

■ Operation example

Operation of instruction format description program

- R10 turns ON when R0 is ON and external input X0 is ON.
- R11 turns ON when R1 is ON and external input X0 is OFF.

■ Precautions for programming

- If the contact is outside the permissible range, an operation error will result.
- When the time is set using the controller input time constant setting system register, the time constant is invalid.

■ Comparison of AN instructions and DAN instructions

- Compared to AN instructions, DAN instructions are capable of faster response.

<For AN instruction>

2.6 DAN, DAN/ (Direct AND, Direct AND NOT)

- Ladder diagram

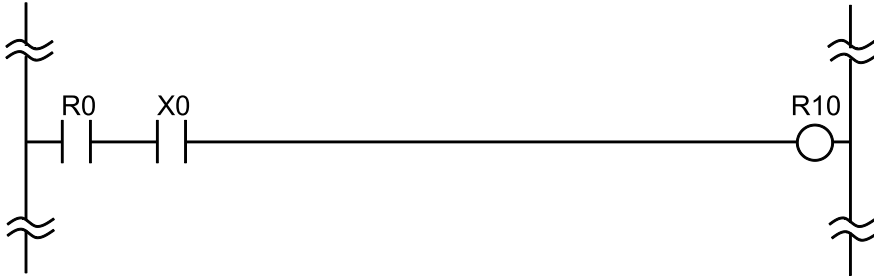

- Timing chart

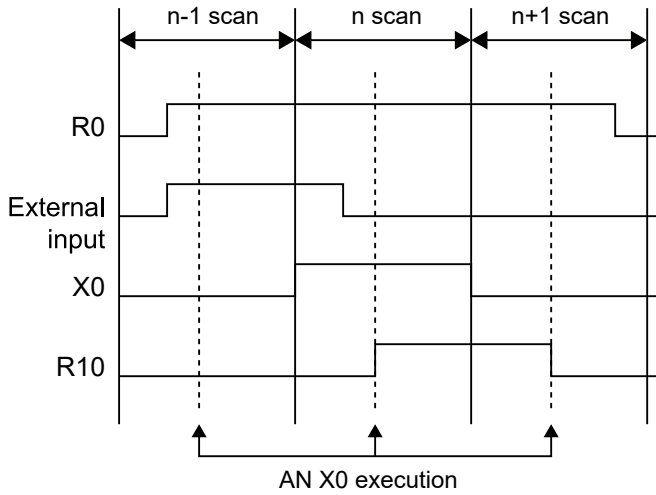

<For DAN instruction>

- Ladder diagram

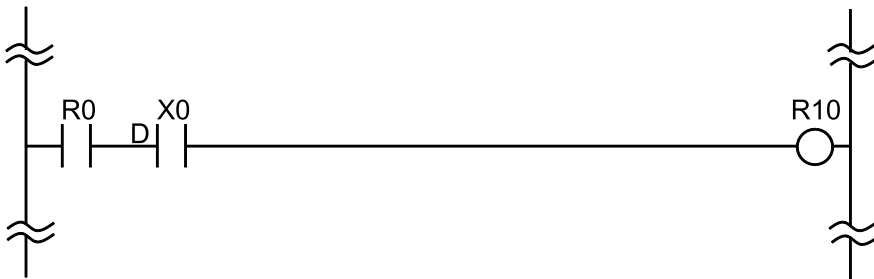

• Timing chart

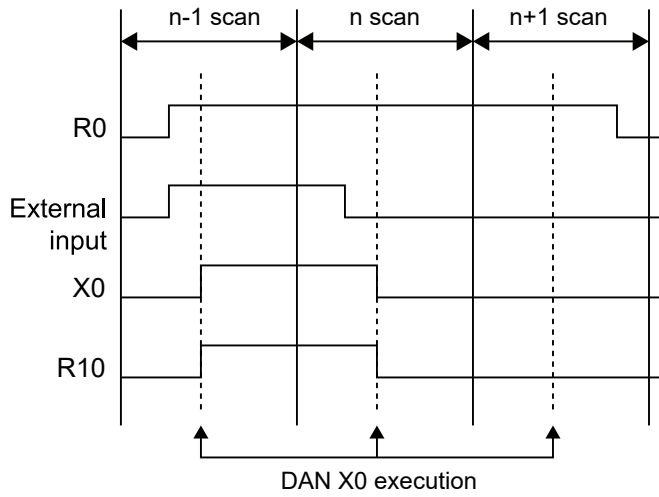

2.7 OR, OR/ (OR, OR Not)

2.7 OR, OR/ (OR, OR Not)

■ Instruction format

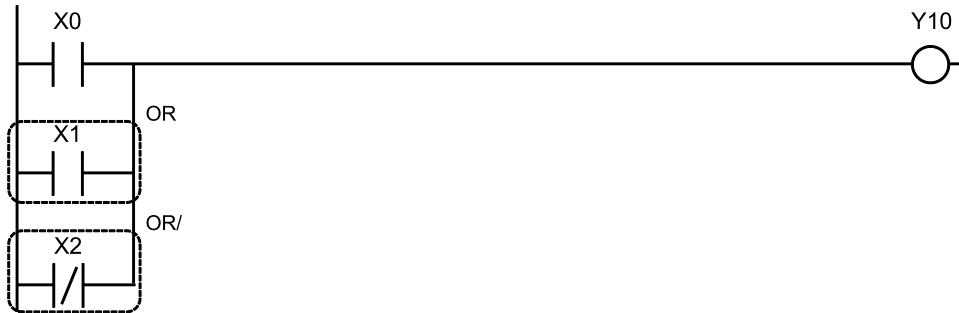

■ Instruction list

Instruction	Description
OR	Form A (normally open) contact connected in parallel
OR/	Form B (normally closed) contact connected in parallel

■ Devices that can be specified (indicated by ●)

Operands	X	Y	R	T	C	L	Index modifier
OR	●	●	●	●	●	●	●
OR/	●	●	●	●	●	●	●

■ Outline of operation

- A logical disjunction is executed with the immediately preceding operation result of the contact connected in parallel.

■ Operation example

Operation of instruction format description program

If any of the conditions of X0 ON, X1 ON, or X2 OFF is satisfied, the result is output to Y10.

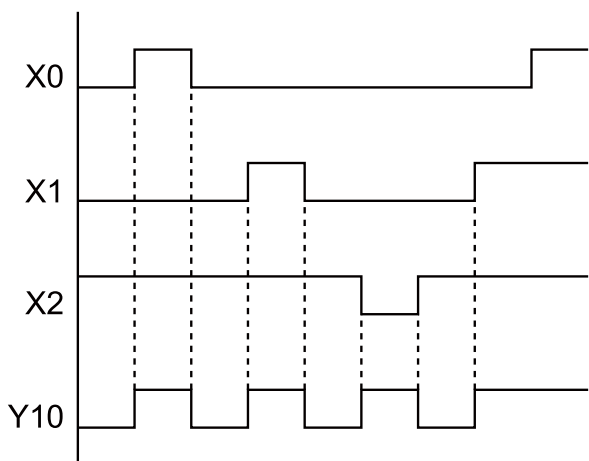

■ Precautions for programming

- Use the **OR** instruction when Form A (normally open) contacts are connected in parallel.
- Use the **OR/** instruction when Form B (normally closed) contacts are connected in parallel.
- The **OR** instruction, like the **ST** instruction, starts from the bus bar.
- The **OR** and **OR/** instructions can be used consecutively.



2.8 DOR, DOR/ (Direct OR, Direct OR Not)

■ **Instruction format**

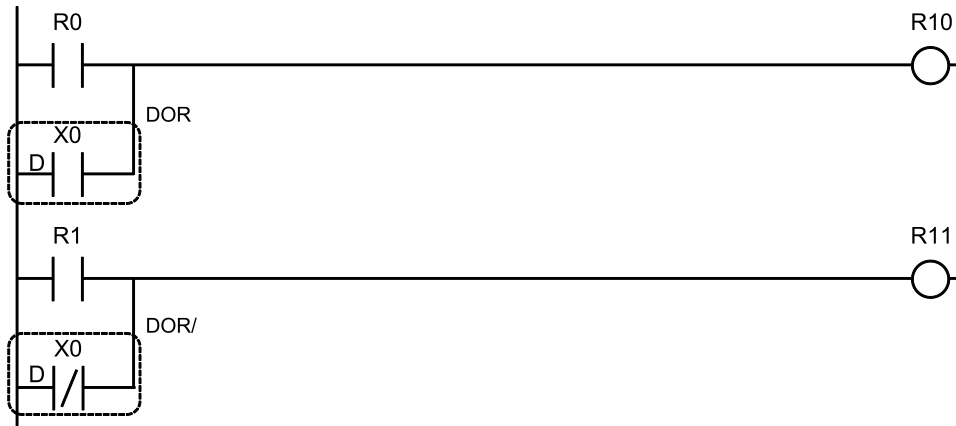

■ **Instruction list**

Instruction	Description
DOR	Form A (normally open) contact connected in parallel
DOR/	Form B (normally closed) contact connected in parallel

■ **Devices that can be specified (indicated by ●)**

Operands	X	Y	R	T	C	L	Index modifier
DOR	●						●
DOR/	●						●

■ **Outline of operation**

- The specified external input is read and the value is reflected to the input contact. A logical disjunction is executed with the immediately preceding operation result of the contact connected in parallel.

■ **Operation example**

Operation of instruction format description program

- When R0 turns OFF or external input X0 turns ON, R10 turns ON.
- When R1 turns OFF or external input X0 turns OFF, R11 turns ON.

■ **Precautions for programming**

- If the contact is outside the permissible range, an operation error will result.
- When the time is set using the controller input time constant setting system register, the time constant is invalid.

■ Comparing the OR instruction and DOR instruction

- A quicker response is possible with a DOR instruction than with an OR instruction.

<OR instruction>

- Ladder diagram

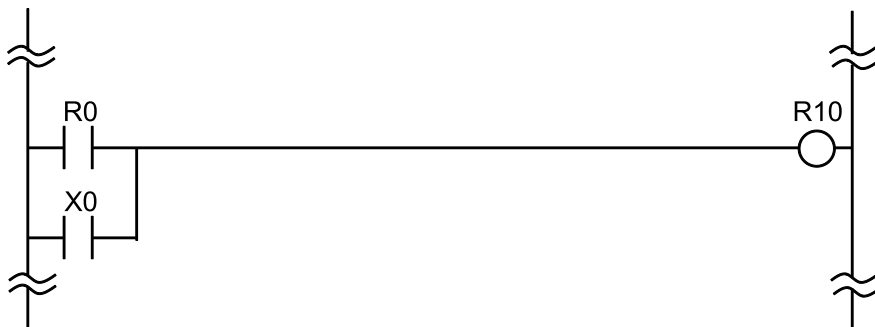

- Timing chart

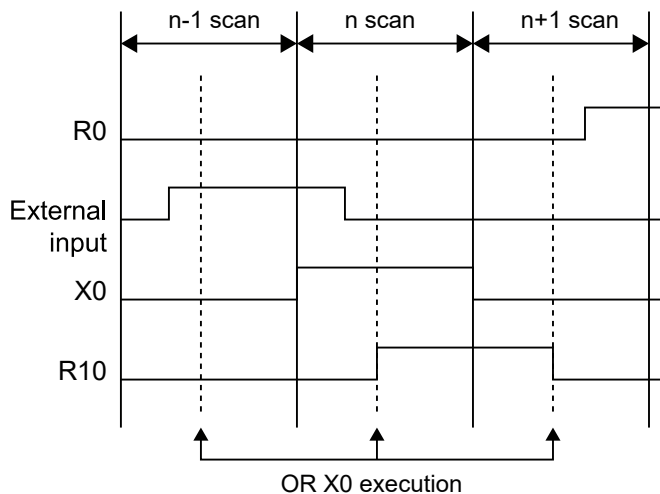

<DOR instruction>

- Ladder diagram

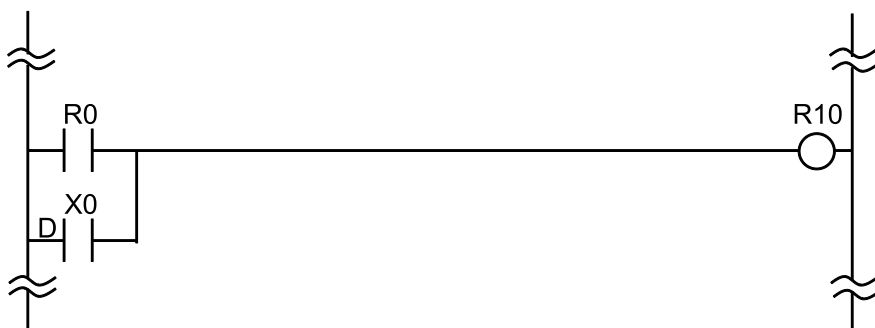

2.8 DOR, DOR/ (Direct OR, Direct OR Not)

- Timing chart

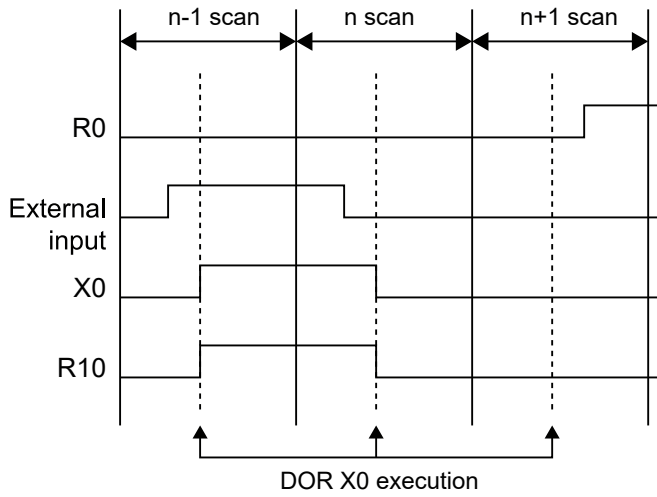

2.9 ST \uparrow , ST \downarrow , AN \uparrow , AN \downarrow , OR \uparrow , OR \downarrow (Rise Detection, Fall Detection)

■ Instruction format

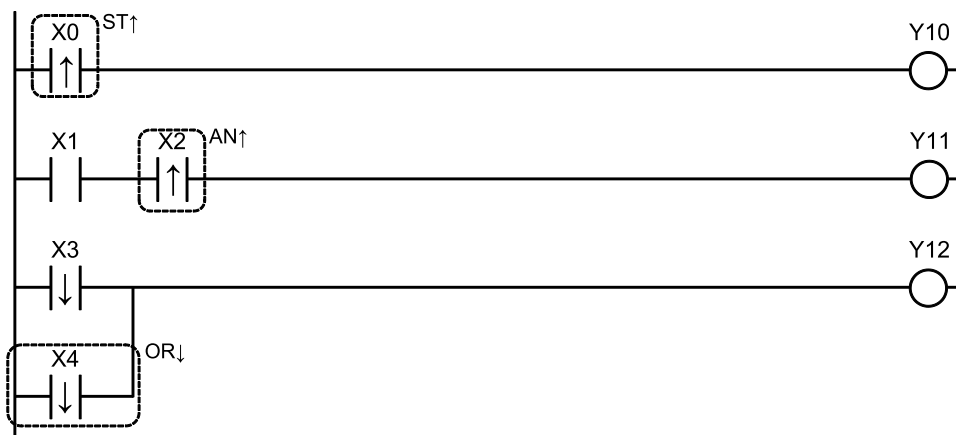

■ Instruction list

Instruction	Description
ST \uparrow , ST \downarrow	Input contact that starts a logical operation at the rise or fall of a signal
AN \uparrow , AN \downarrow	Contacts connected in series at the rise or fall of a signal
OR \uparrow , OR \downarrow	Contacts connected in parallel at the rise or fall of a signal

■ Devices that can be specified (indicated by ●)

Operands	X	Y	R	T	C	L	Index modifier
ST \uparrow , ST \downarrow	●	●	●	●	●	●	
AN \uparrow , AN \downarrow	●	●	●	●	●	●	
OR \uparrow , OR \downarrow	●	●	●	●	●	●	

■ Outline of operation

Instruction	Operation
ST \uparrow , AN \uparrow , OR \uparrow	Conduction takes place for 1 scan only following the change of a signal from the OFF to ON state (rise).
ST \downarrow , AN \downarrow , OR \downarrow	Conduction takes place for 1 scan only following the change of a signal from the ON to OFF state (fall).

■ Operation example

Operation of instruction format description program

1. When X0 changes from OFF to ON (rise), only 1 scan is output to Y10.

2.9 ST \uparrow , ST \downarrow , AN \uparrow , AN \downarrow , OR \uparrow , OR \downarrow (Rise Detection, Fall Detection)

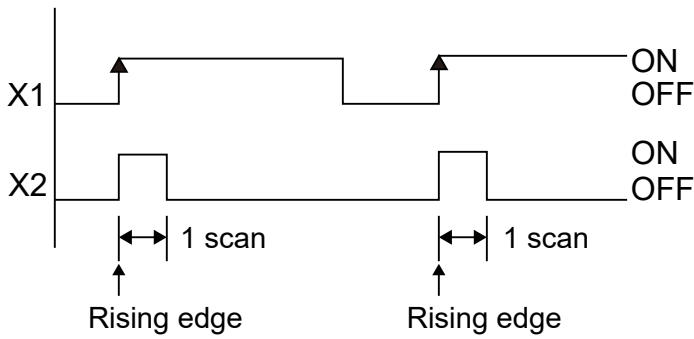

2. Output to Y11 takes place for 1 scan only following the change of X2 from the OFF to ON state (rise) when X1 is ON.

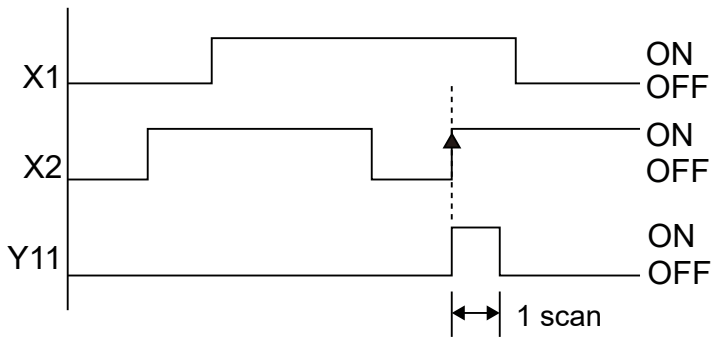

3. Output to Y12 takes place for 1 scan only following the change of X3 or X4 from the ON to OFF state (fall).

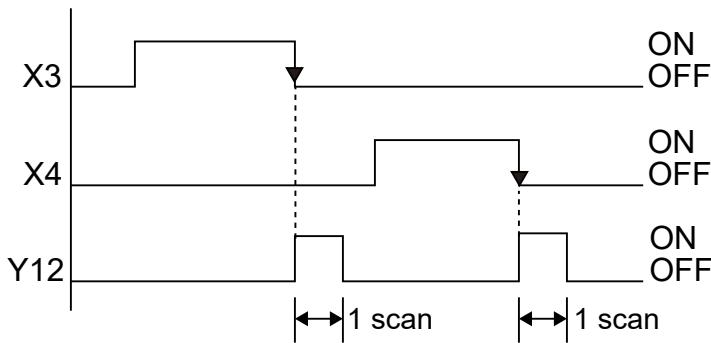

2.10 ALT (Alternate Out)

■ Instruction format

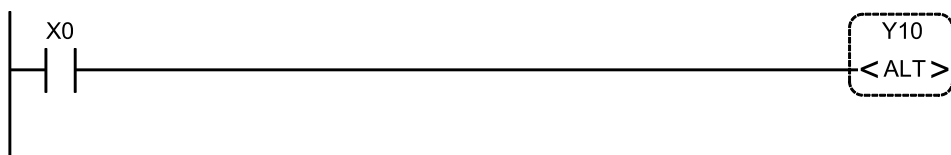

■ Instruction list

Instruction	Description
ALT	Coil that controls flip-flops

■ Devices that can be specified (indicated by ●)

Operands	X	Y	R	T	C	L	Index modifier
ALT		●	●			●	

■ Outline of operation

- When the operation result up to immediately before changes (rises) from OFF to ON, the specified coil ON/OFF is inverted.
- The specified coil ON/OFF status is held until the next rise of the **ALT** instruction that specifies that coil. (Flip-flop control)

■ Operation example

Operation of instruction format description program

Each time X0 changes from OFF to ON (rises), the output Y10 ON/OFF status is inverted.

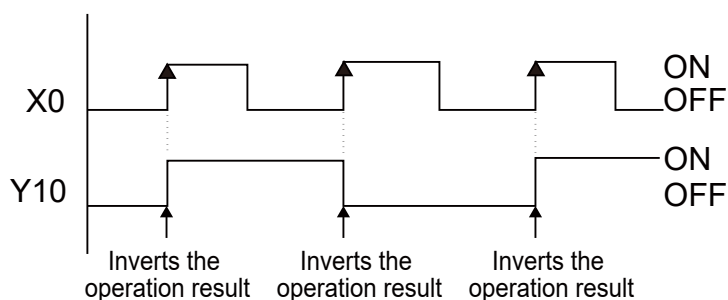

■ Precautions for programming

The **ALT** instruction detects input OFF to ON rise and inverts the output.

- While the input continues to be ON, it is inverted only during rise. After that it is not inverted.
- When switching to RUN or when powering on in "RUN mode", if input is ON from the beginning, inversion is not carried out for the first scan.

2.10 ALT (Alternate Out)

- Be aware that, if used with instructions that change the order of execution such as the MC to MCE instructions or the JP to LBL instructions (see 1 to 6 below), the operation of instructions may change depending on the timing of instruction execution and input.
 1. MC to MCE instructions
 2. JP to LBL instructions
 3. LOOP to LBL instructions
 4. CNDE instruction
 5. Step ladder instructions
 6. Subroutine instructions

2.11 ANS (And Stack)

■ **Instruction format**

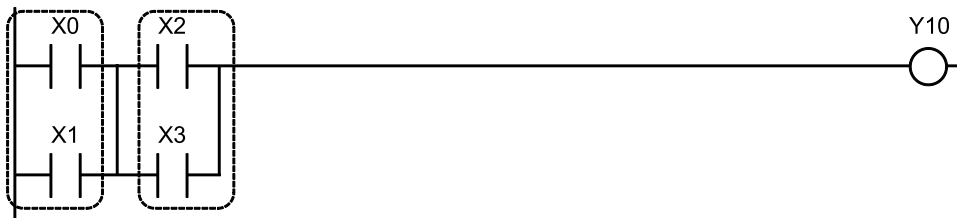

■ **Outline of operation**

- Blocks that were connected in parallel are connected in series.

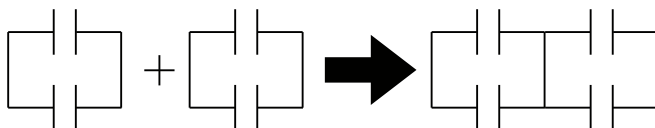

Blocks stack in series

- The start of each block begins with an **ST** instruction.

■ **Operation example**

Operation of instruction format description program

When X0 or X1 are ON, and X2 or X3 are ON, they are output to Y10.

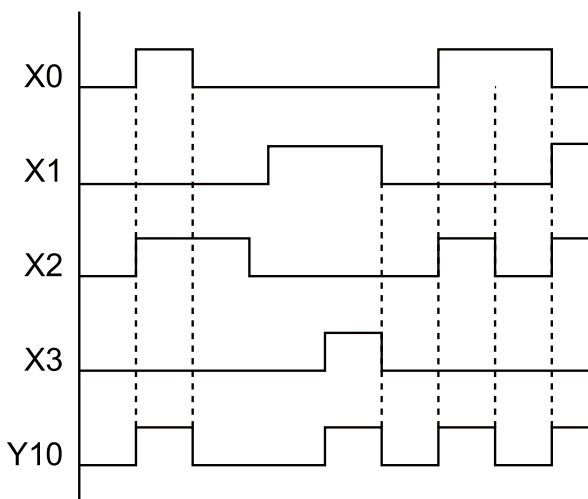
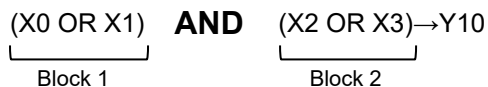

2.11 ANS (And Stack)

■ When blocks are consecutive

When blocks are consecutive, consider a block division as follows.

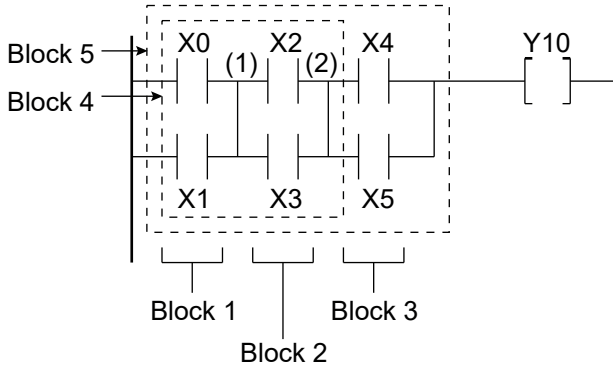

Block 5	Block 4	Block 1	ST X	0
			OR X	1
	Block 2	ST X	2	
		OR X	3	
	Block 3	ANS.....(1)		
		ST X	4	
		OR X	5	
		ANS.....(2)		
		OT Y	10	

2.12 ORS (OR Stack)

■ Instruction format

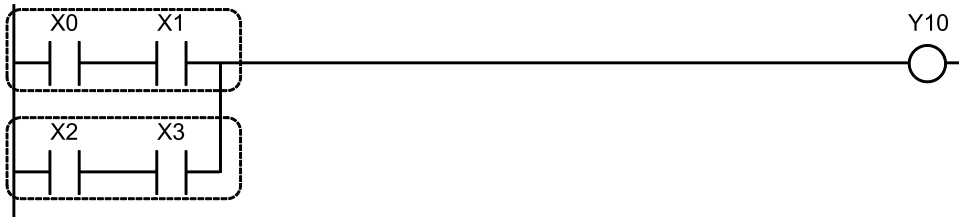

■ Outline of operation

- Serially connected blocks are connected in parallel.

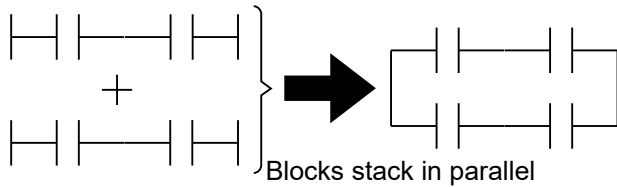

- The start of each block begins with an **ST** instruction.

■ Operation example

Operation of instruction format description program

When both X0 and X1 turn ON, or when both X2 and X3 turn ON, the result is output to Y10.

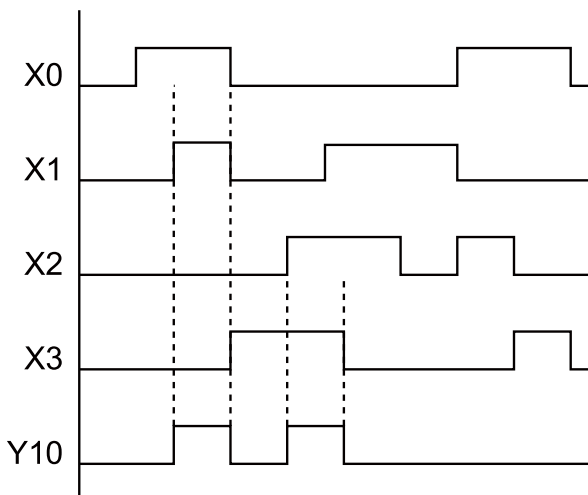
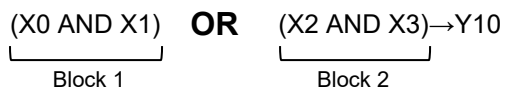

2.12 ORS (OR Stack)

■ When blocks are consecutive

When blocks are consecutive, consider a block division as follows.

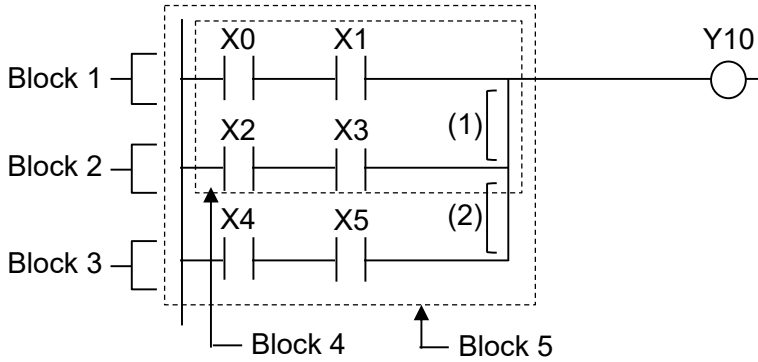

Block 5	Block 4	Block 1	ST	X	0		
			AN	X	1		
	Block 2		ST	X	2		
			AN	X	3		
			ORS			(1)	
	Block 3			ST	X	4	
				AN	X	5	
				ORS			(2)
				OT	Y	10	

2.13 PSHS, RDS, POPS (Push stack, Read stack, Pop stack)

■ Instruction format

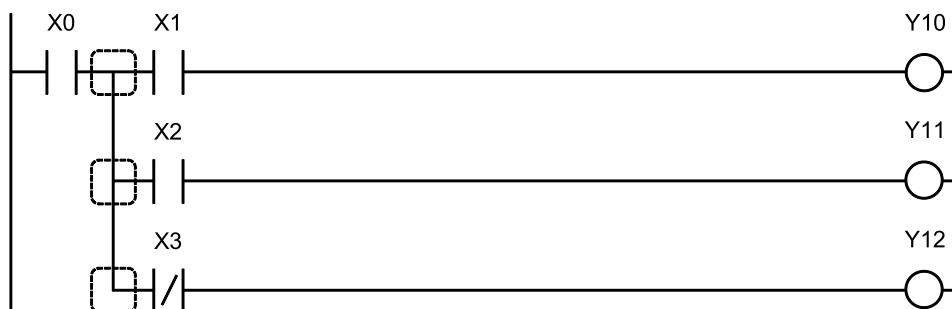

■ Outline of operation

These instructions can be used to store one operation result, read it, and perform multiple processes on it.

Instruction	Operation
PSHS	The operation result immediately before the PSHS instruction is stored and operation continues from the next step.
RDS	The operation result stored by the PSHS instruction is read and operation continues from the next step using this result.
POPS	The operation result stored by the PSHS instruction is read, operation continues from the next step using this result, and the operation result stored by the PSHS instruction is cleared.

This instruction is used when there is branching from a single contact, followed by another contact or contacts.

■ Operation example

Operation of instruction format description program

- 1) When X0 turns ON, the operation result is stored by the **PSHS** instruction, and if X1 is ON, the result is output to Y10.
- 2) The operation result is read by the **RDS** instruction, and if X2 is ON, the result is output to Y11.
- 3) The operation result is read by the **POPS** instruction, output to Y12 if X3 is OFF, and the operation result stored by the **PSHS** instruction is cleared.

2.13 PSHS, RDS, POPS (Push stack, Read stack, Pop stack)

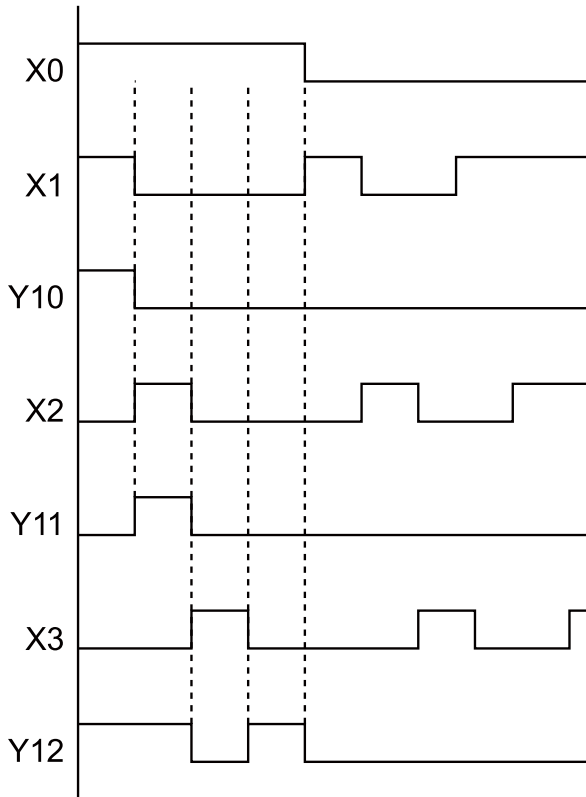

■ Programming precautions

- Use the **RDS** instruction when continuing to use the operation result, and use the **POPS** instruction when finishing. (The **POPS** instruction must be included.)

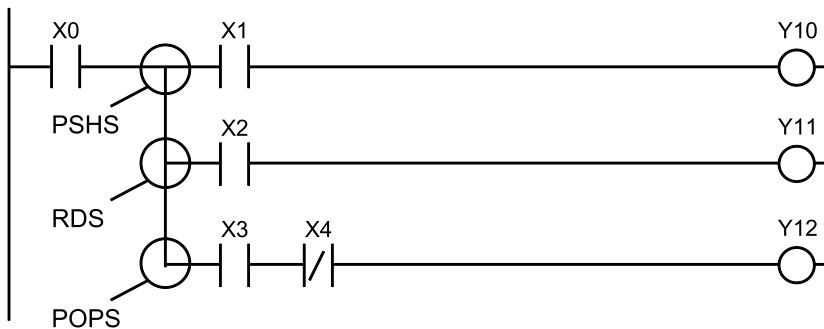

- The **RDS** instruction may be used consecutively as many times as required.

2.13 PSHS, RDS, POPS (Push stack, Read stack, Pop stack)

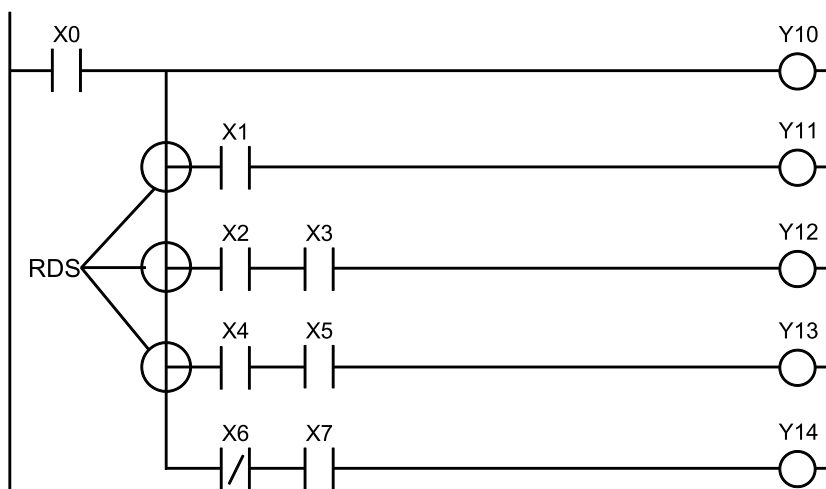

■ Precautions when using the PSHS instruction consecutively

- The **PSHS** instruction is limited to a maximum of eight consecutive uses.
- Please note that the program will not run correctly if this limit is exceeded.

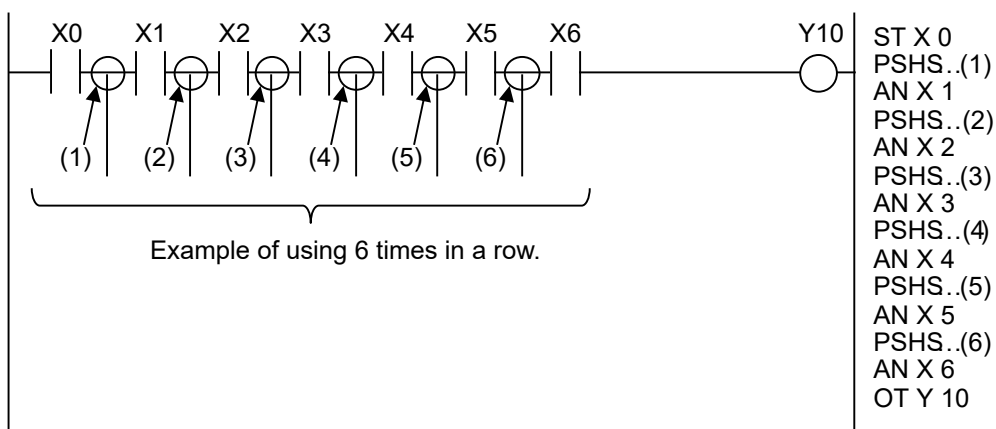

- If the **POPS** instruction is used when using the **PSHS** instruction consecutively, reading will take place in order beginning from the last data stored by the **PSHS** instruction.

2.13 PSHS, RDS, POPS (Push stack, Read stack, Pop stack)

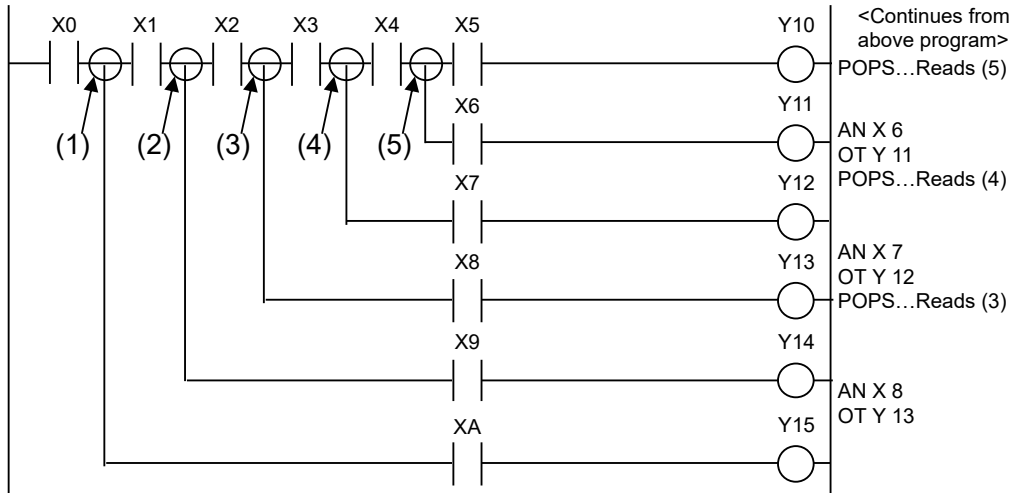

2.14 DF, DF/ (Rise Differential, Fall Differential)

■ Instruction format

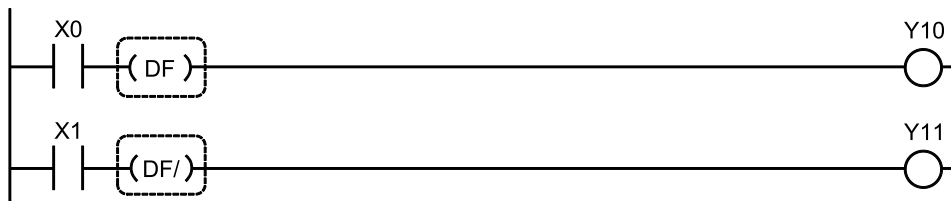

■ Outline of operation

Instruction	Operation
DF	When an execution condition changes from OFF to ON (rise), outputs only that 1 scan (differential output).
DF/	When an execution condition changes from ON to OFF (fall), outputs only that 1 scan (differential output).

- There is no limit to the number of times a differential instruction can be used.
- With a differential instruction, only the changes in the contact's ON/OFF status are detected, so if execution conditions are met (ON) from the start when switching into "RUN mode" or when powering on in "RUN mode", there will be no output.

<Example> Rise differential

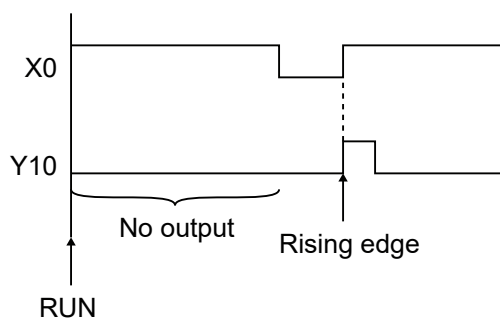

■ Operation example

Operation of instruction format description program

1. When X0 changes from OFF to ON (rise), only 1 scan is output to Y10.
2. When X1 changes from ON to OFF (fall), only 1 scan is output to Y11.

2.14 DF, DF/ (Rise Differential, Fall Differential)

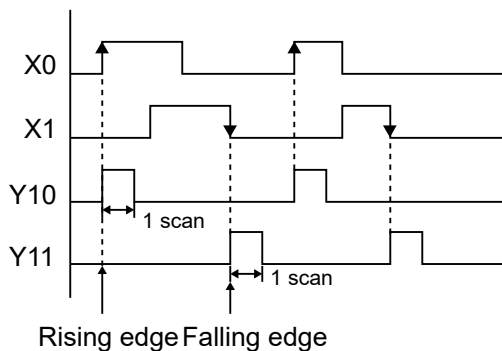

■ Related instructions

- The DFI instruction can be used. Only the first 1 scan is executed.

■ Programming precautions

- For the circuit shown below, the operation is as follows.

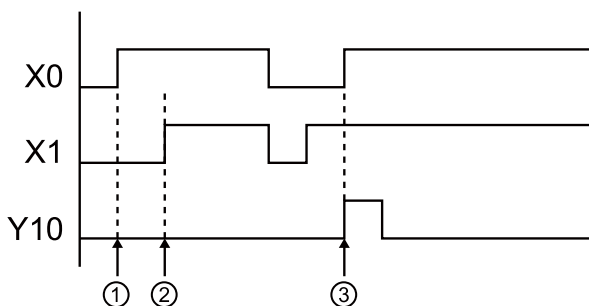
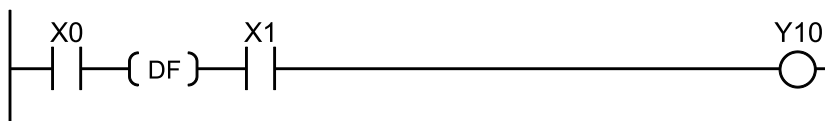

(1)	When X1 is OFF, Y10 remains OFF even if X0 rises.
(2)	When X0 is ON, Y10 remains OFF even if X1 rises.
(3)	When X1 is ON, if X0 rises, then Y10 turns ON for one scan.

- In the following program, the execution condition is ON from the beginning, so output cannot be obtained.

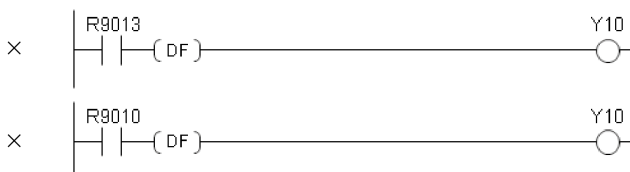

R9013 only turns ON during the first scan after RUN begins.

R9010 is a normally ON relay.

- In the following program, output can be obtained.

2.14 DF, DF/ (Rise Differential, Fall Differential)



R9014 turns ON from the second scan after RUN begins.

- Caution is required when using differential instructions in combination with instructions that change the order of execution of instructions (1 to 6 below), such as the **MC/MCE** instructions or the **JP/LBL** instructions.
 1. MC to MCE instructions
 2. JP to LBL instructions
 3. LOOP to LBL instructions
 4. CNDE instruction
 5. Step ladder instructions
 6. Subroutine instructions
- When a differential instruction is combined with an AND stack instruction or a pop stack instruction, take care that the syntax is correct.
- For the circuit shown below, the operation is as follows.

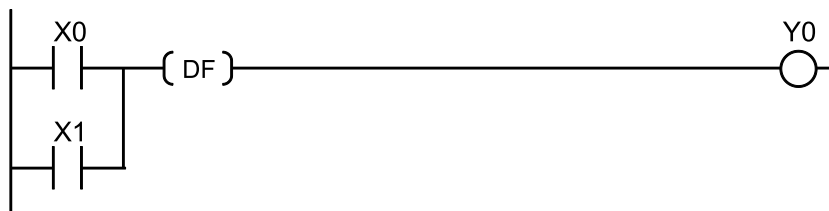

<Time chart>

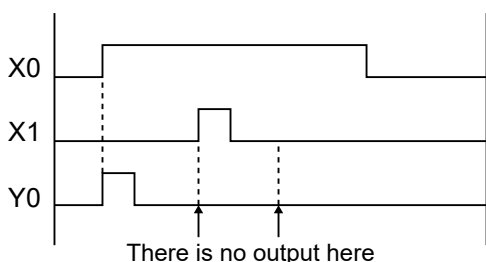

- To turn Y0 ON at the rise of either X0 or X1, program it as follows.



2.14 DF, DF/ (Rise Differential, Fall Differential)

<Time chart>

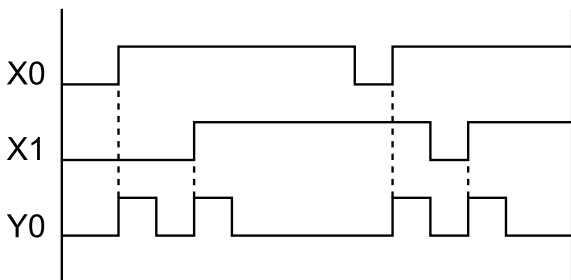

■ Examples of applying differential instructions

- Using differential instructions makes it easy to create and adjust programs.

<Example of application to a self-holding circuit>

- Using a differential instruction allows longer input signals to be supported.

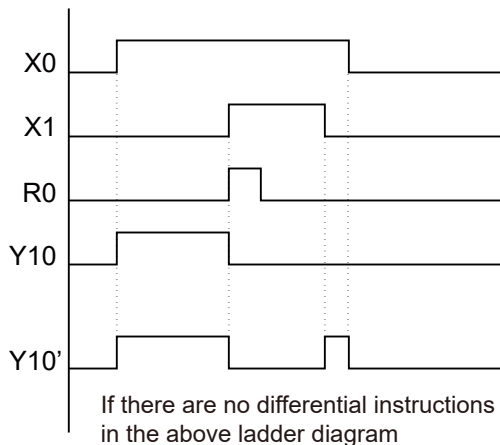
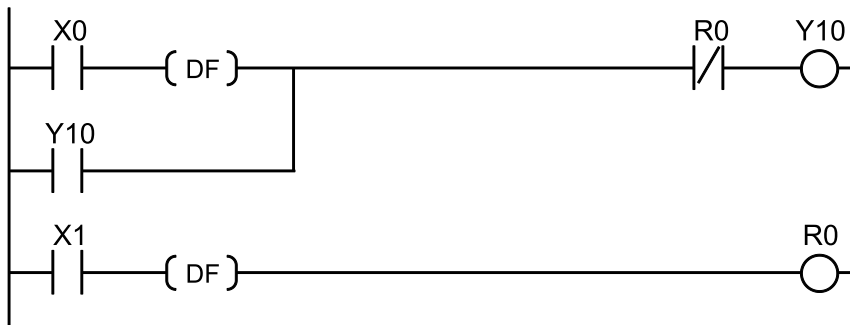

<Example of application to an alternating circuit>

- It can also be applied to alternating circuits that hold and release with a single signal.

<Example 1>

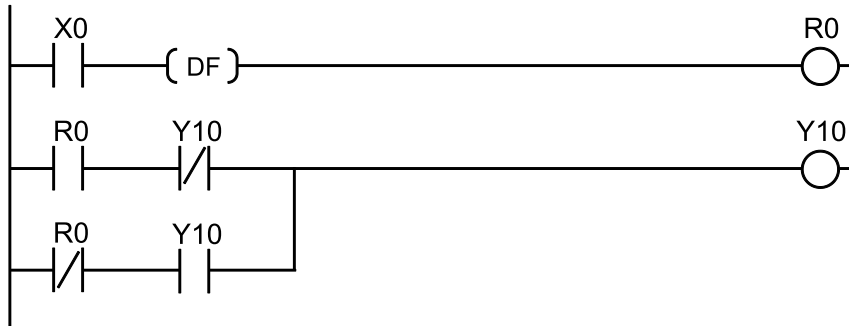

<Example 2>

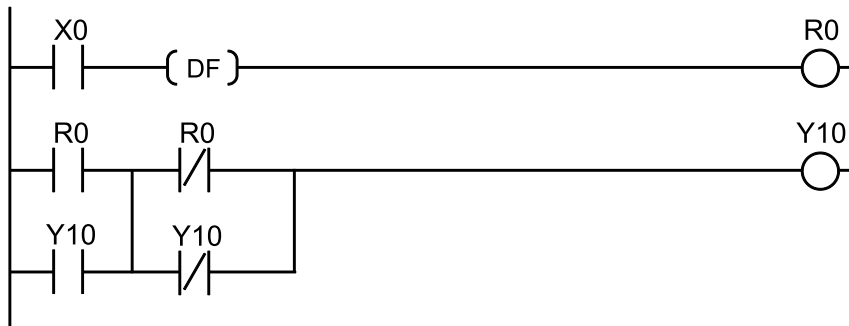

2.15 DFI [Rise Differential (initial execution type)]

2.15 DFI [Rise Differential (initial execution type)]

■ Instruction format

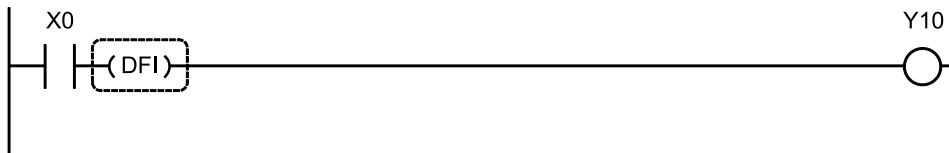

■ Outline of operation

Instruction	Operation
DFI	When an execution condition changes from OFF to ON (rise), outputs only that one scan (differential output).

- If the execution condition is met from before RUN starts, output (differential output) is performed at the first scan.
- There is no limit on the number of times the **DFI** instruction can be used.
- If it is possible for execution conditions to be met when switching into "RUN mode" or when powering on in "RUN mode", with the **DF** instruction, output cannot be obtained with the first scan, so using the **DFI** instruction, blocks that were connected in series are connected in parallel.

■ Operation example

Operation of instruction format description program

When X0 changes from OFF to ON (rise), only 1 scan is output to Y10.

- When execution condition is met after RUN starts

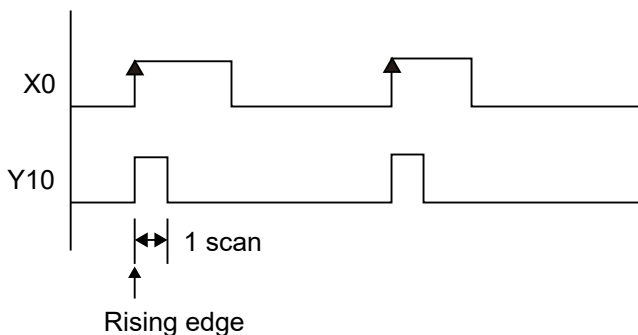

- When execution condition is met from the beginning

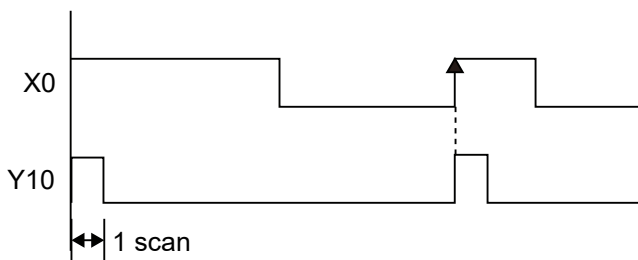

- Caution is required when using differential instructions in combination with instructions that change the order of execution of instructions (1 to 6 below), such as the **MC/MCE** instructions or the **JP/LBL** instructions.
 1. MC to MCE instructions
 2. JP to LBL instructions
 3. LOOP to LBL instructions
 4. CNDE instruction
 5. Step ladder instructions
 6. Subroutine instructions
- When a differential instruction is combined with an AND stack instruction or a pop stack instruction, take care that the syntax is correct.

2.16 SET, RST (Set, Reset)

2.16 SET, RST (Set, Reset)

■ Instruction format

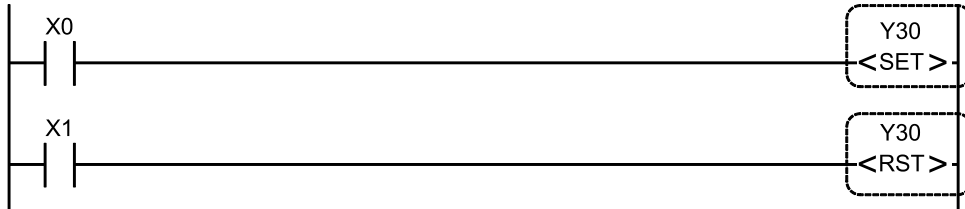

■ Instruction list

Instruction	Description
SET	Output coil
RST	Output coil

■ Devices that can be specified (indicated by ●)

Operands	X	Y	R	T	C	L	Index modifier
SET		●	●			●	●
RST		●	●			●	●

■ Outline of operation

Instruction	Operation
SET	When the execution condition turns ON, the output turns ON and the state is held regardless of a change in the state of the execution condition.
RST	When the execution condition turns ON, the output coil turns OFF and the OFF state is held regardless of a change in the state of the execution condition.

- The same output coil can be specified as many times as desired for the **SET** and **RST** instruction output destinations. (Even if a total check is run, this is not handled as a syntax error.)

■ Operation example

Operation of instruction format description program

1. When X0 turns ON, Y30 turns ON and is held in that state.
2. When X1 turns ON, Y30 turns OFF and is held in that state.

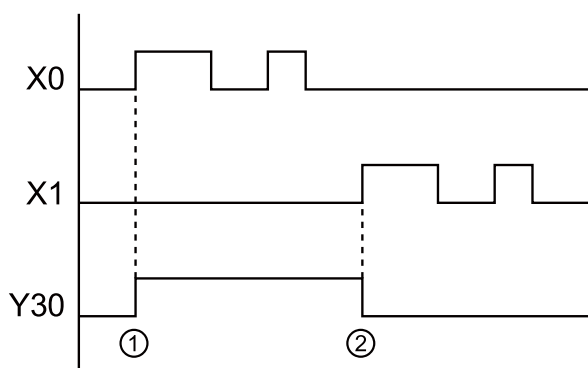

■ Processing mechanisms when the SET and RST instructions are used

- The output content is overwritten with each step during processing of the operation.

e.g. Processing when X0, X1, and X2 are all turned ON

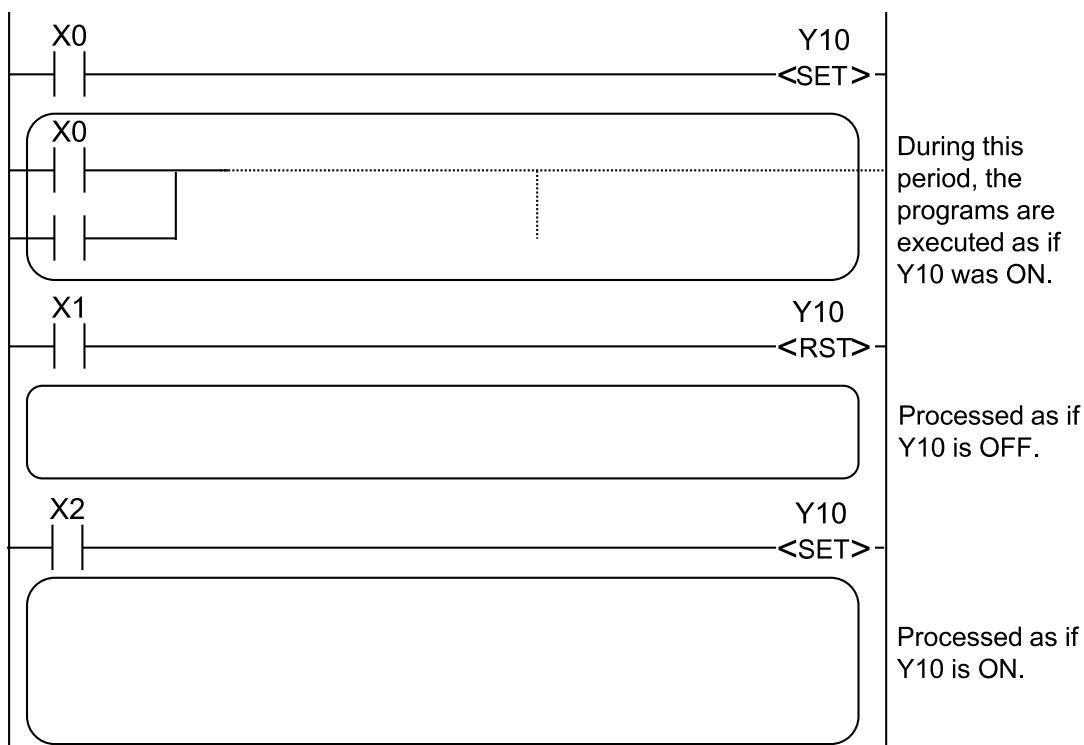

- I/O refresh is performed when an ED instruction is executed; therefore, the data actually output is determined by the final operation result. In the above example, output occurs with Y10 ON.
- To output a result while the operation is still in progress, use the partial I/O refresh instruction (F143).

■ Precautions for programming

- The output destination of a SET instruction retains its state even during the operation of an MC instruction.

2.16 SET, RST (Set, Reset)

- The output destination of a SET instruction is reset when switching from "RUN" to "PROG. mode" and when the power is turned OFF. (However, if an internal relay set as a hold type is specified as the output destination, reset does not take place.)

■ SET and RST instructions used as a set with differential instructions

- Placing a DF differential instruction before the SET and RST instructions makes program development and adjustment easier.
- This is particularly effective when the same output destination is used in several places in the program.

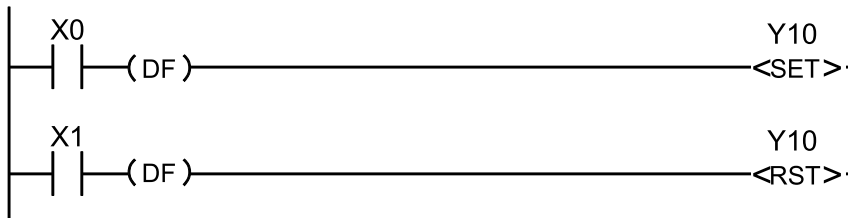

2.17 DSET/DRST (Direct Set/Direct Reset)

■ Instruction format

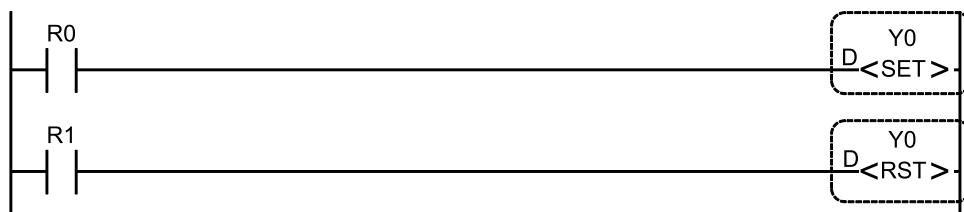

■ Instruction List

Instruction	Description
DSET	Output coil
DRST	Output coil

■ Devices that can be specified (indicated by ●)

Operands	X	Y	R	T	C	L	Index modifier
DSET		●					●
DRST		●					●

■ Outline of operation

Instruction	Operation
DSET	When the execution condition is ON, the specified output contact is turned ON, and ON is output to external output. Regardless of execution condition status changes, the ON status is held.
DRST	When the execution condition is ON, the specified output contact is turned OFF, and OFF is output to external output. Regardless of execution condition status changes, the OFF status is held.

- You can specify the same output coil for the **DSET** and **DRST** instruction output destination as many times as required. Even if Total Check is implemented, it is not treated as a syntax error.

■ Operation Example

Operation of instruction format description program

- When R0 turns ON, external output is turned ON and the ON status is maintained.
- When R1 turns ON, external output is turned OFF and the OFF status is maintained.

■ Precautions for programming

- If the contact is outside the permissible range, an operation error will result.
- Even if the **MC** instruction is in progress, the DSET instruction output destination holds that status.
- The DSET instruction output destination will reset when "RUN MODE" switches to "PROG. MODE" or when the device is powered OFF.

2.17 DSET/DRST (Direct Set/Direct Reset)

■ Comparison of SET instructions and DSET instructions

- Compared to SET instructions, DSET instructions are capable of high-speed responses.

<SET instruction>

- Ladder diagram

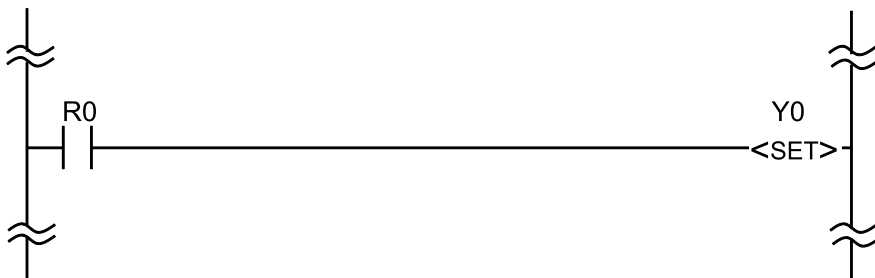

- Timing chart

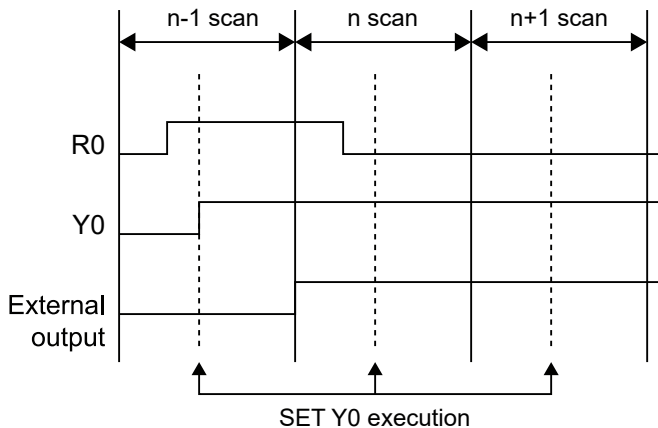

<DSET instruction>

- Ladder diagram



• **Timing chart**

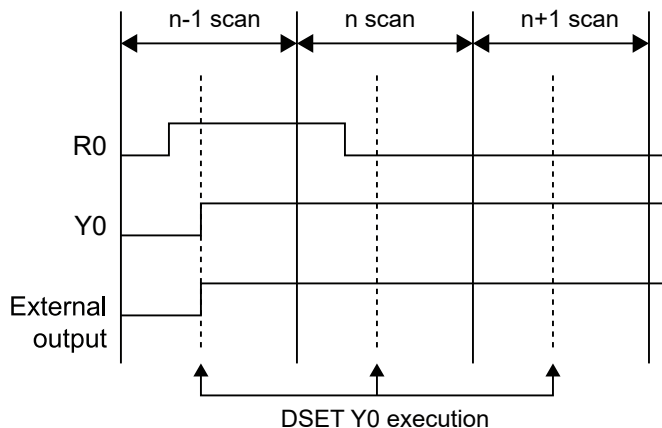

■ **Comparison of RST instructions and DRST instructions**

- Compared to RST instructions, DRST instructions are capable of high-speed responses.

<RST instruction>

• **Ladder diagram**

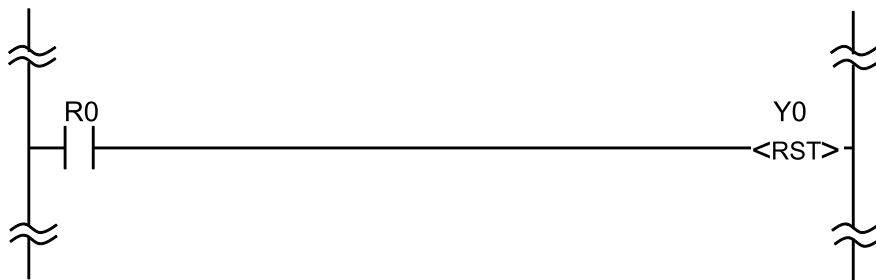

• **Timing chart**

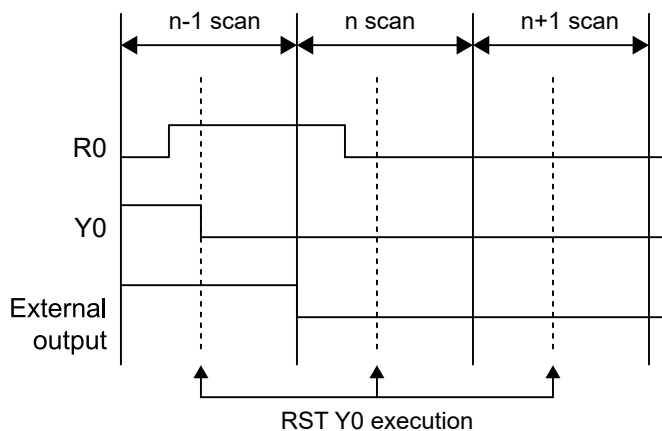

<DRST instruction>

2.17 DSET/DRST (Direct Set/Direct Reset)

- Ladder diagram

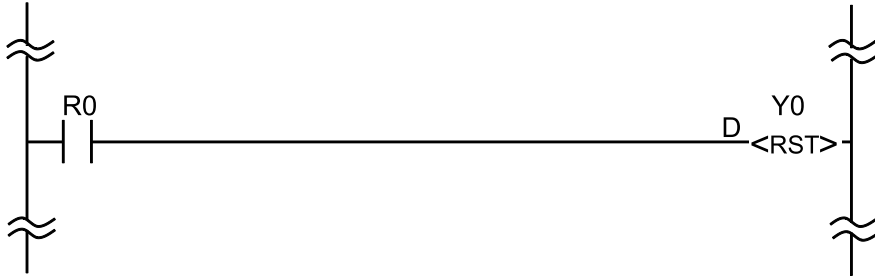

- Timing chart

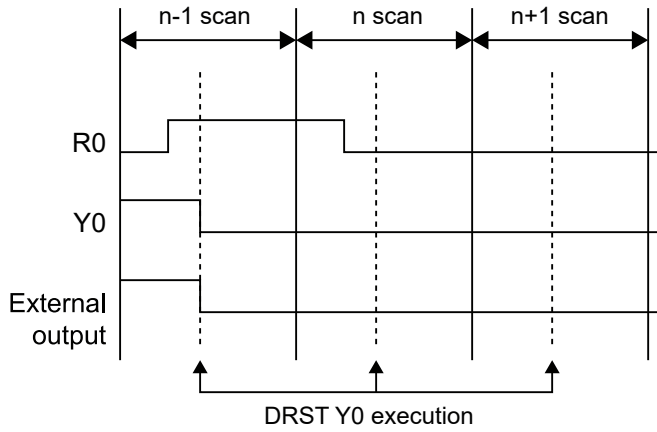

2.18 KP (Keep)

■ Instruction format

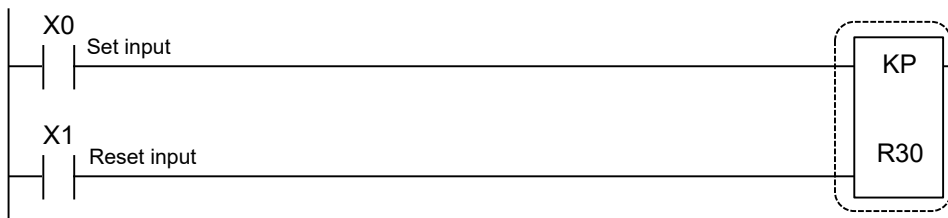

■ Instruction list

Instruction	Description
KP	Output coil

■ Devices that can be specified (indicated by ●)

Operands	X	Y	R	T	C	L	Index modifier
KP		●	●			●	

■ Outline of operation

- When the set input turns ON, output of the specified coil turns ON and is held in that state.
- When the reset input turns ON, the hold state is released.
- The output is held in an ON state until the reset input turns ON, regardless of the ON/OFF state of the set input.
- If the set input and reset input turn ON simultaneously, the reset input takes priority. Serially connected blocks are connected in parallel.

■ Operation example

Operation of instruction format description program

- 1) When X0 turns ON, output of the specified coil turns ON and is held in that state.
- 2) When X1 turns ON, the hold state is released.

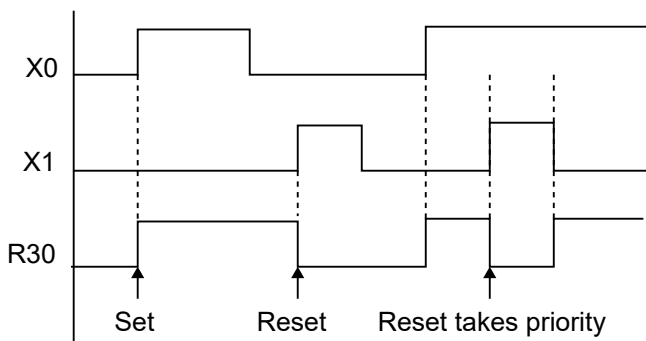

2.18 KP (Keep)

■ Precautions for programming

- The state of the output destination is held even during operation of the **MC** instruction.
- The output is reset when switching from "RUN mode" to "PROG. mode" and when the power is turned OFF. (However, if an internal relay set as a hold type is specified as the output destination, reset does not take place.)

2.19 DKP (Direct Keep)

■ Instruction format

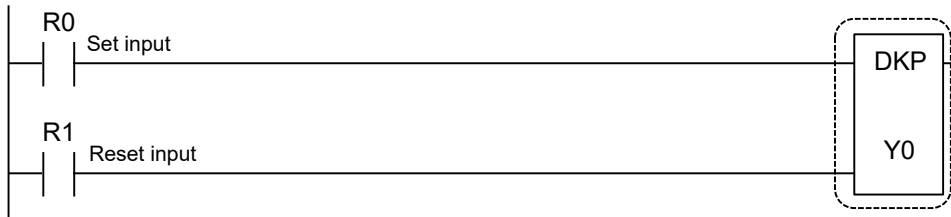

■ Instruction list

Instruction	Description
DKP	Output coil

■ Devices that can be specified (indicated by ●)

Operands	X	Y	R	T	C	L	Index modifier
DKP		●					

■ Outline of operation

- When set input is ON, output from the specified coil is ON, and external output is also ON. Additionally, this status is retained.
- When reset input is ON, output from the specified coil is OFF, and external output is also OFF. Additionally, retention is canceled.
- During retention, regardless of set input ON/OFF status, output is retained until there is reset input.
- If the set input and reset input turn ON simultaneously, the reset input takes priority.

■ Operation example

Operation of instruction format description program

- When R0 turns ON, external output is turned ON and the ON status is maintained.
- When R1 turns ON, external output is turned OFF and the OFF status is maintained.

■ Precautions for programming

- If the contact is outside the permissible range, an operation error will result.
- If the same output coil is specified, a syntax error (duplicate output) will occur.
- The state of the output destination is held even during operation of the **MC** instruction.
- When switching from "RUN mode" to "PROG. mode" and at power OFF, the output destination is reset.

■ Comparison of KP instruction and DKP instruction

- The DKP instruction is capable of faster responsiveness than the KP instruction.

<KP instruction>

2.19 DKP (Direct Keep)

- Ladder diagram

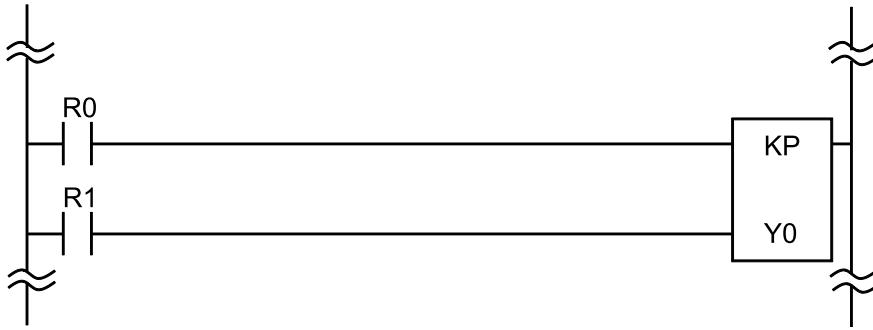

- Timing chart

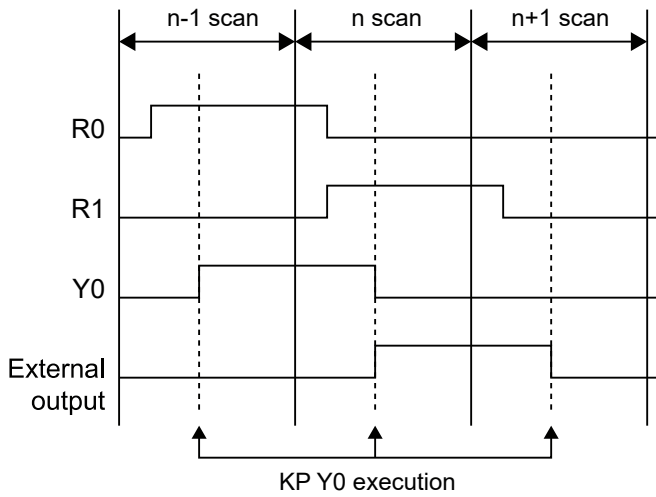

<DKP instruction>

- Ladder diagram

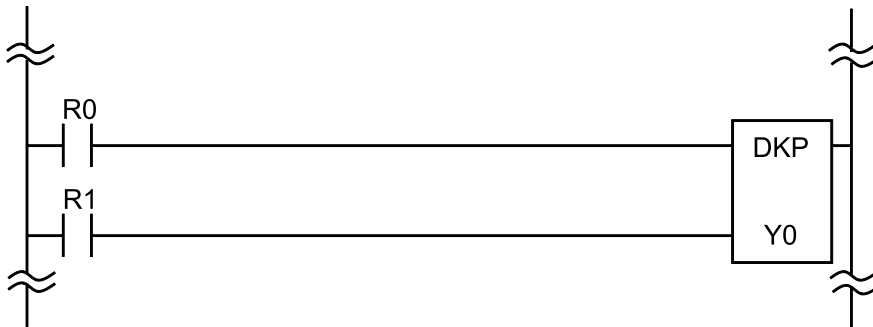

- Timing chart

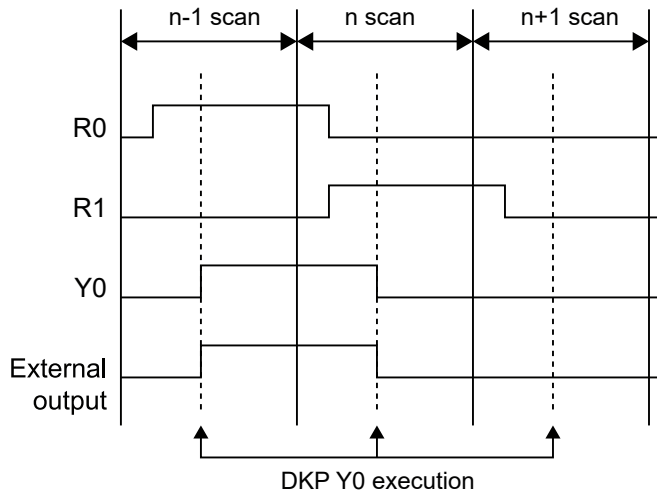

2.20 NOP

■ **Instruction format**

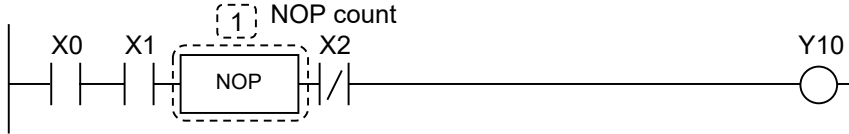

■ **Outline of operation**

- This instruction has no effect on the operation results to that point. The same operation is performed even without a **NOP** instruction.
- A **NOP** instruction can be used to make the program easier to read when checking or correcting.
- Write a **NOP** instruction (overwrite the previous instruction) when you want to delete an instruction without changing addresses.
- Insert a **NOP** instruction when you want to move the addresses of one part of a program without changing the program.
- For example, this is a convenient means of breaking a long program into several blocks.

e.g.

To move the starting point of a program block from address 39 to address 40, insert a **NOP** instruction at address 39.

Address		Address	
36	ST X0	36	ST X0
	OR X1		OR X1
	OT Y10		OT Y10
39	ST X2	39	NOP
40	AN X3	40	ST X2
41	OT R20	41	AN X3
42	ST R2	42	OT R20
43	DF	43	ST R2
44	ST X3	44	DF
	{	45	ST X3
			}

→ Want to start from address 40
 ← Insert NOP

■ **Deleting NOP instructions**

After creating a program, it is possible to delete all **NOP** instructions in a program by using the programming tool.

3 Basic Function Instructions

3.1 TML/TMR/TMX/TMY (0.001 s, 0.01 s, 0.1 s, 1 s On-delay Timer)	3-2
3.2 F137 STMR (16-bit, 0.01 s On-delay Timer).....	3-9
3.3 F183 DSTM (32-bit, 0.01 s On-delay Timer).....	3-12
3.4 CT [Counter (Preset Subtraction Expression)].....	3-16
3.5 F118 UDC (Up/Down Counter)	3-23
3.6 SR (Shift Register)	3-26
3.7 F119 LRSR (Left/Right Shift Register)	3-29
3.8 F182 FILTR (Time Literal Process).....	3-32

3.1 TML/TMR/TMX/TMY (0.001 s, 0.01 s, 0.1 s, 1 s On-delay Timer)

3.1 TML/TMR/TMX/TMY (0.001 s, 0.01 s, 0.1 s, 1 s On-delay Timer)

■ Instruction format

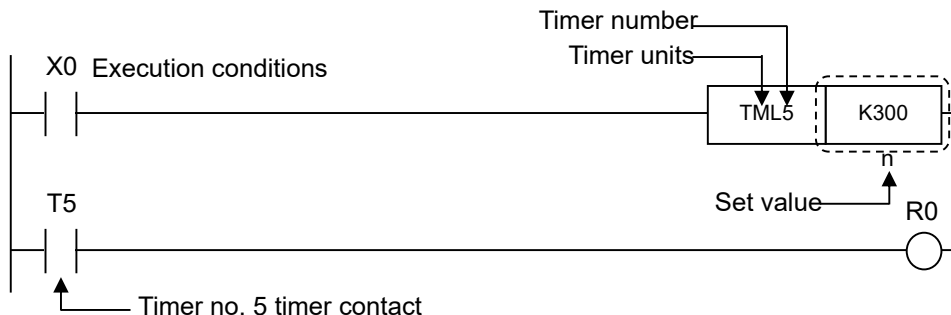

■ Instruction list

Instruction	Description
n	Timer set value

■ Devices that can be specified (indicated by ●)

Operands	WX	WY	WR	WL	SV	EV	DT	LD	I	SWR	SDT	Constant				Index modifier	Integer Device
												K	H	M	f		
n	●	●	●	●	●	●	●	●		●	●	●					

■ Outline of operation

- The timer is a non-hold type that is reset when the power is turned off or when switching from "RUN mode" to "PROG. mode". (If the operating state must be held, set system register No. 6. In that case, be sure to use a battery.)
- When the execution condition turns ON, the set time decrements until the elapsed value becomes 0, at which point timer contact Tn (n is the timer contact number) turns ON.
- If the execution condition turns OFF during while the set time is decrementing, the operation is interrupted and the elapsed value is reset (cleared to 0).
- The OT instruction can also be written immediately after a timer coil.

■ Setting the timer period

1. The timer set time is (timer unit) × (timer set value).
2. The timer set value [n] is set as a decimal constant in the range of K1 to K32767.

TML	0.001 to 32.767 seconds in units of 0.001 second
TMR	0.01 to 327.67 seconds in units of 0.01 second
TMX	0.1 to 3276.7 seconds in units of 0.1 second
TMY	1 to 32,767 seconds in units of 1 second

e.g. When K43 is set by TMX, the set time is $0.1 \times 43 = 4.3$ seconds.
 When K500 is set by TMR, the set time is $0.01 \times 500 = 5$ seconds.

3.1 TML/TMR/TMX/TMY (0.001 s, 0.01 s, 0.1 s, 1 s On-delay Timer)

■ Precautions for programming

- As subtraction operations are performed during operation, create the program so that it operates once during one scan. If an operation is performed more than once during one scan or cannot be performed even once due to an interrupt processing program or jump/loop instruction, correct results cannot be obtained.
- When combining a timer instruction with an AND stack instruction or a POP stack instruction, be careful that the programming is correct.

■ Timer operation mechanism

The following are examples of specifying a K constant as the set value. See below for the operation when specifying the set value area.

1. When the mode is switched to "RUN mode" or when the power is turned ON in "RUN mode", the timer set value is transferred to the set value area "SV" of the same number.

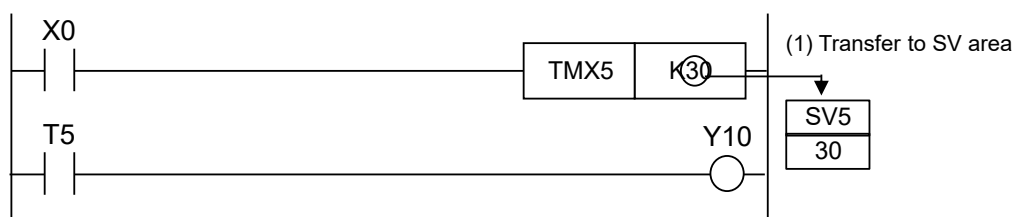

2. When the timer execution condition rises from OFF to ON, the timer set value is transferred from the set value area "SV" to the elapsed value area "EV" of the same number. (The same operation is performed when switching to "RUN mode" while the execution condition is ON.)
3. For each scan, if the execution condition is ON, the timer decrements by the value in the elapsed value area "EV".

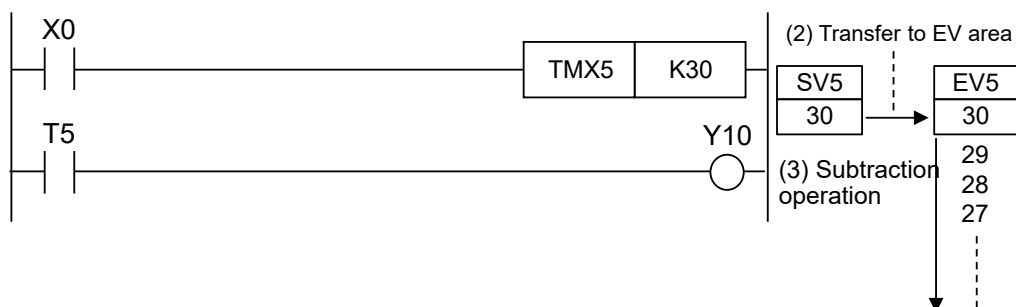

4. When the value of the elapsed value area "EV" becomes 0, the timer contact "T" of the same number turns ON.

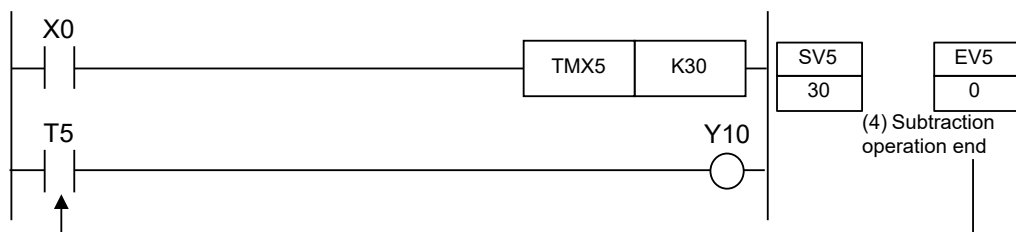

3.1 TML/TMR/TMX/TMY (0.001 s, 0.01 s, 0.1 s, 1 s On-delay Timer)

■ Examples of timer instruction application

<Timer series connection>

● Ladder diagram

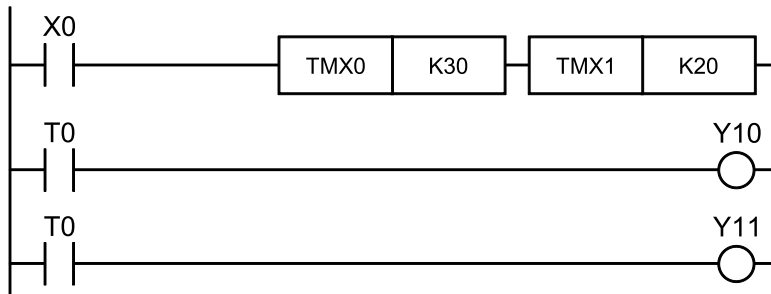

● Timing chart

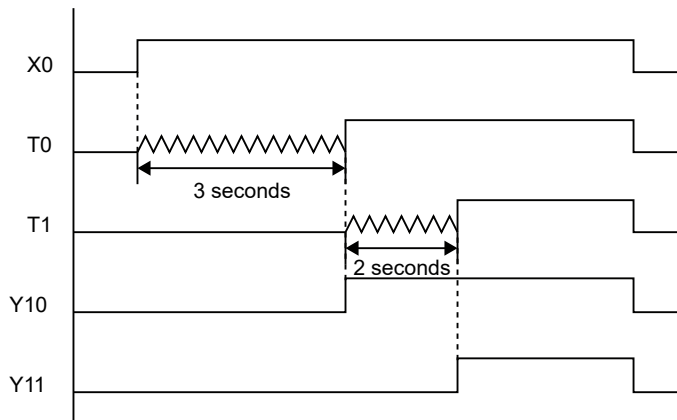

<Timer parallel connection>

● Ladder diagram

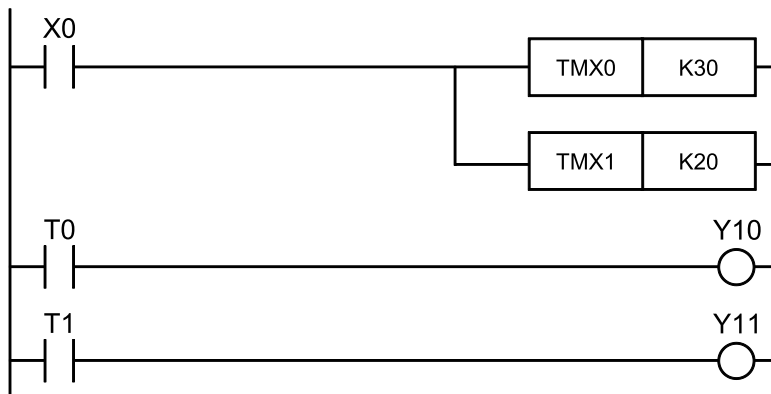

3.1 TML/TMR/TMX/TMY (0.001 s, 0.01 s, 0.1 s, 1 s On-delay Timer)

• Timing chart

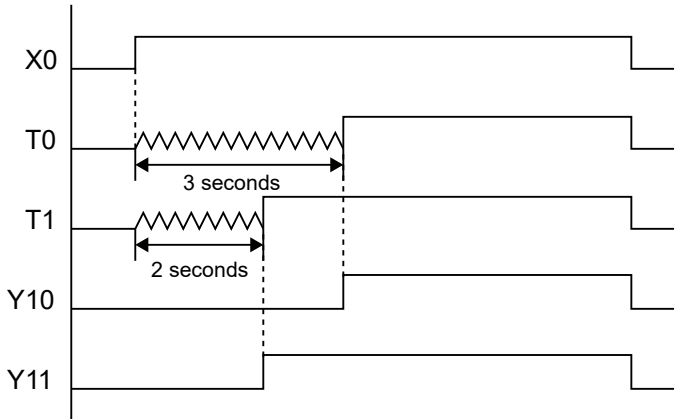

■ How to directly specify the set value area No. for the timer set value

- The set value area number can be specified directly as the set value [n].

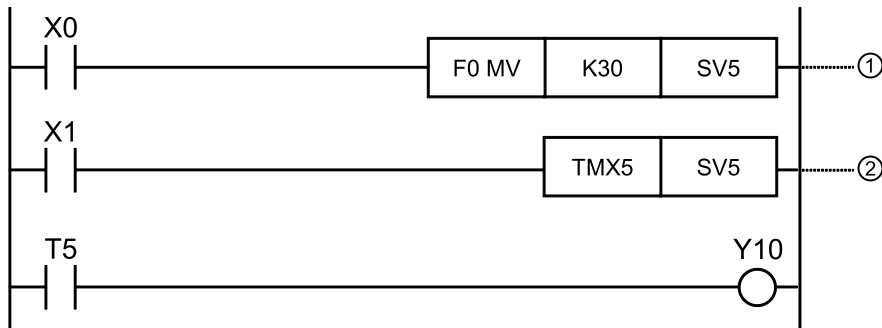

The above program in which SV5 is specified as the set value operates as follows.

1. When execution condition X0 turns ON, the data transfer instruction (F0 MV) is executed and SV5 is set to K30.
 2. When execution condition X1 turns ON, the set value is set to 30 and the decrement operation starts.
- Set the number of the set value area "SV" specified in [n] to be the same as the timer number.

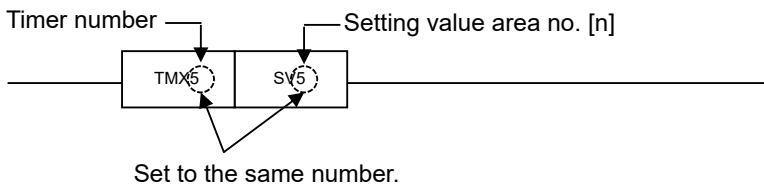

- Even if the value in the set value area "SV" is changed during the subtraction operation, the subtraction operation will continue from the value before the change.
Timer operation starts with the changed value the next time the execution condition changes from OFF to ON after the decrement operation is completed or interrupted.
- The set value area SV is normally a non-hold type that is reset when the power is turned off or when switching from "RUN mode" to "PROG. mode" .

3.1 TML/TMR/TMX/TMY (0.001 s, 0.01 s, 0.1 s, 1 s On-delay Timer)

If the SV value was changed while in RUN mode and that value is to be used as a set value without being reset the next time the power supply is turned on or when switching from "PROG. Mode" to "RUN mode", set the value to a hold type by using system register no. 6.

■ Timer operation when the set value area number is directly specified

1. When the execution condition for a high-level instruction is ON, the value is set in the set value area "SV".

The following diagram shows an example of using the F0 MV instruction.

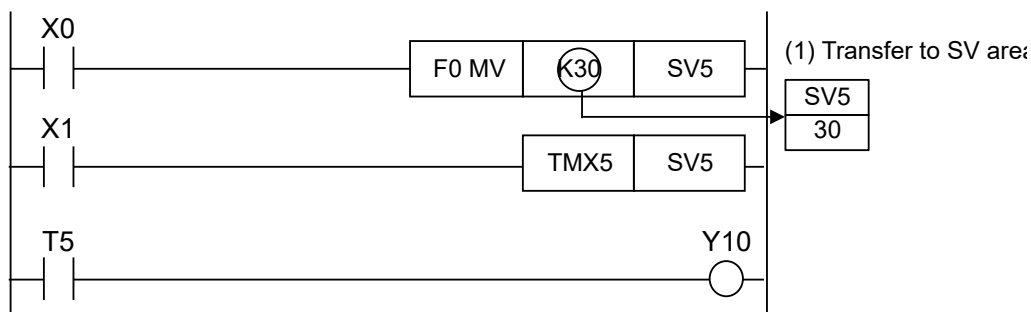

2. When the timer execution condition rises from OFF to ON, the timer set value is transferred from the set value area "SV" to the elapsed value area "EV" of the same number. (The same operation is performed when switching to "RUN mode" while the execution condition is ON.)
3. For each scan, if the execution condition is ON, the timer decrements by the value in the elapsed value area "EV".

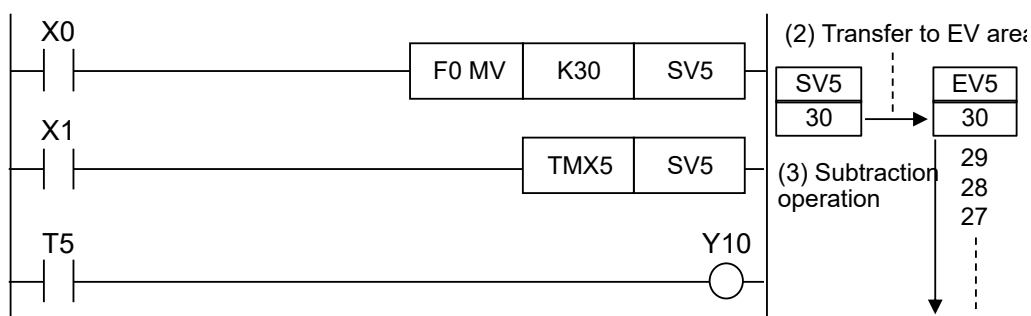

4. When the value of the elapsed value area "EV" becomes 0, the timer contact "T" of the same number turns ON.

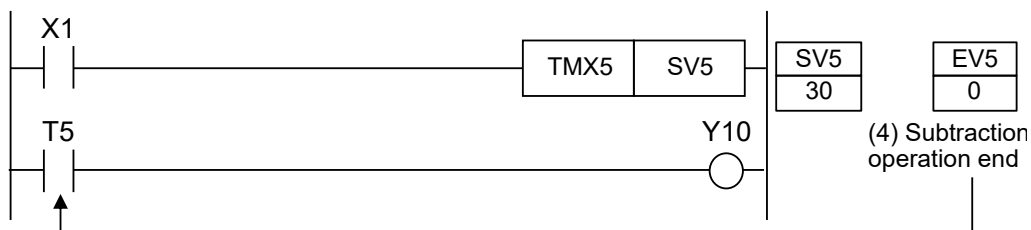

■ Examples of applying direct specification of set value area numbers

Example 1) Changing set values based on specified conditions

The set value is K50 when X0 is ON and K30 when X1 is ON.

3.1 TML/TMR/TMX/TMY (0.001 s, 0.01 s, 0.1 s, 1 s On-delay Timer)

- **Ladder diagram**

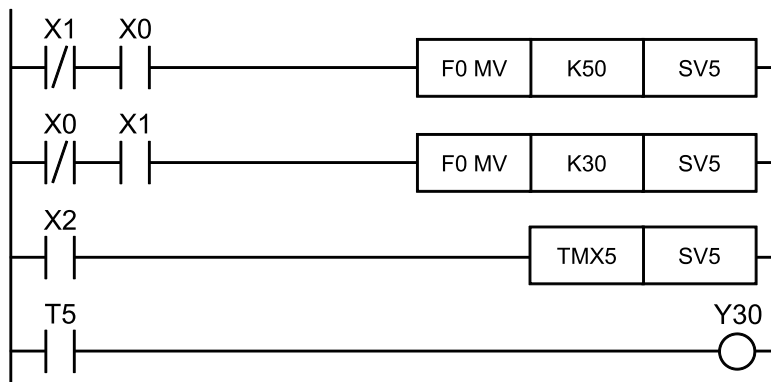

- **Timing chart**

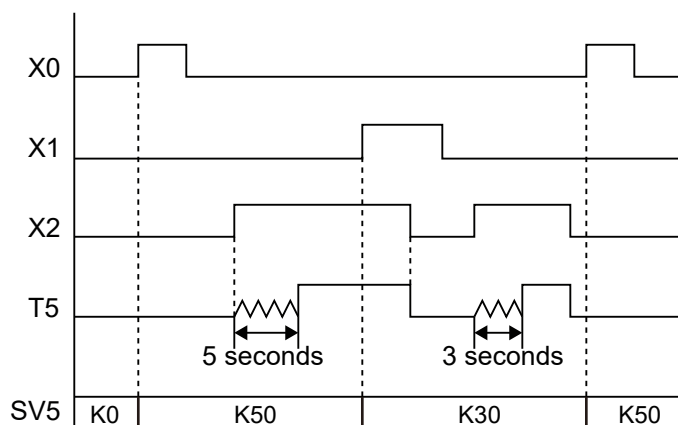

Example 2) Setting a set value from external digital switches

The BCD data of the digital switches connected to X0 through XF is converted and becomes the set value.

- **Connection example**

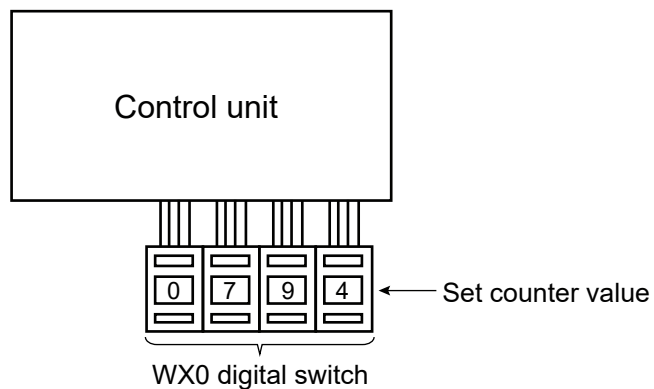

3.1 TML/TMR/TMX/TMY (0.001 s, 0.01 s, 0.1 s, 1 s On-delay Timer)

- Ladder diagram

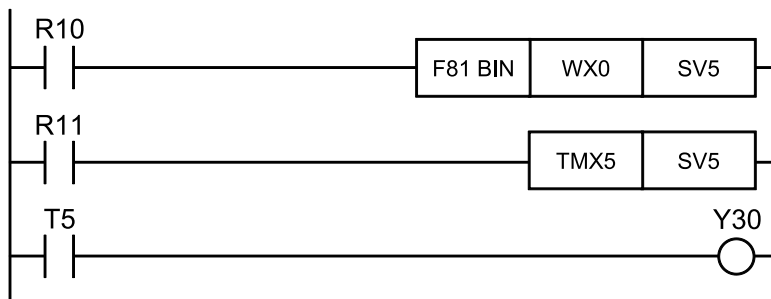

3.2 F137 STMR (16-bit, 0.01 s On-delay Timer)

■ Instruction format

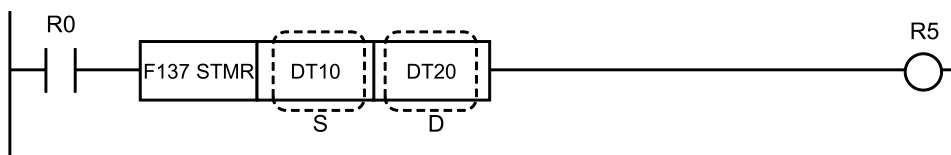

■ Instruction list

Instruction	Description
S	Area storing the setting value, or constant data
D	Process value area

■ Devices that can be specified (indicated by ●)

Operands	WX	WY	WR	WL	SV	EV	DT	LD	I	SWR	SDT	Constant				Index modifier	Integer Device
												K	H	M	f		
S	●	●	●	●	●	●	●	●	●	●	●	●					
D		●	●	●	●	●	●	●	●								

■ Outline of operation

Operates as an ON-delay timer in units of 0.01 seconds. When the internal relay is ON, the setting time is subtracted, and the special internal relay R900D turns ON when the process value [D] becomes 0. (It is OFF when the internal relay is OFF and during subtraction.)

■ Operation example

Operation of instruction format description program

The internal relay is executed, the auxiliary timer is activated, and when a time equal to the value stored in [DT10] × 0.01 seconds has elapsed, R5 turns ON.

- When the internal relay is OFF, the process value area is cleared to 0. The relay in use for the OT instruction turns OFF.
- When the time of the special internal relay R900D is up, it turns ON. It is also possible to use R900D as a timer contact. (It is OFF when the internal relay is OFF and during subtraction.)

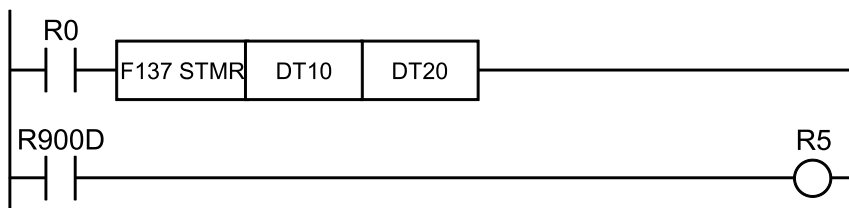

Operation is the same as the above example.

3.2 F137 STMR (16-bit, 0.01 s On-delay Timer)

■ Setting the timer period

1. The timer period is $0.01 \times [\text{timer set value}]$.
2. The timer set value is set with a K constant within the range of K1 to K32767.

"STMR" ranges from 0.01 to 327.67 seconds, in units of 0.01 second.

e.g. If the set value is K500, the set time is $0.01 \times 500 = 5$ seconds.

■ Precautions for programming

- Ensure that the specifications of the area storing the set value and the process value area do not overlap with other timer/counter instructions or operation memory areas of high-level instructions.
- As subtraction operations are performed during operation, create the program so that it operates once during one scan.
(During interrupt processing programs or with jump/loop instructions, a correct result cannot be obtained if there are multiple or no operations during one scan.)

■ How the auxiliary timer works

1. When the internal relay turns from OFF to ON, the set value specified by [S] is transferred to the process value area [D].

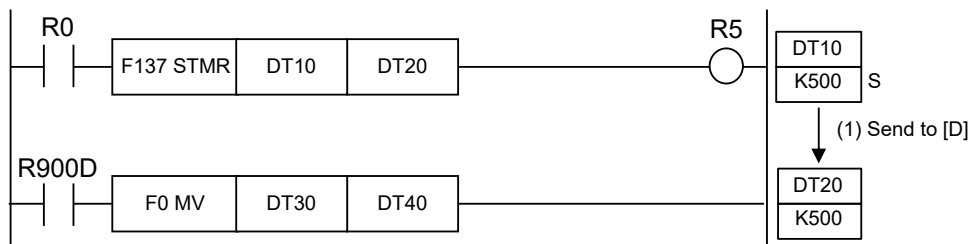

2. With each scan, if the internal relay is ON, the value of the process value area [D] is subtracted.

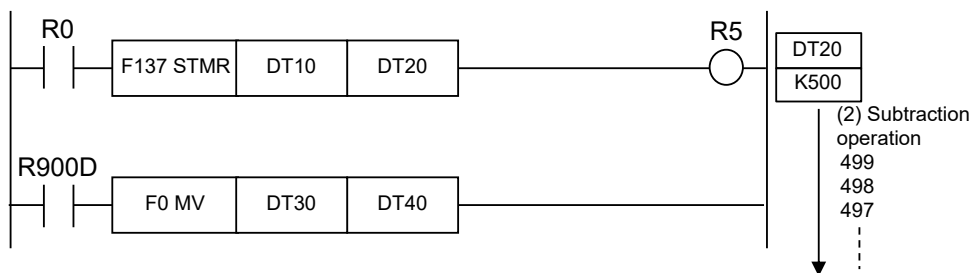

3. If the value of the process value area [D] becomes 0, then the relay in use for the next OT instruction turns ON. The special internal relay R900D also turns ON.

3.2 F137 STMR (16-bit, 0.01 s On-delay Timer)

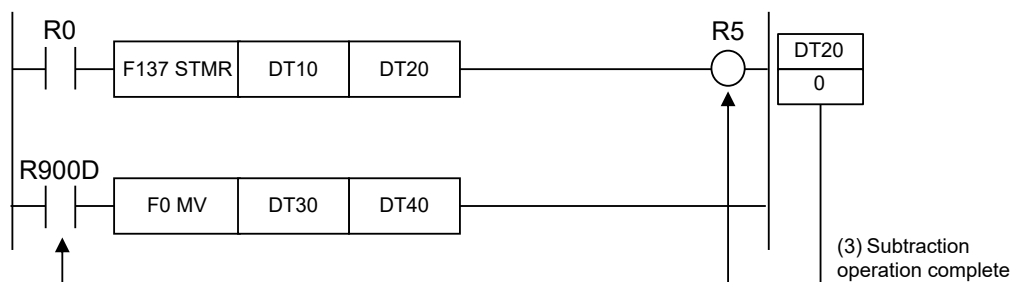

■ Precautions when using R900D

When using multiple auxiliary timers with R900D, ensure that R900D is used on the line after the auxiliary timer instruction.

<Example>

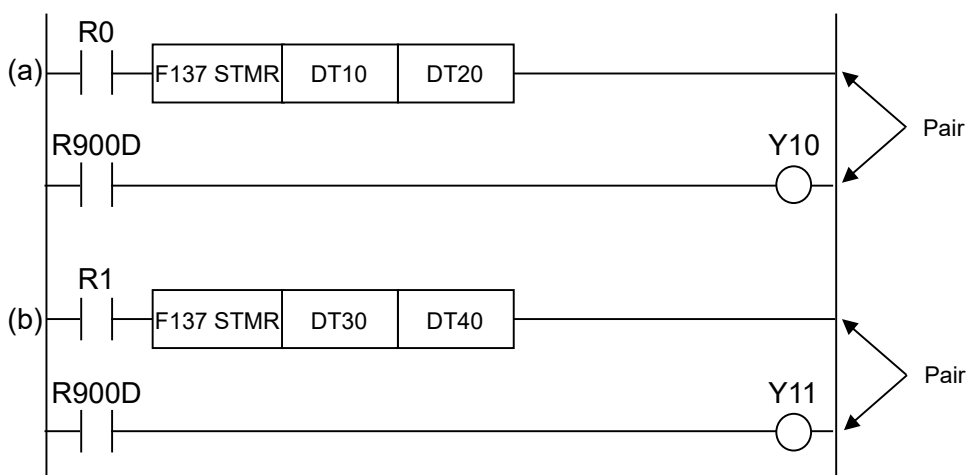

When the time is up for timer (a), activated by R0:ON, Y0 turns ON. When the time is up for timer (b), activated by R1:ON, Y1 turns ON.

- A correct operation cannot be obtained if specified as shown below.

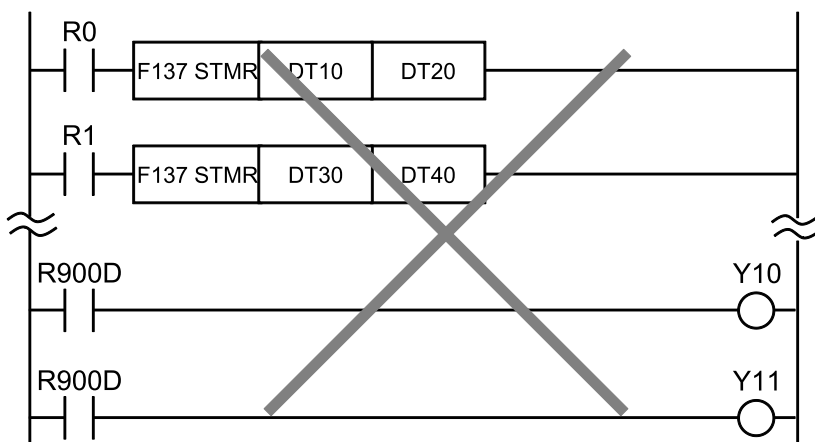

3.3 F183 DSTM (32-bit, 0.01 s On-delay Timer)

3.3 F183 DSTM (32-bit, 0.01 s On-delay Timer)

■ Instruction format

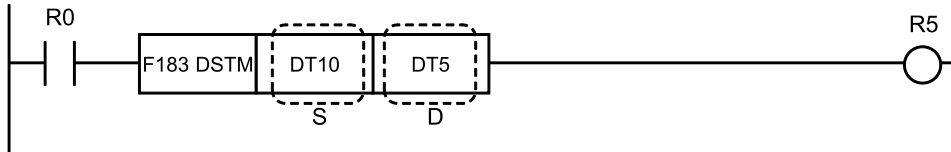

■ Instruction list

Instruction	Description
S	Area storing the setting value, or constant data
D	Process value area

■ Devices that can be specified (indicated by ●)

Operands	WX	WY	WR	WL	SV	EV	DT	LD	I	SWR	SDT	Constant				Index modifier	Integer Device
												K	H	M	f		
S	●	●	●	●	●	●	●	●	●	●	●	●					
D		●	●	●	●	●	●	●									

■ Outline of operation

- This instruction operates as a 32-bit addition expression ON-delay timer set in 0.01-second units.
- When the internal relay turns ON, addition of the elapsed time is performed. When the elapsed value $[D, D+1]$ (32 bits) equals or exceeds the set value, the relays used by the OT instruction described next in the program are turned ON.

■ Operation example

Operation of instruction format description program

The internal relay condition is established, the auxiliary timer becomes active, and when the value stored in data registers DT10 and $DT11 \times 0.01$ seconds has elapsed, R5 turns ON.

- When the internal relay is OFF, the process value area is cleared to 0. The relay in use for the OT instruction turns OFF.
- When the time of the special internal relay R900D is up, it turns ON. It is also possible to use R900D as a timer contact. (Turns OFF when the internal relay is OFF and during addition.)

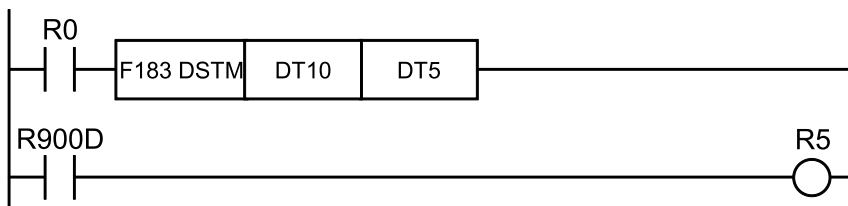

Operation is the same as the above example.

■ Setting the timer period

1. The timer period is $0.01 \times [\text{timer set value}]$.
2. The timer set value is set as a K constant in the range of K1 to K2147483647. 0.01 to 21474836.47 seconds in units of 0.01 second.

Example) If the set value is K500, the set time is $0.01 \times 500 = 5$ seconds.

■ Precautions for programming

- Ensure that the specifications of the area storing the set value and the process value area do not overlap with other timer/counter instructions or operation memory areas of high-level instructions.
- Addition is performed when the operation is executed, so the program should be created so the an operation is executed once per scan. (If an operation is performed more than once during one scan or cannot be performed even once due to an interrupt processing program or jump/loop instruction, correct results cannot be obtained.)

■ How the auxiliary timer works

1. When the internal relay changes from OFF to ON, 0s are transferred to the elapsed value area [D, D+1].

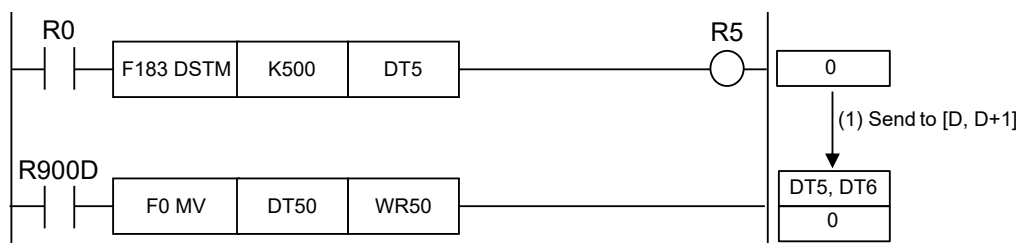

2. During each scan, if the internal relay is ON, the values in the elapsed value area of [D, D +1] are added.

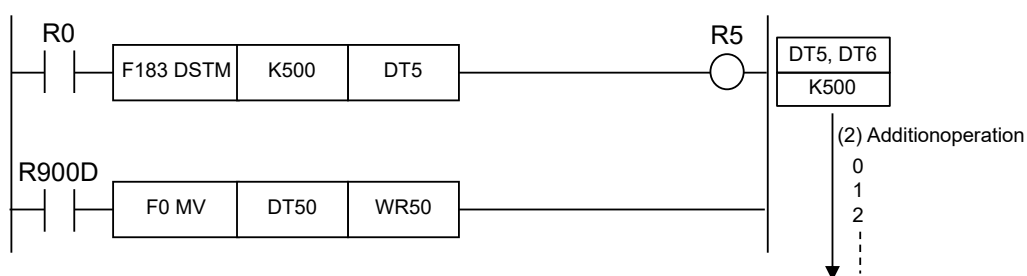

3. When the values in the elapsed value area [D, D+1] equal the values of [S, S+1], the relays used by the OT instruction described next in the program are turned ON. The special internal relay R900D also turns ON.

3.3 F183 DSTM (32-bit, 0.01 s On-delay Timer)

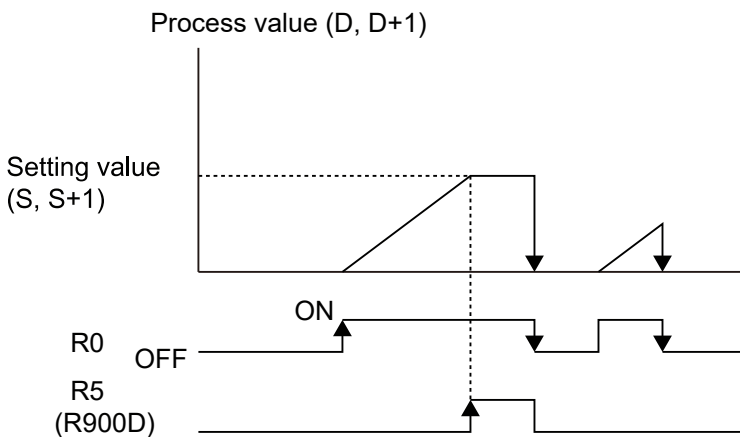
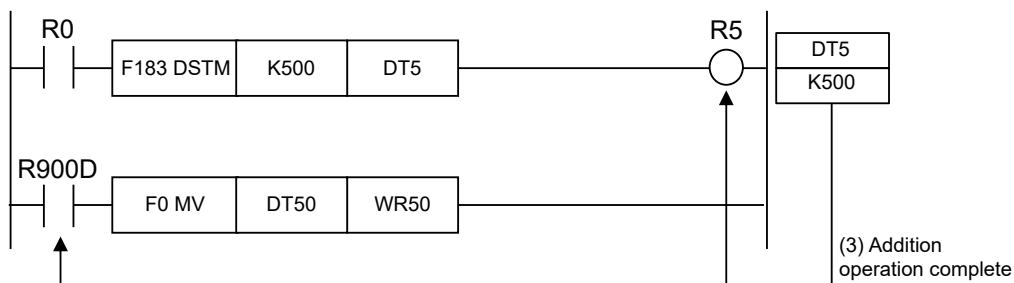

■ Precautions when using R900D

When using multiple auxiliary timers with R900D, ensure that R900D is used on the line after the auxiliary timer instruction.

<Example>

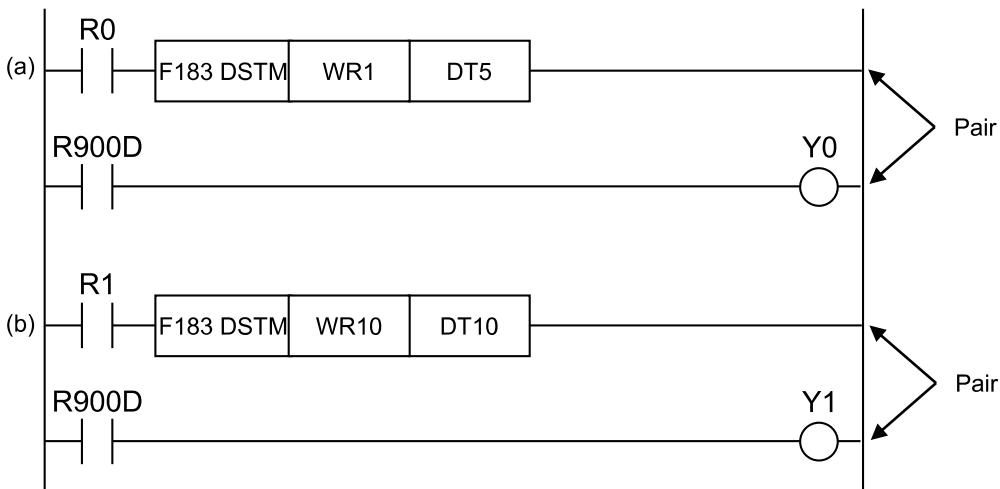

When the time is up for timer (a), activated by R0:ON, Y0 turns ON. When the time is up for timer (b), activated by R1:ON, Y1 turns ON.

- A correct operation cannot be obtained if specified as shown below.

3.3 F183 DSTM (32-bit, 0.01 s On-delay Timer)

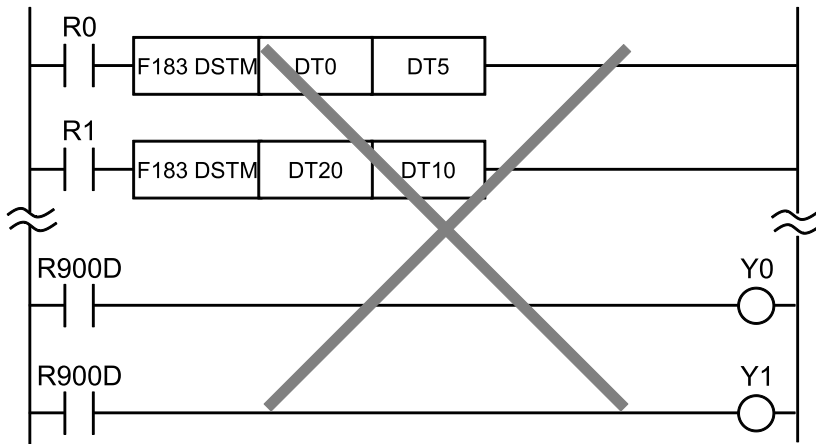

3.4 CT [Counter (Preset Subtraction Expression)]

3.4 CT [Counter (Preset Subtraction Expression)]

■ Instruction format

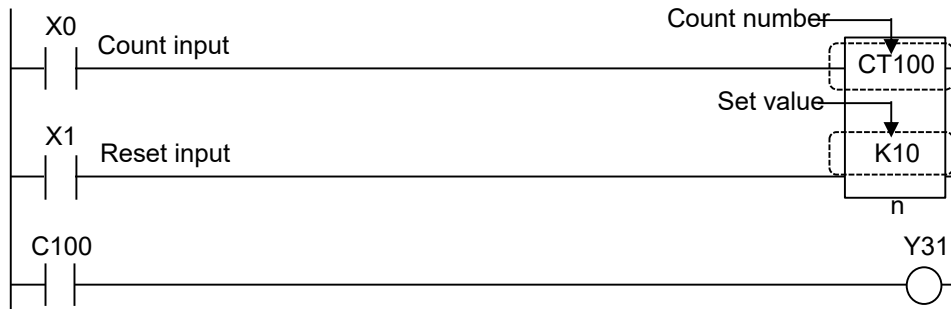

■ Instruction list

Instruction	Description
n	Counter set value

■ Devices that can be specified (indicated by ●)

Operands	WX	WY	WR	WL	SV	EV	DT	LD	I	SWR	SDT	Constant				Index modifier	Integer Device
												K	H	M	f		
n	●	●	●	●	●	●	●	●		●	●	●					

■ Outline of operation

- All counters are subtraction preset counters.
- When the reset input falls from ON to OFF, the value of the set value area SV is preset in the elapsed value area (EV).
- When the reset input is ON, the elapsed value is reset to 0.
- When the count input changes from OFF to ON, the set value is subtracted, and when the elapsed value reaches 0, it is output to the counter contact Cn (n is the counter number).
- If the count input and reset input both turn ON at the same time, the reset input is given priority.
- If the count input rises and the reset input falls at the same time, the count input is ignored and preset is executed.
- An OT instruction can be entered immediately after a counter instruction.

■ Operation example

Operation of instruction format description program

1. If X0 is turned ON 10 times, C100 turns ON, and Y31 turns ON.
2. The elapsed value is reset when X1 turns ON.

3.4 CT [Counter (Preset Subtraction Expression)]

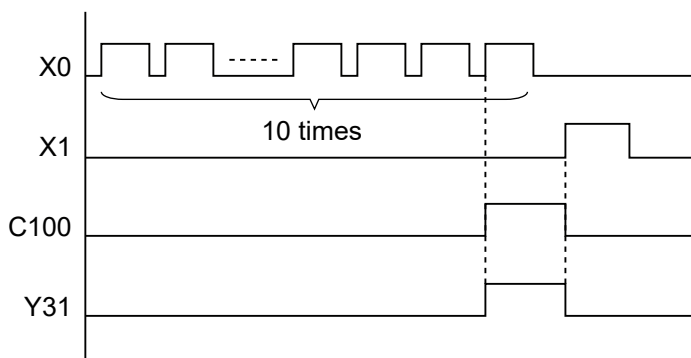

■ Setting the count value

The count value can be set to a decimal constant (K constant) in a setting range from K0 to K32767.

■ Counter operation

The following are examples of specifying a K constant as the set value. For an explanation of operations when a set value area number is specified, see "P.3-19". (This example shows a case in which "100" is specified for the counter.)

1. When switched to "RUN mode" or when the power is turned ON in "RUN mode", the counter set value is transferred to the set value area "SV" with the same number.
2. When the reset input falls, the value in the set value area SV is preset in the elapsed value area EV.

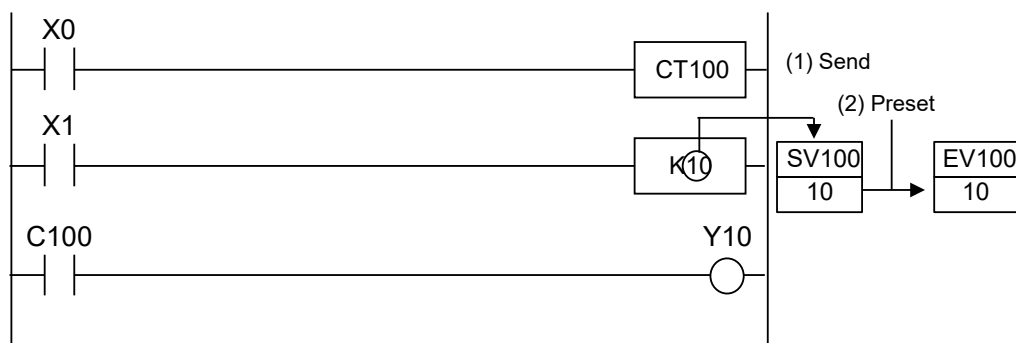

3. Each time the count input X0 turns ON, the value in the elapsed value area "EV" is subtracted.

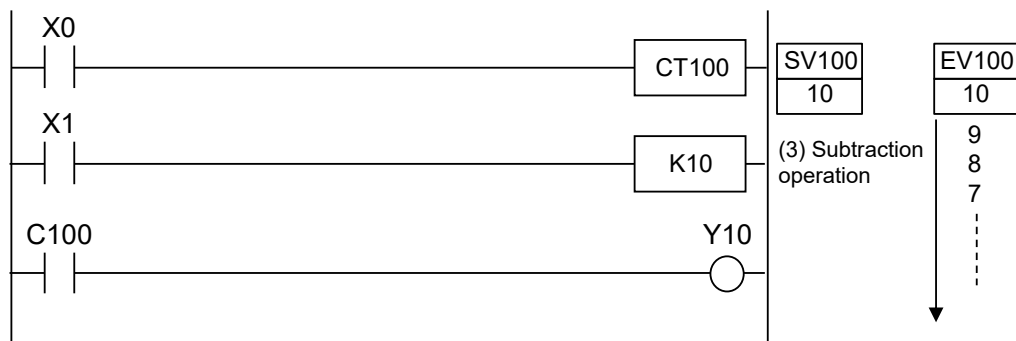

3.4 CT [Counter (Preset Subtraction Expression)]

4. When the value in the elapsed value area "EV" reaches zero, the counter contact "C" with the same number turns ON.

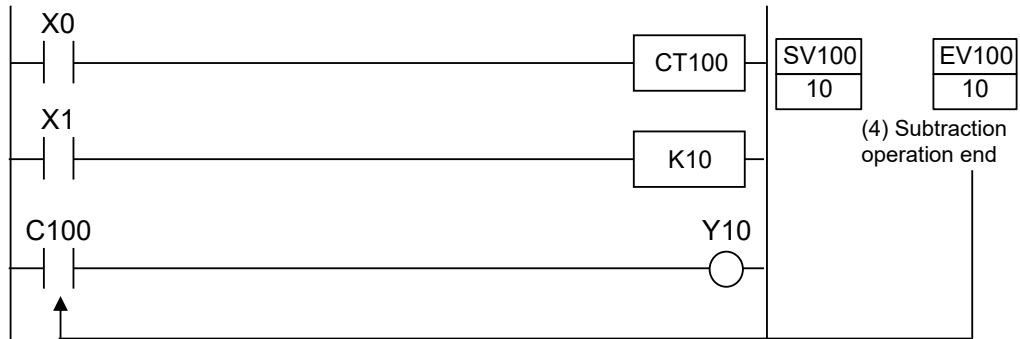

■ Precautions for programming

When combining a counter instruction with an AND stack instruction or POP stack instruction, be careful that the programming is correct.

■ Cautions on detecting the count input

In a counter instruction, the subtraction takes place when the rise of the count input from OFF to ON is detected.

- Counting is only performed at the rise, so even if the count input remains on, no further counting will occur.
- In cases where the count input is initially ON, such as when the mode is switched to RUN or when the power is turned on when in "RUN mode", subtraction will not take place at the first scan.

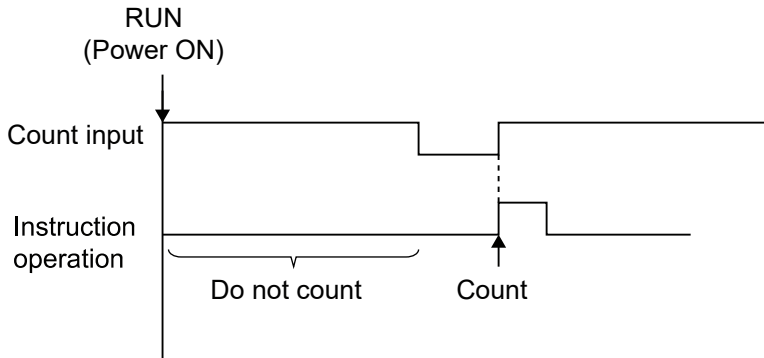

- Be aware that, if used with instructions that change the order of execution such as the MC to MCE instructions or the JP to LBL instructions (see 1 to 6 below), the operation of instructions may change depending on the timing of instruction execution and count input.
 1. MC to MCE instructions
 2. JP to LBL instructions
 3. LOOP to LBL instructions
 4. CNDE instruction
 5. Step ladder instructions
 6. Subroutine instructions

■ Related instructions

- Counter instructions also include an up/down counter instruction (F118 UDC).
- An increment instruction (F35+1) can be used to provide the same type of function.

■ Directly specifying a set value area number as a counter set value

The set value area number can be specified directly as the set value [n].

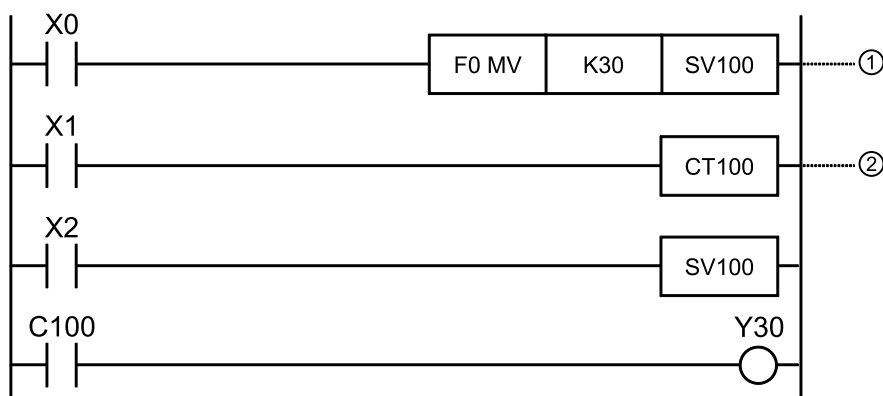

The program described above, which specifies SV100 for the set value, operates as follows.

1. When execution condition X0 is ON, the data transfer instruction (F0 MV) is executed and K30 is set in SV100.
 2. When the count input X1 turns ON, the subtraction operation begins from the set value of 30.
- Make the address of the set value area "SV" that specifies [n] the same as the counter number.

Display:

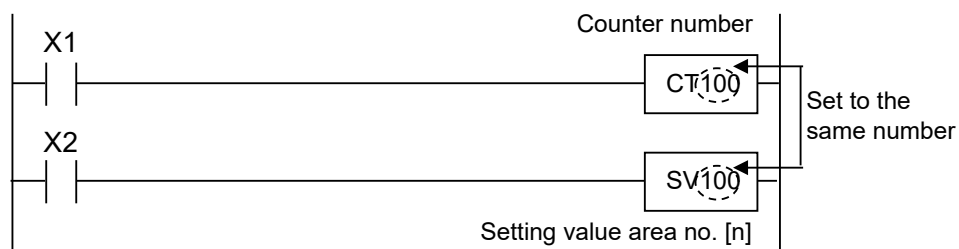

- Even if the value in the set value area "SV" is changed during the subtraction operation, the subtraction operation will continue from the value before the change. Counter operation from the new value will not begin until the counter is reset and the count input subsequently changes from OFF to ON.

■ Counter operation when a set value area number is directly specified

1. When the execution condition for a high-level instruction is ON, the value is set in the set value area "SV". The following diagram shows an example of using the F0 MV instruction.

3.4 CT [Counter (Preset Subtraction Expression)]

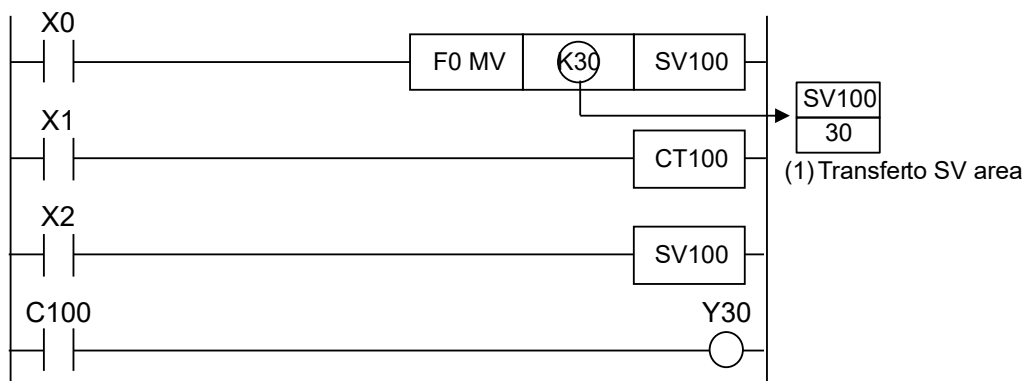

2. When the reset input falls, the value in the set value area "SV" is preset in the elapsed value area "EV" .

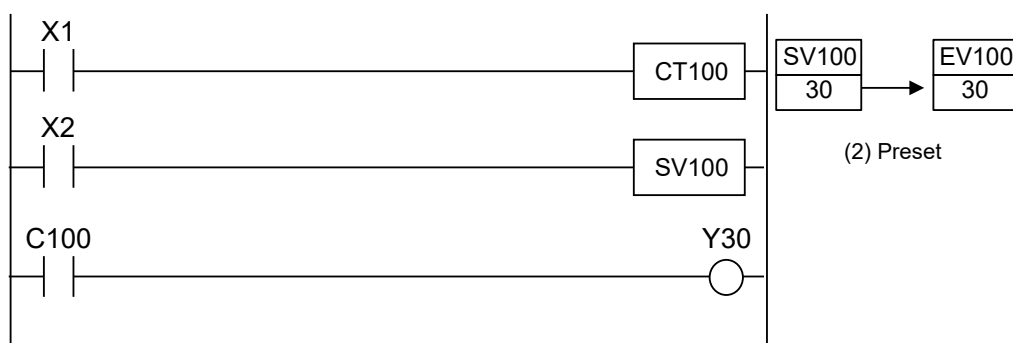

3. Each time the count input X1 turns ON, the value in the elapsed value area "EV" is subtracted.

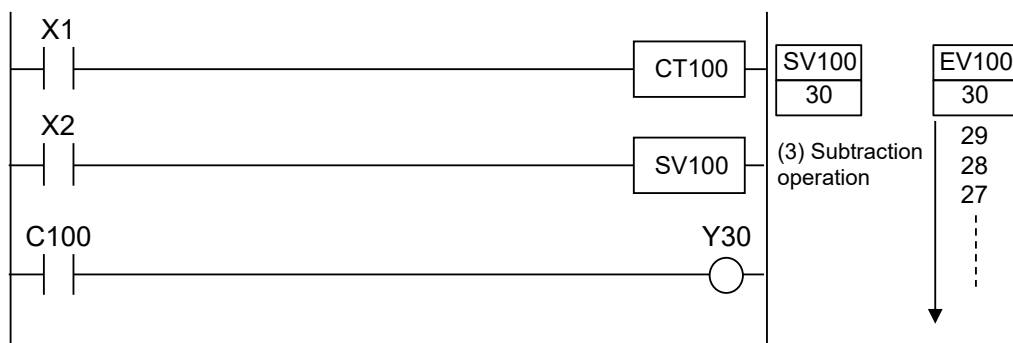

4. When the value in the elapsed value area "EV" reaches zero, the counter contact "C" with the same number turns ON.

3.4 CT [Counter (Preset Subtraction Expression)]

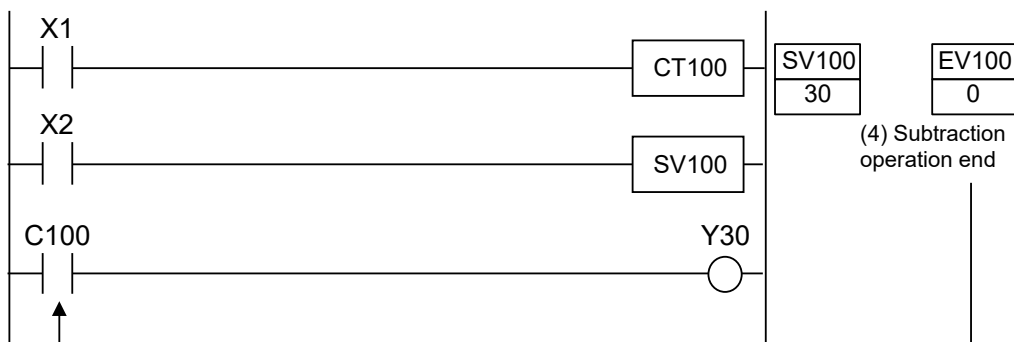

■ Examples of applying direct specification of set value area numbers

Example 1) Changing set values based on specified conditions

The set value is K50 when X0 is ON and K30 when X1 is ON.

● Ladder diagram

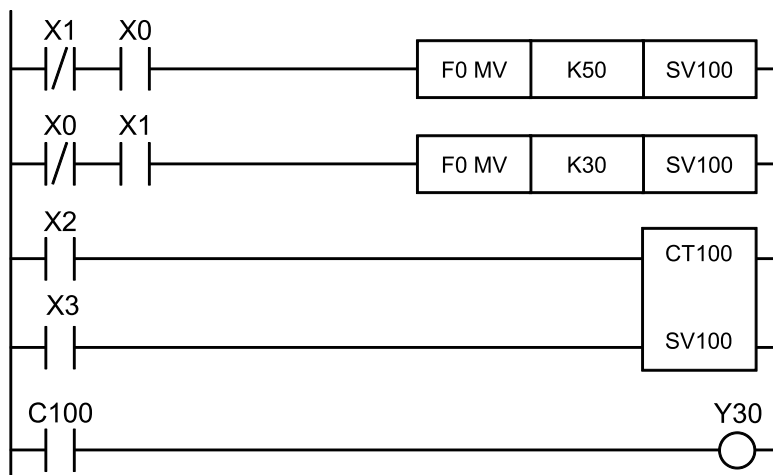

● Timing chart

Example when X0 turns ON.

3.4 CT [Counter (Preset Subtraction Expression)]

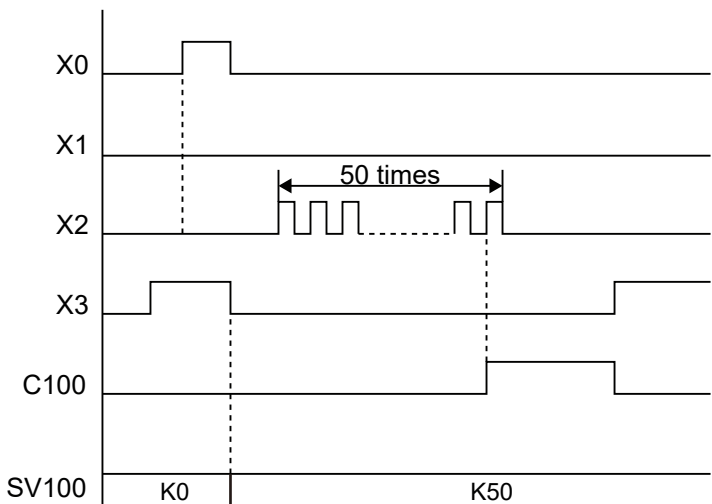

Example 2) Setting a set value from external digital switches

The BCD data of the digital switches connected to X0 through XF is converted and becomes the set value.

• **Connection example**

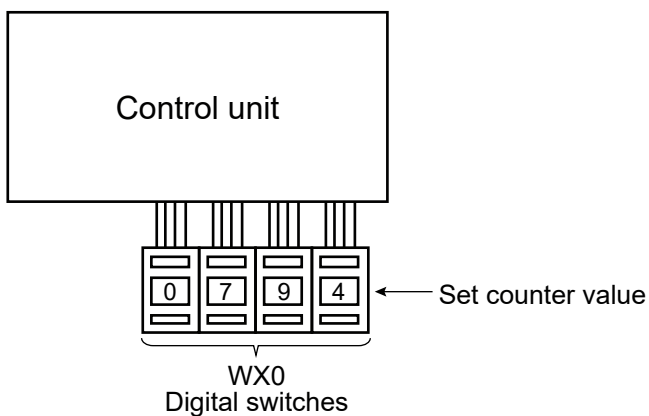

• **Ladder diagram**

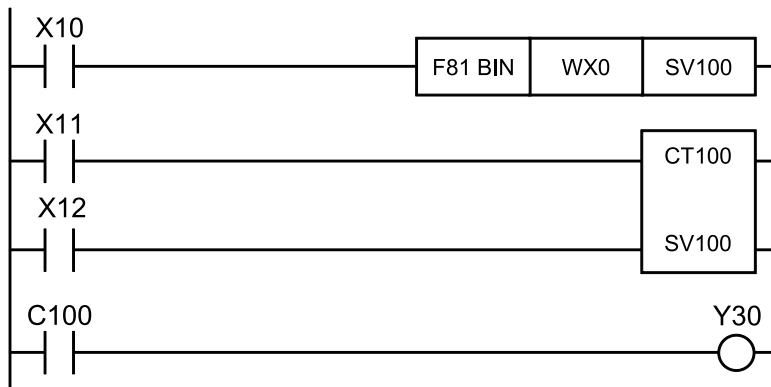

3.5 F118 UDC (Up/Down Counter)

■ Instruction format

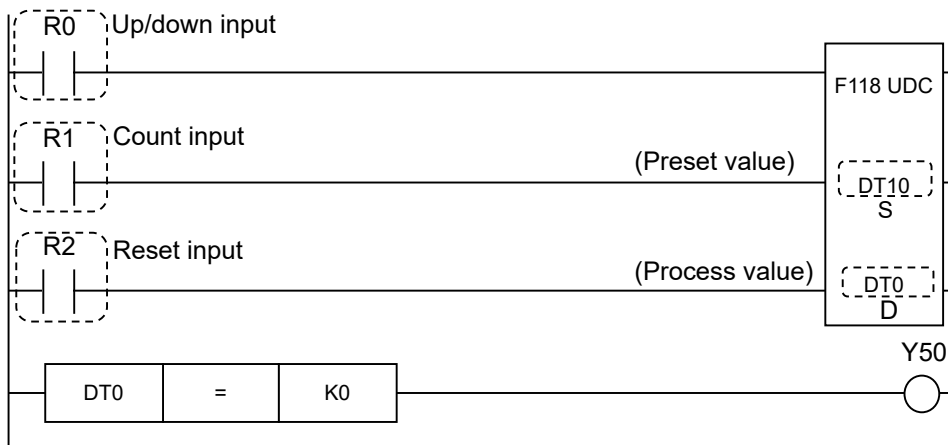

■ Instruction list

Instruction	Description
S	Area storing preset values, or constant data
D	Up/down counter elapsed value area

■ Devices that can be specified (indicated by ●)

Operands	WX	WY	WR	WL	SV	EV	DT	LD	I	SWR	SDT	Constant				Index modifier	Integer Device
												K	H	M	f		
S	●	●	●	●	●	●	●	●		●	●	●	●				
D		●	●	●	●	●	●	●									

■ Outline of operation

- This is a counter that switches between incremental counting (addition) and decremental counting (subtraction) depending on whether the relay specified by the up/down input is ON or OFF.
- The count operation is incremental counting (+1) when the up/down input is ON, and decremental counting (-1) when the up/down input is OFF. The elapsed value is stored in the area specified by [D].
- When the reset input is switched from ON to OFF, the preset value of [S] is transferred to [D]. The count range is K-32,768 (H8000) to K32,767 (H7FFF).
- When the count input is changed from OFF to ON (with reset input in an OFF state), the count operation is performed with the value set in [D] as the default value.
- When the reset input turns ON, the elapsed value area of [D] is cleared.
- The count result can be determined by comparing the elapsed value of [D] with the specified setting value by using the data comparison instruction.
- Execute the data comparison instruction immediately after the F118 UDC instruction.

3.5 F118 UDC (Up/Down Counter)

■ Operation example

Operation of instruction format description program

The program on the previous page is an example in which the default value is set, and external output Y50 turns ON when target value is 0.

This can be used, for example, in programs such as those that cause an indicator lamp to light when the work being added or subtracted reaches a certain quantity.

1. When reset input R2 switches from ON to OFF, the DT10 value is written to DT0. This value is the target value.
2. If count input R1 is ON when R0 turns OFF, the DT0 value is decremented by 1 (decremental counting). If count input R1 is ON when R0 turns ON, the DT0 value is incremented by 1 (incremental counting).
3. As a result of work being added or subtracted, the counter elapsed value area DT0 value is compared with K0, and if DT0 is equal to 0, external output Y50 turns ON.

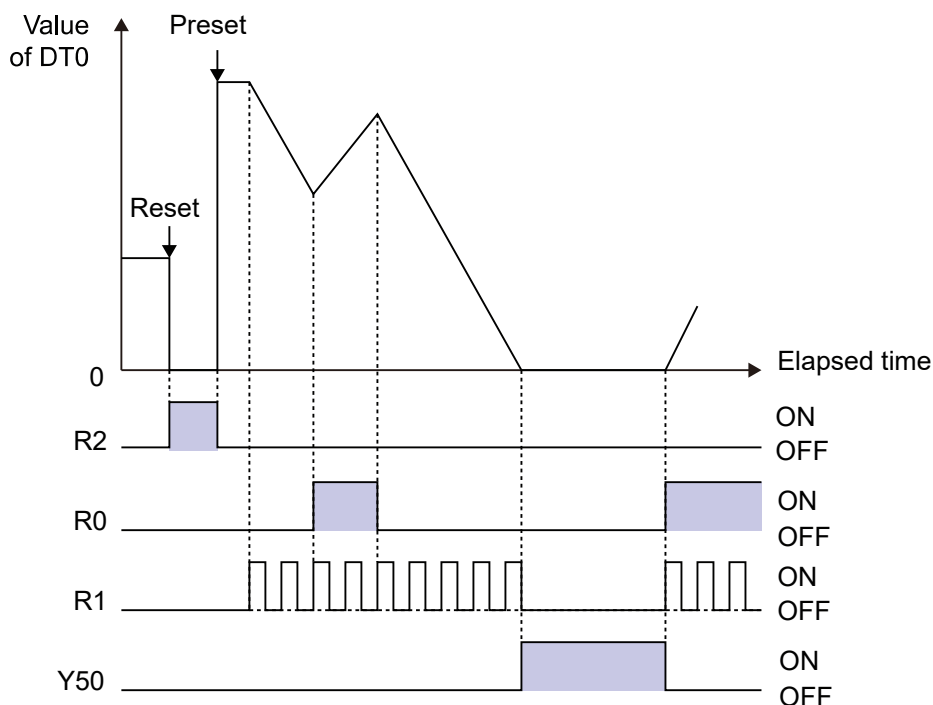

■ Precautions for programming

- If a hold type memory area is specified for the elapsed value area, the elapsed value acts in accordance with the content being held.
- Be aware that the default value when starting operation is not automatically preset to the elapsed value area. When performing preset, switch reset input from ON to OFF.
- When combining the F118 UDC instruction with an AND stack instruction or a POP stack instruction, be careful that the programming is correct.

■ Cautions on detecting the count input

With the F118 UDC instruction, the increment or decrement occurs when the rise of the count input from OFF to ON is detected.

- Counting is only performed at the rise, so even if the count input remains on, no further counting will occur.
- When switching to RUN or when powering on in "RUN mode", if the count input is ON from the beginning, increment/decrement is not carried out for the first scan.

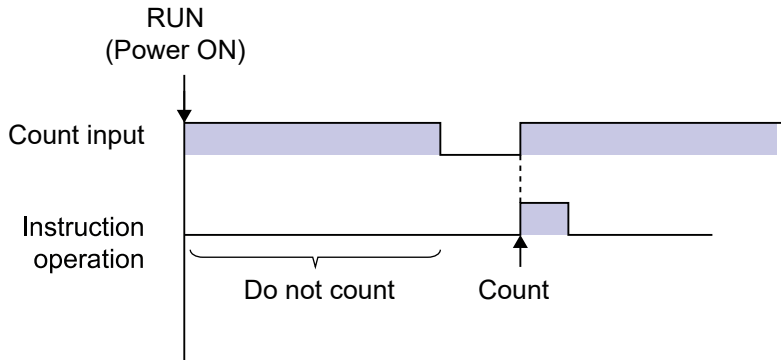

- Be aware that, if used with instructions that change the order of execution such as the MC to MCE instructions or the JP to LBL instructions (see 1 to 6 below), the operation of instructions may change depending on the timing of instruction execution and count input.
 1. MC to MCE instructions
 2. JP to LBL instructions
 3. LOOP to LBL instructions
 4. CNDE instruction
 5. Step ladder instructions
 6. Subroutine instructions

3.6 SR (Shift Register)

3.6 SR (Shift Register)

■ Instruction format



■ Instruction list

Instruction	Description
D	Specified register

■ Devices that can be specified (indicated by ●)

Operands	WX	WY	WR	WL	SV	EV	DT	LD	I	SWR	SDT	Constant				Index modifier	Integer Device
												K	H	M	f		
D			●														

■ Outline of operation

- An instruction that moves (shifts) the content of the specified register WR (16-bit unit) one bit to the left.
1. When shift input turns ON (rises), the contents of WR is shifted one bit to the left
 2. When shifting, the empty bit (least significant bit) is set to 1 if data input is ON or 0 if OFF.
- When shift input turns ON, this instruction operates as shown in the figure below.



- When reset input is ON, the content of the specified register is cleared.

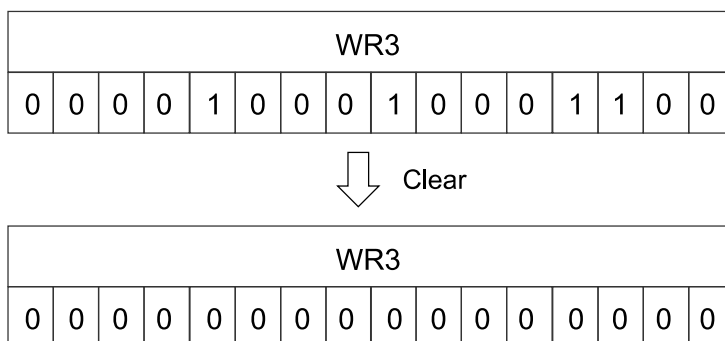

■ Operation example

Operation of instruction format description program

- If X1 turns ON when X2 is in an OFF state, the content of WR3 (internal relays R30 to R3F) is shifted one bit to the left.
- The bit left empty by the left shift (R30) is set to 1 when X0 is ON and 0 when OFF.
- When X2 turns ON, the content of WR3 is reset to 0.

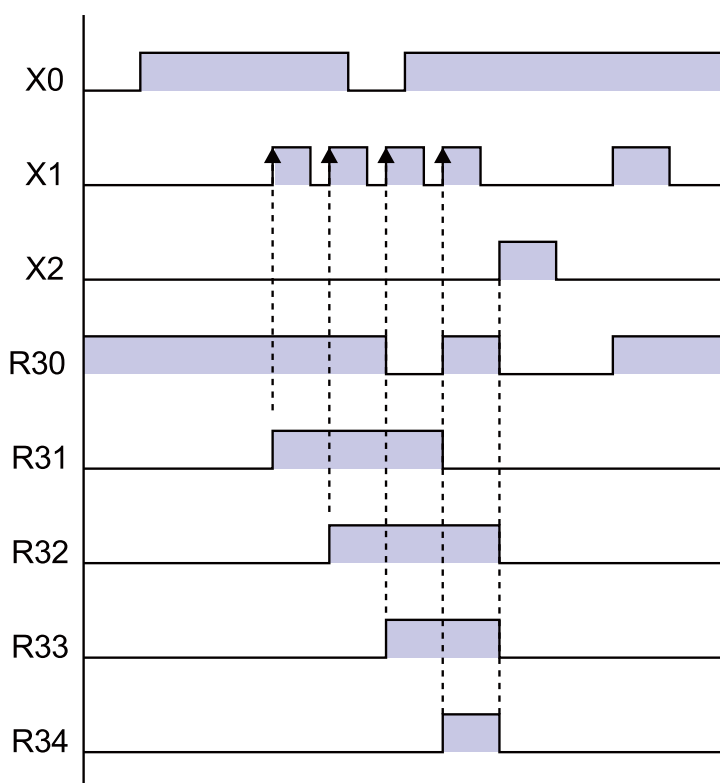

■ Precautions for programming

- The **SR** instruction requires data input, shift input, and reset input.
- When reset input and shift input rise simultaneously, reset input is prioritized.

3.6 SR (Shift Register)

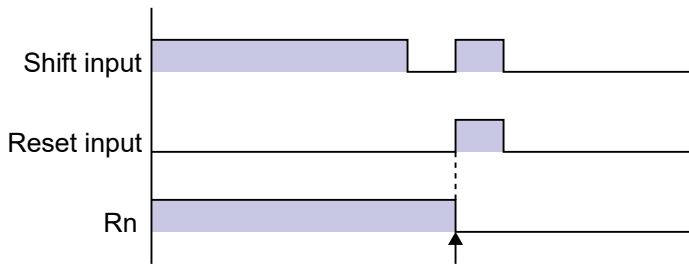

Reset input has priority

- Note that when a hold type memory area is specified for the shift register, an automatic reset is not performed when the power supply is turned ON.
- When combining a shift register instruction with an AND stack instruction or pop stack instruction, make sure that the syntax is correct.

■ Precautions for shift input detection

The SR instruction performs a shift when an OFF to ON rise is detected.

- If the shift input remains continuously ON, a shift will only take place at the rise. No further shifts will take place.
- In cases where the shift input is initially ON, such as when the mode is switched to RUN or when the power is turned on when in "RUN mode", a shift will not take place at the first scan.

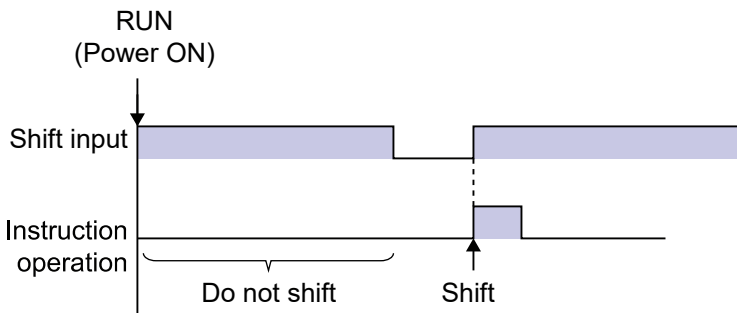

- Be aware that, if used in combination with instructions (see below, 1. to 6.) that change the order of execution of instructions such as the MC to MCE instructions or the JP to LBL instructions, depending on the execution of the instruction and the shift input timing the instruction operation changes.
 1. MC to MCE instructions
 2. JP to LBL instructions
 3. LOOP to LBL instructions
 4. CNDE instruction
 5. Step ladder instructions
 6. Subroutine instructions

■ Related instructions

In addition to this instruction, there is also a left/right shift register (F119 LRSR). The same type of operation can be implemented using data shift instructions (F100 SHR to F113 WBSL) or data rotate instructions (F120 ROR to F123 RCL).

3.7 F119 LRSR (Left/Right Shift Register)

■ Instruction format

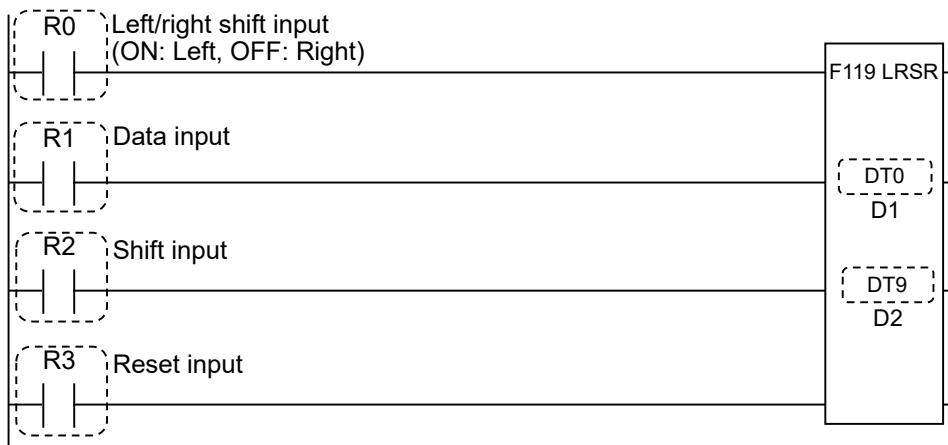

■ Instruction list

Instruction	Description
D1	Starting number of area to be shifted
D2	End number of area to be shifted

■ Devices that can be specified (indicated by ●)

Operands	WX	WY	WR	WL	SV	EV	DT	LD	I	SWR	SDT	Constant				Index modifier	Integer Device
												K	H	M	f		
D1		●	●	●	●	●	●	●									
D2		●	●	●	●	●	●	●									

■ Outline of operation

- This shift register changes direction, either left (direction of most significant bit) or right (direction of least significant bit), in which a shift of one bit is made based on the ON/OFF status of the relay specified by the left/right shift input.
- The shift operation is made to the left when the left/right shift input is ON, and to the right when OFF.
- Specify the same type of area for both [D1] and [D2]. Additionally, specify values so that [D1] is equal to or less than [D2].
- The following operation is performed.
 1. When the shift input changes from OFF to ON (the reset input is OFF), the contents of the area specified by [D1] and [D2] are shifted one bit to the left or right.
 2. When the data is shifted, 1 will be set in the empty bit left by the shift (the most significant bit or least significant bit) if the data input is ON, and 0 if the data input is OFF.

3.7 F119 LRSR (Left/Right Shift Register)

Also, the bit extracted by the shift (the most significant bit for a shift to the left, and the least significant bit for a shift to the right) will be set for the special internal relay R9009 (carry flag).

- If the reset input is ON, the contents of the specified area are cleared to 0.

■ Operation example

Operation of instruction format description program

Left shift

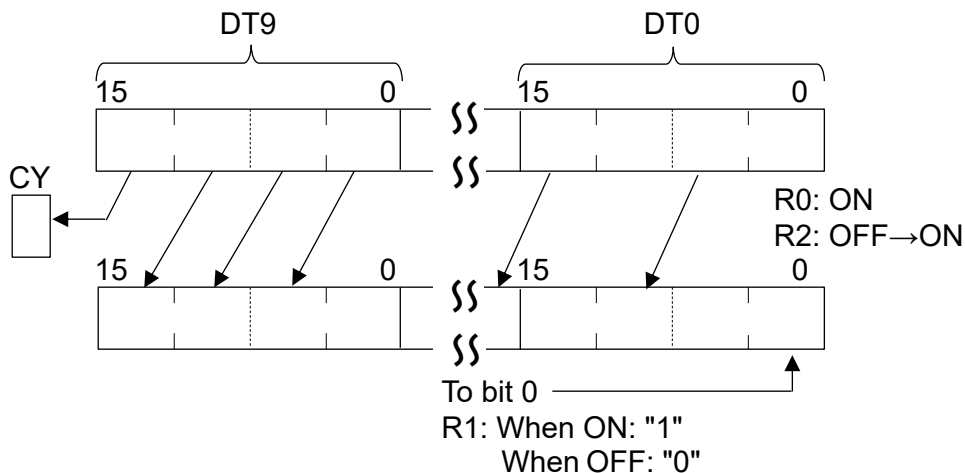

Right shift

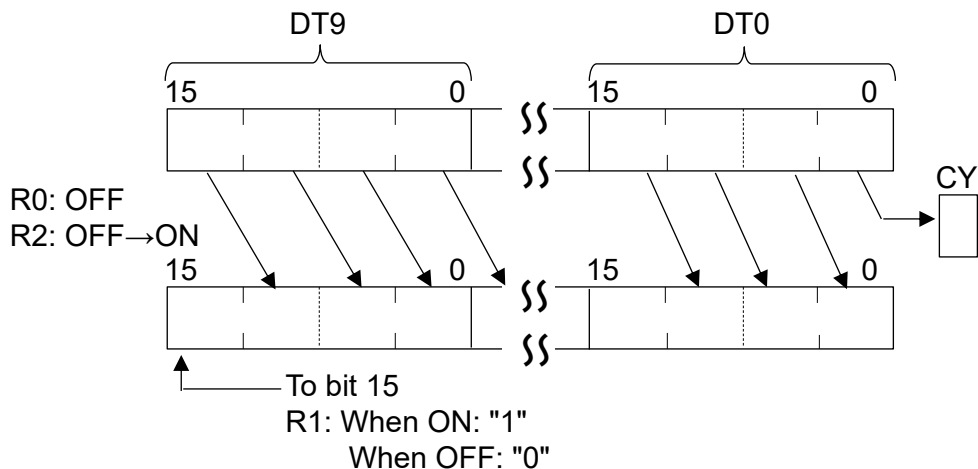

■ Precautions for shift input detection

In the F119 LRSR instruction, shift takes place when the OFF > ON rise of the shift input is detected.

- If the shift input remains continuously ON, a shift will only take place at the rise. No further shifts will take place.

- In cases where the shift input is initially ON, such as when the mode is switched to RUN or when the power is turned on when in "RUN mode", a shift will not take place at the first scan.

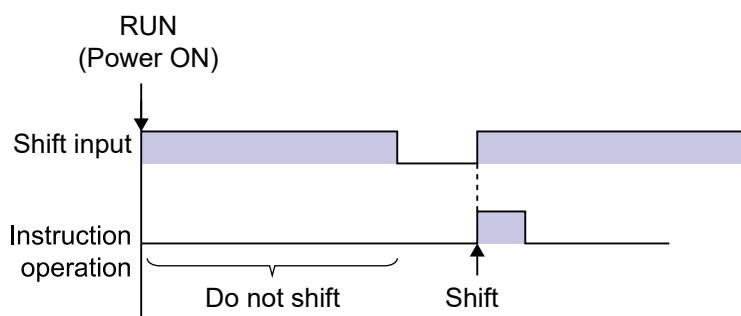

- Be aware that, if used in combination with instructions (see below, 1. to 6.) that change the order of execution of instructions such as the MC to MCE instructions or the JP to LBL instructions, depending on the execution of the instruction and the shift input timing the instruction operation changes.
 1. MC to MCE instructions
 2. JP to LBL instructions
 3. LOOP to LBL instructions
 4. CNDE instruction
 5. Step ladder instructions
 6. Subroutine instructions

■ Precautions for programming

When combining the F119 LRSR instruction with an AND stack instruction or POP stack instruction, be careful that the programming is correct.

■ Flag operations

Name	Description
R9007 R9008 (ER)	Turns ON when the [D1] address > [D2] address
R9009 (CY)	Turns ON when the bit extracted by the shift is "1"

3.8 F182 FILTR (Time Literal Process)

3.8 F182 FILTR (Time Literal Process)

■ Instruction format

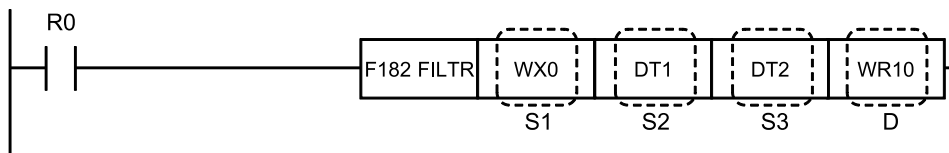

■ Instruction list

Instruction	Description
S1	Area storing the 16-bit data that is filter processing target
S2	Area storing the filter processing target bits, or constant data
S3	Area storing the filter processing time, or constant data
D	Area storing the filter processing result

■ Devices that can be specified (indicated by ●)

Operands	WX	WY	WR	WL	SV	EV	DT	LD	I	SWR	SDT	Constant				Index modifier	Integer Device
												K	H	M	f		
S1	●	●	●	●	●	●	●	●	●	●	●						
S2	●	●	●	●	●	●	●	●	●	●	●	●	●				
S3	●	●	●	●	●	●	●	●	●	●	●	●	●				
D		●	●	●	●	●	●	●	●								

■ Outline of operation

In the 16-bit data in the area specified by S1, for the bits specified by S2, 0 bits are directly output and 1 bits (filter processing targets) are output after filter processing for the amount of time (0 to 30000, ms units) specified by S3 and the result is output in bit units (the bit positions are the same as for S1) to the area specified by D.

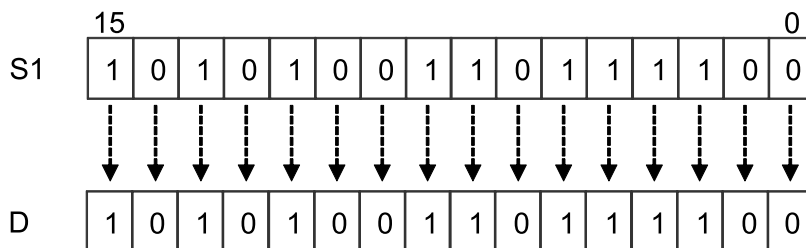

(Note 1) The bit positions of S1 and D correspond.

■ Precautions for programming

- When the execution condition rises, all input bits specified by S1 are directly output unconditionally.
- It is possible that an error of up to one scan may occur in the filter processing time.

■ Example of program execution

The changes in the execution condition R0 and the values of X0 to XF when the state before execution of this instruction (R0 = 0) is as follows are explained by using a time chart.

WX0 (Filter processing input data) = HA9BC

DT1 (Filter processing target bit) = H0001

DT2 (Filter processing time) = K500

WR10 (Filter processing result) = HFFFF

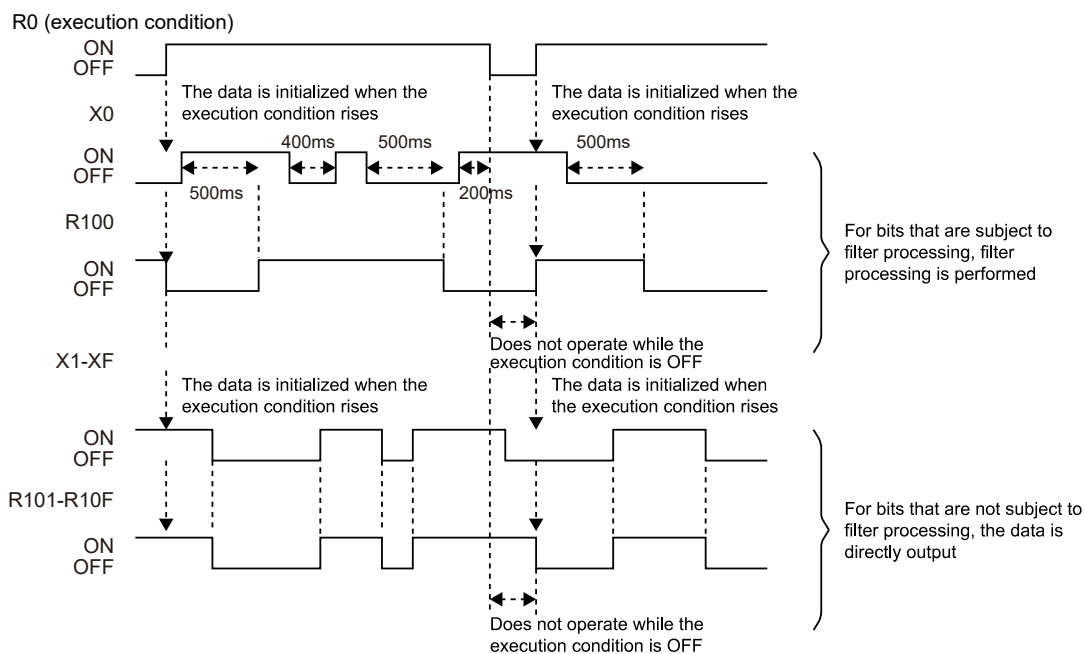

■ Flag operations

Name	Description
R9007	When the area is exceeded in index modification
R9008 (ER)	When the filter processing time specified by S3 is outside the range of K0 to K30000

(MEMO)

4 Control Instructions

4.1 MC/MCE (Master Control Relay / Master Control Relay End).....	4-2
4.2 JP/LBL (Jump/Label)	4-7
4.3 LOOP, LBL (Loop, Label).....	4-11
4.4 ED (End)	4-15
4.5 CNDE (Conditional End).....	4-16
4.6 EJECT.....	4-18

4.1 MC/MCE (Master Control Relay / Master Control Relay End)

4.1 MC/MCE (Master Control Relay / Master Control Relay End)

■ Instruction format

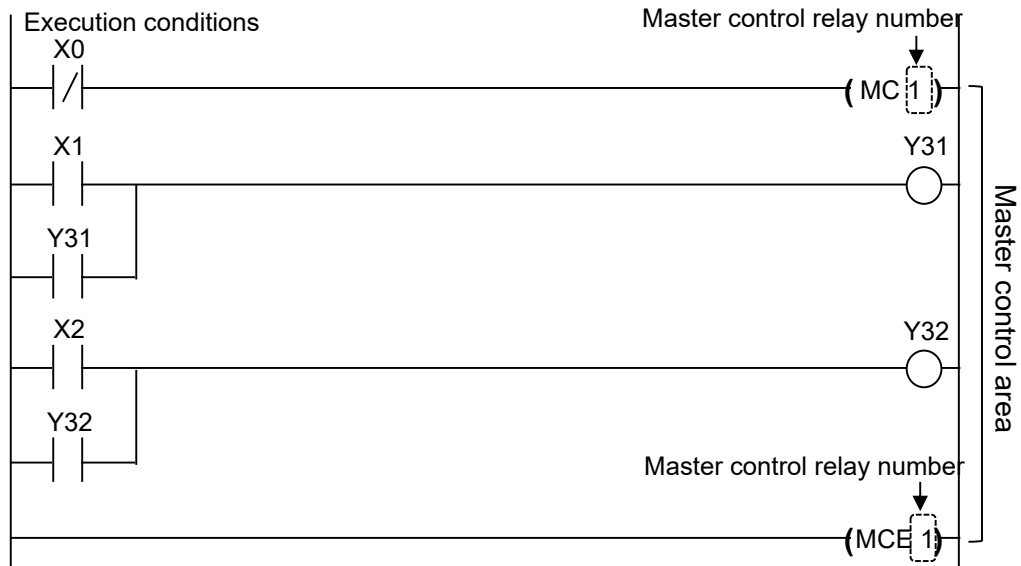

■ Outline of operation

- Executes the program between the **MC** and **MCE** instructions when the execution condition turns ON.
- When the execution condition is OFF, the state of each I/O relay is as follows.

OT instruction	All OFF
KP instruction	Holds the state
SET instruction	Holds the state
RST instruction	Holds the state
TM instruction	Reset
CT instruction	Holds the intermediate process
SR instruction	Holds the intermediate process
Differential instruction	Refer to the following
Other instructions	Not executed

- Caution is required when using an instruction that is executed by detecting the rise of an execution condition, such as a differential instruction (1 to 7 below).
 1. DF (rise differential)
 2. CT (counter) count input
 3. F118 UDC (up-down counter) count input
 4. SR (shift register) shift input
 5. F119 LRSR (left and right shift register) shift input
 6. NSTP (next step)
 7. Differential execution type high-level instruction (instruction specified by P and a number)

■ Operation example

Operation of instruction format description program

1. Executes the process between the **MC1** and **MCE1** instructions while the execution condition is ON.
2. If the execution condition is OFF, the process between the **MC1** and **MCE1** instructions is not executed and output is turned OFF.

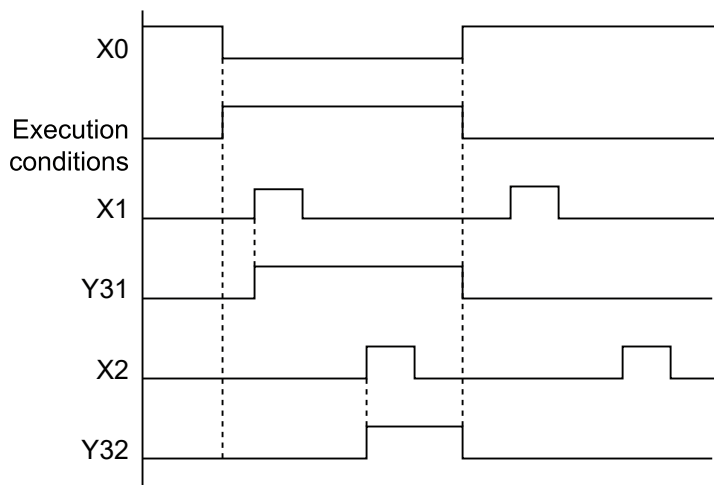

■ Operation of differential instructions between MC and MCE

- Note that if a differential instruction is used between MC and MCE, the output will vary as follows depending on the timing of the MC execution condition and the input of differential instruction.

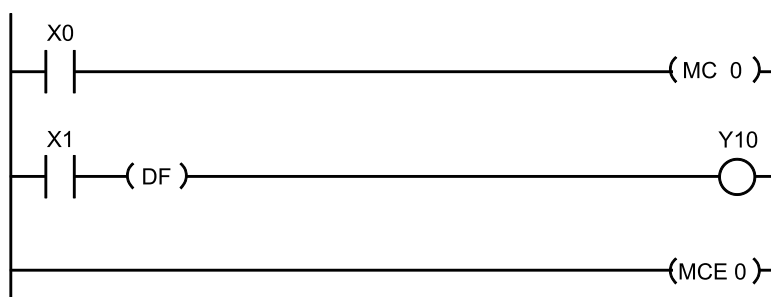

4.1 MC/MCE (Master Control Relay / Master Control Relay End)

Timing chart 1

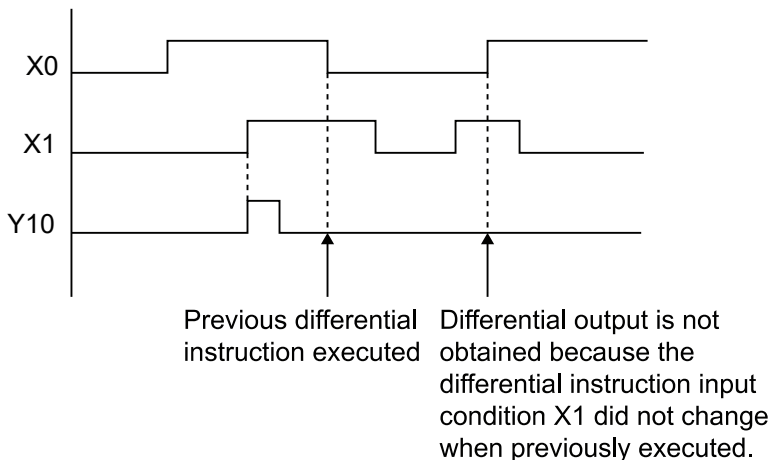

Timing chart 2

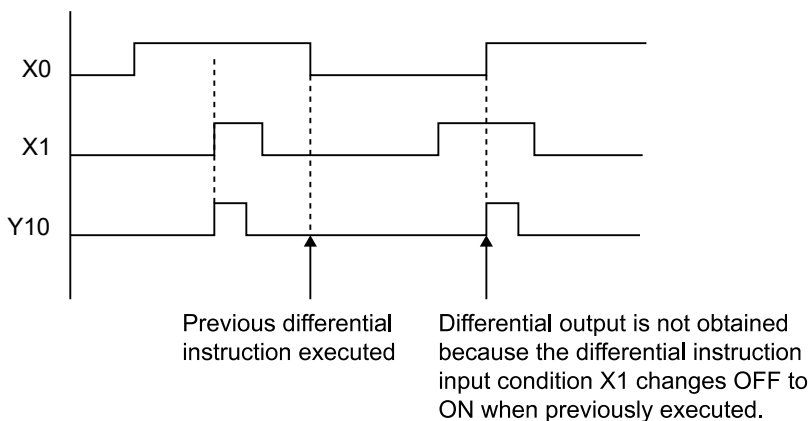

- Output will not be obtained if the same execution condition is specified for an MC instruction and a differential instruction. If output is needed, enter the differential instruction outside of the MC-MCE instruction sequence.

4.1 MC/MCE (Master Control Relay / Master Control Relay End)

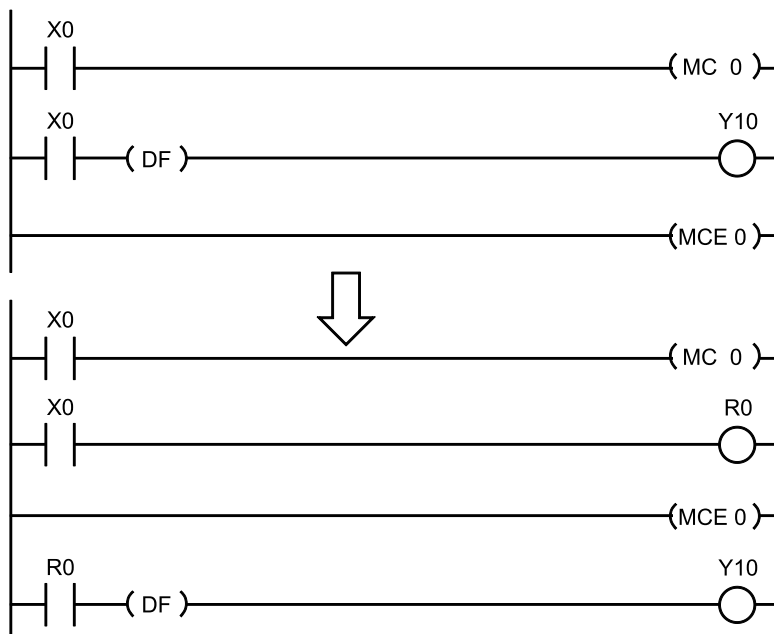

■ Precautions for programming

- A second **MC-MCE** instruction pair can be entered (nested) between an initial **MC-MCE** instruction pair. (There is no limit to the number of nestings.)

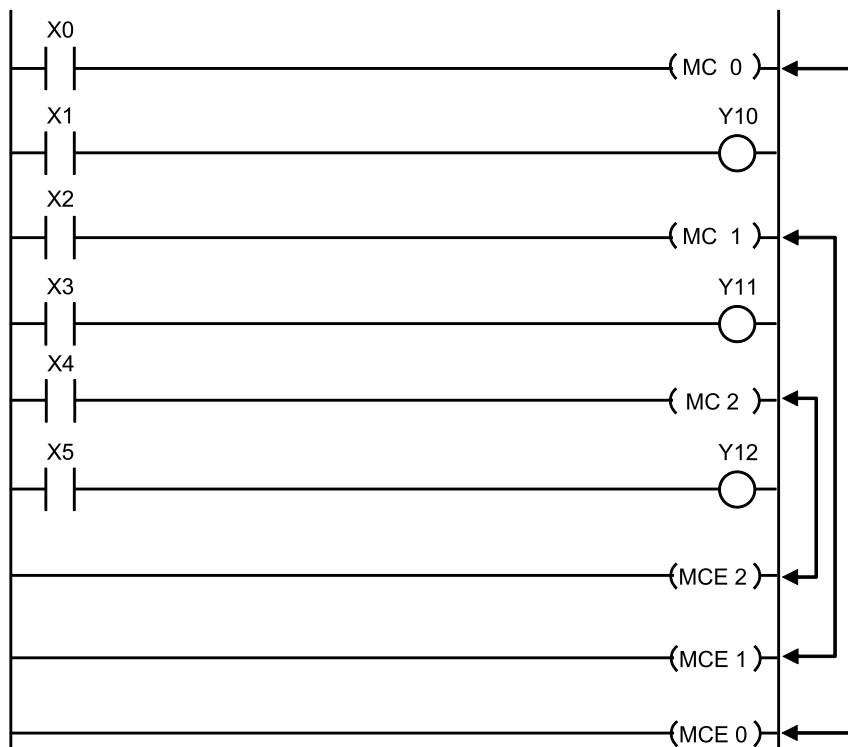

4.1 MC/MCE (Master Control Relay / Master Control Relay End)

- The program cannot be executed in the following cases.
 1. Either **MC** or **MCE** is missing.
 2. The order of **MC** and **MCE** is reversed.

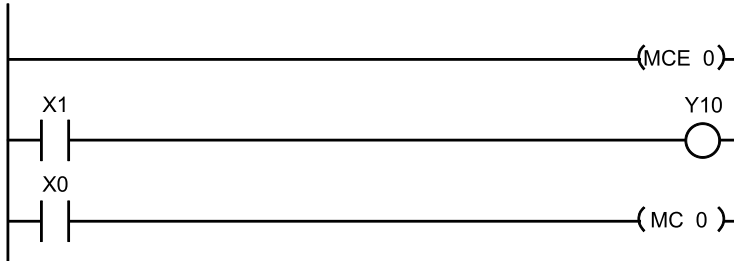

3. There is duplicated use of the specified number.

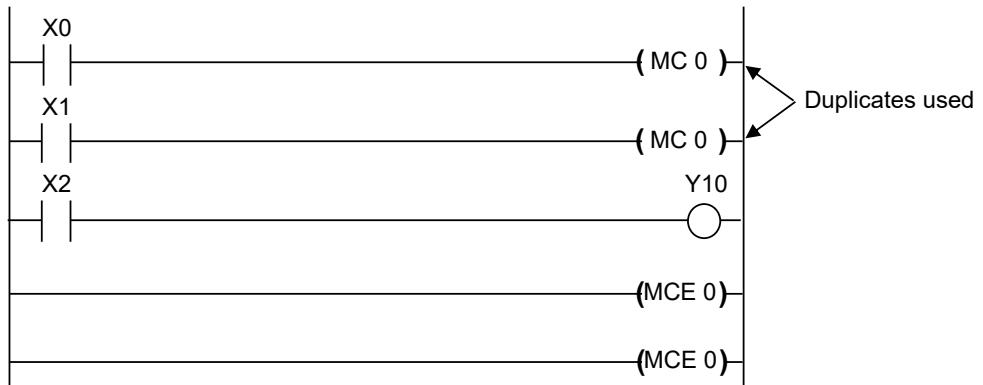

4.2 JP/LBL (Jump/Label)

■ Instruction format

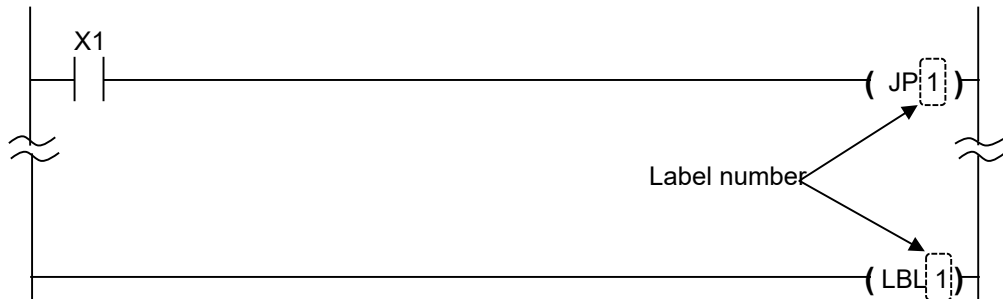

■ Outline of operation

- When the execution condition turns ON, the program jumps to the label (**LBL** instruction) with the same number as the specified number.
- Program execution continues from the next instruction after the jump destination label.

■ Operation example

Operation of instruction format description program

When execution condition X1 turns ON, the program jumps to label 1.

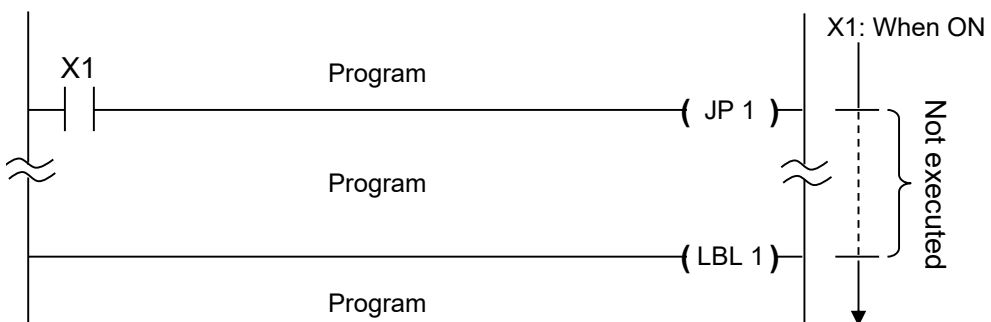

- The same label is used by the **JP** instruction and the **LOOP** instruction. Any instruction can be used as the starting point for the jump destination.
- It is possible to use **JP** instructions with the same label number multiple times.

4.2 JP/LBL (Jump/Label)

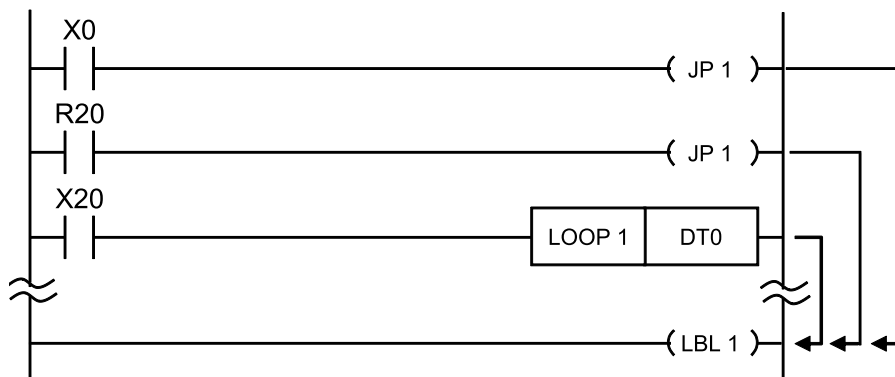

- 2 or more **LBL** instructions with the same number cannot be written in the same program.
- If the jump destination label is not programmed, a syntax error occurs.
- Caution is required when using an instruction that is executed by detecting the rise of an execution condition, such as a differential instruction (1 to 7 below).
 1. DF (rise differential)
 2. CT (counter) count input
 3. F118 UDC (up-down counter) count input
 4. SR (shift register) shift input
 5. F119 LRSR (left and right shift register) shift input
 6. NSTP (next step)
 7. Differential execution type high-level instruction (instruction specified by P and a number)

■ Precautions for programming

- If the label is written to an address before the **JP** instruction, be aware that there is a possibility that the scan cannot be completed, and an operation bottleneck error will occur.
- **JP** and **LBL** instructions cannot be used in a step ladder area (the range from **SSTP** to **STPE**).
- It is not possible to jump from a main program to a subprogram (a subroutine or interrupt program after the **ED** instruction), from a subprogram to a main program, or from a subprogram to another subprogram.

■ Operation of TM, CT, and SR instructions between JP and LBL instructions

- If the **LBL** instruction is at an address after the **JP** instruction, then processing of each instruction when executing the **JP** instruction will be as follows.

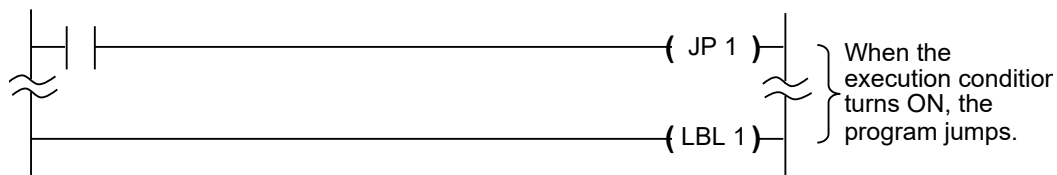

(1)	TM instruction	Clocking is not performed. If it is not executed once during a single scan, the correct time cannot be guaranteed.
(2)	CT instruction	Even if count input is ON, counting is not performed. The elapsed value is retained.

(3)	SR instruction	Even if shift input is ON, no shift is performed. The contents of the specified register are retained.
-----	----------------	--

- If the **LBL** instruction is at an address before the **JP** instruction, then processing of each instruction when executing the **JP** instruction will be as follows.

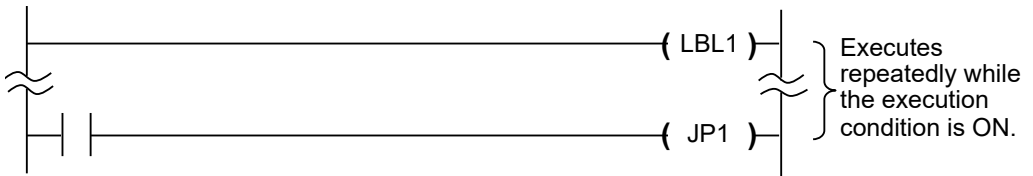

(1)	TM instruction	Multiple timings occur during a single scan, therefore the time cannot be guaranteed.
(2)	CT instruction	If the state of the count input does not change during the scan, it will operate in the usual way.
(3)	SR instruction	If the state of the shift input does not change during the scan, it will operate in the usual way.

■ **Operation of a differential instruction between JP and LBL**

- If a differential instruction is used between a JP and LBL instruction, be aware that the obtained output will differ as shown below depending on the execution condition of the JP and the input timing of the differential instruction.

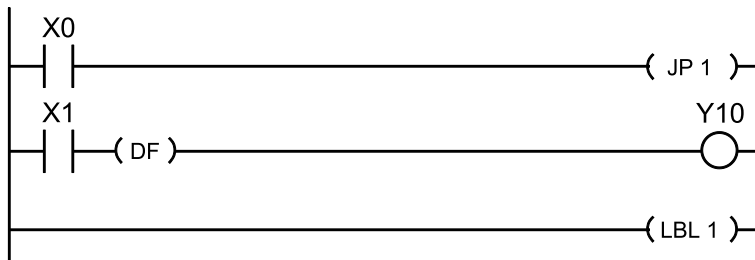

Timing chart 1

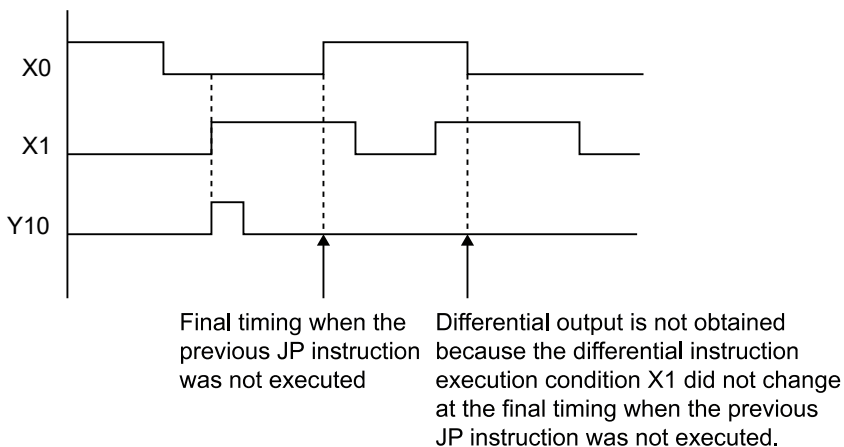

4.2 JP/LBL (Jump/Label)

Timing chart 2

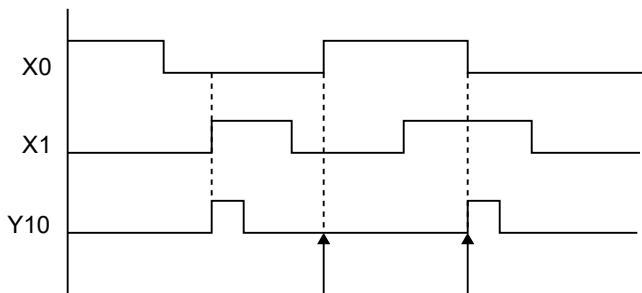

Final timing when the previous JP instruction was not executed

Differential output is not obtained because the differential instruction execution condition X1 changed OFF to ON at the final timing when the previous JP instruction was not executed.

- When the execution conditions for the **JP** instruction are the same as the execution conditions for the differential instruction, the leading edge (or trailing edge) of the execution condition for the differential instruction will not be detected. If differential output is required, write the differential instruction outside of the area between the **JP** and **LBL** instructions.

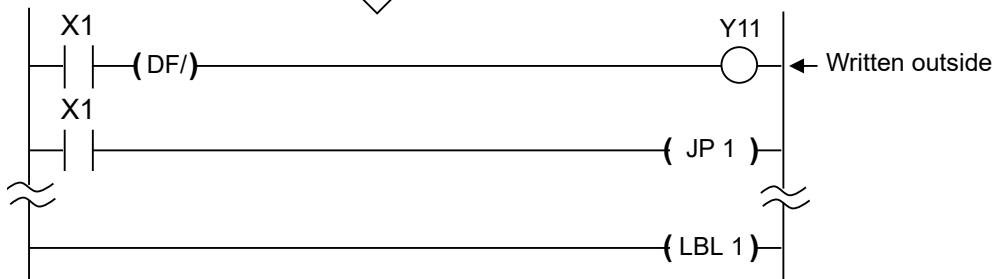
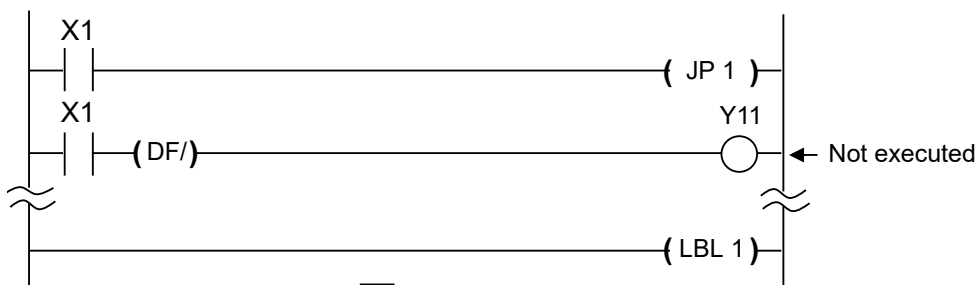

4.3 LOOP, LBL (Loop, Label)

■ Instruction format

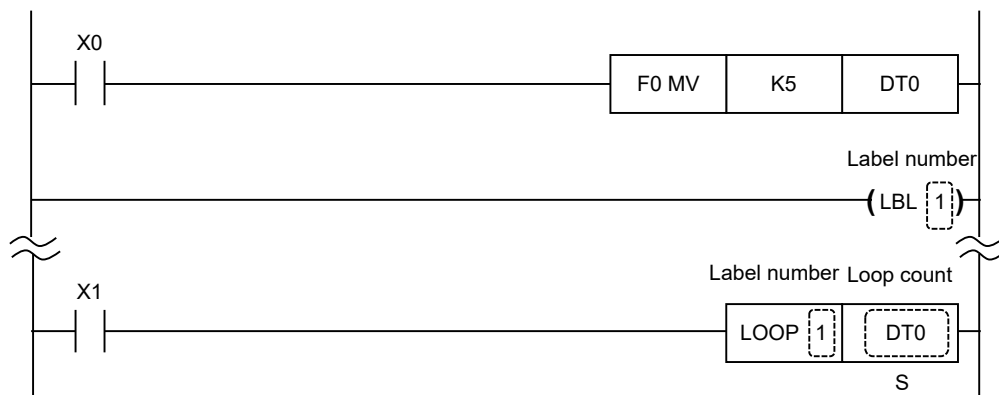

■ Instruction list

Instruction	Description
S	Area storing number of loop operations

■ Devices that can be specified (indicated by ●)

Operands	WX	WY	WR	WL	SV	EV	DT	LD	I	SWR	SDT	Constant				Index modifier	Integer Device
												K	H	M	f		
S		●	●	●	●	●	●	●	●								

■ Outline of operation

- When the execution condition turns ON, 1 is subtracted from the content of [S] and if the result does not equal 0, the operation jumps to the label (**LBL** instruction) with the same number as the specified number.
- Program execution continues starting from the instruction of the label at the jump destination.
- The **LOOP** instruction is used to set the number of times to execute the program. When the number of times (K constant) specified by [S] is reached, the operation does not jump even if the execution condition is established.

4.3 LOOP, LBL (Loop, Label)

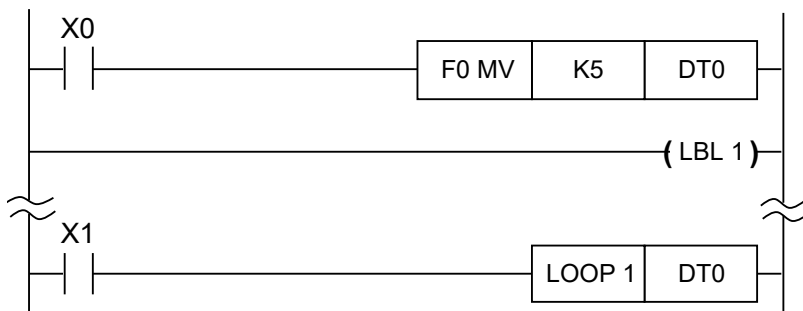

If DT0=K5, then after 5 jumps, there are no more jumps even if X1 is ON.

- If the memory area content specified by [S] is 0 from the start, the operation does not jump to a label number, and the next processing is performed.
- The same label is used by the **JP** instruction and the **LOOP** instruction. A label can be used as the jump destination for any instruction, as many times as required.

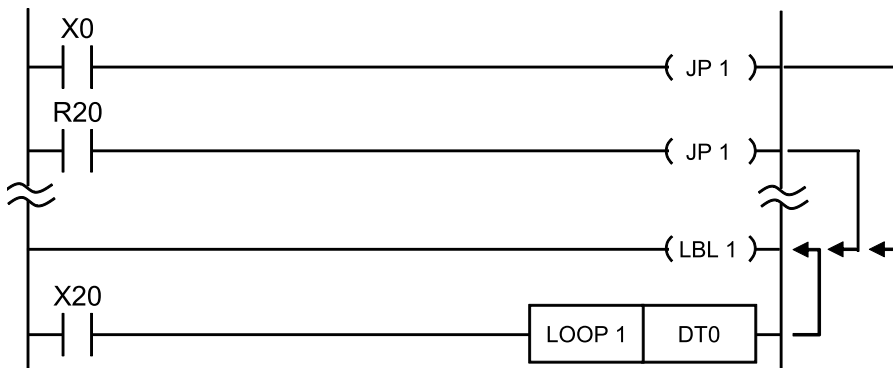

- Two or more **LBL** instructions with the same number cannot be written in the same program.
- If the jump destination label is not programmed, a syntax error occurs.

■ Operation of **TM**, **CT**, and **SR** instructions between **LOOP** and **LBL** instructions

- If the **LBL** instruction address is after that of the **LOOP** instruction, the **TM**, **CT**, and **SR** instructions are processed as follows when the **LOOP** instruction is executed.

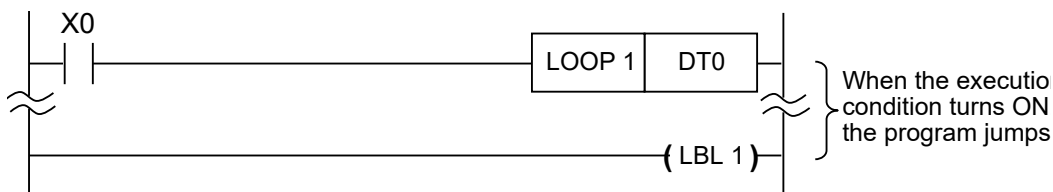

(1)	TM instruction	Clocking is not performed. If it is not executed once during a single scan, the correct time cannot be guaranteed.
(2)	CT instruction	Even if count input is ON, counting is not performed. The elapsed value is retained.
(3)	SR instruction	Even if shift input is ON, no shift is performed. The contents of the specified register are retained.

- If the **LBL** instruction address is before that of the **LOOP** instruction, the **TM**, **CT**, and **SR** instructions are processed as follows when the **LOOP** instruction is executed.

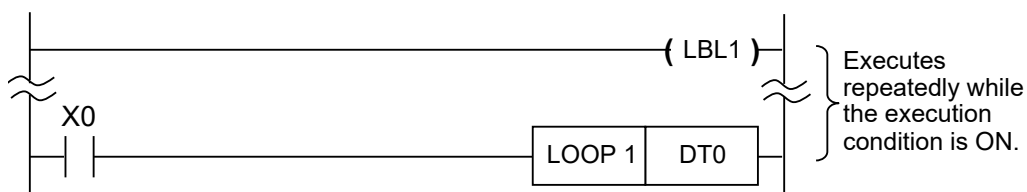

(1)	TM instruction	Multiple timings occur during a single scan, therefore the time cannot be guaranteed.
(2)	CT instruction	If the state of the count input does not change during the scan, it will operate in the usual way.
(3)	SR instruction	If the state of the shift input does not change during the scan, it will operate in the usual way.

■ Precautions for programming

- If the label is written to an address before the **LOOP** instruction, be aware of the following points.
 1. Ensure that the instruction for setting the loop count is written before **LBL** to **LOOP**. See the "P.4-12" program.
 2. Write each instruction repeatedly executed between **LBL** to **LOOP** so that they are executed under the same conditions as the **LOOP** instruction.
 3. During this repetition, it is possible that a single scan will exceed the operation bottleneck monitoring time and an operation bottleneck error may occur.

Example 1: When X5 turns ON, two F0 MV instructions are repeated five times.

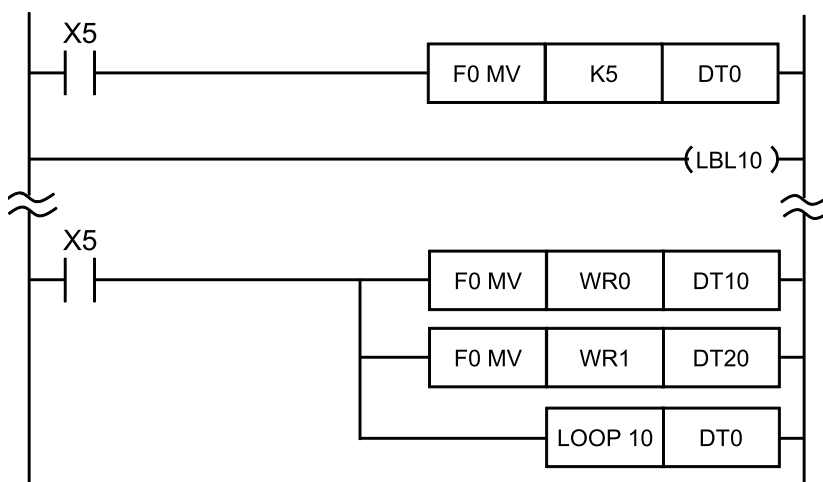

4.3 LOOP, LBL (Loop, Label)

Example 2: The DT100 value is transferred to DT200 to DT219.

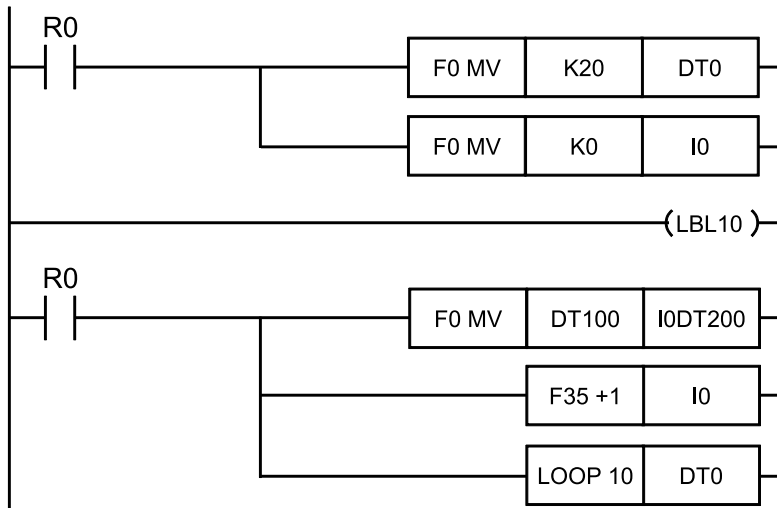

- The **LOOP** instruction and **LBL** instruction cannot be used in the step ladder area (**SSTP** to **STPE** range).
- It is not possible to jump from a main program to a subprogram (a subroutine or interrupt program after the **ED** instruction), from a subprogram to a main program, or from a subprogram to another subprogram.
- Caution is required when using an instruction that is executed by detecting the rise of an execution condition, such as a differential instruction (1 to 7 below).
 1. DF (rise differential)
 2. CT (counter) count input
 3. F118 UDC (up-down counter) count input
 4. SR (shift register) shift input
 5. F119 LRSR (left and right shift register) shift input
 6. NSTP (next step)
 7. Differential execution type high-level instruction (instruction specified by P and a number)

■ Flag operations

Name	Description
R9007 R9008 (ER)	Turns ON when the content of [S] is a negative value (the most significant bit is 1)

4.4 ED (End)

Indicates the end of a regular program area.

■ Instruction format

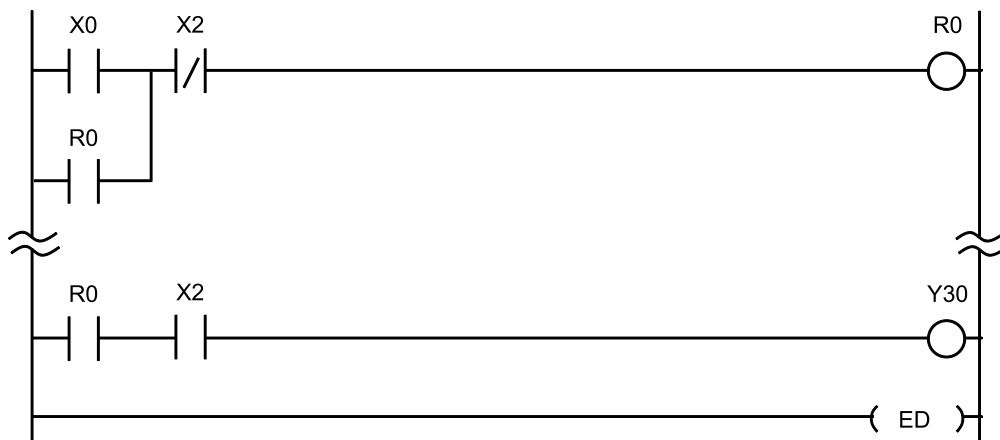

■ Outline of operation

- Write the **ED** instruction at the end of the regular program area.

Program area

Address

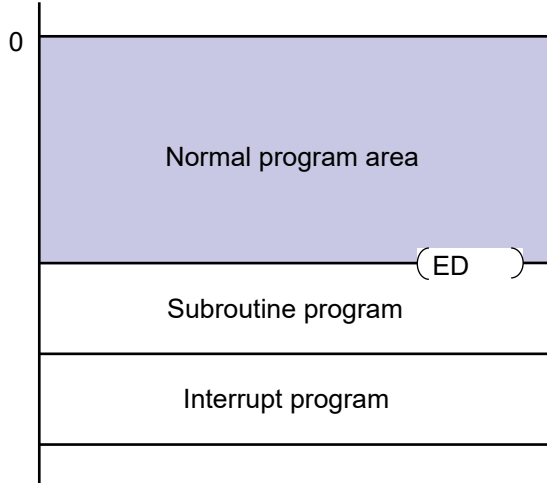

- Program areas are divided into the regular program area (main program) and "subroutine" and "interrupt program" areas (subprograms) using this instruction.
- Write subroutine programs and interrupt programs after the **ED** instruction.

4.5 CNDE (Conditional End)

4.5 CNDE (Conditional End)

■ Instruction format

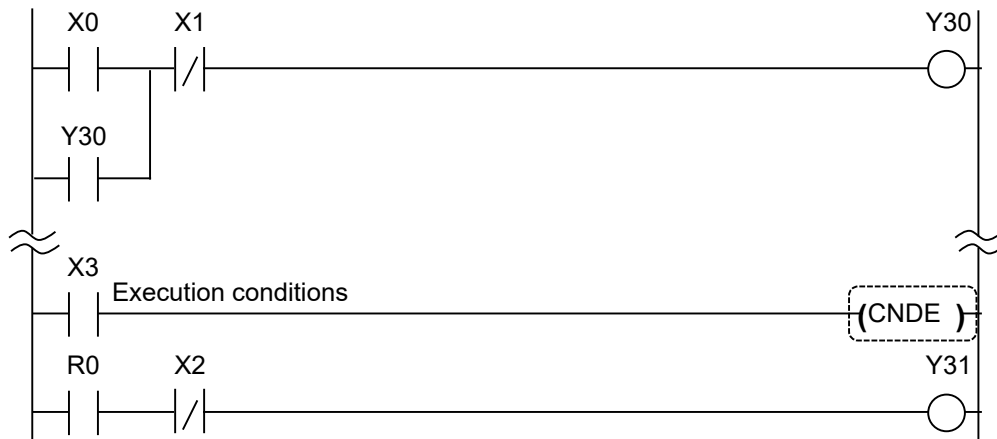

■ Outline of operation

- Ends arithmetic processing of the program at the specified address.
- When the execution condition turns ON, arithmetic processing of the program ends, and processing such as input and output is performed. When processing is complete, the operation returns to the starting address.
- The processing timing can be adjusted by performing the processing only after the required number of program scans are completed.
- The **CNDE** instruction is not available in a subprogram such as a subroutine or interrupt program. Use in the main program area.
- The **CNDE** instruction can be described any number of times in the main program.
- Caution is required when using an instruction that is executed by detecting the rise of an execution condition, such as a differential instruction (1 to 7 below).
 1. DF (rise differential)
 2. CT (counter) count input
 3. F118 UDC (up-down counter) count input
 4. SR (shift register) shift input
 5. F119 LRSR (left and right shift register) shift input
 6. NSTP (next step)
 7. Differential execution type high-level instruction (instruction specified by P and a number)

4.5 CNDE (Conditional End)

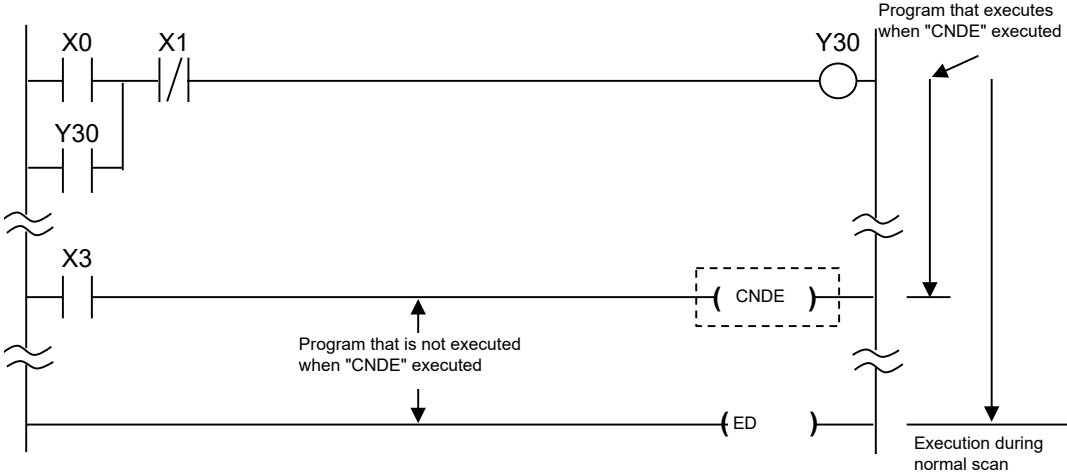

4.6 EJECT

4.6 EJECT

■ Instruction format

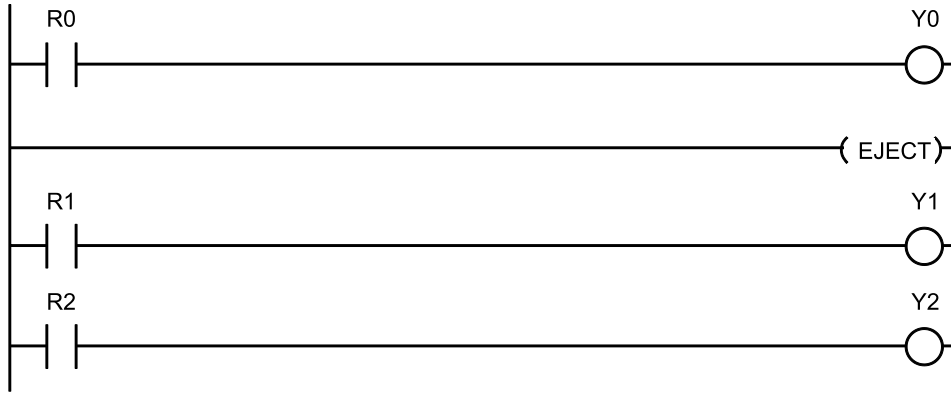

■ Outline of operation

- When printing out a program created using tool software, a page break occurs at the location at which this instruction is inserted.
- As with NOP instructions, no processing is performed in the program.

■ Operation example

Operation of instruction format description program

When printing out a created program, insert an EJECT instruction in the address where you would like a page break.

In the example above, a page break occurs at address 2.

5 Step ladder Instructions

5.1 SSTP, NSTL (NSTP), CSTP, STPE (Start Step, Next Step, Clear Step, Step End).....	5-2
5.2 SCLR (Clear Multiple Processes)	5-17

5.1 SSTP, NSTL (NSTP), CSTP, STPE (Start Step, Next Step, Clear Step, Step End)

5.1 SSTP, NSTL (NSTP), CSTP, STPE (Start Step, Next Step, Clear Step, Step End)

■ Instruction format



■ Outline of operation

- When the **NSTL** or **NSTP** instruction is executed, the process of the specified number starting from the **SSTP** instruction is started and executed.
- The program from the **SSTP** instruction to the next **SSTP** or **STPE** instruction is considered one process.

<Example>

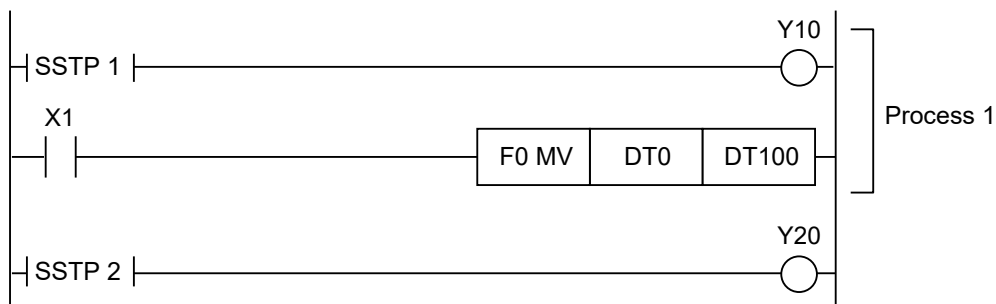

- These instructions make it easy to execute sequence control, selection branch control, parallel branch merge control, and similar operations.

1. Sequence control

Only the necessary processes are switched and executed in order.

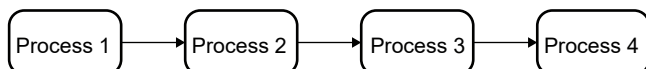

2. Selection branch control

5.1 SSTP, NSTL (NSTP), CSTP, STPE (Start Step, Next Step, Clear Step, Step End)

The processes are selected and executed according to conditions.

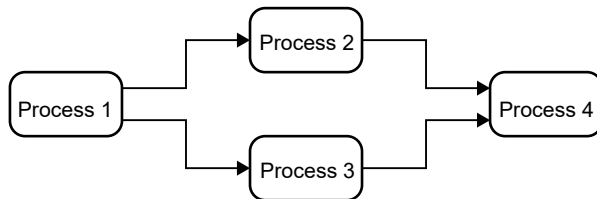

3. Parallel branch merge control

- Multiple processes are executed simultaneously.
- After each process is completed, the next process is executed.

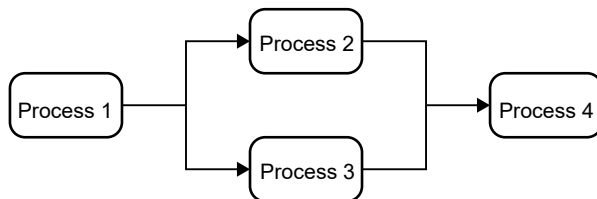

■ Syntax of step ladder instruction

SSTP start step

- This instruction indicates the "start of process n". Be sure to write "SSTP n" at the beginning of the process n program.



- Process n is defined as being from one "SSTP n" instruction to the next **SSTP** or **STPE** instruction.
- The same process number cannot be defined for more than one process.
- The **OUT** instruction can be connected directly from the bus bar immediately after the **SSTP** instruction.
- The **SSTP** instruction cannot be used in a subprogram (subroutine or interrupt program).
- The area starting from the first **SSTP** instruction to the **STPE** instruction is referred to as the "step ladder area". The programs in this area are all controlled as processes. Other areas are referred to as "normal ladder areas".

5.1 SSTP, NSTL (NSTP), CSTP, STPE (Start Step, Next Step, Clear Step, Step End)

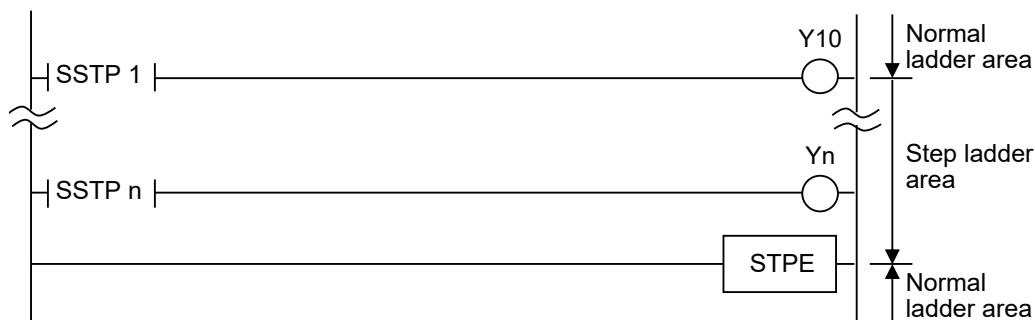

- There is a special internal relay that turns ON for one scan only when a process on the step ladder starts. (R9015: step ladder initial pulse relay.) This relay can be used to process only one scan when starting a process, such as resetting a counter.

NSTL next step (every scan execution type), NSTP next step (differential execution type)

- When an **NSTL n** or **NSTP n** instruction is executed, process n specified by n is invoked.
- The execution condition of the next step instruction becomes the start condition of the process.



- Write the process that starts first in the next step instruction in the normal ladder area.
- A process can be started from the normal ladder area or from a process that is executing.
- However, when you start a process with a next step instruction from within a process, the process that is executing and contains the next step instruction is automatically cleared and the specified process starts.

Be aware that the outputs and other processes are actually turned off by the clear operation during the next scan.

- The **NSTP** instruction is a differential execution type instruction, so it is executed for only one time when the execution condition rises. Also, since it only detects if the execution condition has changed between ON and OFF, the instruction is not executed when switching to "RUN mode" or when the power is turned ON while in "RUN mode" and the execution condition is already ON.

5.1 SSTP, NSTL (NSTP), CSTP, STPE (Start Step, Next Step, Clear Step, Step End)

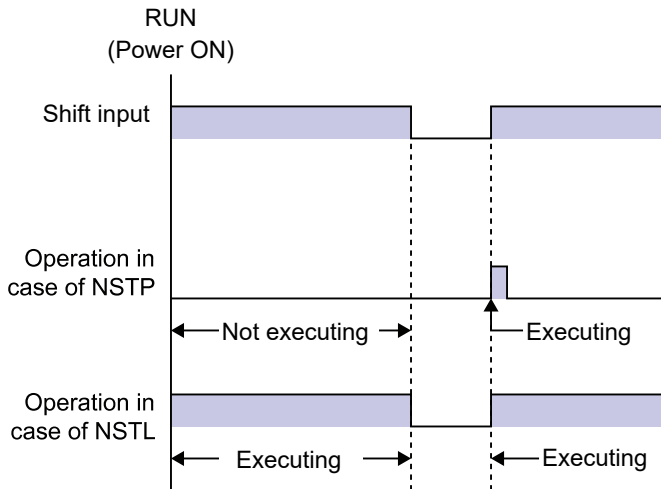

- Be aware that, if the **NSTP** instruction is used with instructions that change the order of execution such as the MC to MCE instructions or the JP to LBL instructions (see 1 to 6 below), the operation of instructions may change depending on the instruction execution and execution condition timing.
 1. MC to MCE instructions
 2. JP to LBL instructions
 3. LOOP to LBL instructions
 4. CNDE instruction
 5. Step ladder instructions
 6. Subroutine instructions
- When combining the NSTP instruction with an AND stack instruction or a POP stack instruction, be careful that the programming is correct.

CSTP clear step

When a **CSTPn** instruction is executed, process n specified by n is cleared. This instruction can be used to clear the final process or to clear the processes executing in parallel during parallel branch merge control.

<Example>



- A process can be cleared from the normal ladder area or from a process that is already started.
You can use the **SCLR** (block clear) instruction to clear multiple processes at once by specifying a range.

STPE step end

5.1 SSTP, NSTL (NSTP), CSTP, STPE (Start Step, Next Step, Clear Step, Step End)

Indicates the "end of the step ladder area". Be sure to write this instruction at the end of the final process. This makes the final process from **SSTP** to **STPE**.

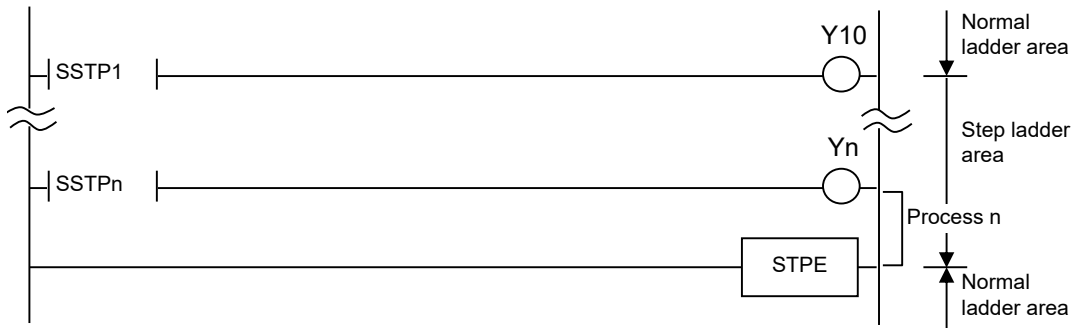

(Note 1) In this case, process n is the final process.

- The **STPE** instruction can only be written once, in the main program. (It cannot be written in subprograms such as subroutine programs and interrupt programs.)

■ Precautions for programming

- Processes do not need to be written in numerical order.
- In the step ladder area, you cannot use the following instructions:
 1. Jump instructions (**JP** and **LBL**)
 2. Loop instructions (**LOOP** and **LBL**)
 3. Master control instructions (**MC** and **MCE**)
 4. Subroutine instructions (**SUB** and **RET**) (*)
 5. Interrupt instructions (**INT** and **IRET**)
 6. **ED** instruction
 7. **CNDE** instruction

(Note): The **CALL** instruction can be used within the step ladder area.

- To clear all processes at once, use the master control relay in the program as follows.

e.g. All processes are cleared when X0 turns ON



5.1 SSTP, NSTL (NSTP), CSTP, STPE (Start Step, Next Step, Clear Step, Step End)

- Processes do not need to be started in numerical order. You can execute multiple processes simultaneously.
- When the output in a process that has not been started is forcibly turned ON or OFF, even if the forced ON/OFF operation is canceled, the output state will be held until the process starts.

■ Step ladder operations

- With step ladder operations, the program in the normal ladder area and the program in the processes invoked by the next step instruction (**NSTL** or **NSTP**) are executed. The program in processes that are not executing is ignored.

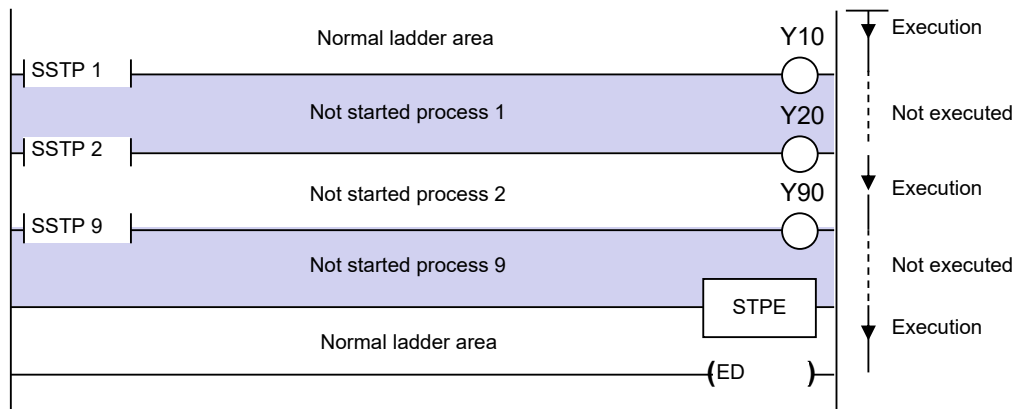

When only process 2 is executing as shown in the above figure, the program in the normal ladder area and in process 2 is executed.

- When a process is started and while the first scan is being performed, the step initial pulse relay (R9015) turns ON. It turns OFF for the second and subsequent scans. This relay can be used to reset counters and shift registers.

■ Precautions for clearing a process

- If the next step instruction is executed in an active process, that process is automatically cleared. However, the actual clear operation does not occur until the next scan. For this reason, when a process transitions, two processes may be executing at the same time for one scan. To prevent simultaneous execution of a set of outputs that should not be ON at the same time, write an interlock into the program. (If there is a possibility of processes being simultaneously ON because of hardware response delays, take measures in the hardware processing to allow the response delay to be taken into account, even if the program includes an interlock.)

5.1 SSTP, NSTL (NSTP), CSTP, STPE (Start Step, Next Step, Clear Step, Step End)

<Example>

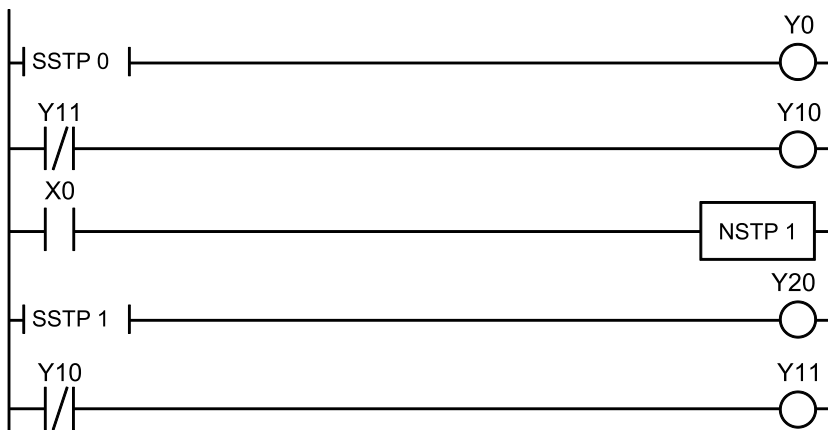

- When a process is cleared, the operation of each instruction used in that process is as follows.

OT instruction	All OFF
KP instruction	Holds the state
SET instruction	Holds the state
RST instruction	Holds the state
TM instruction	Resets the elapsed value and timer contact output
CT instruction	Holds the intermediate process
SR instruction	Holds the intermediate process
Differential instruction	Holds the state of the execution condition (Note 1)
Other instructions	Not executed

(Note 1) This is the same operation as when the execution condition of the **MC** instruction turns OFF. Refer to the explanation of the **MC** and **MCE** instructions.

- Caution is required when using an instruction that is executed by detecting the rise of an execution condition, such as a differential instruction (1 to 7 below).
 - DF (rise differential)
 - CT (counter) count input
 - F118 UDC (up-down counter) count input
 - SR (shift register) shift input
 - F119 LRSR (left and right shift register) shift input
 - NSTP (next step)
 - Differential execution type high-level instruction (instruction specified by P and a number)

■ Examples of step ladder instructions

(1) Sequence control

This is a program that repeats the work in a certain process until it is completed, and then moves to the next process.

- In the program, write the instruction to start the process to be executed next in each process. When the start instruction is executed, the next process is started, and the process that had been executing is cleared.

5.1 SSTEP, NSTL (NSTP), CSTEP, STEP (Start Step, Next Step, Clear Step, Step End)

- Processes do not need to be executed in numerical order. You can also program the start instruction to invoke a previous process according to conditions.

[Program example]

1. When X10 turns ON, process 10 is executed.
2. When X11 turns ON, process 10 is cleared and process 11 is executed.
3. When X12 turns ON, process 11 is cleared and process 12 is executed.
4. When X14 turns ON, process 12 is cleared and step ladder operation finishes.

- **Process flowchart**

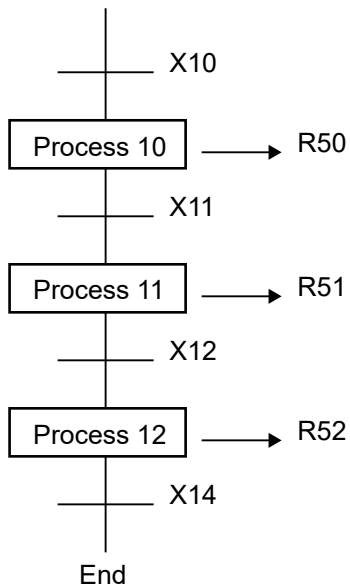

5.1 SSTP, NSTL (NSTP), CSTP, STPE (Start Step, Next Step, Clear Step, Step End)

• Program

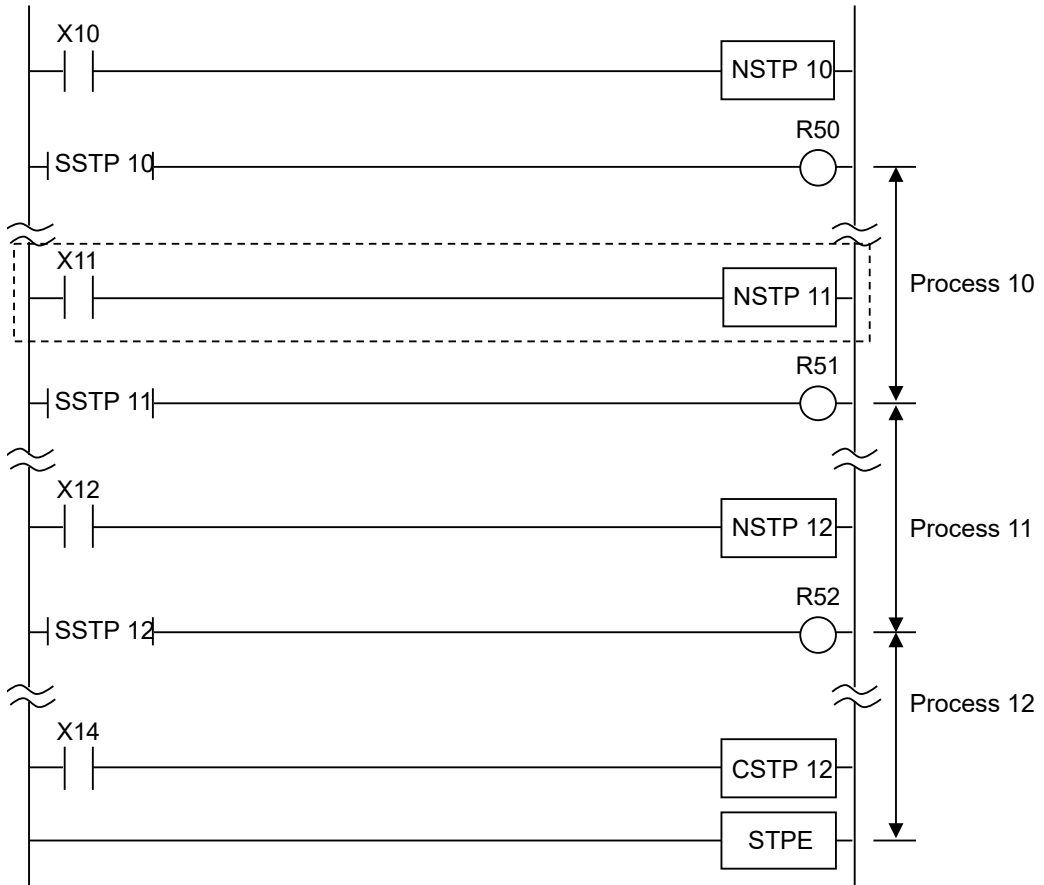

• Timing chart

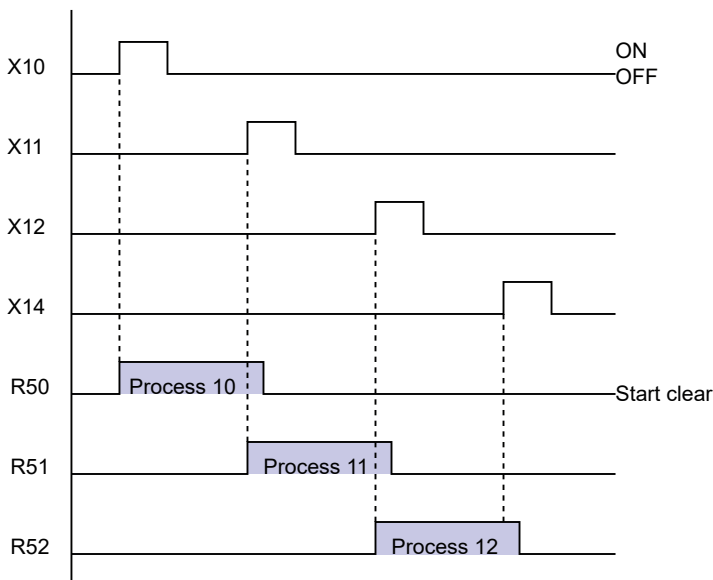

(2) Selection branch control of a process

This program selects and switches to the next process according to the actions and results of a particular process. Each process loops until its work is completed.

- In the program, write the instruction to start the process to be executed next in each process. The next process is selected and program execution is transferred according to the execution conditions.

[Program example]

1. When X100 turns ON, process 100 is executed.
2. While process 100 is executing,
 - when X101 turns ON, process 101 is executed.
 - Or when X102 turns ON, process 102 is executed.
3.
 - While process 101 is executing, when X103 turns ON, process 101 is cleared and process 200 is executed.
 - While process 102 is executing, when X104 turns ON, process 102 is cleared and process 200 is executed.
4. When X200 turns ON, process 200 is cleared and step ladder operation finishes.

• Process flowchart

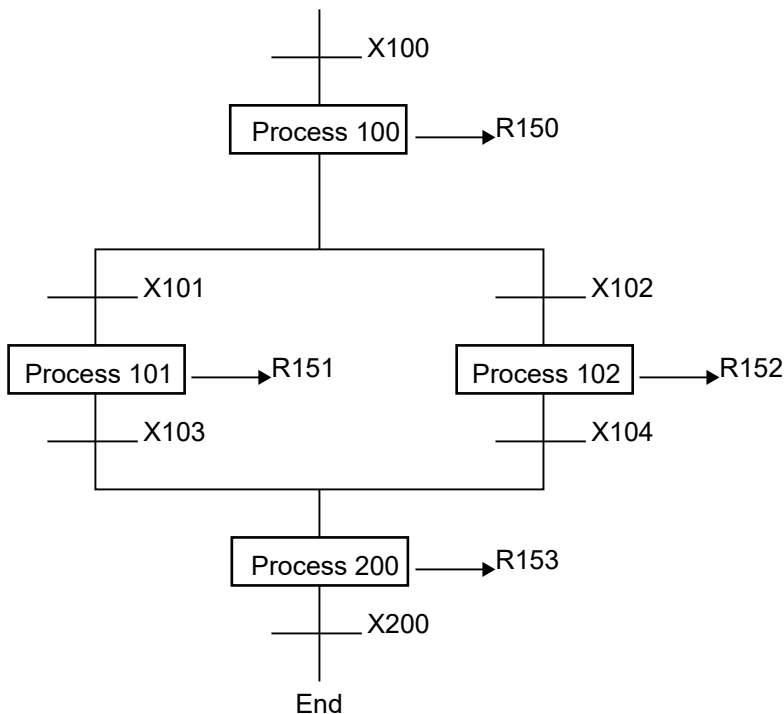

5.1 SSTP, NSTL (NSTP), CSTP, STPE (Start Step, Next Step, Clear Step, Step End)

• Program

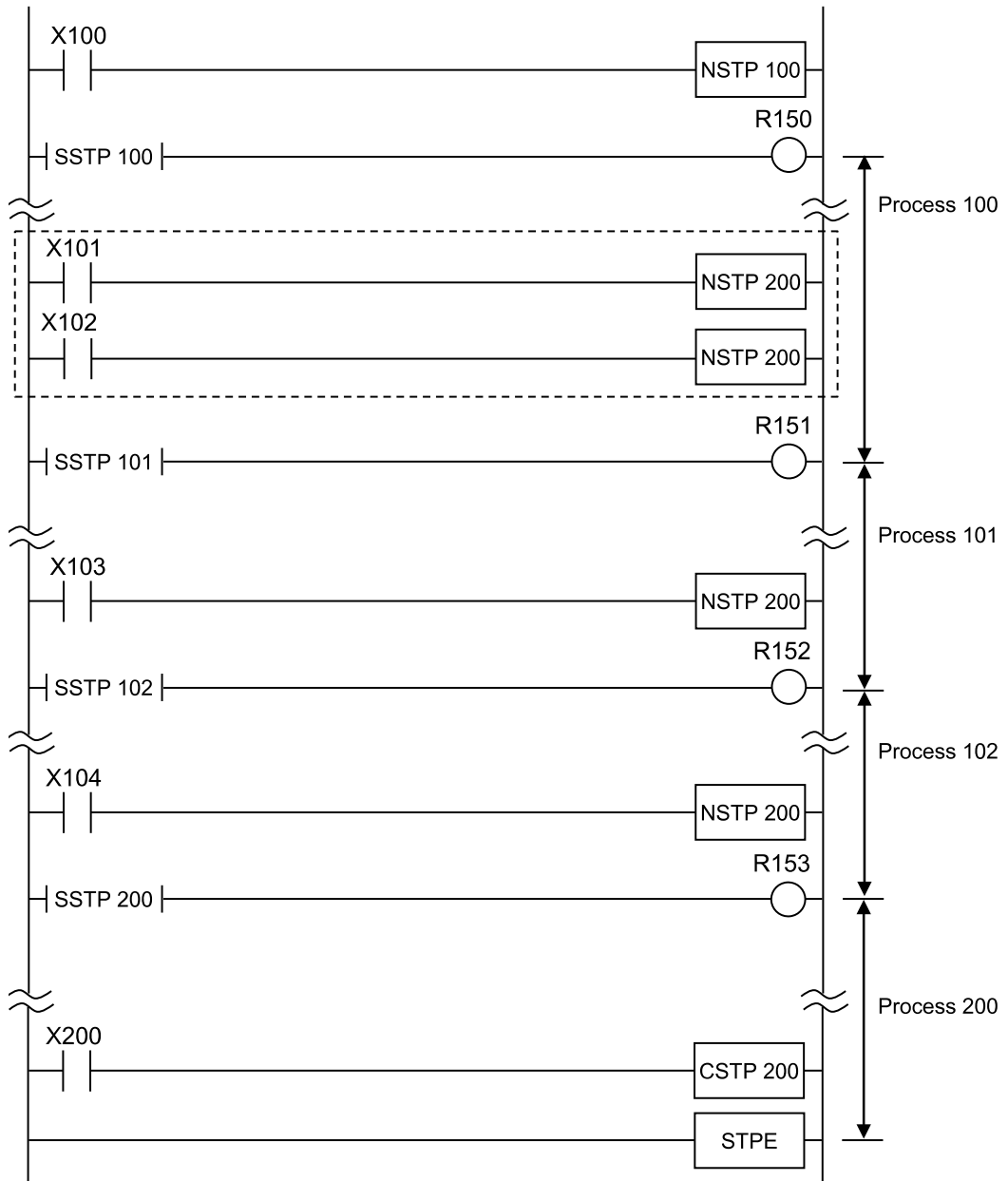

• Timing chart

This is an example of when X101 turns ON.

5.1 SSTP, NSTL (NSTP), CSTP, STPE (Start Step, Next Step, Clear Step, Step End)

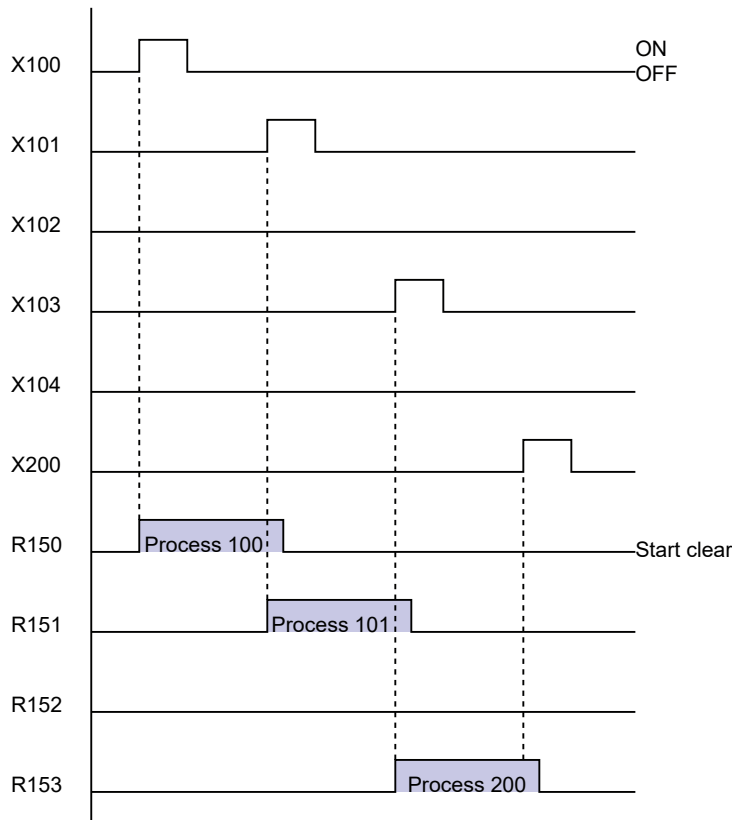

(3) Parallel branch merge control of a process

This program starts multiple processes at the same time. When the work is completed in each of the branched processes, they merge again before transferring execution to the next process.

- In the program, write multiple process transfer instructions for one execution condition in succession in a process.
- To merge processes, include a flag indicating the state of the other processes in the transfer condition for the next process. When they merge and execute the next process, clear all uncleared processes at the same time.

[Program example]

1. When X0 turns ON, process 0 is executed.
2. When X10 turns ON, process 0 is cleared and process 10 and process 20 are executed simultaneously (parallel branch).
3. When X11 turns ON, process 10 transitions to process 11.
4. With processes 11 and 20 executing, when X30 turns ON, execution transfers to process 30 (merge).
 - Process 20 is cleared with the clear instruction.
 - Process 11 is cleared and process 30 is executed.
5. When X31 turns ON, process 30 is cleared and process 0 is executed again.

5.1 SSTP, NSTL (NSTP), CSTP, STPE (Start Step, Next Step, Clear Step, Step End)

- Process flowchart

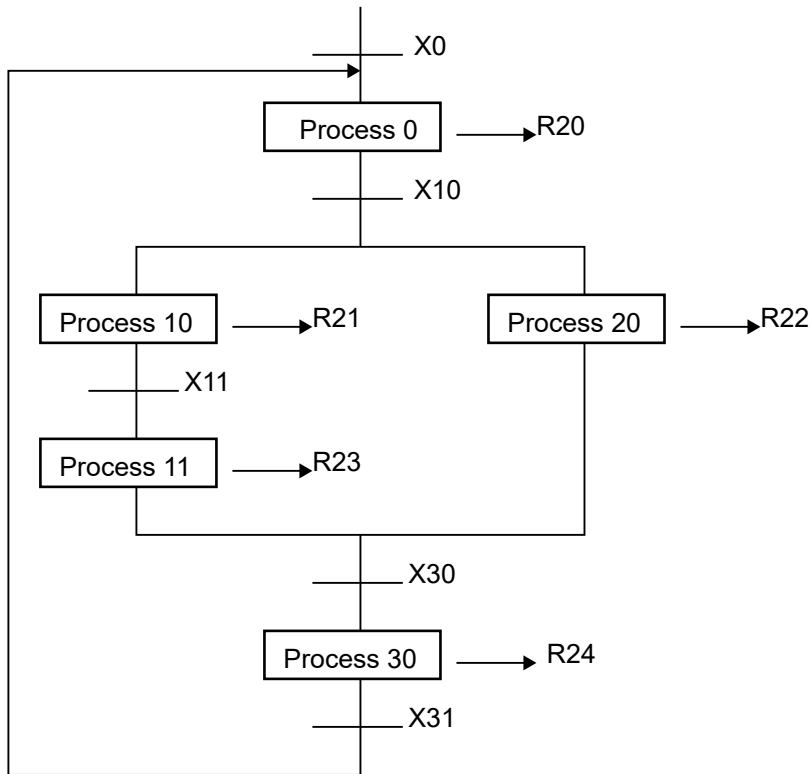

5.1 SSTP, NSTL (NSTP), CSTP, STPE (Start Step, Next Step, Clear Step, Step End)

• Program

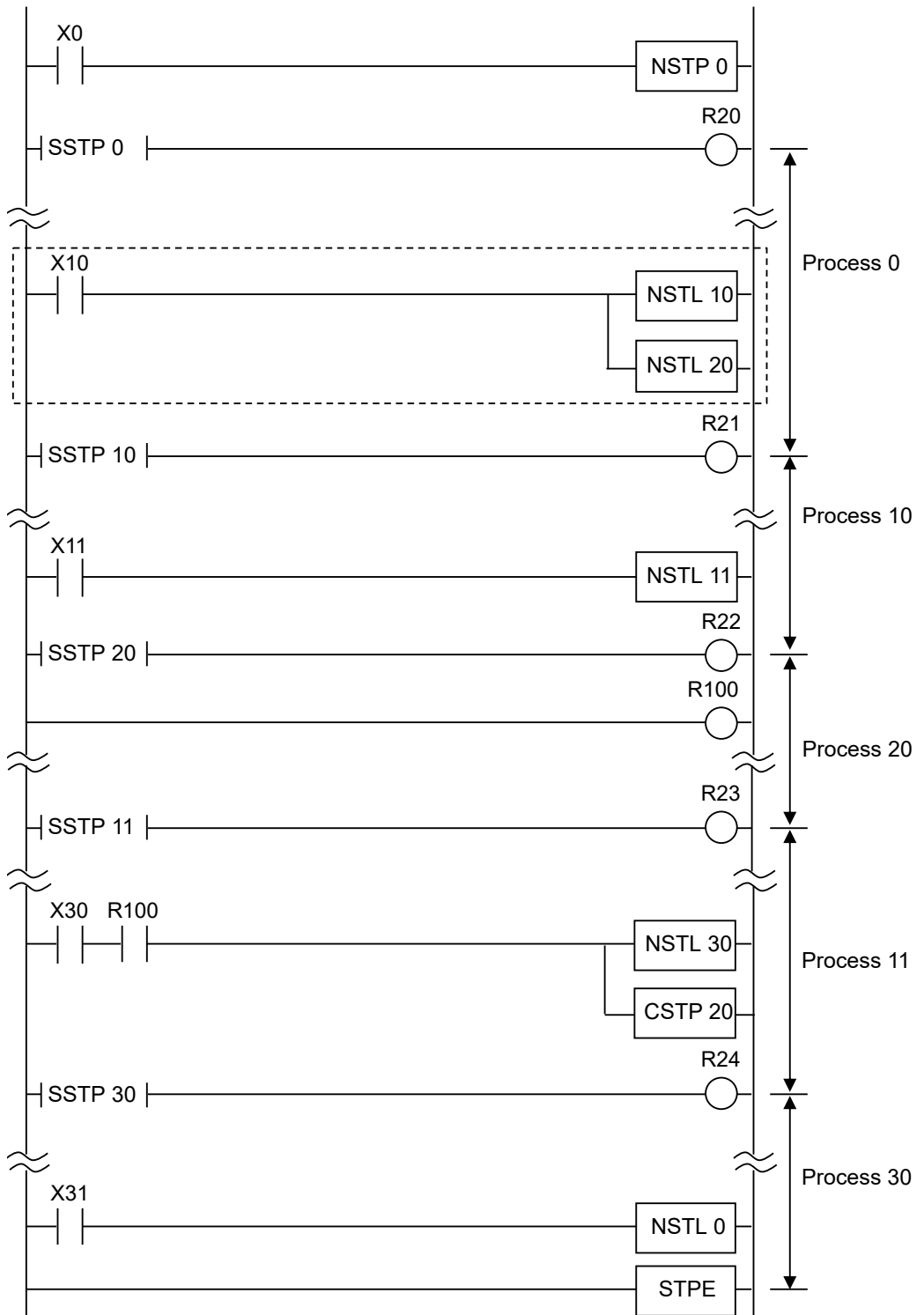

5.1 SSTP, NSTL (NSTP), CSTP, STPE (Start Step, Next Step, Clear Step, Step End)

• Timing chart

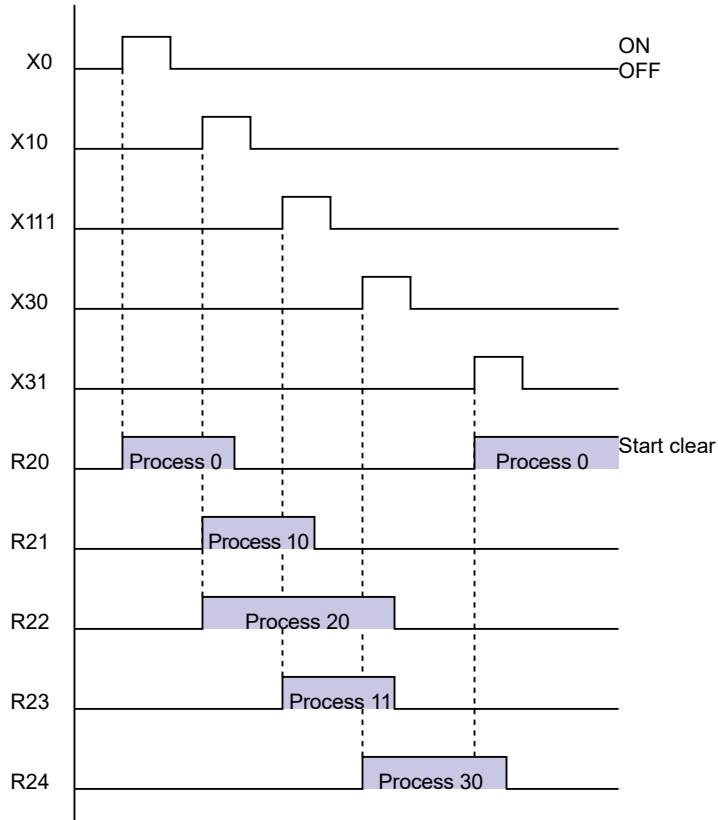

5.2 SCLR (Clear Multiple Processes)

■ Instruction format

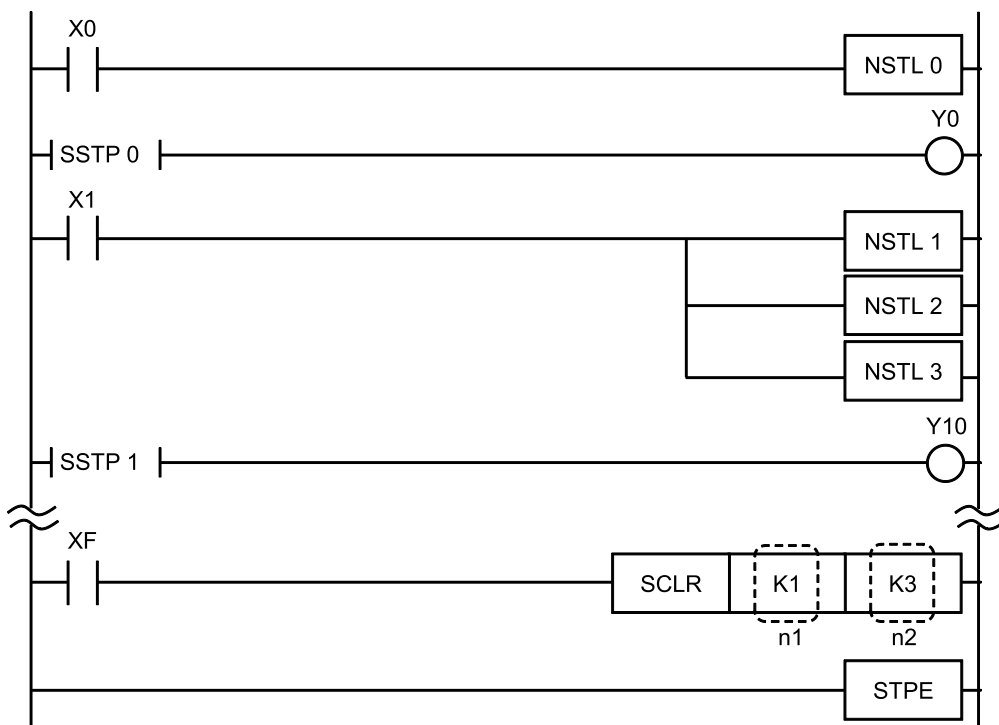

■ Outline of operation

When the **SCLR** instruction is executed, all active processes from process n1 through process n2 are cleared.

■ Operation example

Operation of instruction format description program

When input XF turns ON, active processes from 1 through 3 are cleared.

5.2 SCLR (Clear Multiple Processes)

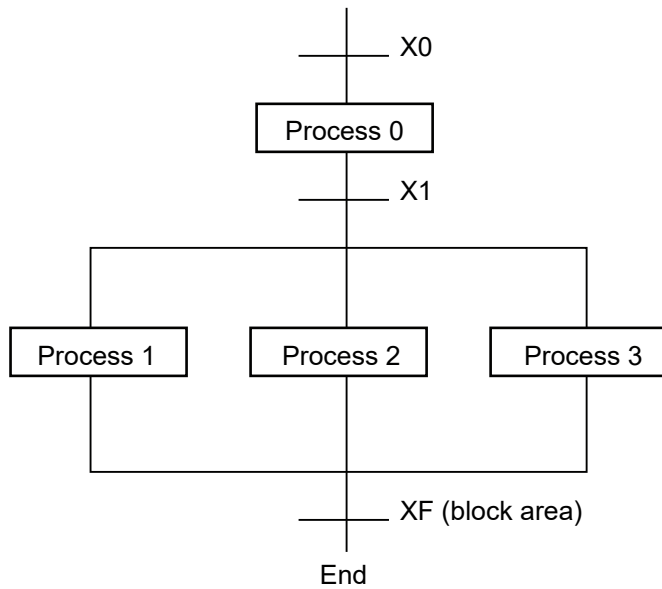

■ Precautions for programming

- Specify values so that n1 is equal to or smaller than n2.
- The **SCLR** instruction can be executed from both normal ladder areas and active processes.

6 Subroutine Instructions

6.1 CALL/SUB/RET (Subroutine Call, Subroutine Entry, Subroutine Return)6-2

6.1 CALL/SUB/RET (Subroutine Call, Subroutine Entry, Subroutine Return)

6.1 CALL/SUB/RET (Subroutine Call, Subroutine Entry, Subroutine Return)

■ Instruction format



■ Outline of operation

- When the execution condition turns ON, the **CALL** instruction is executed and the subroutine program of the specified number starting from the **SUB** instruction is executed.
- When the **RET** instruction is executed, the program returns to the address following the **CALL** instruction in the main program and execution of the main program continues.

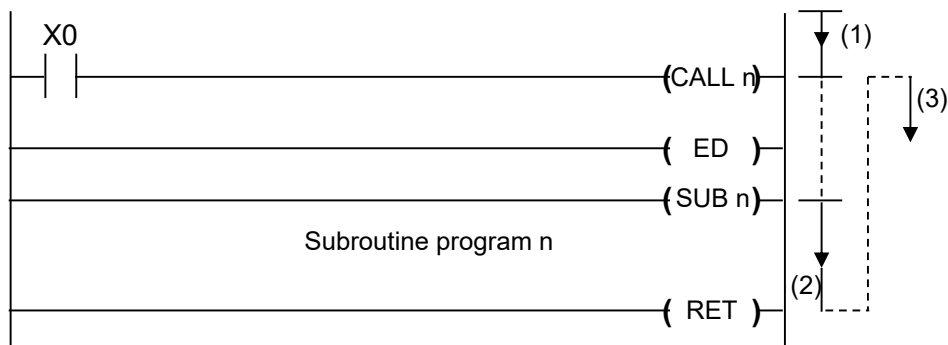

CALL n is executed in the order of (1) to (3).

■ Subroutine program syntax

- "Subroutine program n" is the program between the **SUB n** instruction and the **RET** instruction. Always write a subroutine to an address after the **ED** instruction.
- The **CALL n** instruction can be described in the main program and any other subroutine program, interrupt program, or step ladder. Additionally, a **CALL** instruction with the same number can be repeated.
- Subroutines can be nested up to 5 layers deep.

6.1 CALL/SUB/RET (Subroutine Call, Subroutine Entry, Subroutine Return)

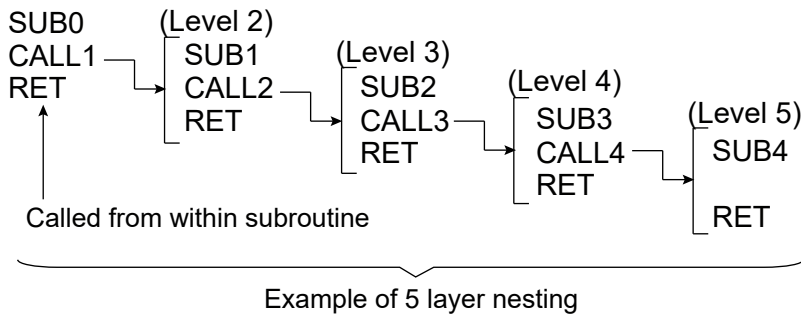

■ Precautions for programming

- A subroutine program cannot be described in an interrupt program.

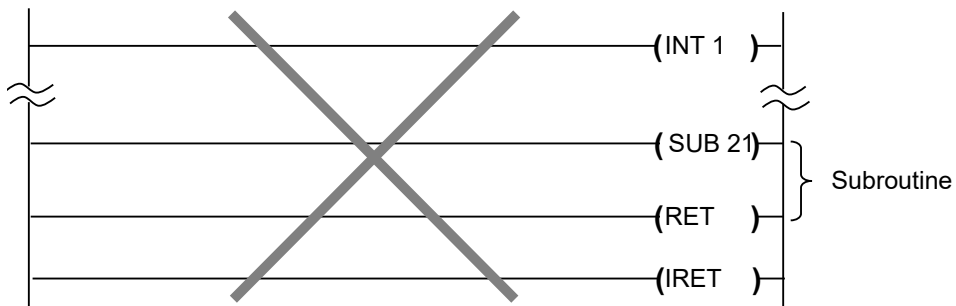

- An interrupt program cannot be described in a subroutine program.

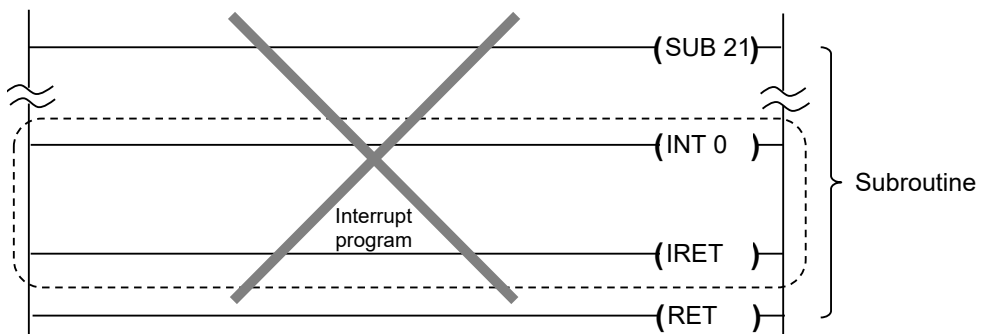

- Caution is required when using an instruction that is executed by detecting the rise of an execution condition, such as a differential instruction (1 to 7 below), in a subroutine.
 1. DF (rise differential)
 2. CT (counter) count input
 3. F118 UDC (up-down counter) count input
 4. SR (shift register) shift input
 5. F119 LRSR (left and right shift register) shift input
 6. NSTP (next step)
 7. Differential execution type high-level instruction (instruction specified by P and a number)

6.1 CALL/SUB/RET (Subroutine Call, Subroutine Entry, Subroutine Return)

■ Operation when the execution condition of the CALL instruction turns OFF

When the execution condition of the **CALL** instruction turns OFF, the operation of that subroutine is not performed (the same applies to calls in master control and step ladders). In this case, the operation of each instruction used in the subroutine is as follows.

OT instruction	Holds the state.
KP instruction	Holds the state.
SET instruction	Holds the state.
RST instruction	Holds the state.
TM instruction	Clocking is not performed. Note that the time cannot be guaranteed if clocking is not performed once during a scan.
CT instruction	Holds the current progress.
SR instruction	Holds the current progress.
Differential instruction	The same as when a differential instruction is used between MC and MCE.
Other instructions	Not executed.

■ Flag operations

Name	Description
R9007 R9008 (ER)	Turns ON when the CALL instruction is executed in the 5th layer of a subroutine when 5-layer nesting is being performed

7 Interrupt Instructions

7.1 INT/IRET (Interrupt / Interrupt Return).....	7-2
7.2 ICTL (Interrupt Control).....	7-8
7.2.1 How to start the interrupt program when executing the high-speed counter match ON / match OFF instruction	7-15

7.1 INT/IRET (Interrupt / Interrupt Return)

7.1 INT/IRET (Interrupt / Interrupt Return)

■ Instruction format

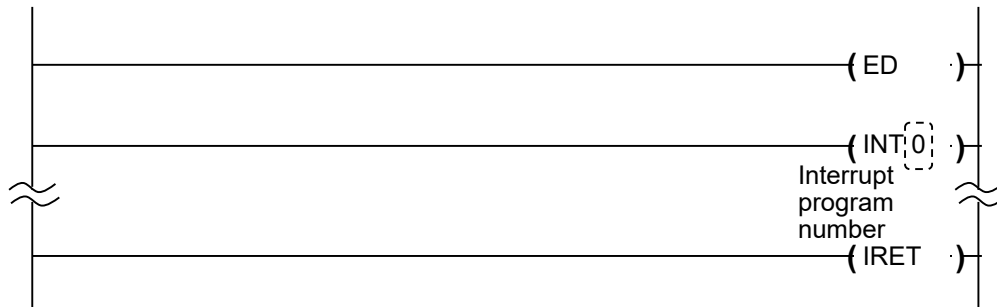

■ Outline of operation

- When an interrupt is input, the interrupt program of the number specified is executed starting from the **INT** instruction.
- When the interrupt program reaches the **IRET** instruction, the program returns to the address where the interrupt occurred and the main program resumes.

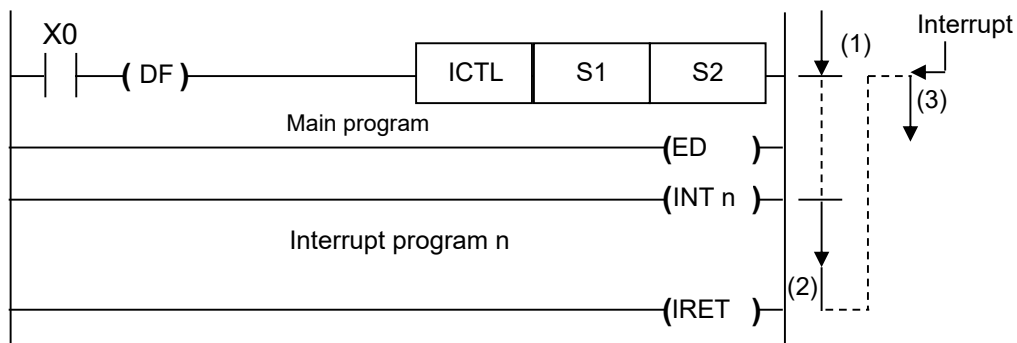

When an interrupt occurs, execution will occur in the order of (1) to (3).

■ Interrupt Program Syntax

- The interrupt program is the program between the **INT n** instruction and the **IRET** instruction. The interrupt program must always be placed in an address after the **ED** instruction.
- The number of the interrupt program is determined by the type of interrupt.

Interrupt program number	Interrupt input	High-speed counter target value match interrupt
INT0	X0	ch0
INT1	X1	ch1
INT2	X2	-
INT3	X3	ch2
INT4	X4	ch3
INT5	X5	-

Interrupt program number	Interrupt input	High-speed counter target value match interrupt
INT6	X6	-
INT7	X7	-
INT8	-	-
INT9	-	-
INT10	-	-
INT11	-	-
INT12	-	-
INT13	-	-
INT24	Periodic interrupt	-

(Note 1) When using a high-speed counter target value match interrupt program, the counting performance of the high-speed counter may decrease upon initiation of the interrupt program.

■ Before inputting an interrupt program

- Specify the contact to be used as the interrupt input.
Select the input contact to be used as the interrupt input and specify it in system register No. 403.

Note

- If the high-speed counter/pulse catch is set, that contact cannot be used as the interrupt input.
 - There is no need to specify the input contact for high-speed counter target value match interrupts and periodic interrupts.
- "Enable" execution of interrupt programs.
All interrupt programs are set to "execution disabled" as default. "Enable" interrupt programs to be executed using the **ICTL** instruction.

■ Precautions when rewriting during RUN

If the program is rewritten in "RUN mode", all interrupt programs will be set to "execution disabled", making it necessary to "enable" them after rewriting in RUN.

To automatically re-enable with a ladder program, use R9034 (rewrite during RUN completion flag). R9034 is a special relay that is ON for only 1 scan after completion of a rewrite during RUN.

■ Interrupt program execution

There are three types of interrupt.

- Interrupt from the input contact
An interrupt occurs from the input specified in system register No. 403.
- High-speed counter target value match interrupt
When executing a high-speed counter instruction, an interrupt occurs when the high-speed counter elapsed value equals the set target value.
- Periodic interrupt (INT24)
The interrupt occurs in fixed time intervals. The time interval is set with the **ICTL** instruction.

7.1 INT/IRET (Interrupt / Interrupt Return)

- If the interrupt occurs, the interrupt program with the corresponding number is executed.

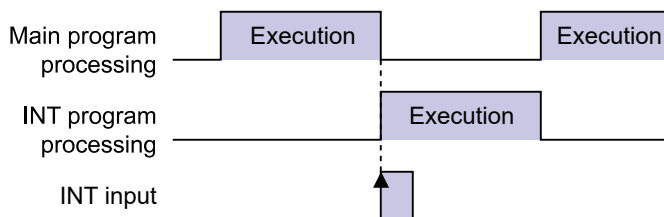

- If interrupts are disabled, they will be executed when execution is enabled with the **ICTL** instruction.

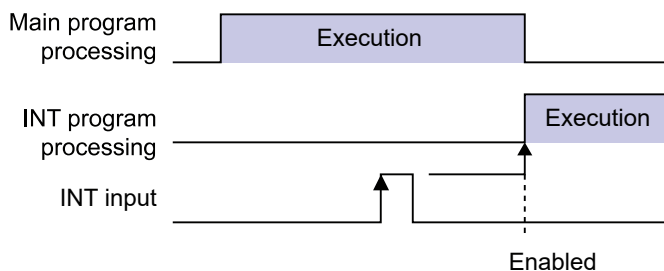

- If an interrupt occurs during execution of another interrupt program, it will be executed after the other program finishes.

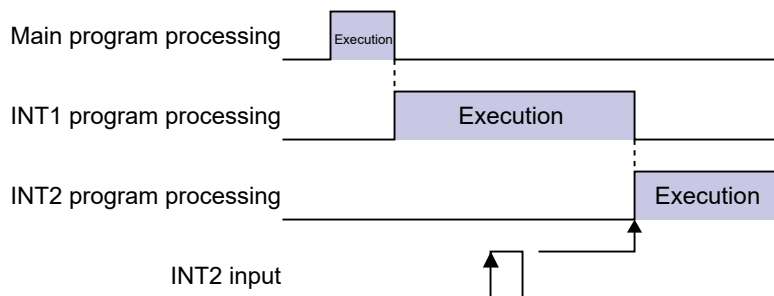

■ Precautions for programming

- A syntax error will occur if either the **INT** instruction or **IRET** instruction is missing.
- When an interrupt occurs, the operation memory corresponding to the interrupt input contact is not I/O refreshed. Therefore, contacts other than the interrupt input contact, such as the normally ON relay R9010, should be specified by the input conditions in the interrupt program.

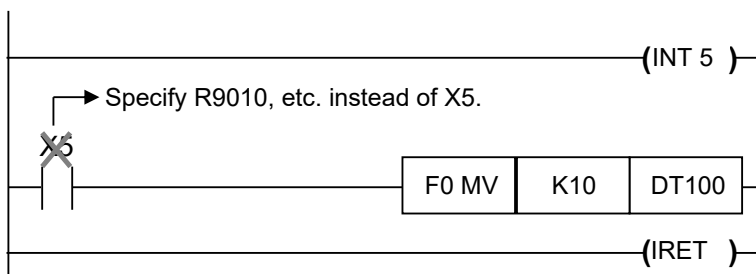

- A subroutine program cannot be used in an interrupt program.

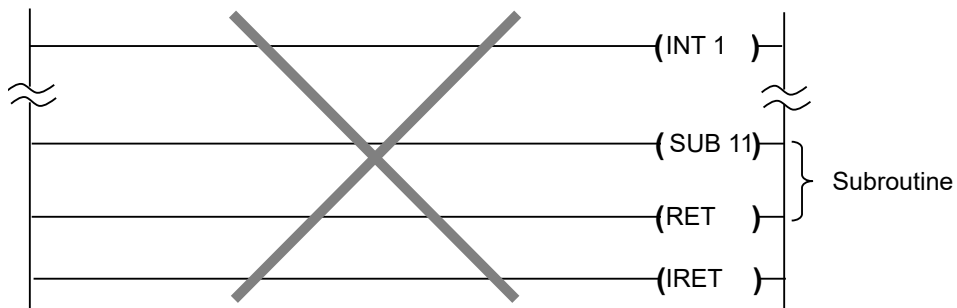

- An interrupt program cannot be used in a subroutine program.

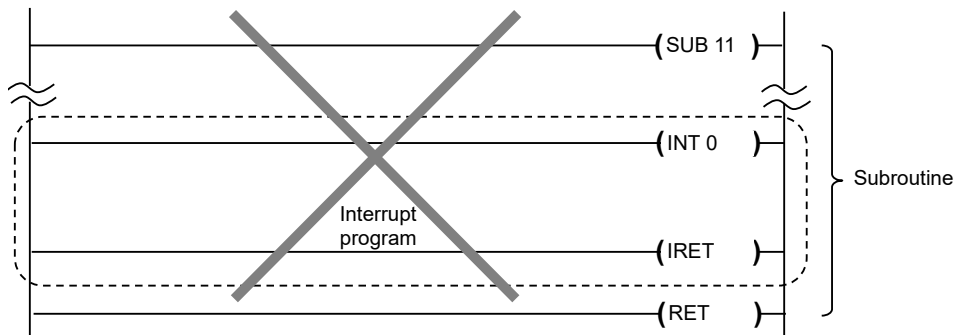

- Another interrupt program cannot be used in an interrupt program.

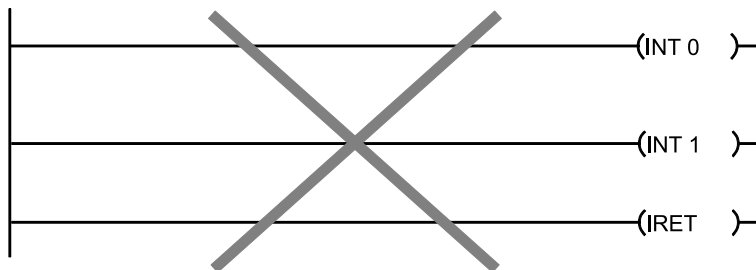

■ Control when multiple interrupts occur simultaneously

- When multiple interrupts occur simultaneously, the interrupt program with the smallest number is executed first. The other interrupt programs are then placed into an execution waiting state. After the first interrupt program is completed, the other programs will be executed in order from the smallest number.

7.1 INT/IRET (Interrupt / Interrupt Return)

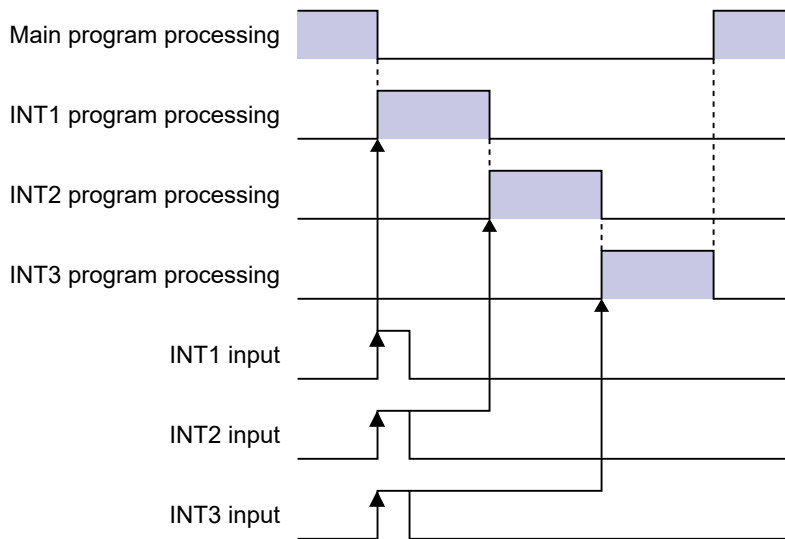

- When multiple interrupts occur during execution of an interrupt program, they will be executed in order from the smallest program number when the program has finished execution.

e.g.

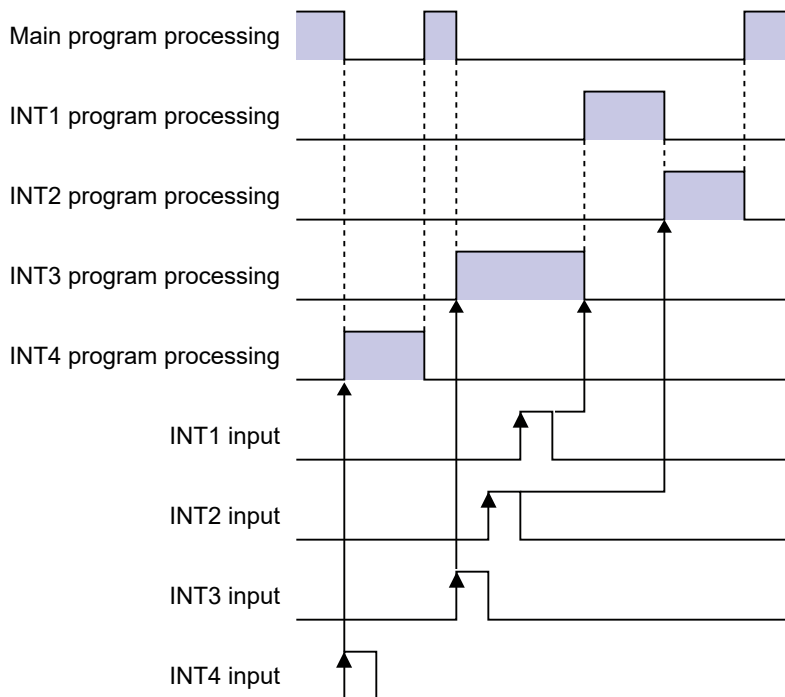

(Note 1) During execution of the INT3 program in the example above, INT1 will be executed before INT2, even if interrupt INT2 occurs before INT1.

■ Interrupt program execution waiting and clearing

- When multiple interrupts occur simultaneously or when a new interrupt occurs during execution of another interrupt program, the interrupts of lower priority will enter an "execution wait state". They will be executed in order when the other interrupt program finishes execution.

e.g.

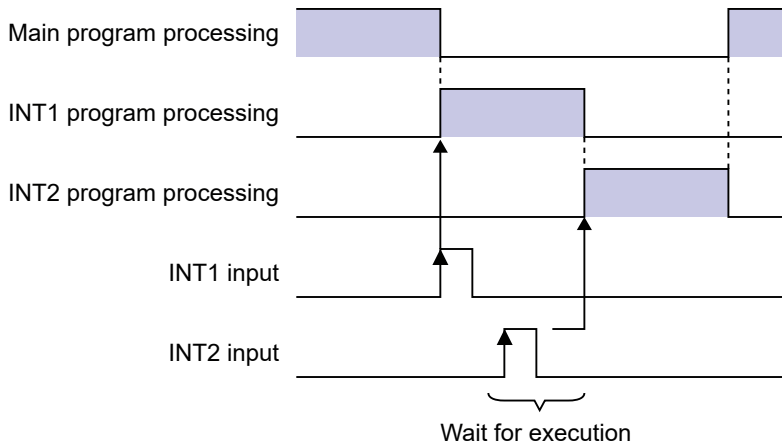

- If placed in execution wait state, there is a time difference between the occurrence of the interrupt and execution of the interrupt program. To avoid execution of these execution wait state programs, clear them using the **ICTL** instruction. Cleared interrupt programs will not be executed.

e.g.

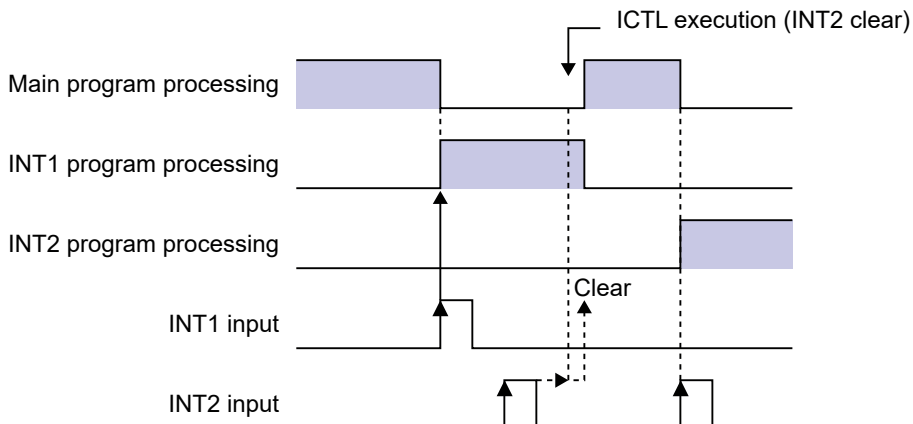

- Even when execution of interrupt programs is disabled with the **ICTL** instruction, if an interrupt occurs it will enter an "execution wait state". Waiting interrupt programs will be executed upon enabling execution with the **ICTL** instruction. As noted above, the interrupt programs in an execution wait state can be cleared by using the **ICTL** instruction.

7.2 ICTL (Interrupt Control)

7.2 ICTL (Interrupt Control)

■ Instruction format

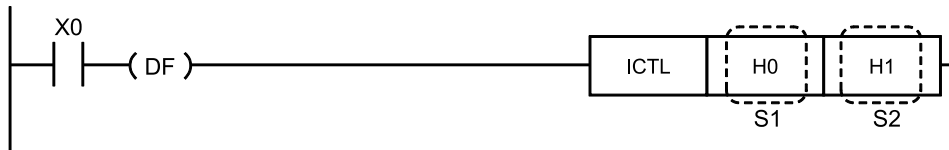

■ Operands

Items	Settings
S1	Area storing the control data, or constant data
S2	Area storing the control data, or constant data

■ Devices that can be specified (indicated by ●)

Operands	WX	WY	WR	WL	SV	EV	DT	LD	I	SWR	SDT	Constant				Index modifier	Integer Device
												K	H	M	f		
S1	●	●	●	●	●	●	●	●	●			●	●			●	
S2	●	●	●	●	●	●	●	●	●			●	●			●	

■ Outline of operation

- When the ICTL instruction is executed, based on the content of [S1] and [S2], either (1) enabling or disabling of the interrupt program is specified, or (2) clearing of the interrupt program is specified.
 - Perform differential execution using an instruction such as **DF** so that it is only executed once when setting.
 - Multiple ICTL instructions can be written consecutively for a single execution condition.
- Always execute this instruction before executing an interrupt program to enable interruption.

■ Precautions when rewriting during RUN

- If a rewrite during RUN is performed while using an interrupt function, the interrupt function will be disabled. It is necessary to re-enable execution of the interrupt program with an ICTL instruction.

e.g. A periodic interrupt every 10 ms is set at the start of operation (re-enables interrupt after rewriting during RUN.)

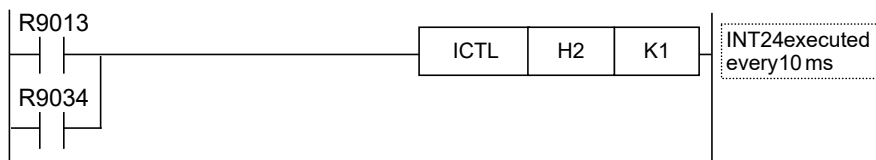

■ Description examples

Example 1) Setting a periodic interrupt every 10 ms at the start of operation

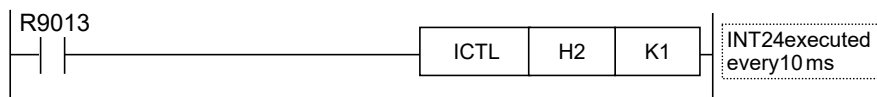

(Note 1) R9013 (initial pulse relay) is a relay that turns ON in only the first scan after execution begins.

Example 2) Enabling INT0 to 3 when X0 rises

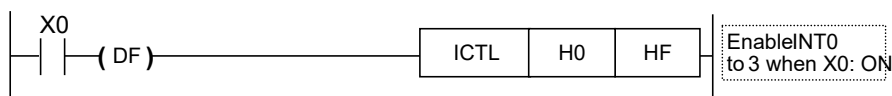

Example 3) Clearing interrupts other than INT0 when the INT0 program ends

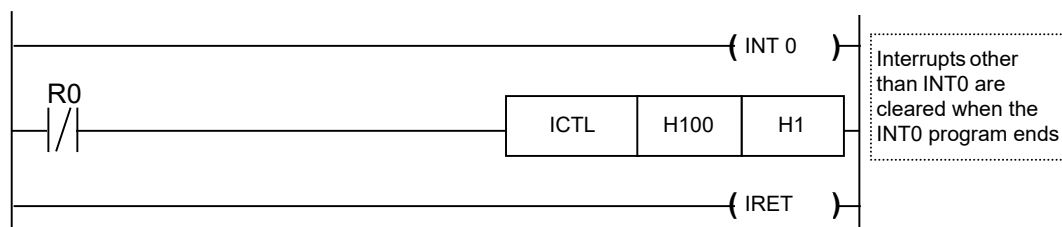

■ Specifying control data

[S1]: Specifies the type of interrupt and the function to be controlled

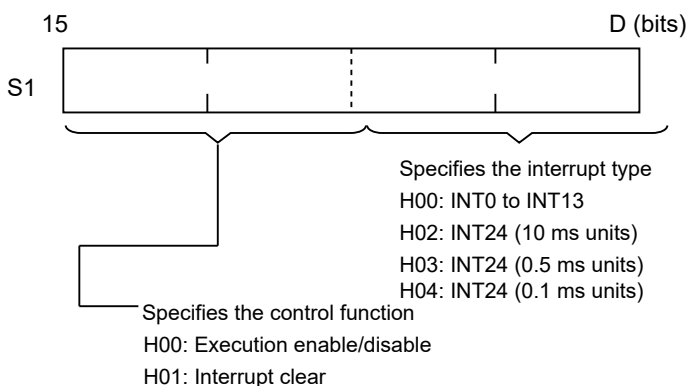

(1)	When specifying enable/disable execution of INT0 to 7	[S1] = H0
(2)	When specifying to clear interrupts for INT0 to 7	[S1] = H100
(3)	Time interval setting for INT24	[S1] = H2 (10 ms units) [S1] = H3 (0.5 ms units) [S1] = H4 (0.1 ms units)

7.2 ICTL (Interrupt Control)

■ Precautions for programming

Inputs that can actually be used as interrupt inputs. (Refer to the table below)

Interrupt program number	Interrupt input
INT0	X0
INT1	X1
INT2	X2
INT3	X3
INT4	X4
INT5	X5
INT6	X6
INT7	X7
INT8	-
INT9	-
INT10	-
INT11	-
INT12	-
INT13	-
INT24	Periodic interrupt

[S2]: Specifies the control content

- Specifying enable/disable execution of the interrupt program (when S1 = H0 or S1 = H1)
Set the control data to the bit corresponding to the interrupt program number you wish to control.
 - To enable execution, set the program number bit to "1"
 - To disable execution, set the program number bit to "0"

e.g. Enabling interrupt program INT1 and INT2, and disabling INT0 and INT3 to INT13

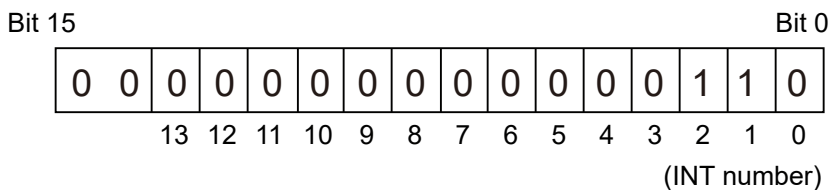

- Clear the interrupts (when S1 = H100)
Set the control data to the bit corresponding to the interrupt program number you wish to control.
 - Set the program number bits to be cleared to "0"
 - Set the program number bits not to be cleared to "1"

e.g. Clearing interrupt program INT0 to INT2, not clearing INT3 to IN13

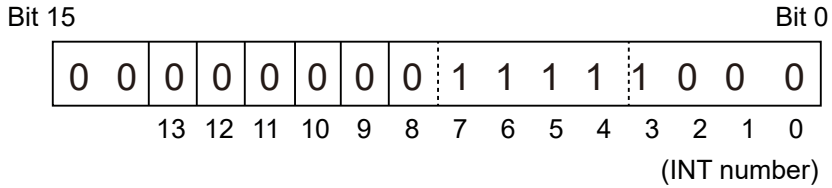

3. Specifying a periodic interrupt (when S1 = H2)

Specify the setting value with a decimal.

Time interval = value of [S2] × 10 (ms)

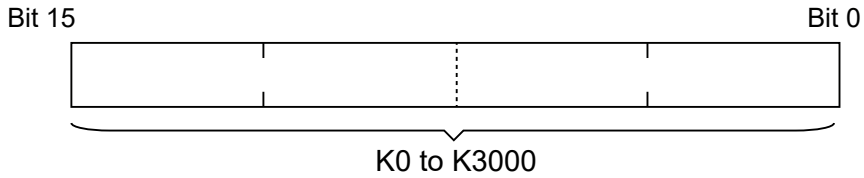

- Time interval setting is K1 to K3000 (10 ms to 30 s)
- Disable INT24 is K0

4. Specify a periodic interrupt (when S1 = H3)

Time interval = value of [S2] × 0.5 (ms)

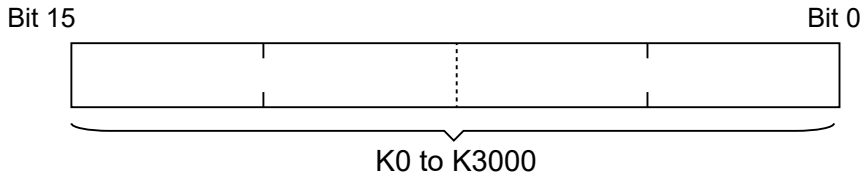

- Time interval setting is K1 to K3000 (0.5 ms to 1.5 s)
- Disable INT24 is K0

■ **Example setting to enable interrupt program execution**

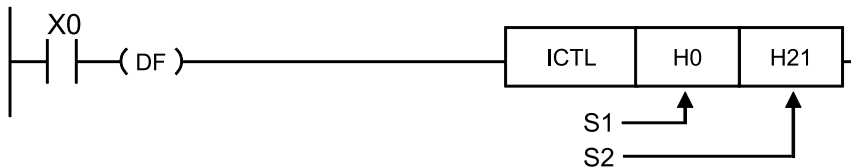

[S1]: H0000	Specifies enable/disable execution of interrupt programs corresponding to interrupts from a specified input contact or interrupts matching the target value
[S2]: H0021	Enable INT0 and INT5 (bits 0 and 5 are "1") and disable others

7.2 ICTL (Interrupt Control)

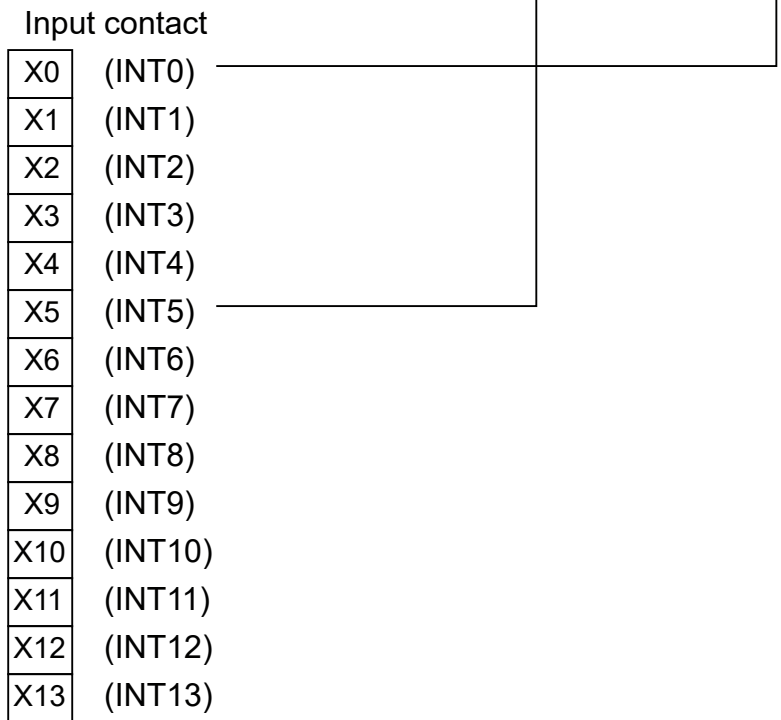
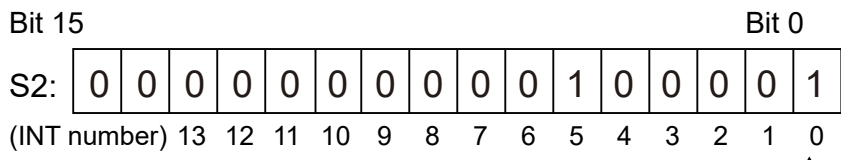

- Set the bits corresponding to the interrupts to be enabled to "1".

Description

If this ICTL instruction is executed, the No. 0 and No. 5 programs will be executed if the corresponding interrupt occurs.

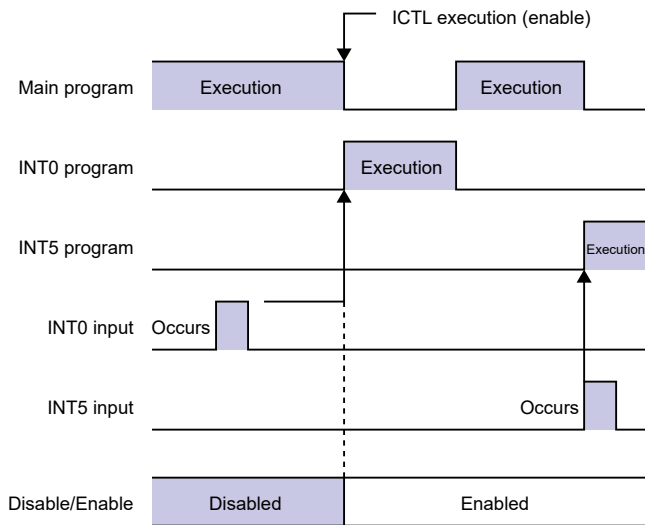

■ Example setting to clear interrupts

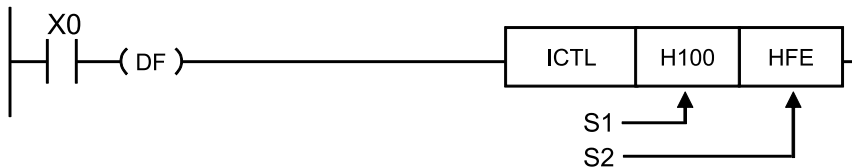

[S1]: H0100	Clears the interrupts from a specified input contact or interrupts matching the target value
[S2]: HFE	Clears INT0 interrupt (bit 0 is "0"), others are not cleared

(Note 1) Refer to the "Enable/Disable" example regarding the correspondence between setting values and interrupt input contacts.

Description

If in a state where an INT0 interrupt is occurring but the corresponding interrupt program is not being executed, executing this ICTL instruction will clear the interrupt.

7.2 ICTL (Interrupt Control)

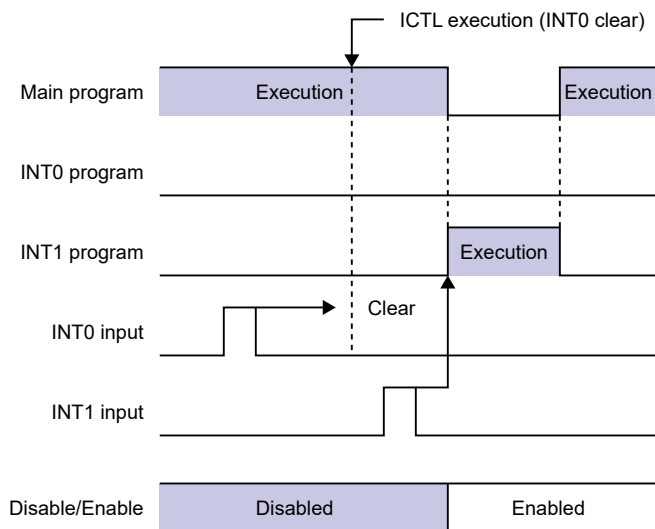

(Note 1) As INT0 has been cleared, it will not be executed even after being enabled. INT1 has not been cleared, so it will be executed after being enabled.

■ Example settings for periodic interrupt

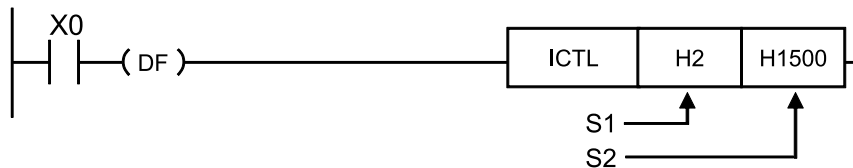

[S1]: H0002	Specifies a periodic interrupt
[S2]: K1500	Specifies the time interval of the periodic interrupt If K1500, the time interval is $K1500 \times 10 \text{ ms} = 15000 \text{ ms}$ (15 s)

Description

If this ICTL instruction is executed, a periodic interrupt will occur every 15 seconds and the INT24 interrupt program will be executed.

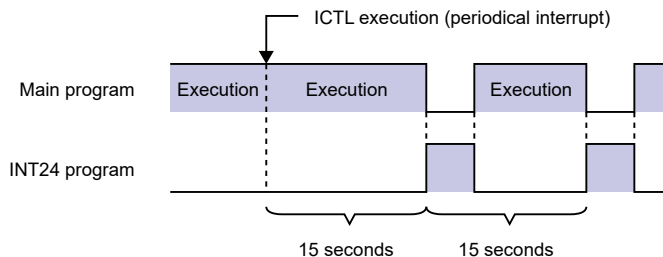

(Note 1) To stop the periodic interrupt, execute the following.

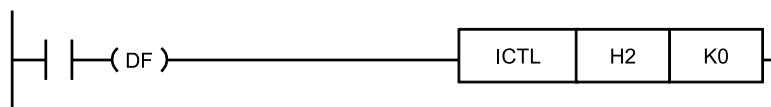

7.2.1 How to start the interrupt program when executing the high-speed counter match ON / match OFF instruction

1 2 Procedure

1. Set the counter via the system register. (It is not necessary to set the external interrupt.)
2. Specify the interrupt program in the program.

The high-speed counters correspond to the interrupt programs as indicated in the table below.

Interrupt program number	High-speed counter target value match interrupt
INT0	ch0
INT1	ch1
INT2	-
INT3	ch2
INT4	ch3
INT5	-
INT6	-
INT7	-
INT8	-
INT9	-
INT10	-
INT11	-
INT12	-
INT13	-

3. Enable the setting via the ICTL instruction. Enable ICTL H0, H9 - - INT0 and INT3.
4. Start the match ON / match OFF instruction.
5. The program is executed when the conditions for match ON / match OFF are met.

Note

- When using a high-speed counter target value match interrupt program, the counting performance of the high-speed counter may decrease upon initiation of the interrupt program.

(MEMO)

8 Special Setting Instructions

8.1 SYS1 (Communication Condition Setting).....	8-2
8.2 SYS1 (Password setting).....	8-8
8.3 SYS1 (Interrupt setting)	8-10
8.4 SYS1 [PC (PLC) Link Time Setting].....	8-12
8.5 SYS1 (MEWTOCOL-COM response control).....	8-14
8.6 SYS1 (Change high-speed counter operation mode).....	8-16
8.7 SYS2 [System Register (No.40 to No.48, No.50 to 57) Change]	8-18

8.1 SYS1 (Communication Condition Setting)

8.1 SYS1 (Communication Condition Setting)

■ Instruction format

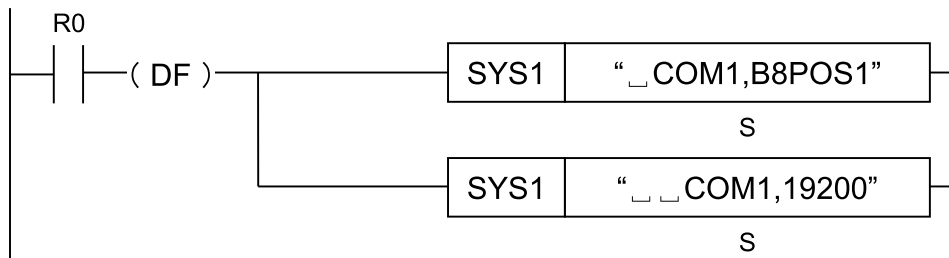

(Note 1) In the example shown in the figure above, the transmission format and baud rate of the COM1 port are set as below.

Character bit length: 8; Parity bit: Odd parity; Stop bit: 1

Baud rate: 19200 bps

■ Operands

Items	Settings
S	Character constant

■ Devices that can be specified (indicated by ●)

Operand s	WX	WY	WR	WL	SV	EV	DT	LD	I	SWR	SDT	Constant			Index modifier (Note 1)
												K	H	M	
S														●	

(Note 1) A character constant cannot be specified.

■ Outline of operation

- This instruction changes the communication conditions of the port specified as the first keyword to the contents specified as the second keyword.
- The following functions can be changed.
 - Transmission format
 - Baud rate
 - Unit number setting (direct / indirect)
 - COM response control
 - Header and terminator
 - End time
 - RS (Request to Send) control

■ Precautions on programming

- Enclose the first and second keywords in double quotation marks ("").
- Separate the first keyword and second keyword with a comma (,) without inserting a space.

8.1 SYS1 (Communication Condition Setting)

- Insert space characters in front of the first keyword so that the total number of characters of the first and second keywords is 12. (The number of space characters to be inserted in front of the first keyword is 12 minus the total number of characters to be entered for the keywords.)

For FPWIN-GR7 Ver.2.23 or later, if the character constant consists of less than 12 characters, space characters will be automatically input (to compensate for the shortage of characters) when the project is converted.

Example: When entering COM1 as the first keyword and 19200 as the second keyword

Specified contents	“			C	O	M	1	,	1	9	2	0	0	”
No. of characters		1	2	3	4	5	6	7	8	9	10	11	12	

- Even if this instruction is executed, the contents of the system ROM in the main unit will not be rewritten. Therefore, when the power is turned OFF and then ON, the contents of the system ROM is rewritten with the contents of the system register specified in FPWIN GR7.
- We recommend that this instruction be executed as a differentiated instruction.
- Because the system register settings are changed, a verification error may occur when verification is performed with FPWIN GR7.

■ Specifying the communication conditions (transmission format)

- Specify transmission format (data length, parity check, and stop bit).

First keyword	Second keyword		
Ports to be used	Data length	Parity check	Stop bit
COM0: COM0 port COM1: COM1 port COM2: COM2 port TOOL: COM0 port	B7: 7 bits B8: 8 bits	PN: No parity PO: Odd parity PE: Even parity	S1: 1 S2: 2

Setting examples

Example 1	S	“_COM0,B7PNS1”
Settings	Port: COM0 / Data length: 7 bits / Parity check: None / Stop bit: 1	
Example 2	S	“_COM1,B8PES2”
Settings	Port: COM1 / Data length: 8 bits / Parity check: Even parity / Stop bit: 2	
Example 3	S	“_COM2,B8POS1”
Settings	Port: COM2 / Data length: 8 bits / Parity check: Odd parity / Stop bit: 1	

■ Specifying the communication conditions (baud rate)

- Specify a baud rate.

First keyword	Second keyword		
Ports to be used	Baud rate		
COM0: COM0 port COM1: COM1 port	1200: 1200 bps 2400: 2400 bps	19200: 19200 bps 38400: 38400 bps	230400: 230400 bps

8.1 SYS1 (Communication Condition Setting)

First keyword	Second keyword
Ports to be used	Baud rate
COM2: COM2 port TOOL: COM0 port	4800: 4800 bps 57600: 57600 bps 9600: 9600 bps 115200: 115200 bps

(Note 1) If the baud rate is changed as below, communications passing through all COM ports will be reset.
Baud rates of all COM ports: 4800 bps or higher ↔ Baud rate of any of the COM ports: 2400 bps or lower

(Note 2) If the baud rate of any of the COM ports is 2400 bps or lower, F-ROM access will slow down.
Example) F12(ICRD) instruction, P13(ICWT) instruction, etc.

Setting example

Example 1	S	"_COM0,19200"
Settings	Port: COM0 / 19200 bps	
Example 2	S	"_COM1,1200"
Settings	Port: COM1 / 1200 bps	
Example 3	S	"_COM2,115200"
Settings	Port: COM2 / 115200 bps	

■ Specifying the communication conditions (unit number)

- Specify a unit number directly or indirectly.

First keyword	Second keyword	
Ports to be used	Unit number (for direct specification)	Unit number (for indirect specification)
COM0: COM0 port COM1: COM1 port COM2: COM2 port TOOL: COM0 port	No1 to No99: Unit numbers 1 to 99	For a DT number that contains a unit number, specify D followed by a four-digit number, as below. D0000 to D9999: DT0 to DT9999

(Note 1) For direct specification of unit numbers, you can specify unit numbers 1 to 99. For indirect specification of unit numbers, specify a DT number that contains a unit number.

Setting example

Example 1	S	"_COM0,No1"
Settings	(For direct specification of unit numbers) Port: COM0 / Unit number: No1	
Example 2	S	"_COM1,No99"
Settings	(For direct specification of unit numbers) Port: COM1 / Unit number: No99	
Example 3	S	"COM0No,D0000"
Settings	(For indirect specification of unit numbers) Port: COM0 / Unit number: Value set in DT0	

8.1 SYS1 (Communication Condition Setting)

Example 4	S	"COM2No,D0123"
Settings	(For indirect specification of unit numbers) Port: COM2 / Unit number: Value set in DT0123	

■ Specifying the communication conditions (response time of COM port)

- Specify the response time of a COM port.

First keyword	Second keyword
Ports to be used	Response time
COM0: COM0 port COM1: COM1 port COM2: COM2 port TOOL: COM0 port	WAIT0 to WAIT999 (n=0 to 999) [When the communication mode is computer link or MODBUS RTU] Set time = Scan time x n [When the communication mode is PLC link] Set time = n μs

Setting examples

Example 1	S	"_COM0,WAIT1"
Settings	Port: COM0 [When the communication mode computer link or MODBUS RTU] Scan time x 1 [When the communication mode is PLC link] 1 μs	
Example 2	S	"COM1,WAIT999"
Settings	Port: COM1 [When the communication mode is computer link or MODBUS RTU] Scan time x 999 [When the communication mode is PLC link] 999 μs	

■ Specifying the communication conditions (header / terminator)

- Specify a header or terminator.

First keyword	Second keyword	
Ports to be used	For header	For terminator
COM0: COM0 port COM1: COM1 port COM2: COM2 port TOOL: COM0 port	STX: With STX NOSTX: Without STX	ETX: ETX CR: CR CRLF: CR + LF NOTERM: No terminator TIME: Enables end time (Note 1)

(Note 1) The setting of TIME takes precedence over the settings of other terminators (EXT, CR, CRLF, and NOTERM).

Setting example

Example 1	S	"_COM0,STX"
Settings	Port: COM0 / Header: With STX	

8.1 SYS1 (Communication Condition Setting)

Example 2	S	"_COM1,ETX"
Settings	Port: COM1 / Terminator: ETX	
Example 3	S	"_COM1,CR"
Settings	Port: COM1 / Terminator: CR	
Example 4	S	"_COM2,NOTERM"
Settings	Port: COM2 / Terminator: No terminator	
Example 5	S	"_COM2,TIME"
Settings	Port: COM2 / Terminator: Enables end time	

■ Specifying the communication conditions (end time)

- Specify an end time.

First keyword	Second keyword
Ports to be used	End time
COM0: COM0 port COM1: COM1 port COM2: COM2 port TOOL: COM0 port	Specify an end time in 0.01 ms increments between 0.01 and 100 ms. T0 to T10000: 0.01ms to 100ms

Setting examples

Example 1	S	"_COM0,T0"
Settings	Port: COM0 / End time: Transfer time for approx. 4 bytes of data	
Example 2	S	"_COM1,T123"
Settings	Port: COM1 / End time: 1.23 ms	
Example 3	S	"_COM2,T10000"
Settings	Port: COM2 / End time: 100 ms	

■ Specifying the communication conditions (RS (Request to Send) control)

- RS control can be performed for 1-channel RS-232C type communication cassettes.
- RS control can only be set for the COM1 port.

First keyword	Second keyword
Ports to be used	RS (Request to Send) control
COM1: COM1 port	RTS1: Disables communication (turns ON the RS terminal) RTS0: Enables communication (turns OFF the RS terminal)

Setting example

Example 1	S	“_COM1,RTS1”
Settings		Port: COM1 / RS (Request to Send) control: Disables communication
Example 2	S	“_COM1,RTS0”
Settings		Port: COM1 / RS (Request to Send) control: Enables communication

■ Flag operations

Name	Description
R9007 R9008 (ER)	Set when non-keyword text or an out-of-range value is specified for the first and second keywords.
	Set when there is no comma between the first and second keywords.
	Set if no communication cassette is mounted when COM1 or COM2 is specified.
	Set if the baud rate or transmission format for COM1 is changed when COM1 is in PLC link mode.
	Set if the baud rate or transmission format is changed while the modem for the COM0, COM1, or COM2 port is being initialized.
	Set if the communication mode is set to any mode other than general-purpose communication mode when a header or terminator is set.
	Set if any communication cassette other than 1-channel RS-232C type communication cassettes is mounted when RS control is performed.
	Set if a unit number greater than the maximum unit number set in the system register is specified when COM1 is in PLC link mode.
Set if the communication speed is changed as below while F-ROM is being accessed. Baud rates of all COM ports: 4800 bps or higher ↔ Baud rate of any of the COM ports: 2400 bps or lower	

8.2 SYS1 (Password setting)

8.2 SYS1 (Password setting)

■ Instruction format

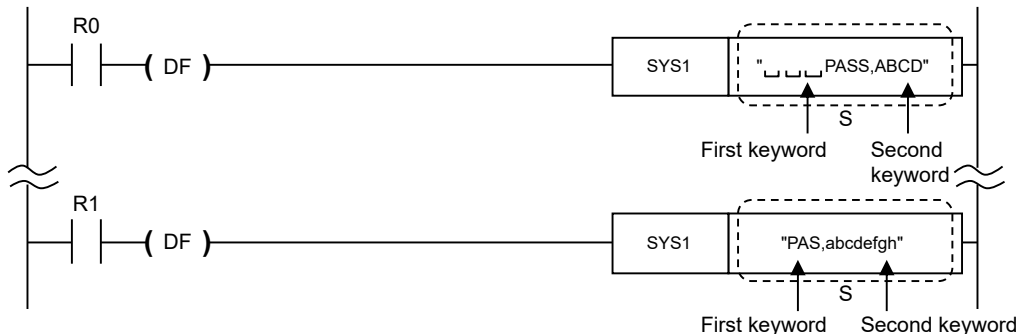

■ Operands

Items	Settings
S	Character constant

■ Devices that can be specified (indicated by ●)

Operands	WX	WY	WR	WL	SV	EV	DT	LD	I	SWR	SDT	Constant				Index modifier	Integer Device
												K	H	M	f		
S															●		

■ Outline of operation

The password specified for the controller is changed to the contents specified by the No. 2 keyword.

■ Operation example

Operation of instruction format description program

When R0 turns ON, the controller password is changed to "ABCD".

■ Specify keywords

- For a 4-digit password

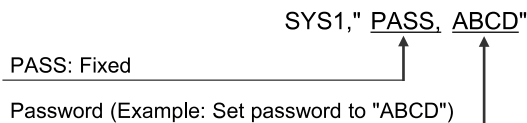

- For an 8-digit password

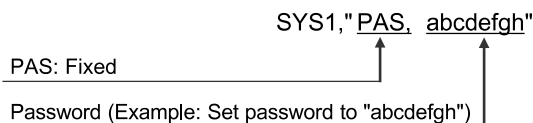

If there are fewer than eight characters, spaces are automatically added at the end to make eight characters.

■ Precautions for programming

- When this instruction is executed, it takes approximately 100 ms to write to the built-in F-ROM.
- If the specified password is the same as the password that has already been written, the password is not written to the F-ROM.
- It is recommended to use differential execution for this instruction.
- Put (12 characters – number of input characters) spaces in front of Keyword 1 so that Keyword 1 and Keyword 2 combined have 12 characters. In FPWIN GR7 Ver. 2.23 and later, if the character constant does not reach 12 characters, spaces are automatically input when the project is converted.

■ Flag operations

Name	Description
	Turns ON when a character other than a keyword is specified
R9007	Turns ON when there is no comma between Keyword 1 and Keyword 2
R9008	Turns ON when the keyword is specified in lower-case characters (for a 4-digit password)
(ER)	Turns ON when the data specified for the password specifies characters other than 0 to 9 and A to F, or the specified data consists of other than four digits (for a 4-digit password)

8.3 SYS1 (Interrupt setting)

8.3 SYS1 (Interrupt setting)

■ Instruction format

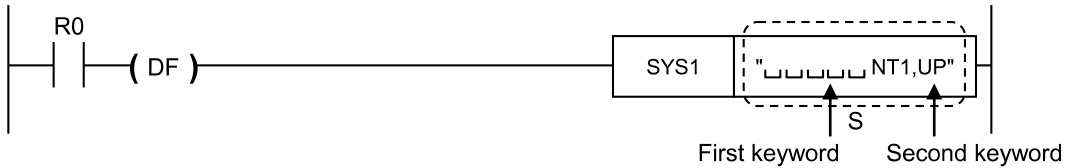

■ Operands

Items	Settings
S	Character constant

■ Devices that can be specified (indicated by ●)

Operands	WX	WY	WR	WL	SV	EV	DT	LD	I	SWR	SDT	Constant				Index modifier	Integer Device
												K	H	M	f		
S															●		

■ Outline of operation

The input specified by the No. 1 keyword is set as the interrupt input, and the input conditions are changed to the contents specified by the No. 2 keyword.

■ Operation example

Operation of instruction format description program

When R0 turns ON, input X1 is set to the interrupt input that becomes valid at the rising edge.

■ Specify keywords

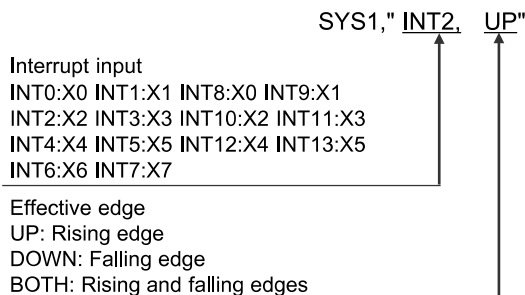

■ Precautions for programming

- Executing this instruction does not rewrite the contents of the system ROM of the main unit. As a result, turning the power supply OFF and then ON again rewrites the contents of the system registers specified by the programming tool software.
- It is recommended to use differential execution for this instruction.
- When UP or DOWN has been specified, the contents of the system registers change in accordance with the specification, meaning a verification error may occur in some cases

when the program is verified. When BOTH has been specified, the contents of the system registers do not change.

- Put (12 characters – number of input characters) spaces in front of Keyword 1 so that Keyword 1 and Keyword 2 combined have 12 characters. In FPWIN GR7 Ver. 2.23 and later, if the character constant does not reach 12 characters, spaces are automatically input when the project is converted.

■ Flag operations

Name	Description
R9007	Turns ON when a character other than a keyword is specified
R9008	Turns ON when there is no comma between Keyword 1 and Keyword 2
(ER)	Turns ON when the keyword is specified in lower-case alphabet characters

8.4 SYS1 [PC (PLC) Link Time Setting]

■ **Instruction format**

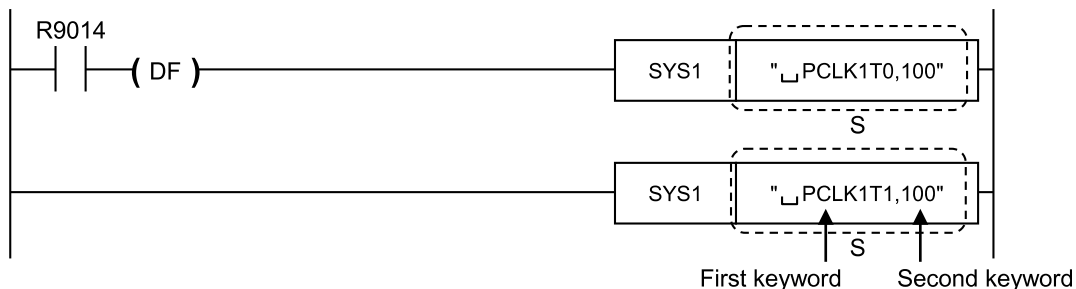

■ **Operands**

Items	Settings
S	Character constant

■ **Devices that can be specified (indicated by ●)**

Operands	WX	WY	WR	WL	SV	EV	DT	LD	I	SWR	SDT	Constant				Index modifier	Integer Device
											K	H	M	f			
S														●			

■ **Outline of operation**

- Set the condition specified by Keyword 1 as the time specified by Keyword 2.
- The setting for the link entry waiting time is set if the transmission cycle time is shortened when there are stations that have not joined the link (*).
 *Stations that have not joined the link: stations that have not been connected between the No. 1 station and the station with the largest number, or stations for which the power supply has not been turned on
- The error detection time setting for the transmission assurance relay is set if the time between the power supply being turned OFF at one station and the transmission assurance relay from the powered-OFF station being turned OFF at a different station is to be shortened.

■ **Operation example**

Operation of instruction format description program

During PC (PLC) link, when R9014 turns ON (at leading edge), the link entry waiting time and error detection time for the transmission assurance relay are set as follows.

Link entry waiting time: 100 ms

Transmission assurance relay error detection time: 100 ms

■ **Specify Keywords**

1. Link entry waiting time

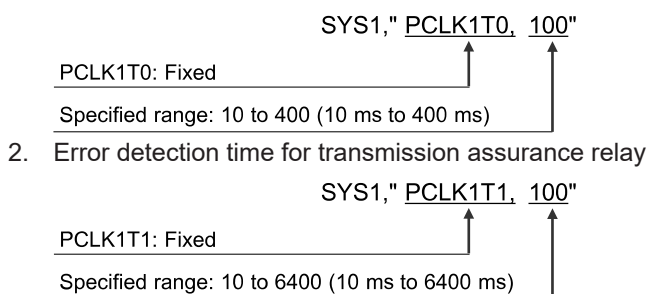

■ Precautions for programming

- The program should be placed at the beginning of all PLCs being linked, and the same values should be set.
- This instruction should be specified with special internal relay R9014 as the differential execution condition.
- Execution of this instruction does not affect the system register setting contents.
- Put a (12 characters – number of input characters) space in front of Keyword 1 so that Keyword 1 and Keyword 2 combined have 12 characters. In FPWIN GR7 Ver. 2.23 and later, if the character constant does not reach 12 characters, spaces are automatically input when the project is converted.

■ Precautions when setting the link entry waiting time

- This should be set to be at least twice that of the largest scan time of each PLC to be linked.
- If set to a shorter value, there may be some PLCs that are not be able to join the link, even if they are powered on.
- If there are any stations that have not joined the link, the settings should not be changed, especially if there are no problems, even if the link transmission cycle time is longer as a result. (The default value is 400 ms.)

■ Precautions when setting the error detection time for the transmission assurance relay

- This should be set to be at least twice that of the largest transmission cycle time when all PLCs are linked.
- If set to a shorter value, there is a possibility that the transmission assurance relay will malfunction.
- The settings should not be changed, especially if there are no problems, even if the transmission assurance relay detection time is longer as a result. (The default value is 6400 ms.)

■ Flag operations

Name	Description
R9007 R9008 (ER)	Turns ON when a character other than a keyword is specified
	Turns ON when there is no comma between Keyword 1 and Keyword 2
	Turns ON when the keyword is specified in lower-case alphabet characters
	Turns ON when a value outside the specified range is specified

8.5 SYS1 (MEWTOCOL-COM response control)

8.5 SYS1 (MEWTOCOL-COM response control)

■ Instruction format

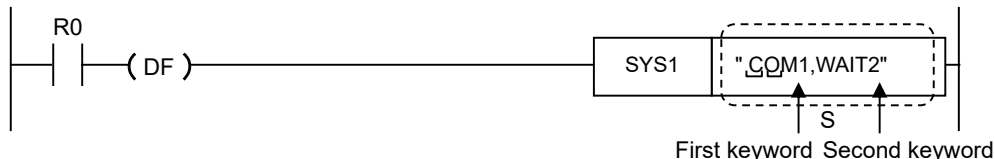

■ Operands

Items	Settings
S	Character constant

■ Devices that can be specified (indicated by ●)

Operands	WX	WY	WR	WL	SV	EV	DT	LD	I	SWR	SDT	Constant				Index modifier	Integer Device
												K	H	M	f		
S														●			

■ Outline of operation

- The MEWTOCOL-COM response time of the port specified by the No. 1 keyword is delayed based on the contents specified by the No. 2 keyword.
- This instruction is used to delay the response time on the PLC side until a state is reached in which commands can be sent by an external device and responses can be received from the PLC.

Usage example:

When a commercial RS232C/RS485 converter is being used to carry out communication between a computer and the PLC, this instruction is used to return the PLC response after switching of the enable signal has been completed on the converter side.

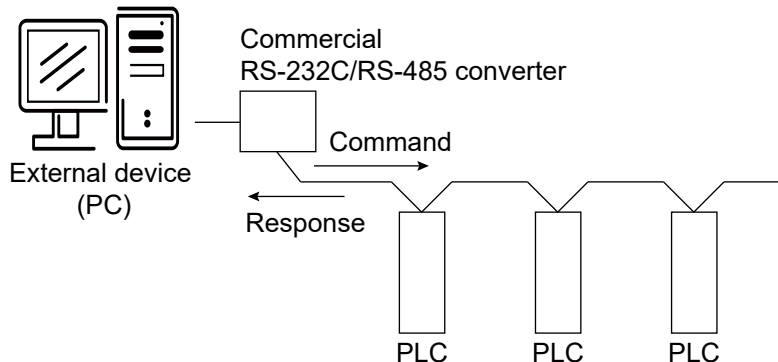

■ Specify keywords

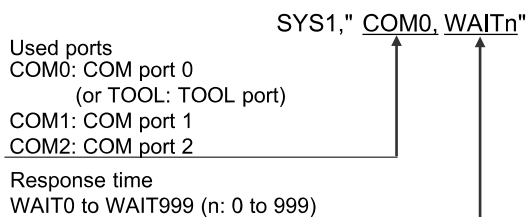

- If the communication mode has been set to computer link mode or MODBUS RTU mode
 Set time = scan time x n (n: 0 to 999)
- If the communication mode has been set to PC (PLC) link mode
 Set time = n μs (n: 0 to 999)
- If n = 0, the delay time set by this instruction will be set to "None".

■ Precautions for programming

Because PC (PLC) links may become unstable, do not change settings unless absolutely necessary.

- This instruction is valid only if the setting on the controller side has been set to computer link mode or PC (PLC) link mode.
- Set all the PLCs to be linked to the same value so that execution occurs at the rise of R9014 at the beginning of the program.
- Executing this instruction does not change the settings in the system registers.
- If the settings are changed, set to approximately double or more.
- It is recommended to use differential execution for this instruction.
- When the power supply to the PLC turns OFF, the settings set by this instruction are cleared. (The set value becomes 0.)

However, the settings will be retained if the mode is switched to "PROG. mode" after this instruction has been executed.

- If a commercial RS232C/RS485 converter is being used in PC (PLC) link mode, this instruction should be programmed in all of the connected stations (PLCs).
- Put (12 characters – number of input characters) spaces in front of Keyword 1 so that Keyword 1 and Keyword 2 combined have 12 characters. In FPWIN GR7 Ver. 2.23 and later, if the character constant does not reach 12 characters, spaces are automatically input when the project is converted.

■ Flag operations

Name	Description
R9007 R9008 (ER)	Turns ON when a character other than a keyword is specified
	Turns ON when there is no comma between Keyword 1 and Keyword 2
	Turns ON when the keyword is specified in lower-case alphabet characters
	Turns ON when no communication cassette has been installed when COM1 or COM2 has been set

8.6 SYS1 (Change high-speed counter operation mode)

8.6 SYS1 (Change high-speed counter operation mode)

■ Instruction format



■ Operands

Items	Settings
S	Character constant

■ Devices that can be specified (indicated by ●)

Operands	WX	WY	WR	WL	SV	EV	DT	LD	I	SWR	SDT	Constant				Index modifier	Integer Device
												K	H	M	f		
S														●			

■ Outline of operation

The high-speed counter operation mode specified by Keyword 1 is changed to the operation mode specified by Keyword 2. It is possible to switch between addition input and subtraction input.

■ Operation example

Operation of instruction format description program

When R0 turns ON, the operation mode of high-speed counter CH0 is set to addition mode.

■ Specify keywords

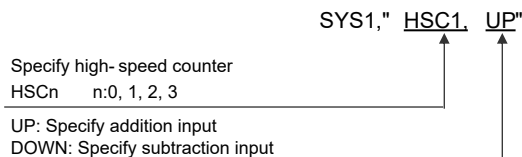

■ Precautions for programming

- With this instruction, if the high-speed counter system register setting is neither addition input nor subtraction input, an operation error is returned. Specify the system register setting to addition or subtraction in advance. Also, when addition input is specified, even if addition input is specified again, the setting remains addition input. This is the same when subtraction input is specified.
- Executing this instruction does not rewrite the contents of the system ROM of the main unit. As a result, turning the power supply OFF and then ON again rewrites the contents of the system registers specified by the programming tool software.
- It is recommended to use differential execution for this instruction.

8.6 SYS1 (Change high-speed counter operation mode)

- When UP or DOWN has been specified, the contents of the system registers change in accordance with the specification, meaning a verification error may occur in some cases when the program is verified. When BOTH has been specified, the contents of the system registers do not change.
- Put (12 characters – number of input characters) spaces in front of Keyword 1 so that Keyword 1 and Keyword 2 combined have 12 characters. In FPWIN GR7 Ver. 2.23 and later, if the character constant does not reach 12 characters, spaces are automatically input when the project is converted.

■ Flag operations

Name	Description
R9007 R9008 (ER)	Turns ON when a character other than a keyword is specified
	Turns ON when there is no comma between Keyword 1 and Keyword 2
	Turns ON when the keyword is specified in lower-case alphabet characters
	When the system register setting is something other than addition input or subtraction input

8.7 SYS2 [System Register (No.40 to No.48, No.50 to 57) Change]

8.7 SYS2 [System Register (No.40 to No.48, No.50 to 57) Change]

■ Instruction format

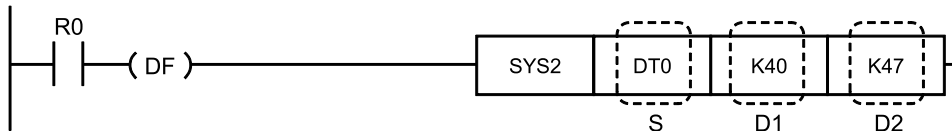

■ Operands

Items	Settings
S	Starting number of area storing 16-bit data
D1	Starting number of the system register to be specified (K40 to K47, K50 to K57)
D2	Ending number of the system register to be specified (K40 to K47, K50 to K57)

■ Devices that can be specified (indicated by ●)

Operands	WX	WY	WR	WL	SV	EV	DT	LD	I	SW R	SD T	Constant				Index modifier	Integer Device
												K	H	M	f		
S							●										
D1												●					
D2												●					

■ Outline of operation

The contents of system registers No. 40 to 48 and No. 50 to 57 are changed to the contents of the data register starting with [S].

■ System registers No. 40 to 48, No. 50 to 57

	No.	Name	Sett values/range
PC (PLC) W0-0 setting	40	Range used by link relay	0 to 64 words
	41	Range used by link register	0 to 128 words
	42	Link relay transmission starting No.	0 to 63
	43	Link relay transmission size	0 to 64 words
	44	Link register transmission starting No.	0 to 127
	45	Link register transmission size	0 to 127 words
	46	PC (PLC) link switch flag	0: Standard, 1: Reverse
	47	MEWNET-W0 PC (PLC) link maximum station number specification	1 to 16
	48	PLC link baud rate	0: 115200 bps 1: 230400 bps
PC (PLC)	50	Range used by link relay	0 to 64 words

8.7 SYS2 [System Register (No.40 to No.48, No.50 to 57) Change]

	No.	Name	Sett values/range
W0-1 setting	51	Range used by link register	0 to 128 words
	52	Link relay transmission starting No.	64 to 127
	53	Link relay transmission size	0 to 64 words
	54	Link register transmission starting No.	128 to 255
	55	Link register transmission size	0 to 127 words
	57	MEWNET-W0 PC (PLC) link maximum station number specification	1 to 16

■ Program example

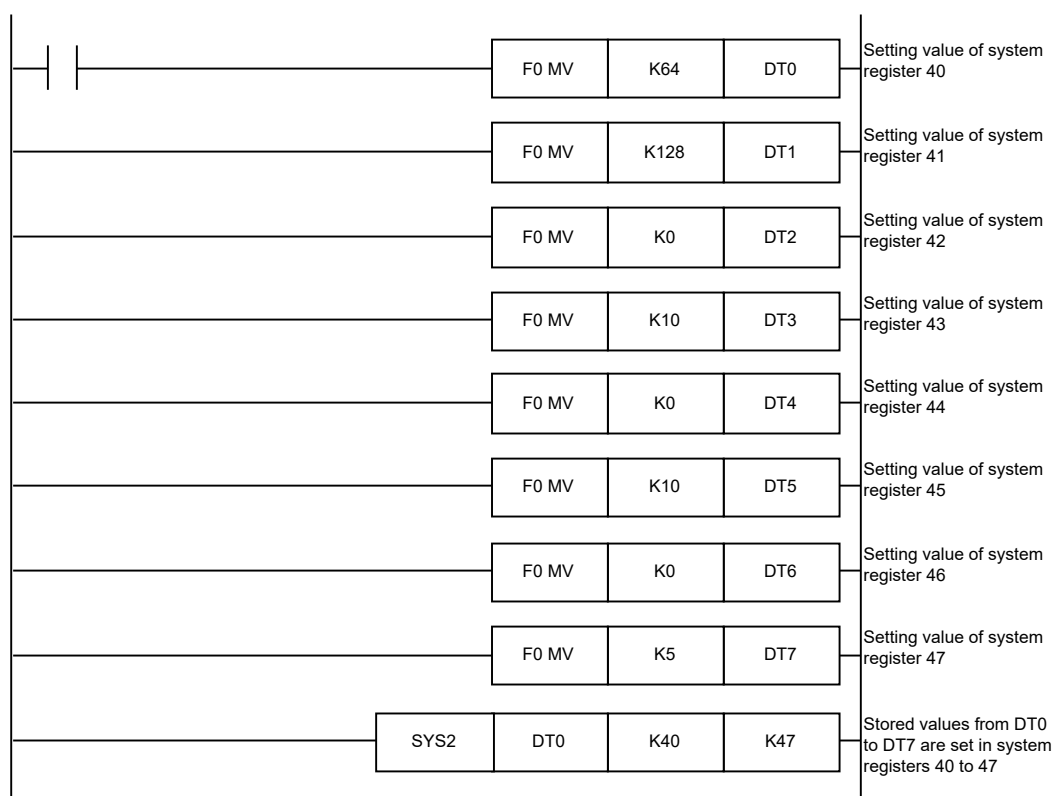

■ Precautions for programming

- Executing this instruction does not rewrite the contents of the system ROM of the main unit. As a result, when the power supply is turned OFF and ON again, the contents of the system registers set with the tool software are rewritten.
- Specify a value between K40 and K48 or between K50 and K57 for [D1] or [D2]. Ensure that D1 is less than or equal to D2.
- Since the value of the system register is changed, a verification error may occur during program verification.

8.7 SYS2 [System Register (No.40 to No.48, No.50 to 57) Change]

■ Flag operations

Name	Description
R9007	Turns ON when D1>D2
R9008 (ER)	Turns ON when a set value is outside the specified range of a system register setting value

9 Compare Contact Instructions

9.1 ST=, ST <>, ST>, ST>=, ST<, ST<= [16-bit Data Comparison (Start)]	9-2
9.2 AN=, AN<>, AN>, AN>=, AN<, AN<= [16-bit Data Comparison (AND)]	9-4
9.3 OR= OR <> OR > OR >= OR < OR <= [16-bit Data Comparison (OR)]	9-6
9.4 STD=, STD<>, STD>, STD>=, STD<, STD<= [32-bit Data Comparison(start)]	9-8
9.5 AND=, AND<>, AND>, AND>=, AND<, AND<= [32-bit Data Comparison (AND)].....	9-10
9.6 ORD=, ORD<>, ORD>, ORD>=, ORD<, ORD<= [32-bit Data Comparison (OR)].....	9-12
9.7 STF=, STF<>, STF>, STF>=, STF< and STF<= [Floating point real number data comparison (start)].....	9-14
9.8 ANF=, ANF<>, ANF>, ANF>=, ANF<, ANF<= [Floating point real number data comparison (AND)]	9-16
9.9 ORF=, ORF<>, ORF>, ORF>=, ORF<, ORF<= [floating point real number data comparison (OR)]	9-18

9.1 ST=, ST <>, ST>, ST>=, ST<, ST<= [16-bit Data Comparison (Start)]

9.1 ST=, ST <>, ST>, ST>=, ST<, ST<= [16-bit Data Comparison (Start)]

■ Instruction format

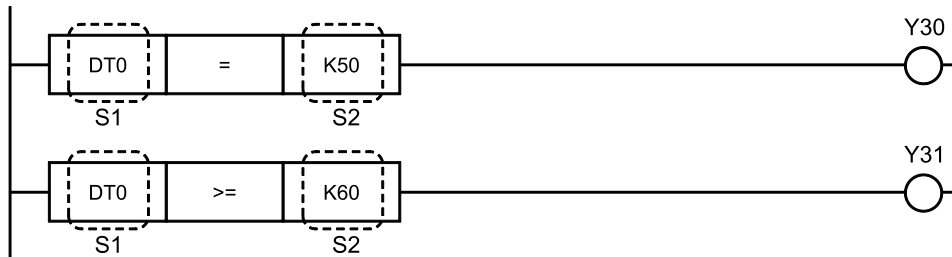

■ Operands

Items	Settings
S1	Comparison data 1: Number of area storing 16-bit data, or constant data
S2	Comparison data 2: Number of area storing 16-bit data, or constant data

■ Devices that can be specified (indicated by ●)

Operands	WX	WY	WR	WL	SV	EV	DT	LD	I	SWR	SDT	Constant				Index modifier	Integer Device
												K	H	M	f		
S1	●	●	●	●	●	●	●	●	●	●	●	●	●	●	●	●	
S2	●	●	●	●	●	●	●	●	●	●	●	●	●	●	●	●	

■ Outline of operation

- The signed 16-bit data specified by [S1] is compared with the signed 16-bit data specified by [S2].
- If the comparison results in one of the specified statuses (=, <, >, etc.), a logical operation is initiated with the contacts operating as liaison contacts.
- Comparison results and operations relate as follows.

Comparison instruction	Relationship between S1 and S2		
	S1 < S2	S1 = S2	S1 > S2
ST=	OFF	ON	OFF
ST<>	ON	OFF	ON
ST>	OFF	OFF	ON
ST>=	OFF	ON	ON
ST<	ON	OFF	OFF
ST<=	ON	ON	OFF

(Note 1) "<>" is displayed as "≠".
 ">=" is displayed as "≥".
 "<=" is displayed as "≤".

■ Operation example

Operation of instruction format description program

Compares the value of data register DT0 with K50. If $DT0 = K50$, external output Y30 turns ON.

Compares the value of DT0 with K60. If $DT0 \geq K60$, Y31 turns ON.

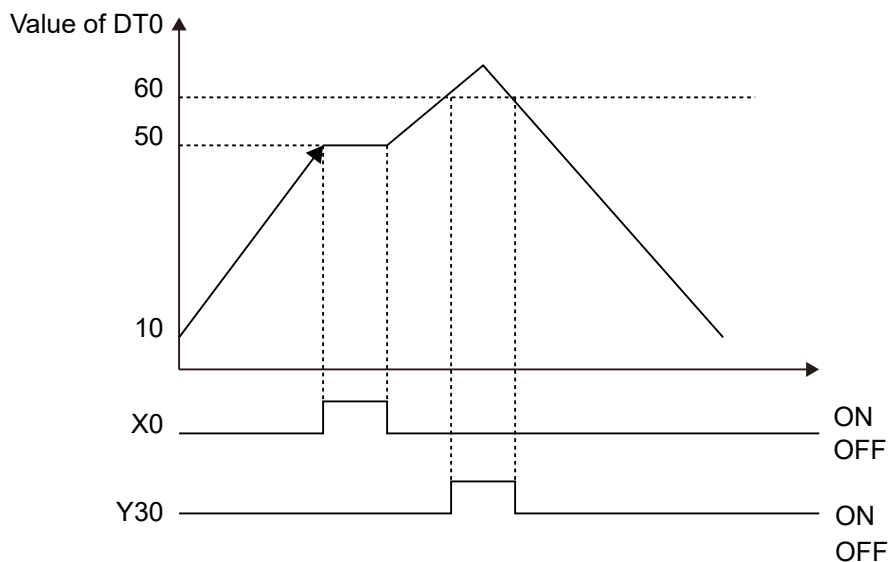

■ Precautions for use

- These instructions start from the bus bar.
- In the case of BCD data, etc., data is compared as a negative value if the most significant bit is 1, so the comparison results may not be accurate. In cases such as this, compare after converting the data to binary data by using an instruction such as F81 BIN.

■ Flag operations

Name	Description
R9007 R9008 (ER)	Turns ON when the area is exceeded in index modification.

9.2 AN=, AN<>, AN>, AN>=, AN<, AN<= [16-bit Data Comparison (AND)]

9.2 AN=, AN<>, AN>, AN>=, AN<, AN<= [16-bit Data Comparison (AND)]

■ Instruction format

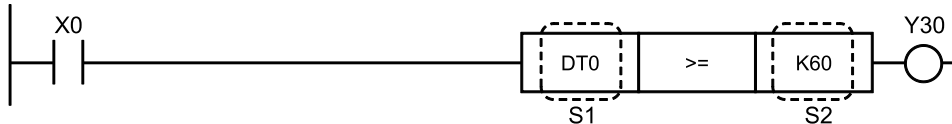

■ Operands

Items	Settings
S1	Comparison data 1: Number of area storing 16-bit data, or constant data
S2	Comparison data 2: Number of area storing 16-bit data, or constant data

■ Devices that can be specified (indicated by ●)

Operands	WX	WY	WR	WL	SV	EV	DT	LD	I	SWR	SDT	Constant				Index modifier	Integer Device
												K	H	M	f		
S1	●	●	●	●	●	●	●	●	●	●	●	●	●		●		
S2	●	●	●	●	●	●	●	●	●	●	●	●	●		●		

■ Outline of operation

- The signed 16-bit data specified by [S1] is compared with the signed 16-bit data specified by [S2].
- If the comparison results in one of the specified statuses (=, <, >, etc.), the contacts are connected in series as liaison contacts.
- Comparison results and operations relate as follows.

Comparison instruction	Relationship between S1 and S2		
	S1 < S2	S1 = S2	S1 > S2
AN=	OFF	ON	OFF
AN<>	ON	OFF	ON
AN>	OFF	OFF	ON
AN>=	OFF	ON	ON
AN<	ON	OFF	OFF
AN<=	ON	ON	OFF

- (Note 1) "<>" is displayed as "≠".
 ">=" is displayed as "≥".
 "<=" is displayed as "≤".

■ Operation example

Operation of instruction format description program

When internal relay X0 turns ON, the value of DT0 and K60 are compared, and if DT0 is equal to or greater than K60, the external output Y30 turns ON. If X0 is OFF or if DT0 is less than K60, Y30 turns OFF.

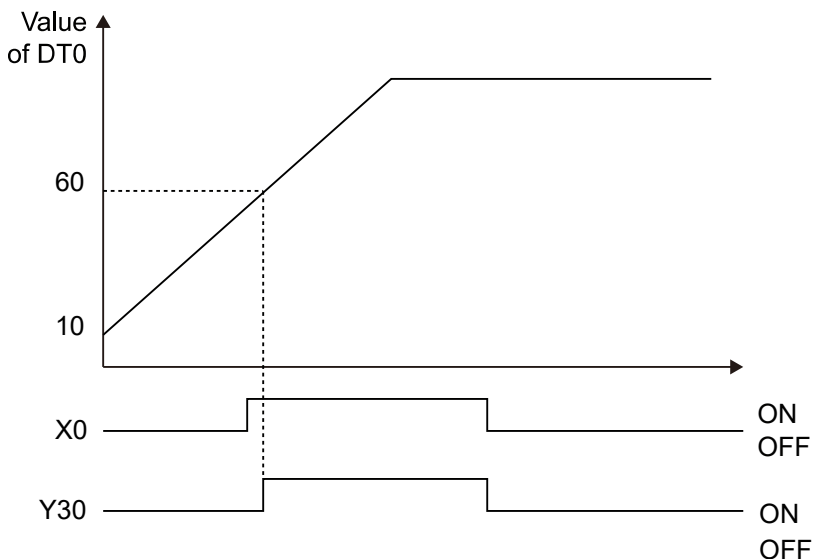

■ Precautions for use

- These instructions can be used consecutively.
- In the case of BCD data, etc., data is compared as a negative value if the most significant bit is 1, so the comparison results may not be accurate. In cases such as this, compare after converting the data to binary data by using an instruction such as F81 BIN.

■ Flag operations

Name	Description
R9007 R9008 (ER)	Turns ON when the area is exceeded in index modification.

9.3 OR= OR <> OR > OR >= OR < OR <= [16-bit Data Comparison (OR)]

9.3 OR= OR <> OR > OR >= OR < OR <= [16-bit Data Comparison (OR)]

■ Instruction format

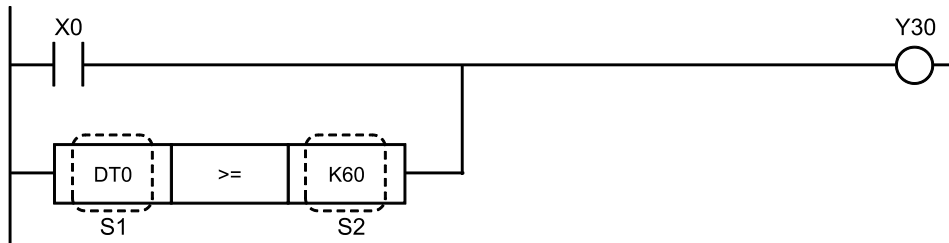

■ Operands

Items	Settings
S1	Comparison data 1: Number of area storing 16-bit data, or constant data
S2	Comparison data 2: Number of area storing 16-bit data, or constant data

■ Devices that can be specified (indicated by ●)

Operands	WX	WY	WR	WL	SV	EV	DT	LD	I	SWR	SDT	Constant				Index modifier	Integer Device
												K	H	M	f		
S1	●	●	●	●	●	●	●	●	●	●	●	●	●	●	●	●	
S2	●	●	●	●	●	●	●	●	●	●	●	●	●	●	●	●	

■ Outline of operation

- The signed 16-bit data specified by [S1] is compared with the signed 16-bit data specified by [S2].
- When comparison results are the specified status (=, <, >, etc.), a parallel connection occurs as the conductive contact.
- Comparison results and operations relate as follows.

Comparison instruction	Relationship between S1 and S2		
	S1 < S2	S1 = S2	S1 > S2
OR=	OFF	ON	OFF
OR<>	ON	OFF	ON
OR>	OFF	OFF	ON
OR>=	OFF	ON	ON
OR<	ON	OFF	OFF
OR<=	ON	ON	OFF

(Note 1) "<>" is displayed as "≠".

">=" is displayed as "≥".

"<=" is displayed as "≤".

■ Operation example

Operation of instruction format description program

When external input X0 turns ON, or the result of comparison between the value of DT0 and K60 is $DT0 \geq K60$, external output Y30 turns ON. If X0 is OFF and $DT0 < K60$, Y30 turns OFF.

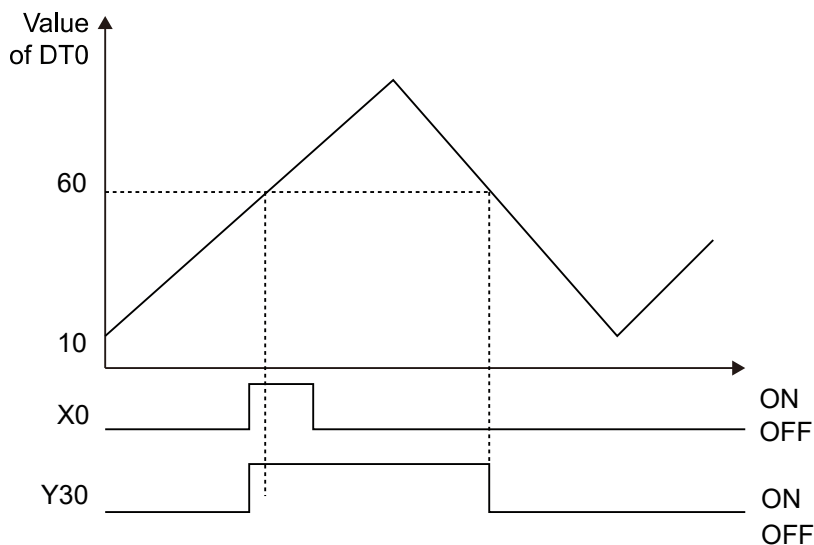

■ Precautions for use

- These instructions start from the bus bar.
- These instructions can be used consecutively.
- In the case of BCD data, etc., data is compared as a negative value if the most significant bit is 1, so the comparison results may not be accurate. In cases such as this, compare after converting the data to binary data by using an instruction such as F81 BIN.

■ Flag operations

Name	Description
R9007 R9008 (ER)	Turns ON when the area is exceeded in index modification.

9.4 STD=, STD<>, STD>, STD>=, STD<, STD<= [32-bit Data Comparison(start)]

■ **Instruction format**

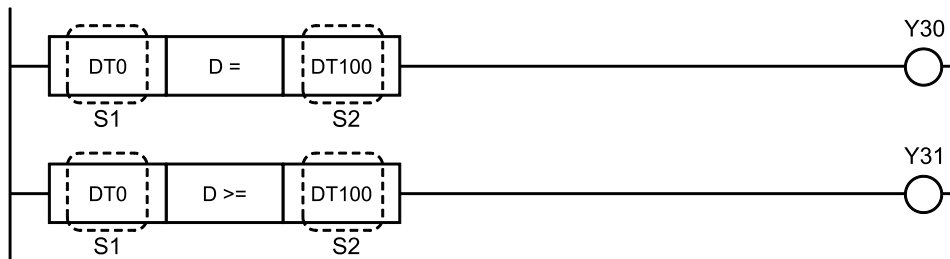

■ **Operands**

Items	Settings
S1	Comparison data 1: Area number storing the 32-bit data, or constant data
S2	Comparison data 2: Area number storing the 32-bit data, or constant data

■ **Devices that can be specified (indicated by ●)**

Operands	WX	WY	WR	WL	SV	EV	DT	LD	I	SWR	SDT	Constant				Index modifier	Integer Device
												K	H	M	f		
S1	●	●	●	●	●	●	●	●	●	●	●	●	●	●	●	●	
S2	●	●	●	●	●	●	●	●	●	●	●	●	●	●	●	●	

■ **Outline of operation**

- Compares the signed 32-bit data of the combined area of [S1] and [S1+1] with the signed 32-bit data of the combined area of [S2] and [S2+1].
- If the comparison results in one of the specified statuses (=, <, >, etc.), a logical operation is initiated with the contacts operating as liaison contacts.
- The relationship between comparison results and operation is the same as "9.1 ST=, ST <>, ST>, ST>=, ST<, ST<= [16-bit Data Comparison (Start)]".
- Memory area is specified by the memory area number of the lower order hexadecimal part.

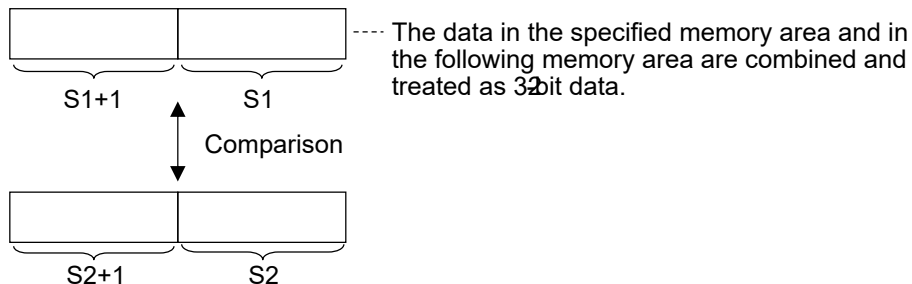

■ **Operation example**

Operation of instruction format description program

The 32-bit value that is a combination of data registers DT0 and DT1 is compared with the 32-bit value that is a combination of DT100 and DT101, and if (DT0, DT1) = (DT100, DT101), external output Y30 turns ON. If (DT0, DT1) is greater than (DT100, DT101), Y31 turns ON.

■ **Precautions for use**

- These instructions start from the bus bar.
- In the case of BCD data, etc., data is compared as a negative value if the most significant bit is 1, so the comparison results may not be accurate. In these instances, use the F83 DBIN instruction or similar to convert to binary data before comparison.

■ **Flag operations**

Name	Description
R9007 R9008 (ER)	Turns ON when the area is exceeded in index modification.

9.5 AND=, AND<>, AND>, AND>=, AND<, AND<= [32-bit Data Comparison (AND)]

9.5 AND=, AND<>, AND>, AND>=, AND<, AND<= [32-bit Data Comparison (AND)]

■ Instruction format

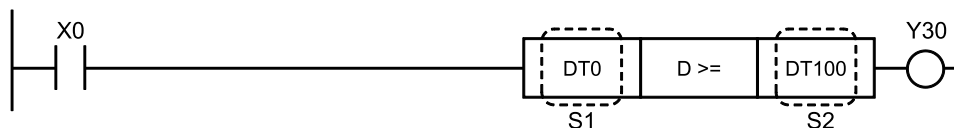

■ Operands

Items	Settings
S1	Comparison data 1: Area number storing the 32-bit data, or constant data
S2	Comparison data 2: Area number storing the 32-bit data, or constant data

■ Devices that can be specified (indicated by ●)

Operands	WX	WY	WR	WL	SV	EV	DT	LD	I	SW R	SD T	Constant				Index modifier	Integer Device
												K	H	M	f		
S1	●	●	●	●	●	●	●	●	●	●	●	●	●	●	●	●	
S2	●	●	●	●	●	●	●	●	●	●	●	●	●	●	●	●	

■ Outline of operation

- Compares the signed 32-bit data of the combined area of [S1] and [S1+1] with the signed 32-bit data of the combined area of [S2] and [S2+1].
- If the comparison results in one of the specified statuses (=, <, >, etc.), the contacts are connected in series as liaison contacts.
- The relationship between comparison results and operation is the same as "9.2 AN=, AN<>, AN>, AN>=, AN<, AN<= [16-bit Data Comparison (AND)]".
- Memory area is specified by the memory area number of the lower order hexadecimal part.

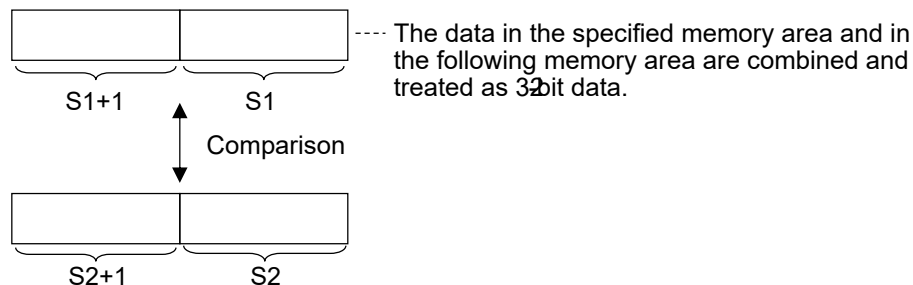

■ Operation example

Operation of instruction format description program

When the external input X0 is ON, and when the comparison result of the combined 32-bit values of data registers DT0 and DT1 and the combined 32-bit values of DT100 and DT101 is

9.5 AND=, AND<>, AND>, AND>=, AND<, AND<= [32-bit Data Comparison (AND)]

(DT0, DT1) ≥ (DT100, DT101), the external output Y30 turns ON. If X0 is OFF or if (DT0, DT1) is less than (D100, D101), Y30 turns OFF.

■ Precautions for use

- These instructions can be used consecutively.
- In the case of BCD data, etc., data is compared as a negative value if the most significant bit is 1, so the comparison results may not be accurate. In these instances, use the F83 DBIN instruction or similar to convert to binary data before comparison.

■ Flag operations

Name	Description
R9007 R9008 (ER)	Turns ON when the area is exceeded in index modification.

9.6 ORD=, ORD<>, ORD>, ORD>=, ORD<, ORD<= [32-bit Data Comparison (OR)]

9.6 ORD=, ORD<>, ORD>, ORD>=, ORD<, ORD<= [32-bit Data Comparison (OR)]

■ Instruction format

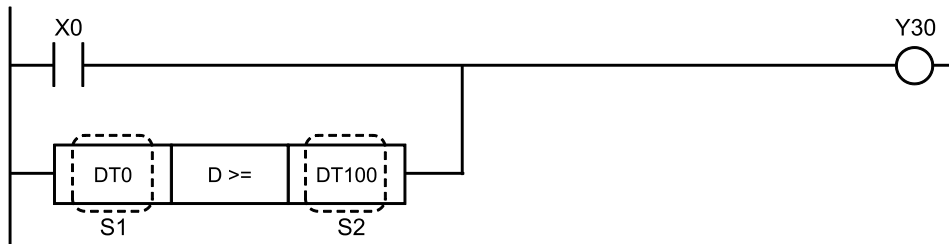

■ Operands

Items	Settings
S1	Comparison data 1: Area number storing the 32-bit data, or constant data
S2	Comparison data 2: Area number storing the 32-bit data, or constant data

■ Devices that can be specified (indicated by ●)

Operands	WX	WY	WR	WL	SV	EV	DT	LD	I	SWR	SDT	Constant				Index modifier	Integer Device
												K	H	M	f		
S1	●	●	●	●	●	●	●	●	●	●	●	●	●	●	●	●	
S2	●	●	●	●	●	●	●	●	●	●	●	●	●	●	●	●	

■ Outline of operation

- This compares signed 32-bit data for the combined [S1] and [S1+1] area with the signed 32-bit data for the combined [S2] and [S2+1] area.
- When comparison results are the specified status (=, <, >, etc.), a parallel connection occurs as the conductive contact.
- The relationship between comparison results and operation is the same as "9.3 OR= OR <> OR > OR >= OR < OR <= [16-bit Data Comparison (OR)]".
- Memory area is specified by the memory area number of the lower order hexadecimal part.

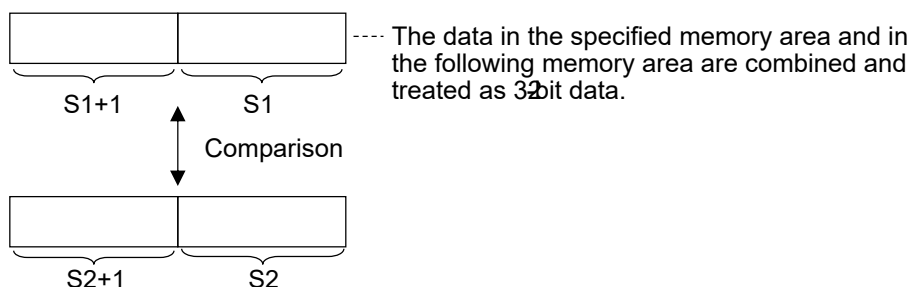

■ **Operation example**

Operation of instruction format description program

When external input X0 turns ON, or when $(DT0, DT1) \geq (DT100, DT101)$ after a comparison between the 32-bit value from combining data register DT0 and DT1 and the 32-bit value from combining data register DT100 and DT101, then the external output Y30 is ON. If X0 is OFF and $(DT0, DT1) < (DT100, DT101)$, then Y30 turns OFF.

■ **Precautions for use**

- These instructions start from the bus bar.
- These instructions can be used consecutively.
- In the case of BCD data, etc., data is compared as a negative value if the most significant bit is 1, so the comparison results may not be accurate. In these instances, use the F83 DBIN instruction or similar to convert to binary data before comparison.

■ **Flag operations**

Name	Description
R9007 R9008 (ER)	Turns ON when the area is exceeded in index modification.

9.7 STF=, STF<>, STF>, STF>=, STF< and STF<= [Floating point real number data comparison (start)]

9.7 STF=, STF<>, STF>, STF>=, STF< and STF<= [Floating point real number data comparison (start)]

■ **Instruction format**

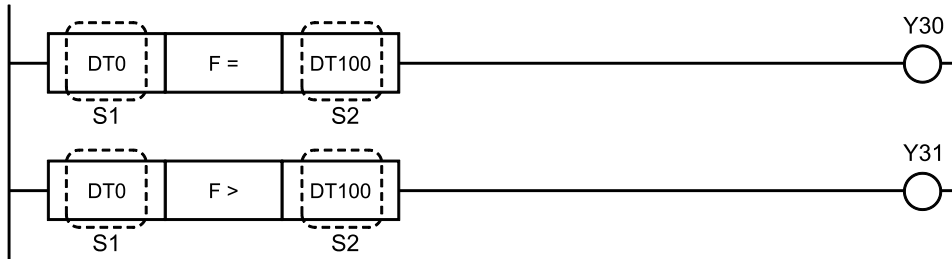

■ **Operands**

Items	Settings
S1	Area storing real number data, or real number data (comparison data 1) (two words)
S2	Area storing real number data, or real number data (comparison data 2) (two words)

■ **Devices that can be specified (indicated by ●)**

Operands	WX	WY	WR	WL	SV	EV	DT	LD	I	SWR	SDT	Constant				Index modifier	Integer Device
												K	H	M	f		
S1	●	●	●	●	●	●	●	●	●	●	●	●	●	●	●	●	●
S2	●	●	●	●	●	●	●	●	●	●	●	●	●	●	●	●	●

■ **Outline of operation**

- Compares the real number data in the area combining [S1] and [S1+1] with the real number data in the area combining [S2] and [S2+1].
- If the comparison results in one of the specified statuses (=, <, >, etc.), a logical operation is initiated with the contacts operating as liaison contacts.
- The relationship between comparison results and operation is the same as "9.1 ST=, ST<>, ST>, ST>=, ST<, ST<= [16-bit Data Comparison (Start)]".
- Memory area is specified by the memory area number of the lower order hexadecimal part.

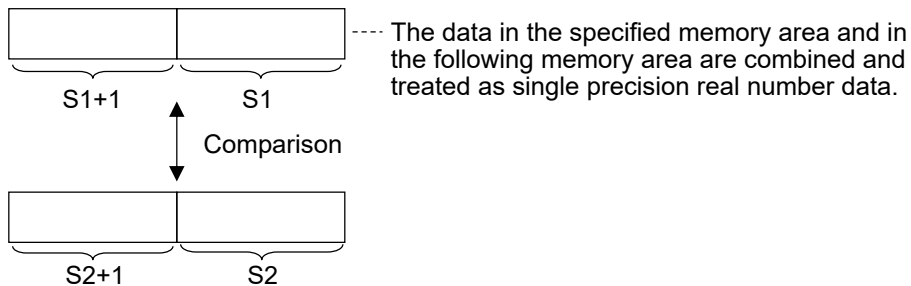

■ **Operation example**

Operation of instruction format description program

The real number that is a combination of data registers DT0 and DT1 is compared with the real number that is a combination of data registers DT100 and DT101, and if (DT0, DT1) is equal to (DT100, DT101), external output Y30 turns ON. If (DT0, DT1) is greater than (DT100, DT101), Y31 turns ON.

■ **Precautions for use**

- These instructions start from the bus bar.
- If [S1] and [S2] are specified with an integer device, the operation occurs after the integer data is internally converted to real numbers.
- If a K constant is specified for [S1] or [S2], the same processing is performed as when an integer device is specified.

■ **Flag operations**

Name	Description
R9007	Turns ON when the area is exceeded in index modification.
R9008 (ER)	Turns ON when non-real-number data is specified in [S1, S1+1] or [S2, S2+1]

9.8 ANF=, ANF<>, ANF>, ANF>=, ANF<, ANF<= [Floating point real number data comparison (AND)]

9.8 ANF=, ANF<>, ANF>, ANF>=, ANF<, ANF<= [Floating point real number data comparison (AND)]

■ **Instruction format**

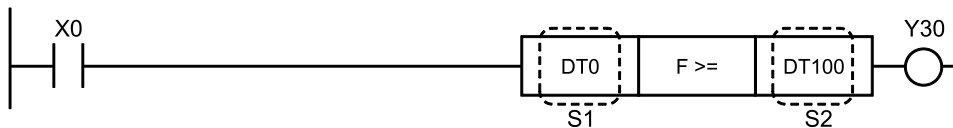

■ **Operands**

Items	Settings
S1	Area storing real number data, or real number data (comparison data 1) (two words)
S2	Area storing real number data, or real number data (comparison data 2) (two words)

■ **Devices that can be specified (indicated by ●)**

Operands	WX	WY	WR	WL	SV	EV	DT	LD	I	SW R	SD T	Constant				Index modifier	Integer Device
												K	H	M	f		
S1	●	●	●	●	●	●	●	●	●	●	●	●	●	●	●	●	●
S2	●	●	●	●	●	●	●	●	●	●	●	●	●	●	●	●	●

■ **Outline of operation**

- Compares the real number data in the area combining [S1] and [S1+1] with the real number data in the area combining [S2] and [S2+1].
- If the comparison result is one of the specified statuses (=, >, <, etc.), the contacts are connected in series as liaison contacts.
- The relationship between comparison results and operation is the same as "9.2 AN=, AN<>, AN>, AN>=, AN<, AN<= [16-bit Data Comparison (AND)]".
- Memory area is specified by the memory area number of the lower order hexadecimal part.

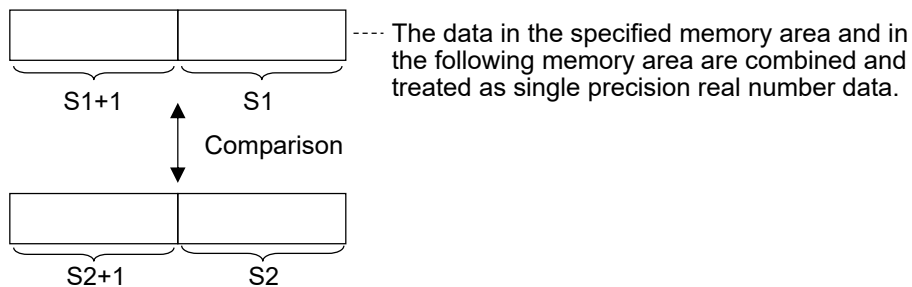

■ **Operation example**

Operation of instruction format description program

When external input X0 turns ON, the real number that is a combination of data registers DT0 and DT1 is compared with the real number that is a combination of data registers DT100 and

9.8 ANF=, ANF<>, ANF>, ANF>=, ANF<, ANF<= [Floating point real number data comparison (AND)]

DT101, and if (DT0, DT1) is equal to or greater than (DT100, DT101), external output Y30 turns ON. If X0 is OFF or if (DT0, DT1) is less than (D100, D101), Y30 turns OFF.

■ Precautions for use

- These instructions can be used consecutively.
- If [S1] and [S2] are specified with an integer device, the operation occurs after the integer data is internally converted to real numbers.
- If a K constant is specified for [S1] or [S2], the same processing is performed as when an integer device is specified.

■ Flag operations

Name	Description
R9007	Turns ON when the area is exceeded in index modification.
R9008 (ER)	Turns ON when non-real-number data is specified in [S1, S1+1] or [S2, S2+1]

9.9 ORF=, ORF<>, ORF>, ORF>=, ORF<, ORF<= [floating point real number data comparison (OR)]

9.9 ORF=, ORF<>, ORF>, ORF>=, ORF<, ORF<= [floating point real number data comparison (OR)]

■ **Instruction format**

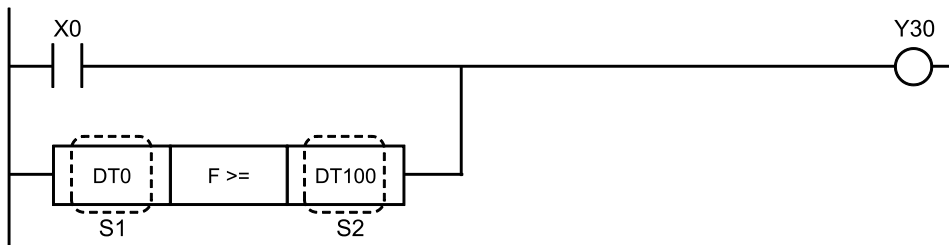

■ **Operands**

Items	Settings
S1	Area storing real number data, or real number data (comparison data 1) (two words)
S2	Area storing real number data, or real number data (comparison data 2) (two words)

■ **Devices that can be specified (indicated by ●)**

Operands	WX	WY	WR	WL	SV	EV	DT	LD	I	SWR	SDT	Constant				Index modifier	Integer Device
												K	H	M	f		
S1	●	●	●	●	●	●	●	●	●	●	●	●	●	●	●	●	●
S2	●	●	●	●	●	●	●	●	●	●	●	●	●	●	●	●	●

■ **Outline of operation**

- Compares the real number data in the area combining [S1] and [S1+1] with the real number data in the area combining [S2] and [S2+1].
- If the comparison result is in the specified status (=, >, <, ...), it is connected in parallel as a conducting contact.
- The relationship between comparison results and operation is the same as "9.3 OR= OR <> OR > OR >= OR < OR <= [16-bit Data Comparison (OR)]".
- Memory area is specified by the memory area number of the lower order hexadecimal part.

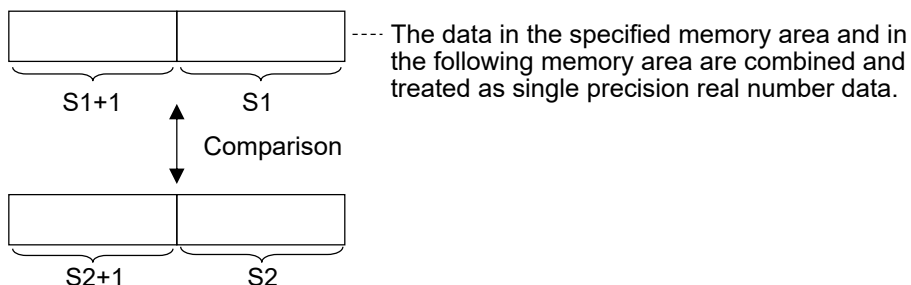

■ **Operation example**

Operation of instruction format description program

If external input X0 is ON, or if the real number values of combined data registers DT0 and DT1 and the real number values of combined data registers DT100 and DT101 are compared and $(DT0, DT1) \geq (DT100, DT101)$, then the external output Y30 turns ON. If X0 is OFF and $(DT0, DT1) < (DT100, DT101)$, then Y30 turns OFF.

■ **Precautions for use**

- This instruction starts from the bus bar.
- These instructions can be used consecutively.
- If [S1] and [S2] are specified with an integer device, the operation occurs after the integer data is internally converted to real numbers.
- If a K constant is specified for [S1] or [S2], the same processing is performed as when an integer device is specified.

■ **Flag operations**

Name	Description
R9007	Turns ON when the area is exceeded in index modification.
R9008 (ER)	Turns ON when non-real-number data is specified in [S1, S1+1] or [S2, S2+1]

(MEMO)

10 Transfer Instructions

10.1 F0 MV (16-bit Data Transfer)	10-2
10.2 F0 MV (10 μ sec Ring Counter Read)	10-4
10.3 F1 DMV (32-bit Data Transfer)	10-5
10.4 F2 MV/ (16-bit Data Inversion and Transfer)	10-7
10.5 F3 DMV/ (32-bit Data Inversion and Transfer).....	10-9
10.6 F5 BTM (Bit Data Transfer).....	10-11
10.7 F6 DGT (Digit Data Transfer).....	10-16
10.8 F7 MV2 (Two 16-bit Data Transfer to Single Area).....	10-20
10.9 F8 DMV2 (32-bit 2 Data Transfer)	10-22
10.10 F10 BKMV (Data Block Transfer)	10-24
10.11 F11 COPY (16-bit Data Block Copy).....	10-27
10.12 F12 ICRD (Data Read from F-ROM)	10-29
10.13 P13 ICWT (Writing to F-ROM)	10-31
10.14 F15 XCH (16-bit Data Exchange)	10-33
10.15 F16 DXCH (32-bit Data Exchange).....	10-35
10.16 F17 SWAP (Higher/Lower Byte Exchange)	10-37
10.17 F18 BXCH (Block Exchange).....	10-39
10.18 F190 MV3 (Three 16-bit Data Transfer to Single Area).....	10-41
10.19 F191 DMV3 (32-Bit 3-Data Batch Transfer).....	10-43

10.1 F0 MV (16-bit Data Transfer)

10.1 F0 MV (16-bit Data Transfer)

Transfers the 16-bit data in the specified area number.

■ Instruction format

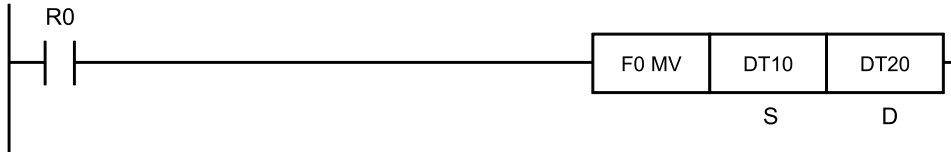

■ Operands

Items	Settings
S	Area storing the hexadecimal data or constant data
D	Area where data is transferred to

■ Devices that can be specified (indicated by ●)

Operands	WX	WY	WR	WL	SV	EV	DT	LD	I	SW R	SD T	Constant				Index modifier	Integer Device
												K	H	M	f		
S	●	●	●	●	●	●	●	●	●	●	●	●	●	●	●		
D		●	●	●	●	●	●	●	●	●	●					●	

■ Outline of operation

- The 16-bit data in the memory area specified by [S] is transferred to the memory area specified by [D].

■ Operation example

Example 1: Instruction format and described program operation

- When the internal relay R0 turns ON, the content of data register DT10 is transferred to data register DT20.

Example 2: Constant K30 is transferred to the timer 0 setting value area when internal relay R1 turns ON

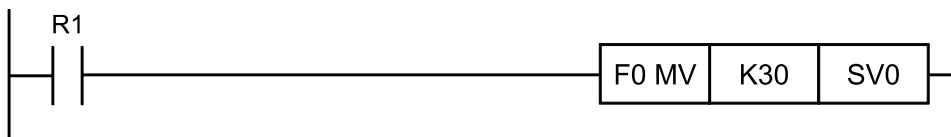

Example 3: The timer 0 elapsed value is transferred to data register DT0 when R2 turns ON

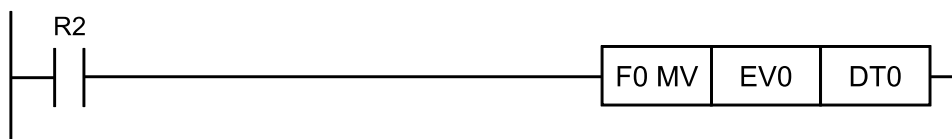

■ Flag operations

Name	Description
R9007 R9008 (ER)	Turns ON when the area is exceeded in index modification.

10.2 F0 MV (10 μsec Ring Counter Read)

10.2 F0 MV (10 μsec Ring Counter Read)

■ Instruction format

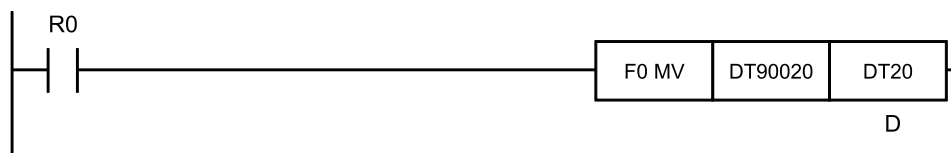

■ Operands

Items	Settings
D	Area where data is transferred to

■ Devices that can be specified (indicated by ●)

Operands	WX	WY	WR	WL	SV	EV	DT	LD	I	SWR	SDT	Constant			Index modifier	Integer Device
												K	H	M		
D		●	●	●	●	●	●	●	●						●	

■ Outline of operation

- When this instruction is executed, the 10 μsec ring counter (H0 to HFFFF) is read once, and the read value is transferred to the memory area specified by [D]. At the same time, the value stored in special data register DT90020 (10 μsec ring counter) is also updated.

■ Operation example

Operation of instruction format description program

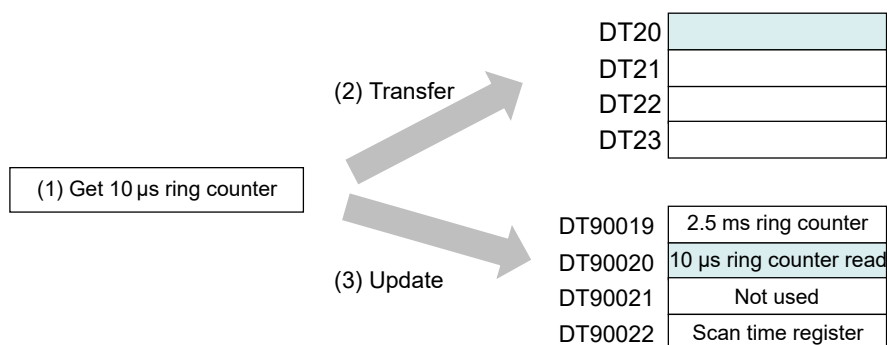

■ Flag operations

Name	Description
R9007 R9008 (ER)	Turns ON when the area is exceeded in index modification.

10.3 F1 DMV (32-bit Data Transfer)

Transfers 32-bit data to the specified area number.

■ Instruction format

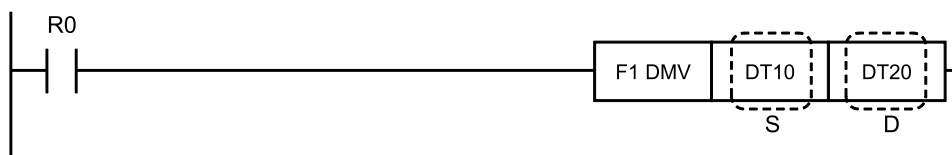

■ Operands

Items	Settings
S	Area storing 32-bit data, or constant data
D	Area where data is transferred to

■ Devices that can be specified (indicated by ●)

Operands	WX	WY	WR	WL	SV	EV	DT	LD	I	SWR	SDT	Constant				Index modifier	Integer Device
												K	H	M	f		
S	●	●	●	●	●	●	●	●	●	●	●	●	●	●	●	●	
D		●	●	●	●	●	●	●	●							●	

■ Outline of operation

The 32-bit data in the memory area specified by [S] is transferred to the memory area specified by [D].

■ Operation example

Operation of instruction format description program

When the internal relay R0 turns ON, the content of data register DT10 and DT11 is transferred to data register DT20 and DT21.

- Specify a lower 16-bit memory area for the memory area.

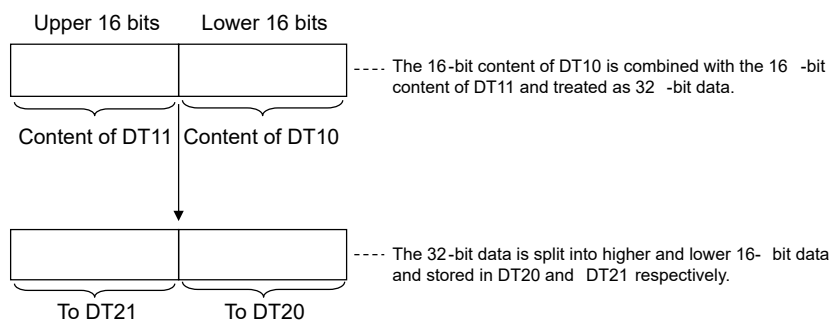

10.3 F1 DMV (32-bit Data Transfer)

■ Flag operations

Name	Description
R9007 R9008 (ER)	Turns ON when the area is exceeded in index modification.

10.4 F2 MV/ (16-bit Data Inversion and Transfer)

Inverts and transfers 16-bit data at the specified area number.

■ Instruction format

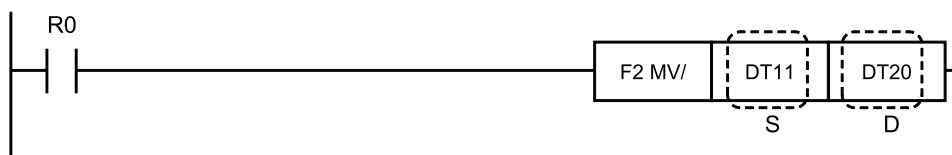

■ Operands

Items	Settings
S	Area storing the hexadecimal data or constant data
D	Area where data is transferred to

■ Devices that can be specified (indicated by ●)

Operands	WX	WY	WR	WL	SV	EV	DT	LD	I	SWR	SDT	Constant				Index modifier	Integer Device
												K	H	M	f		
S	●	●	●	●	●	●	●	●	●	●	●	●	●	●	●	●	
D		●	●	●	●	●	●	●	●							●	

■ Outline of operation

The 16-bit data in the area specified by [S] is logically inverted ($0 \Leftrightarrow 1$ inversion) and transferred to the area specified by [D].

BIN

0	0	0	0	0	1	0	0	1	1	0	1	0	0	1	0
---	---	---	---	---	---	---	---	---	---	---	---	---	---	---	---

HEX 0 4 D 2



BIN

1	1	1	1	1	0	1	1	0	0	1	0	1	1	0	1
---	---	---	---	---	---	---	---	---	---	---	---	---	---	---	---

HEX F B 2 D

■ Operation example

Operation of instruction format description program

When internal relay R0 turns ON, the contents of data register DT11 are logically inverted and transferred to data register DT20.

10.4 F2 MV/ (16-bit Data Inversion and Transfer)

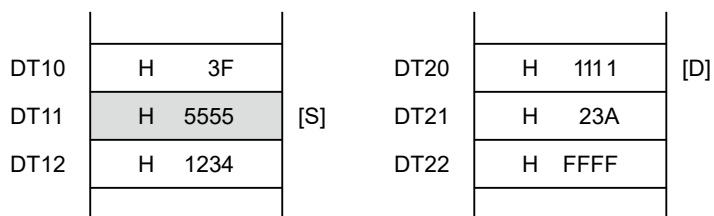

R0:ON
 ↓
 F2 execution

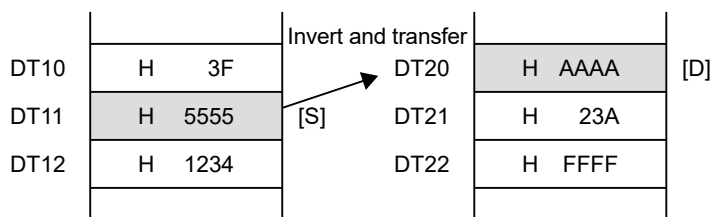

DT11 = "0101 0101 0101 0101" (H5555)

↓ Invert and transfer

DT20 = "1010 1010 1010 1010" (HAAAA)

■ Flag operations

Name	Description
R9007 R9008 (ER)	Turns ON when the area is exceeded in index modification.

10.5 F3 DMV/ (32-bit Data Inversion and Transfer)

Inverts the 32-bit data in the specified area number and transfers it.

■ Instruction format

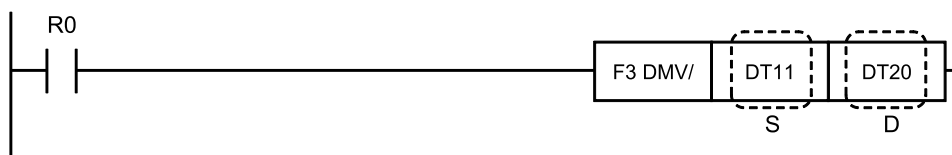

■ Operands

Items	Settings
S	Area storing 32-bit data, or constant data
D	Area where data is transferred to

■ Devices that can be specified (indicated by ●)

Operand s	WX	WY	WR	WL	SV	EV	DT	LD	I	SW R	SD T	Constant				Index modifier	Integer Device
												K	H	M	f		
S	●	●	●	●	●	●	●	●	●	●	●	●	●	●	●	●	
D		●	●	●	●	●	●	●	●							●	

■ Outline of operation

The 32-bit data in the area specified by [S] is logically inverted ($0 \leftrightarrow 1$ inversion) and transferred to the area specified by [D].

S	1	1	0	0	1	1	0	1	0	0	0	1	0	1	0	1
S+1	0	0	0	0	0	1	1	1	0	1	0	1	1	0	1	1
↓																
D	0	0	1	1	0	0	1	0	1	1	1	0	1	0	1	0
D+1	1	1	1	1	1	0	0	0	1	0	1	0	0	1	0	0

■ Operation example

Operation of instruction format description program

When internal relay R0 turns ON, the contents of data registers DT11 and DT12 are logically inverted and transferred to data registers DT20 and DT21.

10.5 F3 DMV/ (32-bit Data Inversion and Transfer)

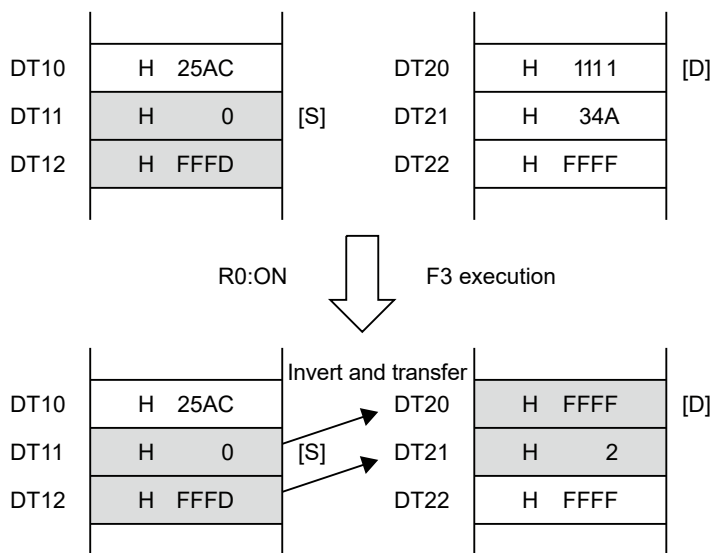

■ Flag operations

Name	Description
R9007 R9008 (ER)	Turns ON when the area is exceeded in index modification.

10.6 F5 BTM (Bit Data Transfer)

Transfers 1-bit data in the specified 16-bit data to the specified bit.

■ Instruction format

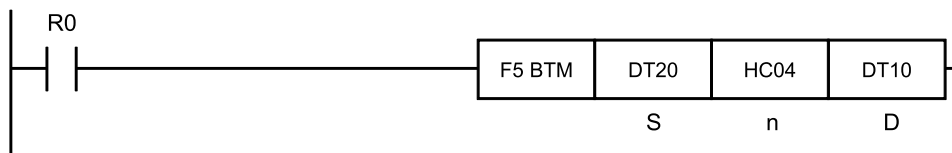

■ Operands

Items	Settings
S	Area storing the hexadecimal data or constant data
n	Area specifying the transfer method
D	Data destination storage area

■ Devices that can be specified (indicated by ●)

Operands	WX	WY	WR	WL	SV	EV	DT	LD	I	SWR	SDT	Constant				Index modifier	Integer Device
												K	H	M	f		
S	●	●	●	●	●	●	●	●	●	●	●	●	●	●	●	●	
n	●	●	●	●	●	●	●	●	●	●	●	●	●	●	●	●	
D		●	●	●	●	●	●	●	●							●	

■ Outline of operation

- Transfers the content of one bit ("1" or "0") at any position in the 16-bit data of the area specified by [S] to any bit of the memory area specified by [D]. The bit position is specified by the value of [n].

■ Operation example

Operation of instruction format description program

- When internal relay R0 turns ON, the content of bit 4 of data register DT20 is transferred to bit 12 of DT10.

10.6 F5 BTM (Bit Data Transfer)

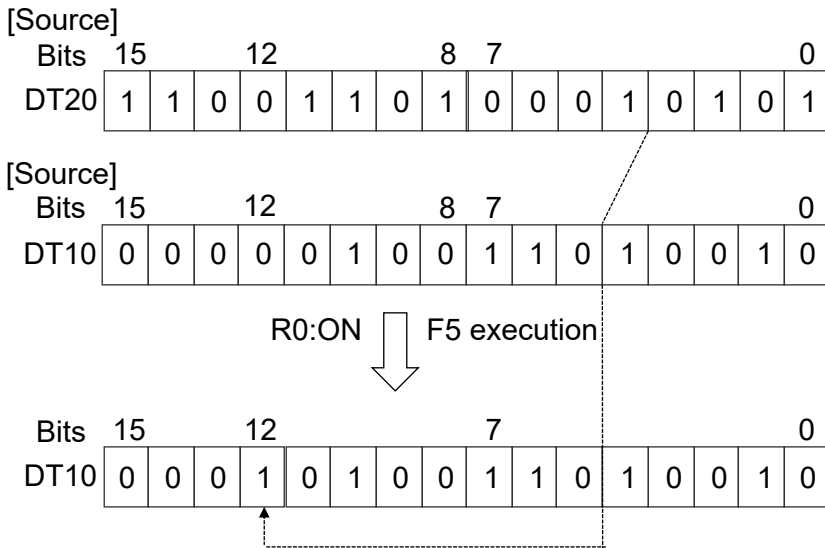

■ About transfer method specification [n]

- Specify [n] as an H constant in the following format:

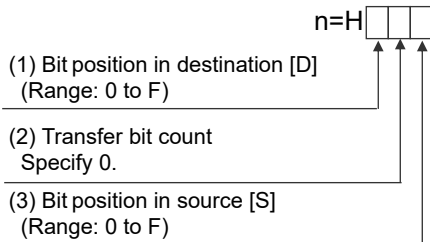

Bit position specification of [S] and [D]

Bits Position	15	14	13	12	11	10	9	8	7	6	5	4	3	2	1	0
Set value (H)	F	E	D	C	B	A	9	8	7	6	5	4	3	2	1	0

For example, specify A to specify bit 10. When transferring bit 4 of [S] to bit 12 of [D], $n = \text{HC04}$.

■ Transferring multiple bits

- When the number of transfer bits is specified in n , the specified bits from the position specified by [S] are transferred to the position whose start is specified by [D].
- Up to 16 bits can be transferred. Specify the number of transfer bits as a hexadecimal number. The range is 0 to F (1 bit to 16 bits).

Number of transfer bits	Setting (n)
1 bit	$\text{H}\square\square$
2-bit	$\text{H}\square\square$

Number of transfer bits	Setting (n)
3 bits	H□2□
4-bit	H□3□
5 bits	H□4□
6 bits	H□5□
7 bits	H□6□
8 bits	H□7□
9 bits	H□8□
10 bits	H□9□
11 bits	H□A□
12 bits	H□B□
13 bits	H□C□
14 bits	H□D□
15 bits	H□E□
16 bits	H□F□

Example 1: When transferring two bits (n = H□1□)

Transfer two bits from [S] bit 5 to [D] bit 10... n = HA15

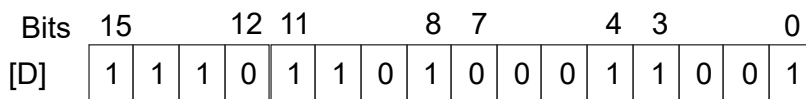
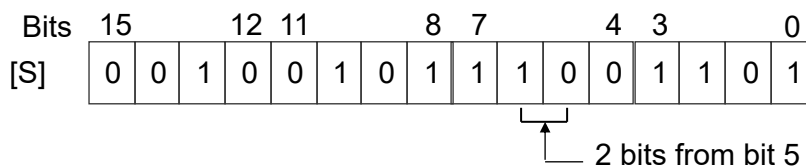

↓ F5 execution

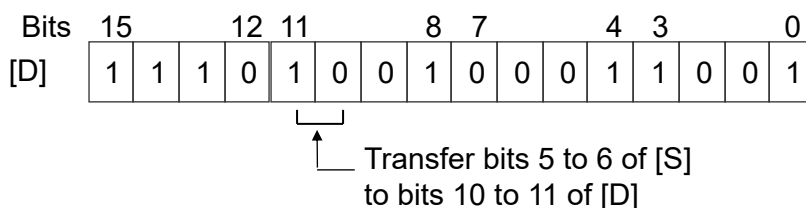

- When 0 is specified for the number of transfer bits, the single specified bit is transferred.
- If the specified range is outside the area of [S], the contents of the part extending beyond the area are set to 0 and transferred.

10.6 F5 BTM (Bit Data Transfer)

Example 2: Transfer four bits from bit 14 of [S] to bit 2 of [D]... n = H23E

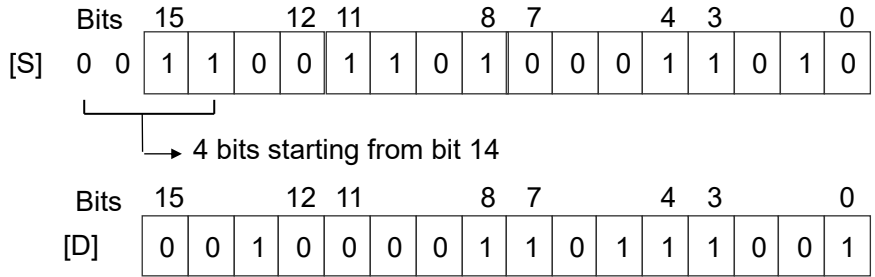

↓ F5 execution

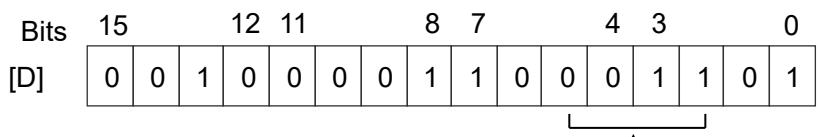

Bits 14 to 15 of [S] are sent to bits 2 to 3 of [D].
0 is stored in bits 4 to 5 of [D].

- If the specified range is outside the area of [D], the part extending beyond the area will not be transferred. Data is not written to the next address.

Example 3: Transfer six bits from bit 6 of [S] to bit 12 of [D]... n = HC56

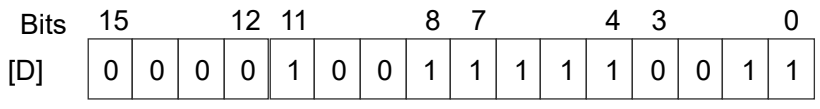
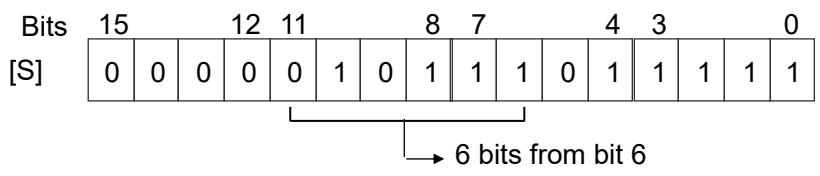

↓ F5 execution

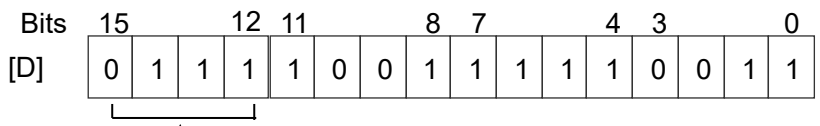

Among bits 6 to 11 of [S], bits 6 to 9 are sent to bits 12 to 15 in [D]
(The content of bits 10 to 11 of [S] have no effect)

■ **Flag operations**

Name	Description
R9007 R9008 (ER)	Turns ON when the area is exceeded in index modification.

10.7 F6 DGT (Digit Data Transfer)

10.7 F6 DGT (Digit Data Transfer)

Transfers the specified 16-bit data in 4-bit (digit) units.

■ Instruction format

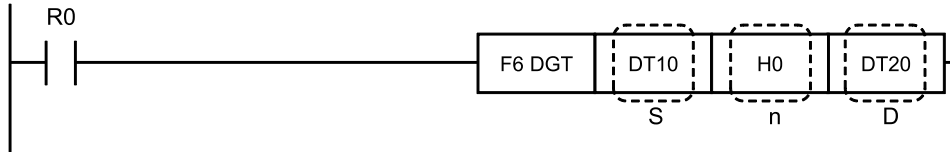

■ Operands

Items	Settings
S	Area storing the hexadecimal data or constant data
n	Area specifying the transfer method
D	Area where data is transferred to

■ Devices that can be specified (indicated by ●)

Operands	WX	WY	WR	WL	SV	EV	DT	LD	I	SWR	SDT	Constant				Index modifier	Integer Device
												K	H	M	f		
S	●	●	●	●	●	●	●	●	●	●	●	●			●		
n	●	●	●	●	●	●	●	●	●	●	●	●			●		
D		●	●	●	●	●	●	●	●						●		

■ Outline of operation

The 16-bit data in the memory area specified by [S] is transferred to the memory area specified by [D], according to the transfer method specified by [n].

■ Operation example

Operation of instruction format description program

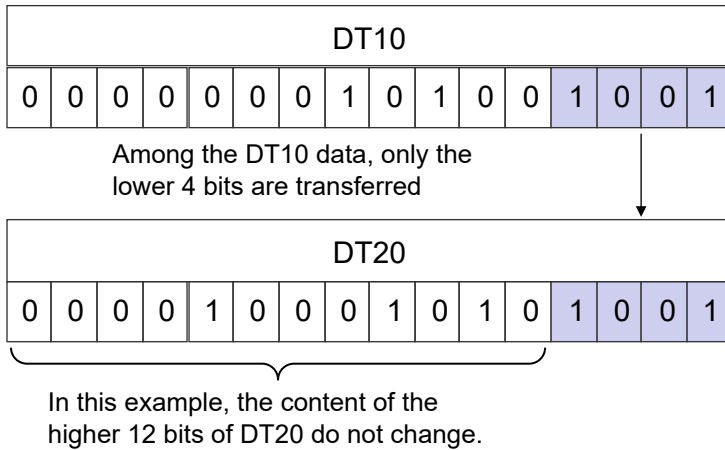

■ What is a digit?

- Digits are units of four bits used when handling data.
- With this instruction, 16-bit data is separated into four digits for convenience. Starting from the lowest four bits, these digits are named digit 0, digit 1, digit 2, and digit 3.

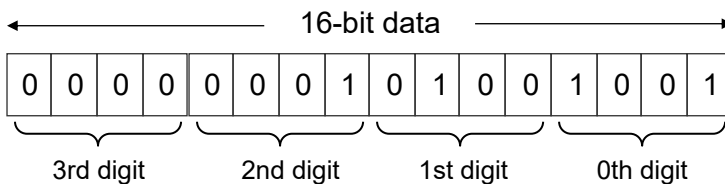

■ About transfer method specification [n]

- For designating
 - (1) which digit to transfer to at the transfer destination;
 - (2) how many digits to transfer; and
 - (3) which digit to transfer from at the transfer source with digit transfer.
- Specify [n] as an H constant in the following format:

10.7 F6 DGT (Digit Data Transfer)

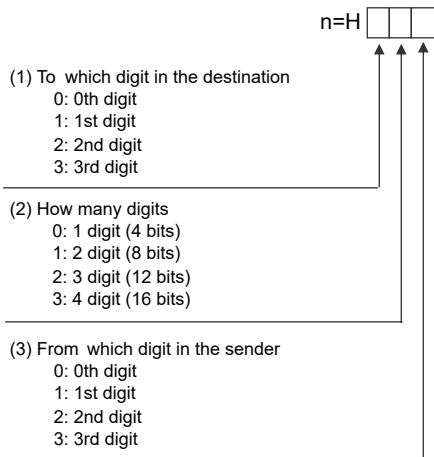

If (1) or (2) is 0, such as "H000" in the program example on the previous page, use the short form "H0".

■ Examples of transfer methods

The following digit transfer patterns are possible based on the specification of [n]:

1. One digit is transferred to a parallel destination

Transferring from digit 1 to digit 1

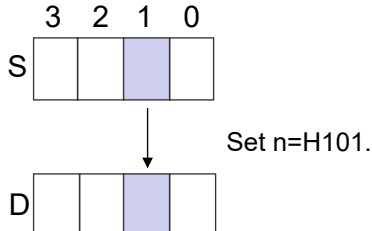

2. One digit is transferred to a non-parallel destination

Transferring from digit 3 to digit 0

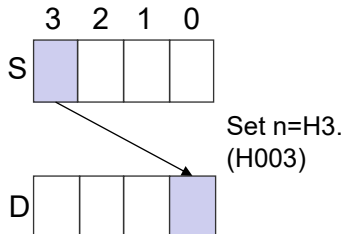

3. Multiple digits are transferred to a parallel destination

Transferring digits 2 and 3 to digits 2 and 3

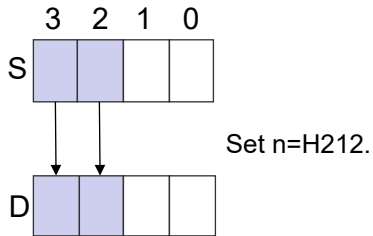

- 4. Multiple digits are transferred to a non-parallel destination

Transferring digits 0 and 1 to digits 2 and 3

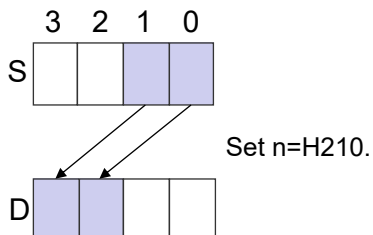

- 5. Four digits are transferred

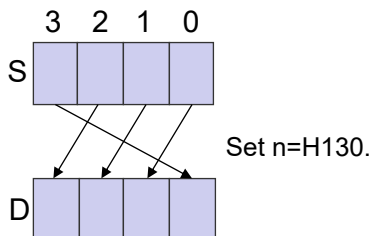

■ **Flag operations**

Name	Description
R9007 R9008 (ER)	Turns ON when the area is exceeded in index modification.

10.8 F7 MV2 (Two 16-bit Data Transfer to Single Area)

10.8 F7 MV2 (Two 16-bit Data Transfer to Single Area)

Two 16-bit data are transferred from the specified area number.

■ Instruction format

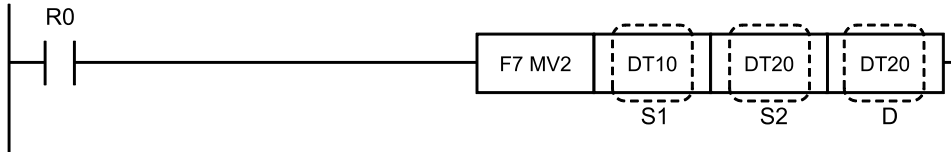

■ Operands

Items	Settings
S1	Area storing the hexadecimal data or constant data
S2	Area storing the hexadecimal data or constant data
D	Starting address of the data transfer destination (two words)

■ Devices that can be specified (indicated by ●)

Operands	WX	WY	WR	WL	SV	EV	DT	LD	I	SWR	SDT	Constant				Index modifier	Integer Device
												K	H	M	f		
S1	●	●	●	●	●	●	●	●	●	●	●	●				●	
S2	●	●	●	●	●	●	●	●	●	●	●	●				●	
D		●	●	●	●	●	●	●	●							●	

■ Outline of operation

The two 16-bit data (two words) specified by [S1] and [S2] are transferred to the memory area (two words) specified by [D].

■ Operation example

Operation of instruction format description program

When the execution condition R0 turns ON, the contents of data register DT10 is transferred to DT30, and the contents of DT20 is transferred to DT31.

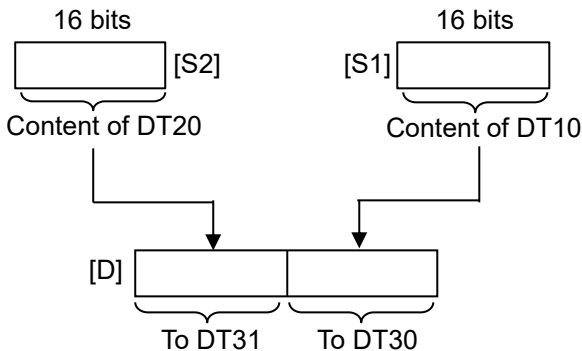

10.8 F7 MV2 (Two 16-bit Data Transfer to Single Area)

■ Related instructions

Use the F190 MV3 instruction to transfer three types of 16-bit data.

■ Flag operations

Name	Description
R9007 R9008 (ER)	Turns ON when the area is exceeded in index modification.

10.9 F8 DMV2 (32-bit 2 Data Transfer)

10.9 F8 DMV2 (32-bit 2 Data Transfer)

Two 32-bit data are transferred from the specified area number.

■ Instruction format

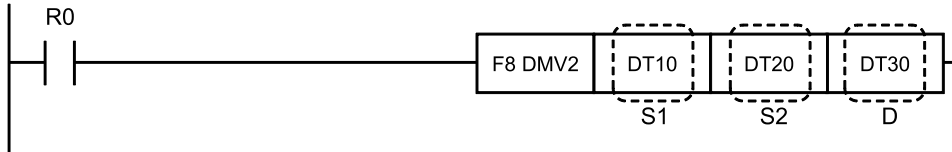

■ Operands

Items	Settings
S1	Area storing 32-bit data, or constant data
S2	Area storing 32-bit data, or constant data
D	Starting address of the data transfer destination area (four words)

■ Devices that can be specified (indicated by ●)

Operands	WX	WY	WR	WL	SV	EV	DT	LD	I	SWR	SDT	Constant				Index modifier	Integer Device
												K	H	M	f		
S1	●	●	●	●	●	●	●	●	●	●	●	●	●	●	●		
S2	●	●	●	●	●	●	●	●	●	●	●	●	●	●	●		
D		●	●	●	●	●	●	●	●							●	

■ Outline of operation

- The two 32-bit data (four words) specified in [S1] and [S2] are transferred to the memory area (four words) specified in [D].
- The specification of [S1] and [S2] specifies the lower 16-bit memory area.
- The specification of [D] specifies the start of the 4 word memory area.

■ Operation example

Operation of instruction format description program

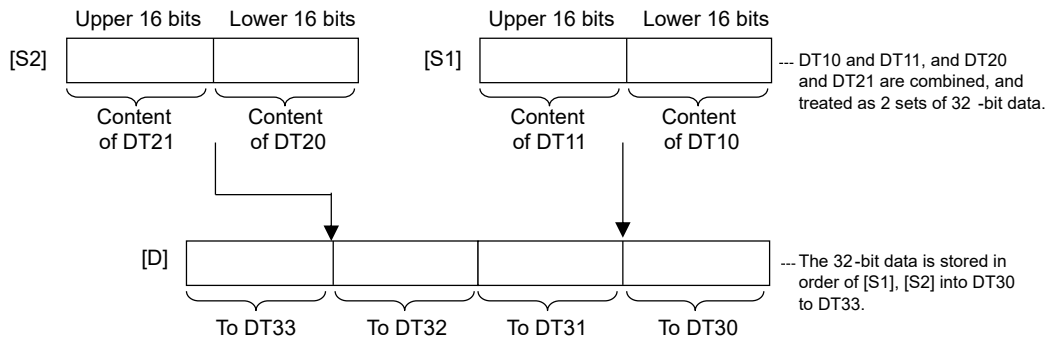

■ **Flag operations**

Name	Description
R9007 R9008 (ER)	Turns ON when the area is exceeded in index modification.

10.10 F10 BKMV (Data Block Transfer)

10.10 F10 BKMV (Data Block Transfer)

Transfers data at the block unit.

■ Instruction format

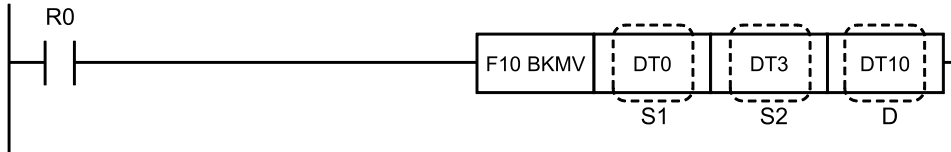

■ Operands

Items	Settings
S1	Starting address of the source data
S2	Final address of the source data
D	Data destination storage area

■ Devices that can be specified (indicated by ●)

Operands	WX	WY	WR	WL	SV	EV	DT	LD	I	SW R	SD T	Constant				Index modifier	Integer Device
												K	H	M	f		
S1	●	●	●	●	●	●	●	●		●	●					●	
S2	●	●	●	●	●	●	●	●		●	●					●	
D		●	●	●	●	●	●	●								●	

■ Outline of operation

This bulk transfers the data between the area specified by [S1] and the area specified by [S2] to the area specified by [D] and later.

■ Operation example

Operation of instruction format description program

When the internal relay R0 turns ON, the data of data registers DT0 to DT3 is transferred to the data registers DT10 to DT13.

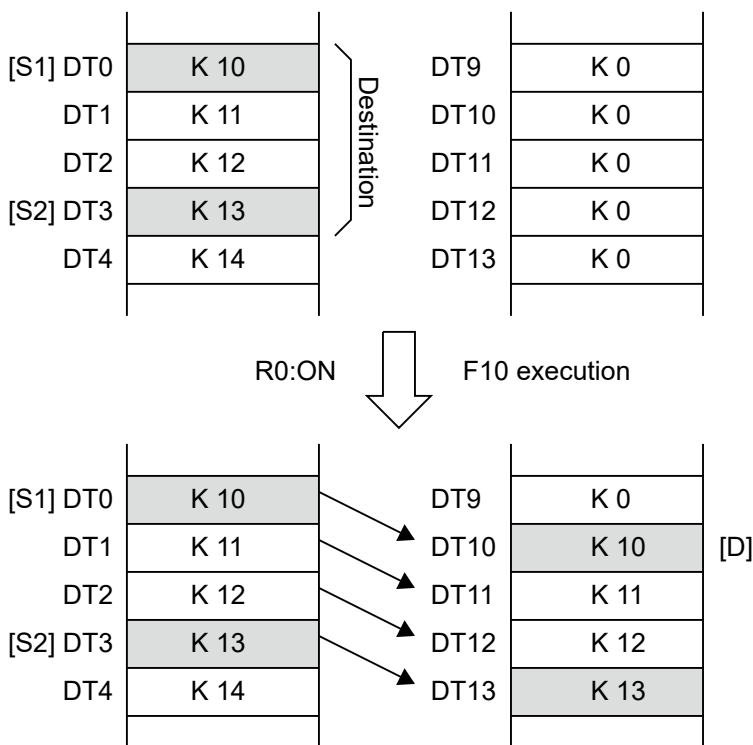

■ **Precautions for programming**

- Specify the same type of memory area for [S1] and [S2].
- Specify the number of the lower address with [S1], and the number of the higher address with [S2].
If [S1] > [S2] is specified and an instruction executed, an operation error will occur.

■ **Precautions if the same type of memory area is specified for S1, S2, and D**

- If [S1] and [D] have the same type and same number of memory area specified, the instruction is not executed.
- If the block being transferred overlaps the destination, transfer results will be overwritten.
- If [S1] < [D], data is transferred starting from the higher address.
In the following example, the data is stored in the order DT4 > DT3 > DT2 > DT1.

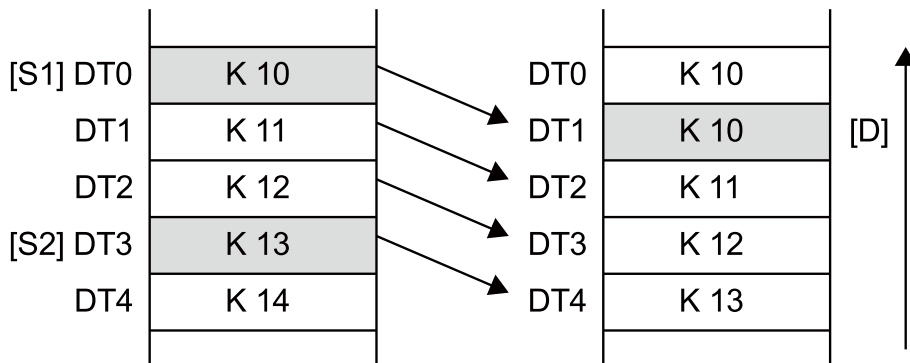

10.10 F10 BKMV (Data Block Transfer)

- If $[S1] > [D]$, data is transferred starting from the lower address.
In the following example, the data is stored in the order $DT0 > DT1 > DT2$.

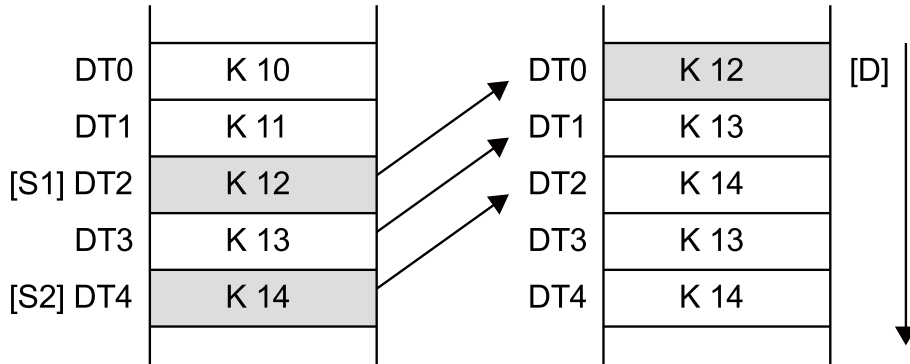

■ Flag operations

Name	Description
R9007 R9008 (ER)	Turns ON when the area is exceeded in index modification.

10.11 F11 COPY (16-bit Data Block Copy)

Copies the specified data to all areas in the range specified by the block.

■ Instruction format

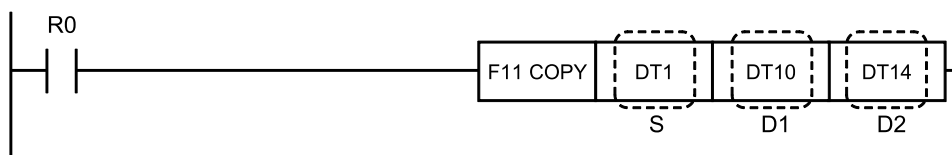

■ Operands

Items	Settings
S	Area storing the copy source data, or constant data
D1	Starting number of data copy destination area
D2	End number of data copy destination area

■ Devices that can be specified (indicated by ●)

Operand s	WX	WY	WR	WL	SV	EV	DT	LD	I	SW R	SD T	Constant				Index modifier	Integer Device
												K	H	M	f		
S	●	●	●	●	●	●	●	●	●	●	●	●	●			●	
D1		●	●	●	●	●	●	●								●	
D2		●	●	●	●	●	●	●								●	

■ Outline of operation

16-bit data in the area specified by [S] is copied to all areas between [D1] and [D2].

■ Operation example

Operation of instruction format description program

The data from data register DT1 is copied to each data register from DT10 to DT14 when internal relay R0 turns ON.

10.11 F11 COPY (16-bit Data Block Copy)

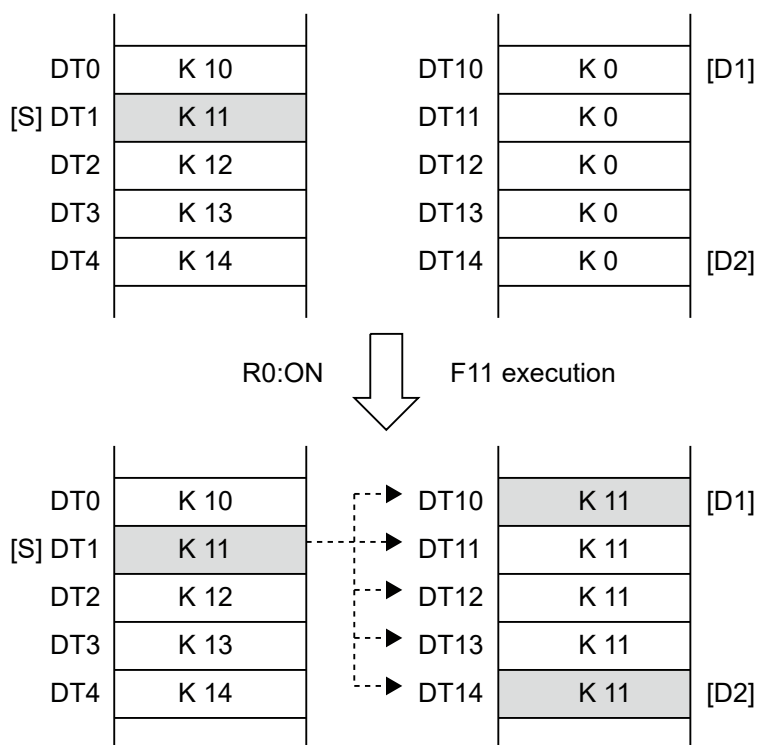

■ Precautions for programming

- Specify the same type of memory area for both [D1] and [D2].
- The area of the lower address for the block being copied should be specified by [D1], and the higher address should be specified by [D2]. If specified as [D1] > [D2], an operation error will occur when the instruction is executed.
- When the same number is specified for [D1] and [D2], the 16-bit data is transferred to that number's area.

■ Flag operations

Name	Description
R9007	Turns ON when the area is exceeded in index modification.
R9008	
(ER)	Turns ON when the D1 address > D2 address

10.12 F12 ICRD (Data Read from F-ROM)

Reads the specified data from the F-ROM area.

■ Instruction format

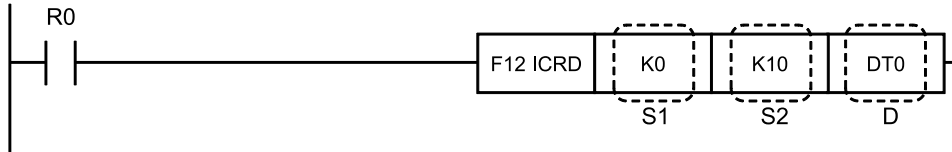

■ Operands

Items	Settings
S1	Starting block number of the F-ROM area (Settable range: K0 to K31)
S2	Number of blocks to be read (Settable range: (K1 to K32)
D	Starting number of area storing read data

■ Devices that can be specified (indicated by ●)

Operands	WX	WY	WR	WL	SV	EV	DT	LD	I	SWR	SDT	Constant				Index modifier	Integer Device
												K	H	M	f		
S1												●					
S2												●					
D							●										

■ Outline of operation

Source

Transfers data starting from the block **S1** in F-ROM for the blocks specified in **S2**.

Destination

Transfers to the memory area starting from the address **D** in the data register.

Transfer units

Data is transferred by the following units.

Data to be transferred per block: 2048 words

■ Settable range of the operand D

The settable range of the operand **D** varies depending on the model and system register No. 0 (setting of the program area size).

System register no.0 Setting of the program area size	Settable range
24	DT0 to DT63488
32	DT0 to DT30720
40	DT0 to DT22528

10.12 F12 ICRD (Data Read from F-ROM)

System register no.0 Setting of the program area size	Settable range
64	DT0 to DT10240

■ Operation example

Operation of instruction format description program

When execution condition R0 turns ON, 10 blocks of F-ROM data from block 0 to block 9 are transferred to data registers DT0 to DT20479.

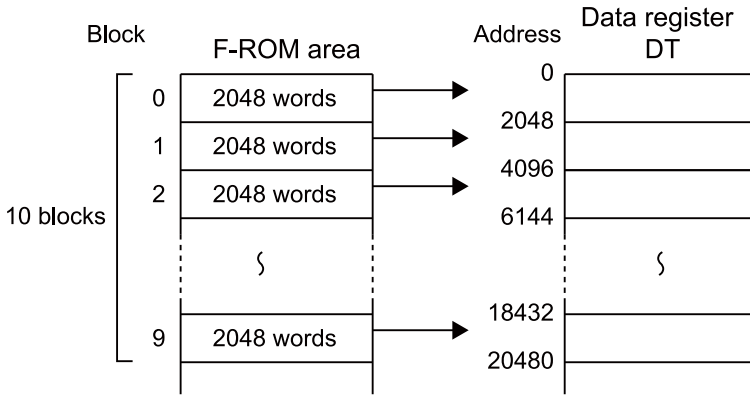

■ Precautions for programming

- Because the initial data in the F-ROM is undefined, caution is required when reading the F-ROM before data has been written to the F-ROM.

■ Flag operations

Name	Description
R9007	Turns ON when the address specified by [S1] does not exist in the F-ROM area
R9008	Turns ON when the area specified by [S2] exceeds the range of the F-ROM area
(ER)	Turns ON when the area is exceeded when the blocks specified by [D] and subsequent parameters are transferred

10.13 P13 ICWT (Writing to F-ROM)

Transfers the specified data to an area in F-ROM.

■ Instruction format

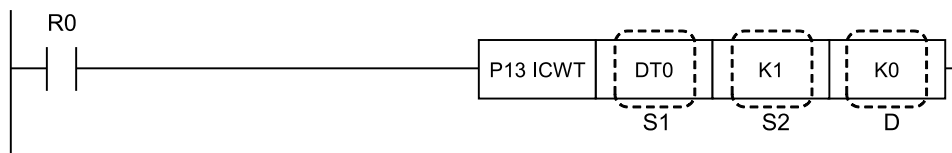

■ Operands

Items	Settings
S1	Starting number of the area storing the write data
S2	Number of blocks to be written (Settable range: K1)
D	Starting number of the F-ROM area where data is to be written (Settable range: K0 to K31)

■ Devices that can be specified (indicated by ●)

Operands	WX	WY	WR	WL	SV	EV	DT	LD	I	SWR	SDT	Constant				Index modifier	Integer Device
												K	H	M	f		
S1							●										
S2												●					
D												●					

■ Outline of operation

Source

Transfers data stored in a data register (data starting from the address **S1**) for the blocks specified in **S2**.

Destination

Transfers to the memory area starting from the block **D** in the F-ROM.

Transfer units

Data is transferred by the following units.

Data to be transferred per block: 2048 words

■ Settable range of the operand S1

The settable range of the operand **S1** varies depending on the model and system register No. 0 (setting of the program area size).

System register no.0 Setting of the program area size	Settable range
24	DT0 to DT63488
32	DT0 to DT30720

10.13 P13 ICWT (Writing to F-ROM)

System register no.0 Setting of the program area size	Settable range
40	DT0 to DT22528
64	DT0 to DT10240

■ Operation example

Operation of instruction format description program

When execution condition R0 turns ON, one block (2,048 words) of data from data register DT0 is transferred to block 0 in the F-ROM area.

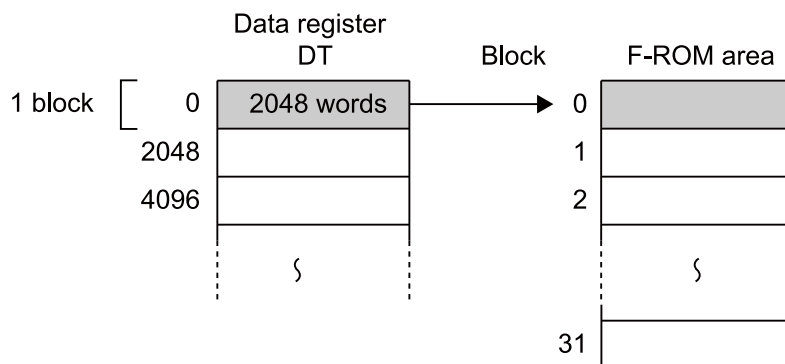

■ Precautions for programming

- Only one block can be written at a time.
- It takes up to approximately 100 ms to execute the instruction. When writing multiple blocks, write them across multiple scans.
- The number of times data can be written to F-ROM is 10,000 times or less.
- This instruction is a differential execution type instruction (P13) used to prevent multiple writes to F-ROM caused by programming errors.
- Be careful to avoid repeated writing to F-ROM when creating the program.
- Do not use this instruction in interrupt programs.

■ Flag operations

Name	Description
R9007	Turns ON when the area is exceeded when transferring the blocks to the area specified from [S1]
R9008	Turns ON when one block is not specified by [S2]
(ER)	Turns ON when the address specified by [D] is not in the F-ROM area

10.14 F15 XCH (16-bit Data Exchange)

Exchanges 16-bit data of two areas.

■ Instruction format

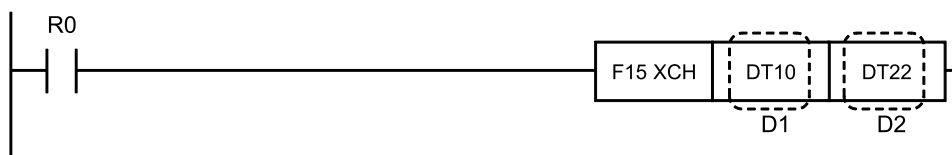

■ Operands

Items	Settings
D1	Area that stores the 16-bit data to exchange with D2
D2	Area that stores the 16-bit data to exchange with D1

■ Devices that can be specified (indicated by ●)

Operands	WX	WY	WR	WL	SV	EV	DT	LD	I	SWR	SDT	Constant				Index modifier	Integer Device
												K	H	M	f		
D1		●	●	●	●	●	●	●	●							●	
D2		●	●	●	●	●	●	●	●							●	

■ Outline of operation

Exchanges the data in the area specified by [D1] with that in the area specified by [D2].

■ Operation example

Operation of instruction format description program

The contents of data register DT10 and data register DT22 are exchanged when internal relay R0 turns ON.

10.14 F15 XCH (16-bit Data Exchange)

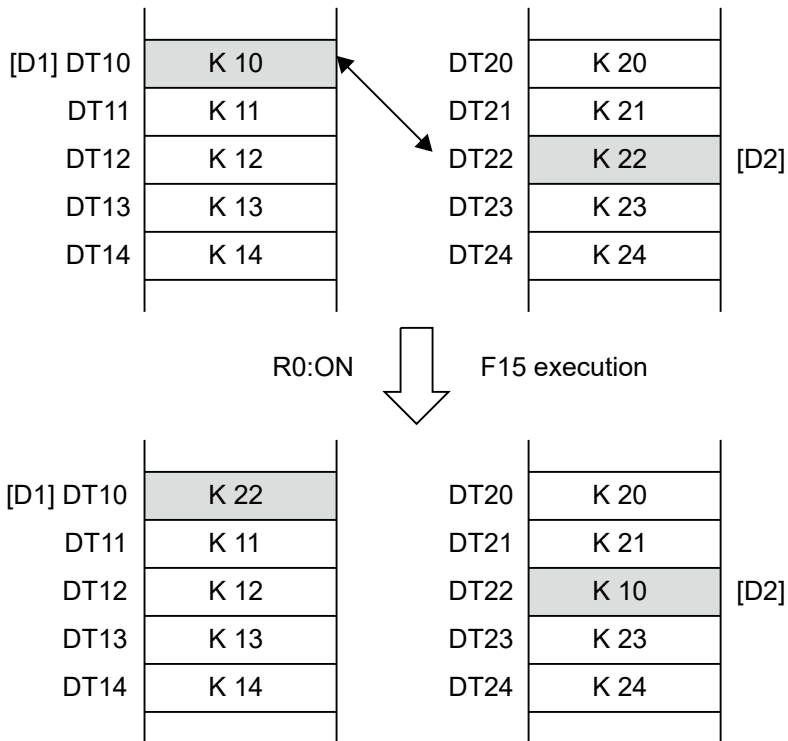

■ Flag operations

Name	Description
R9007 R9008 (ER)	Turns ON when the area is exceeded in index modification.

10.15 F16 DXCH (32-bit Data Exchange)

Exchanges the 32-bit data of two areas.

■ Instruction format

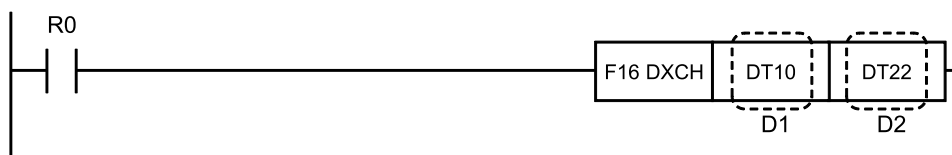

■ Operands

Items	Settings
D1	Area storing the 32-bit data to be exchanged with D2
D2	Area storing the 32-bit data to be exchanged with D1

■ Devices that can be specified (indicated by ●)

Operands	WX	WY	WR	WL	SV	EV	DT	LD	I	SWR	SDT	Constant				Index modifier	Integer Device
												K	H	M	f		
D1		●	●	●	●	●	●	●	●							●	
D2		●	●	●	●	●	●	●	●							●	

■ Outline of operation

The first two words of the content (32-bit) at the start of the area specified by [D1] are exchanged with the first two words of the content (32-bit) at the start of the area specified by [D2].

■ Operation example

Operation of instruction format description program

When internal relay R0 turns ON, the data in data registers DT10 and DT11 is exchanged with the data in data registers DT22 and DT23.

10.15 F16 DXCH (32-bit Data Exchange)

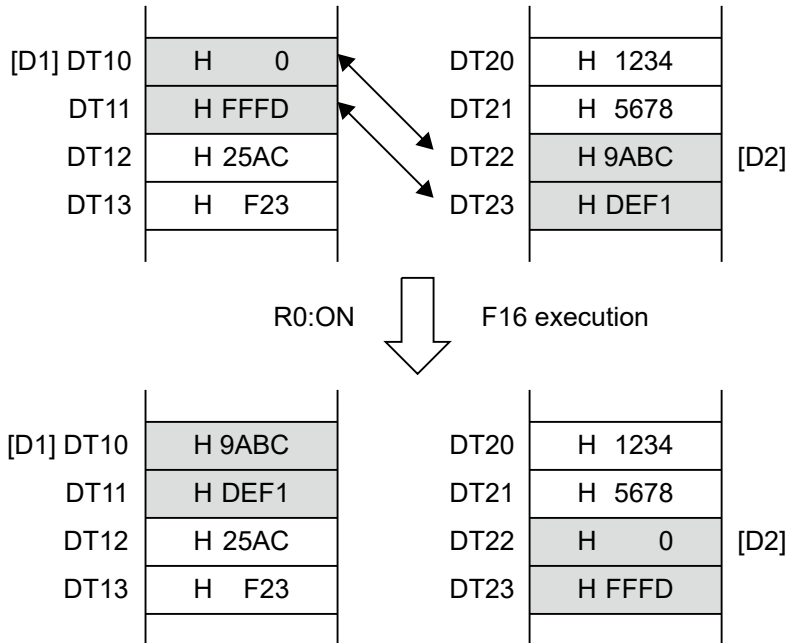

■ Flag operations

Name	Description
R9007 R9008 (ER)	Turns ON when the area is exceeded in index modification.

10.16 F17 SWAP (Higher/Lower Byte Exchange)

Exchanges higher (8-bit) and lower (8-bit) order bytes in 16-bit data.

■ Instruction format

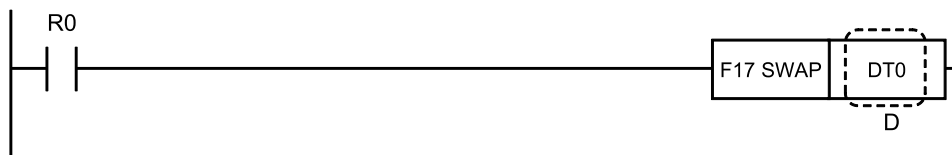

■ Operands

Items	Settings
D	Area storing 16-bit data for higher 8-bit and lower 8-bit exchange

■ Devices that can be specified (indicated by ●)

Operands	WX	WY	WR	WL	SV	EV	DT	LD	I	SWR	SDT	Constant				Index modifier	Integer Device
												K	H	M	f		
D		●	●	●	●	●	●	●	●							●	

■ Outline of operation

Exchanges the higher and lower order bytes of the 16-bit data stored in the area specified by [D].

■ Operation example

Operation of instruction format description program

The higher and lower bytes stored in data register DT0 are exchanged when internal relay R0 turns ON.

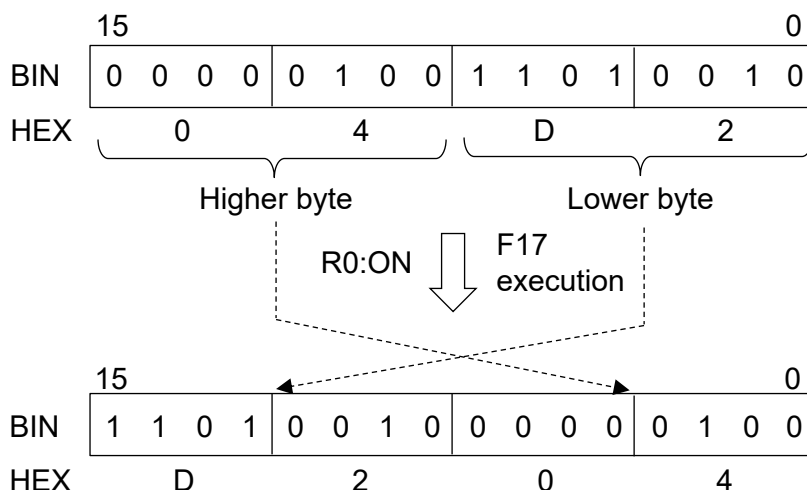

10.16 F17 SWAP (Higher/Lower Byte Exchange)

■ Flag operations

Name	Description
R9007 R9008 (ER)	Turns ON when the area is exceeded in index modification.

10.17 F18 BXCH (Block Exchange)

Exchanges data in blocks.

■ Instruction format

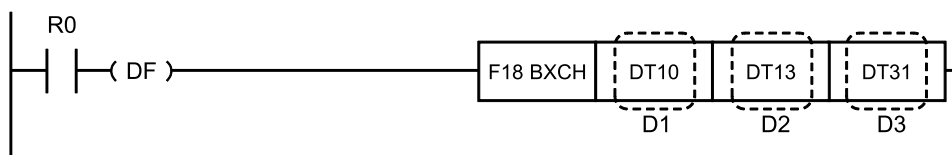

■ Operands

Items	Settings
D1	Starting address for exchange block 1
D2	Ending address for exchange block 1
D3	Starting address for exchange block 2

■ Devices that can be specified (indicated by ●)

Operands	WX	WY	WR	WL	SV	EV	DT	LD	I	SWR	SDT	Constant				Index modifier	Integer Device
												K	H	M	f		
D1		●	●	●	●	●	●	●	●							●	
D2		●	●	●	●	●	●	●	●							●	
D3		●	●	●	●	●	●	●	●							●	

■ Outline of operation

Exchanges the data from the area specified in [D1] to the area specified in [D2] with the data in the area starting at [D3].

■ Precautions for programming

- Specify the same type of memory address for [D1] and [D2].
- Specify the number of the lower address with [D1], and the number of the higher address with [D2].
If specified as [D1] > [D2], an operation error will occur when the instruction is executed.
- If the blocks to be exchanged overlap, they cannot be exchanged correctly. However, an error will not occur.

■ Operation example

Operation of instruction format description program

When the execution condition R0 is ON, data is exchanged between data registers DT10 to DT13 and DT31 to DT34.

10.17 F18 BXCH (Block Exchange)

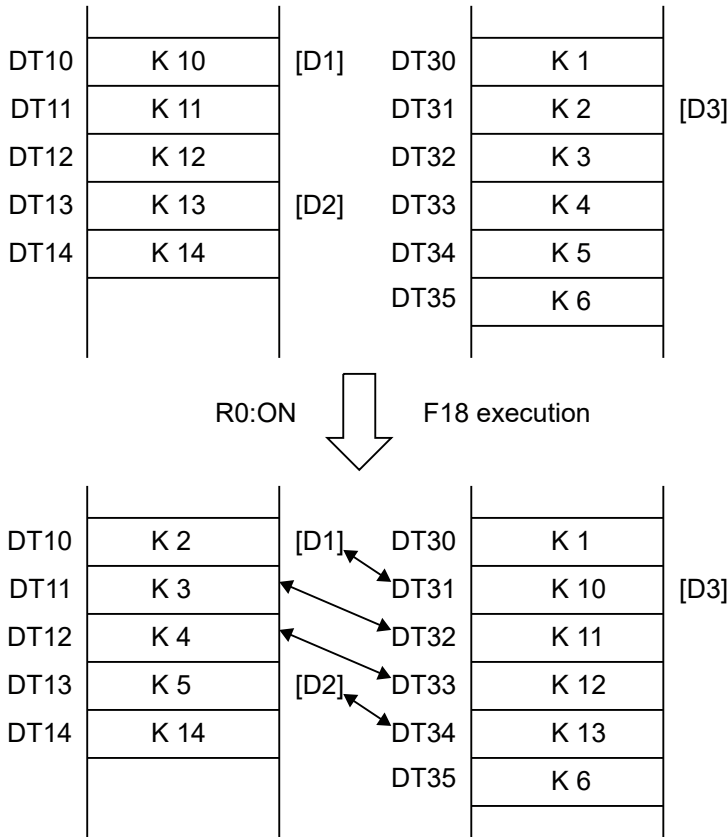

■ Flag operations

Name	Description
R9007	Turns ON when the area is exceeded in index modification.
R9008	Turns ON when [D1] > [D2]
(ER)	Turns ON when area is exceeded when exchanging blocks specified in [D3] or higher

10.18 F190 MV3 (Three 16-bit Data Transfer to Single Area)

Three 16-bit data items are batch-transferred from the specified area number.

■ Instruction format

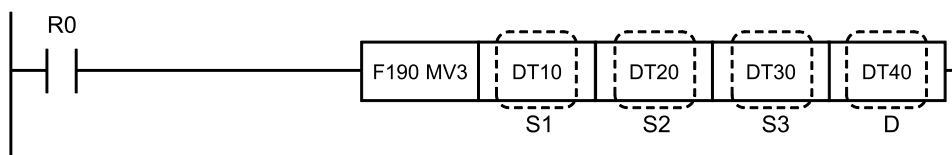

■ Operands

Items	Settings
S1	Area storing the hexadecimal data or constant data
S2	Area storing the hexadecimal data or constant data
S3	Area storing the hexadecimal data or constant data
D	Starting address of the data transfer destination area (three words)

■ Devices that can be specified (indicated by ●)

Operands	WX	WY	WR	WL	SV	EV	DT	LD	I	SWR	SDT	Constant				Index modifier	Integer Device
												K	H	M	f		
S1	●	●	●	●	●	●	●	●	●			●	●			●	
S2	●	●	●	●	●	●	●	●	●			●	●			●	
S3	●	●	●	●	●	●	●	●	●			●	●			●	
D		●	●	●	●	●	●	●	●							●	

■ Outline of operation

The three types of 16-bit data in the memory areas specified by [S1], [S2], and [S3] are batch-transferred to the memory area (three words) specified by [D].

■ Operation example

Operation of instruction format description program

When internal relay R0 turns ON, the content of data register DT10 is transferred to DT40, the content of DT20 is transferred to DT41, and the content of DT30 is transferred to DT42, in a batch.

10.18 F190 MV3 (Three 16-bit Data Transfer to Single Area)

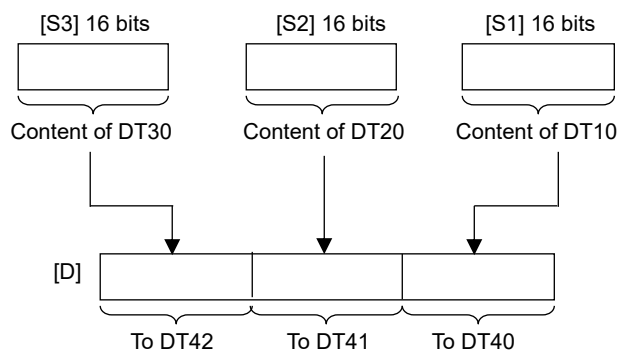

■ Related instructions

Use the F87 MV2 instruction when batch-transferring two types of 16-bit data.

■ Flag operations

Name	Description
R9007 R9008 (ER)	Turns ON when the area is exceeded in index modification.

10.19 F191 DMV3 (32-Bit 3-Data Batch Transfer)

Three 32-bit data items are batch-transferred from the specified area number.

■ Instruction format

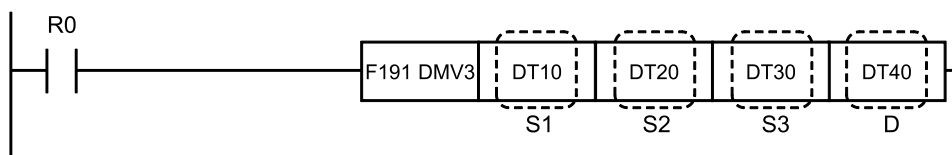

■ Operands

Items	Settings
S1	Area storing 32-bit data, or constant data
S2	Area storing 32-bit data, or constant data
S3	Area storing 32-bit data, or constant data
D	Starting address of the data transfer destination area (six words)

■ Devices that can be specified (indicated by ●)

Operands	WX	WY	WR	WL	SV	EV	DT	LD	I	SWR	SDT	Constant				Index modifier	Integer Device
												K	H	M	f		
S1	●	●	●	●	●	●	●	●	●			●	●			●	
S2	●	●	●	●	●	●	●	●	●			●	●			●	
S3	●	●	●	●	●	●	●	●	●			●	●			●	
D		●	●	●	●	●	●	●	●							●	

■ Outline of operation

The three types of 32-bit data in the memory areas specified by [S1], [S2], and [S3] are batch-transferred to the memory area (six words) specified by [D].

■ Operation example

Operation of instruction format description program

When internal relay R0 turns ON, the combined 32-bit content of data registers DT10 and DT11, data registers DT20 and DT21, and data registers DT30 and DT31 is batch-transferred to the 6-word area starting from data register DT40.

10.19 F191 DMV3 (32-Bit 3-Data Batch Transfer)

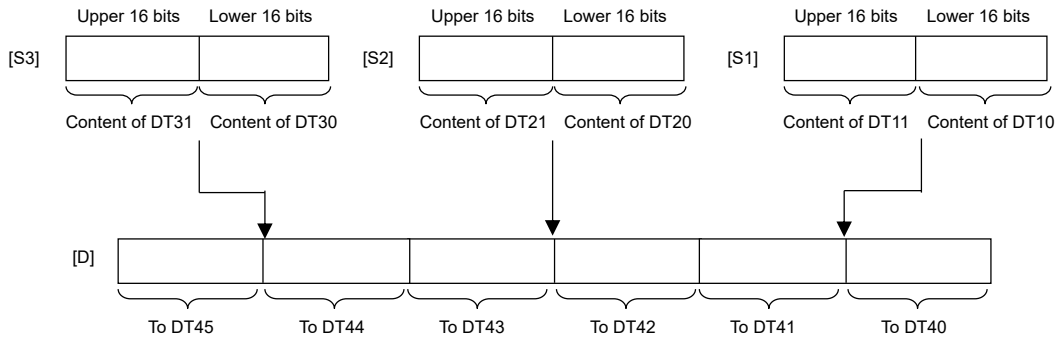

■ Related instructions

Use the F8 DMV2 instruction when batch-transferring two types of 32-bit data.

■ Flag operations

Name	Description
R9007 R9008 (ER)	Turns ON when the area is exceeded in index modification.

11 Binary Arithmetic Instructions

11.1	F20 + (16-bit Data Addition [D+S=D])	11-2
11.2	F21 D+ (32-bit Data Addition [D+S=D])	11-4
11.3	F22 + (16-bit Data Addition [S1+S2=D])	11-6
11.4	F23 D+ (32-bit Data Addition [S1+S2=D])	11-8
11.5	F25 - (16-bit Data Subtraction [D-S=D])	11-10
11.6	F26 D-(32-bit Data Subtraction [D-S=D])	11-13
11.7	F27 - (16-bit Data Subtraction [S1-S2=D])	11-15
11.8	F28 D- (32-bit Data Subtraction [S1-S2=D])	11-18
11.9	F30 * (16-bit Data Multiplication [S1*S2=D+1, D])	11-20
11.10	F31 D* (32-bit Data Multiplication [S1*S2=D+3, D+2, D+1, D])	11-22
11.11	F32 % (16-bit Data Subtraction [S1/S2=D])	11-24
11.12	F33 D% (32-bit Data Subtraction [S1/S2=D+1, D])	11-26
11.13	F34 *W (16-bit Data Multiplication [S1*S2=D])	11-28
11.14	F35 +1 (16-bit Data Increment)	11-30
11.15	F36 D+1 (32-bit Data Increment)	11-32
11.16	F37 -1 (16-bit Data Decrement)	11-34
11.17	F38 D-1 (32-bit Data Decrement)	11-36
11.18	F39 D*D (32-bit Data Multiplication [S1*S2=D+1, D])	11-38

11.1 F20 + (16-bit Data Addition [D+S=D])

11.1 F20 + (16-bit Data Addition [D+S=D])

16-bit data is added.

■ Instruction format

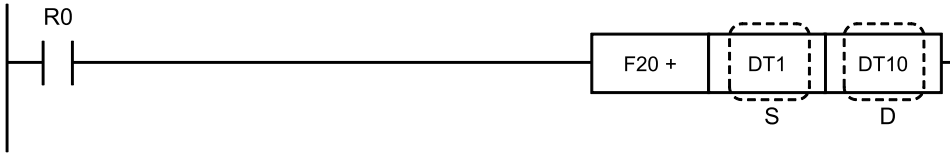

■ Operands

Items	Settings
S	Area storing the 16-bit data to be added, or constant data
D	Area storing the data (16-bit) to be added

■ Devices that can be specified (indicated by ●)

Operand s	WX	WY	WR	WL	SV	EV	DT	LD	I	SW R	SD T	Constant				Index modifier	Integer Device
												K	H	M	f		
S	●	●	●	●	●	●	●	●	●	●	●	●	●	●	●	●	
D		●	●	●	●	●	●	●	●						●		

■ Outline of operation

- The 16-bit data specified in [S] is added to the 16-bit data representing the decimal specified in [D].
 $(D) + (S) \rightarrow (D)$

■ Operation example

Operation of instruction format description program

When internal relay R0 turns ON, the content of data register DT10 is added to the content of data register DT1. When the decimal number 4 is in DT1, and 8 is in DT10, it will be as follows.

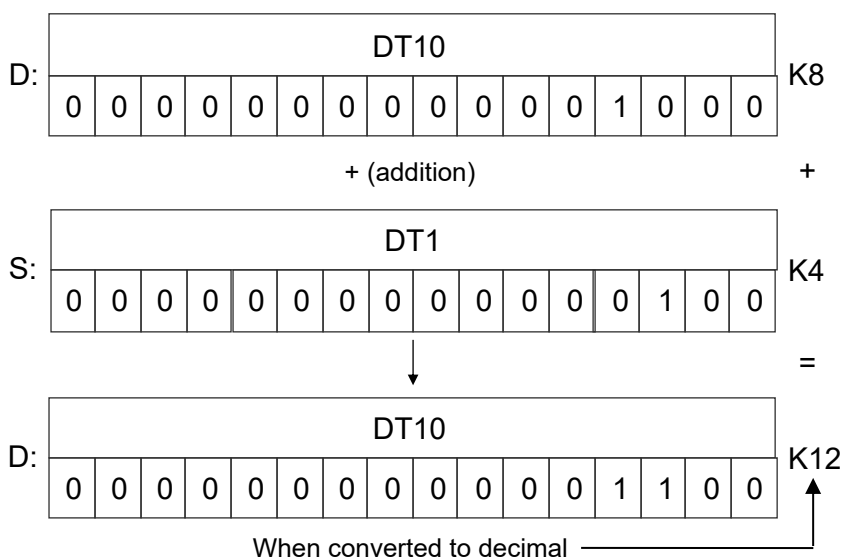

■ Precautions for programming

- With arithmetic operation instructions, in the event that the operation result falls beyond the range of values that can be handled, either an overflow or underflow occurs.
- Under normal circumstances, do not allow an overflow or underflow to occur.
- If an overflow or underflow occurs, use the 32-bit operation instruction.
- Use the F89 EXT sign extension instruction to convert the 16-bit data into 32-bit data.
- If an overflow or underflow occurs, the CY flag (special internal relay R9009) turns ON.

■ Flag operations

Name	Description
R9007 R9008 (ER)	Turns ON when the area is exceeded in index modification.
R900B (=)	Turns ON when the calculation result is "0"
R9009 (CY)	Turns ON when operation result overflows/underflows

11.2 F21 D+ (32-bit Data Addition [D+S=D])

11.2 F21 D+ (32-bit Data Addition [D+S=D])

32-bit data is added.

■ Instruction format

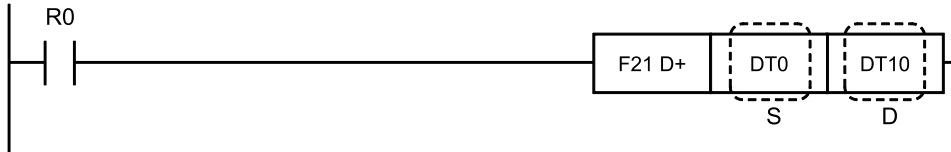

■ Operands

Items	Settings
S	Area storing the 32-bit data to be added, or constant data
D	Area storing the data (32-bit) to be added

■ Devices that can be specified (indicated by ●)

Operand s	WX	WY	WR	WL	SV	EV	DT	LD	I	SW R	SD T	Constant				Index modifier	Integer Device
												K	H	M	f		
S	●	●	●	●	●	●	●	●	●	●	●	●	●		●		
D		●	●	●	●	●	●	●	●						●		

■ Outline of operation

- The 32-bit data specified in [S] is added to the 32-bit data representing the decimal specified in [D].
 $(D+1, D) + (S+1, S) \rightarrow (D+1, D)$

■ Operation example

Operation of instruction format description program

When the internal relay R0 is ON, the content (32-bit) of data registers DT10 to DT11 is added to the content (32-bit) of data registers DT0 to DT1.

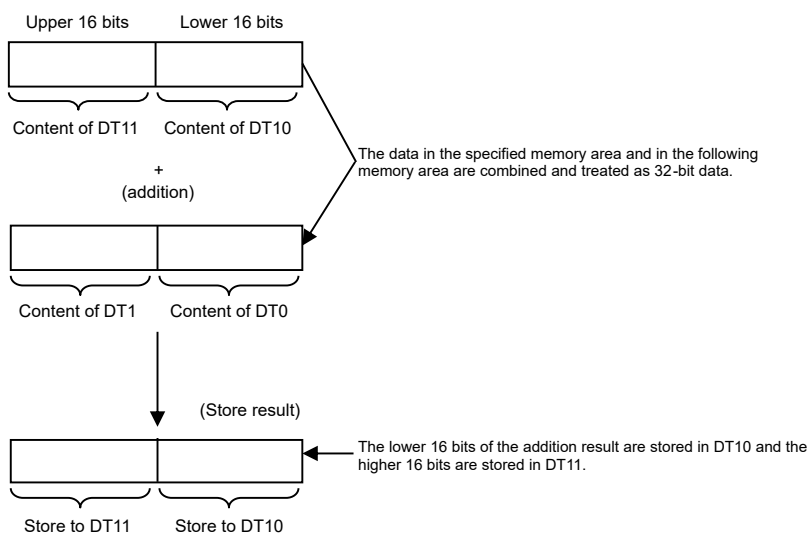

■ Precautions for programming

- With arithmetic operation instructions, in the event that the operation result falls beyond the range of values that can be handled, either an overflow or underflow occurs.
- Ensure that overflows and underflows do not occur in normal circumstances.
- If an overflow or underflow occurs, the CY flag (special internal relay R9009) turns ON.

■ Flag operations

Name	Description
R9007 R9008 (ER)	Turns ON when the area is exceeded in index modification.
R900B (=)	Turns ON when the calculation result is "0"
R9009 (CY)	Turns ON when operation result overflows/underflows

11.3 F22 + (16-bit Data Addition [S1+S2=D])

11.3 F22 + (16-bit Data Addition [S1+S2=D])

This is an instruction that adds 16-bit data.

■ Instruction format

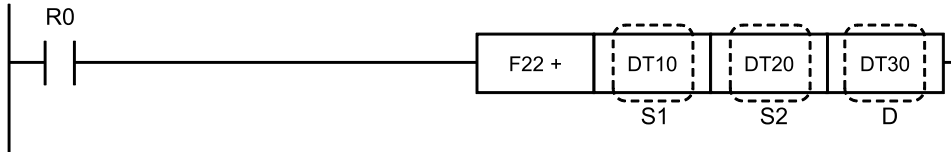

■ Operands

Items	Settings
S1	Area storing the 16-bit data to be added, or constant data
S2	Area storing the 16-bit data to be added, or constant data
D	Area storing the addition results

■ Devices that can be specified (indicated by ●)

Operands	WX	WY	WR	WL	SV	EV	DT	LD	I	SWR	SDT	Constant				Index modifier	Integer Device
												K	H	M	f		
S1	●	●	●	●	●	●	●	●	●	●	●	●	●	●	●	●	
S2	●	●	●	●	●	●	●	●	●	●	●	●	●	●	●	●	
D		●	●	●	●	●	●	●	●							●	

■ Outline of operation

- The 16-bit data expressing a decimal number specified by [S1] and [S2] is added, and the result is stored in [D].
(S1) + (S2) → (D)

■ Operation example

Operation of instruction format description program

When internal relay R0 turns ON, the contents of data register DT10 and data register DT20 are added together, and the result is stored in data register DT30. If DT10 contains decimal 8 and DT20 contains decimal 4, the result is as follows.

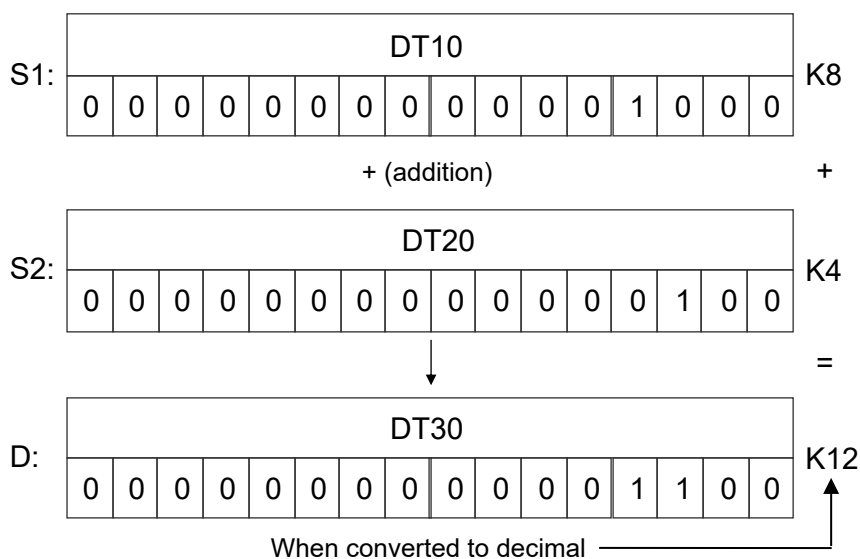

■ Precautions for programming

- With arithmetic operation instructions, in the event that the operation result falls beyond the range of values that can be handled, either an overflow or underflow occurs.
- Under normal circumstances, do not allow an overflow or underflow to occur.
- If an overflow or underflow occurs, use the 32-bit operation instruction.
- Use the F89 EXT sign extension instruction to convert the 16-bit data into 32-bit data.
- If an overflow or underflow occurs, the CY flag (special internal relay R9009) turns ON.

■ Flag operations

Name	Description
R9007 R9008 (ER)	Turns ON when the area is exceeded in index modification.
R900B (=)	Turns ON when the calculation result is "0"
R9009 (CY)	Turns ON when operation result overflows/underflows

11.4 F23 D+ (32-bit Data Addition [S1+S2=D])

11.4 F23 D+ (32-bit Data Addition [S1+S2=D])

This is an instruction that adds 32-bit data.

■ Instruction format

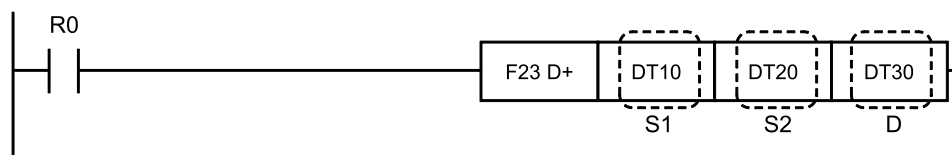

■ Operands

Items	Settings
S1	Area storing the 32-bit data to be added, or constant data
S2	Area storing the 32-bit data to be added, or constant data
D	Area storing the addition results

■ Devices that can be specified (indicated by ●)

Operands	WX	WY	WR	WL	SV	EV	DT	LD	I	SW R	SD T	Constant				Index modifier	Integer Device
												K	H	M	f		
S1	●	●	●	●	●	●	●	●	●	●	●	●	●	●	●	●	
S2	●	●	●	●	●	●	●	●	●	●	●	●	●	●	●	●	
D		●	●	●	●	●	●	●	●							●	

■ Outline of operation

- The 32-bit data expressing a decimal number specified by [S1] and [S2] is added, and the result is stored in [D].
 $(S1+1, S1) + (S2+1, S2) \rightarrow (D+1, D)$
- The memory area is specified by the memory area number of the lower 16-bit portion.

■ Operation example

Operation of instruction format description program

When internal relay R0 turns ON, the contents of data registers DT10 and DT11 are added to the contents of data registers DT20 and DT21, and the result is stored in data registers DT30 and DT31.

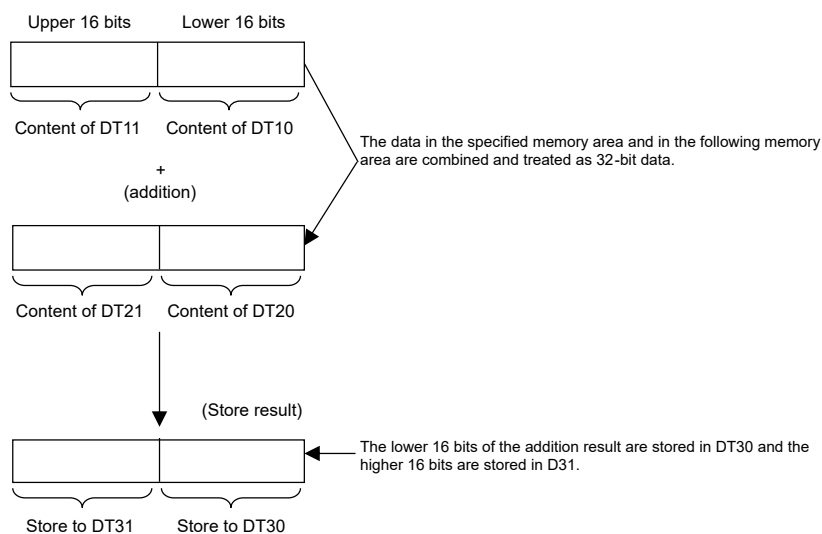

■ Precautions for programming

- With arithmetic operation instructions, in the event that the operation result falls beyond the range of values that can be handled, either an overflow or underflow occurs.
- Ensure that overflows and underflows do not occur in normal circumstances.
- If an overflow or underflow occurs, the CY flag (special internal relay R9009) turns ON.

■ Flag operations

Name	Description
R9007 R9008 (ER)	Turns ON when the area is exceeded in index modification.
R900B (=)	Turns ON when the calculation result is "0"
R9009 (CY)	Turns ON when operation result overflows/underflows

11.5 F25 - (16-bit Data Subtraction [D-S=D])

11.5 F25 - (16-bit Data Subtraction [D-S=D])

16-bit data is subtracted.

■ Instruction format

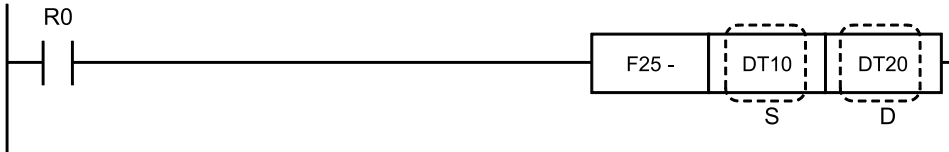

■ Operands

Items	Settings
S	Area storing the subtrahend (16-bit data), or constant data
D	Area storing the subtrahend from (16-bit data)

■ Devices that can be specified (indicated by ●)

Operand s	WX	WY	WR	WL	SV	EV	DT	LD	I	SW R	SD T	Constant				Index modifier	Integer Device
												K	H	M	f		
S	●	●	●	●	●	●	●	●	●	●	●	●	●		●		
D		●	●	●	●	●	●	●	●						●		

■ Outline of operation

- The 16-bit data specified by [S] is subtracted from the 16-bit decimal data specified by [D].
(D) - (S) -> (D)

■ Operation example

Operation of instruction format description program

Subtracts the contents of data register DT10 from the contents of data register DT20 when internal relay R0 turns ON.

Specific Example 1) When the decimal number 16 is in DT20 and the decimal number 4 is in DT10

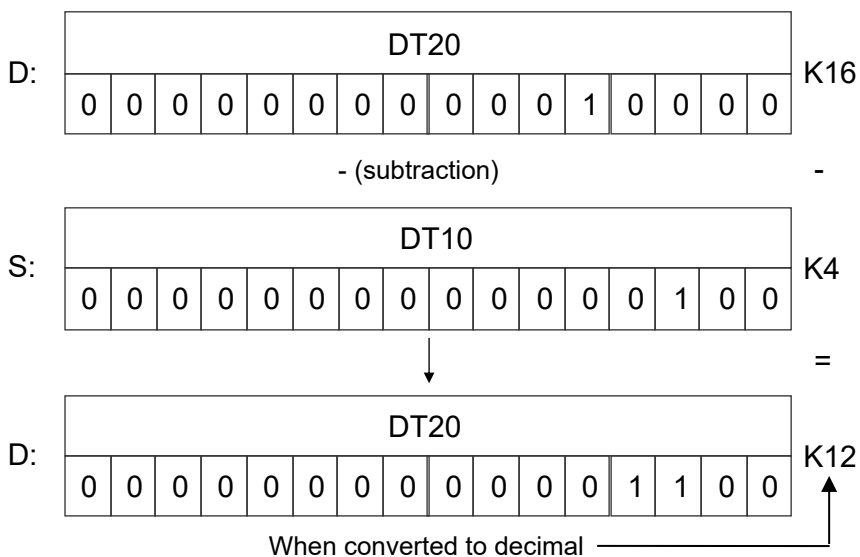

Specific Example 2) When the decimal number 3 is in DT20 and the decimal number 5 is in DT10

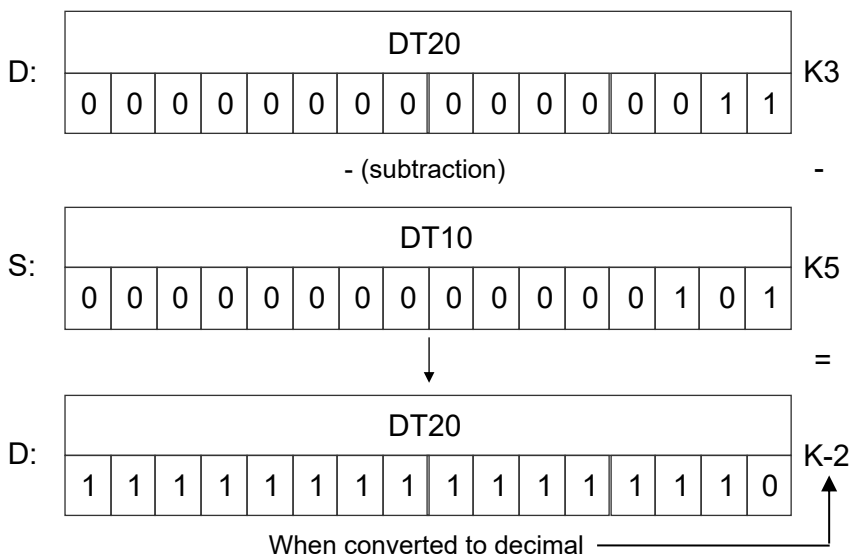

■ Precautions for programming

- With arithmetic operation instructions, in the event that the operation result falls beyond the range of values that can be handled, either an overflow or underflow occurs.
- Under normal circumstances, do not allow an overflow or underflow to occur.
- If an overflow or underflow occurs, use the 32-bit operation instruction.
- Use the F89 EXT sign extension instruction to convert the 16-bit data into 32-bit data.
- If an overflow or underflow occurs, the CY flag (special internal relay R9009) turns ON.

11.5 F25 - (16-bit Data Subtraction [D-S=D])

■ Flag operations

Name	Description
R9007 R9008 (ER)	Turns ON when the area is exceeded in index modification.
R900B (=)	Turns ON when the calculation result is"0"
R9009 (CY)	Turns ON when operation result overflows/underflows

11.6 F26 D-(32-bit Data Subtraction [D-S=D])

Subtracts 32-bit data.

■ Instruction format

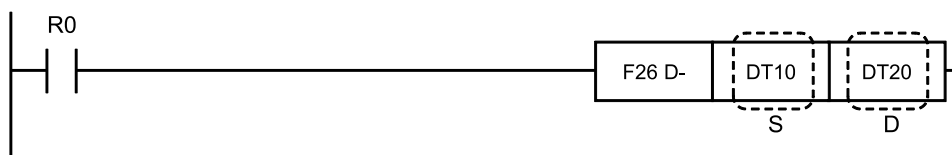

■ Operands

Items	Settings
S	Area that stores subtrahends (32-bit data), or constant data
D	Area storing the number to be subtracted (32-bit data)

■ Devices that can be specified (indicated by ●)

Operand s	WX	WY	WR	WL	SV	EV	DT	LD	I	SW R	SD T	Constant				Index modifier	Integer Device
												K	H	M	f		
S	●	●	●	●	●	●	●	●	●	●	●	●	●	●	●	●	
D		●	●	●	●	●	●	●	●							●	

■ Outline of operation

- The 32-bit data specified by [S] is subtracted from the 32-bit data expressing a decimal number specified by [D].
 $(D+1, D) - (S+1, S) \rightarrow (D+1, D)$

■ Operation example

Operation of instruction format description program

When internal relay R0 turns ON, the content of data registers DT10 and DT11 (32 bits) is subtracted from the content of data registers DT20 and DT21(32 bits).

11.6 F26 D-(32-bit Data Subtraction [D-S=D])

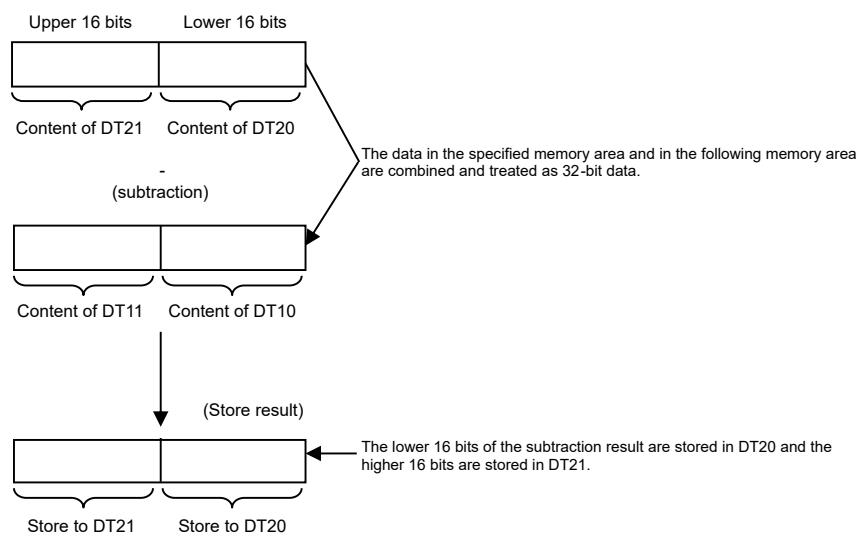

■ Precautions for programming

- With arithmetic operation instructions, in the event that the operation result falls beyond the range of values that can be handled, either an overflow or underflow occurs.
- Ensure that overflows and underflows do not occur in normal circumstances.
- If an overflow or underflow occurs, the CY flag (special internal relay R9009) turns ON.

■ Flag operations

Name	Description
R9007 R9008 (ER)	Turns ON when the area is exceeded in index modification.
R900B (=)	Turns ON when the calculation result is "0"
R9009 (CY)	Turns ON when operation result overflows/underflows

11.7 F27 - (16-bit Data Subtraction [S1-S2=D])

16-bit data is subtracted.

■ Instruction format

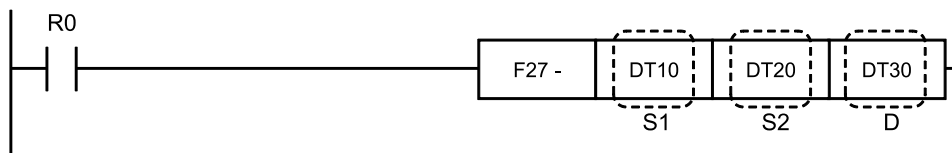

■ Operands

Items	Settings
S1	Area storing the number to be subtracted (16-bit data), or constant data
S2	Area storing the subtrahend (16-bit data), or constant data
D	Area that stores operation results

■ Devices that can be specified (indicated by ●)

Operands	WX	WY	WR	WL	SV	EV	DT	LD	I	SW R	SD T	Constant				Index modifier	Integer Device
												K	H	M	f		
S1	●	●	●	●	●	●	●	●	●	●	●	●	●	●	●	●	
S2	●	●	●	●	●	●	●	●	●	●	●	●	●	●	●	●	
D		●	●	●	●	●	●	●	●							●	

■ Outline of operation

- The 16-bit data specified in [S2] is subtracted from the 16-bit data representing the decimal of the memory area specified in [S1], and the result is stored in [D].
(S1) - (S2) → (D)

■ Operation example

Operation of instruction format description program

When the internal relay R0 is ON, the content of data register DT20 is subtracted from the content of data register D10, and the operation result is stored in data register DT30.

Example 1) If the decimal 16 is in DT10, and 4 is in DT20

11.7 F27 - (16-bit Data Subtraction [S1-S2=D])

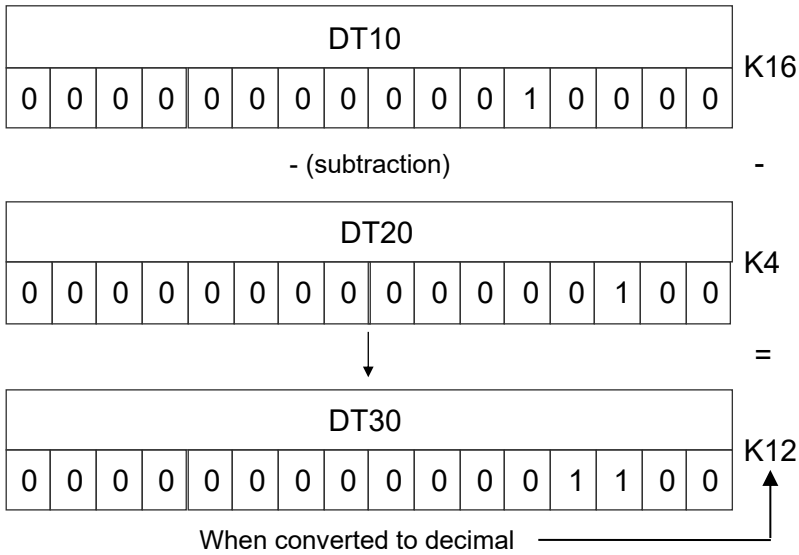

Example 2) If the decimal 3 is in DT10, and 5 is in DT20

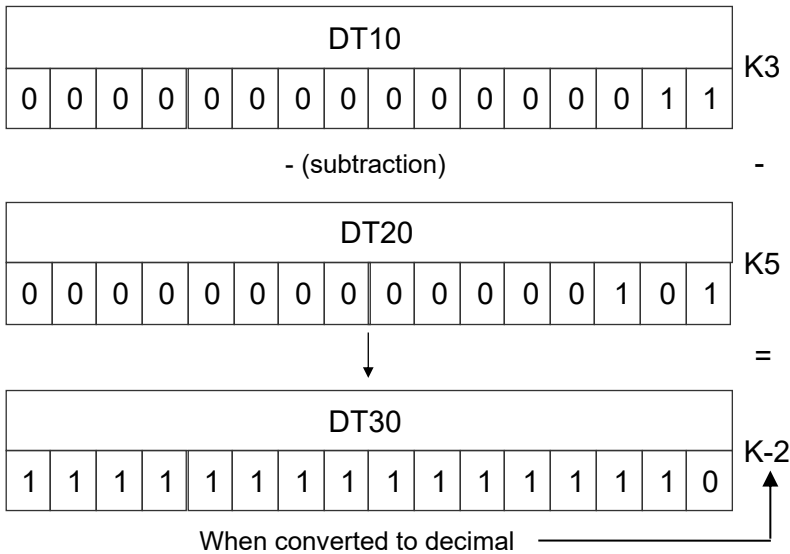

■ Precautions for programming

- With arithmetic operation instructions, in the event that the operation result falls beyond the range of values that can be handled, either an overflow or underflow occurs.
- Under normal circumstances, do not allow an overflow or underflow to occur.
- If an overflow or underflow occurs, use the 32-bit operation instruction.
- Use the F89 EXT sign extension instruction to convert the 16-bit data into 32-bit data.
- If an overflow or underflow occurs, the CY flag (special internal relay R9009) turns ON.

■ Flag operations

Name	Description
R9007 R9008 (ER)	Turns ON when the area is exceeded in index modification.
R900B (=)	Turns ON when the calculation result is "0"
R9009 (CY)	Turns ON when operation result overflows/underflows

11.8 F28 D- (32-bit Data Subtraction [S1-S2=D])

11.8 F28 D- (32-bit Data Subtraction [S1-S2=D])

Subtracts 32-bit data.

■ Instruction format

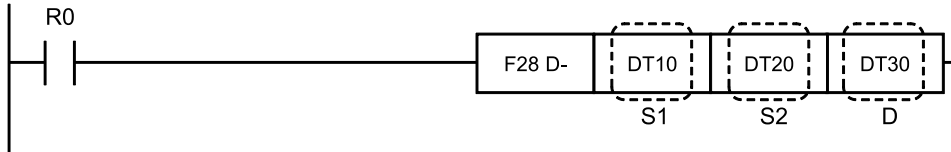

■ Operands

Items	Settings
S1	Area that stores minuends (32-bit data), or constant data
S2	Area that stores subtrahends (32-bit data), or constant data
D	Area that stores operation results

■ Devices that can be specified (indicated by ●)

Operands	WX	WY	WR	WL	SV	EV	DT	LD	I	SWR	SDT	Constant				Index modifier	Integer Device
												K	H	M	f		
S1	●	●	●	●	●	●	●	●	●	●	●	●	●	●	●	●	
S2	●	●	●	●	●	●	●	●	●	●	●	●	●	●	●	●	
D		●	●	●	●	●	●	●	●							●	

■ Outline of operation

- 32-bit data specified in [S2] is subtracted from the 32-bit data, representing a decimal, of the memory area specified in [S1], and the result is stored in [D].
 $(S1+1, S1) - (S2+1, S2) \rightarrow (D+1, D)$
- The memory area is specified by the memory area number of the lower 16-bit portion.

■ Operation example

Operation of instruction format description program

When the internal relay R0 is ON, the content of data registers DT20 to DT21 is subtracted from the content of DT10 to DT11, and the operation result is stored in DT30 to DT31.

11.8 F28 D- (32-bit Data Subtraction [S1-S2=D])

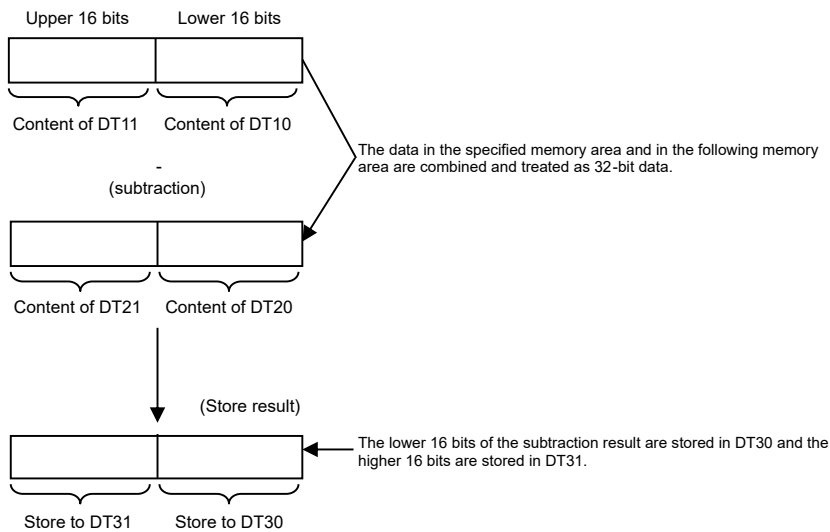

■ Precautions for programming

- With arithmetic operation instructions, in the event that the operation result falls beyond the range of values that can be handled, either an overflow or underflow occurs.
- Ensure that overflows and underflows do not occur in normal circumstances.
- If an overflow or underflow occurs, the CY flag (special internal relay R9009) turns ON.

■ Flag operations

Name	Description
R9007 R9008 (ER)	Turns ON when the area is exceeded in index modification.
R900B (=)	Turns ON when the calculation result is "0"
R9009 (CY)	Turns ON when operation result overflows/underflows

11.9 F30 * (16-bit Data Multiplication [S1*S2=D+1, D])

11.9 F30 * (16-bit Data Multiplication [S1*S2=D+1, D])

Multiplies hexadecimal data.

■ Instruction format

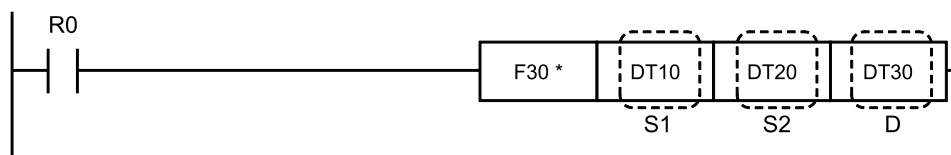

■ Operands

Items	Settings
S1	Area storing the hexadecimal data or constant data
S2	Area storing the hexadecimal data or constant data
D	Area storing the multiplication results (32-bit data)

■ Devices that can be specified (indicated by ●)

Operands	WX	WY	WR	WL	SV	EV	DT	LD	I	SW R	SD T	Constant				Index modifier	Integer Device
												K	H	M	f		
S1	●	●	●	●	●	●	●	●	●	●	●	●	●	●	●	●	
S2	●	●	●	●	●	●	●	●	●	●	●	●	●	●	●	●	
D		●	●	●	●	●	●	●	●							●	

■ Outline of operation

- Multiplies the hexadecimal data expressed in decimal form that is specified by [S1] with the hexadecimal data specified by [S2], and stores the result in the area specified by [D].
(S1) × (S2) → (D+1, D)
- The calculation result is stored using 32-bit data (K constant).
- Storage destination [D] is specified by the number of the memory area with the lower order 16 bits.

■ Operation example

Operation of instruction format description program

The contents of data registers DT10 and DT20 are multiplied and stored in data registers DT30 and DT31 when internal relay R0 turns ON. When 8 is in the decimal number in DT10 (K constant) and 2 is in the decimal number 4 in DT20.

11.9 F30 * (16-bit Data Multiplication [S1*S2=D+1, D])

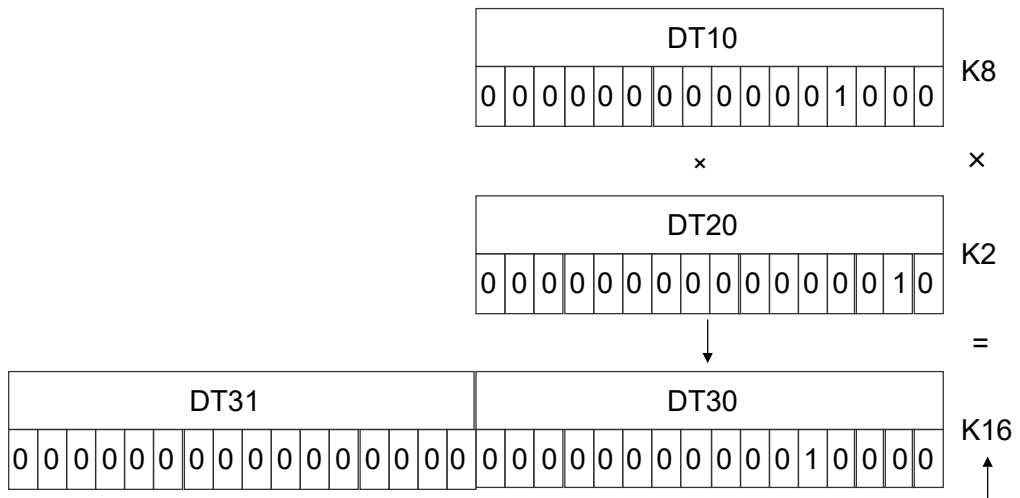

Of the 32-bit data multiplication results, the lower order 16 bits are stored in the specified memory area (DT30) and the higher order 16 bits is stored in the next area after the specified area (DT31).

■ Flag operations

Name	Description
R9007 R9008 (ER)	Turns ON when the area is exceeded in index modification.
R900B (=)	Turns ON when the calculation result is "0"

11.10 F31 D* (32-bit Data Multiplication [S1*S2=D+3, D+2, D+1, D])

11.10 F31 D* (32-bit Data Multiplication [S1*S2=D+3, D+2, D+1, D])

Multiplies 32-bit data items.

■ Instruction format

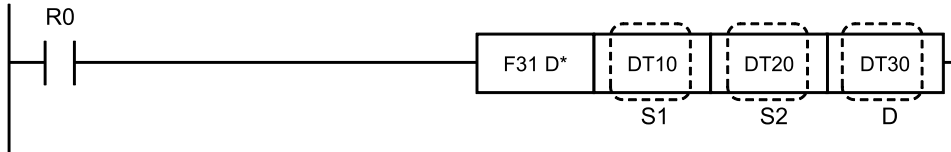

■ Operands

Items	Settings
S1	Multiplicand data: Area storing 32-bit data, or constant data
S2	Multiplier data: Area storing 32-bit data, or constant data
D	Storage destination: Area storing multiplication result (64-bit data)

■ Devices that can be specified (indicated by ●)

Operands	WX	WY	WR	WL	SV	EV	DT	LD	I	SWR	SDT	Constant				Index modifier	Integer Device
												K	H	M	f		
S1	●	●	●	●	●	●	●	●	●	●	●	●			●		
S2	●	●	●	●	●	●	●	●	●	●	●	●			●		
D		●	●	●	●	●	●	●							●		

■ Outline of operation

- Multiplies the 32-bit data representing decimal data specified by [S1] and the 32-bit data specified by [S2], and stores the result in the area specified by [D].
 $(S1+1, S1) \times (S2+1, S2) \rightarrow (D+3, D+2, D+1, D)$
- The calculation result is stored in the 64-bit area.
- The memory area is specified by the number of the lowest 16-bit memory area.

■ Operation example

Operation of instruction format description program

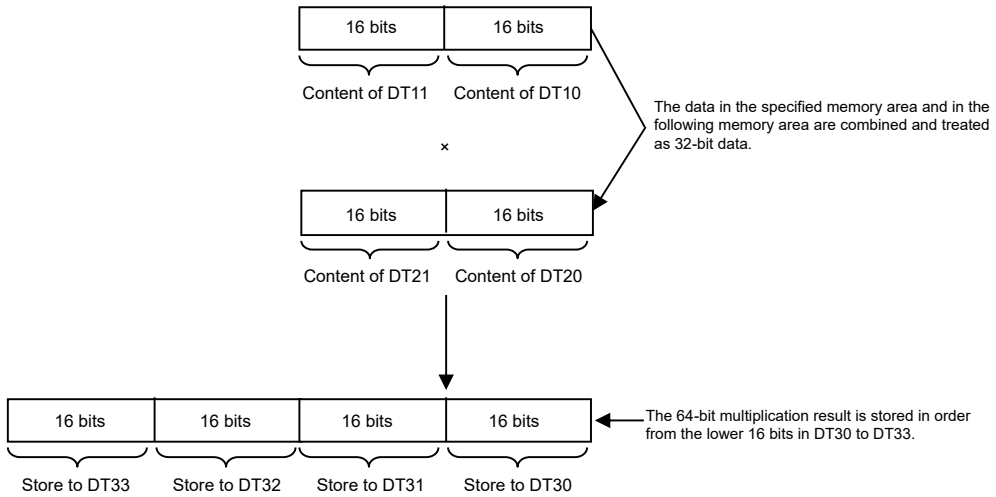

■ Flag operations

Name	Description
R9007 R9008 (ER)	Turns ON when the area is exceeded in index modification.
R900B (=)	Turns ON when the calculation result is "0"

11.11 F32 % (16-bit Data Subtraction [S1/S2=D])

11.11 F32 % (16-bit Data Subtraction [S1/S2=D])

Divides 16-bit data.

■ Instruction format

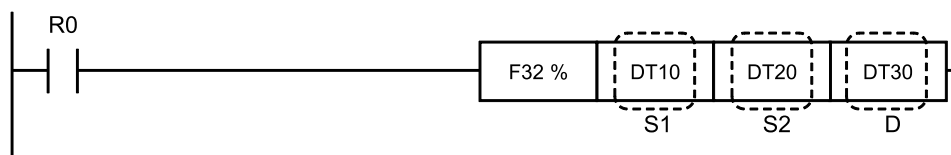

■ Operands

Items	Settings
S1	Dividend data: Area storing 16-bit data, or constant data
S2	Divisor data: Area storing 16-bit data, or constant data
D	Storage destination: Area storing the division result (quotient) (remainder stored as 16-bit data in DT90015)

■ Devices that can be specified (indicated by ●)

Operands	WX	WY	WR	WL	SV	EV	DT	LD	I	SWR	SDT	Constant				Index modifier	Integer Device
												K	H	M	f		
S1	●	●	●	●	●	●	●	●	●	●	●	●	●	●	●		
S2	●	●	●	●	●	●	●	●	●	●	●	●	●	●	●		
D		●	●	●	●	●	●	●	●						●		

■ Outline of operation

- The 16-bit data expressing a decimal specified by [S1] is divided by the 16-bit data specified by [S2]. The quotient is stored in [D], and the remainder is stored in special data register DT90015.

$(S1) \div (S2) \rightarrow \text{Quotient (D) Remainder (DT90015)}$

■ Operation example

Operation of instruction format description program

When internal relay R0 turns ON, data register DT10 is divided by data register DT20, and the quotient is stored in DT30 and the remainder in DT90015. If the content in DT10 is decimal number (K constant) 15 and the content in DT20 is 4, the result is as follows.

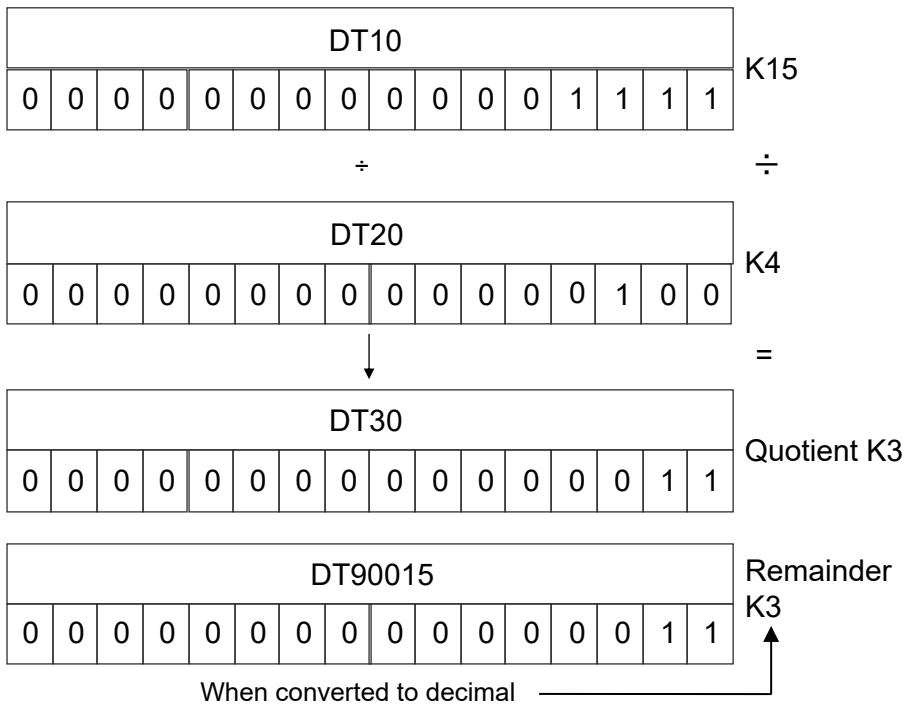

■ Flag operations

Name	Description
R9007	Turns ON when the area is exceeded in index modification.
R9008 (ER)	Turns ON when [S2] is "0"
R900B (=)	Turns ON when the calculation result is "0"
R9009 (CY)	Turns ON when the negative maximum value is divided by "-1"

11.12 F33 D% (32-bit Data Subtraction [S1/S2=D+1, D])

11.12 F33 D% (32-bit Data Subtraction [S1/S2=D+1, D])

Divides 32-bit data.

■ Instruction format

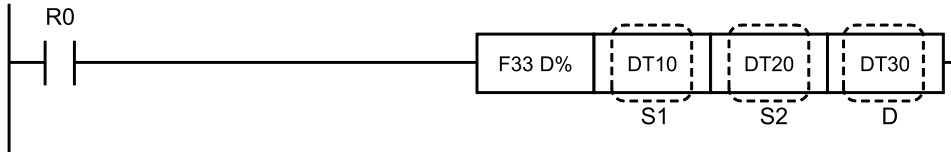

■ Operands

Items	Settings
S1	Dividend data: Area storing 32-bit data, or constant data
S2	Divisor data: Area storing 32-bit data, or constant data
D	Storage destination: Area storing the division result (quotient) (remainder stored as 32-bit data in DT90015 and DT90016)

■ Devices that can be specified (indicated by ●)

Operands	WX	WY	WR	WL	SV	EV	DT	LD	I	SWR	SDT	Constant				Index modifier	Integer Device
												K	H	M	f		
S1	●	●	●	●	●	●	●	●	●	●	●	●	●	●	●		
S2	●	●	●	●	●	●	●	●	●	●	●	●	●	●	●		
D		●	●	●	●	●	●	●	●						●		

■ Outline of operation

- The 32-bit data expressing a decimal specified by [S1] is divided by the 32-bit data specified by [S2]. The quotient is stored in [D], and the remainder is stored in special data registers DT90015 and DT90016.

$(S1 + 1, S1) \div (S2 + 1, S2) \rightarrow$ Quotient (D+1, D) Remainder (DT90016, DT90015)

- Memory area is specified by the memory area number of the lower order hexadecimal part.

■ Operation example

Operation of instruction format description program

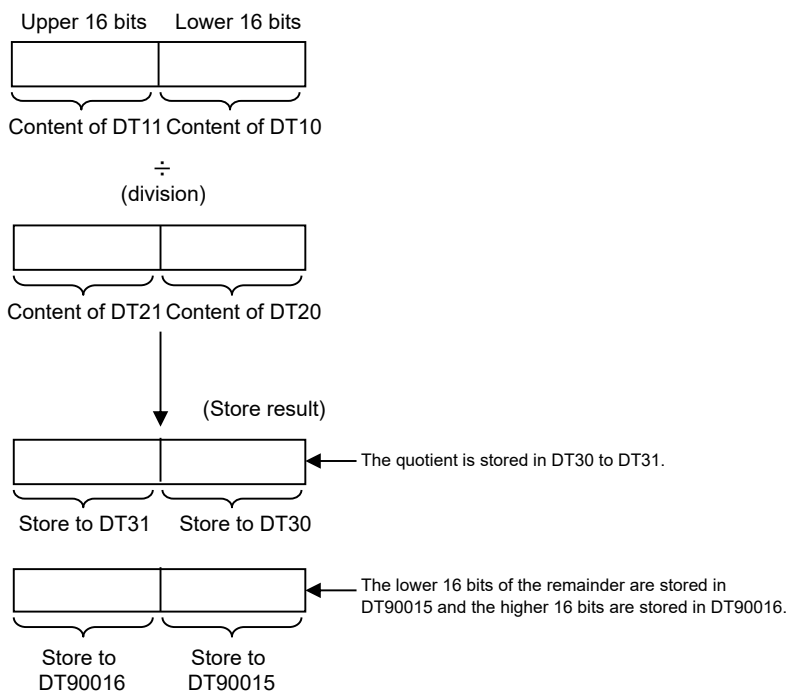

■ Flag operations

Name	Description
R9007	Turns ON when the area is exceeded in index modification.
R9008 (ER)	Turns ON when [S2] is "0"
R900B (=)	Turns ON when the calculation result is "0"
R9009 (CY)	Turns ON when the negative maximum value is divided by "-1"

11.13 F34 *W (16-bit Data Multiplication [S1*S2=D])

11.13 F34 *W (16-bit Data Multiplication [S1*S2=D])

Multiplies 16-bit data and stores the result in a 16-bit, one-word area.

■ Instruction format

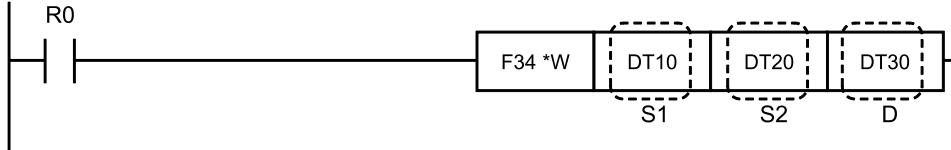

■ Operands

Items	Settings
S1	Area storing the hexadecimal data or constant data
S2	Area storing the hexadecimal data or constant data
D	Area storing multiplication result (16-bit data)

■ Devices that can be specified (indicated by ●)

Operands	WX	WY	WR	WL	SV	EV	DT	LD	I	SWR	SDT	Constant				Index modifier	Integer Device	
												K	H	M	f			
S1	●	●	●	●	●	●	●	●	●	●	●	●	●	●	●			●
S2	●	●	●	●	●	●	●	●	●	●	●	●	●	●	●			●
D		●	●	●	●	●	●	●	●									●

■ Outline of operation

- The 16-bit data specified by [S1] and the 16-bit data specified by [S2] are multiplied, and the result is stored in the area specified by [D].
(S1) x (S2) → (D)
- The operation result is stored as one word of 16-bit data.

■ Operation example

Operation of instruction format description program

When the DT10 content is decimal 8

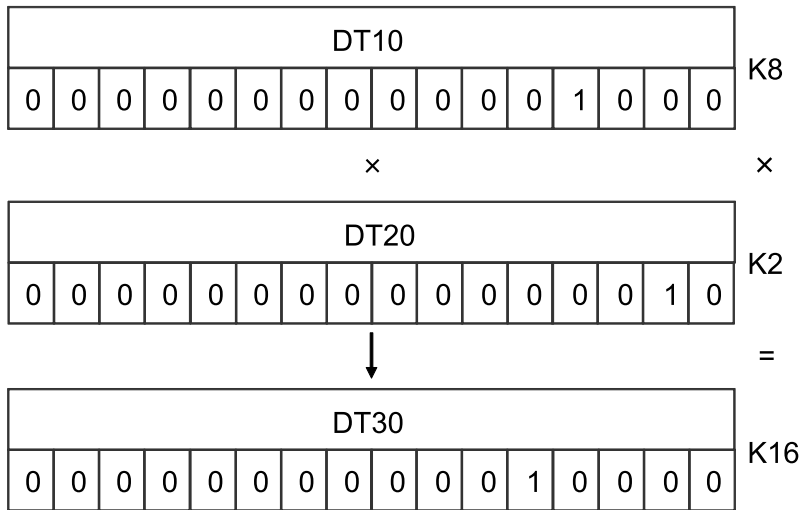

■ **Precautions for programming**

Keep the operation result [D] within the range of K-32768 to K32767.

■ **Flag operations**

Name	Description
R9007	Turns ON when the area is exceeded in index modification.
R9008 (ER)	Turns ON when the operation result exceeds 16 bits
R900B (=)	Turns ON when the calculation result is "0"

11.14 F35 +1 (16-bit Data Increment)

11.14 F35 +1 (16-bit Data Increment)

Adds 1 to 16-bit data.

■ Instruction format

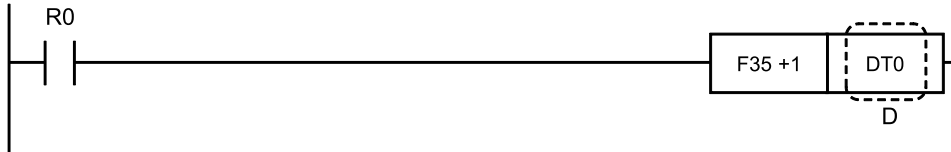

■ Operands

Items	Settings
D	Area to which 1 is to be added

■ Devices that can be specified (indicated by ●)

Operands	WX	WY	WR	WL	SV	EV	DT	LD	I	SWR	SDT	Constant				Index modifier	Integer Device
												K	H	M	f		
D		●	●	●	●	●	●	●	●							●	

■ Outline of operation

- 1 is added to the 16-bit data that expresses the decimal number specified by [D] and the result is stored in [D].
 $(D) + 1 \rightarrow (D)$

■ Operation example

Operation of instruction format description program

When internal relay R0 turns ON, 1 is added to the contents of data register DT0.

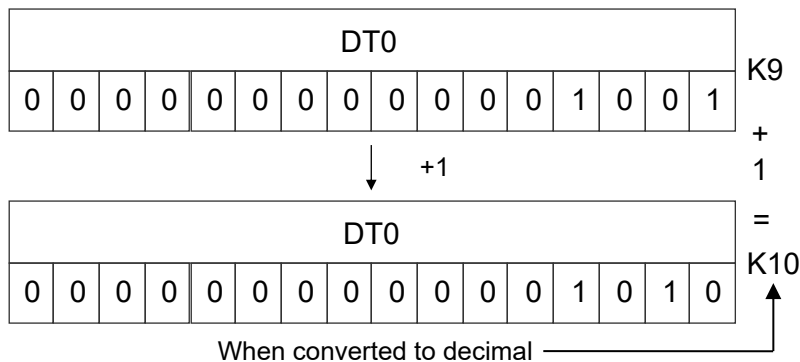

■ Precautions for programming

- With arithmetic operation instructions, in the event that the operation result falls beyond the range of values that can be handled, an overflow occurs.

- Ensure that overflows do not occur in normal circumstances.
- If an overflow occurs, use a 32-bit operation instruction.
- If an overflow occurs, the CY flag (special internal relay R9009) turns ON.

■ Flag operations

Name	Description
R9007 R9008 (ER)	Turns ON when the area is exceeded in index modification.
R900B (=)	Turns ON when the calculation result is "0"
R9009 (CY)	Turns ON when operation result overflows

11.15 F36 D+1 (32-bit Data Increment)

11.15 F36 D+1 (32-bit Data Increment)

Adds 1 to 32-bit data.

■ Instruction format

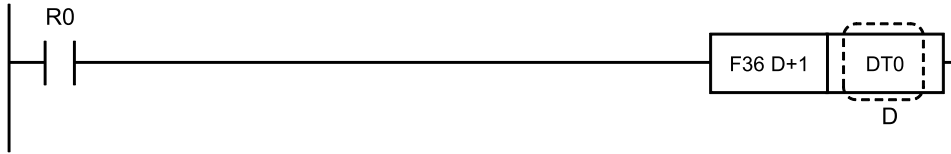

■ Operands

Items	Settings
D	The area (32-bit) that +1 is added to

■ Devices that can be specified (indicated by ●)

Operands	WX	WY	WR	WL	SV	EV	DT	LD	I	SWR	SDT	Constant				Index modifier	Integer Device
												K	H	M	f		
D		●	●	●	●	●	●	●	●							●	

■ Outline of operation

- Adds +1 to the 32-bit data, representing a decimal, specified in [D] and stores it in the 2-word memory area starting at [D].
 $(D+1, D) + 1 \rightarrow (D+1, D)$

■ Operation example

Operation of instruction format description program

When the internal relay R0 is ON, adds +1 to the content of the combined 32 bits of data registers DT0 and DT1.

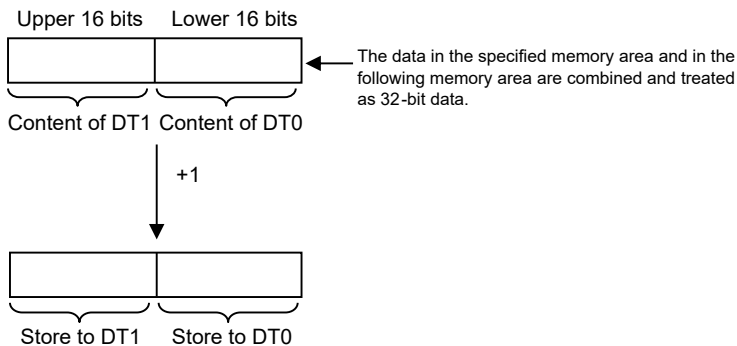

■ Precautions for programming

- With arithmetic operation instructions, in the event that the operation result falls beyond the range of values that can be handled, an overflow occurs.
- Ensure that overflows do not occur in normal circumstances.
- If an overflow occurs, the CY flag (special internal relay R9009) turns ON.

■ Flag operations

Name	Description
R9007 R9008 (ER)	Turns ON when the area is exceeded in index modification.
R900B (=)	Turns ON when the calculation result is "0"
R9009 (CY)	Turns ON when operation result overflows

11.16 F37 -1 (16-bit Data Decrement)

11.16 F37 -1 (16-bit Data Decrement)

Subtracts 1 from 16-bit data.

■ Instruction format

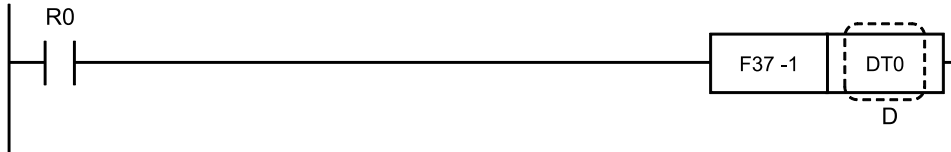

■ Operands

Items	Settings
D	Area to be decreased by 1

■ Devices that can be specified (indicated by ●)

Operands	WX	WY	WR	WL	SV	EV	DT	LD	I	SW R	SD T	Constant				Index modifier	Integer Device
												K	H	M	f		
D		●	●	●	●	●	●	●	●							●	

■ Outline of operation

- The 16-bit data specified by [D] and expressed in base 10 is decreased by 1 and stored in [D].
 $(D) - 1 \rightarrow (D)$

■ Operation example

Operation of instruction format description program

When internal relay R0 is ON, the content of data register DT0 is decreased by 1.

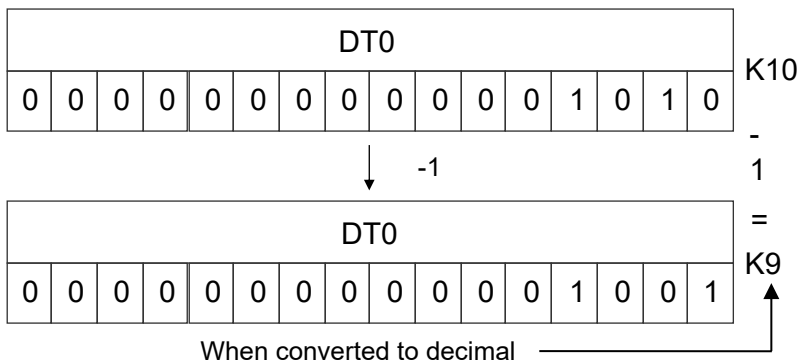

■ Precautions for programming

- If the result of an arithmetic operation instruction exceeds the numerical range that can be handled, an underflow will result.

- Under normal circumstances, do not allow an underflow to occur.
- If an underflow occurs, use the 32-bit operation instruction.
- If an underflow occurs, the CY flag (special internal relay R9009) will turn ON.

■ Flag operations

Name	Description
R9007 R9008 (ER)	Turns ON when the area is exceeded in index modification.
R900B (=)	Turns ON when the calculation result is "0"
R9009 (CY)	Turns ON when the calculation result underflows

11.17 F38 D-1 (32-bit Data Decrement)

11.17 F38 D-1 (32-bit Data Decrement)

Subtracts 1 from 32-bit data.

■ Instruction format

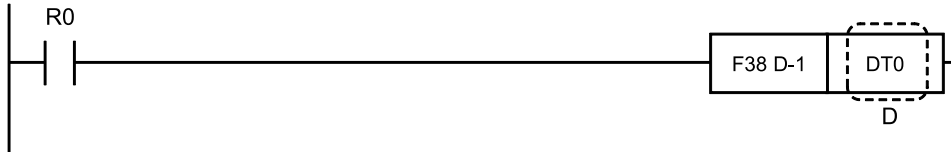

■ Operands

Items	Settings
D	Area (32-bit) from which 1 is subtracted

■ Devices that can be specified (indicated by ●)

Operands	WX	WY	WR	WL	SV	EV	DT	LD	I	SW R	SD T	Constant				Index modifier	Integer Device
												K	H	M	f		
D		●	●	●	●	●	●	●	●							●	

■ Outline of operation

- 1 is subtracted from the 32-bit data that expresses the decimal number specified by [D] and the result is stored in the 2-word memory area starting at [D].

$$(D+1, D) - 1 \rightarrow (D+1, D)$$

■ Operation example

Operation of instruction format description program

When internal relay R0 turns ON, 1 is subtracted from the contents of the 32-bit data that is a combination of data registers DT0 and DT1.

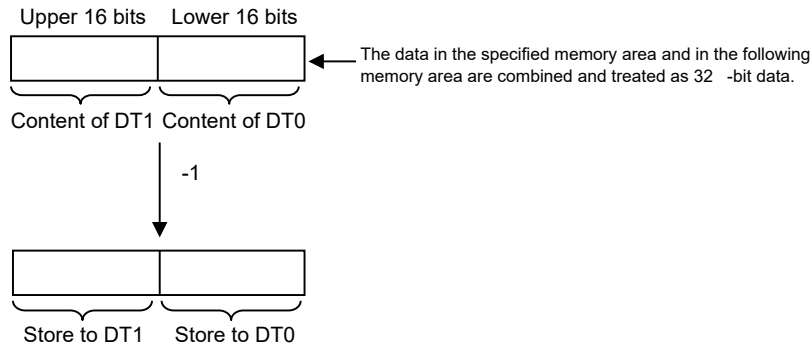

■ Precautions for programming

- If the result of an arithmetic operation instruction exceeds the numerical range that can be handled, an underflow will result.
- Under normal circumstances, do not allow an underflow to occur.
- If an underflow occurs, the CY flag (special internal relay R9009) will turn ON.

■ Flag operations

Name	Description
R9007 R9008 (ER)	Turns ON when the area is exceeded in index modification.
R900B (=)	Turns ON when the calculation result is"0"
R9009 (CY)	Turns ON when the calculation result underflows

11.18 F39 D*D (32-bit Data Multiplication [S1*S2=D+1, D])

11.18 F39 D*D (32-bit Data Multiplication [S1*S2=D+1, D])

Multiplies 32-bit data items and stores the result in the 32-bit two-word area.

■ Instruction format

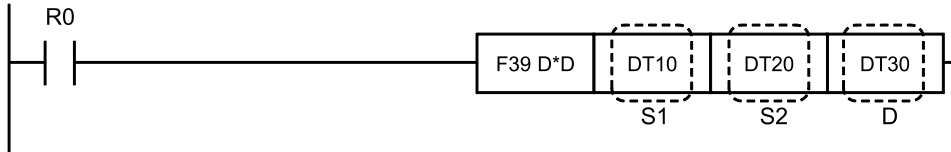

■ Operands

Items	Settings
S1	Multiplicand data: Area storing 32-bit data, or constant data
S2	Multiplier data: Area storing 32-bit data, or constant data
D	Storage destination: Area storing multiplication result (32-bit data)

■ Devices that can be specified (indicated by ●)

Operands	WX	WY	WR	WL	SV	EV	DT	LD	I	SWR	SDT	Constant				Index modifier	Integer Device
												K	H	M	f		
S1	●	●	●	●	●	●	●	●	●	●	●	●	●	●	●	●	
S2	●	●	●	●	●	●	●	●	●	●	●	●	●	●	●	●	
D		●	●	●	●	●	●	●	●							●	

■ Outline of operation

- The 32-bit data specified by [S1] and the 32-bit data specified by [S2] are multiplied, and the result is stored in the area specified by [D].
 $(S1+1, S1) \times (S2+1, S2) \rightarrow (D+1, D)$
- The operation result is stored as two words of 32-bit data.

■ Operation example

Operation of instruction format description program

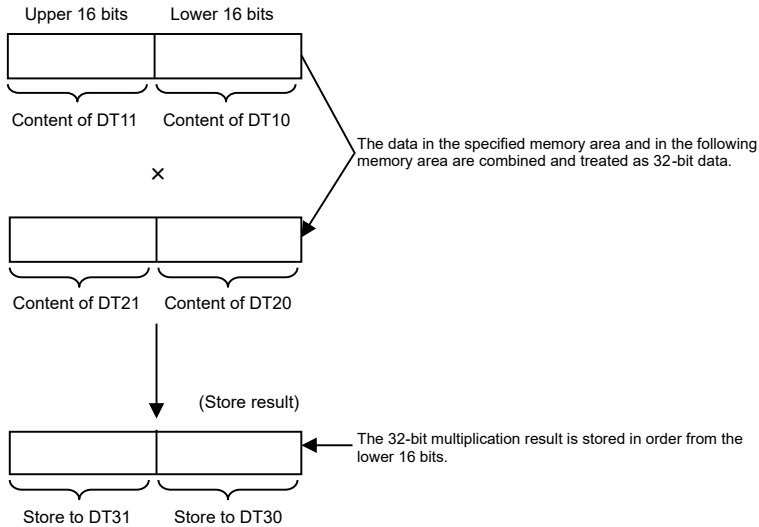

■ Precautions for programming

Keep the operation result [D] within the range of K-2147483648 to K2147483647.

■ Flag operations

Name	Description
R9007	Turns ON when the area is exceeded in index modification.
R9008 (ER)	Turns ON when the operation result exceeds 32 bits
R900B (=)	Turns ON when the calculation result is "0"

(MEMO)

12 BCD Data Arithmetic Instructions

12.1	F40 B+ (4-digit BCD Data Addition [D+S=D])	12-2
12.2	F41 DB+ (8-digit BCD Data Addition [D+S=D])	12-4
12.3	F42 B+ (4-digit BCD Data Addition [S1+S2=D])	12-6
12.4	F43 DB+ (8-digit BCD Data Addition [S1+S2=D])	12-8
12.5	F45 B- (4-digit BCD Data Subtraction [D-S=D])	12-10
12.6	F46 DB- (8-digit BCD Data Subtraction [D-S=D])	12-12
12.7	F47 B- (4-digit BCD Data Subtraction [S1-S2=D])	12-14
12.8	F48 DB- (8-digit BCD Data Subtraction [S1-S2=D])	12-16
12.9	F50 B* (4-digit BCD Data Multiplication [S1*S2=D+1, D])	12-18
12.10	F51 DB* (8-Digit BCD Data Multiplication [S1*S2=D+3, D+2, D+1, D])	12-20
12.11	F52 B% (4-digit BCD Data Subtraction [S1/S2=D])	12-22
12.12	F53 DB% (8-digit BCD Data Subtraction [S1/S2=D+1, D])	12-24
12.13	F55 B+1 (4-digit BCD Data Increment)	12-26
12.14	F56 DB+1 (8-digit BCD Data Increment)	12-28
12.15	F57 B-1 (4-digit BCD Data Decrement)	12-30
12.16	F58 DB-1 (8-digit BCD Data Decrement)	12-32

12.1 F40 B+ (4-digit BCD Data Addition [D+S=D])

12.1 F40 B+ (4-digit BCD Data Addition [D+S=D])

Adds 4-digit BCD data.

■ Instruction format

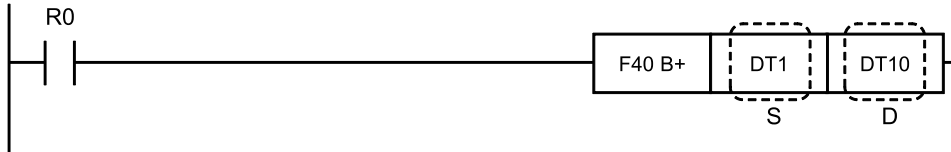

■ Operands

Items	Settings
S	Area storing the 4-digit BCD data to be added, or constant data
D	Area storing the 4-digit BCD data to be added to

■ Devices that can be specified (indicated by ●)

Operand s	WX	WY	WR	WL	SV	EV	DT	LD	I	SW R	SD T	Constant				Index modifier	Integer Device
												K	H	M	f		
S	●	●	●	●	●	●	●	●	●	●	●	●	●		●		
D		●	●	●	●	●	●	●	●						●		

■ Outline of operation

- The 4-digit BCD data specified by [S] is added to the 4-digit BCD data (H constant) specified by [D].
 $(D) + (S) \rightarrow (D)$

■ Operation example

Operation of instruction format description program

When internal relay R0 turns ON, the content of data register DT10 is added to the content of data register DT1. If DT1 contains BCD 4 and DT10 contains 8, the result is as follows.

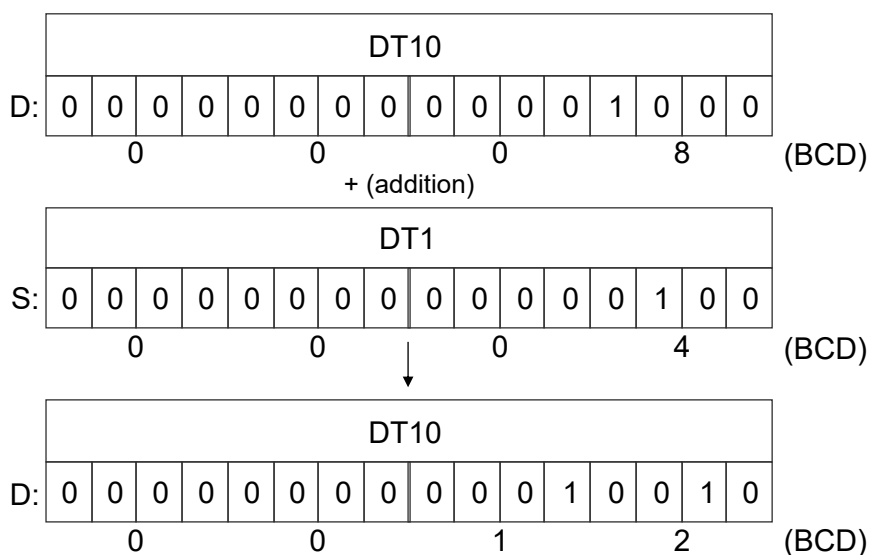

■ Precautions for programming

- If the result of an arithmetic operation instruction exceeds the maximum value that can be handled, this will result in an overflow.
- Ensure that overflows do not occur in normal circumstances.
- In the case of an overflow, use an 8-digit arithmetic operation instruction.
- If an overflow occurs, the CY flag (special internal relay R9009) turns ON.

■ Flag operations

Name	Description
R9007	Turns ON when the area is exceeded in index modification.
R9008 (ER)	Turns ON when the specified data is not BCD data
R900B (=)	Turns ON when the calculation result is "0"
R9009 (CY)	Turns ON when operation result overflows

12.2 F41 DB+ (8-digit BCD Data Addition [D+S=D])

12.2 F41 DB+ (8-digit BCD Data Addition [D+S=D])

Adds 8-digit BCD data.

■ Instruction format

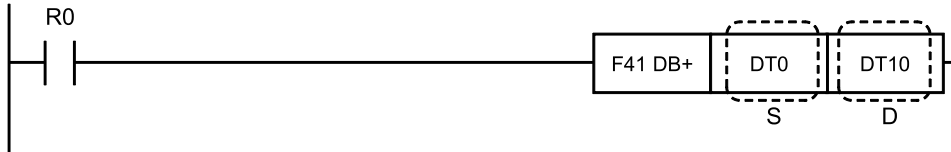

■ Operands

Items	Settings
S	Area storing the 8-digit BCD data to be added, or constant data
D	Area storing the 8-digit BCD data to be added to

■ Devices that can be specified (indicated by ●)

Operand s	WX	WY	WR	WL	SV	EV	DT	LD	I	SW R	SD T	Constant				Index modifier	Integer Device
												K	H	M	f		
S	●	●	●	●	●	●	●	●	●	●	●	●	●	●	●	●	
D		●	●	●	●	●	●	●	●						●		

■ Outline of operation

- The 8-digit BCD data specified by [S] is added to the 8-bit BCD data (H constant) specified by [D].
 $(D+1, D) + (S+1, S) \rightarrow (D+1, D)$

■ Operation example

Operation of instruction format description program

When internal relay R0 turns ON, the contents of data registers DT0 and DT1 are added to the contents of data registers DT10 and DT11.

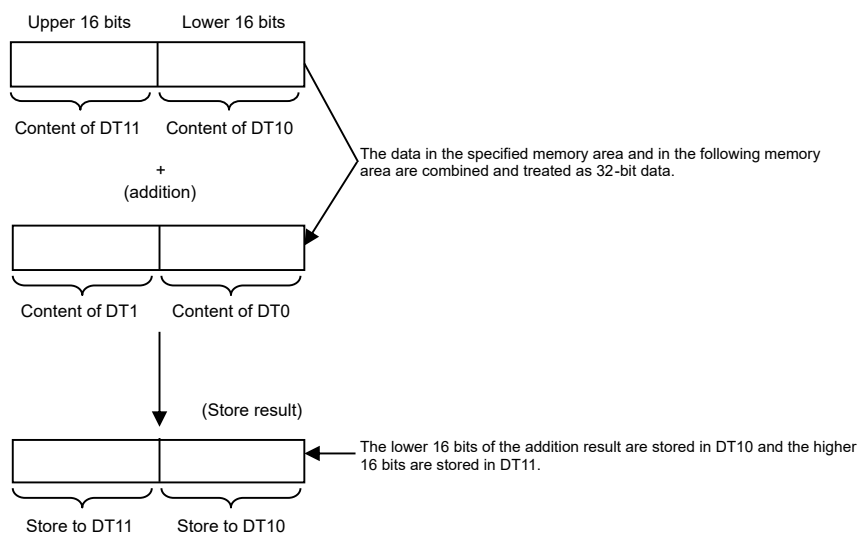

■ Precautions for programming

- If the result of an arithmetic operation instruction exceeds the maximum value that can be handled, this will result in an overflow.
- Ensure that overflows do not occur in normal circumstances.
- If an overflow occurs, the CY flag (special internal relay R9009) turns ON.

■ Flag operations

Name	Description
R9007	Turns ON when the area is exceeded in index modification.
R9008 (ER)	Turns ON when the specified data is not BCD data
R900B (=)	Turns ON when the calculation result is "0"
R9009 (CY)	Turns ON when operation result overflows

12.3 F42 B+ (4-digit BCD Data Addition [S1+S2=D])

12.3 F42 B+ (4-digit BCD Data Addition [S1+S2=D])

Adds 4-digit BCD data.

■ Instruction format

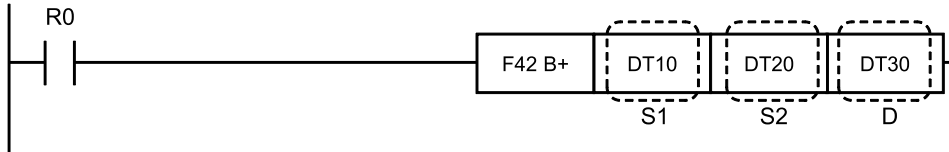

■ Operands

Items	Settings
S1	Area storing the 4-digit BCD data to be added, or constant data
S2	Area storing the 4-digit BCD data to be added, or constant data
D	Area storing the addition results

■ Devices that can be specified (indicated by ●)

Operands	WX	WY	WR	WL	SV	EV	DT	LD	I	SWR	SDT	Constant				Index modifier	Integer Device
												K	H	M	f		
S1	●	●	●	●	●	●	●	●	●	●	●	●	●	●	●	●	
S2	●	●	●	●	●	●	●	●	●	●	●	●	●	●	●	●	
D		●	●	●	●	●	●	●	●							●	

■ Outline of operation

- The 4-digit BCD data (H constant) specified by [S1] and [S2] are added together, and the result is stored in [D].
(S1) + (S2) → (D)

■ Operation example

Operation of instruction format description program

When internal relay R0 turns ON, the contents of data register DT10 and data register DT20 are added together, and the result is stored in data register DT30. If DT10 contains BCD 8 and DT20 contains BCD 4, the result is as follows.

12.3 F42 B+ (4-digit BCD Data Addition [S1+S2=D])



■ Precautions for programming

- If the result of an arithmetic operation instruction exceeds the maximum value that can be handled, this will result in an overflow.
- Ensure that overflows do not occur in normal circumstances.
- In the case of an overflow, use an 8-digit arithmetic operation instruction.
- If an overflow occurs, the CY flag (special internal relay R9009) turns ON.

■ Flag operations

Name	Description
R9007	Turns ON when the area is exceeded in index modification.
R9008 (ER)	Turns ON when the specified data is not BCD data
R900B (=)	Turns ON when the calculation result is "0"
R9009 (CY)	Turns ON when operation result overflows

12.4 F43 DB+ (8-digit BCD Data Addition [S1+S2=D])

12.4 F43 DB+ (8-digit BCD Data Addition [S1+S2=D])

Adds 8-digit BCD data.

■ Instruction format

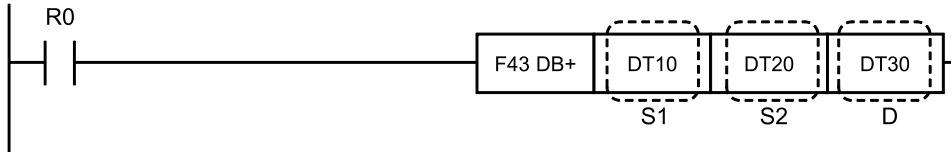

■ Operands

Items	Settings
S1	Area storing the 8-digit BCD data to be added, or constant data
S2	Area storing the 8-digit BCD data to be added, or constant data
D	Area storing the addition results

■ Devices that can be specified (indicated by ●)

Operands	WX	WY	WR	WL	SV	EV	DT	LD	I	SW R	SD T	Constant				Index modifier	Integer Device
												K	H	M	f		
S1	●	●	●	●	●	●	●	●	●	●	●	●	●	●	●	●	
S2	●	●	●	●	●	●	●	●	●	●	●	●	●	●	●	●	
D		●	●	●	●	●	●	●	●							●	

■ Outline of operation

- The 8-digit BCD data (H constant) specified by [S1] and [S2] are added together, and the result is stored in [D].
 $(S1+1, S1) + (S2+1, S2) \rightarrow (D+1, D)$
- The memory area is specified by the memory area number of the lower 16-bit portion.

■ Operation example

Operation of instruction format description program

When internal relay R0 turns ON, the contents of data registers DT10 and DT11 are added to the contents of data registers DT20 and DT21, and the result is stored in data registers DT30 and DT31.

12.4 F43 DB+ (8-digit BCD Data Addition [S1+S2=D])

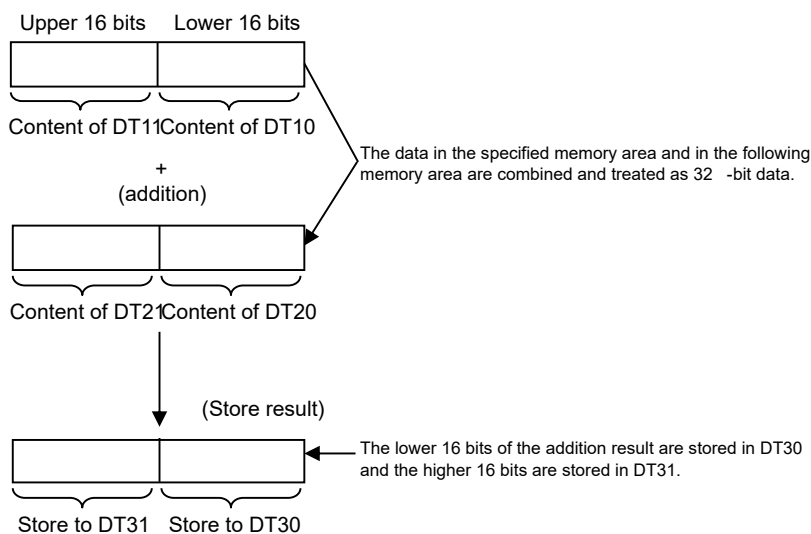

■ Precautions for programming

- If the result of an arithmetic operation instruction exceeds the maximum value that can be handled, this will result in an overflow.
- Ensure that overflows do not occur in normal circumstances.
- If an overflow occurs, the CY flag (special internal relay R9009) turns ON.

■ Flag operations

Name	Description
R9007	Turns ON when the area is exceeded in index modification.
R9008 (ER)	Turns ON when the specified data is not BCD data
R900B (=)	Turns ON when the calculation result is "0"
R9009 (CY)	Turns ON when operation result overflows

12.5 F45 B- (4-digit BCD Data Subtraction [D-S=D])

12.5 F45 B- (4-digit BCD Data Subtraction [D-S=D])

Subtracts 4-digit BCD data.

■ Instruction format

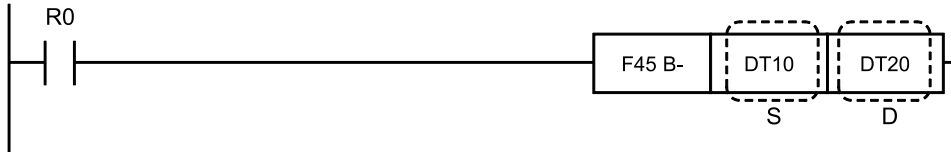

■ Operands

Items	Settings
S	Area storing the subtrahend (4-digit BCD data) or constant data
D	Area storing the subtrahend (4-digit BCD data)

■ Devices that can be specified (indicated by ●)

Operand s	WX	WY	WR	WL	SV	EV	DT	LD	I	SW R	SD T	Constant				Index modifier	Integer Device
												K	H	M	f		
S	●	●	●	●	●	●	●	●	●	●	●	●	●	●	●	●	
D		●	●	●	●	●	●	●	●							●	

■ Outline of operation

- The 4-digit BCD data specified by [S] is subtracted from the 4-digit BCD data (H constant) specified by [D].
(D) - (S) → (D)

■ Operation example

Operation of instruction format description program

Subtracts the contents of data register DT10 from the contents of data register DT20 when internal relay R0 turns ON. When BCD is 16 in DT20 and 4 in DT10, it is as shown below.

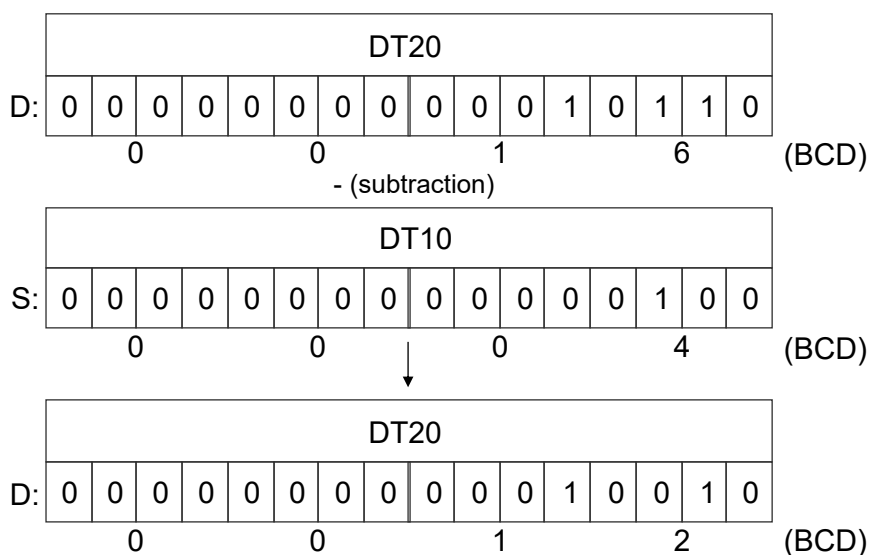

■ **Precautions for programming**

- If the result of an arithmetic operation instruction exceeds the maximum value that can be handled, this will result in an underflow.
- Under normal circumstances, do not allow an underflow to occur.
- If an underflow occurs, use an 8-digit arithmetic operation instruction.
- If an underflow occurs, the CY flag (special internal relay R9009) will turn ON.

■ **Flag operations**

Name	Description
R9007	Turns ON when the area is exceeded in index modification.
R9008 (ER)	Turns ON when the specified data is not BCD data
R900B (=)	Turns ON when the calculation result is "0"
R9009 (CY)	Turns ON when the calculation result underflows

12.6 F46 DB- (8-digit BCD Data Subtraction [D-S=D])

12.6 F46 DB- (8-digit BCD Data Subtraction [D-S=D])

Subtracts 8-digit BCD data.

■ Instruction format

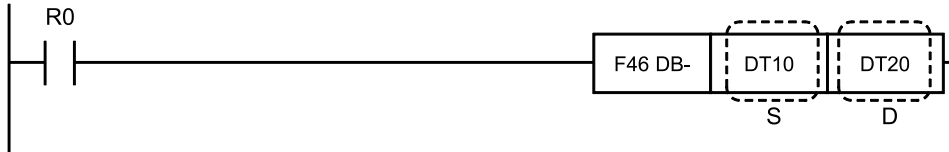

■ Operands

Items	Settings
S	Area that stores the subtrahend (8-digit BCD data), or constant data
D	Area storing the number to be subtracted (8-digit BCD data)

■ Devices that can be specified (indicated by ●)

Operand s	WX	WY	WR	WL	SV	EV	DT	LD	I	SW R	SD T	Constant				Index modifier	Integer Device
												K	H	M	f		
S	●	●	●	●	●	●	●	●	●	●	●	●	●	●	●	●	
D		●	●	●	●	●	●	●	●						●		

■ Outline of operation

- The 8-digit BCD data specified by [S] is subtracted from the 8-digit BCD data (H constant) specified by [D].
 $(D+1, D) - (S+1, S) \rightarrow (D+1, D)$

■ Operation example

Operation of instruction format description program

When internal relay R0 turns ON, the content of data registers DT10 and DT11 is subtracted from the content of data registers DT20 and DT21.

12.6 F46 DB- (8-digit BCD Data Subtraction [D-S=D])

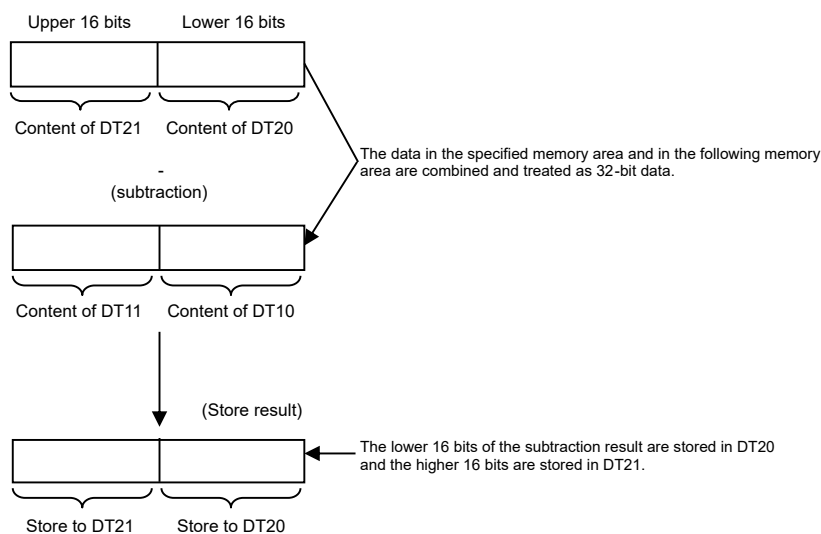

■ Precautions for programming

- If the result of an arithmetic operation instruction exceeds the maximum value that can be handled, this will result in an underflow.
- Under normal circumstances, do not allow an underflow to occur.
- If an underflow occurs, the CY flag (special internal relay R9009) will turn ON.

■ Flag operations

Name	Description
R9007	Turns ON when the area is exceeded in index modification.
R9008 (ER)	
R900B (=)	Turns ON when the calculation result is "0"
R9009 (CY)	Turns ON when the calculation result underflows

12.7 F47 B- (4-digit BCD Data Subtraction [S1-S2=D])

12.7 F47 B- (4-digit BCD Data Subtraction [S1-S2=D])

Subtracts 4-digit BCD data.

■ Instruction format

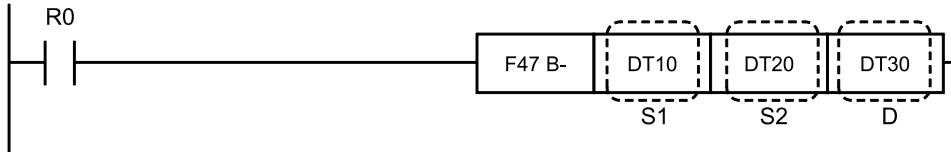

■ Operands

Items	Settings
S1	Area storing the minuend (4-digit BCD data), or constant data
S2	Area storing the subtrahend (4-digit BCD data) or constant data
D	Area that stores the calculation result

■ Devices that can be specified (indicated by ●)

Operands	WX	WY	WR	WL	SV	EV	DT	LD	I	SWR	SDT	Constant				Index modifier	Integer Device
												K	H	M	f		
S1	●	●	●	●	●	●	●	●	●	●	●	●	●	●	●		
S2	●	●	●	●	●	●	●	●	●	●	●	●	●	●	●		
D		●	●	●	●	●	●	●	●							●	

■ Outline of operation

- The 4-digit BCD data specified by [S2] is subtracted from the 4-digit BCD data (H constant) specified by [S1], and the result is stored in [D].
 $(S1) - (S2) \rightarrow (D)$

■ Operation example

Operation of instruction format description program

When internal relay R0 turns ON, the content of data register DT20 is subtracted from the content of data register DT10, and the result is stored in data register DT30. If DT10 contains BCD 16 and DT20 contains BCD 4, the result is as follows.



■ **Precautions for programming**

- If the result of an arithmetic operation instruction exceeds the maximum value that can be handled, this will result in an underflow.
- Under normal circumstances, do not allow an underflow to occur.
- If an underflow occurs, use an 8-digit arithmetic operation instruction.
- If an underflow occurs, the CY flag (special internal relay R9009) will turn ON.

■ **Flag operations**

Name	Description
R9007	Turns ON when the area is exceeded in index modification.
R9008 (ER)	Turns ON when the specified data is not BCD data
R900B (=)	Turns ON when the calculation result is "0"
R9009 (CY)	Turns ON when the calculation result underflows

12.8 F48 DB- (8-digit BCD Data Subtraction [S1-S2=D])

12.8 F48 DB- (8-digit BCD Data Subtraction [S1-S2=D])

Subtracts 8-digit BCD data.

■ Instruction format

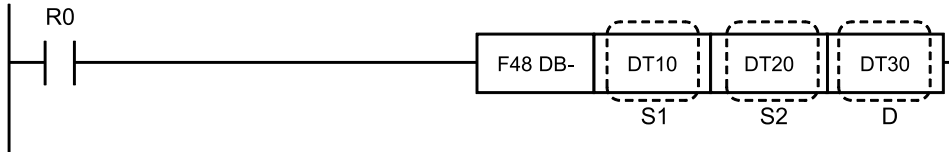

■ Operands

Items	Settings
S1	Area that stores the minuend (8-digit BCD data), or constant data
S2	Area that stores the subtrahend (8-digit BCD data), or constant data
D	Area that stores the calculation result

■ Devices that can be specified (indicated by ●)

Operands	WX	WY	WR	WL	SV	EV	DT	LD	I	SW R	SD T	Constant				Index modifier	Integer Device
												K	H	M	f		
S1	●	●	●	●	●	●	●	●	●	●	●	●			●		
S2	●	●	●	●	●	●	●	●	●	●	●	●			●		
D		●	●	●	●	●	●	●	●						●		

■ Outline of operation

- Subtracts the 8-digit BCD data specified by [S2] from the 8-digit BCD data (H constant) in the area specified by [S1], and stores the result in [D].
 $(S1+1, S1) - (S2+1, S2) \rightarrow (D+1, D)$
- Memory area is specified by the memory area number of the lower order hexadecimal part.

■ Operation example

Operation of instruction format description program

Subtracts the contents of data registers DT20 to DT21 from the contents of data registers DT10 to DT11 when internal relay X0 turns ON, and stores the calculation result in data registers DT30 to DT31.

12.8 F48 DB- (8-digit BCD Data Subtraction [S1-S2=D])

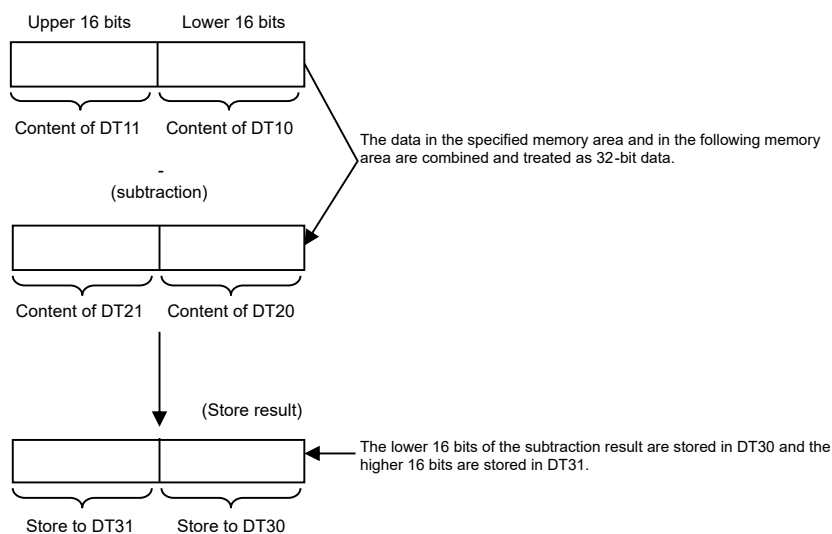

■ Precautions for programming

- If the result of an arithmetic operation instruction falls below the minimum value which can be handled, an underflow will result.
- Under normal circumstances, do not allow an underflow to occur.
- If an underflow occurs, the CY flag (special internal relay R9009) will turn ON.

■ Flag operations

Name	Description
R9007	Turns ON when the area is exceeded in index modification.
R9008 (ER)	Turns ON when the specified data is not BCD data
R900B (=)	Turns ON when the calculation result is "0"
R9009 (CY)	Turns ON when the calculation result underflows

12.9 F50 B* (4-digit BCD Data Multiplication [S1*S2=D+1, D])

12.9 F50 B* (4-digit BCD Data Multiplication [S1*S2=D+1, D])

Multiplies 4-digit BCD data.

■ Instruction format

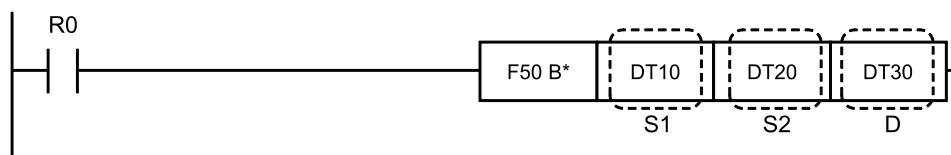

■ Operands

Items	Settings
S1	Area storing 4-digit BCD data, or constant data
S2	Area storing 4-digit BCD data, or constant data
D	Area storing multiplication result (8-digit BCD data)

■ Devices that can be specified (indicated by ●)

Operands	WX	WY	WR	WL	SV	EV	DT	LD	I	SWR	SDT	Constant				Index modifier	Integer Device
												K	H	M	f		
S1	●	●	●	●	●	●	●	●	●	●	●	●	●		●		
S2	●	●	●	●	●	●	●	●	●	●	●	●	●		●		
D		●	●	●	●	●	●	●	●						●		

■ Outline of operation

- Multiplies the 4-digit BCD data specified by [S1] (H constant) by the 4-digit BCD data specified by [S2], and the result is stored in the area specified by [D].
(S1) × (S2) → (D+1, D)
- The operation result is stored as 32-bit data (8-digit BCD).
- Storage destination [D] is specified by the number of the memory area with the lower order 16 bits.

■ Operation example

Operation of instruction format description program

e.g. If DT10 contains BCD 8 and DT20 contains BCD 2

12.9 F50 B* (4-digit BCD Data Multiplication [S1*S2=D+1, D])

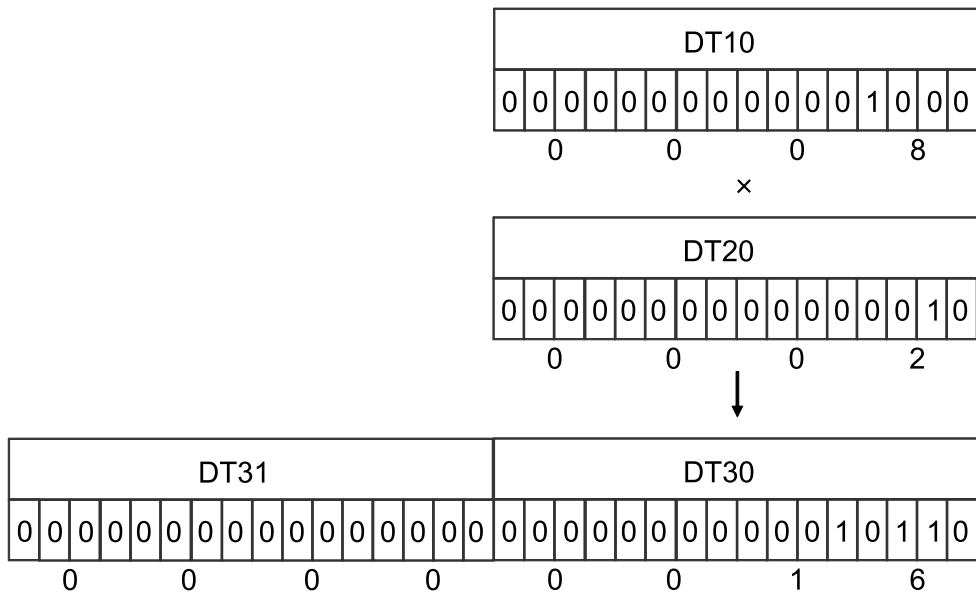

Of the 32-bit data multiplication results, the lower order 16 bits are stored in the specified memory area (DT30) and the higher order 16 bits is stored in the next area after the specified area (DT31).

■ Flag operations

Name	Description
R9007	Turns ON when the area is exceeded in index modification.
R9008 (ER)	Turns ON when the specified data is not BCD data
R900B (=)	Turns ON when the calculation result is "0"

12.10 F51 DB* (8-Digit BCD Data Multiplication [S1*S2=D+3, D+2, D+1, D])

12.10 F51 DB* (8-Digit BCD Data Multiplication [S1*S2=D+3, D+2, D+1, D])

Multiplies 8-digit BCD data.

■ Instruction format

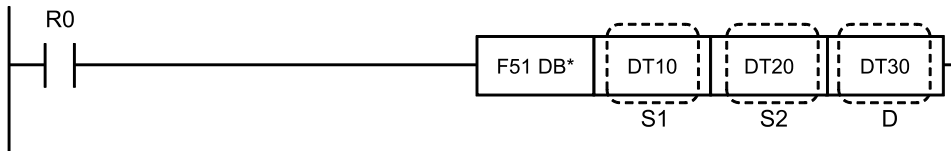

■ Operands

Items	Settings
S1	Multiplicand data: Area storing 8-digit BCD data, or constant data
S2	Multiplier data: Area storing 8-digit BCD data, or constant data
D	Storage destination: Area storing multiplication result (64-bit data)

■ Devices that can be specified (indicated by ●)

Operands	WX	WY	WR	WL	SV	EV	DT	LD	I	SWR	SDT	Constant				Index modifier	Integer Device
												K	H	M	f		
S1	●	●	●	●	●	●	●	●	●	●	●	●	●	●	●	●	
S2	●	●	●	●	●	●	●	●	●	●	●	●	●	●	●	●	
D		●	●	●	●	●	●	●								●	

■ Outline of operation

- The 8-digit BCD data (H constant) specified by [S1] is multiplied by the 8-digit BCD data specified by [S2], and the result is stored in the area specified by [D].
 $(S1+1, S1) \times (S2+1, S2) \rightarrow (D+3, D+2, D+1, D)$
- The operation result is stored as 64-bit data (16-digit BCD).
- The memory area is specified by the number of the lowest 16-bit memory area.

■ Operation example

Operation of instruction format description program

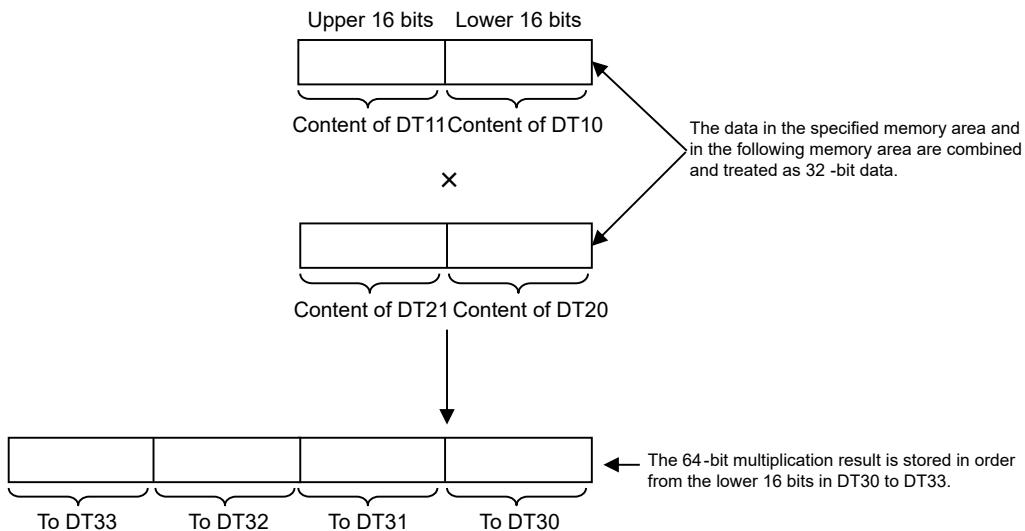

■ Flag operations

Name	Description
R9007	Turns ON when the area is exceeded in index modification.
R9008 (ER)	Turns ON when the specified data is not BCD data
R900B (=)	Turns ON when the calculation result is "0"

12.11 F52 B% (4-digit BCD Data Subtraction [S1/S2=D])

12.11 F52 B% (4-digit BCD Data Subtraction [S1/S2=D])

Divides 4-digit BCD data.

■ Instruction format

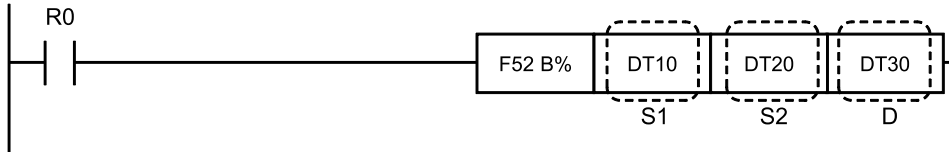

■ Operands

Items	Settings
S1	Dividend data: Area storing 4-digit BCD data, or constant data
S2	Divisor data: Area storing 4-digit BCD data, or constant data
D	Storage destination: Area storing the divisor result (quotient) (remainder stored as 16-bit data in DT90015)

■ Devices that can be specified (indicated by ●)

Operands	WX	WY	WR	WL	SV	EV	DT	LD	I	SWR	SDT	Constant				Index modifier	Integer Device
												K	H	M	f		
S1	●	●	●	●	●	●	●	●	●	●	●	●	●	●	●	●	
S2	●	●	●	●	●	●	●	●	●	●	●	●	●	●	●	●	
D		●	●	●	●	●	●	●	●						●		

■ Outline of operation

- The 4-digit BCD data (H constant) specified by [S1] is divided by the 4-digit BCD data specified by [S2], with the quotient stored in [D] and the remainder stored in a special data register.

$(S1) \div (S2) \rightarrow \text{Quotient (D)}$

Remainder (DT90015)

■ Operation example

Operation of instruction format description program

When the internal relay R0 turns ON, the contents of DT10 are divided by the contents of DT20, with the quotient stored in DT30 and the remainder stored as BCD in DT90015.

If DT10 contains BCD 15 and DT20 contains BCD 4, the result is as follows.

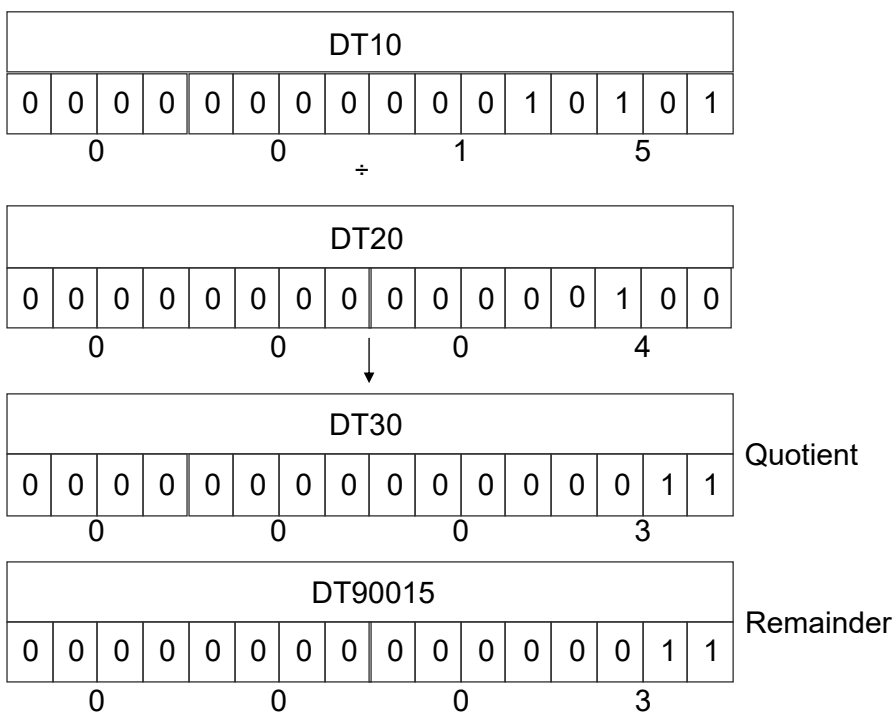

■ Flag operations

Name	Description
R9007	Turns ON when the area is exceeded in index modification.
R9008	Turns ON when the specified data is not BCD data
(ER)	Turns ON when S2 is "0"(when S1 is divided by "0")
R900B (=)	Turns ON when the operation result (quotient) is "0"

12.12 F53 DB% (8-digit BCD Data Subtraction [S1/S2=D+1, D])

12.12 F53 DB% (8-digit BCD Data Subtraction [S1/S2=D+1, D])

Divides 8-digit BCD data.

■ Instruction format

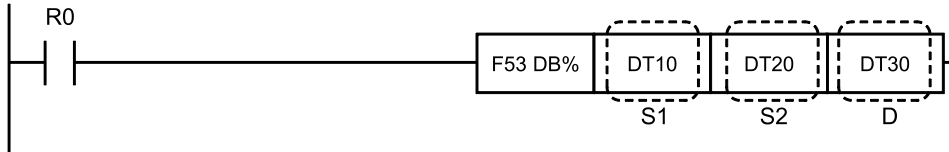

■ Operands

Items	Settings
S1	Dividend data: Area storing 8-digit BCD data, or constant data
S2	Divisor data: Area storing 8-digit BCD data, or constant data
D	Storage destination: Area storing the divisor result (quotient) (remainder stored as 32-bit data in DT90015 and DT90016)

■ Devices that can be specified (indicated by ●)

Operands	WX	WY	WR	WL	SV	EV	DT	LD	I	SWR	SDT	Constant				Index modifier	Integer Device
												K	H	M	f		
S1	●	●	●	●	●	●	●	●	●	●	●	●	●	●	●		
S2	●	●	●	●	●	●	●	●	●	●	●	●	●	●	●		
D		●	●	●	●	●	●	●	●						●		

■ Outline of operation

- The 8-digit BCD data (H constant) from the area specified by [S1] is divided by the 8-digit BCD data from the area specified by [S2]. The quotient is stored in the area specified by [D], and the remainder is stored as BCD in special data registers DT90015 and DT90016.

$(S1 + 1, S1) \div (S2 + 1, S2) \rightarrow$ Quotient (D + 1, D)

Remainder (DT90016, DT90015)

- Memory area is specified by the memory area number of the lower order hexadecimal part.

■ Operation example

Operation of instruction format description program

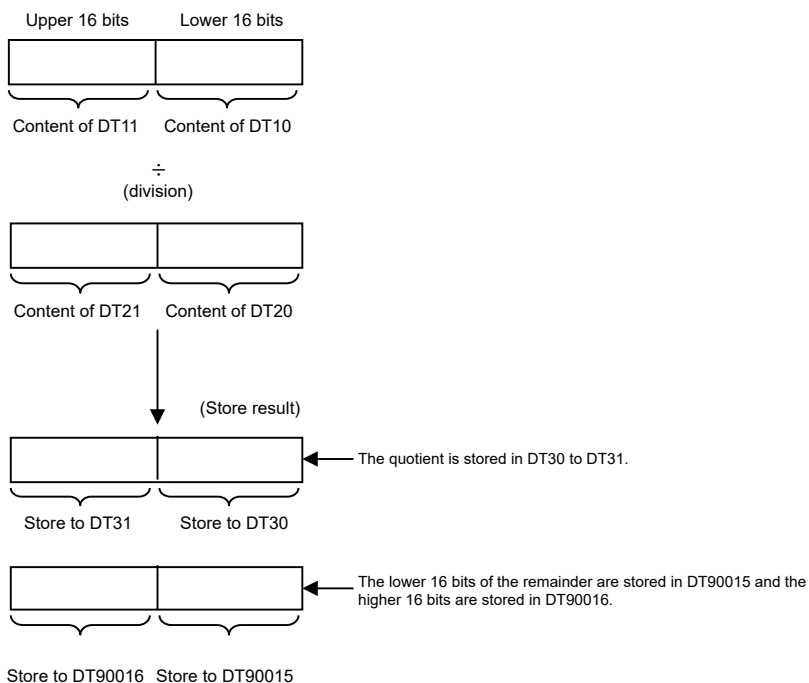

■ Flag operations

Name	Description
R9007	Turns ON when the area is exceeded in index modification.
R9008	Turns ON when the specified data is not BCD data
(ER)	Turns ON when S2 is "0" (when S1 is divided by "0")
R900B	Turns ON when the operation result (quotient) is "0"
(=)	

12.13 F55 B+1 (4-digit BCD Data Increment)

12.13 F55 B+1 (4-digit BCD Data Increment)

Adds 1 to 4-digit BCD data.

■ Instruction format

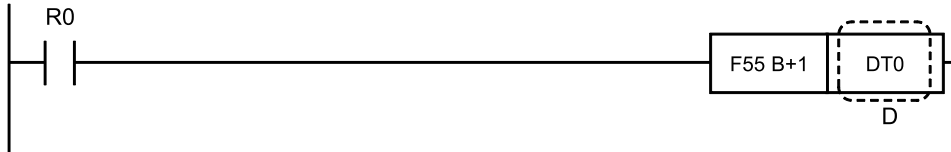

■ Operands

Items	Settings
D	Area to which 1 is to be added

■ Devices that can be specified (indicated by ●)

Operands	WX	WY	WR	WL	SV	EV	DT	LD	I	SWR	SDT	Constant				Index modifier	Integer Device
												K	H	M	f		
D		●	●	●	●	●	●	●	●							●	

■ Outline of operation

- 1 is added to the 4-digit BCD data (H constant) specified by [D] and the result is stored in [D].
 $(D) + 1 \rightarrow (D)$

■ Operation example

Operation of instruction format description program

When internal relay R0 turns ON, 1 is added to the contents of data register DT0.

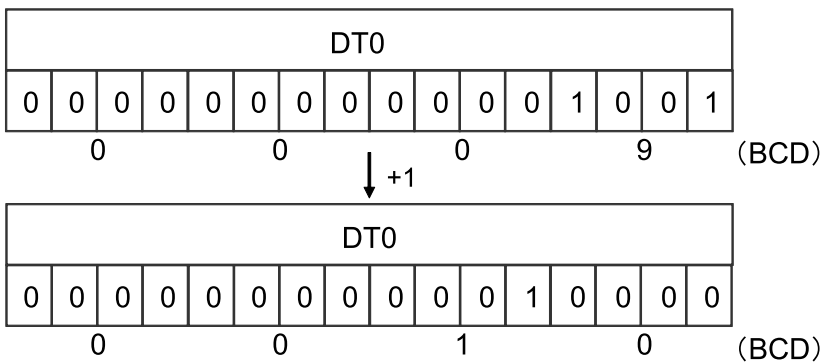

■ Precautions for programming

- If the result of an arithmetic operation instruction exceeds the maximum value that can be handled, this will result in an overflow.

- Ensure that overflows do not occur in normal circumstances.
- In the case of an overflow, use an 8-digit arithmetic operation instruction.
- If an overflow occurs, the CY flag (special internal relay R9009) turns ON.

■ Flag operations

Name	Description
R9007	Turns ON when the area is exceeded in index modification.
R9008 (ER)	Turns ON when the content of [D] is not BCD data (BCD error)
R900B (=)	Turns ON when the calculation result is "0"
R9009 (CY)	Turns ON when operation result overflows

12.14 F56 DB+1 (8-digit BCD Data Increment)

12.14 F56 DB+1 (8-digit BCD Data Increment)

Adds 1 to the 8-digit BCD data.

■ Instruction format

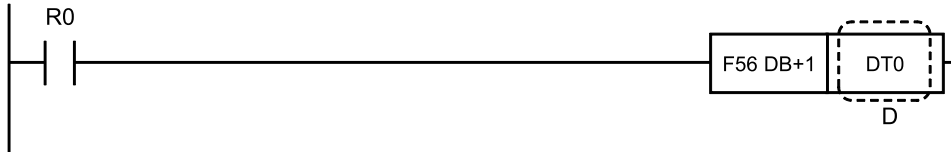

■ Operands

Items	Settings
D	The area (32-bit) that +1 is added to

■ Devices that can be specified (indicated by ●)

Operands	WX	WY	WR	WL	SV	EV	DT	LD	I	SWR	SDT	Constant				Index modifier	Integer Device
												K	H	M	f		
D		●	●	●	●	●	●	●	●							●	

■ Outline of operation

- Adds +1 to the 8-digit BCD data (H constant) specified by [D], then stores the result in the 2-word memory area starting with [D].
 $(D+1, D) + 1 \rightarrow (D+1, D)$

■ Operation example

Operation of instruction format description program

Adds 1 to the contents (8-digit BCD data) of data registers DT1 and DT0 when internal relay R0 turns ON.

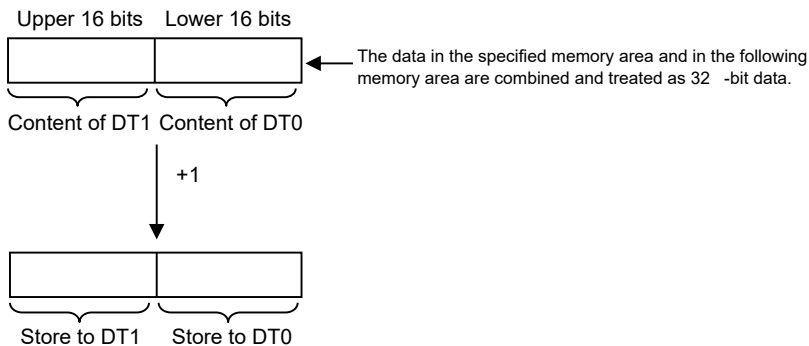

■ Precautions for programming

- If the result of an arithmetic operation instruction exceeds the maximum value that can be handled, this will result in an overflow.
- Ensure that overflows do not occur in normal circumstances.
- If an overflow occurs, the CY flag (special internal relay R9009) turns ON.

■ Flag operations

Name	Description
R9007	Turns ON when the area is exceeded in index modification.
R9008 (ER)	Turns ON when the content of the area specified by [D] is not BCD data (BCD error)
R900B (=)	Turns ON when the calculation result is "0"
R9009 (CY)	Turns ON when operation result overflows

12.15 F57 B-1 (4-digit BCD Data Decrement)

12.15 F57 B-1 (4-digit BCD Data Decrement)

Subtracts 1 from 4-digit BCD data.

■ Instruction format

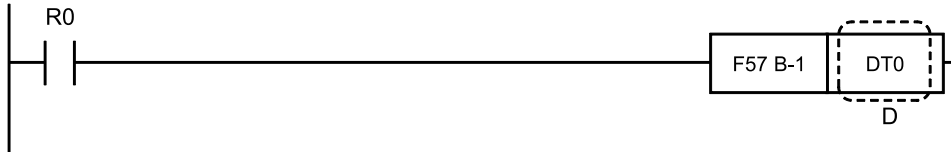

■ Operands

Items	Settings
D	Area to be decreased by 1

■ Devices that can be specified (indicated by ●)

Operands	WX	WY	WR	WL	SV	EV	DT	LD	I	SW R	SD T	Constant				Index modifier	Integer Device
												K	H	M	f		
D		●	●	●	●	●	●	●	●							●	

■ Outline of operation

- 1 is subtracted from the 4-digit BCD data (H constant) specified by [D] and the result is stored in [D].
 $(D) - 1 \rightarrow (D)$

■ Operation example

Operation of instruction format description program

When internal relay R0 turns ON, 1 is subtracted from the content of data register DT0.

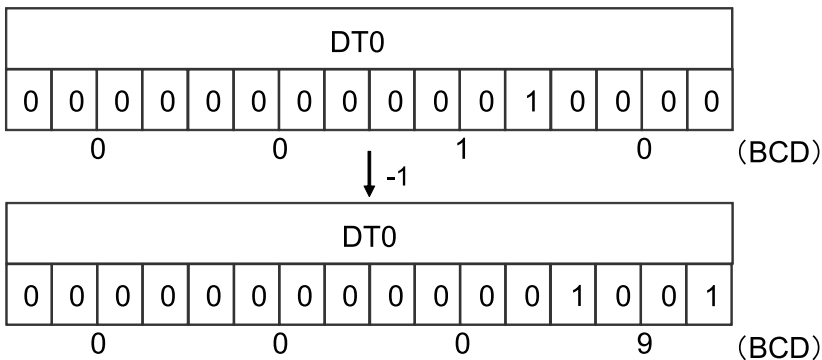

■ Precautions for programming

- If the result of an arithmetic operation instruction exceeds the maximum value that can be handled, this will result in an underflow.
- Under normal circumstances, do not allow an underflow to occur.
- If an underflow occurs, use an 8-digit arithmetic operation instruction.
- If an underflow occurs, the CY flag (special internal relay R9009) will turn ON.

■ Flag operations

Name	Description
R9007	Turns ON when the area is exceeded in index modification.
R9008 (ER)	Turns ON when the content of [D] is not BCD data (BCD error)
R900B (=)	Turns ON when the calculation result is "0"
R9009 (CY)	Turns ON when the calculation result underflows

12.16 F58 DB-1 (8-digit BCD Data Decrement)

12.16 F58 DB-1 (8-digit BCD Data Decrement)

Subtracts 1 from 8-digit BCD data.

■ Instruction format

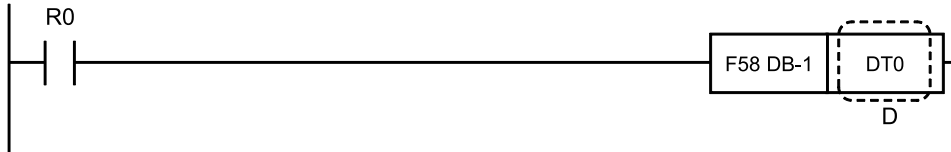

■ Operands

Items	Settings
D	Area (32-bit) from which 1 is subtracted

■ Devices that can be specified (indicated by ●)

Operands	WX	WY	WR	WL	SV	EV	DT	LD	I	SWR	SDT	Constant				Index modifier	Integer Device
												K	H	M	f		
D		●	●	●	●	●	●	●	●							●	

■ Outline of operation

- Subtracts 1 from 8-digit BCD data (H constant) specified by [D] and stores the result in the two-word memory area starting with [D].
 $(D+1, D) - 1 \rightarrow (D+1, D)$

■ Operation example

Operation of instruction format description program

Subtracts 1 from the 8-digit BCD data content of data registers DT0 and DT1 when internal relay R0 turns ON.

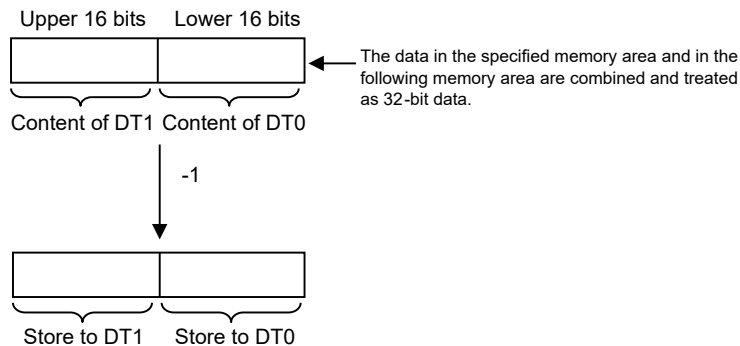

■ Precautions for programming

- If the result of an arithmetic operation instruction falls below the minimum value which can be handled, an underflow will result.
- Under normal circumstances, do not allow an underflow to occur.
- If an underflow occurs, the CY flag (special internal relay R9009) will turn ON.

■ Flag operations

Name	Description
R9007 R9008 (ER)	Turns ON when the area is exceeded in index modification. Turns ON when the content of [D] is not BCD data (BCD error)
R900B (=)	Turns ON when the calculation result is "0"
R9009 (CY)	Turns ON when the calculation result underflows

(MEMO)

13 Data Comparison Instructions

13.1 F60 CMP (16-bit Data Comparison)	13-2
13.2 F61 DCMP (32-bit Data Comparison).....	13-8
13.3 F62 WIN (16-bit Data Band Comparison).....	13-12
13.4 F63 DWIN (32-bit Data Band Comparison)	13-14
13.5 F64 BCMP (Block Data Comparison)	13-16
13.6 F373 DTR (16-bit Data Change Detection).....	13-19
13.7 F374 DDTR (32-bit Data Change Detection).....	13-21

13.1 F60 CMP (16-bit Data Comparison)

13.1 F60 CMP (16-bit Data Comparison)

Compares the two specified 16-bit data and outputs the judgment result to special internal relays.

■ Instruction format

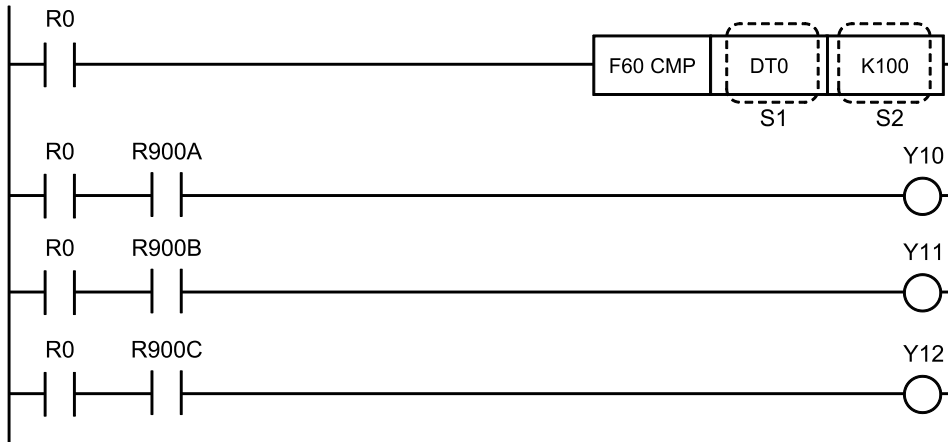

■ Operands

Items	Settings
S1	Comparison data 1: Area storing 16-bit data, or constant data
S2	Comparison data 2: Area storing 16-bit data, or constant data

■ Devices that can be specified (indicated by ●)

Operands	WX	WY	WR	WL	SV	EV	DT	LD	I	SW R	SD T	Constant				Index modifier	Integer Device
	K	H	M	f													
S1	●	●	●	●	●	●	●	●	●	●	●	●	●			●	
S2	●	●	●	●	●	●	●	●	●	●	●	●	●			●	

■ Outline of operation

- The 16-bit data specified by [S1] expressing a decimal number is compared with the 16-bit data specified by [S2], and the judgment result is output to special internal relays R9009 to R900C (comparison instruction judgement flags).
- R9009 to R900C are assigned based on whether [S1] or [S2] is larger or smaller, as shown in the table below.

Relationship between S1 and S2	Flag			
	R900A	R900B	R900C	R9009
	>	=	<	Carry
S1 < S2	OFF	OFF	ON	Indefinite
S1 = S2	OFF	ON	OFF	OFF

Relationship between S1 and S2	Flag			
	R900A	R900B	R900C	R9009
	>	=	<	Carry
S1 > S2	ON	OFF	OFF	Indefinite

(Note 1) The above table shows the comparison results for signed integer.
When comparing unsigned integer or BCD data, refer to "P.13-6".

■ Operation example

Operation of instruction format description program

When internal relay R0 turns ON and when the data register DT0 value is K100, output relay Y11 turns ON. When the value is smaller than K100, Y12 turns ON, and when the value is larger than K100, Y10 turns ON.

■ About internal relays

- In the program example on the previous page, comparison is only performed when R0 turns ON.
- If ongoing comparison is necessary, use relay R9010, which is always ON, as the internal relay.

e.g.

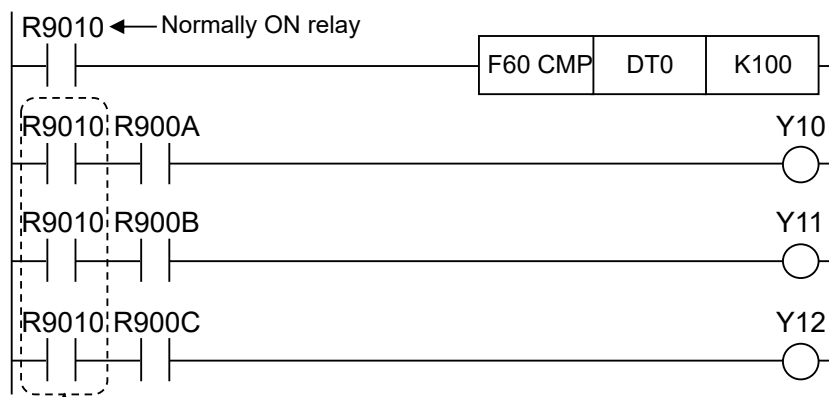

↑ This part can be omitted because it always executes.

- The following programming is possible using instructions PSHS, RDS, and POPS.

13.1 F60 CMP (16-bit Data Comparison)

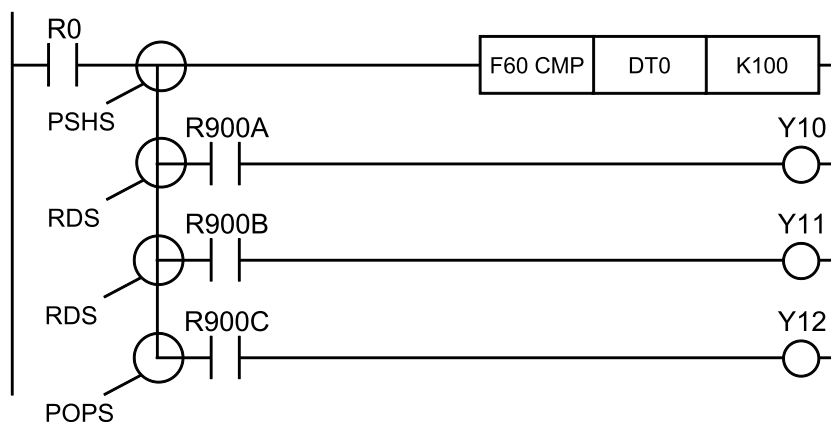

This program has the same operation as the program example.

■ Precautions when using two or more comparison instructions

- The comparison instruction judgment flags R900A to R900C are updated each time comparison instructions are executed.
- Therefore, when using two or more comparison instructions:
 1. Insert programs using judgment flags immediately after the comparison instruction.
 2. Output to the output relay or internal relay for each comparison instruction.

e.g. Example of comparison of DT0 and K100, and DT1 and K200

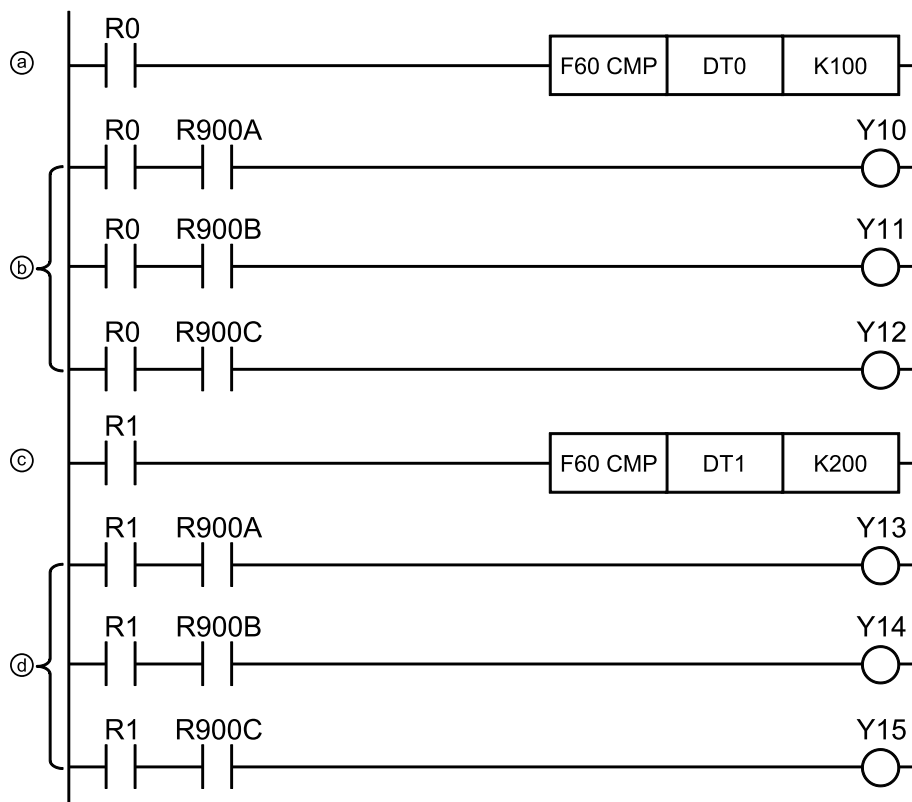

The comparison result for (a) is reflected in the contents of output relays Y10 to Y12 of program (b), and the comparison result for (c) is reflected in the contents of output relays Y13 to Y15 of program (d).

■ Precautions when comparing BCD data or external data

- When comparing BCD data or unsigned 16-bit data (0 to FFFF), construct a judgment program such as the one shown below using R900B and R9009 instead of R900A and R900C.

13.1 F60 CMP (16-bit Data Comparison)

e.g. Comparing the BCD data in DT0 and DT1

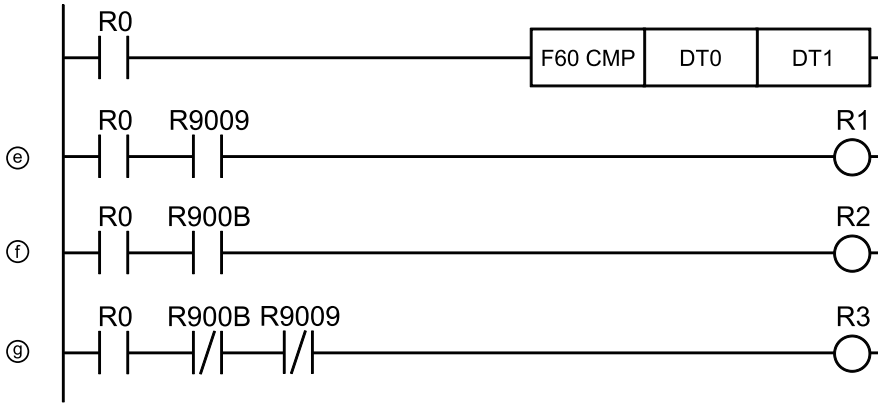

(e)	When DT0 is less than DT1, R1 turns ON
(f)	When DT0 is equal to DT1, R2 turns ON
(g)	When DT0 is greater than DT1, R3 turns ON

- Flag operation when comparing BCD data or unsigned 16-bit data (0 to FFFF)

Relationship between S1 and S2	Flag			
	R900A	R900B	R900C	R9009
	>	=	<	Carry
S1 < S2	Indefinite	OFF	Indefinite	ON
S1 = S2	OFF	ON	OFF	OFF
S1 > S2	Indefinite	OFF	Indefinite	OFF

(Note 1) The above table shows the comparison results for unsigned integer or BCD data.
When comparing signed data, refer to "P.13-2".

<Remarks>

For example, because R900A turns OFF and R900C turns ON when S1 = H8000 and S2 = H1000, accurate comparison results cannot be obtained with a judgment program that uses R900A and R900C.

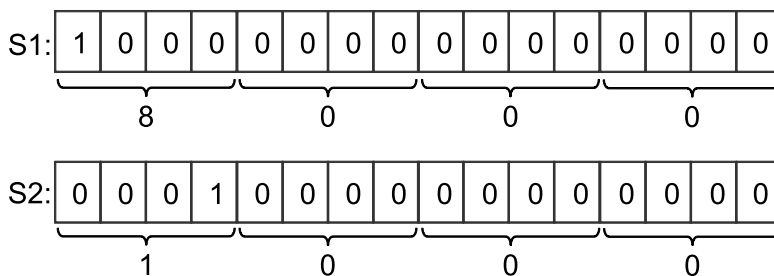

■ Flag operations

Name	Description
R9007	Turns ON when the area is exceeded in index modification.

13.1 F60 CMP (16-bit Data Comparison)

Name	Description
R9008 (ER)	

13.2 F61 DCMP (32-bit Data Comparison)

13.2 F61 DCMP (32-bit Data Comparison)

Compares two specified 32-bit data, and outputs the result to special internal relays.

■ Instruction format

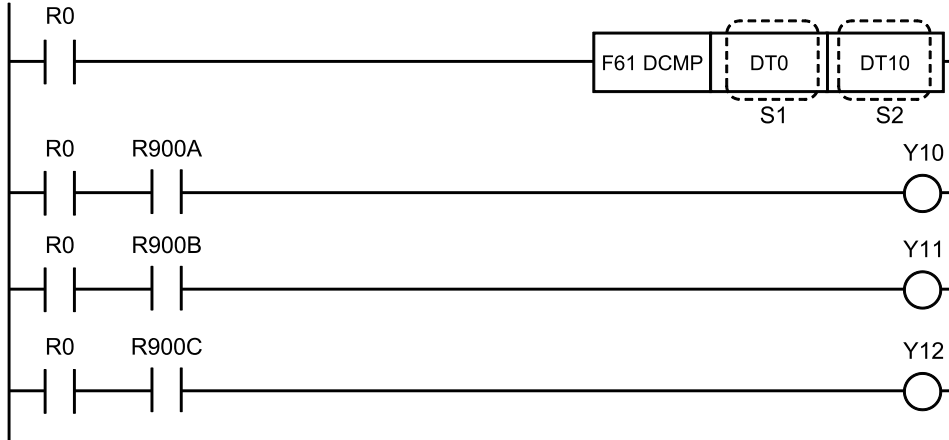

■ Operands

Items	Settings
S1	Comparison data 1: Area storing 32-bit data, or constant data
S2	Comparison data 2: Area storing 32-bit data, or constant data

■ Devices that can be specified (indicated by ●)

Operands	WX	WY	WR	WL	SV	EV	DT	LD	I	SW R	SD T	Constant				Index modifier	Integer Device
	K	H	M	f													
S1	●	●	●	●	●	●	●	●	●	●	●	●	●			●	
S2	●	●	●	●	●	●	●	●	●	●	●	●	●			●	

■ Outline of operation

- Compare the 32-bit data specified by [S1] and expressed as a decimal with 32-bit data in the area specified by [S2], and outputs the result to special internal relay flags (R9009 to R900C).
- R9009 to R900C are assigned based on whether [S1] or [S2] is larger or smaller, as shown in the table below.

Relationship between S1 and S2	Flag			
	R900A	R900B	R900C	R9009
	>	=	<	Carry
(S1+1, S1) < (S2+1, S2)	OFF	OFF	ON	Indefinite
(S1+1, S1) = (S2+1, S2)	OFF	ON	OFF	OFF
(S1+1, S1) > (S2+1, S2)	ON	OFF	OFF	Indefinite

(Note 1) The above table shows the comparison results for signed integer.

When comparing unsigned integer or BCD data, refer to "P.13-11".

- Memory area is specified by the memory area number of the lower order hexadecimal part.

■ Operation example

Operation of instruction format description program

When internal relay R0 is ON, the 32-bit data that is a combination of data registers DT0 and DT1 is compared with the 32-bit data that is a combination of data registers DT10 and DT11, and if the values of the two data are the same, the output relay Y11 turns ON. If the data in DT0 to DT1 is smaller than the data in DT10 to DT11, Y12 turns ON, and if it is larger Y10 turns ON.

■ About internal relays

- In the above program example, the comparison is performed only when R0 is ON.
- If ongoing comparison is necessary, use relay R9010, which is always ON, as the internal relay.

e.g.

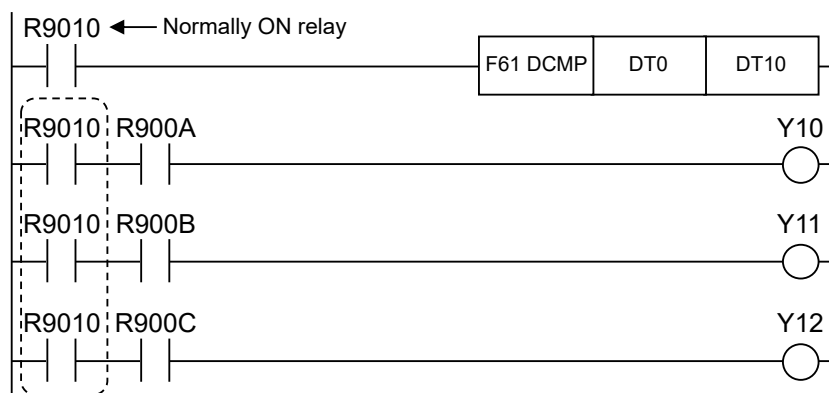

This part can be omitted because it always executes.

- The following programming is possible using instructions PSHS, RDS, and POPS.

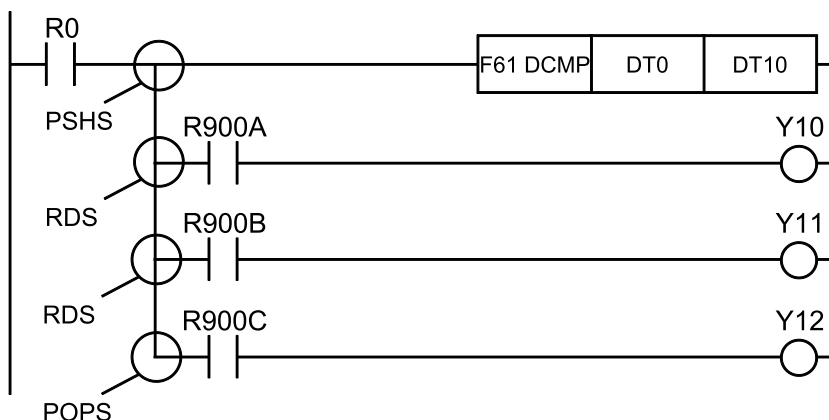

This program has the same operation as the program example.

13.2 F61 DCMP (32-bit Data Comparison)

■ Precautions when using two or more comparison instructions

- The comparison instruction judgment flags R900A to R900C are updated each time comparison instructions are executed.
- Therefore, when using two or more comparison instructions:
 1. Insert programs using judgment flags immediately after the comparison instruction.
 2. Output to the output relay or internal relay for each comparison instruction.

e.g. Comparison of DT0 to DT1 with DT10 to DT11, and DT2 to DT3 with DT20 to DT21

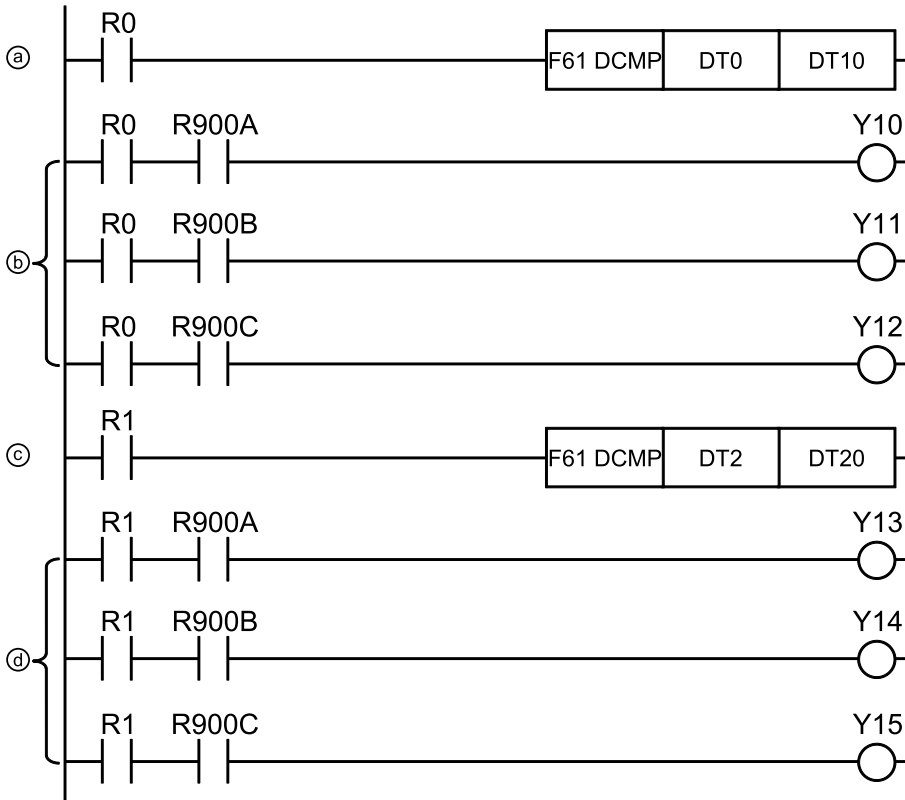

The comparison result for (a) is reflected in the contents of output relays Y10 to Y12 of program (b), and the comparison result for (c) is reflected in the contents of output relays Y13 to Y15 of program (d).

■ Precautions when comparing BCD data or external data

- When comparing BCD data or unsigned 16-bit data (0 to FFFFFFFF), do not use R900A and R900C. Use R900B and R9009, and create a judgment program such as the one shown below.

e.g. Comparing BCD data in DT0 to DT1 with BCD Data in DT10 to DT11

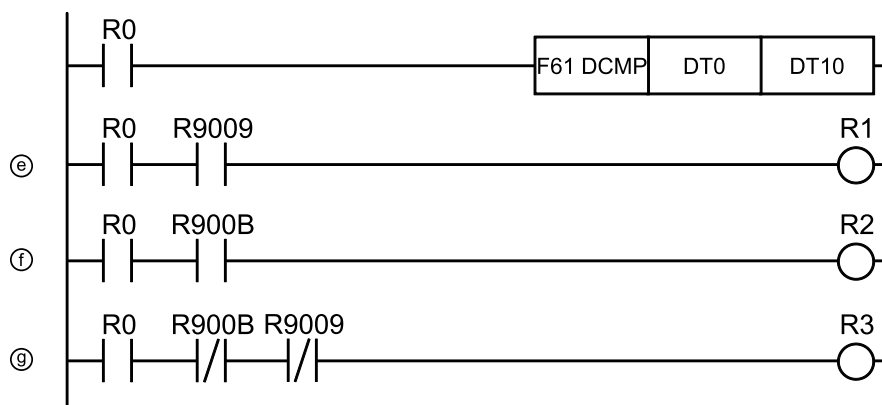

(e)	R1 turns ON when (DT1, DT0) < (DT11, DT10)
(f)	R2 turns ON when (DT1, DT0) = (DT11, DT10)
(g)	R3 turns ON when (DT1, DT0) > (DT11, DT10)

- Flag operations when comparing BCD data or unsigned 32-bit data (0 to FFFFFFFF)

Relationship between (S1+1, S1) and (S2+1, S2)	Flag			
	R900A	R900B	R900C	R9009
	>	=	<	Carry
(S1+1, S1) < (S2+1, S2)	Indefinite	OFF	Indefinite	ON
(S1+1, S1) = (S2+1, S2)	OFF	ON	OFF	OFF
(S1+1, S1) > (S2+1, S2)	Indefinite	OFF	Indefinite	OFF

(Note 1) The above table shows the comparison results for unsigned integer or BCD data.
When comparing signed data, refer to "P.13-8".

<Remarks>

For example, when S1 = H80000000 (K - 2,147,483,648) and S2 = H10000001 (K + 268,435,457), and when the F61 DCMP instruction is executed, the judgment is S1 < S2, R900A turns OFF, and R900C turns ON. Correct comparison results cannot be obtained with judgment programs that use R900A and R900C.

■ Flag operations

Name	Description
R9007 R9008 (ER)	Turns ON when the area is exceeded in index modification.

13.3 F62 WIN (16-bit Data Band Comparison)

13.3 F62 WIN (16-bit Data Band Comparison)

Performs a band comparison of signed 16-bit data and outputs the comparison result to special internal relays.

■ Instruction format

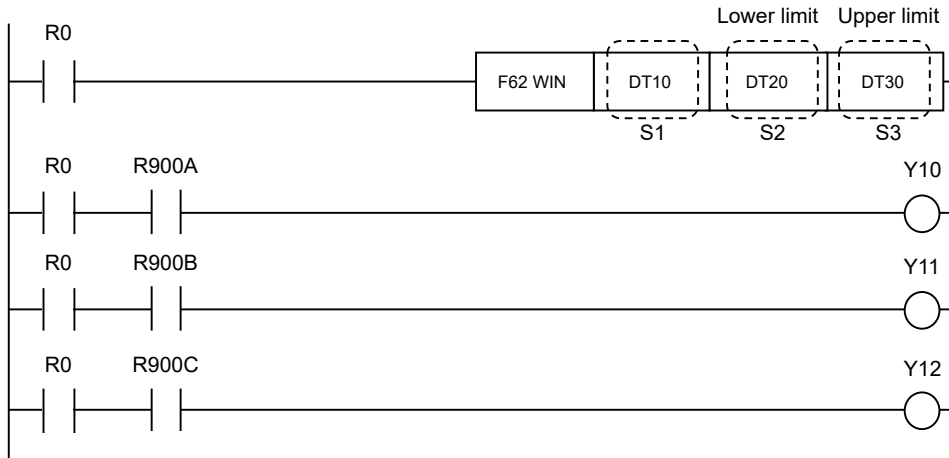

■ Operands

Items	Settings
S1	Comparison data: Area storing 16-bit data, or constant data
S2	Lower limit data: Area storing 16-bit data, or constant data
S3	Upper limit data: Area storing 16-bit data, or constant data

■ Devices that can be specified (indicated by ●)

Operands	WX	WY	WR	WL	SV	EV	DT	LD	I	SWR	SDT	Constant				Index modifier	Integer Device
												K	H	M	f		
S1	●	●	●	●	●	●	●	●	●	●	●	●	●	●	●	●	
S2	●	●	●	●	●	●	●	●	●	●	●	●	●	●	●	●	
S3	●	●	●	●	●	●	●	●	●	●	●	●	●	●	●	●	

■ Outline of operation

- A band comparison is performed on signed 16-bit data expressing a decimal number. The signed 16-bit data specified by [S1] is compared with the range specified by [S2] (lower limit value) and [S3] (upper limit value) to determine whether it falls in that range, and the comparison result is output to the special internal relays R9009 to R900C (comparison instruction judgment flag).
- The relationship between [S1], [S2], and [S3] affects R9009 to R900C as follows.

13.3 F62 WIN (16-bit Data Band Comparison)

Relationship between S1, S2, and S3	Flag			
	R900A	R900B	R900C	R9009
	>	=	<	Carry
S1 < S2	OFF	OFF	ON	×
S2 ≤ S1 ≤ S3	OFF	ON	OFF	×
S3 < S1	ON	OFF	OFF	×

(Note 1) ×: Does not change.

■ Operation example

Operation of instruction format description program

When internal relay R0 turns ON, the value of DT10 is compared with the range bounded by the lower limit value of DT20 and the upper limit value of DT30 to determine if it falls within that range.

e.g. When DT20 contains K-500 and DT30 contains K500

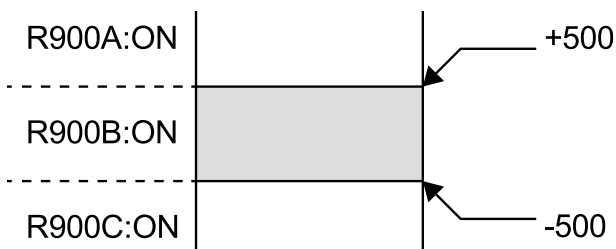

When DT10 = K-680	R900C: ON, Y12: ON
When DT10 = K-500	R900B: ON, Y11: ON
When DT10 = K256	R900B: ON, Y11: ON
When DT10 = K680	R900A: ON, Y10: ON

■ Precautions for programming

Set so that the lower limit value is equal to or less than the upper limit value (S2 ≤ S3).

■ Flag operations

Name	Description
R9007	Turns ON when the area is exceeded in index modification.
R9008	
(ER)	ON when S2 > S3

13.4 F63 DWIN (32-bit Data Band Comparison)

13.4 F63 DWIN (32-bit Data Band Comparison)

Performs a band comparison of signed 32-bit data and outputs the comparison result to special internal relays.

■ Instruction format

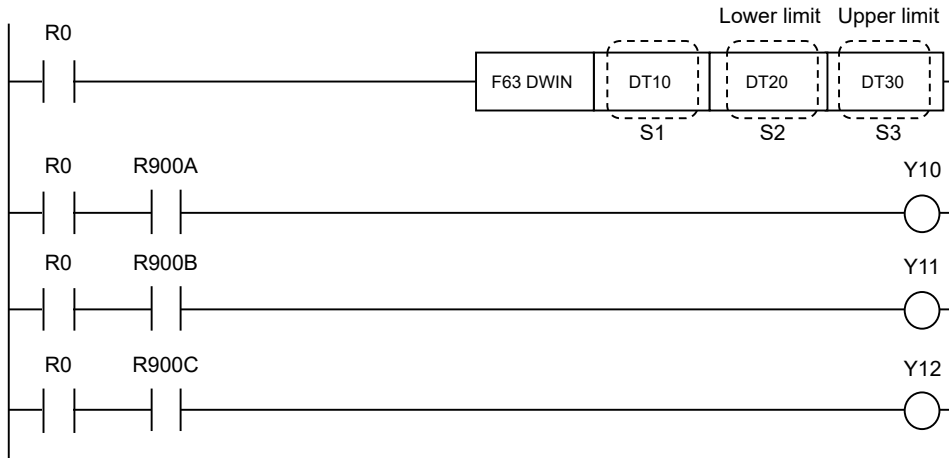

■ Operands

Items	Settings
S1	Comparison data: Area storing 32-bit data, or constant data
S2	Lower limit data: Area storing 32-bit data, or constant data
S3	Upper limit data: Area storing 32-bit data, or constant data

■ Devices that can be specified (indicated by ●)

Operands	WX	WY	WR	WL	SV	EV	DT	LD	I	SWR	SDT	Constant				Index modifier	Integer Device
												K	H	M	f		
S1	●	●	●	●	●	●	●	●	●	●	●	●	●	●	●	●	
S2	●	●	●	●	●	●	●	●	●	●	●	●	●	●	●	●	
S3	●	●	●	●	●	●	●	●	●	●	●	●	●	●	●	●	

■ Outline of operation

- A band comparison is performed on signed 32-bit data expressing a decimal number. The signed 32-bit data specified by [S1] is compared with the range specified by [S2] (lower limit value) and [S3] (upper limit value) to determine whether it falls in that range, and the comparison result is output to the special internal relays R9009 to R900C (comparison instruction judgement flag).
- The 32-bit data specified by each operand is read from the next area.
 - [S1] = (S1+1, S1)
 - [S2] = (S2+1, S2)
 - [S3] = (S3+1, S3)

13.4 F63 DWIN (32-bit Data Band Comparison)

- The relationship between [S1], [S2], and [S3] affects R9009 to R900C as follows.

Relationship between S1, S2, and S3	Flag			
	R900A	R900B	R900C	R9009
	>	=	<	Carry
S1 < S2	OFF	OFF	ON	×
S2 ≤ S1 ≤ S3	OFF	ON	OFF	×
S3 < S1	ON	OFF	OFF	×

(Note 1) ×: Does not change.

■ Operation example

Operation of instruction format description program

When internal relay R0 turns ON, the value of (DT11, DT10) is compared with the range bounded by the lower limit value of (DT21, DT20) and the upper limit value of (DT31, DT30) to determine if it falls within that range.

e.g. When DT20 and DT21 contain K-50000, and DT30 and DT31 contain K50000

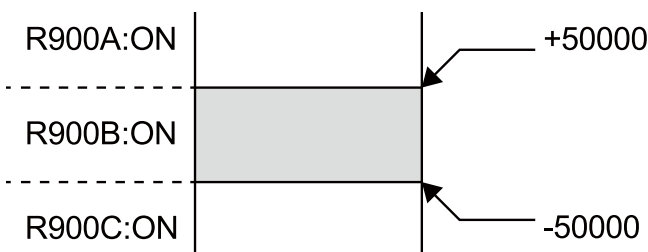

When (DT11, DT10) = K-68000	R900C: ON, Y12: ON
When (DT11, DT10) = K-50000	R900B: ON, Y11: ON
When (DT11, DT10) = K25600	R900B: ON, Y11: ON
When (DT11, DT10) = K68000	R900A: ON, Y10: ON

■ Precautions for programming

Set so that the lower limit value (S2+1, S2) is equal to or less than the upper limit value (S3+1, S3).

■ Flag operations

Name	Description
R9007	Turns ON when the area is exceeded in index modification.
R9008	
(ER)	Turns ON when (S2+1, S2) is greater than (S3+1, S3)

13.5 F64 BCMP (Block Data Comparison)

13.5 F64 BCMP (Block Data Comparison)

Detects matches in two block-specified areas in byte units.

■ Instruction format

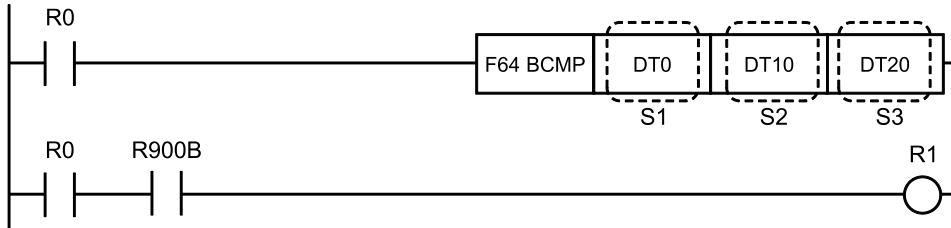

■ Operands

Items	Settings
S1	Area storing the control data (4-digit BCD data), or constant data
S2	Starting address of comparison block 1
S3	Starting address of comparison block 2

■ Devices that can be specified (indicated by ●)

Operands	WX	WY	WR	WL	SV	EV	DT	LD	I	SWR	SDT	Constant				Index modifier	Integer Device
												K	H	M	f		
S1	●	●	●	●	●	●	●	●	●	●	●	●	●	●	●	●	
S2	●	●	●	●	●	●	●	●		●	●				●		
S3	●	●	●	●	●	●	●	●		●	●				●		

■ Outline of operation

- The contents of the area specified by [S2] (comparison block 1) are compared with the contents of the area specified by [S3] (comparison block 2).
- When the comparison result shows that the contents of the blocks match, special internal relay R900B ("="flag) turns ON.
- [S1] is the control data that determines factors such as the size of the comparison.

■ How to specify control data [S1]

Specify a 4-digit BCD (H constant) according to the following format.

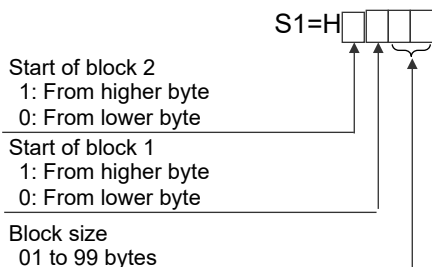

<Setting example>

When specifying the 4 bytes from the low byte of the area specified by [S2] as block 1 and the 4 bytes from the high byte of the area specified by [S3] as block 2, set [S1] to H1004.

■ Operation example**Operation of instruction format description program**

When internal relay R0 turns ON, the block starting at data register DT10 is compared with the block starting at data register DT20. When the values of the two blocks are the same, R1 turns ON. If H1004 is entered in DT0, the two blocks are as follows.

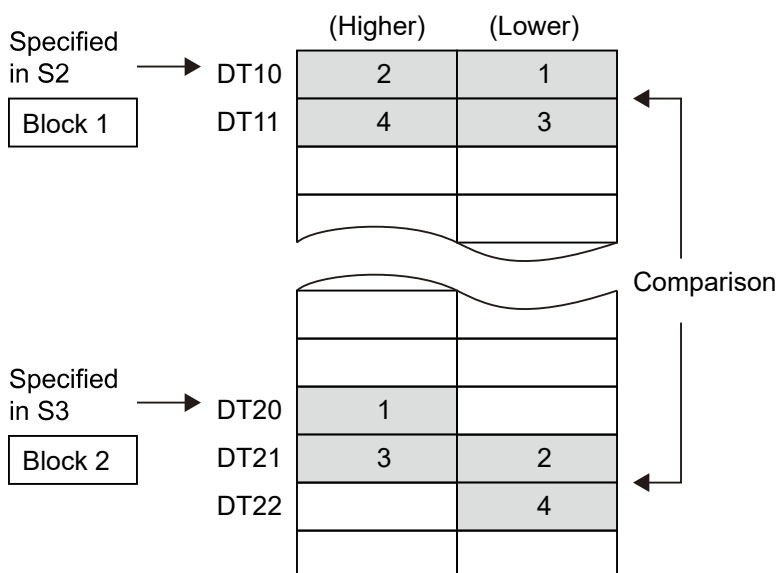
**■ Precautions for programming**

The flag R900B used for comparison instruction judgment is refreshed each time a comparison instruction, etc., is executed. Accordingly:

1. The program that uses R900B should be inserted immediately after the BCMP instruction.
2. Output the flag value to an output relay or internal relay and save the result.

13.5 F64 BCMP (Block Data Comparison)

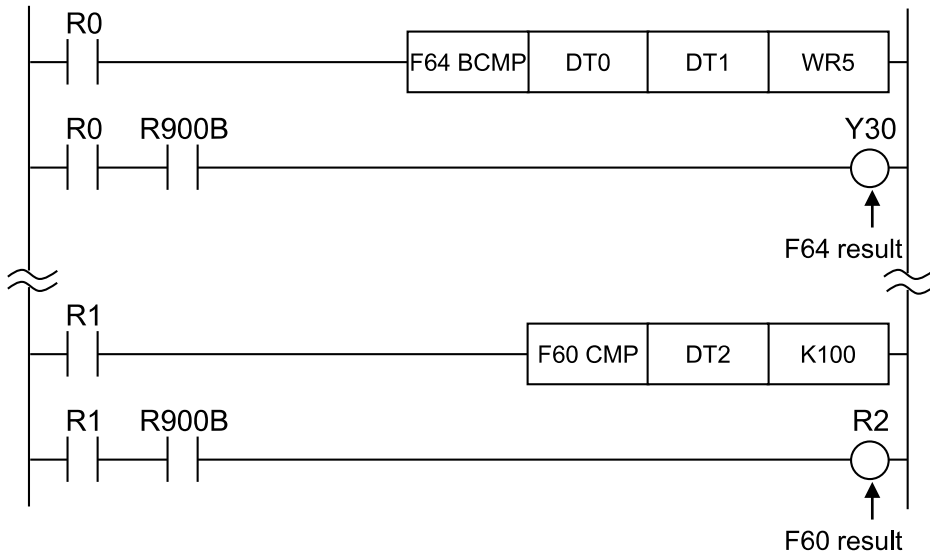

(Note 1) As shown in the program example above, make sure to place the comparison internal relay before the flag relay. This is not necessary for normal execution.

■ Flag operations

Name	Description
R9007	Turns ON when the area is exceeded in index modification.
R9008	Turns ON when the content specified by [S1] is not comprised of BCD data
(ER)	Turns ON when the specified block range exceeds the area

13.6 F373 DTR (16-bit Data Change Detection)

Detects changes in word data numerical values.

■ Instruction format

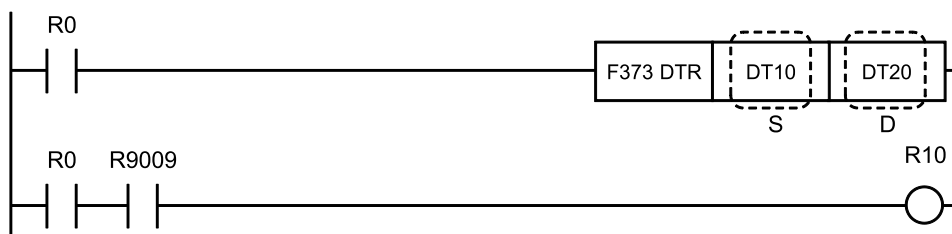

■ Operands

Items	Settings
S	Area that detects data changes
D	Area that stores data status during the previous execution

■ Devices that can be specified (indicated by ●)

Operand s	WX	WY	WR	WL	SV	EV	DT	LD	I	SW R	SD T	Constant				Index modifier	Integer Device
	K	H	M	f													
S	●	●	●	●	●	●	●	●	●	●	●					●	
D		●	●	●	●	●	●	●	●							●	

■ Outline of operation

- If the data in the area specified by [S] has changed since the previous time it was executed, the internal relay R9009 ("CY"flag) turns ON.

[D] is used as an area for memorizing the preceding values, and the current values are stored when the instruction is completed.

■ Operation example

Operation of instruction format description program

When execution condition R0 is ON, if there are changes compared to when data register DT10 was previously executed, R9009 turns ON, and R10 also turns ON following this.

■ Precautions for programming

Flag R9009, which is used for detecting data changes, is updated each time a calculation instruction, etc. is executed. Therefore,

- a program using R9009 should be inserted immediately after the F373 DTR instruction.
- Output to an output relay or internal relay to hold the results.

13.6 F373 DTR (16-bit Data Change Detection)

Note

- Always insert execution conditions before the flag relay (R9009), as shown in the above program example. This is not necessary for normal execution.

■ Flag operations

Name	Description
R9007 R9008 (ER)	Turns ON when the area is exceeded in index modification.
R9009 (CY)	Turns ON if there are changes to the specified data area

13.7 F374 DDTR (32-bit Data Change Detection)

Detects changes in double-word data (32-bit data) values.

■ Instruction format

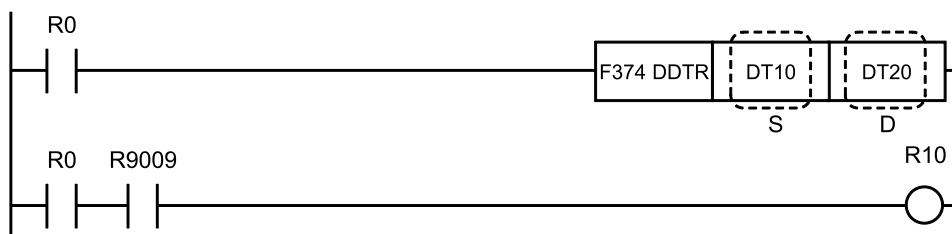

■ Operands

Items	Settings
S	Area that detects data changes
D	Area that stores data status during the previous execution

■ Devices that can be specified (indicated by ●)

Operand s	WX	WY	WR	WL	SV	EV	DT	LD	I	SW R	SD T	Constant				Index modifier	Integer Device
												K	H	M	f		
S	●	●	●	●	●	●	●	●	●	●	●					●	
D		●	●	●	●	●	●	●	●							●	

■ Outline of operation

- Internal relay R9009 (the "CY" flag) turns ON if the data in the area specified by [S, S+1] has changed from the data values of the previous execution.
[D, D+1] is used as an area for recording previous values, with the current values being stored when instruction execution is complete.

■ Operation example

Operation of instruction format description program

When execution condition R0 is ON, if there are changes compared to when data register DT10 was previously executed, R9009 turns ON, and R10 also turns ON following this.

■ Precautions for programming

Flag R9009, which is used for detecting data changes, is updated each time a calculation instruction, etc., is executed. Therefore:

- The program that uses R9009 should be inserted immediately after the F374 DDTR instruction.
- Output to an output relay or internal relay to hold the results.

13.7 F374 DDTR (32-bit Data Change Detection)

Note

- Always insert execution conditions before the flag relay (R9009), as shown in the above program example. This is not necessary for normal execution.

■ Flag operations

Name	Description
R9007 R9008 (ER)	Turns ON when the area is exceeded in index modification.
R9009 (CY)	Turns ON if there are changes to the specified data area

14 Boolean Instructions

14.1 F65 WAN (16-bit Data AND).....	14-2
14.2 F66 WOR (16-bit Data OR).....	14-4
14.3 F67 XOR (16-bit Data Exclusive OR)	14-6
14.4 F68 XNR (16-bit Data Exclusive NOR).....	14-8
14.5 F69 WUNI [(S1 AND S3) OR (S2 AND S3) = D] (16-bit).....	14-10
14.6 F215 DAND (32-bit Data AND).....	14-12
14.7 F216 DOR (32-bit Data OR)	14-14
14.8 F217 DXOR (32-bit Data Exclusive OR).....	14-16
14.9 F218 DXNR (32-bit Data Exclusive NOR)	14-18
14.10 F219 DUNI [(S1 AND S3) OR (S2 AND S3) = D] (32-bit).....	14-20

14.1 F65 WAN (16-bit Data AND)

14.1 F65 WAN (16-bit Data AND)

Calculates the logical conjunction of 16-bit data.

■ Instruction format

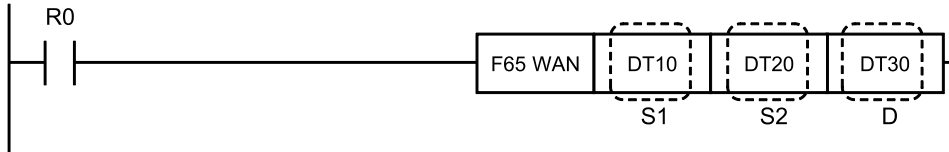

■ Operands

Items	Settings
S1	Data 1: Area storing data on which to perform the logical operation, or constant data
S2	Data 2: Area storing data on which to perform the logical operation, or constant data
D	Storage location: Area storing the operation result

■ Devices that can be specified (indicated by ●)

Operands	WX	WY	WR	WL	SV	EV	DT	LD	I	SW R	SD T	Constant				Index modifier	Integer Device
												K	H	M	f		
S1	●	●	●	●	●	●	●	●	●	●	●	●	●	●	●	●	
S2	●	●	●	●	●	●	●	●	●	●	●	●	●	●	●	●	
D		●	●	●	●	●	●	●	●							●	

■ Outline of operation

- A bitwise logical conjunction is performed on each bit of the contents of the area specified by [S1] and the contents of the area specified by [S2], and the results are stored in [D].
 $(S1) \wedge (S2) \rightarrow (D)$
- This instruction can be used for operations such as forcibly turning OFF (bit masking) specific parts of data.

■ Operation example

Operation of instruction format description program

When internal relay R0 turns ON, a bitwise logical conjunction is performed on each bit of the contents of data register DT10 and the contents of data register DT20, and the results are stored in data register DT30.

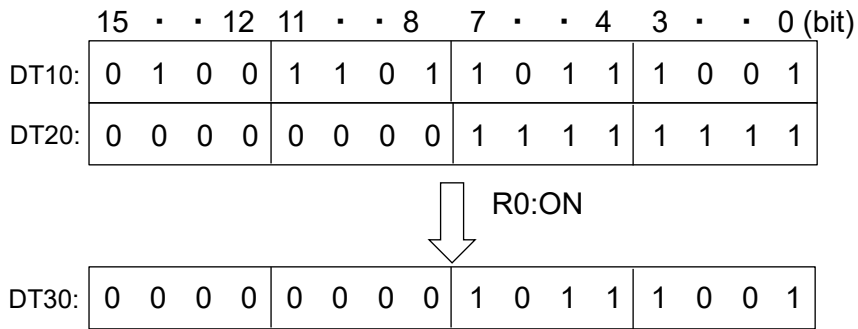

■ Logical conjunction (AND)

S1 bit	S2 bit	Logical conjunction
0	0	0
0	1	0
1	0	0
1	1	1

■ Flag operations

Name	Description
R9007 R9008 (ER)	Turns ON when the area is exceeded in index modification.
R900B (=)	Turns ON when the calculation result is "0"

14.2 F66 WOR (16-bit Data OR)

14.2 F66 WOR (16-bit Data OR)

Calculates the OR of 16-bit data.

■ Instruction format

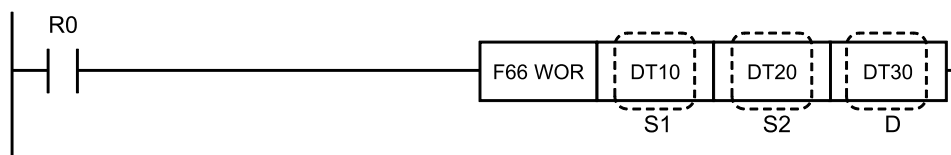

■ Operands

Items	Settings
S1	Data 1: Area storing data on which to perform the logical operation, or constant data
S2	Data 2: Area storing data on which to perform the logical operation, or constant data
D	Storage location: Area storing the operation result

■ Devices that can be specified (indicated by ●)

Operands	WX	WY	WR	WL	SV	EV	DT	LD	I	SWR	SDT	Constant				Index modifier	Integer Device
												K	H	M	f		
S1	●	●	●	●	●	●	●	●	●	●	●	●	●		●		
S2	●	●	●	●	●	●	●	●	●	●	●	●	●		●		
D		●	●	●	●	●	●	●	●						●		

■ Outline of operation

- A bitwise OR is performed on each bit of the contents of the area specified by [S1] and the contents of the area specified by [S2], and the results are stored in the area specified by [D].
(S1) v (S2) → (D)
- This instruction can be used to forcibly turn ON specific parts of data.

■ Operation example

Operation of instruction format description program

When internal relay R0 turns ON, a bitwise OR is performed on each bit of the contents of data register DT10 and the contents of data register DT20, and the result is stored in data register DT30.

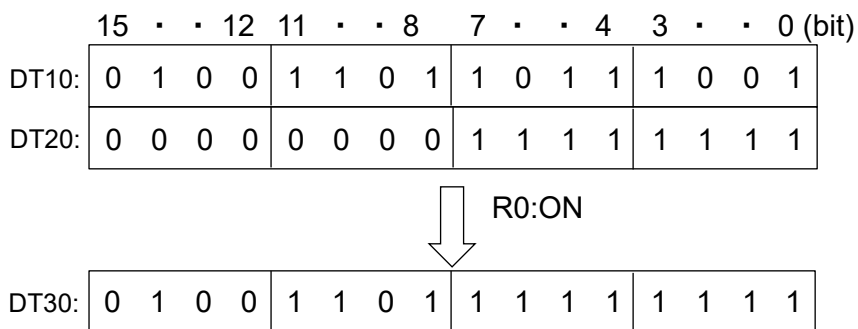

■ **Logical disjunction (OR)**

S1 bit	S2 bit	Logical disjunction
0	0	0
0	1	1
1	0	1
1	1	1

■ **Flag operations**

Name	Description
R9007 R9008 (ER)	Turns ON when the area is exceeded in index modification.
R900B (=)	Turns ON when the calculation result is"0"

14.3 F67 XOR (16-bit Data Exclusive OR)

14.3 F67 XOR (16-bit Data Exclusive OR)

Calculates the exclusive OR of 16-bit data.

■ Instruction format

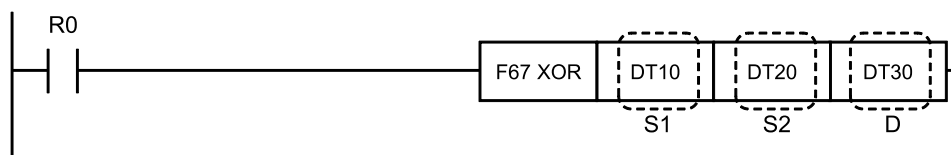

■ Operands

Items	Settings
S1	Data 1: Area storing data on which to perform the logical operation, or constant data
S2	Data 2: Area storing data on which to perform the logical operation, or constant data
D	Storage location: Area storing the operation result

■ Devices that can be specified (indicated by ●)

Operands	WX	WY	WR	WL	SV	EV	DT	LD	I	SWR	SDT	Constant				Index modifier	Integer Device
												K	H	M	f		
S1	●	●	●	●	●	●	●	●	●	●	●	●	●	●	●	●	
S2	●	●	●	●	●	●	●	●	●	●	●	●	●	●	●	●	
D		●	●	●	●	●	●	●	●							●	

■ Outline of operation

- An exclusive OR is performed on each bit of the contents of the area specified by [S1] and the contents of the area specified by [S2], and the results are stored in the area specified by [D].

$$\{(S1) \wedge (S2)\} \vee \{(S1) \wedge (S2)\} \rightarrow (D)$$

- This can be used to detect bits whose ON/OFF status does not match.
- When the values of [S1] and [S2] are the same, all the bits in the data specified by [D] become 0.

■ Operation example

Operation of instruction format description program

When internal relay R0 turns ON, an exclusive OR is performed on each bit of the contents of data register DT10 and the contents of data register DT20, and the result is stored in data register DT30.

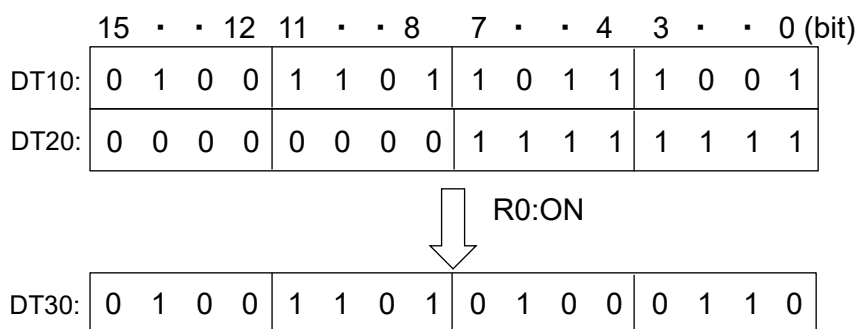

■ Exclusive OR (XOR)

S1 bit	S2 bit	Exclusive OR
0	0	0
0	1	1
1	0	1
1	1	0

■ Flag operations

Name	Description
R9007 R9008 (ER)	Turns ON when the area is exceeded in index modification.
R900B (=)	Turns ON when the calculation result is "0"

14.4 F68 XNR (16-bit Data Exclusive NOR)

14.4 F68 XNR (16-bit Data Exclusive NOR)

Calculates the exclusive NOR of 16-bit data.

■ Instruction format

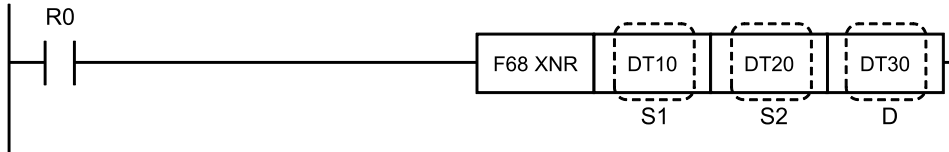

■ Operands

Items	Settings
S1	Data 1: Area storing data on which to perform the logical operation, or constant data
S2	Data 2: Area storing data on which to perform the logical operation, or constant data
D	Storage location: Area storing the operation result

■ Devices that can be specified (indicated by ●)

Operands	WX	WY	WR	WL	SV	EV	DT	LD	I	SWR	SDT	Constant				Index modifier	Integer Device
												K	H	M	f		
S1	●	●	●	●	●	●	●	●	●	●	●	●	●	●	●	●	
S2	●	●	●	●	●	●	●	●	●	●	●	●	●	●	●	●	
D		●	●	●	●	●	●	●	●							●	

■ Outline of operation

- An exclusive NOR is performed on each bit of the contents of the area specified by [S1] and the contents of the area specified by [S2], and the results are stored in the area specified by [D].

$$\{(S1) \wedge (S2)\} \vee \{(S1) \wedge (S2)\} \rightarrow (D)$$

- This can be used to detect bits with matching ON/OFF status.
- When the values of [S1] and [S2] are the same, all the bits in the data specified by [D] become 1.

■ Operation example

Operation of instruction format description program

When internal relay R0 turns ON, if the values of the bits in the same positions in data registers DT10 and DT20 are equal, the bits in the same positions in data register DT30 turn ON (1). If they are not equal, they turn OFF (0).

14.4 F68 XNR (16-bit Data Exclusive NOR)

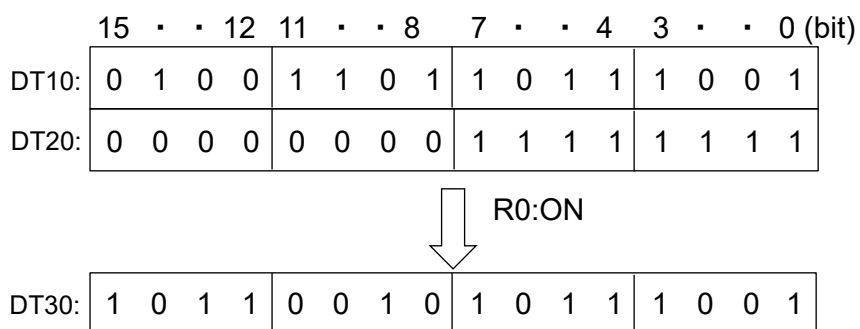

■ Exclusive NOR (XNR)

S1 bit	S2 bit	Exclusive NOR
0	0	1
0	1	0
1	0	0
1	1	1

■ Flag operations

Name	Description
R9007 R9008 (ER)	Turns ON when the area is exceeded in index modification.
R900B (=)	Turns ON when the calculation result is "0"

14.5 F69 WUNI [(S1 AND S3) OR (S2 AND S3) = D] (16-bit)

14.5 F69 WUNI [(S1 AND S3) OR (S2 AND S3) = D] (16-bit)

Combines two sets of word data.

■ Instruction format

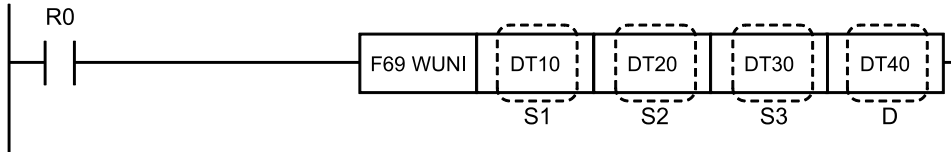

■ Operands

Items	Settings
S1	Area storing data to be combined, or constant data
S2	Area storing data to be combined, or constant data
S3	Area storing mask data for combining, or constant data
D	Area that stores operation results

■ Devices that can be specified (indicated by ●)

Operands	WX	WY	WR	WL	SV	EV	DT	LD	I	SWR	SDT	Constant				Index modifier	Integer Device
												K	H	M	f		
S1	●	●	●	●	●	●	●	●	●	●	●	●	●	●	●		
S2	●	●	●	●	●	●	●	●	●	●	●	●	●	●	●		
S3	●	●	●	●	●	●	●	●	●	●	●	●	●	●	●		
D		●	●	●	●	●	●	●	●						●		

■ Outline of operation

- Using the mask data specified by [S3], the two sets of word data specified by [S1] and [S2] are combined in bit units, and stored in the area specified by [D].

$[(S1 \text{ AND } S3) \text{ OR } (S2 \text{ AND } S3)] \rightarrow [D]$

When [S3] is H0, [S2] is stored in [D]

When [S3] is HFFFF, [S1] is stored in [D].

■ Operation example

Operation of instruction format description program

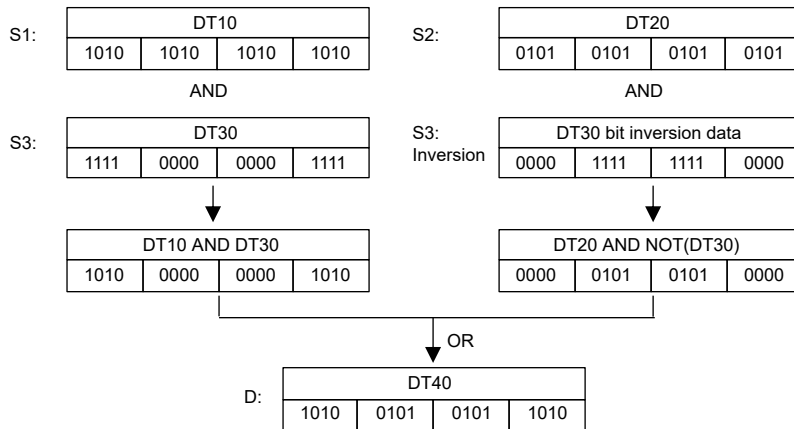

■ Flag operations

Name	Description
R9007 R9008 (ER)	Turns ON when the area is exceeded in index modification.
R900B (=)	Turns ON when the calculation result is "0"

14.6 F215 DAND (32-bit Data AND)

14.6 F215 DAND (32-bit Data AND)

Calculates logical conjunction of double word data.

■ Instruction format

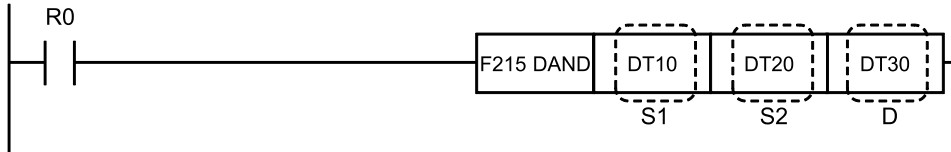

■ Operands

Items	Settings
S1	Area storing the data on which OR operations will be performed, or constant data (two words)
S2	Area storing the data on which OR operations will be performed, or constant data (two words)
D	Storage destination: Area that stores calculation results (two words)

■ Devices that can be specified (indicated by ●)

Operands	WX	WY	WR	WL	SV	EV	DT	LD	I	SWR	SDT	Constant				Index modifier	Integer Device
												K	H	M	f		
S1	●	●	●	●	●	●	●	●	●	●	●	●	●	●	●	●	
S2	●	●	●	●	●	●	●	●	●	●	●	●	●	●	●	●	
D		●	●	●	●	●	●	●	●							●	

■ Outline of operation

- Takes the logical conjunction for each bit of the double word data specified by [S1, S1+1] and the double word data specified by [S2, S2+2], and stores the results in [D, D+1].

■ Operation example

Operation of instruction format description program

	15		0													
DT10	1	0	0	1	0	1	1	0	0	0	1	0	0	0	1	
DT11	1	1	0	0	0	1	1	0	1	0	1	0	1	0	0	1

Logical conjunction

	15		0													
DT20	1	1	1	1	1	1	1	1	0	0	0	0	0	0	0	0
DT21	0	0	0	0	0	0	0	0	1	1	1	1	1	1	1	1



	15		0													
DT30	1	0	0	1	0	1	1	0	0	0	0	0	0	0	0	0
DT31	0	0	0	0	0	0	0	0	1	0	1	0	1	0	0	1

■ Flag operations

Name	Description
R9007 R9008 (ER)	Turns ON when the area is exceeded in index modification.
R900B (=)	Turns ON when the calculation result is "0"

14.7 F216 DOR (32-bit Data OR)

14.7 F216 DOR (32-bit Data OR)

Performs OR operations double word data.

■ Instruction format

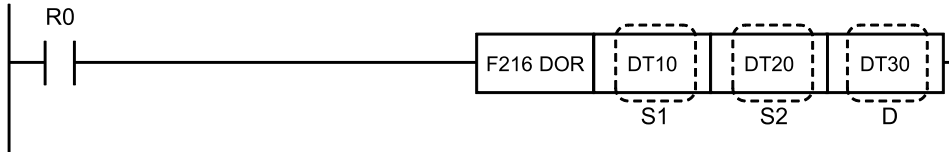

■ Operands

Items	Settings
S1	Area storing the data on which OR operations will be performed, or constant data (two words)
S2	Area storing the data on which OR operations will be performed, or constant data (two words)
D	Storage destination: Area that stores calculation results (two words)

■ Devices that can be specified (indicated by ●)

Operands	WX	WY	WR	WL	SV	EV	DT	LD	I	SWR	SDT	Constant				Index modifier	Integer Device
												K	H	M	f		
S1	●	●	●	●	●	●	●	●	●	●	●	●	●	●	●		
S2	●	●	●	●	●	●	●	●	●	●	●	●	●	●	●		
D		●	●	●	●	●	●	●	●							●	

■ Outline of operation

- Performs OR operation on each bit of the double word data specified by [S1, S1+1] and [S2, S2+1], and stores the results in [D, D+1].

■ Operation example

Operation of instruction format description program

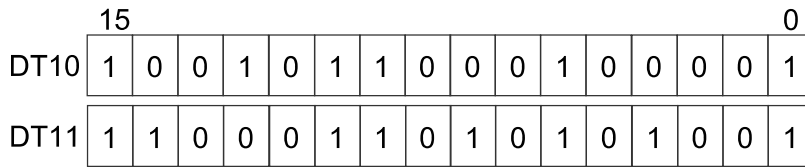

Logical disjunction

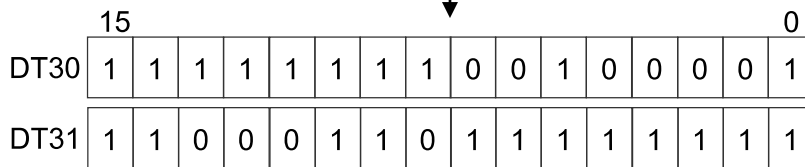
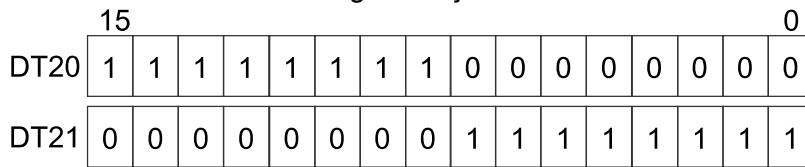

■ Flag operations

Name	Description
R9007 R9008 (ER)	Turns ON when the area is exceeded in index modification.
R900B (=)	Turns ON when the calculation result is"0"

14.8 F217 DXOR (32-bit Data Exclusive OR)

14.8 F217 DXOR (32-bit Data Exclusive OR)

Calculates the exclusive OR of double-word data.

■ Instruction format

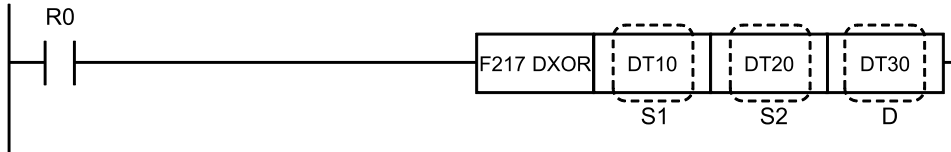

■ Operands

Items	Settings
S1	Area storing the data on which OR operations will be performed, or constant data (two words)
S2	Area storing the data on which OR operations will be performed, or constant data (two words)
D	Storage destination: Area that stores calculation results (two words)

■ Devices that can be specified (indicated by ●)

Operands	WX	WY	WR	WL	SV	EV	DT	LD	I	SWR	SDT	Constant				Index modifier	Integer Device
												K	H	M	f		
S1	●	●	●	●	●	●	●	●	●	●	●	●	●	●	●	●	
S2	●	●	●	●	●	●	●	●	●	●	●	●	●	●	●	●	
D		●	●	●	●	●	●	●	●							●	

■ Outline of operation

- An exclusive OR is performed on each bit of the double-word data specified by [S1, S1+1] and the double-word data specified by [S2, S2+1], and the results are stored in the area specified by [D, D+1].

- This can be used to detect which bits are not the same.

Matching bit = 0

Non-matching bit = 1

■ Operation example

Operation of instruction format description program

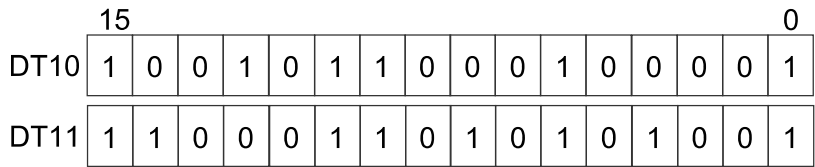

Exclusive OR

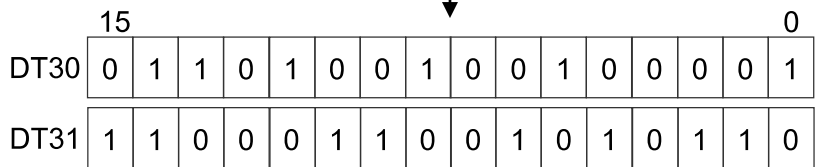
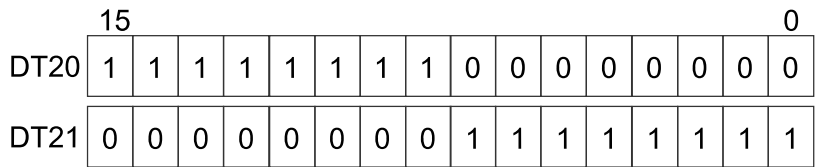

■ Flag operations

Name	Description
R9007 R9008 (ER)	Turns ON when the area is exceeded in index modification.
R900B (=)	Turns ON when the calculation result is "0"

14.9 F218 DXNR (32-bit Data Exclusive NOR)

14.9 F218 DXNR (32-bit Data Exclusive NOR)

Calculates the exclusive NOR of double word data.

■ Instruction format

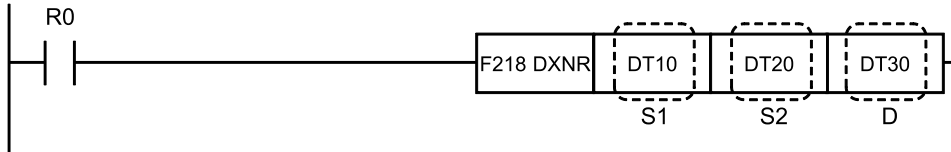

■ Operands

Items	Settings
S1	Area storing the data on which OR operations will be performed, or constant data (two words)
S2	Area storing the data on which OR operations will be performed, or constant data (two words)
D	Storage destination: Area that stores calculation results (two words)

■ Devices that can be specified (indicated by ●)

Operands	WX	WY	WR	WL	SV	EV	DT	LD	I	SWR	SDT	Constant				Index modifier	Integer Device
												K	H	M	f		
S1	●	●	●	●	●	●	●	●	●	●	●	●	●		●		
S2	●	●	●	●	●	●	●	●	●	●	●	●	●		●		
D		●	●	●	●	●	●	●	●						●		

■ Outline of operation

- Retrieves the exclusive NOR of each bit for the double word data specified by [S1, S1+1] and the double word data specified by [S2, S2+1] before storing the result in [D, D+1].
- This can be used to determine whether each bit matches.

Matching bit = 1

Non-matching bit = 0

■ Operation example

Operation of instruction format description program

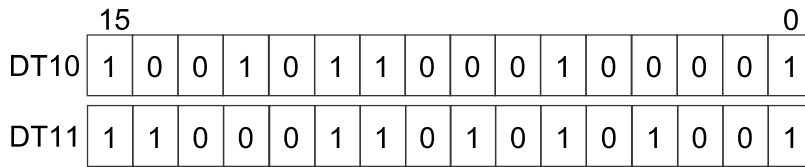

Exclusive NOR

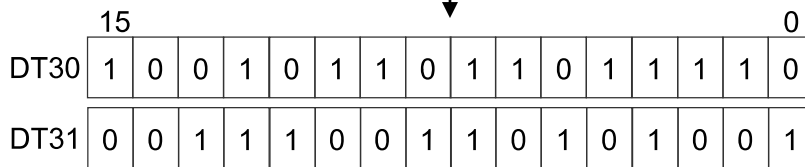
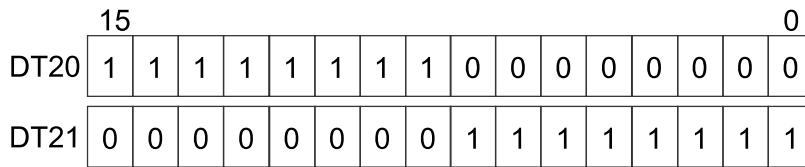

■ Flag operations

Name	Description
R9007 R9008 (ER)	Turns ON when the area is exceeded in index modification.
R900B (=)	Turns ON when the calculation result is "0"

14.10 F219 DUNI [(S1 AND S3) OR (S2 AND S3) = D] (32-bit)

14.10 F219 DUNI [(S1 AND S3) OR (S2 AND S3) = D] (32-bit)

Combines two double words.

■ Instruction format

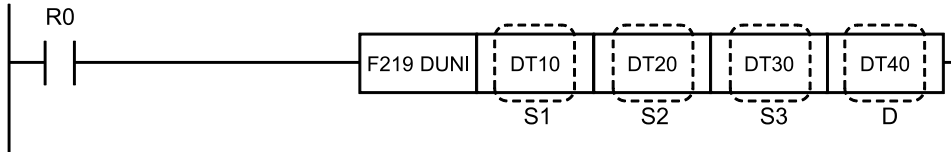

■ Operands

Items	Settings
S1	Area storing the data to be combined, or constant data (two words)
S2	Area storing the data to be combined, or constant data (two words)
S3	Area storing mask data for combination, or constant data (two words)
D	Area storing the operation results (two words)

■ Devices that can be specified (indicated by ●)

Operands	WX	WY	WR	WL	SV	EV	DT	LD	I	SWR	SDT	Constant				Index modifier	Integer Device
												K	H	M	f		
S1	●	●	●	●	●	●	●	●	●	●	●	●	●	●	●		
S2	●	●	●	●	●	●	●	●	●	●	●	●	●	●	●		
S3	●	●	●	●	●	●	●	●	●	●	●	●	●	●	●		
D		●	●	●	●	●	●	●	●						●		

■ Outline of operation

- Using the mask data specified by [S3, S3+1], the two double word data specified by [S1, S1+1] and [S2, S2+1] are combined in bit units and stored in the area specified by [D, D+1].

$$([S1, S1+1] \text{ AND } [S3, S3+1]) \text{ OR } ([S2, S2+1] \text{ AND } [S3, S3+1]) \rightarrow [D, D+1]$$
- If [S3, S3+1] is H0, then [S2, S2+1] → [D, D+1]
- If [S3, S3+1] is HFFFFFFF, then [S1, S1+1] → [D, D+1]

■ Operation example

Operation of instruction format description program

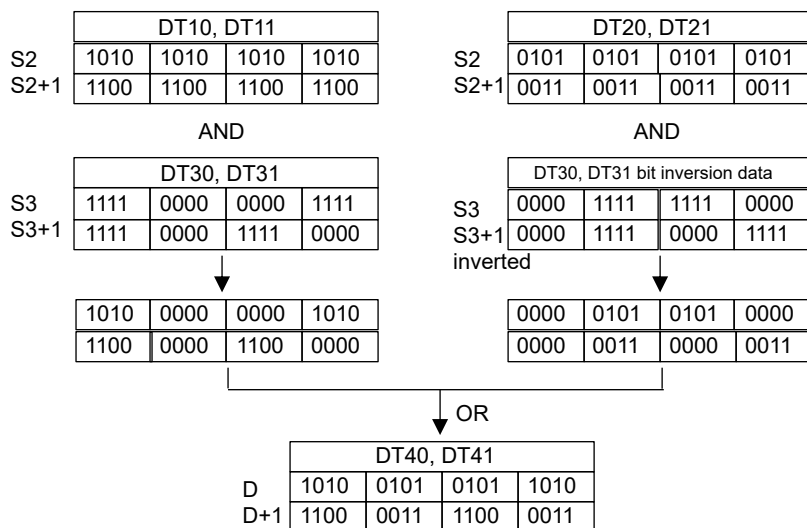

■ Flag operations

Name	Description
R9007 R9008 (ER)	Turns ON when the area is exceeded in index modification.
R900B (=)	
	Turns ON when the calculation result is "0"

(MEMO)

15 Data Conversion Instructions

15.1	F70 BCC [Block Check Code (ADD, SUB, XOR, CRC)].....	15-3
15.2	F71 HEXA (Hexadecimal Data to ASCII Code Conversion)	15-7
15.3	F72 AHEX (ASCII Code to Hexadecimal Data Conversion)	15-10
15.4	F73 BCDA (BCD Data to ASCII Code Conversion)	15-14
15.5	F74 ABCD (ASCII Code to BCD Data Conversion)	15-18
15.6	F75 BINA (16-bit Binary Data to ASCII Code Conversion)	15-22
15.7	F76 ABIN (ASCII Code to 16-bit Binary Data Conversion)	15-25
15.8	F77 DBIA (32-bit Binary Data to ASCII Code Conversion)	15-29
15.9	F78 DABI (ASCII Code to 32-bit Binary Data Conversion)	15-32
15.10	F80 BCD (16-bit Binary Data to BCD Data Conversion).....	15-36
15.11	F81 BIN (BCD Data to 16-bit Binary Data Conversion)	15-38
15.12	F82 DBCD (32-bit Binary Data to BCD Data Conversion)	15-40
15.13	F83 DBIN (BCD Data to 32-bit Binary Data Conversion).....	15-41
15.14	F84 INV (16-bit Data Invert).....	15-42
15.15	F85 NEG (16-bit Data Sign Inversion)	15-43
15.16	F86 DNEG (32-bit Data Sign Inversion).....	15-44
15.17	F87 ABS (Absolute Value of 16-bit Data).....	15-46
15.18	F88 DABS (Absolute Value of 32-bit Data)	15-47
15.19	F89 EXT (Sign Extension)	15-48
15.20	F90 DECO (Decode).....	15-50
15.21	F91 SEGT (7-segment).....	15-53
15.22	F92 ENCO (Encode).....	15-55
15.23	F93 UNIT (Digit Combine)	15-58
15.24	F94 DIST (Digit Distribute).....	15-60
15.25	F96 SRC (16-bit Data Search).....	15-62
15.26	F97 DSRC (32-bit Data Search)	15-64
15.27	F230 TMSEC (Time data to second conversion).....	15-66
15.28	F231 SECTM (Second to Time Data Conversion).....	15-69
15.29	F235 GRY (16-bit Data to Gray Code Conversion)	15-72
15.30	F236 DGRY (32-bit Data to Gray Code Conversion).....	15-73

15 Data Conversion Instructions

- 15.31 F237 GBIN (Gray Code to 16-bit Data Conversion) 15-74
- 15.32 F238 DGBIN (Gray Code to 32-bit Data Conversion)..... 15-75
- 15.33 F240 COLM (Bit Line to Bit Column Conversion) 15-77
- 15.34 F241 LINE (Bit Column to Bit Line Conversion) 15-79

15.1 F70 BCC [Block Check Code (ADD, SUB, XOR, CRC)]

Calculates block check code (BCC).

■ Instruction format

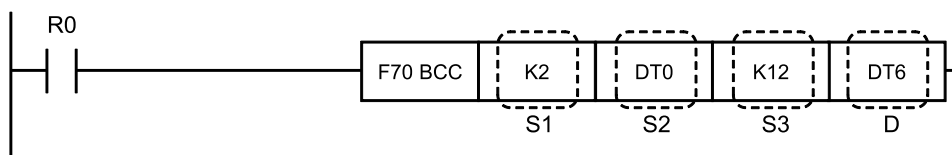

■ Operands

Items	Settings
S1	Area storing data specifying the calculation method, or constant data
S2	Starting address of the area storing target data
S3	Area storing the length (number of bytes) of the target data, or constant data
D	Area that stores operation results

■ Devices that can be specified (indicated by ●)

Operands	WX	WY	WR	WL	SV	EV	DT	LD	I	SWR	SDT	Constant				Index modifier	Integer Device
												K	H	M	f		
S1	●	●	●	●	●	●	●	●	●	●	●	●	●	●	●	●	
S2	●	●	●	●	●	●	●	●		●	●						●
S3	●	●	●	●	●	●	●	●	●	●	●	●	●				●
D		●	●	●	●	●	●	●									●

■ Outline of operation

- Creates block check code (BCC) from the starting position for the calculation specified by S1 and S2 using the calculation method specified by S1, and stores the result at the storage position specified by D and S1 according to the conversion method specified by S1.

15.1 F70 BCC [Block Check Code (ADD, SUB, XOR, CRC)]

Specification of control data [S1]

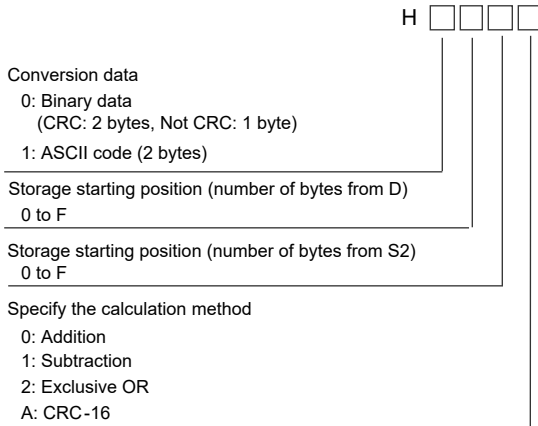

(Note 1) If CRC-16 is specified as the calculation method, ASCII code cannot be specified for the conversion data.

■ Calculation method

If the calculation method specified by [S1] is CRC, the calculation is carried out using the following generator polynomial. (Same calculation method as MODBUS-RTU.)

Generator polynomial: $X^{16}+X^{15}+X^2+1$

■ Operation example

Operation of instruction format description program

When the internal relay R0 turns ON, this calculates the BCC for the 12 bytes of data stored starting from data register DT0, via an exclusive OR operation. The result is stored in the lower byte of DT6.

■ Usage example 1

In this example, the block check code of the message being sent "%01#RCSX0000" is calculated and is added after the message.

- Transmission is performed using ASCII codes.
- BCC is calculated via an exclusive OR.

1. The message should be stored in the memory area as shown below.

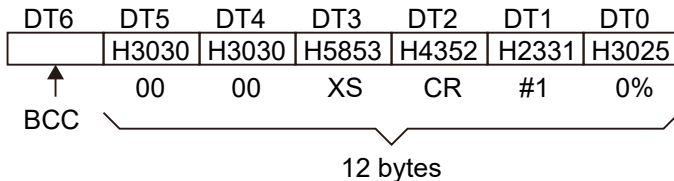

2. The BCC instruction is as shown below.

15.1 F70 BCC [Block Check Code (ADD, SUB, XOR, CRC)]

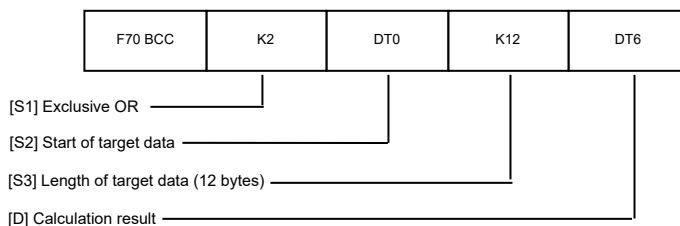

> When this is executed, BCC (H 1D) is stored in the lower byte of DT6 of [D].

- Calculation method

Calculation is performed as shown below. (Explained in Usage example 2.)

% → H25 → 00100101 (a)

0 → H30 → 00110000 (b)

1 → H31 → 00110001 (c)

→ H23 → 00100011 (d)

R → H52 → 01010010 (e)

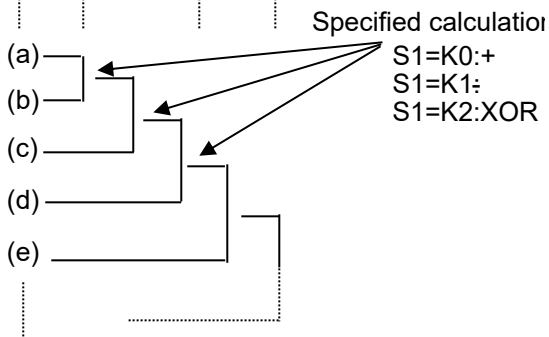

Calculation is performed in the order of carrying out the specified calculation in 8-bit units, and carrying out calculations on that result with the next 8 bits.

■ Usage example 2

In this example the block check code of the message being sent "%01#RCSX0000" is calculated and is added at the end of the message

- Calculation method: addition, conversion data: binary data

DT9	DT8	DT7	DT6	DT5	DT4	DT3	DT2	DT1	DT0
H0000	H0000	H0000	H0000	H3030	H3030	H5853	H4352	H2331	H3025
				00	00	XS	CR	#1	0%

Specification of control data [S1]

DT10 = H0C00

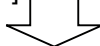

DT9	DT8	DT7	DT6	DT5	DT4	DT3	DT2	DT1	DT0
H0000	H0000	H0000	H00A9	H3030	H3030	H5853	H4352	H2331	H3025
				00	00	XS	CR	#1	0%

- Calculation method: addition, conversion data: ASCII code

15.1 F70 BCC [Block Check Code (ADD, SUB, XOR, CRC)]

DT9	DT8	DT7	DT6	DT5	DT4	DT3	DT2	DT1	DT0
H0000	H0000	H0000	H0000	H3030	H3030	H5853	H4352	H2331	H3025

00 00 XS CR #1 0%

Specification of control data [S1]

DT10 = H1C00

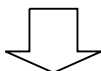

DT9	DT8	DT7	DT6	DT5	DT4	DT3	DT2	DT1	DT0
H0000	H0000	H0000	H3941	H3030	H3030	H5853	H4352	H2331	H3025

9A 00 00 XS CR #1 0%

- Calculation method: addition, conversion data: ASCII code

DT9	DT8	DT7	DT6	DT5	DT4	DT3	DT2	DT1	DT0
H0000	H0000	H0030	H3030	H3058	H5343	H5223	H3130	H2500	H0000

0 00 0X SC R# 10 %

Specification of control data [S1]

DT10 = H1F30

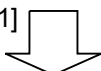

DT9	DT8	DT7	DT6	DT5	DT4	DT3	DT2	DT1	DT0
H0000	H0039	H4130	H3030	H3058	H5343	H5223	H3130	H2500	H0000

9 A0 00 0X SC R# 10 %

- Calculation method: CRC, conversion data: binary data

DT9	DT8	DT7	DT6	DT5	DT4	DT3	DT2	DT1	DT0
H0000	H0000	H0000	H0000	H3030	H3030	H5853	H4352	H2331	H3025

00 00 XS CR #1 0%

Specification of control data [S1]

DT10 = H0C0A

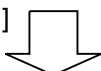

DT9	DT8	DT7	DT6	DT5	DT4	DT3	DT2	DT1	DT0
H0000	H0000	H0000	H2E0A	H3030	H3030	H5853	H4352	H2331	H3025

00 00 XS CR #1 0%

■ Flag operations

Name	Description
R9007	When the calculation method specified by S1 is outside the specified range
R9008 (ER)	When the conversion data specified by S1 is outside the specified range

15.2 F71 HEXA (Hexadecimal Data to ASCII Code Conversion)

Converts hexadecimal numeric values to ASCII code.

■ **Instruction format**

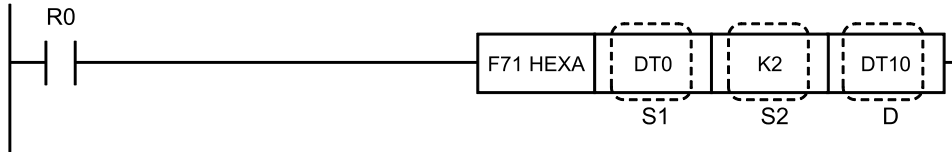

■ **Operands**

Items	Settings
S1	Starting number for the area storing the hexadecimal numeric values
S2	Area storing the length of the numeric value (number of bytes) to be converted, or constant data
D	Starting number of the area storing the ASCII code of conversion result

■ **Devices that can be specified (indicated by ●)**

Operands	WX	WY	WR	WL	SV	EV	DT	LD	I	SW R	SD T	Constant				Index modifier	Integer Device
												K	H	M	f		
S1	●	●	●	●	●	●	●	●		●	●					●	
S2	●	●	●	●	●	●	●	●	●	●	●	●	●			●	
D		●	●	●	●	●	●	●								●	

■ **Outline of operation**

- The hexadecimal numeric data stored in the area specified by [S1] is converted to ASCII codes and stored in the area specified by [D].
- [S2] specifies the number of data bytes to be converted.
- The amount of the result (ASCII code) is twice the converted data.

■ **Operation example**

Operation of instruction format description program

When internal relay R0 turns ON, the hexadecimal numeric data stored in data register DT0 (two bytes) is converted to ASCII codes and stored in DT10 and DT11.

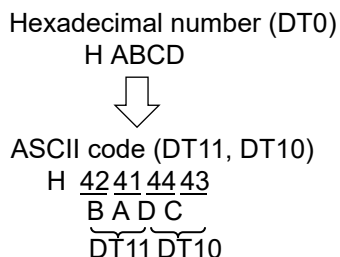

15.2 F71 HEXA (Hexadecimal Data to ASCII Code Conversion)

■ Precautions for programming

1. The two characters that make up one byte are interchanged when stored.
2. Converts two bytes as one section.

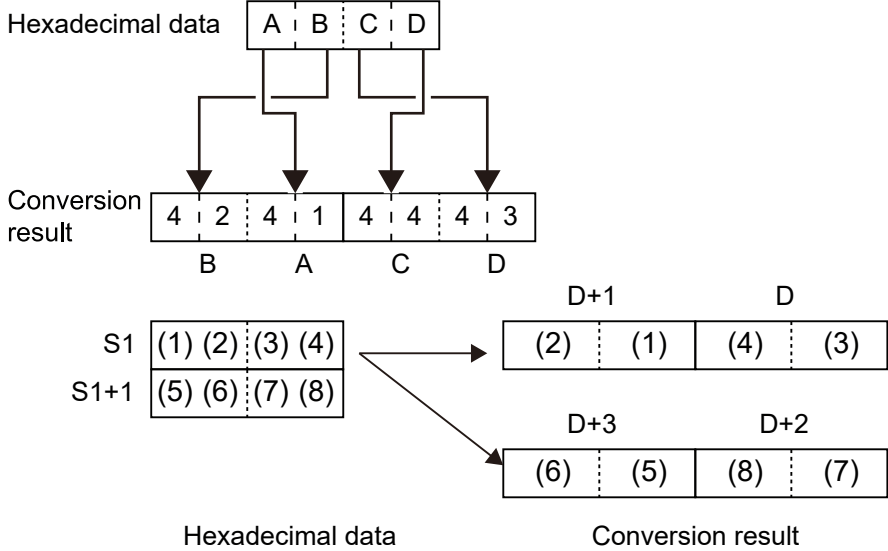

■ Conversion example

The following shows the conversion of hexadecimal number data to ASCII code.

Conversion of 4 bytes (S2 = K4)

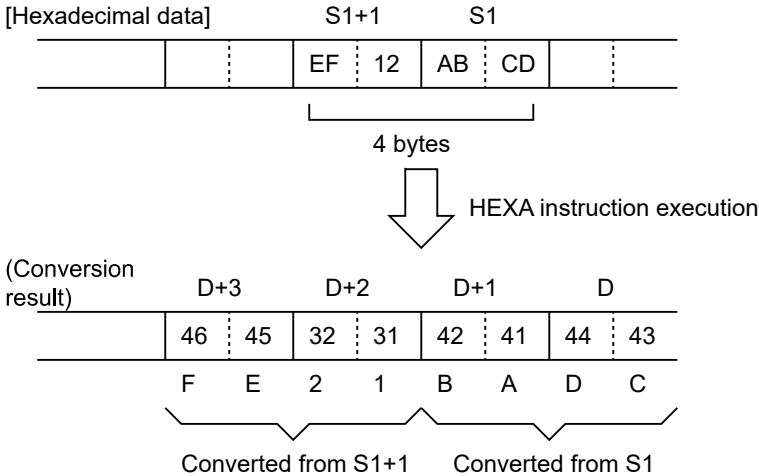

Conversion of 3 bytes (S2 = K3)

Since the data to be converted is specified in byte units, it is also possible to convert only the low byte of one-word data.

15.2 F71 HEXA (Hexadecimal Data to ASCII Code Conversion)

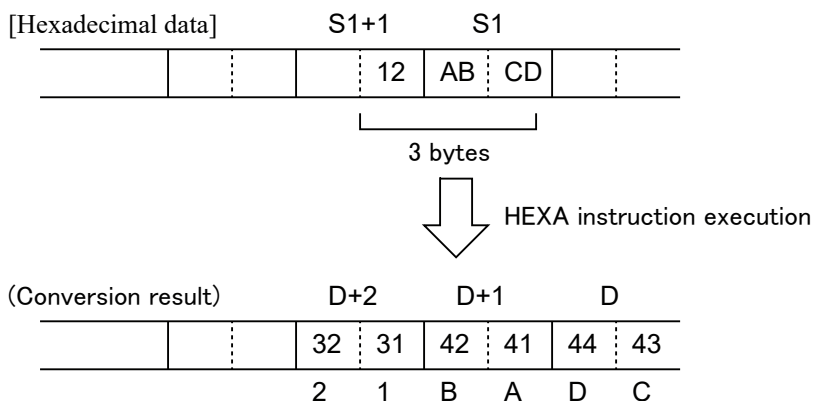

■ Reference: ASCII code

		Higher	
		3	4
Lower	0	0	@
	1	1	A
	2	2	B
	3	3	C
	4	4	D
	5	5	E
	6	6	F
	7	7	G
	8	8	H
	9	9	I

■ Flag operations

Name	Description
R9007 R9008 (ER)	Turns ON when the area is exceeded in index modification.
	Turns ON when the conversion range of the number of bytes specified by [S2] exceeds the area
	Turns ON when the conversion result exceeds the area
	Turns ON when the [S2] specification is "0"

15.3 F72 AHEX (ASCII Code to Hexadecimal Data Conversion)

15.3 F72 AHEX (ASCII Code to Hexadecimal Data Conversion)

Converts character strings in ASCII code to hexadecimal numbers.

■ Instruction format

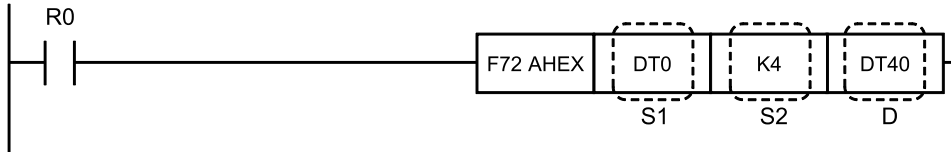

■ Operands

Items	Settings
S1	Starting number of the area storing the ASCII code
S2	Area storing the number of ASCII codes (number of characters) to be converted, or constant data
D	Number of the start of the area storing the hexadecimal number that is the result of conversion

■ Devices that can be specified (indicated by ●)

Operands	WX	WY	WR	WL	SV	EV	DT	LD	I	SW R	SD T	Constant				Index modifier	Integer Device
												K	H	M	f		
S1	●	●	●	●	●	●	●	●		●	●					●	
S2	●	●	●	●	●	●	●	●	●	●	●	●	●			●	
D		●	●	●	●	●	●	●								●	

■ Outline of operation

- The ASCII codes stored in the area specified by [S1] are converted into hexadecimal numeric data and stored in the area specified by [D].
- The number of ASCII codes (number of characters) to be converted is specified by [S2].
- The volume of the result (hexadecimal numeric data) is half that of the converted ASCII codes.

■ Operation example

Operation of instruction format description program

When the internal relay R0 turns ON, the ASCII codes stored in data registers DT0 and DT1 (four characters) are converted into hexadecimal numeric data and stored in DT40.

15.3 F72 AHX (ASCII Code to Hexadecimal Data Conversion)

ASCII code (DT1, DT0)

H 44 43 42 41
 D C B A
 DT1 DT0



Value in hexadecimal (DT40)
 H CDAB

■ Precautions for programming

1. Two ASCII code characters are converted into two 1-byte numeric digits. At this time, the upper and lower characters are interchanged.
2. Four characters are converted as one segment of data.

ASCII code string

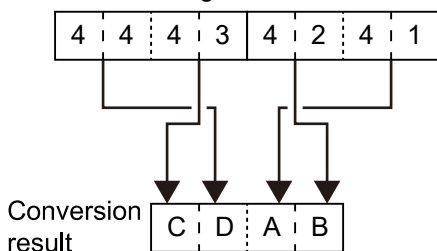

■ Conversion example

- ASCII codes are converted into hexadecimal data as shown below.

Conversion of eight characters (S2 = K8)

[ASCII code]

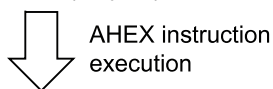
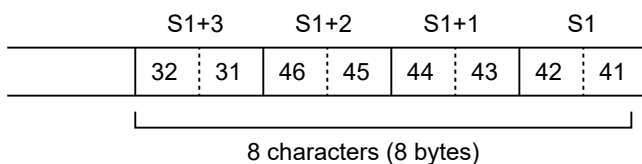

(Conversion result)

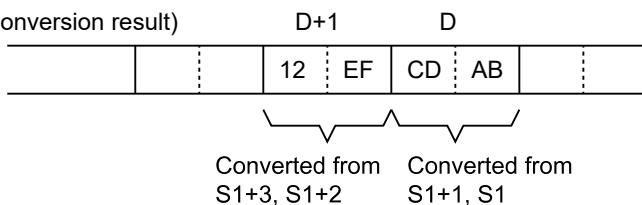

15.3 F72 AHX (ASCII Code to Hexadecimal Data Conversion)

Conversion of seven characters (S2 = K7)

[ASCII code]

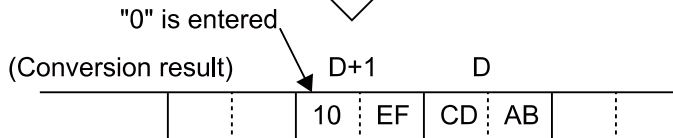
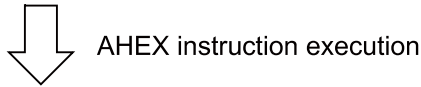
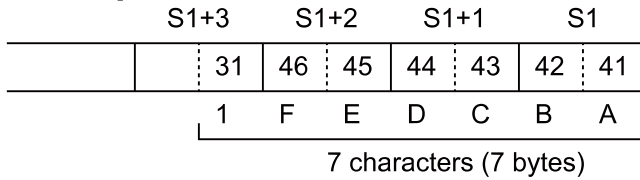

Conversion of six characters (S2 = K6)

[ASCII code]

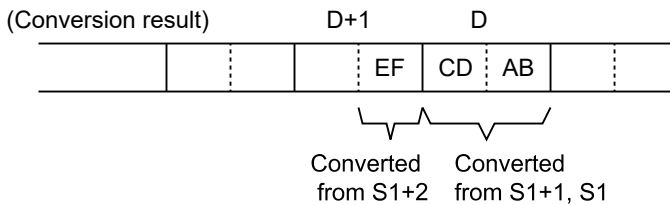
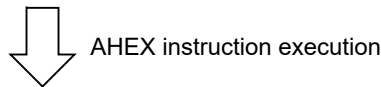
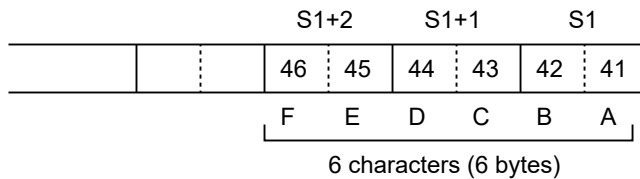

(Note 1) In the conversion results, only the data for the low byte is stored in the D+1 word. The data for the high byte is left as it is and does not change.

- The conversion results are stored in byte units. If an odd number of characters is being converted, bits 0 to 3 of the final data (byte) of the conversion results will be filled with "0".

15.3 F72 AHX (ASCII Code to Hexadecimal Data Conversion)

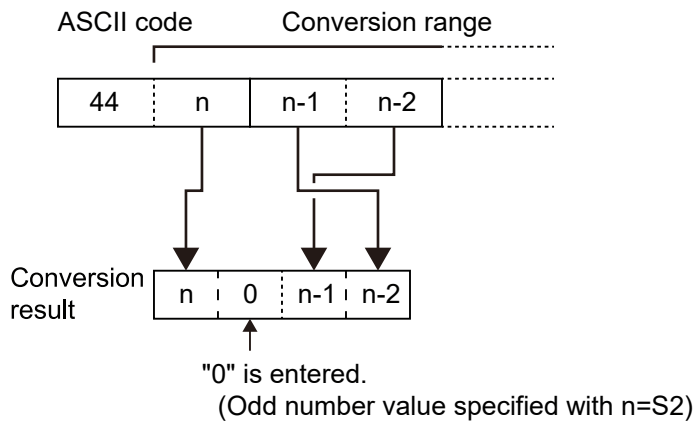

■ Reference: ASCII code

		Higher	
		3	4
Lower	0	0	@
	1	1	A
	2	2	B
	3	3	C
	4	4	D
	5	5	E
	6	6	F
	7	7	G
	8	8	H
	9	9	I

■ Flag operations

Name	Description
R9007 R9008 (ER)	Turns ON when the area is exceeded in index modification.
	Turns ON when the conversion range of the number of bytes specified by [S2] exceeds the area
	Turns ON when the conversion result exceeds the area
	Turns ON when the [S2] specification is "0"
	Turns ON when there is a character code other than 0 to F in the ASCII codes specified by [S1]

15.4 F73 BCDA (BCD Data to ASCII Code Conversion)

15.4 F73 BCDA (BCD Data to ASCII Code Conversion)

Converts up to eight digits of BCD data to ASCII code character strings.

■ Instruction format

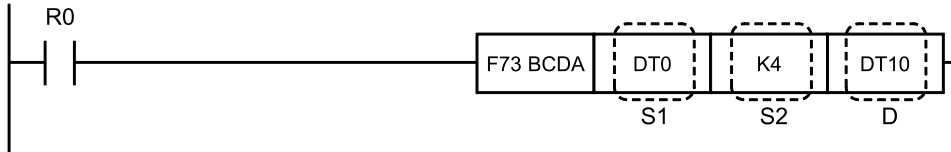

■ Operands

Items	Settings
S1	Starting number of the area storing the BCD numerical value
S2	Area storing data indicating the amount and direction of data to be converted, or constant data
D	Starting number of the area storing the ASCII code of conversion result

■ Devices that can be specified (indicated by ●)

Operands	WX	WY	WR	WL	SV	EV	DT	LD	I	SWR	SDT	Constant				Index modifier	Integer Device
												K	H	M	f		
S1	●	●	●	●	●	●	●	●		●	●					●	
S2	●	●	●	●	●	●	●	●	●	●	●	●	●			●	
D		●	●	●	●	●	●	●								●	

■ Outline of operation

- The BCD data stored in the area specified by [S1] is converted to ASCII code and stored in the area specified by [D]. Up to four bytes (8 digits) can be converted.
- The amount (number of bytes) of BCD data to be converted and the conversion direction is specified by [S2].
- The amount of the conversion result (ASCII code) is twice the converted data.

■ Setting the conversion data amount and conversion direction [S2]

Specify a 4-digit BCD (H constant) according to the following format.

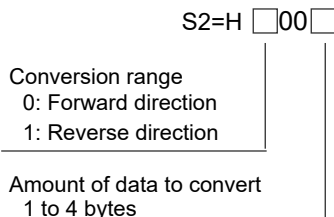

- Since the amount of data to be converted is specified in bytes, it is also possible to convert only the low byte of one word data.
- Refer to the example for a description of the conversion direction.

■ Precautions for programming

- The two characters that make up one byte are interchanged when stored.
- Converts two bytes as one section.

Forward direction

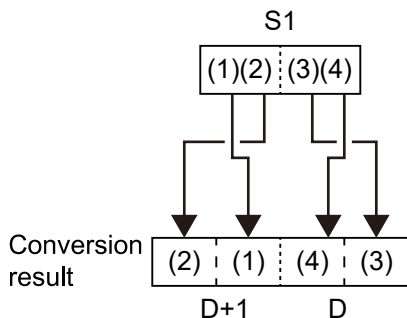

Reverse direction

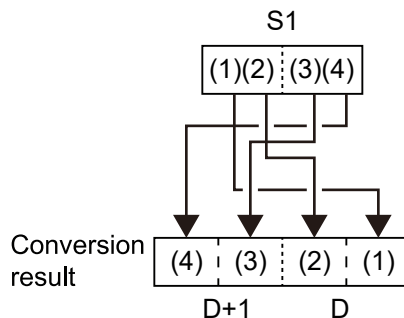

<Example>

When internal relay R0 turns ON, the BCD data stored in data register DT0 is converted to ASCII code and stored in DT10.

1. When S2 = H2 (forward direction, 2-byte conversion)

```

BCD data (DT0)
H 1234
  ↓
ASCII code (DT11, DT10)
H 32313433
  2 1 4 3
  DT11 DT10
    
```

2. When S2 = H1002 (reverse direction, 2-byte conversion)

```

BCD data (DT0)
H 1234
  ↓
ASCII code (DT11, DT10)
H 34333231
  4 3 2 1
  DT11 DT10
    
```

■ Conversion example

For the above program

The conversion from BCD data to ASCII code is performed as shown below.

15.4 F73 BCDA (BCD Data to ASCII Code Conversion)

Forward conversion of four bytes (S2 = H0004)

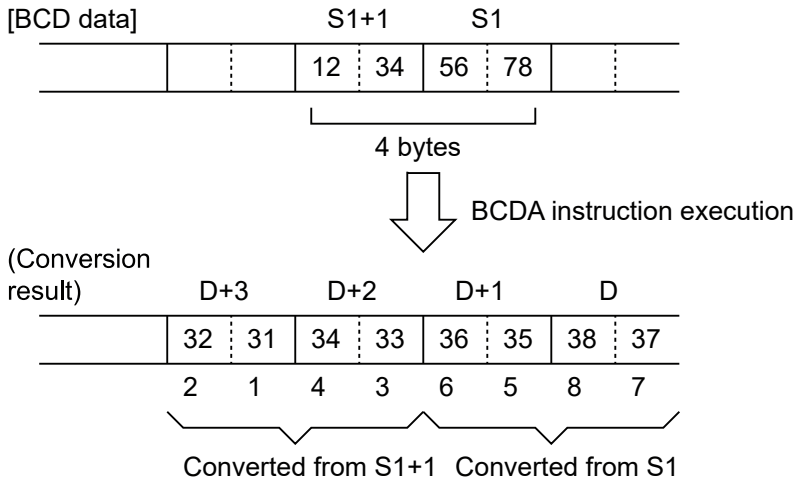

Reverse conversion of four bytes (S2 = H1004)

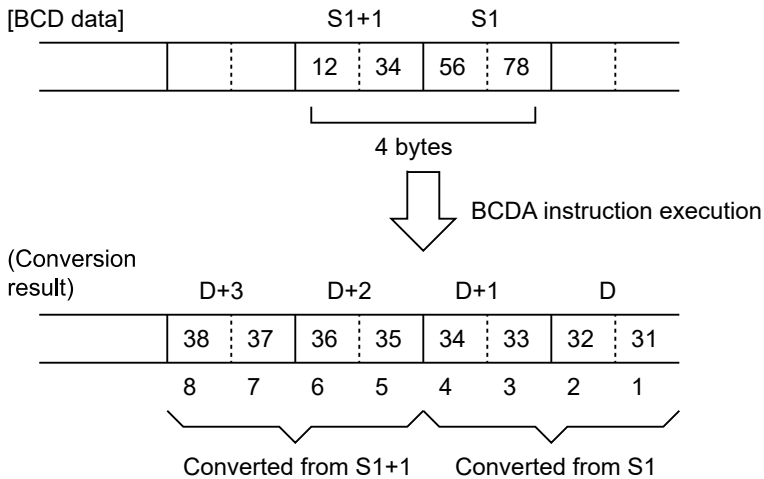

■ Reference: ASCII code

		Higher
		3
Lower	0	0
	1	1
	2	2
	3	3
	4	4
	5	5
	6	6
	7	7

15.4 F73 BCDA (BCD Data to ASCII Code Conversion)

		Higher
		3
	8	8
	9	9

■ Flag operations

Name	Description
R9007 R9008 (ER)	Turns ON when the area is exceeded in index modification.
	Turns ON when there is data other than BCD in the data starting with [S1]
	Turns ON when the number of bytes specified by [S2] exceeds the area of [S1]
	Turns ON when the conversion result exceeds the area
	Turns ON when the number of bytes specified by [S2] is "0"
	Turns ON when the number of bytes specified by [S2] is greater than four

15.5 F74 ABCD (ASCII Code to BCD Data Conversion)

15.5 F74 ABCD (ASCII Code to BCD Data Conversion)

Converts an ASCII character string to 4-digit BCD data.

■ Instruction format

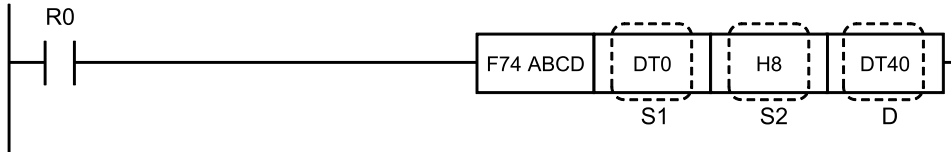

■ Operands

Items	Settings
S1	Starting number of the area storing the ASCII code
S2	Area storing data indicating the number of ASCII codes and direction of data to be converted, or constant data
D	Number of the start of the area storing the BCD value that is the result of conversion

■ Devices that can be specified (indicated by ●)

Operands	WX	WY	WR	WL	SV	EV	DT	LD	I	SWR	SDT	Constant				Index modifier	Integer Device
												K	H	M	f		
S1	●	●	●	●	●	●	●	●		●	●					●	
S2	●	●	●	●	●	●	●	●	●	●	●	●	●			●	
D		●	●	●	●	●	●	●								●	

■ Outline of operation

- The ASCII codes that are stored in the area starting from the number specified by [S1] are converted into BCD data and stored in the area starting from the number specified by [D]. A maximum of eight characters can be converted.
- The number of ASCII codes (number of characters) to be converted and the conversion direction are specified by [S2].
- The conversion result (BCD data) is half the volume of the converted ASCII code strings.

■ Specification of number of characters to be converted and conversion direction [S2]

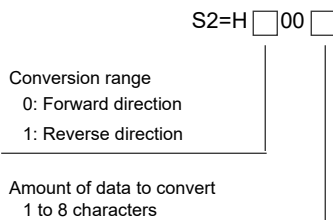

■ Precautions for programming

- Two ASCII code characters are converted into 1-byte numeric values (two digits). At this time, the upper and lower characters are interchanged.
- Four characters are stored as one segment of data.
- The conversion results are stored in byte units. If an odd number of characters is being converted, the conversion result is as follows.
 - i) Bits 0 to 3 of the final data are filled with "0". (In the forward direction)
 - ii) Bits 4 to 7 of the final data are filled with "0". (In the reverse direction)

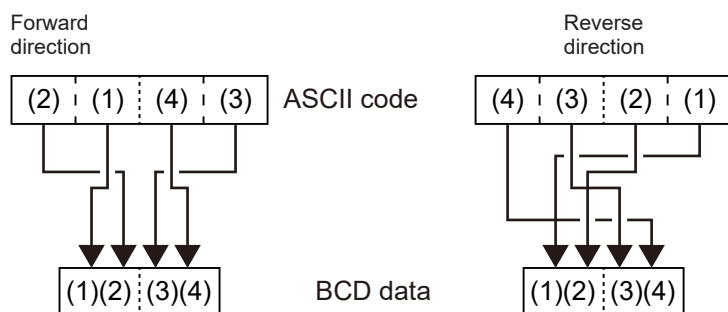

<Example>

When internal relay R0 turns ON, the ASCII codes stored in data registers starting from DT0 are converted to BCD numeric data and stored in DT40.

1. When S2 = H4 (forward direction, 4-byte conversion)

ASCII code (DT1, DT0)

H 34 33 32 31
 4 3 2 1
 DT1 DT0



BCD data (DT40)

H 3412

2. When S2 = H1004 (reverse direction, 4-byte conversion)

ASCII code (DT1, DT0)

H 34 33 32 31
 4 3 2 1
 DT1 DT0



BCD data (DT40)

H 1234

■ Conversion example

For the above program

ASCII codes are converted into BCD data as shown below.

15.5 F74 ABCD (ASCII Code to BCD Data Conversion)

Conversion of eight characters (S2 = H0008)

[ASCII code]

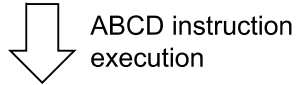
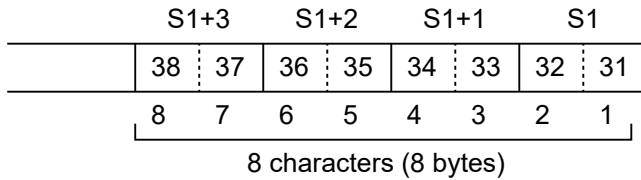

(Conversion result)

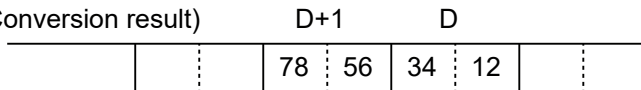

Conversion of seven characters (S2 = H1007)

[ASCII code]

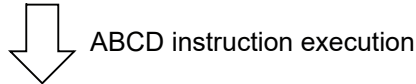
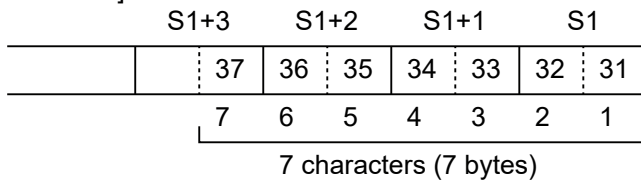

"0" is entered

(Conversion result)

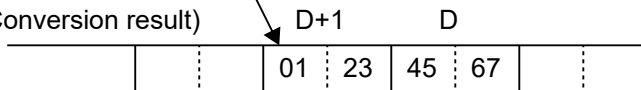

■ Reference: ASCII code

		Higher
		3
Lower	0	0
	1	1
	2	2
	3	3
	4	4
	5	5
	6	6
	7	7
	8	8
	9	9

■ Flag operations

Name	Description
R9007 R9008 (ER)	Turns ON when the area is exceeded in index modification.
	Turns ON when there is a character code other than 0 to 9 in the ASCII codes specified by [S1]
	Turns ON when the number of characters specified by [S2] exceeds the area of [S1]
	Turns ON when the conversion result exceeds the area
	Turns ON when the number of characters specified by [S2] is "0"
	Turns ON when the number of characters specified by [S2] is greater than 8

15.6 F75 BINA (16-bit Binary Data to ASCII Code Conversion)

15.6 F75 BINA (16-bit Binary Data to ASCII Code Conversion)

Converts 16-bit BIN data expressing a decimal number to an ASCII code character string.

■ Instruction format

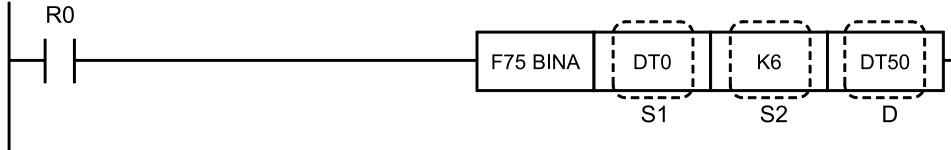

■ Operands

Items	Settings
S1	Area storing the hexadecimal data or constant data
S2	Area storing the number of bytes of the area storing the conversion results, or constant data
D	Starting number of the area storing the ASCII code of conversion result

■ Devices that can be specified (indicated by ●)

Operands	WX	WY	WR	WL	SV	EV	DT	LD	I	SWR	SDT	Constant				Index modifier	Integer Device
												K	H	M	f		
S1	●	●	●	●	●	●	●	●	●	●	●	●	●	●	●	●	
S2	●	●	●	●	●	●	●	●	●	●	●	●	●	●	●	●	
D		●	●	●	●	●	●	●							●		

■ Outline of operation

- The 16-bit data expressing a decimal number specified by [S1] is converted to ASCII code. The ASCII code is stored in the area specified by [D]. The start of the storage area is specified by [D] and its size is specified by [S2].
- Specify the number of bytes in [S2] as a decimal number. (This specification cannot be made with BCD data.)

■ Operation example

Operation of instruction format description program

When internal relay R0 is ON, the 16-bit data (expressing a decimal number) stored in data register DT0 is converted to ASCII code and stored in DT50 to DT52 (six bytes).

DT0: K-100 (H FF9C)



DT52~DT50: H 30 30 31 2D 20 20
 0 0 1 -
 DT52 DT51 DT50

15.6 F75 BINA (16-bit Binary Data to ASCII Code Conversion)

■ Precautions for programming

- If the conversion target is a positive number, a sign code (+) is not added in front of the numeric data.
- If the conversion target is a negative number, a sign code (-: H2D) is added in front of the numeric data.
- Any remaining storage area is filled with spaces (H20).
- The position of the ASCII code may change depending on the size of the storage area as data is filled in the direction of the final address.

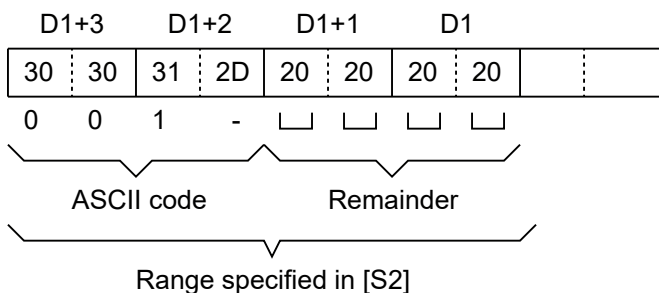

- An operation error occurs if the number of bytes of ASCII codes following conversion (including the minus sign) is larger than the number of bytes specified by S2. When specifying S2, make sure the number of digits to be converted including the sign is taken into consideration.

■ Conversion example

The conversion from a 16-bit decimal number to ASCII code is performed as follows.

When converting a negative number

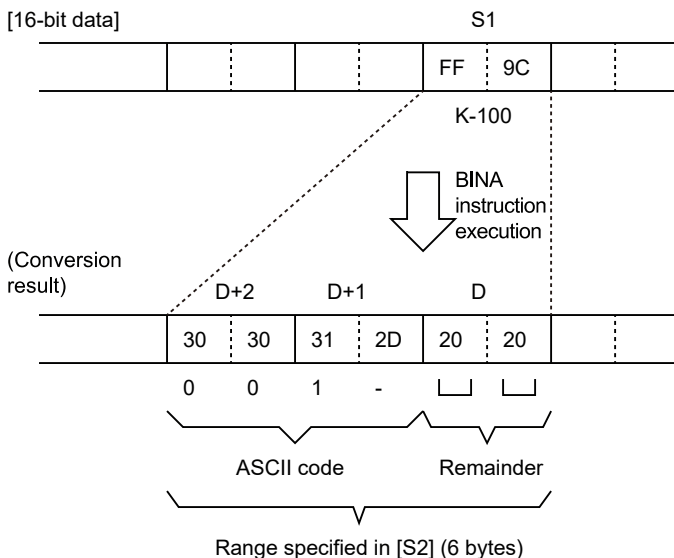

15.6 F75 BINA (16-bit Binary Data to ASCII Code Conversion)

When converting a positive number

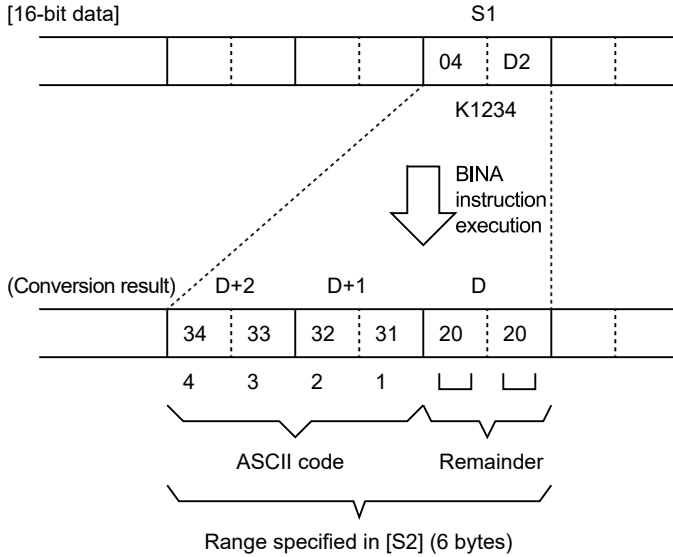

■ Reference: ASCII code

		Higher
		3
Lower	0	0
	1	1
	2	2
	3	3
	4	4
	5	5
	6	6
	7	7
	8	8
	9	9

■ Flag operations

Name	Description
R9007 R9008 (ER)	Turns ON when the area is exceeded in index modification.
	Turns ON when the number of bytes specified by [S2] exceeds the area specified by [D]
	Turns ON when the number of bytes specified by [S2] is "0"
	Turns ON when the conversion result exceeds the area
	Turns ON when the number of bytes of the conversion result exceeds the number of bytes specified by [S2]

15.7 F76 ABIN (ASCII Code to 16-bit Binary Data Conversion)

Converts an ASCII code character string expressing a decimal number to 16-bit BIN data.

■ Instruction format

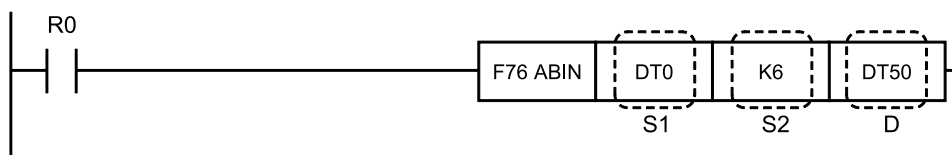

■ Operands

Items	Settings
S1	Starting number of the area storing the ASCII code to be converted
S2	Area storing the number of bytes of data to be converted, or constant data
D	Area to store the conversion result

■ Devices that can be specified (indicated by ●)

Operands	WX	WY	WR	WL	SV	EV	DT	LD	I	SWR	SDT	Constant				Index modifier	Integer Device
												K	H	M	f		
S1	●	●	●	●	●	●	●	●		●	●					●	
S2	●	●	●	●	●	●	●	●	●	●	●	●	●			●	
D		●	●	●	●	●	●	●								●	

■ Outline of operation

- The ASCII code expressing a decimal value of the number of bytes (number of characters) specified by [S2] starting from the area specified by [S1] is converted to a decimal value (16-bit K constant). The decimal value is stored in the area specified by [D].
- Specify the number of bytes in [S2] as a decimal number. (This specification cannot be made with BCD data.)

■ Operation example

Operation of instruction format description program

When internal relay R0 turns ON, the ASCII code stored in data registers DT0 to DT2 (6 bytes) is converted to a decimal number (16-bit data), and stored in DT50.

ASCII code (DT2 to DT0)

H 30 30 31 2D 30 30
 0 0 1 -
 DT2 DT1 DT0



16-bit data (DT50)
 K-100

15.7 F76 ABIN (ASCII Code to 16-bit Binary Data Conversion)

■ Precautions for programming

- Store the ASCII code for conversion in the direction of the final address of the specified area.
- Fill the remaining bytes with "0"(H30) or spaces (H20).
- Signed ASCII codes (+: H2B, -: H2D) are also converted. The + sign can be omitted.

■ Conversion example

Conversion of ASCII code to a 16-bit decimal number is performed as shown below.

Example of conversion of an ASCII code expressing a negative number

[ASCII code]

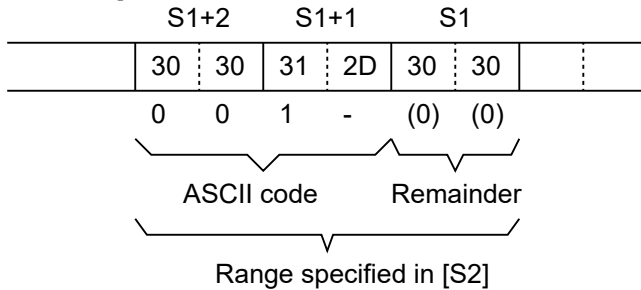

↓ ABIN instruction execution

(Conversion result)

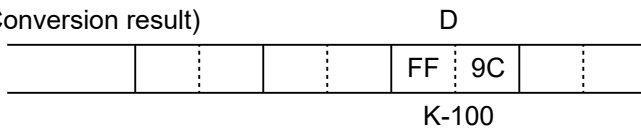

Example of conversion of an ASCII code expressing a positive number

Example (1)

[ASCII code]

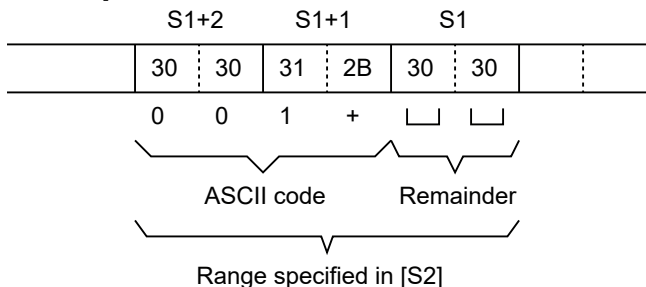

Example (2)

[ASCII code]

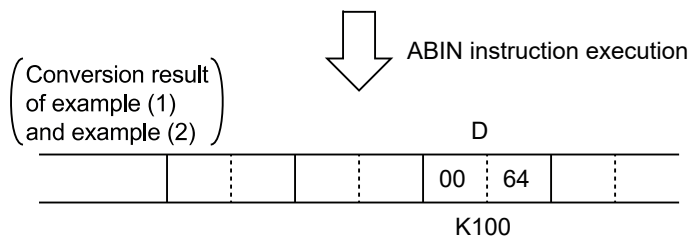
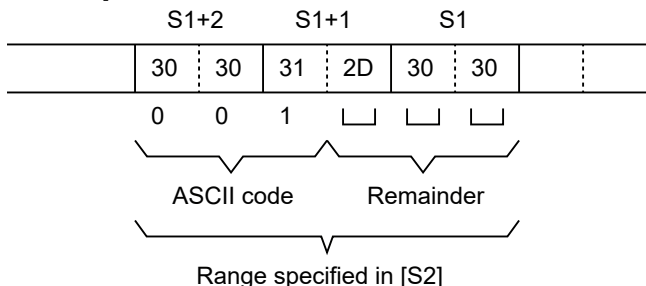

■ Reference: ASCII code

		Higher
		3
Lower	0	0
	1	1
	2	2
	3	3
	4	4
	5	5
	6	6
	7	7
	8	8

15.7 F76 ABIN (ASCII Code to 16-bit Binary Data Conversion)

		Higher
		3
	9	9

■ Flag operations

Name	Description
R9007 R9008 (ER)	Turns ON when the area is exceeded in index modification.
	Turns ON when the number of bytes specified by [S2] exceeds the area of [S1]
	Turns ON when the number of bytes specified by [S2] is "0"
	Turns ON when the conversion result exceeds the area
	Turns ON when the conversion result exceeds 16 bits of data
	Turns ON when an ASCII code containing characters other than the numbers 0 to 9, signed code, or spaces is specified for [S1]

15.8 F77 DBIA (32-bit Binary Data to ASCII Code Conversion)

Converts 32-bit BIN data expressing a decimal number to an ASCII code character string.

■ Instruction format

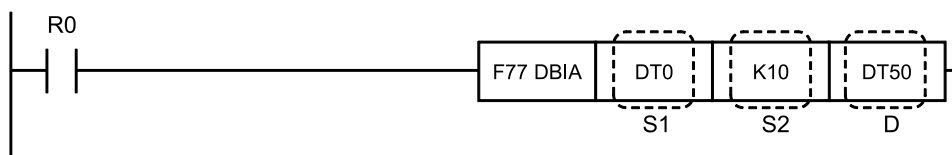

■ Operands

Items	Settings
S1	Starting number of the area storing 32-bit data, or constant data
S2	Area storing the number of bytes of the area storing the conversion results, or constant data
D	Starting number of the area storing the ASCII code of conversion result

■ Devices that can be specified (indicated by ●)

Operands	WX	WY	WR	WL	SV	EV	DT	LD	I	SWR	SDT	Constant				Index modifier	Integer Device
												K	H	M	f		
S1	●	●	●	●	●	●	●	●	●	●	●	●	●	●	●	●	
S2	●	●	●	●	●	●	●	●	●	●	●	●	●	●	●	●	
D		●	●	●	●	●	●	●								●	

■ Outline of operation

- The 32-bit data expressing a decimal number specified by [S1] is converted to ASCII code. The ASCII code is stored in the area starting with the area specified by [D]. The start of the storage area is specified by [D] and the number of bytes is specified by [S2].
- Specify the number of bytes in [S2] as a decimal number (K constant).

■ Operation example

Operation of instruction format description program

When internal relay R0 turns ON, the 32-bit data stored in data registers DT0 and DT1 is converted to ASCII code expressing a decimal number and stored in DT50 to DT54 (10 bytes).

32-bit data (DT0, DT1)

K12345678



ASCII codes DT50 to DT54:

H 38 37 36 35 34 33 32 31 20 20

8 7 6 5 4 3 2 1
 DT54 DT53 DT52 DT51 DT50

15.8 F77 DBIA (32-bit Binary Data to ASCII Code Conversion)

■ Precautions for programming

- If the conversion target is a positive number, a sign code (+) is not added in front of the numeric data.
- If the conversion target is a negative number, a sign code (–: H2D) is added in front of the numeric data.
- Any remaining storage area is filled with spaces (H20).
- The position of the ASCII code may change depending on the size of the storage area as data is filled in the direction of the final address.
- An operation error occurs if the number of bytes of ASCII codes following conversion (including the minus sign) is larger than the number of bytes specified by S2. When specifying S2, make sure the number of digits to be converted including the sign is taken into consideration.

■ Conversion example

The following shows conversion of a 32-bit decimal number to ASCII codes.

When converting a negative number

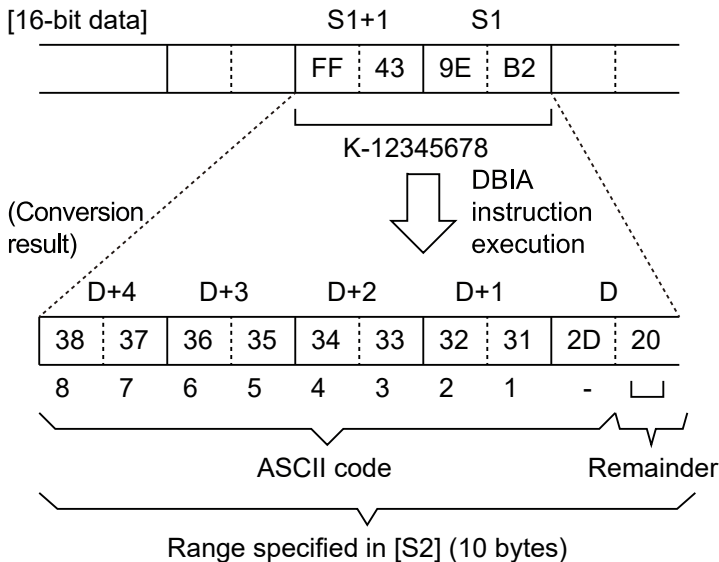

15.8 F77 DBIA (32-bit Binary Data to ASCII Code Conversion)

When converting a positive number

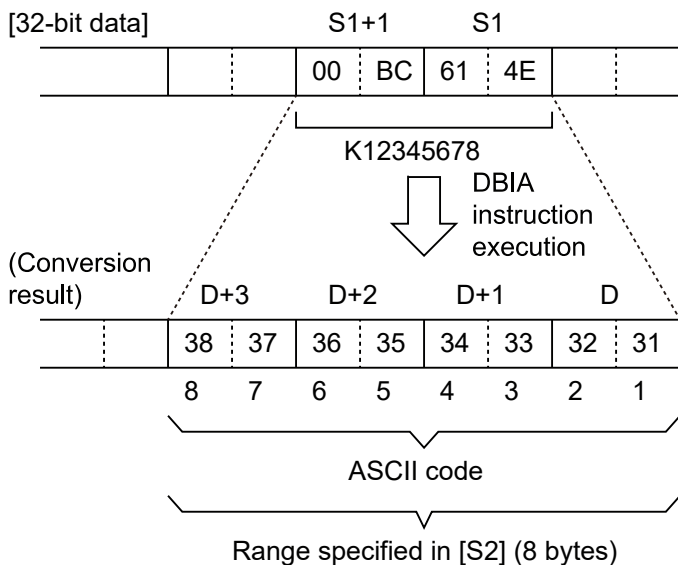

■ Reference: ASCII code

		Higher
		3
Lower	0	0
	1	1
	2	2
	3	3
	4	4
	5	5
	6	6
	7	7
	8	8
	9	9

■ Flag operations

Name	Description
R9007 R9008 (ER)	Turns ON when the area is exceeded in index modification.
	Turns ON when the number of bytes specified by [S2] exceeds the area specified by [D]
	Turns ON when the number of bytes specified by [S2] is "0"
	Turns ON when the conversion result exceeds the area
	Turns ON when the number of bytes of the conversion result exceeds the number of bytes specified by [S2]

15.9 F78 DABI (ASCII Code to 32-bit Binary Data Conversion)

15.9 F78 DABI (ASCII Code to 32-bit Binary Data Conversion)

Converts an ASCII code character string expressing a decimal number to 32-bit BIN data.

■ Instruction format

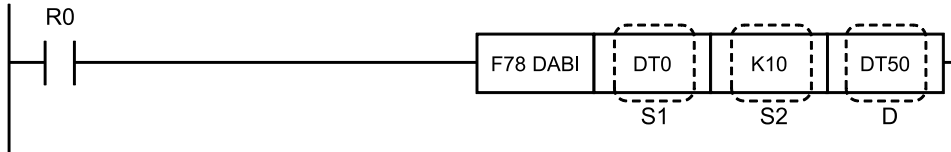

■ Operands

Items	Settings
S1	Starting number of the area storing the ASCII code to be converted
S2	Area storing the numerical values (number of bytes = number of characters) representing the range to be converted, or constant data
D	Number of the start of the area storing the conversion result

■ Devices that can be specified (indicated by ●)

Operands	WX	WY	WR	WL	SV	EV	DT	LD	I	SWR	SDT	Constant				Index modifier	Integer Device
												K	H	M	f		
S1	●	●	●	●	●	●	●	●		●	●				●		
S2	●	●	●	●	●	●	●	●	●	●	●	●	●		●		
D		●	●	●	●	●	●	●							●		

■ Outline of operation

- The ASCII code string expressing a decimal value of the number of bytes (number of characters) specified by [S2] starting from the area specified by [S1] is converted to a decimal value (32-bit K constant). The decimal value is stored in two words starting from the area specified by [D].
- Specify the number of bytes in [S2] as a decimal number.

■ Operation example

Operation of instruction format description program

When internal relay R0 turns ON, the ASCII codes stored in data registers DT0 to DT4 (10 bytes) are converted to decimal numbers, and stored in DT50 and DT51.

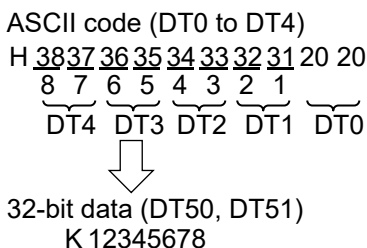

15.9 F78 DABI (ASCII Code to 32-bit Binary Data Conversion)

■ Precautions for programming

- Store the ASCII code for conversion in the direction of the final address of the specified area.
- Fill the remaining bytes with "0" (H30) or spaces (H20).
- Signed ASCII codes (+: H2B, -: H2D) are also converted. The + sign can be omitted.

■ Conversion example

Conversion of ASCII code to a 32-bit decimal number is performed as shown below.

Example of conversion of an ASCII code string expressing a negative number

[ASCII code]

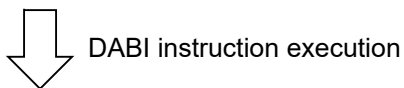
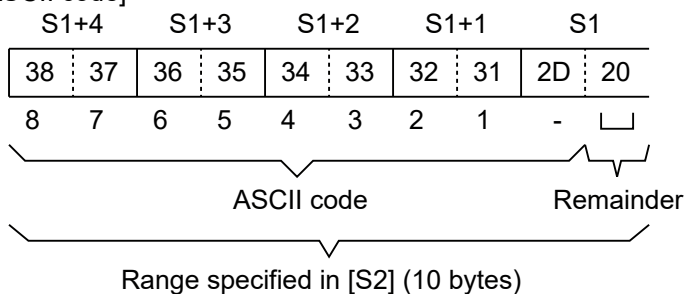

(Conversion result)

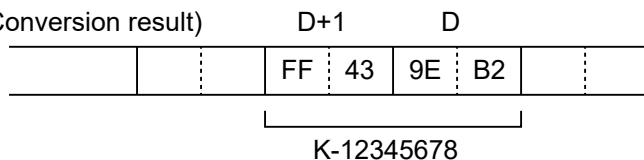

15.9 F78 DABI (ASCII Code to 32-bit Binary Data Conversion)

Example of conversion of an ASCII code expressing a positive number

Example (1)

[ASCII code]

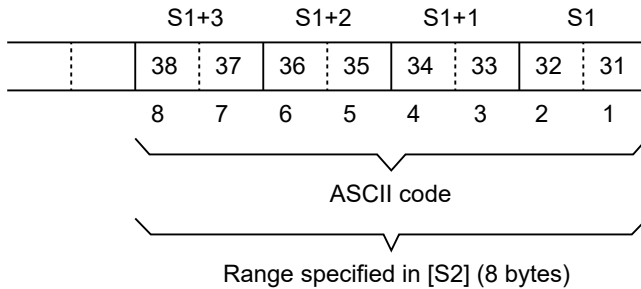

Example (2)

[ASCII code]

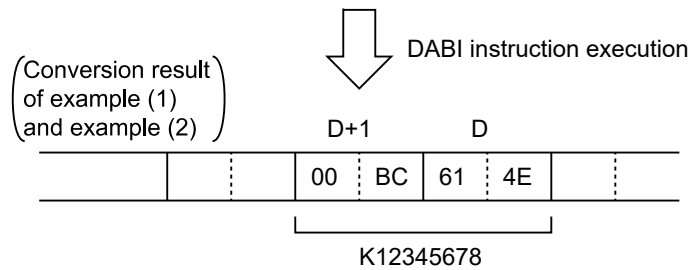
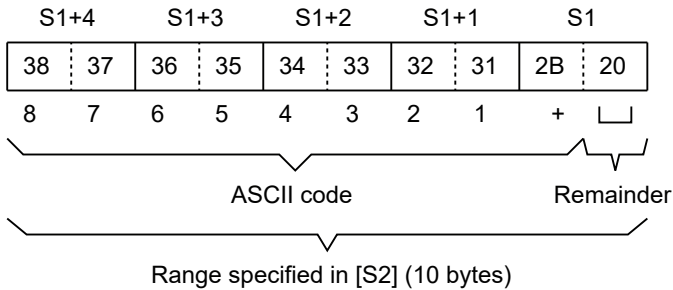

■ Reference: ASCII code

		Higher
		3
Lower	0	0
	1	1
	2	2
	3	3
	4	4
	5	5
	6	6
	7	7

15.9 F78 DABI (ASCII Code to 32-bit Binary Data Conversion)

		Higher
		3
	8	8
	9	9

■ Flag operations

Name	Description
R9007 R9008 (ER)	Turns ON when the area is exceeded in index modification.
	Turns ON when the number of bytes specified by [S2] exceeds the area of [S1]
	Turns ON when the number of bytes specified by [S2] is "0"
	Turns ON when the conversion result exceeds the area
	Turns ON when the conversion result exceeds 32 bits of data
	Turns ON when an ASCII code containing characters other than the numbers 0 to 9, signed code, or spaces is specified for [S1]

15.10 F80 BCD (16-bit Binary Data to BCD Data Conversion)

15.10 F80 BCD (16-bit Binary Data to BCD Data Conversion)

Converts 16-bit binary data to 4-digit BCD.

■ Instruction format

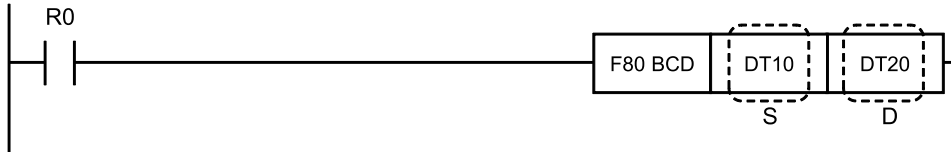

■ Operands

Items	Settings
S	Target data: Area storing 16-bit data, or constant data
D	Storage destination: Area storing 4-digit BCD data following conversion

■ Devices that can be specified (indicated by ●)

Operands	WX	WY	WR	WL	SV	EV	DT	LD	I	SWR	SDT	Constant				Index modifier	Integer Device
												K	H	M	f		
S	●	●	●	●	●	●	●	●	●	●	●	●	●	●	●	●	
D		●	●	●	●	●	●	●	●							●	

■ Outline of operation

- The 16-bit data expressing a decimal number specified by [S] is converted to 4-digit BCD data and stored in the area specified by [D].

■ Operation example

Operation of instruction format description program

When internal relay R0 turns ON, the contents of data register DT10 are converted to 4-digit BCD data and stored in data register DT20.

If DT10 is converted decimal number 16, the following will be stored in DT20.

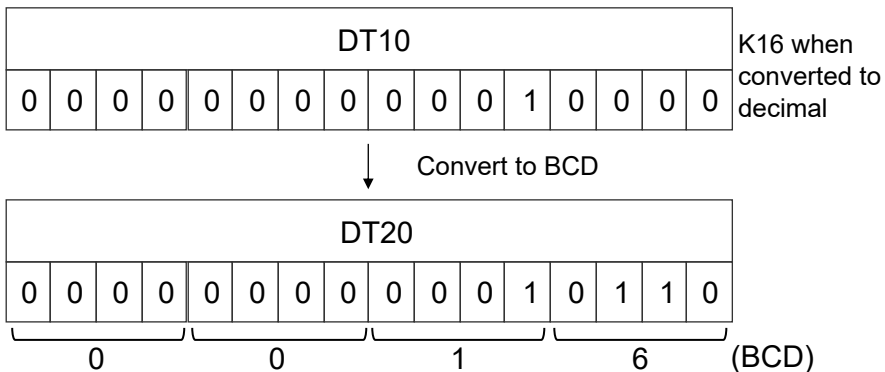

15.10 F80 BCD (16-bit Binary Data to BCD Data Conversion)

■ Precautions for programming

- The maximum value of 16-bit data that can be converted is K9999 (H270F).

■ Flag operations

Name	Description
R9007	Turns ON when the area is exceeded in index modification.
R9008 (ER)	Turns ON when the binary data exceeds the range that can be converted to BCD (when negative, or over K9999)

15.11 F81 BIN (BCD Data to 16-bit Binary Data Conversion)

15.11 F81 BIN (BCD Data to 16-bit Binary Data Conversion)

Converts 4-digit BCD data to 16-bit binary data.

■ Instruction format

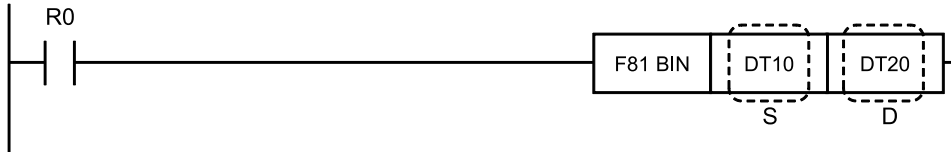

■ Operands

Items	Settings
S	Target data: Area storing 4-digit BCD data, or constant data
D	Storage destination: Area storing converted binary data

■ Devices that can be specified (indicated by ●)

Operand s	WX	WY	WR	WL	SV	EV	DT	LD	I	SW R	SD T	Constant				Index modifier	Integer Device
												K	H	M	f		
S	●	●	●	●	●	●	●	●	●	●	●	●	●			●	
D		●	●	●	●	●	●	●	●							●	

■ Outline of operation

The 4-digit BCD data specified by [S] is converted to 16-bit data expressing a decimal number and stored in the area specified by [D].

■ Operation example

Operation of instruction format description program

When internal relay R0 turns ON, the content of data register DT10 is converted to 16-bit data expressing a decimal number and stored in data register DT20. If DT10 is BCD data consisting of H15, the following will be stored in DT20.



■ Flag operations

Name	Description
R9007	Turns ON when the area is exceeded in index modification.
R9008 (ER)	Turns ON if [S] is not BCD data

15.12 F82 DBCD (32-bit Binary Data to BCD Data Conversion)

15.12 F82 DBCD (32-bit Binary Data to BCD Data Conversion)

Converts 32-bit binary data to 8-digit BCD data.

■ Instruction format

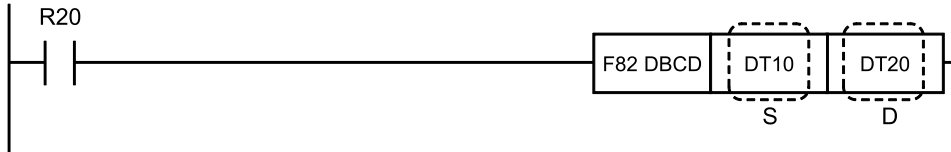

■ Operands

Items	Settings
S	Target data: Area storing 32-bit data, or constant data
D	Storage destination: Area storing 8-digit BCD data following conversion

■ Devices that can be specified (indicated by ●)

Operand S	WX	WY	WR	WL	SV	EV	DT	LD	I	SW R	SD T	Constant				Index modifier	Integer Device
												K	H	M	f		
S	●	●	●	●	●	●	●	●	●	●	●	●	●	●	●	●	
D		●	●	●	●	●	●	●	●							●	

■ Outline of operation

The 32-bit data specified by [S] expressing a decimal number is converted to 8-digit BCD data and stored in the area specified by [D].

■ Operation example

Operation of instruction format description program

When internal relay R20 turns ON, the content of data registers DT10 and DT11 is converted to 8-digit BCD data, and stored in DT21 and DT22.

■ Precautions for programming

The maximum value of binary data that can be converted is K99999999 (H5F5E0FF).

■ Flag operations

Name	Description
R9007	Turns ON when the area is exceeded in index modification.
R9008 (ER)	When the binary data exceeds the range that can be converted to BCD data (when the value is negative or exceeds K99999999)

15.13 F83 DBIN (BCD Data to 32-bit Binary Data Conversion)

Converts 8-digit BCD data to 32-bit binary data.

■ Instruction format

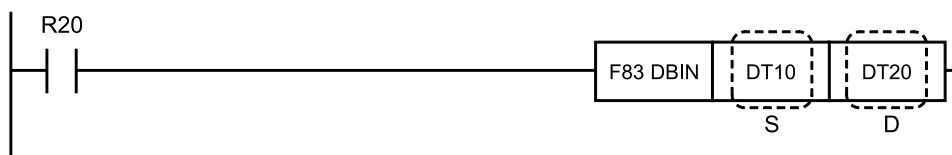

■ Operands

Items	Settings
S	Target data: Area storing 8-digit BCD data, or constant data
D	Storage destination: Area storing converted binary data

■ Devices that can be specified (indicated by ●)

Operands	WX	WY	WR	WL	SV	EV	DT	LD	I	SWR	SDT	Constant				Index modifier	Integer Device
												K	H	M	f		
S	●	●	●	●	●	●	●	●	●	●	●	●	●	●	●	●	
D		●	●	●	●	●	●	●	●							●	

■ Outline of operation

The 8-digit BCD data specified by [S] is converted to 32-bit data expressing a decimal number and stored in the area specified by [D].

■ Operation example

Operation of instruction format description program

When internal relay R20 turns ON, the value expressing the 8-digit BCD data in data registers DT10 and DT11 is converted to 32-bit data (K constant) and stored in DT20 and DT21.

■ Flag operations

Name	Description
R9007	Turns ON when the area is exceeded in index modification.
R9008 (ER)	Turns ON if [S] is not BCD data

15.14 F84 INV (16-bit Data Invert)

15.14 F84 INV (16-bit Data Invert)

Inverts 16-bit data.

■ Instruction format

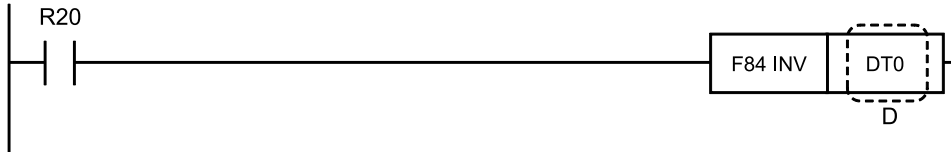

■ Operands

Items	Settings
D	Area that stores the data to invert

■ Devices that can be specified (indicated by ●)

Operands	WX	WY	WR	WL	SV	EV	DT	LD	I	SW R	SD T	Constant				Index modifier	Integer Device
												K	H	M	f		
D		●	●	●	●	●	●	●	●							●	

■ Outline of operation

- Inverts 1 (ON) and 0 (OFF) of each bit of the 16-bit data specified by [D].
- This instruction can be used to output to 7-segment display that uses negative logic operation.

■ Operation example

Operation of instruction format description program

Inverts the contents of data register DT0 when internal relay R20 turns ON.

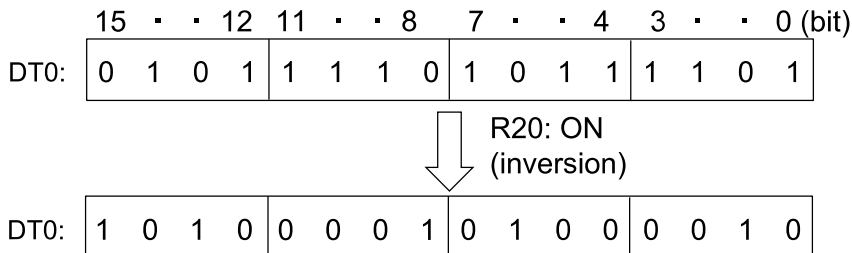

■ Flag operations

Name	Description
R9007 R9008 (ER)	Turns ON when the area is exceeded in index modification.

15.15 F85 NEG (16-bit Data Sign Inversion)

Takes complement of 2 in hexadecimal data.

■ Instruction format

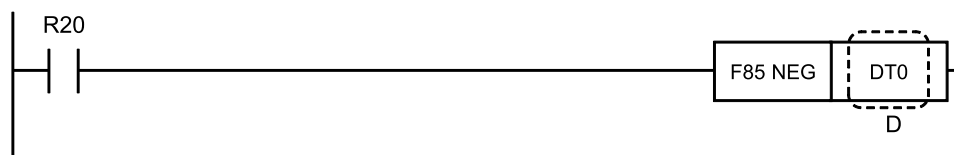

■ Operands

Items	Settings
D	Area for storing original data and its complement of 2

■ Devices that can be specified (indicated by ●)

Operands	WX	WY	WR	WL	SV	EV	DT	LD	I	SWR	SDT	Constant				Index modifier	Integer Device
												K	H	M	f		
D		●	●	●	●	●	●	●	●							●	

■ Outline of operation

- Inverts the content of hexadecimal data specified by [D] and adds +1 (takes complement of 2).
- Useful for inverting the signs of 16-bit data.

■ Operation example

Operation of instruction format description program

Inverts the content of data register DT0 and adds +1 when internal relay R20 turns ON.

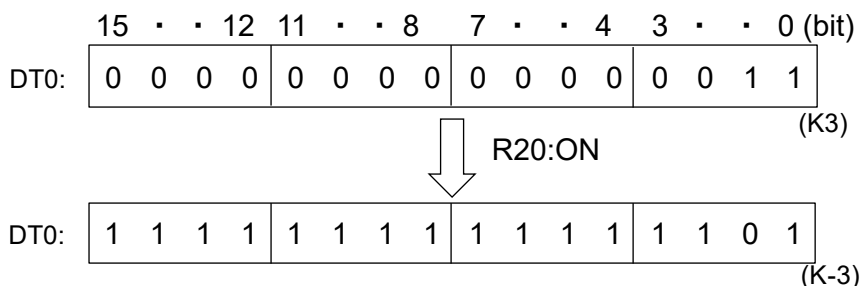

■ Flag operations

Name	Description
R9007 R9008 (ER)	Turns ON when the area is exceeded in index modification.

15.16 F86 DNEG (32-bit Data Sign Inversion)

15.16 F86 DNEG (32-bit Data Sign Inversion)

Takes complement of 2 in 32-bit data.

■ Instruction format

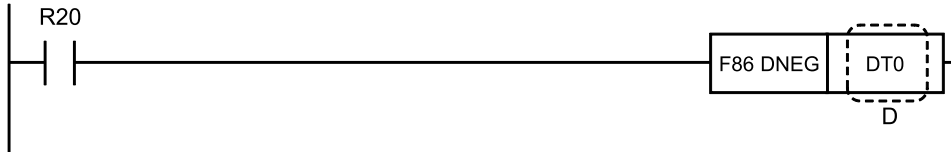

■ Operands

Items	Settings
D	Starting number of area for storing original data and its complement of 2

■ Devices that can be specified (indicated by ●)

Operands	WX	WY	WR	WL	SV	EV	DT	LD	I	SWR	SDT	Constant				Index modifier	Integer Device
												K	H	M	f		
D		●	●	●	●	●	●	●	●							●	

■ Outline of operation

- Inverts the content of 32-bit data specified by [D] and [D+1] and adds +1.
- Useful for inverting the signs of 32-bit data.

■ Operation example

Operation of instruction format description program

Inverts the 32-bit content of DT0 and DT1 and adds +1 when internal relay R20 turns ON.

	15	14	13	12	11	10	9	8	7	6	5	4	3	2	1	0 (bit)
DT0:	1	1	1	1	1	1	1	1	1	1	1	1	1	1	0	1
DT1:	1	1	1	1	1	1	1	1	1	1	1	1	1	1	1	1
(K-3)																
<div style="display: flex; align-items: center; justify-content: center;"> <div style="font-size: 2em; margin-right: 10px;">↓</div> <div style="text-align: left;">R20:ON</div> </div>																
DT0:	0	0	0	0	0	0	0	0	0	0	0	0	0	0	1	1
DT1:	0	0	0	0	0	0	0	0	0	0	0	0	0	0	0	0
(K3)																

■ **Flag operations**

Name	Description
R9007 R9008 (ER)	Turns ON when the area is exceeded in index modification.

15.17 F87 ABS (Absolute Value of 16-bit Data)

15.17 F87 ABS (Absolute Value of 16-bit Data)

Calculates the absolute value of signed 16-bit data.

■ Instruction format

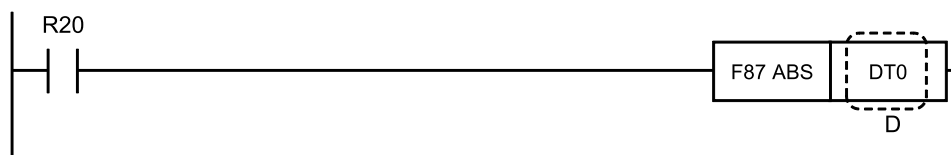

■ Operands

Items	Settings
D	Area storing the data for which the absolute value will be calculated

■ Devices that can be specified (indicated by ●)

Operands	WX	WY	WR	WL	SV	EV	DT	LD	I	SWR	SDT	Constant				Index modifier	Integer Device
												K	H	M	f		
D		●	●	●	●	●	●	●	●							●	

■ Outline of operation

- The absolute value of the signed 16-bit data specified by [D] is calculated and stores in [D].
- This is effective for processing data in which the polarity (+ or -) changes.

■ Operation example

Operation of instruction format description program

When internal relay R20 turns ON, the absolute value of the value of data register DT0 is calculated. For instance, regardless of whether the value of DT0 is K1 or K-1, it will be K1 when this instruction is executed.

■ Flag operations

Name	Description
R9007	Turns ON when the area is exceeded in index modification.
R9008 (ER)	
R9009 (CY)	Turns ON when the value is negative (other than the minimum)

15.18 F88 DABS (Absolute Value of 32-bit Data)

Calculates the absolute value of signed 32-bit data.

■ Instruction format

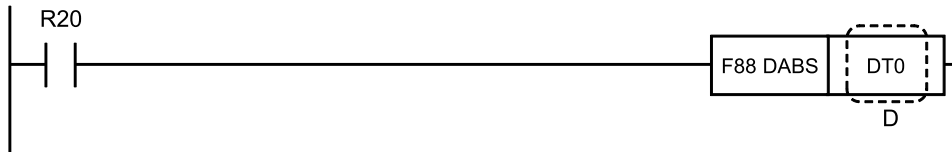

■ Operands

Items	Settings
D	Starting number of the area storing the data for which the absolute value will be calculated

■ Devices that can be specified (indicated by ●)

Operands	WX	WY	WR	WL	SV	EV	DT	LD	I	SWR	SDT	Constant				Index modifier	Integer Device
												K	H	M	f		
D		●	●	●	●	●	●	●	●							●	

■ Outline of operation

- The absolute value of the signed 32-bit data stored in [D] and [D+1] is calculated and stored in [D] and [D+1].
- This is effective for processing data in which the polarity (+ or -) changes.

■ Operation example

Operation of instruction format description program

When internal relay R20 turns ON, the absolute value of the signed 32-bit data in DT0 and DT1 is calculated and stored in DT0 and DT1.

■ Flag operations

Name	Description
R9007	Turns ON when the area is exceeded in index modification.
R9008 (ER)	Turns ON when the minimum value is negative (H80000000)
R9009 (CY)	Turns ON when the value is negative (other than the minimum)

15.19 F89 EXT (Sign Extension)

15.19 F89 EXT (Sign Extension)

Extends 16-bit data to 32-bit data without changing signs or values.

■ Instruction format

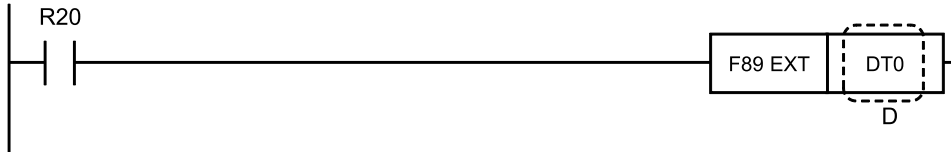

■ Operands

Items	Settings
D	Area where data for sign extension is stored

■ Devices that can be specified (indicated by ●)

Operands	WX	WY	WR	WL	SV	EV	DT	LD	I	SWR	SDT	Constant				Index modifier	Integer Device
												K	H	M	f		
D		●	●	●	●	●	●	●	●						●		

■ Outline of operation

- Converts 16-bit data to 32-bit data without changing its signs or values.
- If the sign bit (bit 15) of the 16-bit data specified in [D] is 0, all 16 bits in the area following [D] become 0. If the sign bit is 1, all 16 bits become 1. Thus, 16-bit data is converted to 32-bit data without its signs or values being changed.
- After execution of the F89 EXT instruction, double word data starting at [D] can be used as an operand for a 32-bit operation instruction.

■ Operation example

Operation of instruction format description program

When the internal relay R20 is ON, all 16 bits of DT1 are filled with the content of bit 15 of the data in DT0. If K-2 is stored in DT0, the data will be as follows.

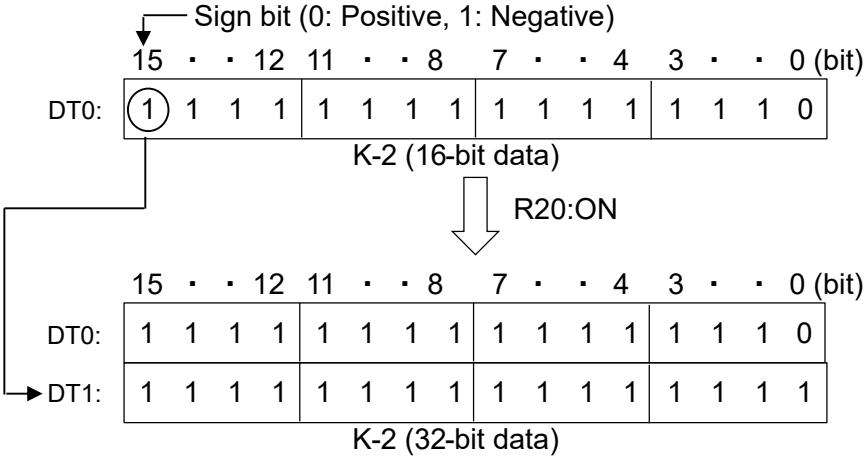

■ Flag operations

Name	Description
R9007 R9008 (ER)	Turns ON when the area is exceeded in index modification.

15.20 F90 DECO (Decode)

15.20 F90 DECO (Decode)

Decodes the specified data.

■ Instruction format

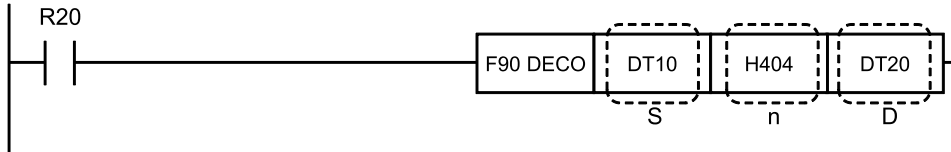

■ Operands

Items	Settings
S	Area storing conversion data, or constant data
n	Area storing the control data, or constant data
D	Starting address of the area storing the conversion result

■ Devices that can be specified (indicated by ●)

Operands	WX	WY	WR	WL	SV	EV	DT	LD	I	SWR	SDT	Constant				Index modifier	Integer Device
												K	H	M	f		
S	●	●	●	●	●	●	●	●	●	●	●	●	●		●		
n	●	●	●	●	●	●	●	●	●	●	●	●	●		●		
D		●	●	●	●	●	●	●	●						●		

■ Outline of operation

- The part of the data specified by [S] is decoded and the decoded result is stored in the area specified by [D].
- The part to be decoded is specified by control data [n].
- The length of the area required to store the decoded result depends on the length of the data to be decoded.

■ Operation example

Operation of instruction format description program

When internal relay R20 turns ON, the part of data register DT10 specified by [n] = H404 (H constant) is decoded and the result is stored in data register DT20.

e.g. When the value (control data) of [n] is H404

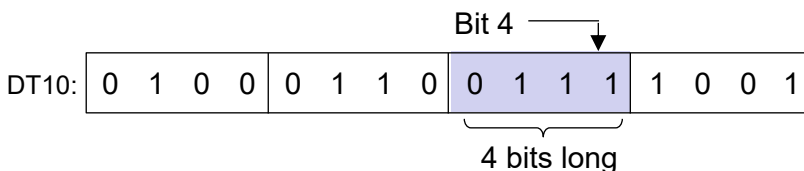

The decoded result for the specified part ("0111"= 7) is stored in the 2⁴bit area starting from DT20.

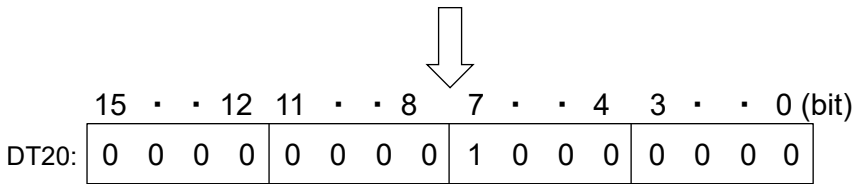

Bit 7 of the 2⁴bit area starting from DT20 is turned ON, and the other bits are set to 0.

■ **Specifying the data to be decoded (control data [n])**

Specify the conversion start bit and conversion effective bit length.

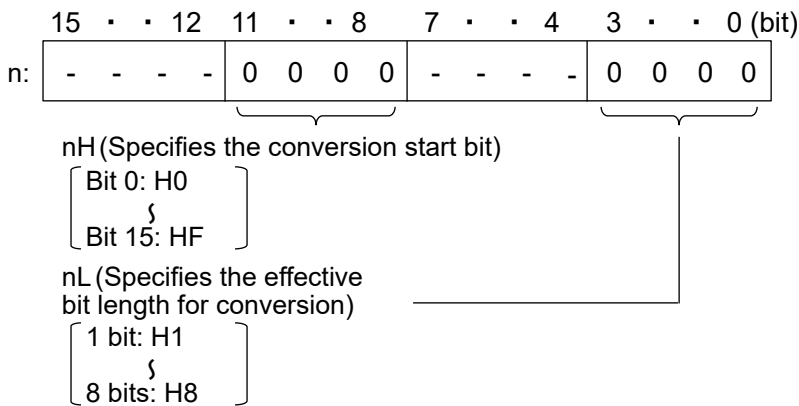

The effective bit length of the decoded result is 2^{nL}bits.

See the table below for the effective bit length and occupied length of the result.

e.g. When control data [n] is H0404 and the data to be decoded is the 4 bits from bit 4 in the area specified by [S].

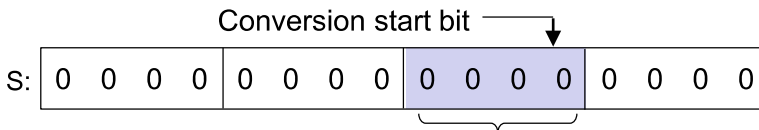

: Decode target

Specification of nL and length of result

Effective bit length for <nL value> conversion	Occupation length of decoded result	Effective bit length of decoded result	Value other than effective bit length in D
1	1 word	2-bit	0
2	1 word	4-bit	0
3	1 word	8 bits	0
4	1 word	16 bits	-

15.20 F90 DECO (Decode)

Effective bit length for <nL value> conversion	Occupation length of decoded result	Effective bit length of decoded result	Value other than effective bit length in D
5	2 words	32 bits	-
6	4 words	64 bits	-
7	8 words	128 bits	-
8	16 words	256 bits	-

Conversion example

When decoding 4-bit data (nL = 4), the contents of the conversion data and the decoded result are as follows.

Conversion data	Decoded result
0000	000000000000000001
0001	000000000000000010
0010	000000000000000100
0011	000000000000010000
0100	000000000001000000
0101	000000000010000000
0110	000000000100000000
0111	000000001000000000
1000	000000010000000000
1001	000000100000000000
1010	000001000000000000
1011	000010000000000000
1100	000100000000000000
1101	001000000000000000
1110	010000000000000000
1111	100000000000000000

■ Flag operations

Name	Description
R9007 R9008 (ER)	Turns ON when the area is exceeded in index modification.
	Turns ON when the effective bit length for conversion (nL) is not $1 \leq nL \leq 8$
	Turns ON (integrity) when the conversion start bit No. (nH) and conversion effective bit length (nL) are not $1 \leq (nH + nL) \leq 16$
	Turns ON when the decoded result exceeds the area specified by [D] when stored

15.21 F91 SEGT (7-segment)

Converts specified 16-bit data to 4-digit data for 7-segment display.

■ Instruction format

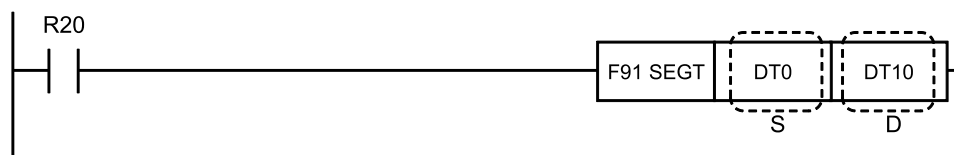

■ Operands

Items	Settings
S	Area storing conversion data, or constant data
D	Starting address of the area storing the conversion result

■ Devices that can be specified (indicated by ●)

Operands	WX	WY	WR	WL	SV	EV	DT	LD	I	SWR	SDT	Constant				Index modifier	Integer Device
												K	H	M	f		
S	●	●	●	●	●	●	●	●	●	●	●	●	●	●	●		
D		●	●	●	●	●	●	●	●							●	

■ Outline of operation

- Converts 16-bit data specified by [S] to four-digit data for 7-segment display, and stores this in the area starting from the two-word area specified by [D].
- Refer to the table below for the relationship between the displayed contents, the contents specified for [S], and the 7-segment display data.

■ Operation example

Operation of instruction format description program

Converts the contents of data register DT0 to 7-segment display data when internal relay R20 turns ON. The converted results are stored in data registers DT10 and DT11. For example, to display "ABCD", the following would be entered.

1. DT0 is set to H ABCD.

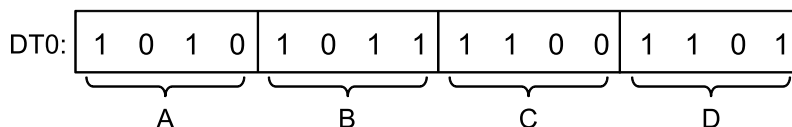

2. When the content of DT0 is converted to 7-segment display data, it is as follows.

15.21 F91 SEGT (7-segment)

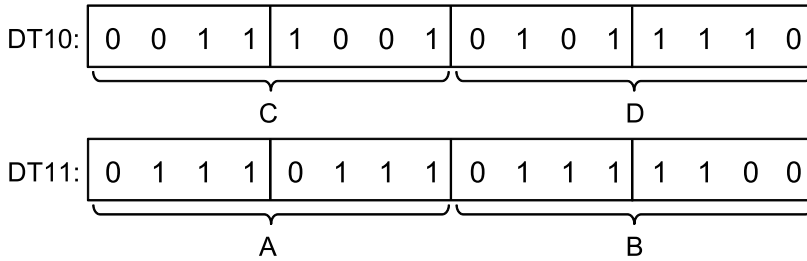

■ Relationship between display content and data

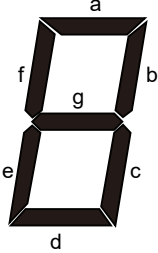
Value	Conversion data 1 digit [S]					Data for 7-segment display 1 digit [D]							7-segment display										
						g	f	e	d	c	b	a											
0	0	0	0	0	0	0	1	1	1	1	1	1	1	0	<div style="display: flex; align-items: center; justify-content: center;"> <div style="writing-mode: vertical-rl; transform: rotate(180deg);">LSB</div> <table border="1" style="border-collapse: collapse; text-align: center; margin-right: 10px;"> <tr><td>a</td></tr><tr><td>b</td></tr><tr><td>c</td></tr><tr><td>d</td></tr><tr><td>e</td></tr><tr><td>f</td></tr><tr><td>g</td></tr><tr><td>MSB</td></tr> </table>  </div>	a	b	c	d	e	f	g	MSB
a																							
b																							
c																							
d																							
e																							
f																							
g																							
MSB																							
1	0	0	0	1	0	0	0	0	0	1	1	0	1	1									
2	0	0	1	0	0	1	0	1	1	0	1	1	1	2									
3	0	0	1	1	0	1	0	0	1	1	1	1	1	3									
4	0	1	0	0	0	1	1	0	0	1	1	0	1	4									
5	0	1	0	1	0	1	1	0	1	1	0	1	1	5									
6	0	1	1	0	0	1	1	1	1	1	0	1	1	6									
7	0	1	1	1	0	0	1	0	0	1	1	1	1	7									
8	1	0	0	0	0	1	1	1	1	1	1	1	1	8									
9	1	0	0	1	0	1	1	0	1	1	1	1	1	9									
A	1	0	1	0	0	1	1	1	0	1	1	1	1	A									
B	1	0	1	1	0	1	1	1	1	1	0	0	1	B									
C	1	1	0	0	0	0	1	1	1	0	0	1	1	C									
D	1	1	0	1	0	1	0	1	1	1	1	0	1	D									
E	1	1	1	0	0	1	1	1	1	0	0	1	1	E									
F	1	1	1	1	0	1	1	1	0	0	0	1	1	F									

■ Flag operations

Name	Description
R9007	Turns ON when the area is exceeded in index modification.
R9008 (ER)	Turns ON when the area is exceeded when conversion results are stored in the area specified by [D]

15.22 F92 ENCO (Encode)

Encodes the specified data.

■ Instruction format

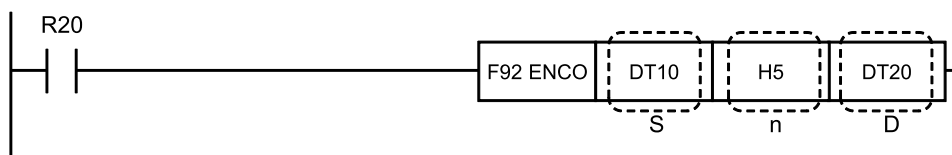

■ Operands

Items	Settings
S	Starting address of the area storing conversion data
n	Area storing the control data, or constant data
D	Area to store the conversion result

■ Devices that can be specified (indicated by ●)

Operands	WX	WY	WR	WL	SV	EV	DT	LD	I	SWR	SDT	Constant				Index modifier	Integer Device
												K	H	M	f		
S	●	●	●	●	●	●	●	●		●	●					●	
n	●	●	●	●	●	●	●	●	●	●	●	●	●			●	
D		●	●	●	●	●	●	●	●							●	

■ Outline of operation

- Encodes a section of the data specified in [S], and stores the encoded result in the area specified in [D].
- The target section to be encoded is specified by the control data [n].
- If multiple bits are ON in the target section for encoding, the higher bit is enabled.
- The content of the 2^{nL} -bits starting from the area specified in [S] are encoded. The encoded result is stored as a decimal, within the 8 bits starting from the bit specified in nH.
- Sections of the area specified in [D] that are not storing the conversion result will be 0.

■ Operation example

Operation of instruction format description program

When the internal relay R20 is ON, the bit area (data register starting at DT10) specified in [n] = H5 (H constant) is encoded, and the result is stored in DT20.

When the value of [n] (control data) is H5

The effective bits for conversion are the 32-bit section from DT10 (DT10 to DT11). The bit numbers that are ON in this two-word area are stored as decimals from bit 0 of DT20.

15.22 F92 ENCO (Encode)

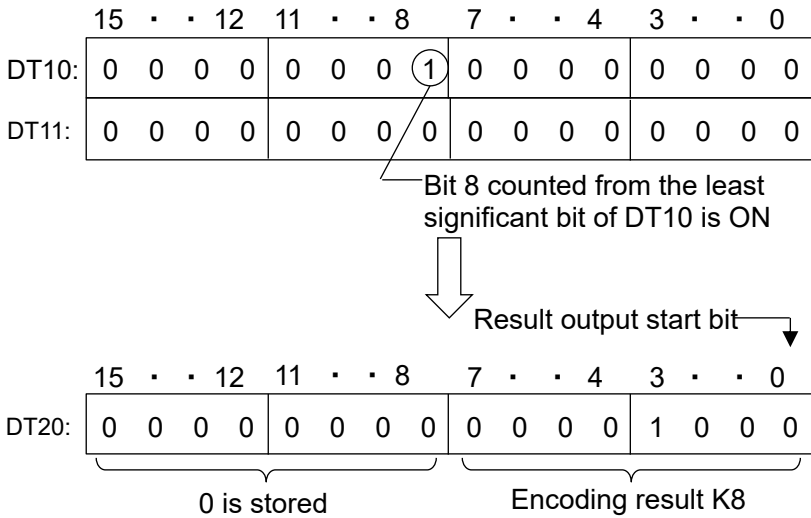

■ Specifying the target to be encoded (control data [n])

Specifies the effective bit length for conversion and the starting bit for output of the result.

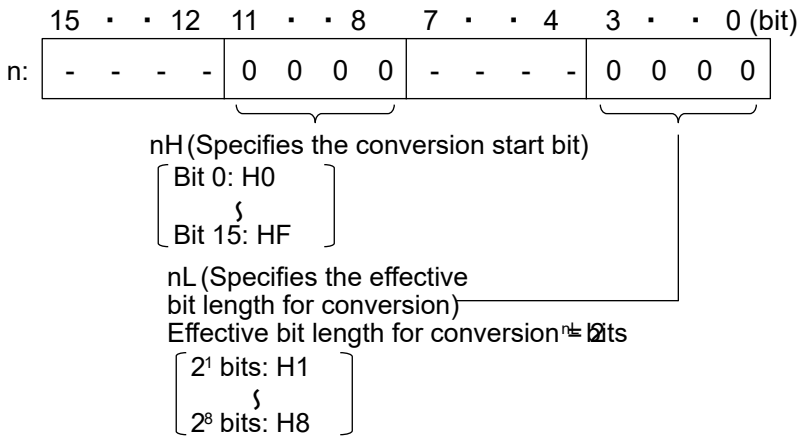

e.g. When the control data [n] is H0005

The target to be encoded is the 2⁵bits (32-bit = two words) starting from the area specified by [S].

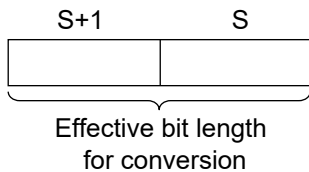

The result is stored from bit 0 in the area specified by [D].

Specification of nL and length of result

Value of nL	Effective bit length for conversion
1	2-bit
2	4-bit
3	8-bit (one byte)
4	16-bit (one word)
5	32-bit (two words)
6	64-bit (four words)
7	128-bit (eight words)
8	256-bit (16 words)

Conversion example

When encoding 16-bit data (nL = 4), the content of the conversion data and the encoding result will be as follows.

Conversion data (16-bit)				Encoding result
0000	0000	0000	0001	0000
0000	0000	0000	0010	0001
0000	0000	0000	0100	0010
0000	0000	0000	1000	0011
0000	0000	0001	0000	0100
0000	0000	0010	0000	0101
0000	0000	0100	0000	0110
0000	0000	1000	0000	0111
0000	0001	0000	0000	1000
0000	0010	0000	0000	1001
0000	0100	0000	0000	1010
0000	1000	0000	0000	1011
0001	0000	0000	0000	1100
0010	0000	0000	0000	1101
0100	0000	0000	0000	1110
1000	0000	0000	0000	1111

■ Flag operations

Name	Description
R9007 R9008 (ER)	Turns ON when the area is exceeded in index modification.
	Turns ON when the effective bit length for conversion (nL) is not $1 \leq nL \leq 8$
	Turns ON when the result output start bit no. (nH) and the effective bit length for conversion (nL) is not $1 \leq (nH + nL) \leq 16$ (consistency)
	Turns ON when all the data to be encoded is "0"

15.23 F93 UNIT (Digit Combine)

15.23 F93 UNIT (Digit Combine)

Combines the lower order 4 bits (bits 0 to 3) of 16-bit data.

■ Instruction format

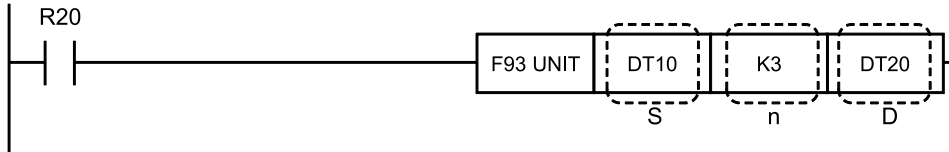

■ Operands

Items	Settings
S	The starting address of the area that stores the data to be combined
n	Area storing the number of data to be combined, or constant data
D	Area that stores the combined data

■ Devices that can be specified (indicated by ●)

Operands	WX	WY	WR	WL	SV	EV	DT	LD	I	SWR	SDT	Constant				Index modifier	Integer Device
												K	H	M	f		
S	●	●	●	●	●	●	●	●		●	●					●	
n	●	●	●	●	●	●	●	●	●	●	●	●	●			●	
D		●	●	●	●	●	●	●	●							●	

■ Outline of operation

- The lower 4 bits of n points of data from the area specified by [S] are stored in order 4 bits at a time from the lower order of the area specified by [D].
- The number of data areas to be combined [n] can be specified within the range 0 to 4.
- When n = 0, no operation takes place.
- If n < 4, the remainder of [D] is filled with "0".

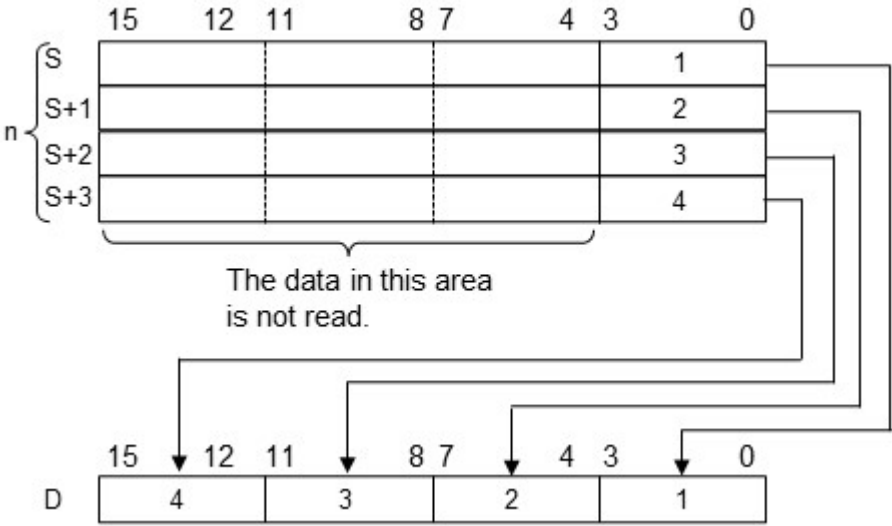

■ Operation example

Operation of instruction format description program

When internal relay R20 is ON, the lower 4 bits from data register 10, the lower 4 bits from DT11, and the lower 4 bits from DT12 are each stored from the lower order of DT20 4 bits at a time.

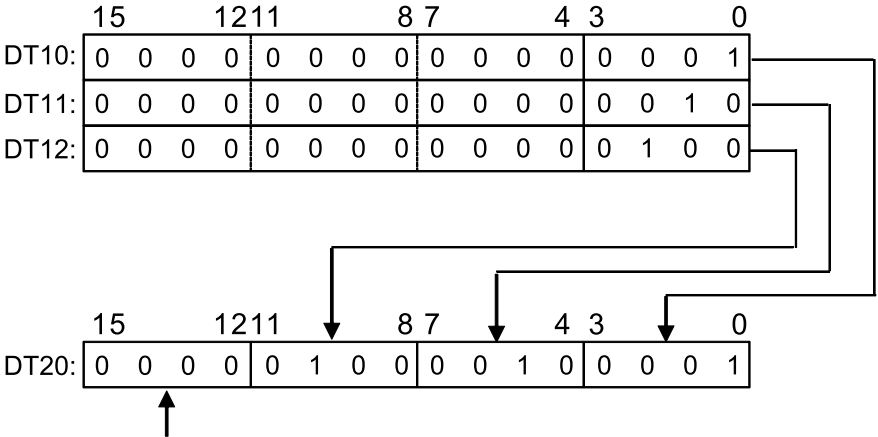

If [n] is less than 4, the 4 bits corresponding to the output destination are filled with "0".

■ Flag operations

Name	Description
R9007	Turns ON when the area is exceeded in index modification.
R9008 (ER)	Turns ON if the number of data areas to be combined [n] is $n \geq 5$

15.24 F94 DIST (Digit Distribute)

15.24 F94 DIST (Digit Distribute)

Divides 16-bit data into four 4-bit units and distributes it.

■ Instruction format

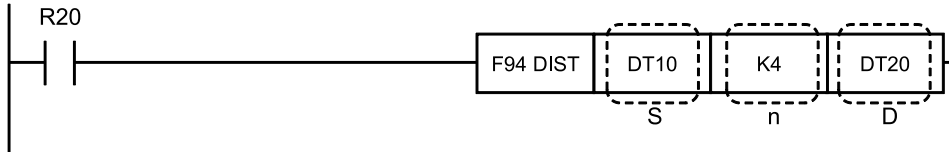

■ Operands

Items	Settings
S	Area storing the 16-bit data to be divided, or constant data
n	Area storing the number of data items to be divided, or constant data
D	Starting address of the area storing each divided digit

■ Devices that can be specified (indicated by ●)

Operands	WX	WY	WR	WL	SV	EV	DT	LD	I	SWR	SDT	Constant				Index modifier	Integer Device
												K	H	M	f		
S	●	●	●	●	●	●	●	●	●	●	●	●	●	●	●	●	
n	●	●	●	●	●	●	●	●	●	●	●	●	●	●	●	●	
D		●	●	●	●	●	●	●	●							●	

■ Outline of operation

- The 16-bit data specified by [S] is divided into 4-bit (1-digit) units, and the digits specified by [n] are each stored in the lower 4 bits (bit positions 0 to 3) of n areas in order starting from the area specified by [D].
- The range of the number of data divisions that can be specified [n] is 0 to 4.
- When n = 0, no operation takes place.

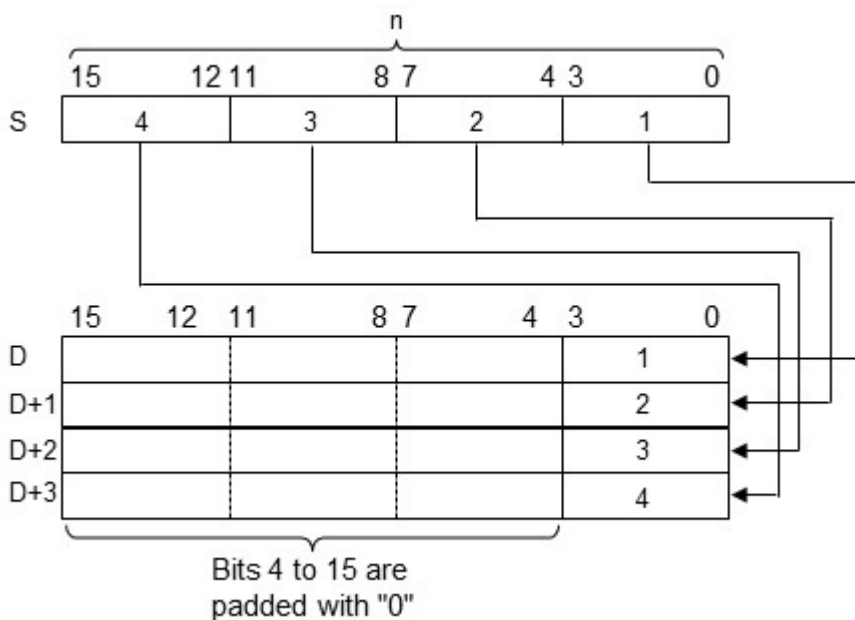

■ Operation example

Operation of instruction format description program

When internal relay R20 turns ON, the data of data register DT10 is divided into 4 bits from the low bit, and 1 digit each is stored in order in the lower 4 bits of data registers DT20 to DT23.

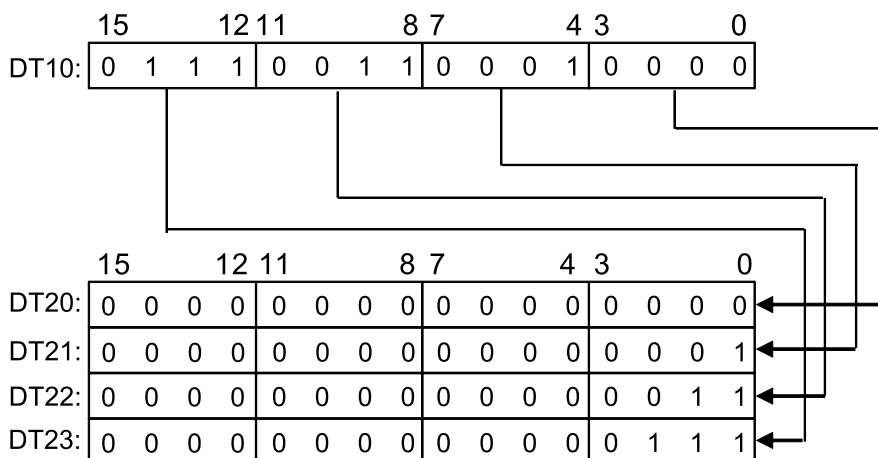

■ Flag operations

Name	Description
R9007	Turns ON when the area is exceeded in index modification.
R9008	Turns ON when the number of divided data items [n] is equal to or greater than 5
(ER)	Turns ON when the area is exceeded when distributing n data items to the address specified by [D]

15.25 F96 SRC (16-bit Data Search)

15.25 F96 SRC (16-bit Data Search)

Searches for the specified 16-bit data from the area in the specified range (table).

■ Instruction format

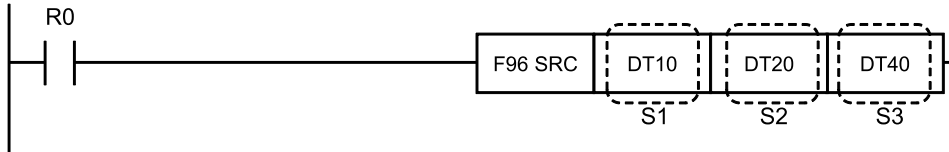

■ Operands

Items	Settings
S1	Area storing the data to be searched, or constant data
S2	Search table starting address
S3	Search table ending address

■ Devices that can be specified (indicated by ●)

Operands	WX	WY	WR	WL	SV	EV	DT	LD	I	SWR	SDT	Constant				Index modifier	Integer Device
												K	H	M	f		
S1	●	●	●	●	●	●	●	●	●	●	●	●			●		
S2		●	●	●	●	●	●	●							●		
S3		●	●	●	●	●	●	●							●		

■ Outline of operation

- The search data comprised of the 16-bit data specified by [S1] is searched for in the area (table) in the range specified by [S2] and [S3].
The search results are stored as follows.
 1. The number of registers that have the same value is stored as a decimal number in special data register DT90037.
 2. The position of the first matching register is stored in special data register DT90038 at a relative position to [S2].
- [S2] specifies the starting address, and [S3] the ending address for the table.
- Specify the same type of memory area for [S2] and [S3]. Additionally, specify values so that [S2] is equal to or less than [S3].
- Data is searched in the direction from [S2] to [S3].

■ Operation example

Operation of instruction format description program

When internal relay R0 turns ON, data that is the same content as the data in data register DT10 is searched in the range of data registers DT20 to DT40.

For example, to search the area of the value H1234, H1234 is written to DT10.

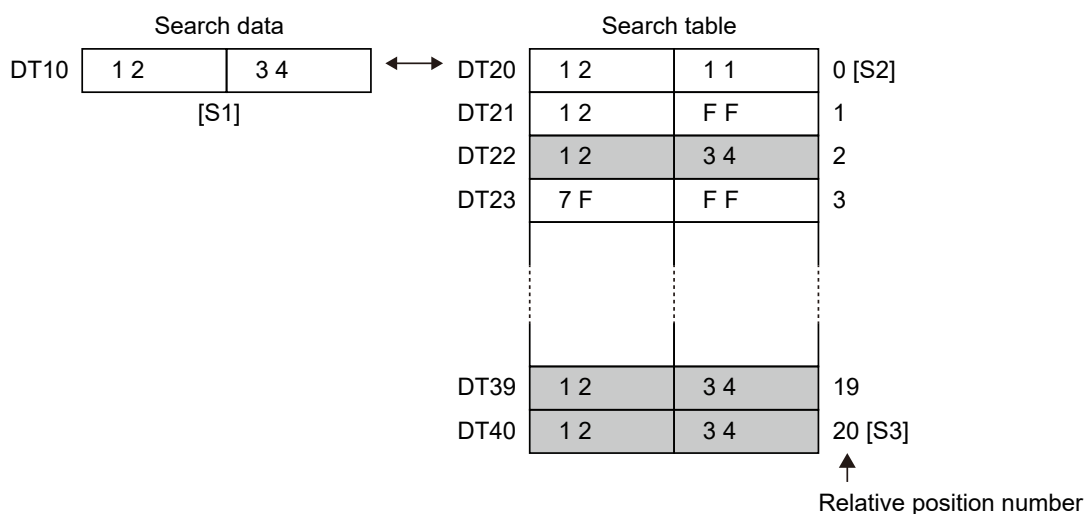

If DT22, DT39, and DT40 match the searched data, the following occurs.

1. If the number of registers matching the searched data equals 3
"K3" is stored in DT90037.
2. If the position of the first matching data (the relative position number) equals 2
"K2" is stored in DT90038.

■ Flag operations

Name	Description
R9007	Turns ON when the area is exceeded in index modification.
R9008 (ER)	ON when [S2] > [S3]

15.26 F97 DSRC (32-bit Data Search)

15.26 F97 DSRC (32-bit Data Search)

Searches for specified 32-bit data in any area range (table).

■ Instruction format

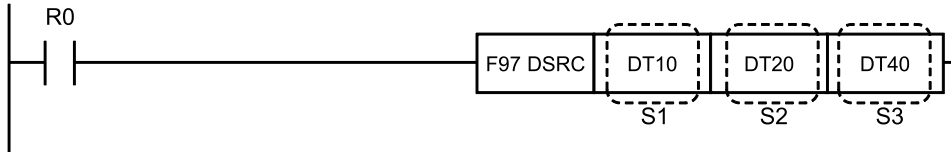

■ Operands

Items	Settings
S1	Area storing the data to search for, or constant data (32-bit)
S2	Address of the search table starting area (32-bit)
S3	Address of the search table ending area (32-bit)

■ Devices that can be specified (indicated by ●)

Operands	WX	WY	WR	WL	SV	EV	DT	LD	I	SWR	SDT	Constant				Index modifier	Integer Device
												K	H	M	f		
S1	●	●	●	●	●	●	●	●	●	●	●	●			●		
S2		●	●	●	●	●	●	●	●						●		
S3		●	●	●	●	●	●	●	●						●		

■ Outline of operation

- Searches the area range (table) specified by [S2] and [S3] for the 32-bit search data specified by [S1].
The search results are stored as follows.
 1. The number of registers with the same value is stored in special data register DT90037.
 2. The position of the first matching register is stored in special data register DT90038 at a relative position to [S2].
- [S2] specifies the starting address, and [S3] the ending address for the table.
- Specify the same type of memory area for [S2] and [S3]. Additionally, specify values so that [S2] is equal to or less than [S3].
- Data is searched in the direction from [S2] to [S3].

■ Operation example

Operation of instruction format description program

Searches data registers DT20 through DT40 for the same data as that in data registers DT10 and DT11 when execution condition R0 turns on.

For example, to search the area for the value "H01234567", write "H01234567" to DT10 and DT11.

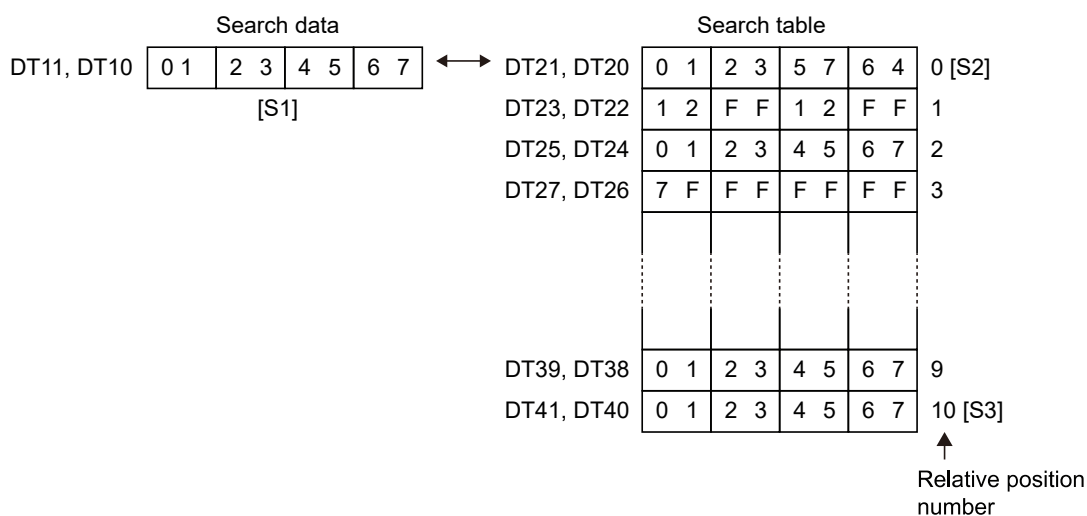

If "DT24, DT25", "DT38, DT39", and "DT40, DT41" match the searched data, the following occurs.

1. If the number of registers matching the searched data equals 3
"K3" is stored in DT90037.
2. If the position of the first matching data (the relative position number) equals 2
"K2" is stored in DT90038.

■ Flag operations

Name	Description
R9007	Turns ON when the area is exceeded in index modification.
R9008 (ER)	ON when [S2] > [S3]

15.27 F230 TMSEC (Time data to second conversion)

15.27 F230 TMSEC (Time data to second conversion)

Converts the specified time of day data (year, month, day, hour, minute, second) into number of seconds.

■ Instruction format

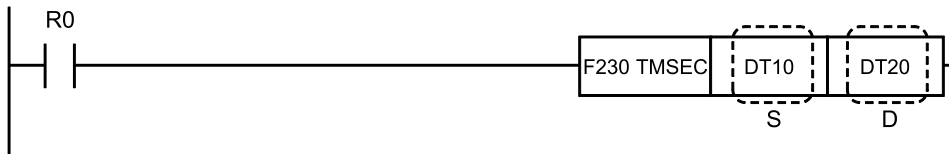

■ Operands

Items	Settings
S	Area storing the data to be converted, or constant data
D	Area to store the conversion result

■ Devices that can be specified (indicated by ●)

Operands	WX	WY	WR	WL	SV	EV	DT	LD	I	SWR	SDT	Constant				Index modifier	Integer Device
												K	H	M	f		
S	●	●	●	●	●	●	●	●	●	●	●					●	
D		●	●	●	●	●	●	●	●							●	

■ Outline of operation

- The input time data [S to S+2] is converted from standard time (*1) to number of seconds and the conversion result is stored in [D, D+1] as a 32-bit integer value.
(*1): Standard time is 00:00'00" on January 1, '01. The conversion result is output as a binary value.
- Time data conversion outputs time that takes into account leap years.

1 minute	60 seconds conversion
1 hour	60 minutes conversion
1 day	24 hours conversion
1 year (leap year)	366 days conversion
1 year (regular year)	365 days conversion
Leap year	2/29 (every 4 years)

- The time data (S) must be specified as BCD data and a value within the range must be registered.

15.27 F230 TMSEC (Time data to second conversion)

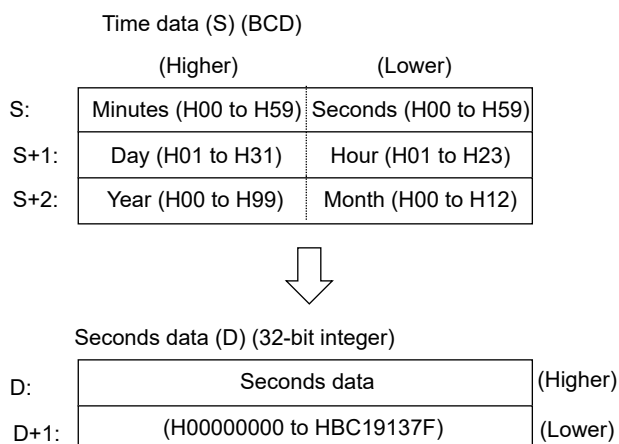

■ Operation example

Operation of instruction format description program

When internal relay R0 turns ON, the time data of data registers DT10 to DT12 is converted from standard time to number of seconds and the result is stored in DT20 and DT21.

Example 1)

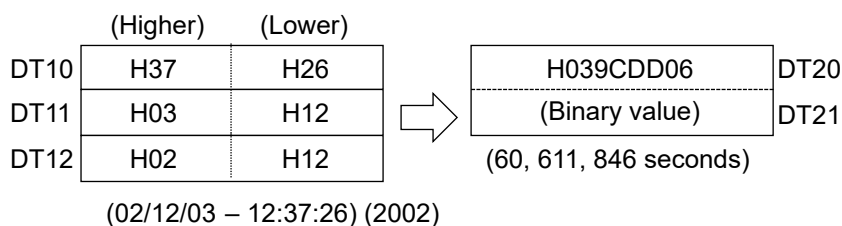

Example 2)

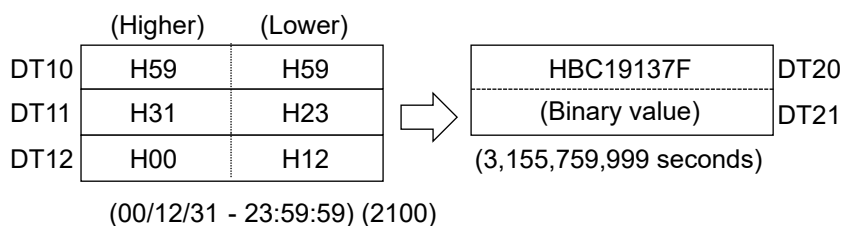

Correspondence between time of day data and second data

	Time data (S)	Second data (D)
2001	'01/01/01 00:00:00	H00000000
:	'01/01/01 00:00:01	H00000001
:	:	:
:	'01/01/01 00:01:00	H0000003C
:	:	:

15.27 F230 TMSEC (Time data to second conversion)

	Time data (S)	Second data (D)
:	'01/01/01 01:00:00	H00000E10
:	:	:
:	'01/01/01 00:00:00	H00015180
:	:	:
2099	'99/12/31 23:59:59	HBA368E7F
2100	'00/01/01 00:00:00	HBA368E80
:	:	:
2100	'00/12/31 23:59:59	HBC19137F

■ Flag operations

Name	Description
R9007 R9008 (ER)	Turns ON when the area is exceeded in index modification.
	Turns ON when a value other than BCD is specified for [S]
	Turns ON when a value that exceeds the range is specified for any one of month, day, hour, minute, or second in the time data of [S]
	Turns ON when the data of [S] exceeds the area

15.28 F231 SECTM (Second to Time Data Conversion)

The specified number of seconds is changed into time data (year/month/day/hour/minute/second).

■ Instruction format

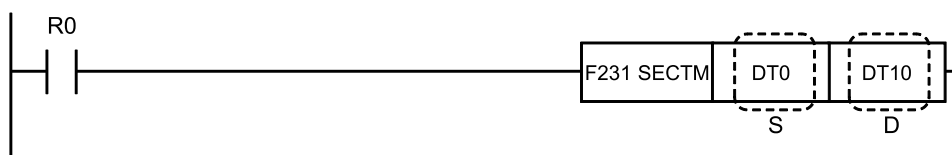

■ Operands

Items	Settings
S	Area storing the number of seconds (32 bits)
D	Starting area storing the time data

■ Devices that can be specified (indicated by ●)

Operands	WX	WY	WR	WL	SV	EV	DT	LD	I	SWR	SDT	Constant				Index modifier	Integer Device
												K	H	M	f		
S	●	●	●	●	●	●	●	●	●	●	●					●	
D		●	●	●	●	●	●	●	●							●	

■ Outline of operation

- The input number of seconds [S to S+2] is converted to the time data based on the standard time (*1), and stored in [D, D+1].
(*1): Standard time is 00:00'00" on January 1, '01.
- Time data conversion outputs time that takes into account leap years.

1 minute	60 seconds conversion
1 hour	60 minutes conversion
1 day	24 hours conversion
1 year (leap year)	366 days conversion
1 year (regular year)	365 days conversion
Leap year	2/29 (every 4 years)

- The number of seconds (S) must be within a range of values that can be expressed in time data, equaling up to 100 years.

H 0 to H BC19137F	Normal conversion
H BC191380 to H FFFFFFFF	Conversion error

15.28 F231 SECTM (Second to Time Data Conversion)

Seconds data (S) (32bit integer)

S:	Seconds data	(Lower)
S+1:	(H00000000 to HBC19137F)	(Higher)



Time of day data (D) (BCD)

	(Higher)	(Lower)
D:	Minutes (H00 to H59)	Seconds (H00 to H59)
D+1:	Day (H01 to H31)	Hour (H01 to H23)
D+2:	Year (H00 to H99)	Month (H00 to H12)

■ Operation example

Operation of instruction format description program

When the internal relay R0 is ON, the number of seconds for the data registers DT0 and DT1 is converted to the time data based on the standard time, and stored in DT10 to DT12.

Example 1)

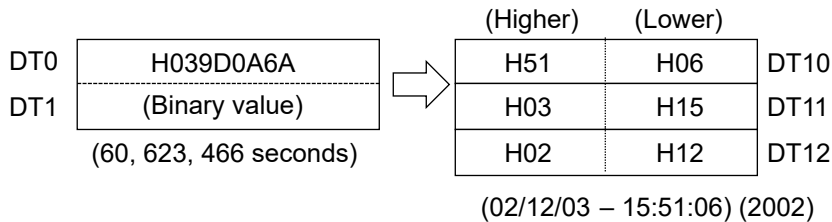

Example 2)

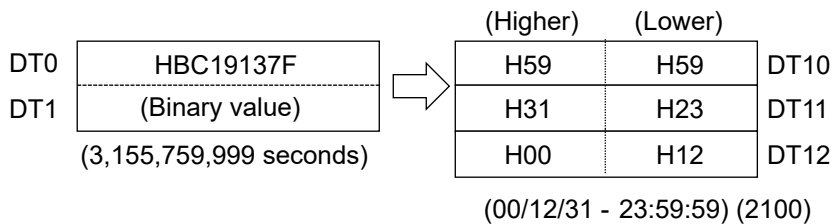

Second conversion

Second data (D)	Time data (S)	
H00000000	'01/01/01 00:00:00	2001
H00000001	'01/01/01 00:00:01	:
:	:	:
H0000003C	'01/01/01 00:01:00	:
:	:	:

15.28 F231 SECTM (Second to Time Data Conversion)

Second data (D)	Time data (S)	
H00000E10	'01/01/01 01:00:00	:
:	:	:
H00015180	'01/01/01 00:00:00	:
:	:	:
HBA368E7F	'99/12/31 23:59:59	2099
HBA368E80	'00/01/01 00:00:00	2100
:	:	:
HBC19137F	'00/12/31 23:59:59	2100

■ Flag operations

Name	Description
R9007	Turns ON when the area is exceeded in index modification.
R9008	Turns ON when the number of seconds [S] is $[S] \geq \text{HBC191380}$ (number of seconds in 100 years)
(ER)	Turns ON when the data memory of [D] exceeds the area

15.29 F235 GRY (16-bit Data to Gray Code Conversion)

15.29 F235 GRY (16-bit Data to Gray Code Conversion)

Converts the specified 16-bit data to gray code.

■ Instruction format

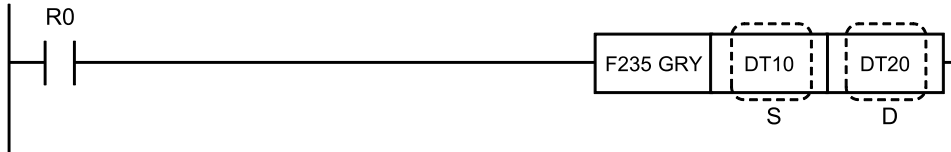

■ Operands

Items	Settings
S	Area storing the data to be converted, or constant data
D	Area to store the conversion result

■ Devices that can be specified (indicated by ●)

Operands	WX	WY	WR	WL	SV	EV	DT	LD	I	SWR	SDT	Constant				Index modifier	Integer Device
												K	H	M	f		
S	●	●	●	●	●	●	●	●	●	●	●	●	●		●		
D		●	●	●	●	●	●	●	●						●		

■ Outline of operation

- The 16-bit data in the area specified by [S] is converted to gray code and stored in the area specified by [D].

i Info.

- For the gray code, refer the correspondence table in "P.15-75".

■ Flag operations

Name	Description
R9007 R9008 (ER)	Turns ON when the area is exceeded in index modification.

15.30 F236 DGRY (32-bit Data to Gray Code Conversion)

Converts specified 32-bit data to gray code.

■ Instruction format

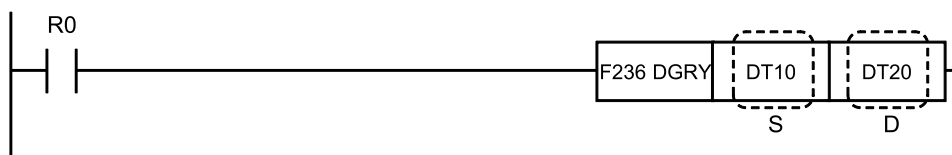

■ Operands

Items	Settings
S	Area (two word) storing the data to be converted, or constant data
D	Area (two word) to store the conversion result

■ Devices that can be specified (indicated by ●)

Operands	WX	WY	WR	WL	SV	EV	DT	LD	I	SWR	SDT	Constant				Index modifier	Integer Device
												K	H	M	f		
S	●	●	●	●	●	●	●	●	●	●	●	●	●	●	●	●	
D		●	●	●	●	●	●	●	●							●	

■ Outline of operation

- Converts the 32-bit data specified by [S] to gray code, and stores the converted data in the area specified by [D].

i Info.

- For the gray code, refer the correspondence table in "P.15-75".

■ Flag operations

Name	Description
R9007 R9008 (ER)	Turns ON when the area is exceeded in index modification.

15.31 F237 GBIN (Gray Code to 16-bit Data Conversion)

15.31 F237 GBIN (Gray Code to 16-bit Data Conversion)

Converts the gray code in the specified area to 16-bit binary data.

■ Instruction format

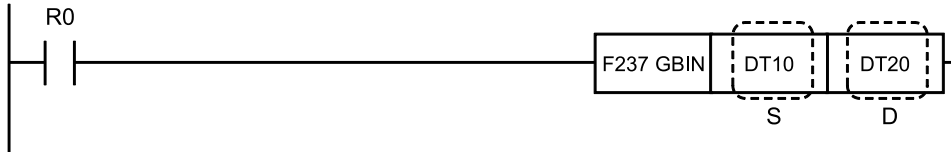

■ Operands

Items	Settings
S	Area storing the data to be converted, or constant data
D	Area to store the conversion result

■ Devices that can be specified (indicated by ●)

Operands	WX	WY	WR	WL	SV	EV	DT	LD	I	SWR	SDT	Constant				Index modifier	Integer Device
												K	H	M	f		
S	●	●	●	●	●	●	●	●	●	●	●	●	●	●	●	●	
D		●	●	●	●	●	●	●	●							●	

■ Outline of operation

- The gray code of the area specified by [S] is converted to 16-bit binary data and stored in the area specified by [D].

i Info.

- For the gray code, refer the correspondence table in "P.15-75".

■ Flag operations

Name	Description
R9007 R9008 (ER)	Turns ON when the area is exceeded in index modification.

15.32 F238 DGBIN (Gray Code to 32-bit Data Conversion)

The gray code in the specified area is converted to 32-bit binary data.

■ Instruction format

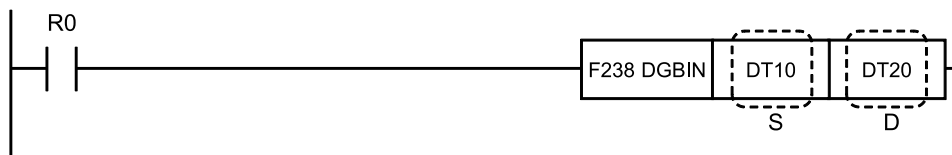

■ Operands

Items	Settings
S	Area (two word) storing the data to be converted, or constant data
D	Area (two words) to store the conversion result

■ Devices that can be specified (indicated by ●)

Operands	WX	WY	WR	WL	SV	EV	DT	LD	I	SWR	SDT	Constant				Index modifier	Integer Device
												K	H	M	f		
S	●	●	●	●	●	●	●	●	●	●	●	●	●	●	●	●	
D		●	●	●	●	●	●	●	●							●	

■ Outline of operation

- The gray code in the area specified in [S] is converted to 32-bit binary data and stored in the area specified in [D].

i Info.

- For the gray code, refer the correspondence table in "P.15-75".

■ Flag operations

Name	Description
R9007 R9008 (ER)	Turns ON when the area is exceeded in index modification.

BIN/Gray Code Correspondence Table

Decimal (Decimal)	Binary (Binary)	Gray code (Gray code)
0	0000 0000 0000 0000	0000 0000 0000 0000
1	0000 0000 0000 0001	0000 0000 0000 0001
2	0000 0000 0000 0010	0000 0000 0000 0011

15.32 F238 DGBIN (Gray Code to 32-bit Data Conversion)

Decimal (Decimal)	Binary (Binary)	Gray code (Gray code)
3	0000 0000 0000 0011	0000 0000 0000 0010
4	0000 0000 0000 0100	0000 0000 0000 0110
5	0000 0000 0000 0101	0000 0000 0000 0111
6	0000 0000 0000 0110	0000 0000 0000 0101
7	0000 0000 0000 0111	0000 0000 0000 0100
8	0000 0000 0000 1000	0000 0000 0000 1100
9	0000 0000 0000 1001	0000 0000 0000 1101
10	0000 0000 0000 1010	0000 0000 0000 1111
11	0000 0000 0000 1011	0000 0000 0000 1110
12	0000 0000 0000 1100	0000 0000 0000 1010
13	0000 0000 0000 1101	0000 0000 0000 1011
14	0000 0000 0000 1110	0000 0000 0000 1001
15	0000 0000 0000 1111	0000 0000 0000 1000
16	0000 0000 0001 0000	0000 0000 0001 1000
17	0000 0000 0001 0001	0000 0000 0001 1001
18	0000 0000 0001 0010	0000 0000 0001 1011
19	0000 0000 0001 0011	0000 0000 0001 1010
20	0000 0000 0001 0100	0000 0000 0001 1110
21	0000 0000 0001 0101	0000 0000 0001 1111
22	0000 0000 0001 0110	0000 0000 0001 1101
23	0000 0000 0001 0111	0000 0000 0001 1100
24	0000 0000 0001 1000	0000 0000 0001 0100
25	0000 0000 0001 1001	0000 0000 0001 1101
26	0000 0000 0001 1010	0000 0000 0001 0111
27	0000 0000 0001 1011	0000 0000 0001 0110
28	0000 0000 0001 1100	0000 0000 0001 0010
29	0000 0000 0001 1101	0000 0000 0001 0011
30	0000 0000 0001 1110	0000 0000 0001 0001
31	0000 0000 0001 1111	0000 0000 0001 0000
32	0000 0000 0010 0000	0000 0000 0011 0000
63	0000 0000 0011 1111	0000 0000 0010 0000
64	0000 0000 0100 0000	0000 0000 0110 0000
:	:	:
255	0000 0000 1111 1111	0000 0000 1000 0000

15.33 F240 COLM (Bit Line to Bit Column Conversion)

Converts a bit line to a bit column.

■ Instruction format

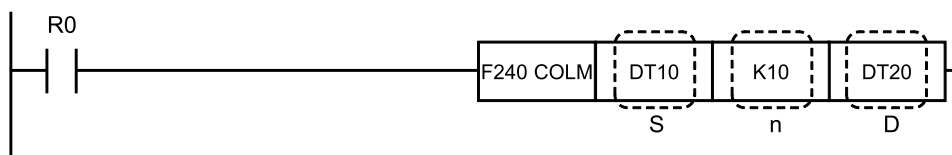

■ Operands

Items	Settings
S	Area storing the hexadecimal data or constant data
n	Area storing the bit position specification, or constant data
D	Starting address of the area that will be overwritten by the bit column

■ Devices that can be specified (indicated by ●)

Operand s	WX	WY	WR	WL	SV	EV	DT	LD	I	SW R	SD T	Constant				Index modifier	Integer Device
												K	H	M	f		
S	●	●	●	●	●	●	●	●	●	●	●	●	●			●	
n	●	●	●	●	●	●	●	●	●	●	●	●	●			●	
D		●	●	●	●	●	●	●	●							●	

■ Outline of operation

- The bit data at the position specified by [n] in the 16-word data area starting from [D] is rewritten by the 16-bit data of the area specified by [S].
- The contents of the bits of the 16-word data area starting from [D] that are not specified do not change.
- [n] can be specified in the range of 0 to 15.

15.33 F240 COLM (Bit Line to Bit Column Conversion)

e.g. When the specified bit position $n = 10$ (K10)

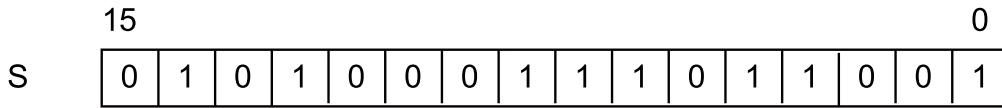

15 10 0

D

D					1										
D+1					0										
D+2					0										
D+3					1										
D+4					1										
D+5					0										
D+6					1										
D+7					1										
D+8					1										
D+9					0										
D+10					0										
D+11					0										
D+12					1										
D+13					0										
D+14					1										
D+15					0										

■ Flag operations

Name	Description
R9007	Turns ON when the area is exceeded in index modification.
R9008	Turns ON if $0 \leq [n] \leq 15$ is not true
(ER)	Turns ON when the conversion result exceeds the area specified by [D] when stored

15.34 F241 LINE (Bit Column to Bit Line Conversion)

Converts a bit column to a bit line.

■ **Instruction format**

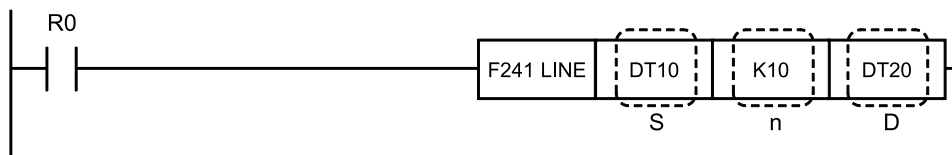

■ **Operands**

Items	Settings
S	Starting address of area where bit column will be read
n	Area storing the bit position specification, or constant data
D	Area to store the conversion result

■ **Devices that can be specified (indicated by ●)**

Operand s	WX	WY	WR	WL	SV	EV	DT	LD	I	SW R	SD T	Constant				Index modifier	Integer Device
												K	H	M	f		
S	●	●	●	●	●	●	●	●	●	●	●					●	
n	●	●	●	●	●	●	●	●	●	●	●	●	●			●	
D		●	●	●	●	●	●	●	●							●	

■ **Outline of operation**

- Reads the bit data at the position specified by [n] from the area specified by [S] and stores it in the area specified by [D].
- [n] can be specified in the range of 0 to 15.

15.34 F241 LINE (Bit Column to Bit Line Conversion)

e.g. When the specified bit position $n = 10$ (K10)

	15					10									0
S						1									
S+1						0									
S+2						0									
S+3						1									
S+4						1									
S+5						0									
S+6						1									
S+7						1									
S+8						1									
S+9						0									
S+10						0									
S+11						0									
S+12						1									
S+13						0									
S+14						1									
S+15						0									



	15														0	
D	0	1	0	1	0	0	0	1	1	1	0	1	1	0	0	1

■ **Flag operations**

Name	Description
R9007	Turns ON when the area is exceeded in index modification.
R9008	Turns ON if $0 \leq [n] \leq 15$ is not true
(ER)	Turns ON when the conversion range specified by [S] exceeds the area

16 Data Shift Instruction

16.1	F100 SHR (16-bit Data Right Shift).....	16-2
16.2	F101 SHL (16-bit Data Left Shift).....	16-4
16.3	F102 DSHR (32-bit Data Right Shift).....	16-6
16.4	F103 DSHL (32-bit Data Left Shift).....	16-8
16.5	F105 BSR (16-bit Data 1-Digit Right Shift)	16-10
16.6	F106 BSL (16-bit Data 1-Digit Left Shift)	16-12
16.7	F108 BITR (Block Area Bitwise Right Shift).....	16-14
16.8	F109 BITL (Block Area Bitwise Left Shift).....	16-16
16.9	F110 WSHR (Block Area 1 Word Right Shift)	16-18
16.10	F111 WSHL (Block Area 1 Word Left Shift)	16-20
16.11	F112 WBSR (Block Area 1 Digit Right Shift).....	16-22
16.12	F113 WBSL (Block Area 1 Digit Left Shift).....	16-24

16.1 F100 SHR (16-bit Data Right Shift)

16.1 F100 SHR (16-bit Data Right Shift)

Shifts 16-bit data to the right by a specified number of bits.

■ Instruction format

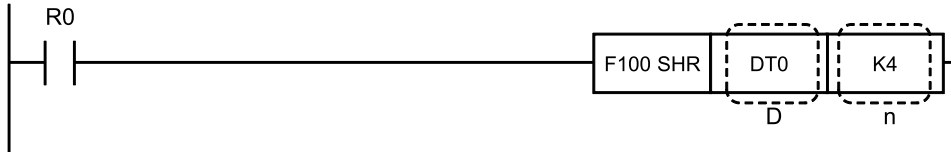

■ Operands

Items	Settings
D	Area storing the 16-bit data to be shifted
n	Area storing the number of bits to be shifted, or constant data

■ Devices that can be specified (indicated by ●)

Operands	WX	WY	WR	WL	SV	EV	DT	LD	I	SWR	SDT	Constant				Index modifier	Integer Device
												K	H	M	f		
D		●	●	●	●	●	●	●	●						●		
n	●	●	●	●	●	●	●	●	●	●	●	●	●		●		

■ Outline of operation

- Shifts the 16-bit data specified by [D] by the number of bits (specified in decimal form) specified by [n] to the right (the lower bit direction).

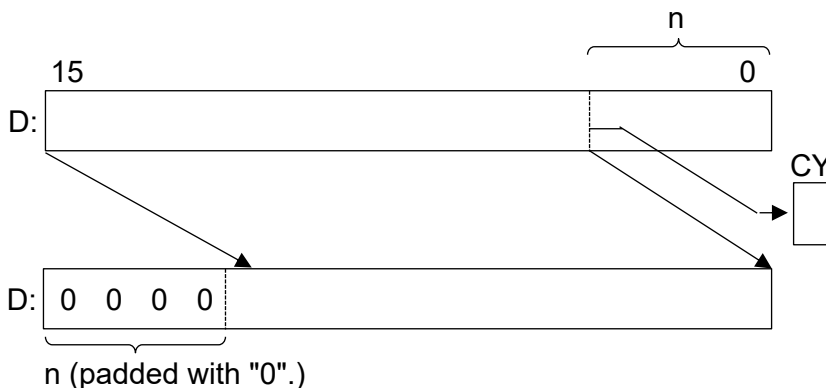

- When the data is shifted to the right,
 - the n bits from the most significant bit are filled with 0.
 - The content from the least significant bit to the n th bit is stored in the CY (carry) flag (R9009).
- For [n], only the lower 8 bits of the 16-bit data are valid. The shift amount can be selected from 1 bit to 255 bits.

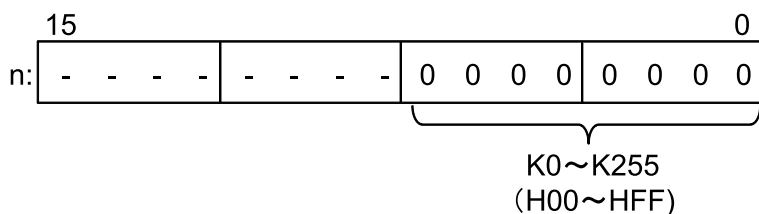

(Note 1) The bits marked with - are invalid.

■ Operation example

Operation of instruction format description program

Shifts the content of DT0 four bits to the right when internal relay R0 turns ON. The content of bit 3 before the shift is stored in the CY (carry) flag.

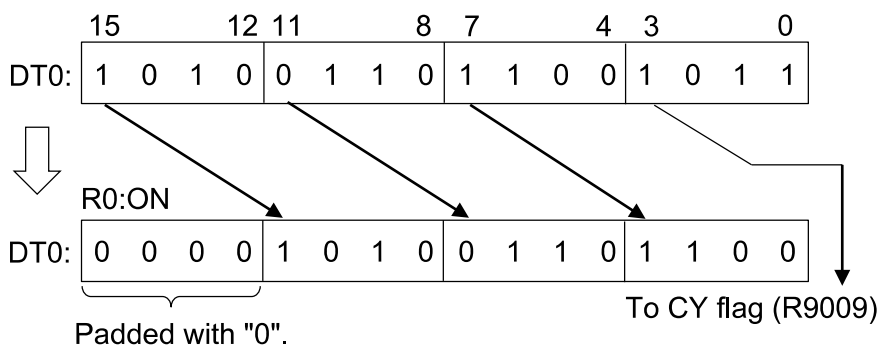

■ Flag operations

Name	Description
R9007 R9008 (ER)	Turns ON when the area is exceeded in index modification.
R9009 (CY)	Turns ON when the content of the least significant bit to the n bit is "1"

16.2 F101 SHL (16-bit Data Left Shift)

16.2 F101 SHL (16-bit Data Left Shift)

Shifts 16-bit data to the left by the specified number of bits.

■ Instruction format

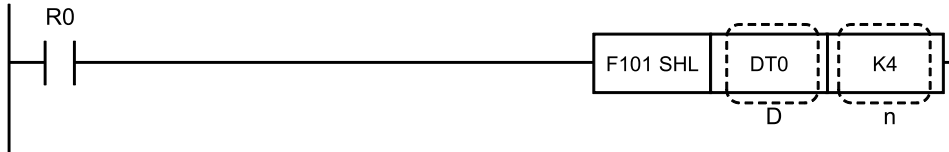

■ Operands

Items	Settings
D	Area storing the 16-bit data to be shifted
n	Area storing the number of bits to be shifted, or constant data

■ Devices that can be specified (indicated by ●)

Operands	WX	WY	WR	WL	SV	EV	DT	LD	I	SWR	SDT	Constant				Index modifier	Integer Device
												K	H	M	f		
D		●	●	●	●	●	●	●	●						●		
n	●	●	●	●	●	●	●	●	●	●	●	●			●		

■ Outline of operation

- The 16-bit data specified by [D] is shifted to the left (in the high bit direction) by the number of bits specified by [n] (specified as a decimal number).

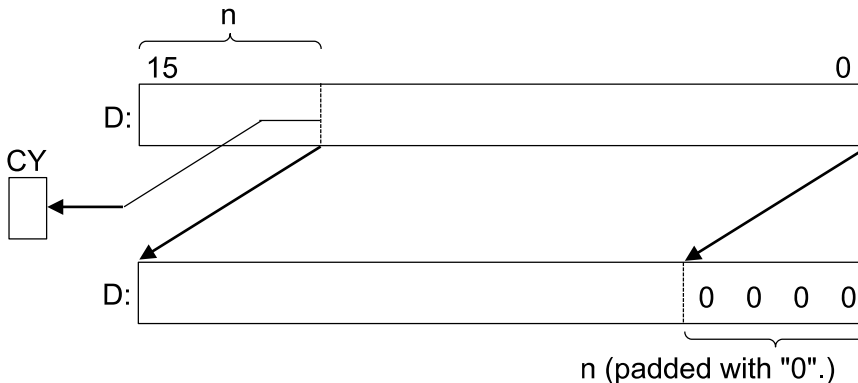

- When the data is shifted to the left,
 - the n bits from the least significant bit are filled with 0.
 - The content from the most significant bit to the n th bit is stored in the CY (carry) flag (R9009).
- For [n], only the lower 8 bits of the 16-bit data are valid. The shift amount can be selected from 1 bit to 255 bits.

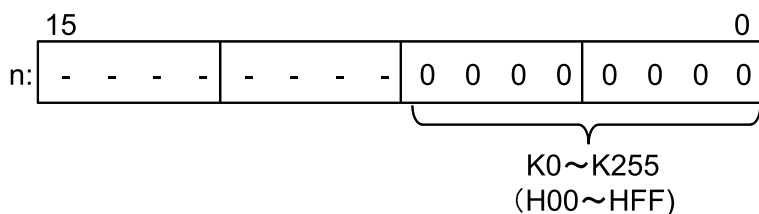

(Note 1) The bits marked with - are invalid.

■ Operation example

Operation of instruction format description program

When internal relay R0 turns ON, the content of DT0 shifts four bits to the left. The content of bit 12 before the shift is stored in the CY (carry) flag.

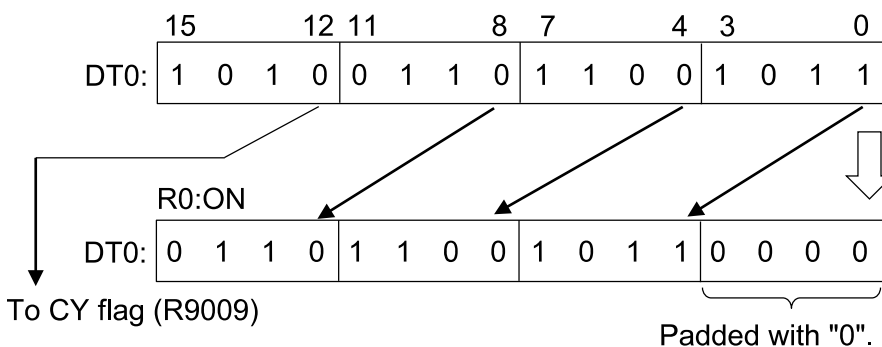

■ Flag operations

Name	Description
R9007 R9008 (ER)	Turns ON when the area is exceeded in index modification.
R9009 (CY)	Turns ON when the content of the nth bit from the most significant bit is "1"

16.3 F102 DSHR (32-bit Data Right Shift)

16.3 F102 DSHR (32-bit Data Right Shift)

Shifts 32-bit data (double-word data) n bits to the right.

■ Instruction format

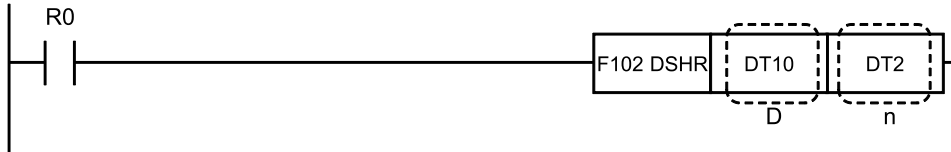

■ Operands

Items	Settings
D	Area storing the double-word data to be shifted (two words)
n	Area storing the number of bits to be shifted, or constant data

■ Devices that can be specified (indicated by ●)

Operands	WX	WY	WR	WL	SV	EV	DT	LD	I	SW R	SD T	Constant				Index modifier	Integer Device
												K	H	M	f		
D		●	●	●	●	●	●	●	●						●		
n	●	●	●	●	●	●	●	●	●	●	●	●			●		

■ Outline of operation

- The double-word data specified by $[D, D+1]$ is shifted to the right (in the low bit direction) by the number of bits specified by $[n]$ (16-bit K constant).

n bits shifted to the right

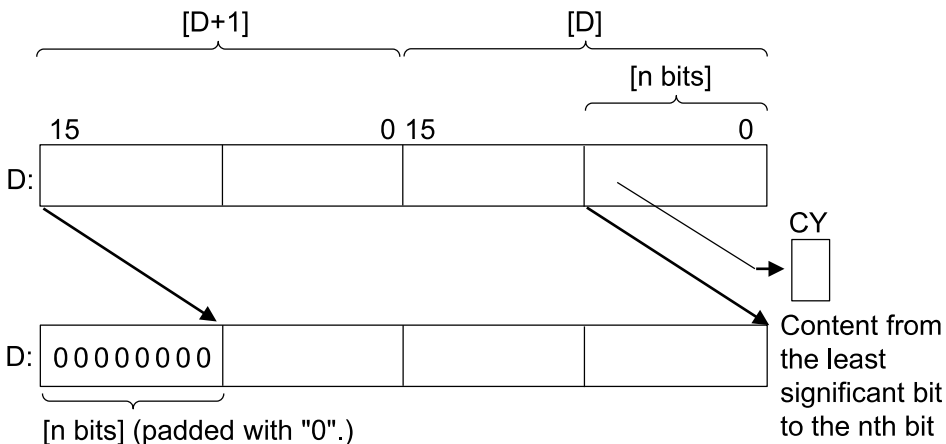

- When the data is shifted to the right,
 - the n bits from the most significant bit are filled with 0.
 - The content from the least significant bit to the n th bit is stored in the CY (carry) flag (R9009).

- For [n], only the lower 8 bits of the 16-bit data are valid. The shift amount can be selected from 1 bit to 255 bits.

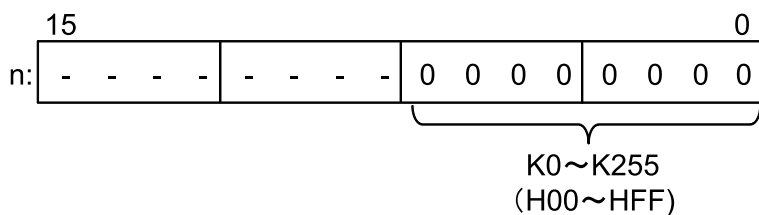

(Note 1) The bits marked with - are invalid.

- When [n] = K0, the content of [D, D+1] and the CY flag do not change.
- When [n] is specified as K32 or higher, the content of [D, D+1] changes to 0.

■ Flag operations

Name	Description
R9007 R9008 (ER)	Turns ON when the area is exceeded in index modification.
R9009 (CY)	Reflects the content of the nth bit from the least significant bit immediately before the instruction is executed.

16.4 F103 DSHL (32-bit Data Left Shift)

16.4 F103 DSHL (32-bit Data Left Shift)

Shifts 32-bit data (double-word data) n bits to the left.

■ Instruction format

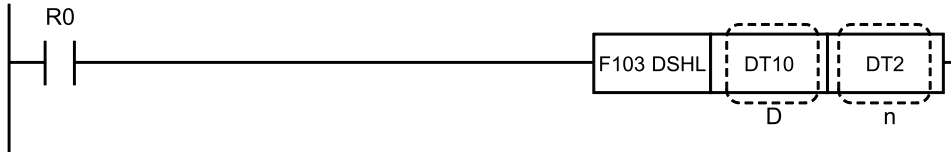

■ Operands

Items	Settings
D	Area storing the double-word data to be shifted (two words)
n	Area storing the number of bits to be shifted, or constant data

■ Devices that can be specified (indicated by ●)

Operands	WX	WY	WR	WL	SV	EV	DT	LD	I	SW R	SD T	Constant				Index modifier	Integer Device
												K	H	M	f		
D		●	●	●	●	●	●	●	●						●		
n	●	●	●	●	●	●	●	●	●	●	●	●			●		

■ Outline of operation

- The double-word data specified by [D, D+1] is shifted to the left (in the high bit direction) by the number of bits specified by [n] (16-bit K constant).

n bits shifted to the left

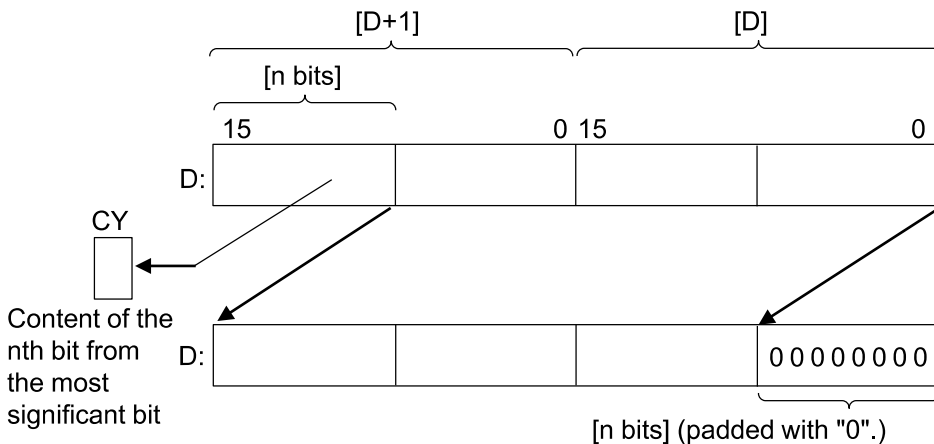

- When the data is shifted to the left,
 - the n bits from the least significant bit are filled with 0.
 - The content from the most significant bit to the n th bit is stored in the CY (carry) flag (R9009).

- For [n], only the lower 8 bits of the 16-bit data are valid. The shift amount can be selected from 1 bit to 255 bits.

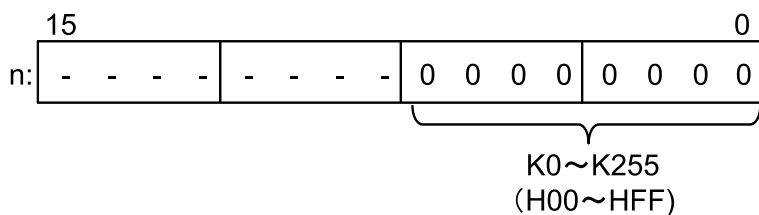

(Note 1) The bits marked with - are invalid.

- When $[n] = K0$, the content of $[D, D+1]$ and the CY flag do not change.
- When $[n]$ is specified as $K32$ or higher, the content of $[D, D+1]$ changes to 0.

■ Flag operations

Name	Description
R9007 R9008 (ER)	Turns ON when the area is exceeded in index modification.
R9009 (CY)	Reflects the content of the nth bit from the most significant bit immediately before the instruction is executed.

16.5 F105 BSR (16-bit Data 1-Digit Right Shift)

16.5 F105 BSR (16-bit Data 1-Digit Right Shift)

Shifts 16-bit data one digit (four bits) to the right.

■ Instruction format

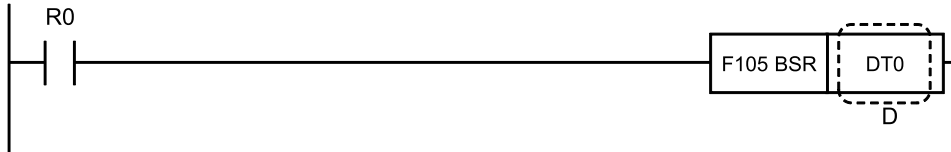

■ Operands

Items	Settings
D	Area storing the 16-bit data to be shifted

■ Devices that can be specified (indicated by ●)

Operands	WX	WY	WR	WL	SV	EV	DT	LD	I	SWR	SDT	Constant				Index modifier	Integer Device
												K	H	M	f		
D		●	●	●	●	●	●	●	●							●	

■ Outline of operation

- The 16-bit data (four digits) specified by [D] is shifted one digit (four bits) to the right (downward direction).

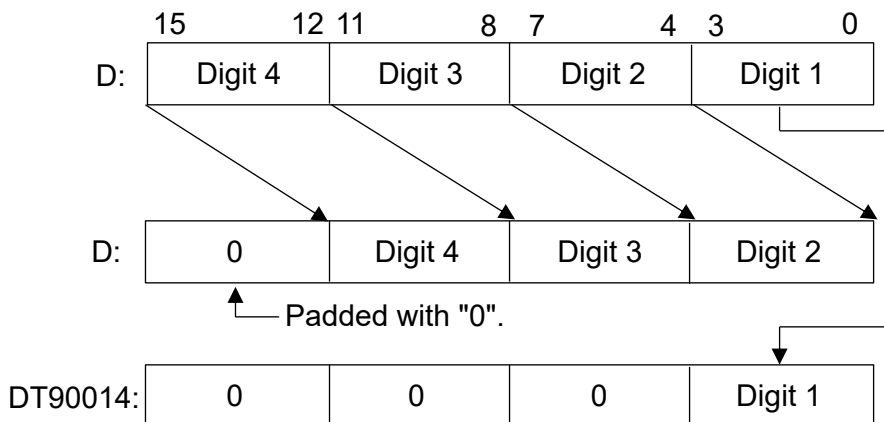

- When the data is shifted to the right,
 - bits 0 to 3 (Digit 1) before the shift are stored in bits 0 to 3 of special data register DT90014.
 - After the shift, bits 12 to 15 are filled with 0.

■ **Operation example**

Operation of instruction format description program

When internal relay R0 turns ON, the content of DT0 shifts one digit to the right. The content of bits 0 to 3 before the shift are stored in bits 0 to 3 of DT90014.

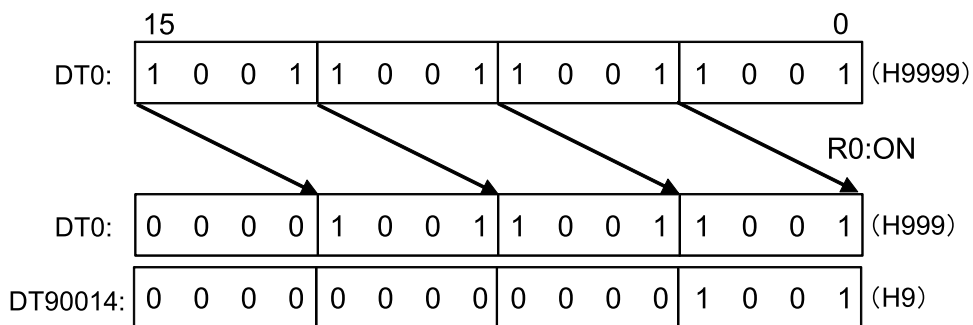

■ **Flag operations**

Name	Description
R9007 R9008 (ER)	Turns ON when the area is exceeded in index modification.

16.6 F106 BSL (16-bit Data 1-Digit Left Shift)

16.6 F106 BSL (16-bit Data 1-Digit Left Shift)

Shifts 16-bit data one digit (four bits) to the left.

■ Instruction format

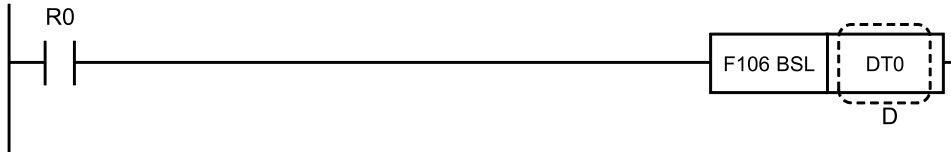

■ Operands

Items	Settings
D	Area storing the 16-bit data to be shifted

■ Devices that can be specified (indicated by ●)

Operands	WX	WY	WR	WL	SV	EV	DT	LD	I	SWR	SDT	Constant				Index modifier	Integer Device
												K	H	M	f		
D		●	●	●	●	●	●	●	●							●	

■ Outline of operation

- The 16-bit data (four digits) specified by [D] is shifted one digit (four bits) to the left (upward direction).

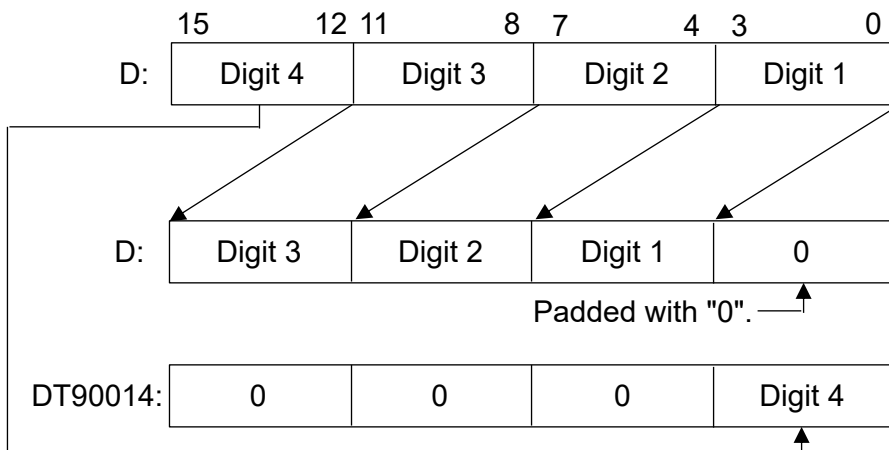

- When the data is shifted to the left,
 - bits 12 to 15 before the shift are stored in bits 0 to 3 of special data register DT90014.
 - After the shift, bits 0 to 3 are filled with 0.

■ Operation example

Operation of instruction format description program

When internal relay R0 turns ON, the content of DT0 shifts one digit to the left. The contents of bits 12 to 15 before the shift are stored in bits 0 to 3 of DT90014.

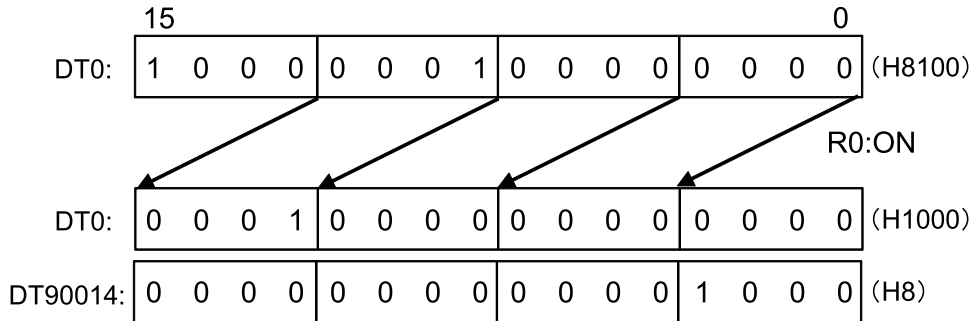

■ Flag operations

Name	Description
R9007 R9008 (ER)	Turns ON when the area is exceeded in index modification.

16.7 F108 BITR (Block Area Bitwise Right Shift)

16.7 F108 BITR (Block Area Bitwise Right Shift)

Shifts a block area to the right in bit units.

■ Instruction format

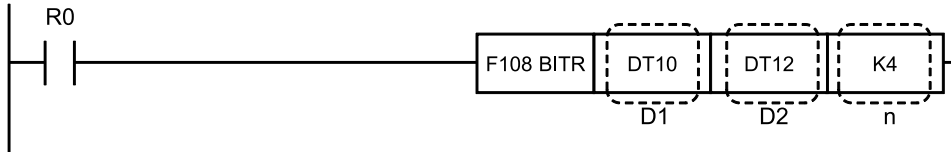

■ Operands

Items	Settings
D1	Starting address of the area to be shifted
D2	Ending address of the area to be shifted
n	Area storing the number of bits to be shifted, or constant data

■ Devices that can be specified (indicated by ●)

Operands	WX	WY	WR	WL	SV	EV	DT	LD	I	SWR	SDT	Constant				Index modifier	Integer Device
												K	H	M	f		
D1		●	●	●	●	●	●	●	●							●	
D2		●	●	●	●	●	●	●	●							●	
n	●	●	●	●	●	●	●	●	●	●	●	●	●			●	

■ Outline of operation

- The area in the range specified by [D1] and [D2] is shifted to the right by the number of bits specified by [n].

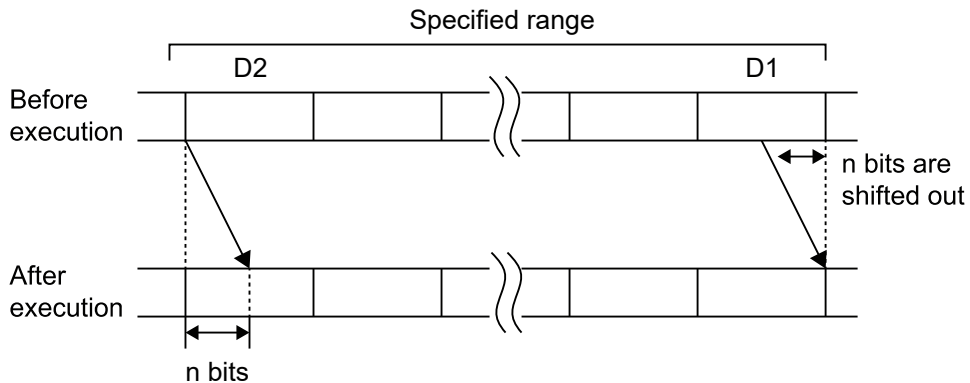

- The starting address of the area to be shifted is specified by [D1] and the ending address is specified by [D2].
- Specify the same type of area for both [D1] and [D2]. Also, specify values so that D1 is equal to or smaller than D2.

- When the data is shifted to the right,
 1. the lower n bits of [D1] before the shift are shifted out.
 2. After the shift, the upper n bits of [D2] are filled with 0.
- No operation takes place if [n] = 0.
- If [n] is set to a number of bits that exceeds the area in the range specified by [D1] and [D2], the value of the area from [D1] to [D2] is 0.

■ Operation example

Operation of instruction format description program

When internal relay R0 turns ON, the three-word data in DT10 to DT12 is shifted four bits to the right

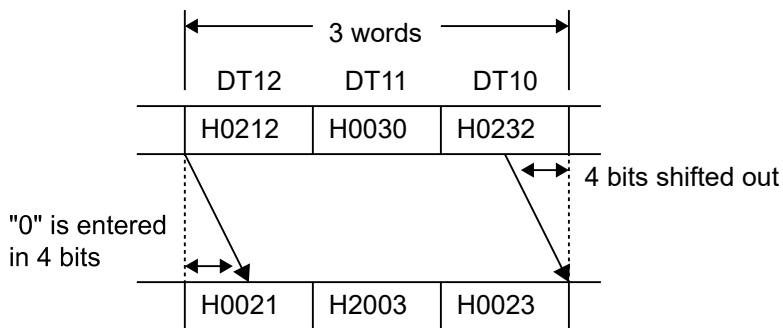

■ Flag operations

Name	Description
R9007	Turns ON when the area is exceeded in index modification.
R9008 (ER)	Turns ON when [D1] > [D2]

16.8 F109 BITL (Block Area Bitwise Left Shift)

16.8 F109 BITL (Block Area Bitwise Left Shift)

Shifts a block area left in bit units.

■ Instruction format

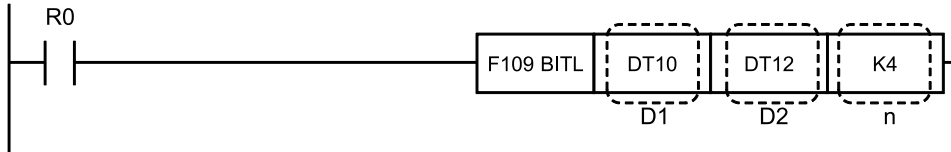

■ Operands

Items	Settings
D1	Starting address of the area to be shifted
D2	Ending address of the area to be shifted
n	Area storing the number of bits to be shifted, or constant data

■ Devices that can be specified (indicated by ●)

Operands	WX	WY	WR	WL	SV	EV	DT	LD	I	SWR	SDT	Constant				Index modifier	Integer Device
												K	H	M	f		
D1		●	●	●	●	●	●	●	●							●	
D2		●	●	●	●	●	●	●	●							●	
n	●	●	●	●	●	●	●	●	●	●	●	●	●			●	

■ Outline of operation

- The area in the range specified by [D1] and [D2] is shifted left by the number of bits specified by [n].

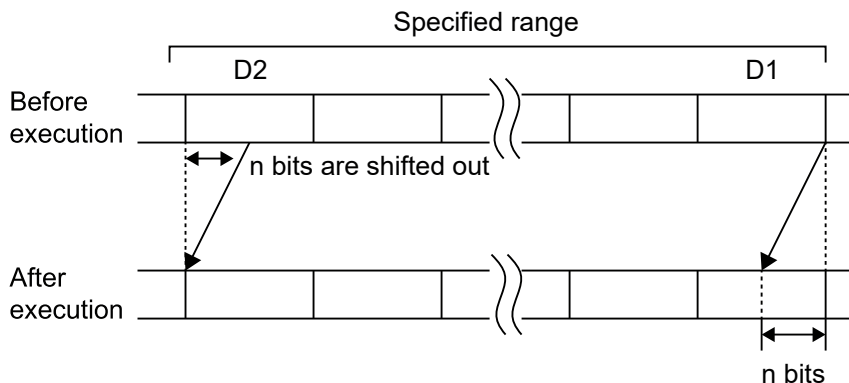

- The starting address of the area to be shifted is specified by [D1] and the ending address is specified by [D2].
- Specify the same type of area for both [D1] and [D2]. Also, specify values so that D1 is equal to or smaller than D2.

- When the data is shifted to the left,
 1. the upper n bits of [D2] before the shift are shifted out.
 2. After the shift, the lower n bits of [D1] are filled with 0.
- No operation takes place if [n] = 0.
- If [n] is set to a number of bits that exceeds the area in the range specified by [D1] and [D2], the value of the area from [D1] to [D2] is 0.

■ Operation example

Operation of instruction format description program

When internal relay R0 turns ON, the three-word data in DT10 to DT12 is shifted four bits to the left.

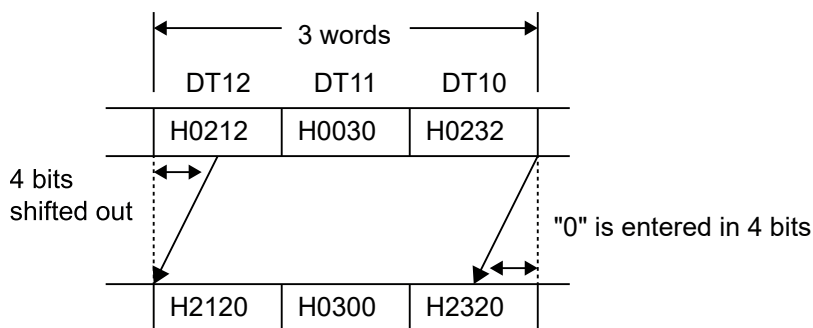

■ Flag operations

Name	Description
R9007	Turns ON when the area is exceeded in index modification.
R9008 (ER)	Turns ON when [D1] > [D2]

16.9 F110 WSHR (Block Area 1 Word Right Shift)

16.9 F110 WSHR (Block Area 1 Word Right Shift)

Shifts the specified data range one word to the right.

■ Instruction format

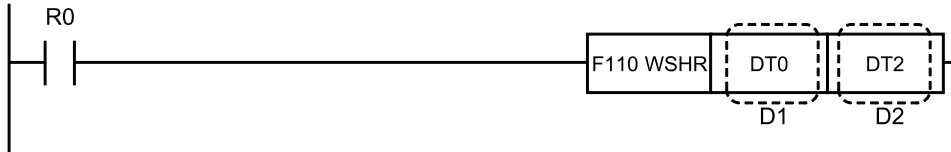

■ Operands

Items	Settings
D1	Starting address of the area to be shifted
D2	Ending address of the area to be shifted

■ Devices that can be specified (indicated by ●)

Operands	WX	WY	WR	WL	SV	EV	DT	LD	I	SWR	SDT	Constant				Index modifier	Integer Device
												K	H	M	f		
D1		●	●	●	●	●	●	●								●	
D2		●	●	●	●	●	●	●								●	

■ Outline of operation

- The area of the range specified by [D1] and [D2] is shifted one word to the right (downward direction).

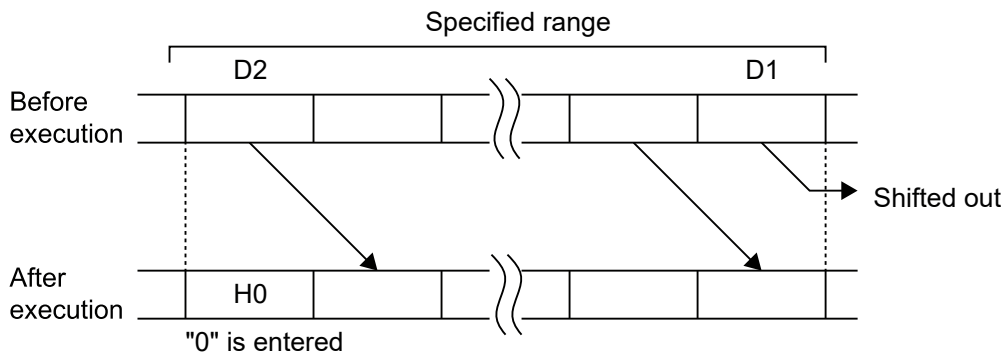

- The starting address of the area to be shifted is specified by [D1] and the ending address is specified by [D2].
- Specify the same type of area for both [D1] and [D2]. Also, make sure that [D1] address \leq [D2] address.
- When the data is shifted to the right,
 1. the content of [D1] before the shift is lost.
 2. After the shift, [D2] is filled with H0.

■ **Operation example**

Operation of instruction format description program

When internal relay R0 turns ON, the three-word data in DT0 to DT2 is shifted one word to the right.

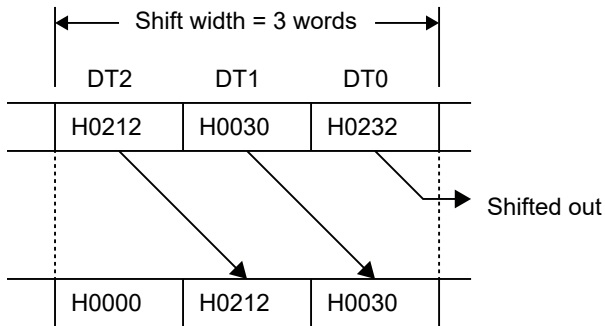

■ **Flag operations**

Name	Description
R9007	Turns ON when the area is exceeded in index modification.
R9008 (ER)	Turns ON when the [D1] address > [D2] address

16.10 F111 WSHL (Block Area 1 Word Left Shift)

16.10 F111 WSHL (Block Area 1 Word Left Shift)

Data in the specified range is shifted one word to the left.

■ Instruction format

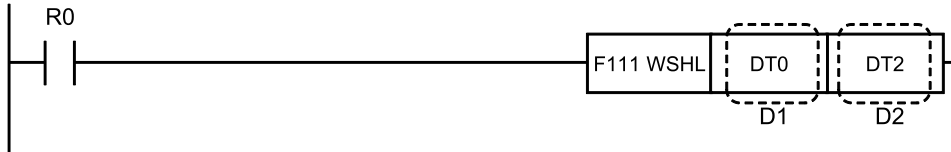

■ Operands

Items	Settings
D1	Starting address of the area to be shifted
D2	Ending address of the area to be shifted

■ Devices that can be specified (indicated by ●)

Operands	WX	WY	WR	WL	SV	EV	DT	LD	I	SW R	SD T	Constant				Index modifier	Integer Device
												K	H	M	f		
D1		●	●	●	●	●	●	●								●	
D2		●	●	●	●	●	●	●								●	

■ Outline of operation

- The range area specified by [D1] and [D2] is shifted to the left (upper direction) by one word.

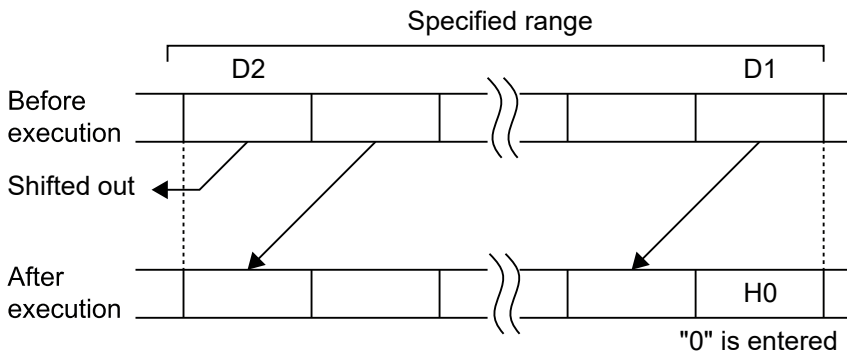

- The starting address of the area to be shifted is specified by [D1] and the ending address is specified by [D2].
- Specify the same type of area for both [D1] and [D2]. Also, make sure that [D1] address \leq [D2] address.
- When the data is shifted to the left,
 - the content of [D2] before the shift is lost.
 - After the shift, [D1] is filled with H0.

■ **Operation example**

Operation of instruction format description program

Three-word data from DT0 to DT2 is shifted one word to the left when internal relay R0 turns ON.

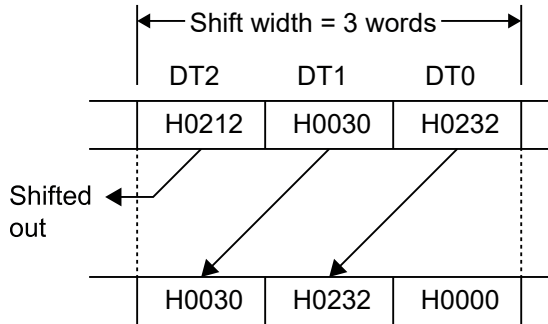

■ **Flag operations**

Name	Description
R9007	Turns ON when the area is exceeded in index modification.
R9008 (ER)	Turns ON when the [D1] address > [D2] address

16.11 F112 WBSR (Block Area 1 Digit Right Shift)

16.11 F112 WBSR (Block Area 1 Digit Right Shift)

Data in the specified range is shifted 1 digit to the right.

■ Instruction format

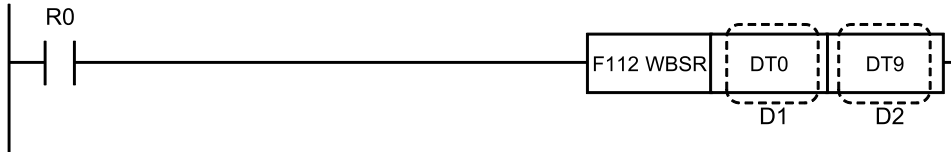

■ Operands

Items	Settings
D1	Starting address of the area to be shifted
D2	Ending address of the area to be shifted

■ Devices that can be specified (indicated by ●)

Operands	WX	WY	WR	WL	SV	EV	DT	LD	I	SWR	SDT	Constant				Index modifier	Integer Device
												K	H	M	f		
D1		●	●	●	●	●	●	●								●	
D2		●	●	●	●	●	●	●								●	

■ Outline of operation

- The area of the range specified in [D1] and [D2] is shifted to the right (lower direction) by 1 digit (4 bits).

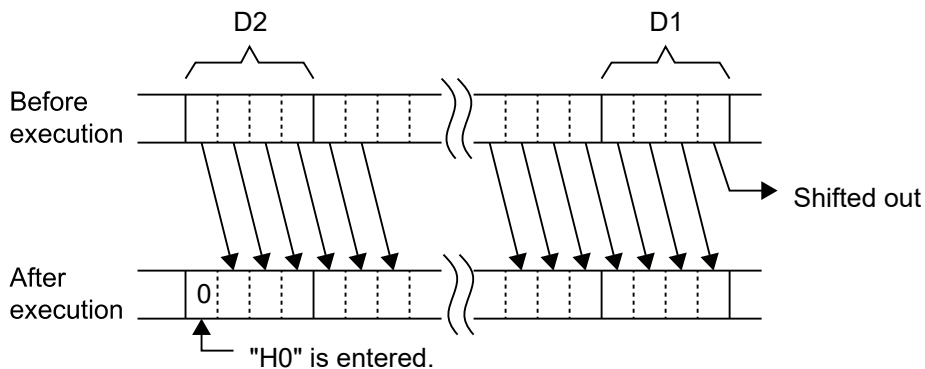

- The starting address of the area to be shifted is specified by [D1] and the ending address is specified by [D2].
- Specify the same type of area for both [D1] and [D2]. Also, make sure that [D1] address \leq [D2] address.
- When the data is shifted to the right,
 1. the content of bits 0 to 3 (Digit 1) of [D1] before the shift is lost.
 2. After the shift, bits 12 to 15 of [D2] (Digit 4) are filled with "0".

■ Operation example

Operation of instruction format description program

When internal relay R0 is ON, 10 word data of DT0 to DT9 is shifted 1 digit to the right.

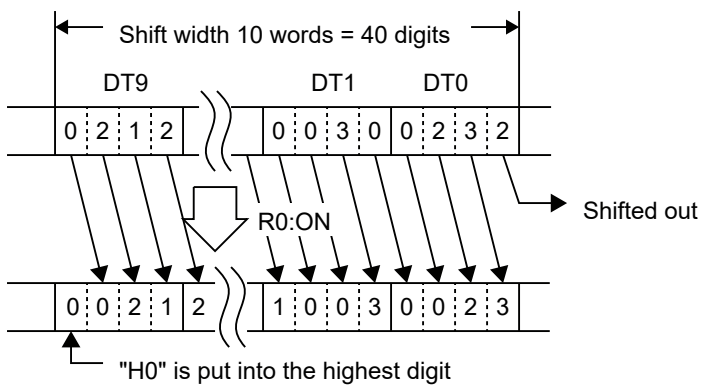

■ Flag operations

Name	Description
R9007	Turns ON when the area is exceeded in index modification.
R9008 (ER)	Turns ON when the [D1] address > [D2] address

16.12 F113 WBSL (Block Area 1 Digit Left Shift)

16.12 F113 WBSL (Block Area 1 Digit Left Shift)

Shifts data in a specified range one digit to the left.

■ Instruction format

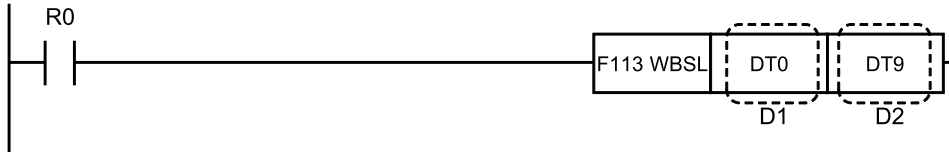

■ Operands

Items	Settings
D1	Starting address of the area to be shifted
D2	Ending address of the area to be shifted

■ Devices that can be specified (indicated by ●)

Operands	WX	WY	WR	WL	SV	EV	DT	LD	I	SWR	SDT	Constant				Index modifier	Integer Device
												K	H	M	f		
D1		●	●	●	●	●	●	●								●	
D2		●	●	●	●	●	●	●								●	

■ Outline of operation

- Shifts an area of a range specified in [D1] and [D2] one digit (4 bits) to the left (toward the higher digit).

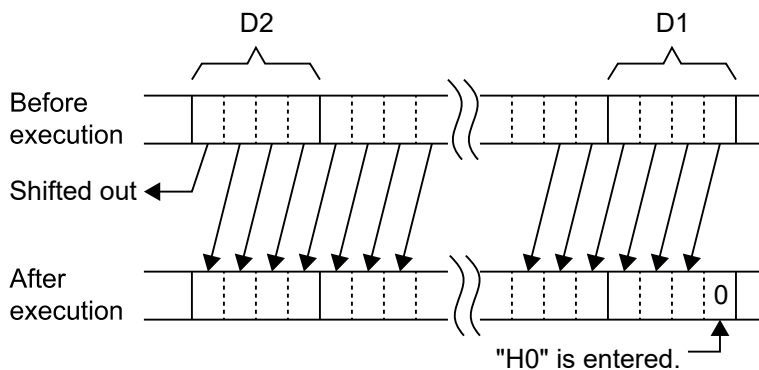

- The starting address of the area to be shifted is specified by [D1] and the ending address is specified by [D2].
- Specify the same type of area for both [D1] and [D2]. Also, make sure that [D1] address \leq [D2] address.
- When the data is shifted to the left,
 - the content of bits 12 to 15 (Digit 4) of [D2] before the shift is lost.
 - After the shift, bits 0 to 3 of [D1] (Digit 1) are filled with "0".

■ **Operation example**

Operation of instruction format description program

When the internal relay R0 is ON, the data of 10 words from DT0 to DT9 is shifted to the left by one digit.

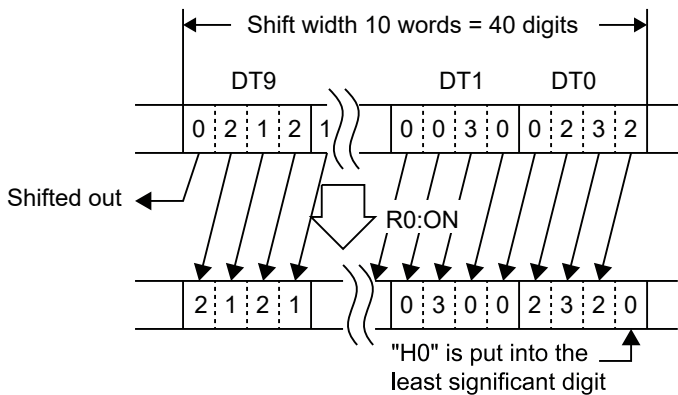

■ **Flag operations**

Name	Description
R9007	Turns ON when the area is exceeded in index modification.
R9008 (ER)	Turns ON when the [D1] address > [D2] address

(MEMO)

17 Data Rotation Instructions

17.1 F120 ROR (16-Bit Data Rotation to the Right).....	17-2
17.2 F121 ROL (16-Bit Data Rotation to the Left)	17-4
17.3 F122 RCR (16-bit Data Right Rotation with Carry).....	17-6
17.4 F123 RCL (16-bit Data Left Rotation with Carry).....	17-8
17.5 F125 DROR [32-Bit Data Right Rotation]	17-10
17.6 F126 DROL (32-bit data left rotation).....	17-12
17.7 F127 DRCR (32-bit Data Right Rotation with Carry)	17-14
17.8 F128 DRCL (32-bit Data Left Rotation with Carry)	17-16

17.1 F120 ROR (16-Bit Data Rotation to the Right)

17.1 F120 ROR (16-Bit Data Rotation to the Right)

Rotates the specified 16-bit data to the right.

■ Instruction format

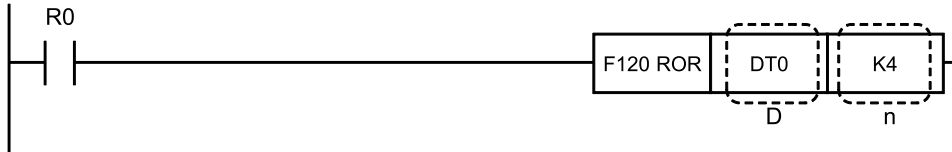

■ Operands

Items	Settings
D	Area targeted for rotation
n	Area storing the number of bits specified to be rotated, or constant data

■ Devices that can be specified (indicated by ●)

Operands	WX	WY	WR	WL	SV	EV	DT	LD	I	SWR	SDT	Constant				Index modifier	Integer Device
												K	H	M	f		
D		●	●	●	●	●	●	●	●						●		
n	●	●	●	●	●	●	●	●	●	●	●	●			●		

■ Outline of operation

- The 16-bit data specified by [D] is rotated to the right (in the low bit direction) by the number of bits specified by [n].

Example of rotation 1 bit to the right

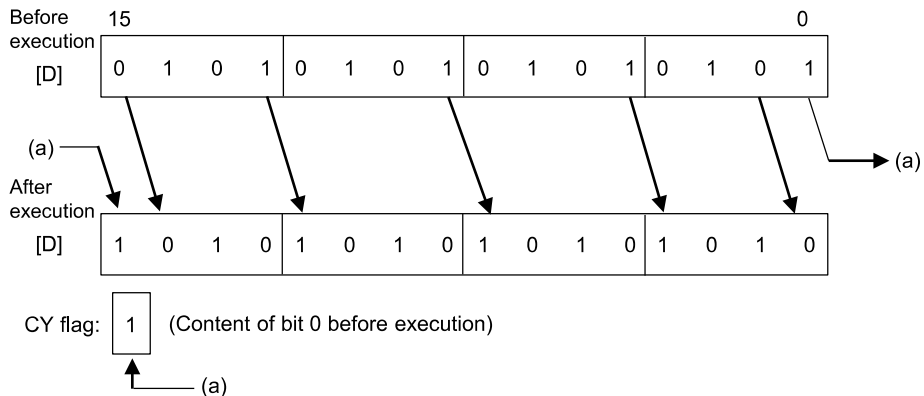

- When rotated to the right, the content of the bit that is 1 bit below the bit that moves to the least significant bit when rotated is stored in the CY flag (R9009). This bit is moved to the most significant bit as a result of rotation.
- For [n], only the lower 8 bits of the 16-bit data are valid.

17.1 F120 ROR (16-Bit Data Rotation to the Right)

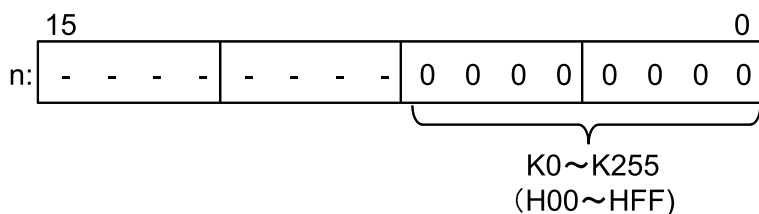

(Note 1) The bits marked with - are invalid.

■ Operation example

Operation of instruction format description program

When internal relay R0 turns ON, the content of data register DT0 is rotated 4 bits to the right.

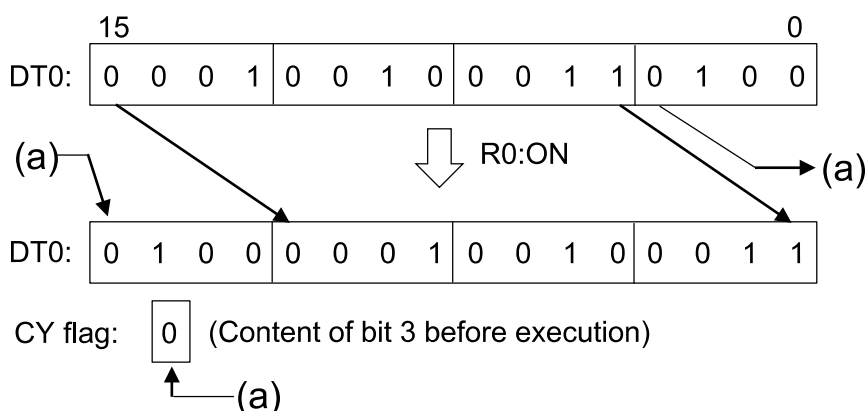

■ Precautions for programming

For the value of n, the operation is the same for every multiple of 16.

e.g.

When n = 16, the operation is the same as when n = 0 (the CY flag does not change either)

When n = 17, the operation is the same as when n = 1

When n = 32, the operation is the same as when n = 0 (the CY flag does not change either)

When n = 33, the operation is the same as when n = 1

■ Flag operations

Name	Description
R9007 R9008 (ER)	Turns ON when the area is exceeded in index modification.
R9009 (CY)	Turns ON when the instruction is executed when the [n]th bit from the least significant bit is "1" before execution

17.2 F121 ROL (16-Bit Data Rotation to the Left)

17.2 F121 ROL (16-Bit Data Rotation to the Left)

Rotates the specified 16-bit data to the left.

■ Instruction format

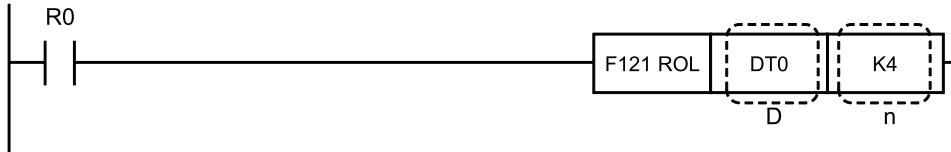

■ Operands

Items	Settings
D	Area targeted for rotation
n	Area storing the number of bits specified to be rotated, or constant data

■ Devices that can be specified (indicated by ●)

Operands	WX	WY	WR	WL	SV	EV	DT	LD	I	SWR	SDT	Constant				Index modifier	Integer Device
												K	H	M	f		
D		●	●	●	●	●	●	●	●						●		
n	●	●	●	●	●	●	●	●	●	●	●	●			●		

■ Outline of operation

- The 16-bit data specified by [D] is rotated to the left (in the high bit direction) by the number of bits specified by [n].

Example of rotation 1 bit to the left

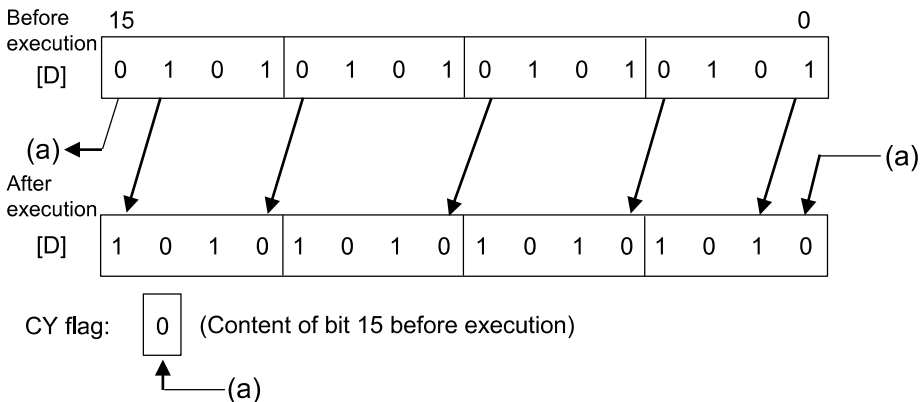

- When rotated to the left, the content of the bit that is 1 bit above the bit that moves to the most significant bit when rotated is stored in the CY flag (R9009). This bit is moved to the least significant bit as a result of rotation.
- For [n], only the lower 8 bits of the 16-bit data are valid.

17.2 F121 ROL (16-Bit Data Rotation to the Left)

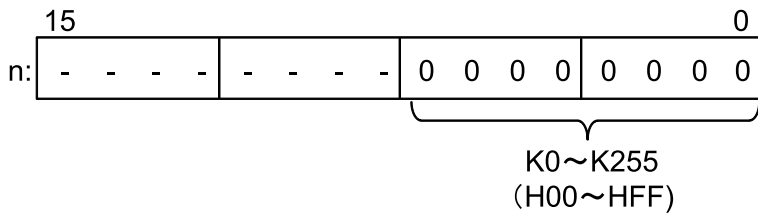

(Note 1) The bits marked with - are invalid.

■ Operation example

Operation of instruction format description program

When internal relay R0 turns ON, the content of data register DT0 is rotated 4 bits to the left.

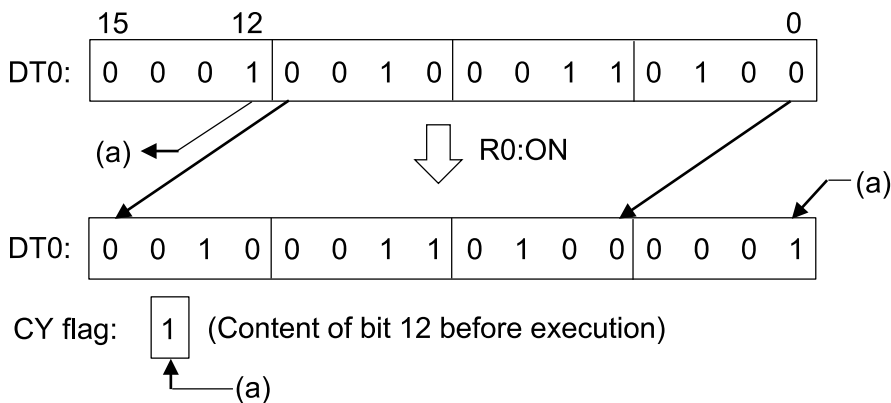

■ Precautions for programming

For the value of n, the operation is the same for every multiple of 16.

e.g.

When n = 16, the operation is the same as when n = 0 (the CY flag does not change either)

When n = 17, the operation is the same as when n = 1

When n = 32, the operation is the same as when n = 0 (the CY flag does not change either)

When n = 33, the operation is the same as when n = 1

■ Flag operations

Name	Description
R9007 R9008 (ER)	Turns ON when the area is exceeded in index modification.
R9009 (CY)	Turns ON when the instruction is executed when the [n]th bit from the most significant bit is "1" before execution

17.3 F122 RCR (16-bit Data Right Rotation with Carry)

17.3 F122 RCR (16-bit Data Right Rotation with Carry)

Rotate 17 bits of data made up of the specified 16-bit data and the carry flag to the right.

■ Instruction format

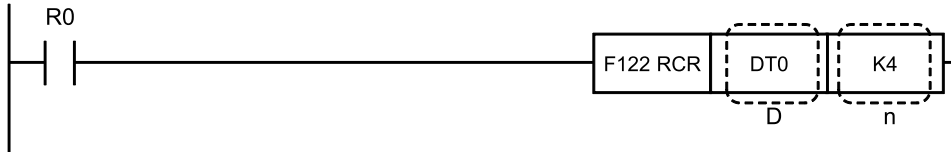

■ Operands

Items	Settings
D	Area targeted for rotation
n	Area storing the number of bits specified to be rotated, or constant data

■ Devices that can be specified (indicated by ●)

Operands	WX	WY	WR	WL	SV	EV	DT	LD	I	SWR	SDT	Constant				Index modifier	Integer Device
												K	H	M	f		
D		●	●	●	●	●	●	●	●							●	
n	●	●	●	●	●	●	●	●	●	●	●	●	●			●	

■ Outline of operation

- The 16-bit data specified by [D] is rotated to the right (in the low bit direction) by the number of bits specified by [n], including the CY (carry) flag (R9009).

Example of rotation 1 bit to the right

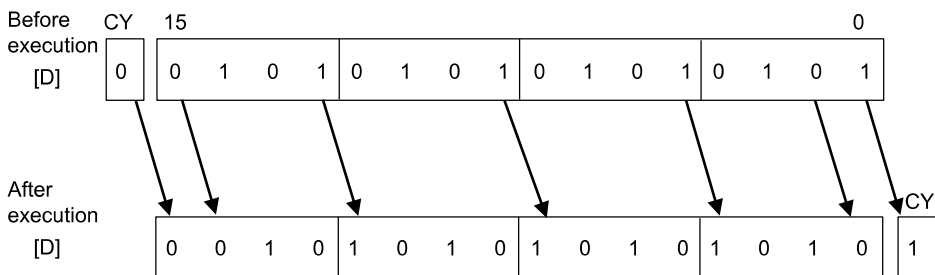

- When the data is rotated to the right,
 1. the content of the bit that is 1 bit lower than the bit that moves to the least significant bit when rotated is stored in the CY flag (R9009).
 2. The content of the CY flag (R9009) before the rotation is stored in the [n]th bit from the most significant bit.
- For [n], only the lower 8 bits of the 16-bit data are valid.

17.3 F122 RCR (16-bit Data Right Rotation with Carry)

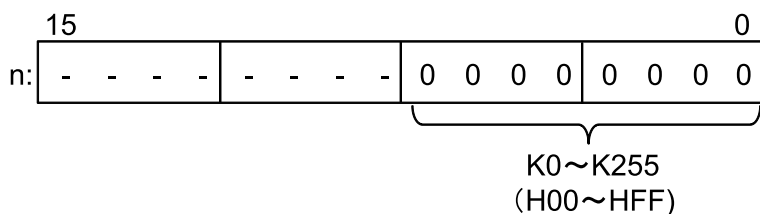

(Note 1) The bits marked with - are invalid.

■ Operation example

Operation of instruction format description program

When internal relay R0 turns ON, the content of data register DT0 is rotated 4 bits to the right. (The CY value immediately before execution is assumed to be 1.)

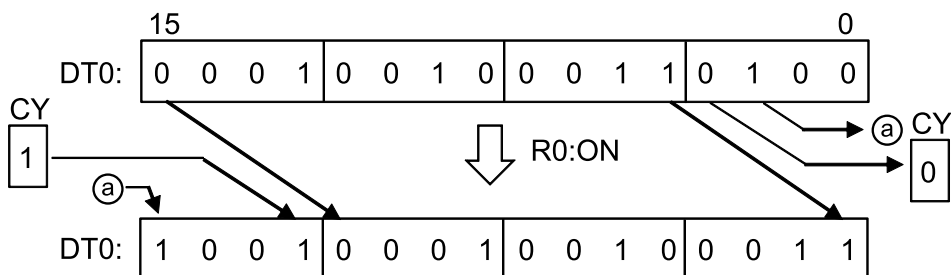

■ Precautions for programming

For the value of n, the operation is the same for every multiple of 17.

e.g.

When n = 17, the operation is the same as when n = 0

When n = 18, the operation is the same as when n = 1

When n = 34, the operation is the same as when n = 0

When n = 35, the operation is the same as when n = 1

■ Flag operations

Name	Description
R9007 R9008 (ER)	Turns ON when the area is exceeded in index modification.
R9009 (CY)	Turns ON when the instruction is executed when the [n]th bit from the least significant bit is "1" before execution

17.4 F123 RCL (16-bit Data Left Rotation with Carry)

17.4 F123 RCL (16-bit Data Left Rotation with Carry)

Rotates 17-bit data, consisting of specified 16-bit data with carry flag data added, to the left.

■ Instruction format

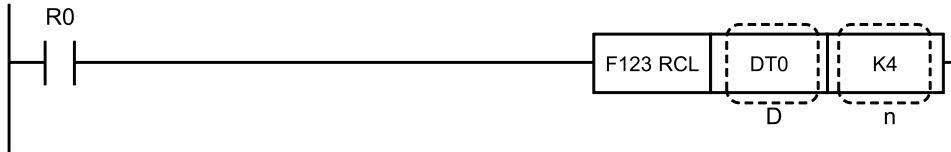

■ Operands

Items	Settings
D	Area targeted for rotation
n	Area storing the number of bits specified to be rotated, or constant data

■ Devices that can be specified (indicated by ●)

Operands	WX	WY	WR	WL	SV	EV	DT	LD	I	SWR	SDT	Constant				Index modifier	Integer Device
												K	H	M	f		
D		●	●	●	●	●	●	●	●						●		
n	●	●	●	●	●	●	●	●	●	●	●	●			●		

■ Outline of operation

- Rotates 16-bit data specified by [D], including CY (carry) flag (R9009) data, to the left (toward higher bits) by the number of bits specified by [n].

Example of rotation 1 bit to the left

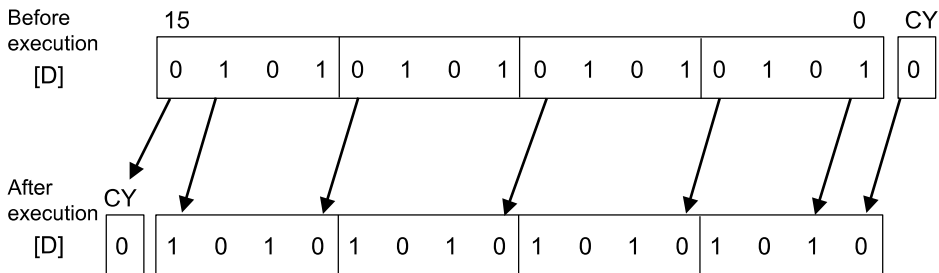

- When the data is rotated to the left,
 - the content of the bit that is 1 bit higher than the bit that moves to the most significant bit when rotated is stored in the CY flag (R9009).
 - The content of the CY flag (R9009) before the rotation is stored in the [n]th bit from the least significant bit.
- For [n], only the lower 8 bits of the 16-bit data are valid.

17.4 F123 RCL (16-bit Data Left Rotation with Carry)

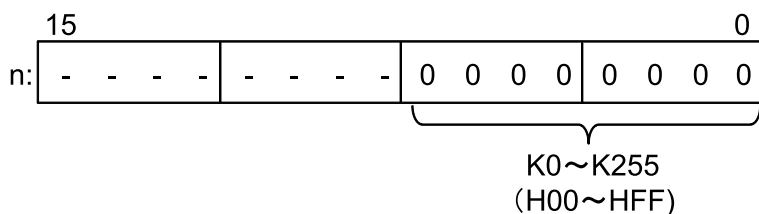

(Note 1) The bits marked with - are invalid.

■ Operation example

Operation of instruction format description program

When internal relay R0 turns ON, the content of data register DT0 is rotated 4 bits to the left. (The CY value immediately before execution is assumed to be 1.)

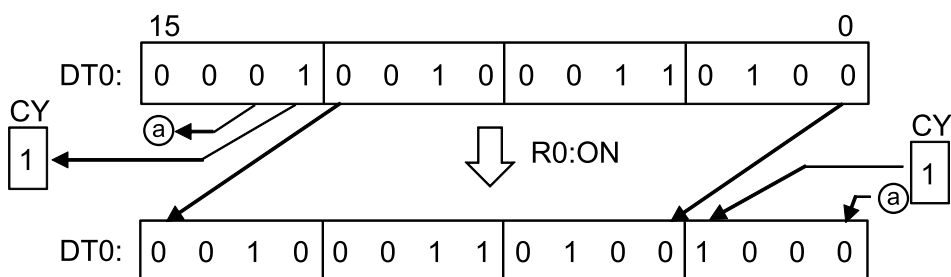

■ Precautions for programming

For the value of n, the operation is the same for every multiple of 17.

e.g.

When n = 17, the operation is the same as when n = 0

When n = 18, the operation is the same as when n = 1

When n = 34, the operation is the same as when n = 0

When n = 35, the operation is the same as when n = 1

■ Flag operations

Name	Description
R9007 R9008 (ER)	Turns ON when the area is exceeded in index modification.
R9009 (CY)	Turns ON when the instruction is executed when the [n]th bit from the most significant bit is "1" before execution

17.5 F125 DROR [32-Bit Data Right Rotation]

17.5 F125 DROR [32-Bit Data Right Rotation]

Rotates "n" bits of 32-bit data (double word data) to the right.

■ Instruction format

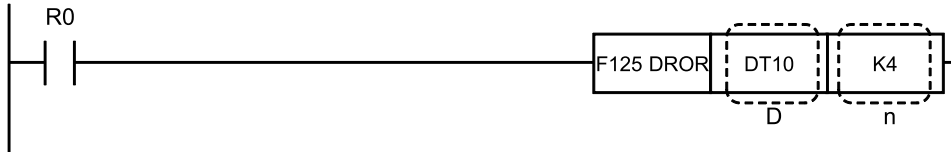

■ Operands

Items	Settings
D	Area to be rotated (two words)
n	Area storing the number of bits specified to be rotated, or constant data

■ Devices that can be specified (indicated by ●)

Operands	WX	WY	WR	WL	SV	EV	DT	LD	I	SWR	SDT	Constant				Index modifier	Integer Device
												K	H	M	f		
D		●	●	●	●	●	●	●	●						●		
n	●	●	●	●	●	●	●	●	●	●	●	●			●		

■ Outline of operation

- Rotates a number of bits specified by [n] of double word data specified by [D, D+1], to the right (toward lower bits).

Example of rotation 1 bit to the right

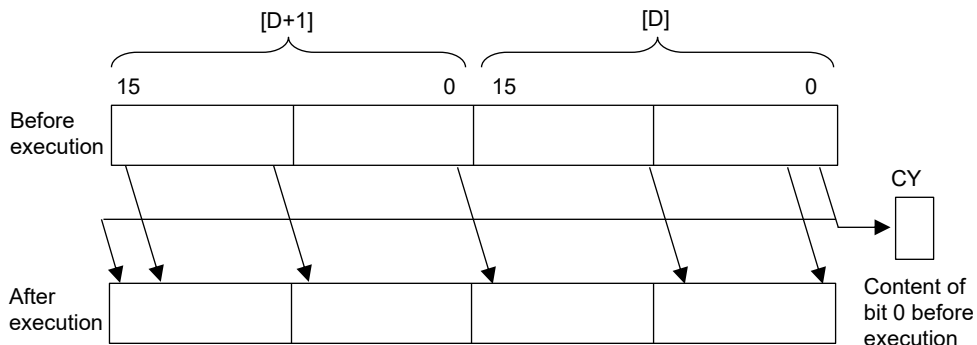

- When data is rotated to the right, the data which moves to 1 bit above the least significant bit position when rotation occurs is stored in the CY flag (R9009). This bit is moved to the most significant bit position as a result of the rotation.
- For [n], only the lower 8 bits of the 16-bit data are valid.

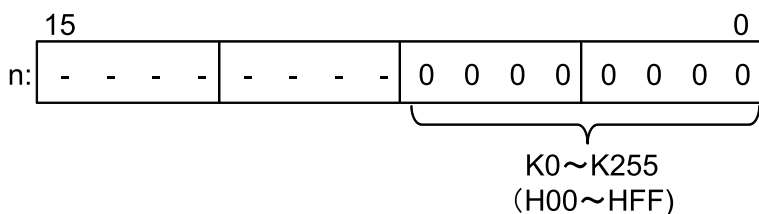

(Note 1) The bits marked with - are invalid.

- When $[n] = K0$, the contents of $[D, D+1]$ and the CY flag do not change.

■ Operation example

Operation of instruction format description program

When the internal relay R0 turns ON, the contents of DT11 and DT10 are rotated 4 bits to the right. The content of bit 3 before execution is stored in the CY flag.

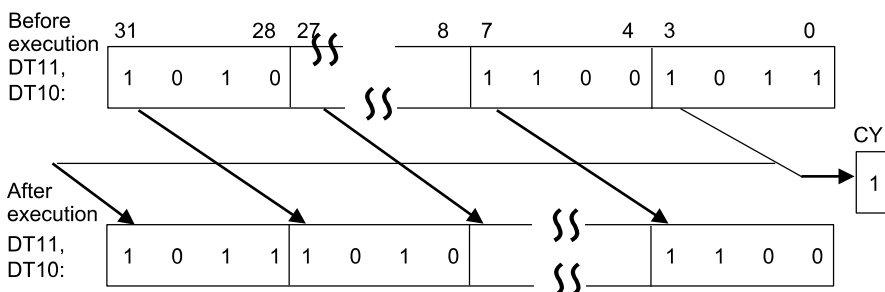

■ Precautions for programming

If n is a multiple of 32, this will result in the same operation as $n = 0$.

■ Flag operations

Name	Description
R9007 R9008 (ER)	Turns ON when the area is exceeded in index modification.
R9009 (CY)	Reflects the content of the n th bit from the least significant bit immediately before the instruction is executed.

17.6 F126 DROL (32-bit data left rotation)

17.6 F126 DROL (32-bit data left rotation)

Rotates 32-bit data (double word data) n bits to the left.

■ Instruction format

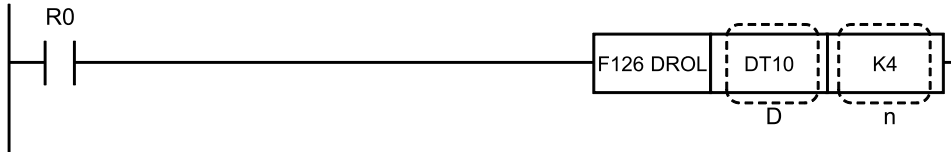

■ Operands

Items	Settings
D	Area to be rotated (two words)
n	Area storing the number of bits specified to be rotated, or constant data

■ Devices that can be specified (indicated by ●)

Operands	WX	WY	WR	WL	SV	EV	DT	LD	I	SWR	SDT	Constant				Index modifier	Integer Device
												K	H	M	f		
D		●	●	●	●	●	●	●	●						●		
n	●	●	●	●	●	●	●	●	●	●	●	●			●		

■ Outline of operation

- Rotates double word data specified by [D, D+1] a number of bits specified by [n] to the left (toward higher bits).

Example of rotation 1 bit to the left

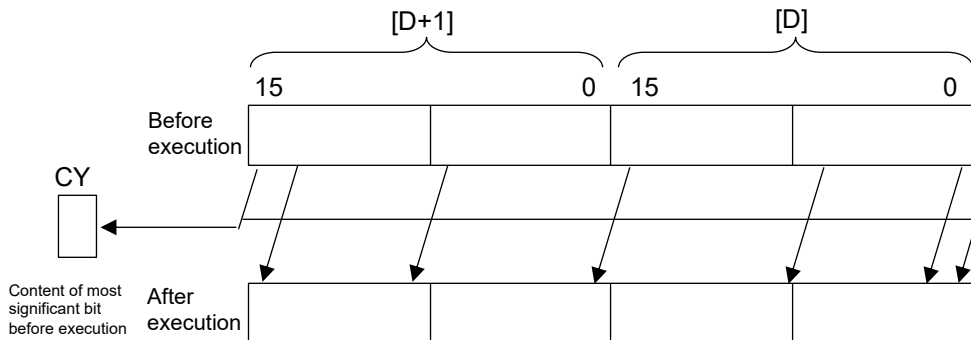

- When rotated to the left, the content of the bit that is 1 bit above the bit that moves to the most significant bit when rotated is stored in the CY flag (R9009). After rotation, this bit moves to the least significant bit.
- For [n], only the lower 8 bits of the 16-bit data are valid.

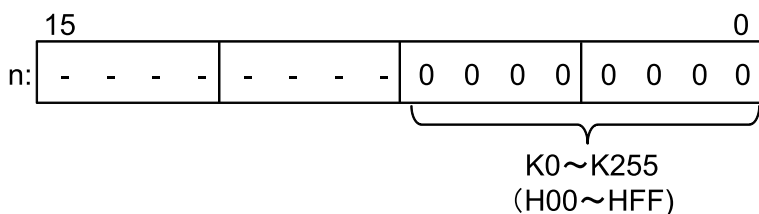

(Note 1) The bits marked with - are invalid.

- When $[n]=K0$, the contents of $[D, D+1]$ and the CY flag do not change.

■ Operation example

Operation of instruction format description program

When the internal relay R0 turns ON, the contents of DT11 and DT10 are rotated 4 bits to the left. The CY flag stores the contents of bit 28 from before execution.

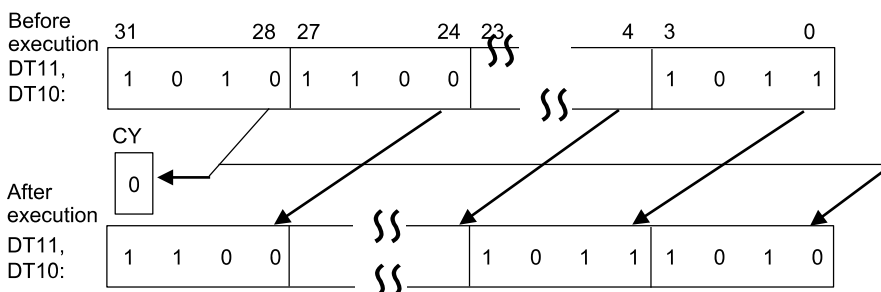

■ Precautions for programming

If n is a multiple of 32, this will result in the same operation as $n=0$.

■ Flag operations

Name	Description
R9007 R9008 (ER)	Turns ON when the area is exceeded in index modification.
R9009 (CY)	Reflects the content of the n th bit from the most significant bit immediately before the instruction is executed.

17.7 F127 DRCR (32-bit Data Right Rotation with Carry)

17.7 F127 DRCR (32-bit Data Right Rotation with Carry)

Rotates 32-bit data (double-word data) n bits to the right together with carry data.

■ Instruction format

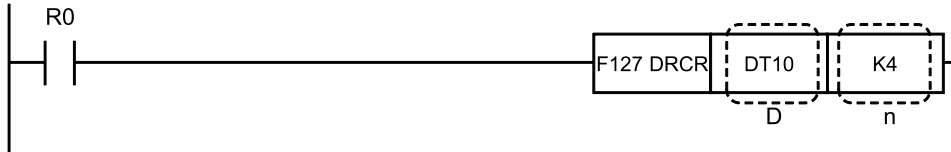

■ Operands

Items	Settings
D	Area to be rotated (two words)
n	Area storing the number of bits specified to be rotated, or constant data

■ Devices that can be specified (indicated by ●)

Operands	WX	WY	WR	WL	SV	EV	DT	LD	I	SWR	SDT	Constant				Index modifier	Integer Device
												K	H	M	f		
D		●	●	●	●	●	●	●	●						●		
n	●	●	●	●	●	●	●	●	●	●	●	●			●		

■ Outline of operation

- The double-word data specified by [D, D+1] is rotated to the right (in the low bit direction) by the number of bits specified by [n], including the CY (carry) flag (R9009).

Example of 1-bit right rotation (with carry)

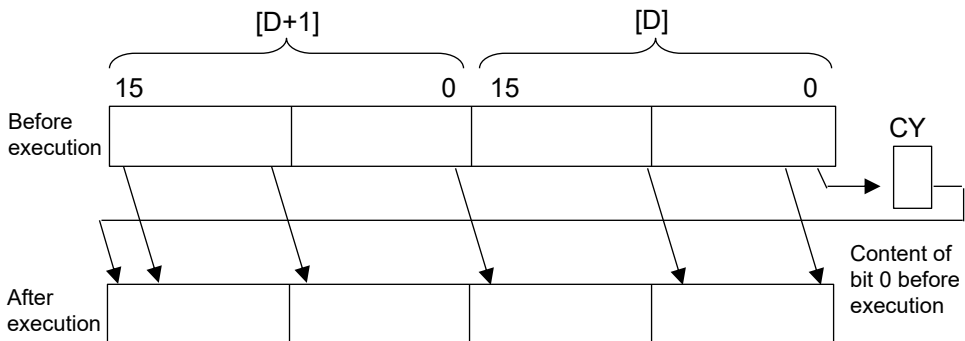

- When the data is rotated to the right,
 - the content of the bit that is 1 bit lower than the bit that moves to the least significant bit when rotated is stored in the CY flag (R9009).
 - The content of the CY flag (R9009) before the rotation is stored in the [n]th bit from the most significant bit.
- For [n], only the lower 8 bits of the 16-bit data are valid.

17.7 F127 DRCR (32-bit Data Right Rotation with Carry)

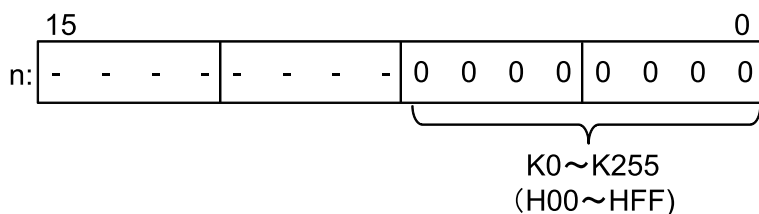

(Note 1) The bits marked with - are invalid.

- When $[n] = K0$, the contents of $[D, D+1]$ and the CY flag do not change.

■ Operation example

Operation of instruction format description program

When internal relay R10 turns ON, the contents of DT11 and DT10 are rotated 4 bits to the right.

The content of bit 3 before execution is stored in the CY flag. The content of the CY flag before execution is stored in bit 28.

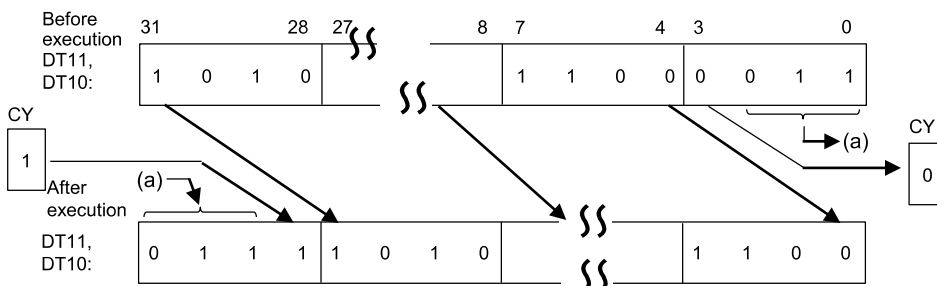

■ Precautions for programming

When $n = (a \text{ multiple of } 33)$, the operation is the same as when $n = 0$.

■ Flag operations

Name	Description
R9007 R9008 (ER)	Turns ON when the area is exceeded in index modification.
R9009 (CY)	Reflects the content of the n th bit from the least significant bit immediately before the instruction is executed.

17.8 F128 DRCL (32-bit Data Left Rotation with Carry)

17.8 F128 DRCL (32-bit Data Left Rotation with Carry)

Rotates 32-bit data (double-word data) n bits to the left with carry data.

■ Instruction format

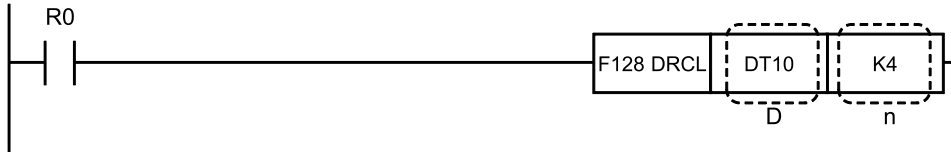

■ Operands

Items	Settings
D	Area to be rotated (two words)
n	Area storing the number of bits specified to be rotated, or constant data

■ Devices that can be specified (indicated by ●)

Operands	WX	WY	WR	WL	SV	EV	DT	LD	I	SWR	SDT	Constant				Index modifier	Integer Device
												K	H	M	f		
D		●	●	●	●	●	●	●	●						●		
n	●	●	●	●	●	●	●	●	●	●	●	●	●		●		

■ Outline of operation

- The double-word data specified by $[D, D+1]$ is rotated to the left (in the high bit direction) by the number of bits specified by $[n]$, including the CY (carry) flag (R9009).

Example of rotation 1 bit to the left (with carry data)

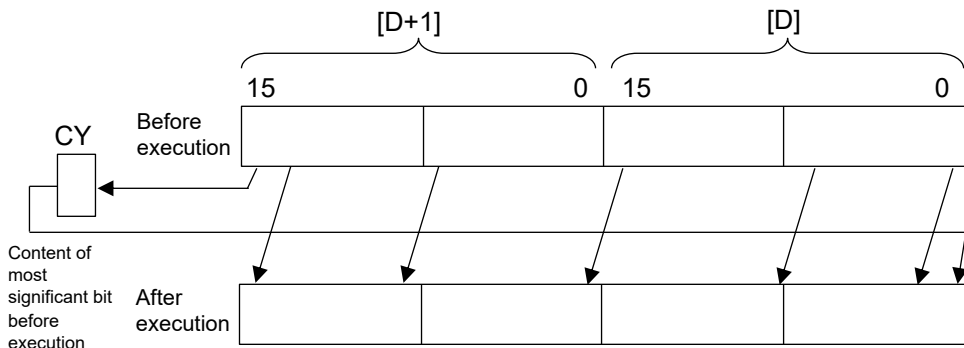

- When the data is rotated to the left,
 - the content of the bit that is 1 bit higher than the bit that moves to the most significant bit when rotated is stored in the CY flag (R9009).
 - The content of the CY flag (R9009) before the rotation is stored in the $[n]$ th bit from the least significant bit.
- For $[n]$, only the lower 8 bits of the 16-bit data are valid.

17.8 F128 DRCL (32-bit Data Left Rotation with Carry)

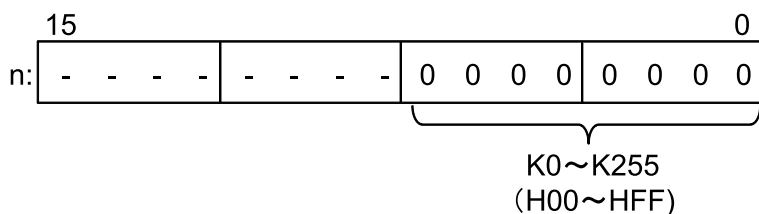

(Note 1) The bits marked with - are invalid.

- When $[n] = K0$, the contents of $[D, D+1]$ and the CY flag do not change.

■ Operation example

Operation of instruction format description program

When the internal relay R0 turns ON, the contents of DT11 and DT10 are rotated 4 bits to the left.

The CY flag stores the contents of bit 28 from before execution. The content of the CY flag before execution is stored in bit 3.

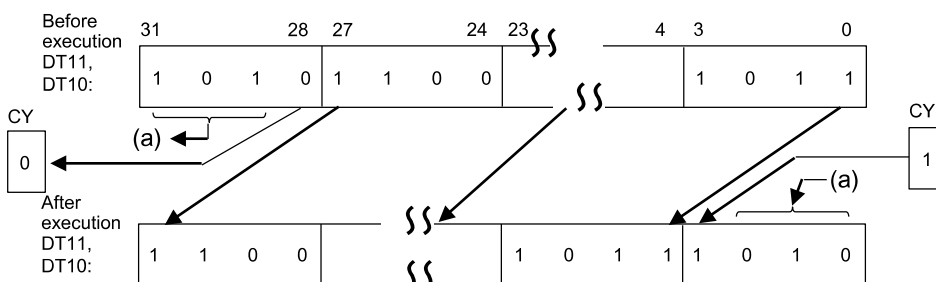

■ Precautions for programming

When $n = (a \text{ multiple of } 33)$, the same operation is the same as when $n = 0$.

■ Flag operations

Name	Description
R9007 R9008 (ER)	Turns ON when the area is exceeded in index modification.
R9009 (CY)	Reflects the content of the n th bit from the most significant bit immediately before the instruction is executed.

(MEMO)

18 Data Buffer Instruction

18.1 F98 CMPR (Compress Shift Read).....	18-2
18.2 F99 CMPW (Compress Shift Write)	18-6
18.3 How to Use the FIFO (First-in First-out) Buffer	18-10
18.4 F115 FIFT (FIFO Buffer Definition)	18-11
18.5 F116 FIFR (FIFO Data Read)	18-14
18.6 F117 FIFW (FIFO Data Write).....	18-18

18.1 F98 CMPR (Compress Shift Read)

18.1 F98 CMPR (Compress Shift Read)

Reads the data at the highest address in the specified range and compresses the data upward.

■ Instruction format

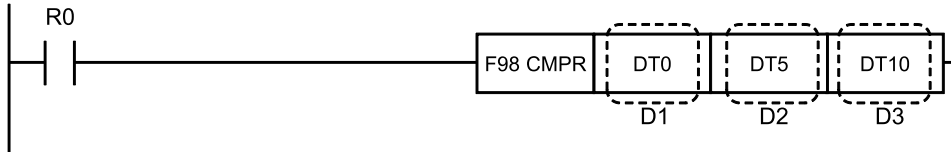

■ Operands

Items	Settings
D1	Starting address of specified range
D2	Final address of specified range
D3	Area storing read data

■ Devices that can be specified (indicated by ●)

Operands	WX	WY	WR	WL	SV	EV	DT	LD	I	SW R	SD T	Constant				Index modifier	Integer Device
												K	H	M	f		
D1		●	●	●	●	●	●	●								●	
D2		●	●	●	●	●	●	●								●	
D3		●	●	●	●	●	●	●								●	

■ Outline of operation

- In the area of the range specified by [D1] and [D2], the content of [D2] (highest address in the specified range) is transferred to the area specified by [D3].
Non-zero data is shifted (compressed) in sequential order in the direction of the higher addresses in the specified range.

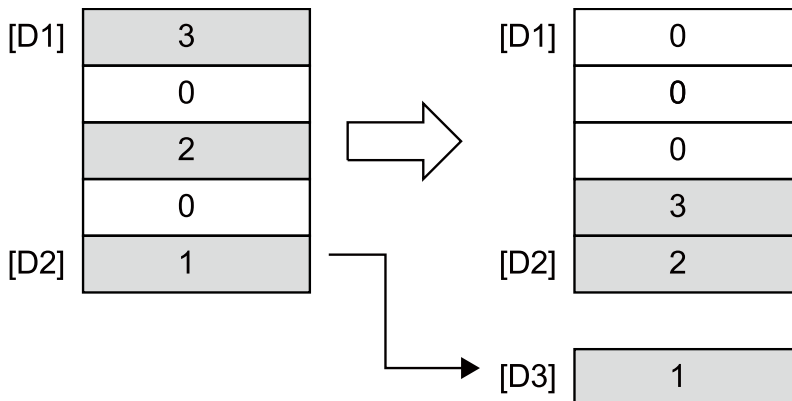

- The starting address of the area is specified by [D1] and the final address is specified by [D2].

- Specify the same type of area for both [D1] and [D2]. Additionally, specify values so that [D1] is equal to or less than [D2].
- If all of the content in the range specified by [D1] and [D2] is 0, 0 is stored in [D3].

■ Operation example

Operation of instruction format description program

When internal relay R0 turns ON, the content of data register DT5 is transferred to data register DT10.

Additionally, the non-zero content in the range of DT0 to DT5 is stored in order from DT5. Any remaining content becomes "0".

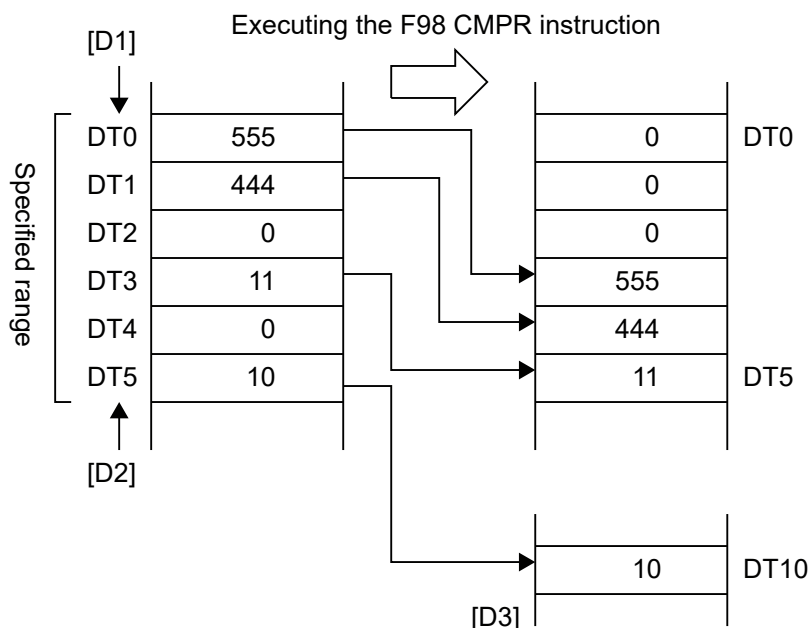

■ Application example

- This instruction can be combined with the "Compress shift Write" (F99 CMPW) instruction to use a memory area of any range as a buffer.

1. Executing the F99 CMPW instruction

When data is written to the starting address of the buffer (the area of the specified range), it accumulates in the buffer in sequential order. The oldest data will be at the final address of the buffer.

18.1 F98 CMPR (Compress Shift Read)

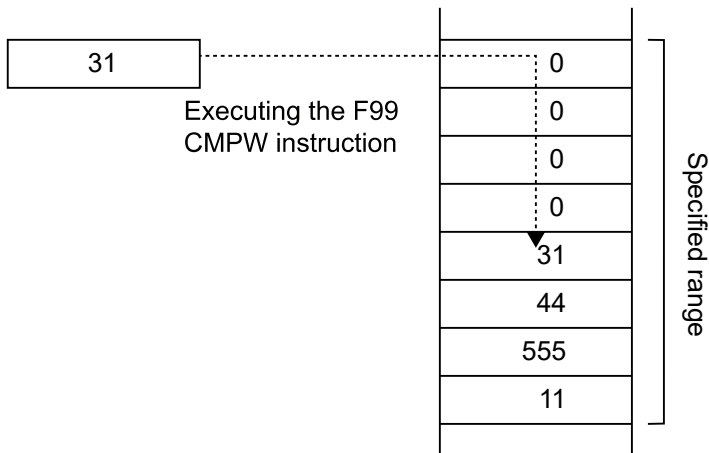

2. Executing the F98 CMPR instruction

When data at the final address of the buffer (the area of the specified range) is read, data can be extracted in sequential order, starting from the oldest data. Any remaining data in the buffer is shifted in the direction of the higher addresses, so the oldest data at any point will always be stored at the final address.

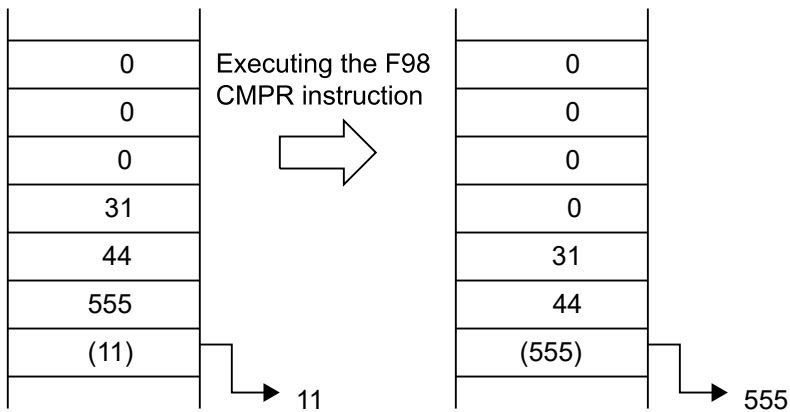

- This can be used to extract valid non-zero data from data written in random order.

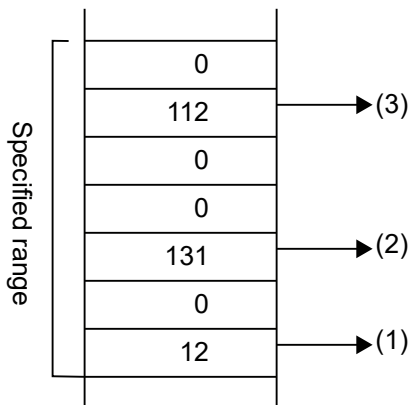

Each time the F98 CMPR instruction is executed, data is extracted in sequential order from (1) to (3).

■ Flag operations

Name	Description
R9007	Turns ON when the area is exceeded in index modification.
R9008	Turns ON when [D1] > [D2]
(ER)	Turns ON when [D1] and [D2] are not the same type of area

18.2 F99 CMPW (Compress Shift Write)

18.2 F99 CMPW (Compress Shift Write)

Writes data to the starting address in the specified range, and compresses the data upward.

■ Instruction format

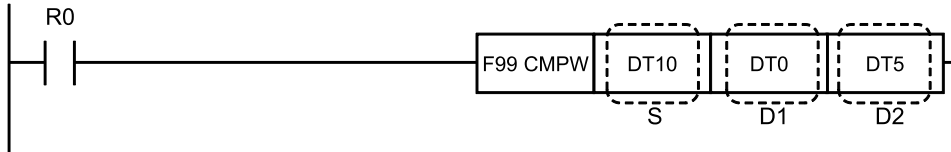

■ Operands

Items	Settings
S	Area storing the hexadecimal data or constant data
D1	Starting address of specified range
D2	Final address of specified range

■ Devices that can be specified (indicated by ●)

Operands	WX	WY	WR	WL	SV	EV	DT	LD	I	SWR	SDT	Constant				Index modifier	Integer Device
												K	H	M	f		
S	●	●	●	●	●	●	●	●	●	●	●	●	●	●	●	●	
D1		●	●	●	●	●	●	●								●	
D2		●	●	●	●	●	●	●								●	

■ Outline of operation

- In the area of the range specified by [D1] and [D2], the content of the area specified by [S] is transferred to [D1] (starting address in the specified range).
Non-zero data is shifted (compressed) in sequential order in the direction of the higher addresses in the specified range.

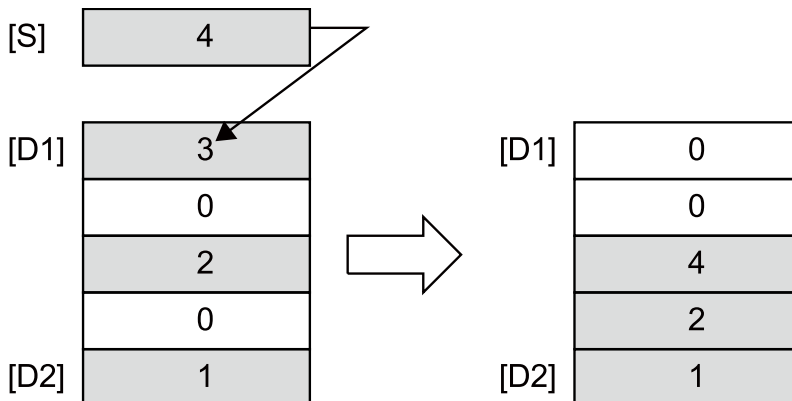

- The starting address of the area is specified by [D1] and the final address is specified by [D2].

- Specify the same type of area for both [D1] and [D2]. Additionally, specify values so that [D1] is equal to or less than [D2].
- If the content of [S] is 0, only a compressed shift is carried out.

■ Operation example

Operation of instruction format description program

When internal relay R0 turns ON, the content of data register DT10 is transferred to data register DT0. Additionally, the non-zero content in the range of DT0 to DT5 is stored in order from DT5. Any remaining content becomes "0".

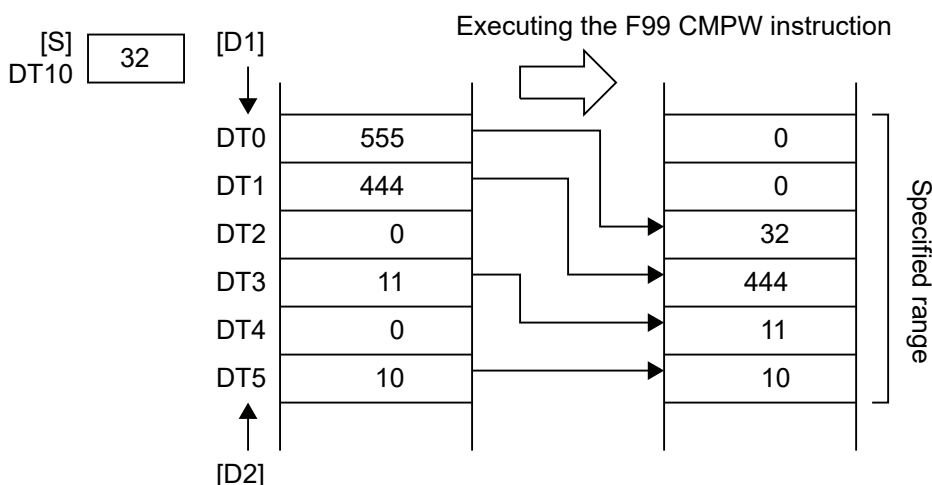

(Note 1) Because the content of [S] is written to DT0 first, the original content of DT0 (555 for example) is overwritten.

■ Application example

- This instruction can be combined with the "Compress shift read" (F98 CMPR) instruction to use a memory area of the specified range as a buffer.
 1. Executing the F99 CMPW instruction

When data is written to the starting address of the buffer (the area of the specified range), it accumulates in the buffer in sequential order. The oldest data will be at the final address of the buffer.

18.2 F99 CMPW (Compress Shift Write)

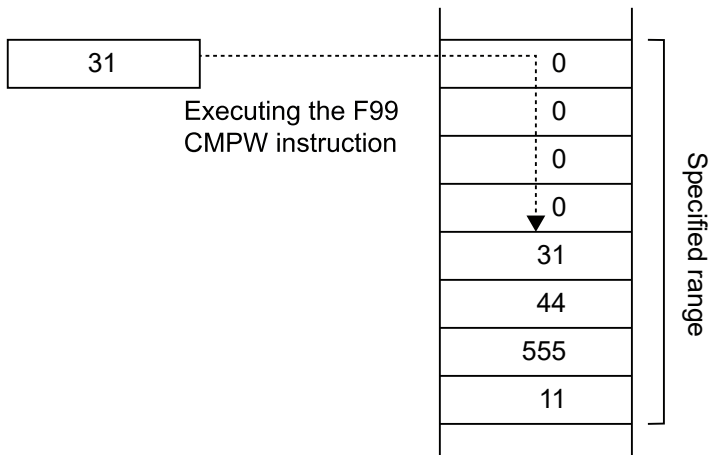

2. Executing the F98 CMPR instruction

When data at the final address of the buffer (the area of the specified range) is read, data can be extracted in sequential order, starting from the oldest data. Any remaining data in the buffer is shifted in the direction of the higher addresses, so the oldest data at any point will always be stored at the final address.

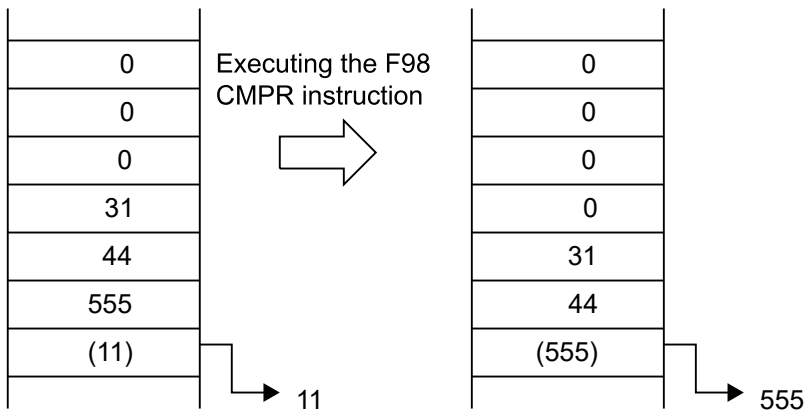

- This can be used to extract valid non-zero data from data written in random order.

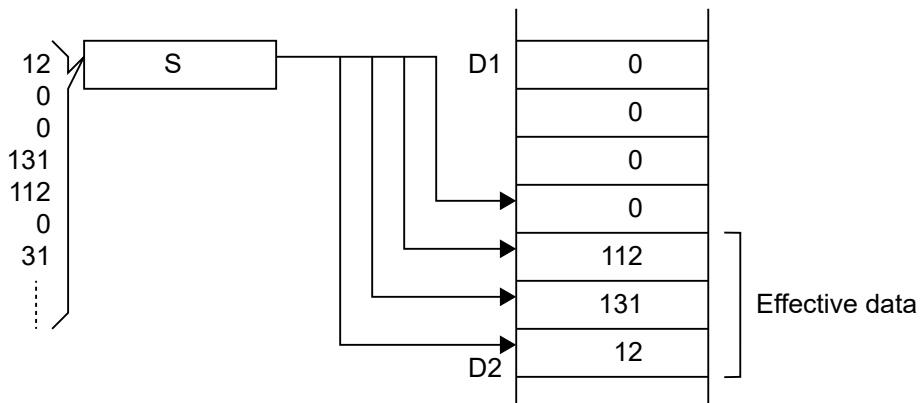

Executing the F99 CMPW instruction causes only the valid data to be stored.

■ Flag operations

Name	Description
R9007	Turns ON when the area is exceeded in index modification.
R9008	Turns ON when [D1] > [D2]
(ER)	Turns ON when [D1] and [D2] are not the same type of area

18.3 How to Use the FIFO (First-in First-out) Buffer

18.3 How to Use the FIFO (First-in First-out) Buffer

The FIFO buffer is a buffer area that stores data in the order it is written, and starts reading in order from the first data stored. It is convenient to use the FIFO buffer as a record of the order of objects on a conveyor line or buffer line.

1.2 Procedure

1. The F115 FIFT instruction defines the area to be used as the FIFO buffer. (Use it just once before read/write.)
2. Use the F117 FIFW instruction for data write, and the F116 FIFR instruction for read.

Data write

- After data is written, it is stored in the data storage area in order starting from the first written data. The write pointer indicates the next write area.
- When the data storage area becomes full, it is no longer possible to write.

Data read

- When read is executed, data is transferred in order from the first data that was stored. The read pointer indicates the area that will be read.
- If read is executed when there is no data written to the data storage area, an error is returned.

<Example of data storage area>

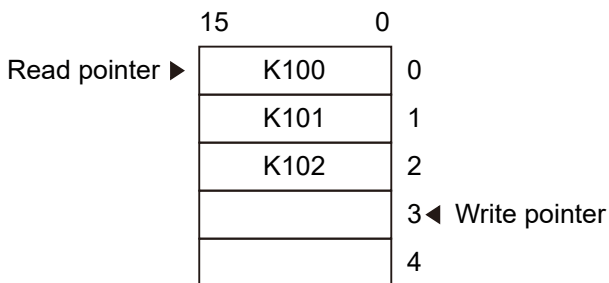

As shown in the figure above, when data is written, it is stored in area "3". The write pointer moves to "4". (Data will next be written to "4".) When a read is executed, data is read from the "0" area. The read pointer moves to "1". (Data will next be read from "1").

18.4 F115 FIFT (FIFO Buffer Definition)

Defines the start and size of the FIFO buffer area.

■ Instruction format

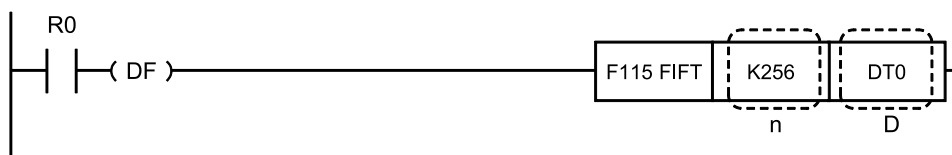

■ Operands

Items	Settings
n	Area storing the size (number of words) of the FIFO buffer, or constant data
D	Starting address for the FIFO buffer area

■ Devices that can be specified (indicated by ●)

Operand s	WX	WY	WR	WL	SV	EV	DT	LD	I	SW R	SD T	Constant				Index modifier	Integer Device
												K	H	M	f		
n	●	●	●	●	●	●	●	●	●	●	●	●	●	●	●	●	
D		●	●	●	●	●	●	●							●		

■ Outline of operation

- The area used as the FIFO buffer is defined. A data storage area of n words (n = K1 to K256) is defined for the area specified by [D].

Definition of the area using the F115 FIFT instruction should be executed only once, before writing to or reading from the FIFO buffer. Normally, reading and writing are disabled while this instruction is being executed.

- When the F115 FIFT instruction is executed, the FIFO buffer area is defined as follows.

18.4 F115 FIFT (FIFO Buffer Definition)

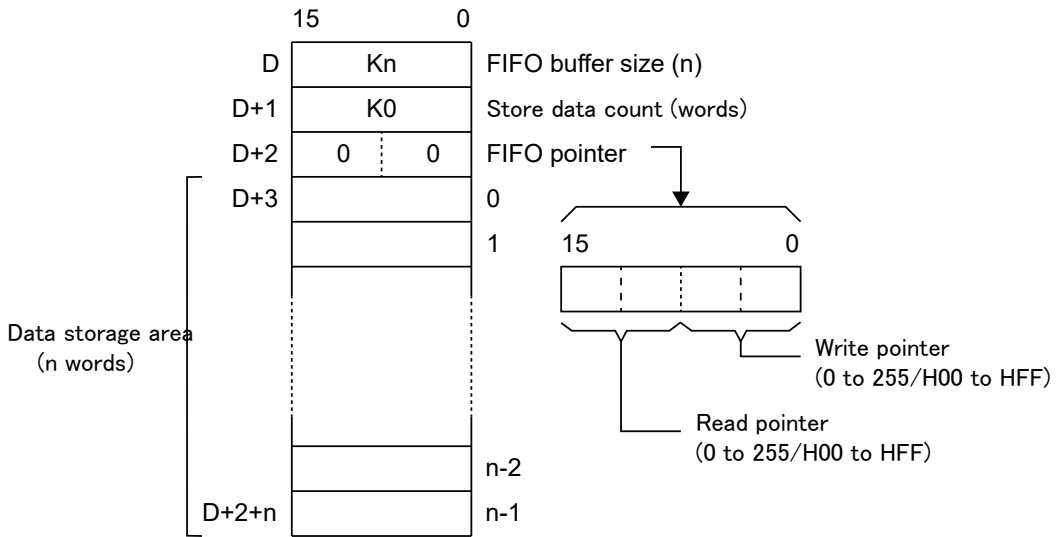

- When the F115 FIFT instruction is executed, the following are stored as default values: [D] = n (the value specified by the F115 FIFT instruction), [D+1] = K0 and [D+2] = H0000.

■ Operation example

Operation of instruction format description program

When internal relay R0 turns ON, the area starting from DT0 is defined as the FIFO buffer area. "FIFO buffer size"(K256) is stored in DT0, "number of data items" is stored in DT1 (with a default value of K0), and "FIFO pointer"(with a default value of H0000) is stored in DT2. When n = K256, the 256 words from DT3 to DT258 are defined as the data storage area.

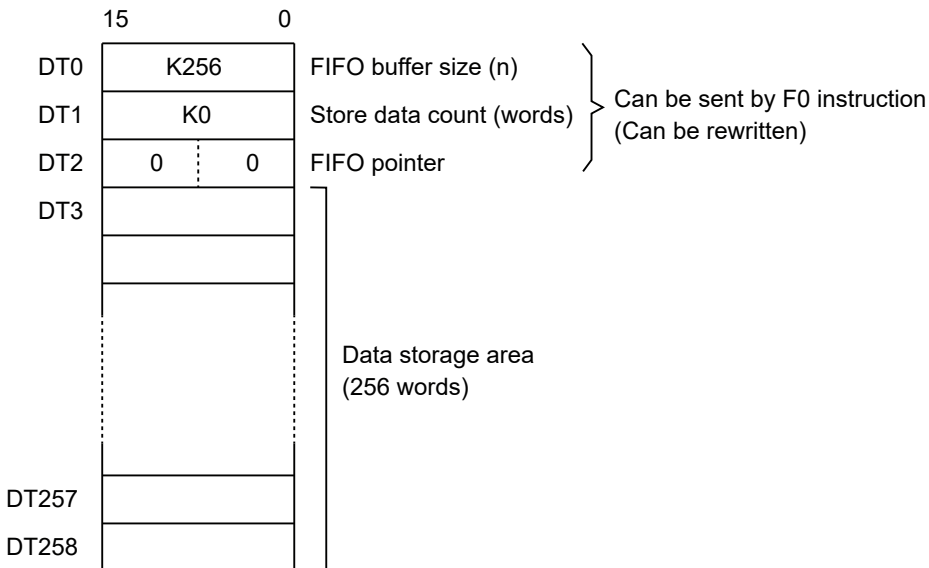

■ Flag operations

Name	Description
R9007	Turns ON when the area is exceeded in index modification.

18.4 F115 FIFT (FIFO Buffer Definition)

Name	Description
R9008 (ER)	Turns ON when $n = 0$
	Turns ON when $n > 256$
	Turns ON when the final address of the FIFO set according to the FIFO size exceeds the area

18.5 F116 FIFR (FIFO Data Read)

18.5 F116 FIFR (FIFO Data Read)

Reads the data from the specified FIFO buffer.

■ Instruction format

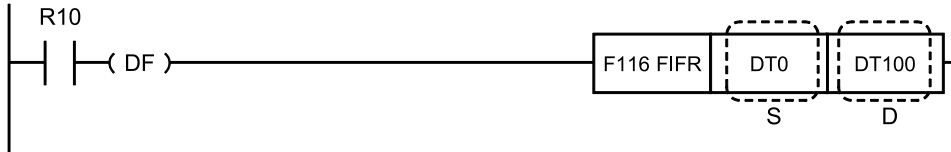

■ Operands

Items	Settings
S	Starting address for the FIFO buffer area
D	Area storing the data read from the FIFO buffer

■ Devices that can be specified (indicated by ●)

Operands	WX	WY	WR	WL	SV	EV	DT	LD	I	SWR	SDT	Constant				Index modifier	Integer Device
												K	H	M	f		
S		●	●	●	●	●	●	●								●	
D		●	●	●	●	●	●	●	●							●	

■ Outline of operation

- The data is read from the FIFO buffer at the start of the area specified by [S], and is stored in the area specified by [D]. For [S], specify the start of the FIFO buffer defined by the FIFT instruction.
- Data is read from the address specified by the read pointer when the instruction is executed.

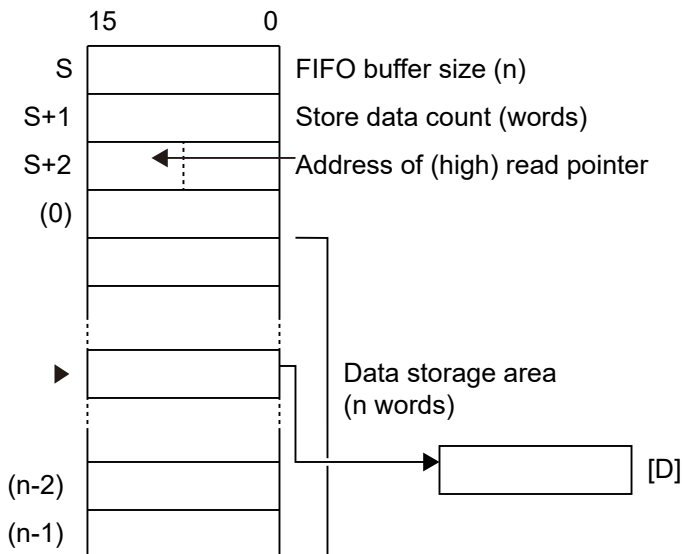

(Note 1) (0) to (n-1) are addresses assigned to the data storage areas.

(Note 2) n is the value specified by the F115 FIFT instruction.

(Note 3) ▶ is the read pointer.

- The read pointer is stored in the upper eight bits of the third word of the FIFO buffer area. It is indicated by an address in the data storage area. The actual address is the starting address of the FIFO buffer area specified by [S], plus 3, plus the read pointer value (in which only the upper byte is a decimal value).
- When a read is executed, 1 is subtracted from the number of stored data and the read pointer is incremented by 1.

Note

- An error occurs if the instruction is executed when the number of stored data is 0. No data set for [D].
- A read is only performed when the read pointer is not equal to the write pointer.
- If this instruction is executed while the read pointer is pointing to the ending address of the FIFO buffer (n defined by the F115 FIFT instruction minus 1), the read pointer becomes 0.

■ Operation example

Operation of instruction format description program

When internal relay R10 turns ON, data is read from the FIFO buffer area at the start of DT0 and stored in DT100.

18.5 F116 FIFR (FIFO Data Read)

[When the read pointer is 2]

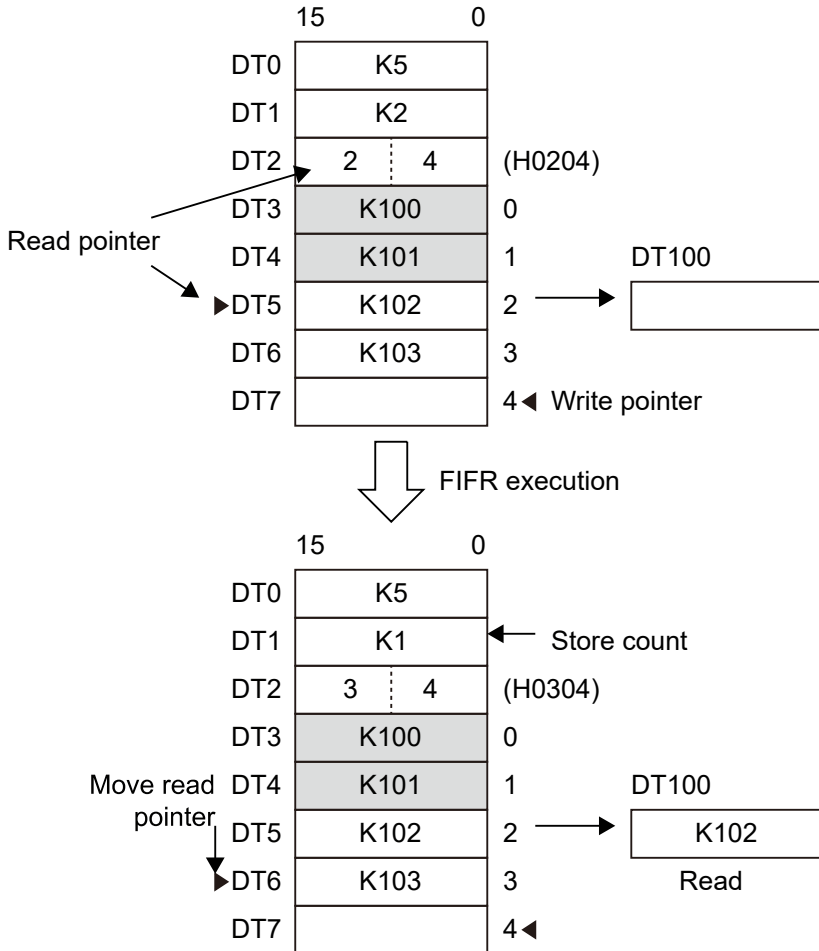

1. The content of DT5 indicated by read pointer 2 is transferred to DT100.
2. After reading, 1 is subtracted from the content of DT1 (number of stored data), and the read pointer moves to 3. (The next time a read is executed, the content of DT6 indicated by 3 is transferred to DT100.)

■ Precautions for programming

An error occurs if the F116 FIFR instruction is executed when the number of stored data ($[S+1]$) is 0.

[Reference]

In the program below, the F116 FIFR instruction is not executed when the data storage number is 0.

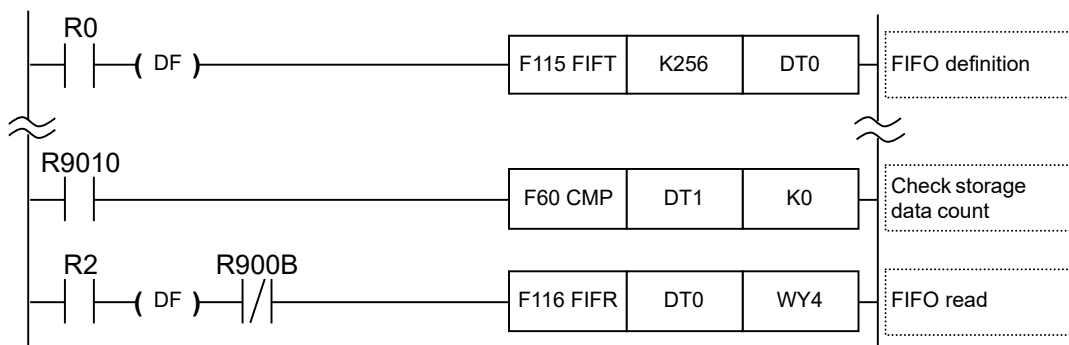

■ Flag operations

Name	Description
R9007 R9008 (ER)	Turns ON when the area is exceeded in index modification.
	Turns ON when the size of the FIFO specified by [S] (n) is n = 0 or n > 256
	Turns ON when the number of data stored in the FIFO is 0
	Turns ON when the number of stored data items of the FIFO is larger than the FIFO size (n)
	Turns ON when the final address of the FIFO based on the FIFO size (n) exceeds the area
	Turns ON when the FIFO read pointer is larger than the size of the FIFO (n)
	Turns ON when, after reading data, the FIFO read pointer is K256 (H100) or higher

18.6 F117 FIFW (FIFO Data Write)

18.6 F117 FIFW (FIFO Data Write)

Writes data to the specified FIFO buffer.

■ Instruction format

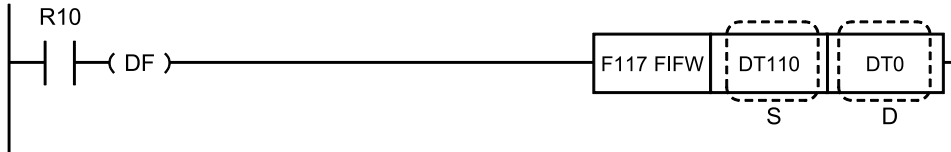

■ Operands

Items	Settings
S	Area storing the 16-bit data to write to the FIFO buffer, or constant data
D	Starting address for the FIFO buffer area

■ Devices that can be specified (indicated by ●)

Operand s	WX	WY	WR	WL	SV	EV	DT	LD	I	SW R	SD T	Constant				Index modifier	Integer Device
												K	H	M	f		
S	●	●	●	●	●	●	●	●	●	●	●	●	●	●	●		
D		●	●	●	●	●	●	●							●		

■ Outline of operation

- The 16-bit data specified by [S] is stored in the FIFO buffer starting at the area specified by [D]. Specify the start of the FIFO buffer defined by the FIFT instruction for [D].
- The specified data is written to the address indicated by the write pointer when the instruction is executed.

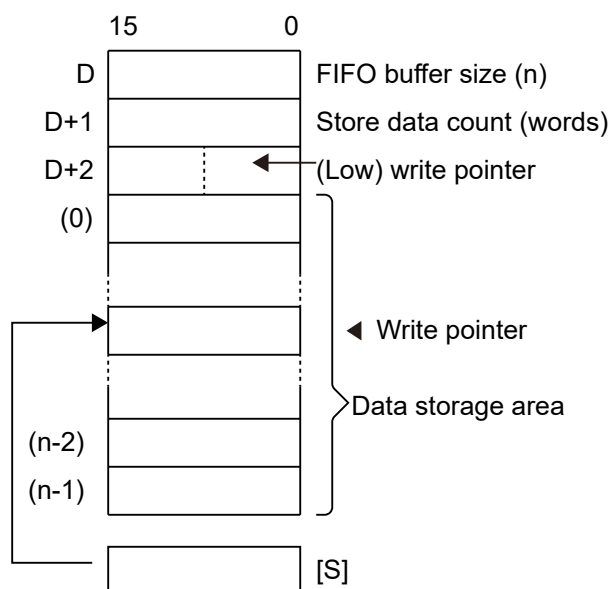

(Note 1) (0) to (n-1) are addresses assigned to the data storage areas.

(Note 2) n is the value specified by the F115 FIFT instruction.

- The write pointer is stored in the lower eight bits of the third word of the FIFO buffer area. It is indicated by a relative position in the data storage area. The actual address is the starting address of the FIFO buffer area specified by [D], plus 3, plus the write pointer value (in which only the lower byte is a decimal value).
- When a write is executed, 1 is added to the number of stored data items, and the write pointer is incremented 1.

Note

- An error occurs if this instruction is executed when the FIFO buffer is full (the number of stored data items = size n of the FIFO defined by the F115 FIFT instruction). In this case, the write is not performed.
- If this instruction is executed when the write pointer is indicating the final address in the FIFO buffer (the n value defined by the F115 FIFT instruction), the write pointer will be set to 0.

■ Operation example

Operation of instruction format description program

When internal relay R10 turns ON, the contents of DT110 are written to the FIFO buffer area that starts from by DT0.

18.6 F117 FIFW (FIFO Data Write)

When the write pointer is 3

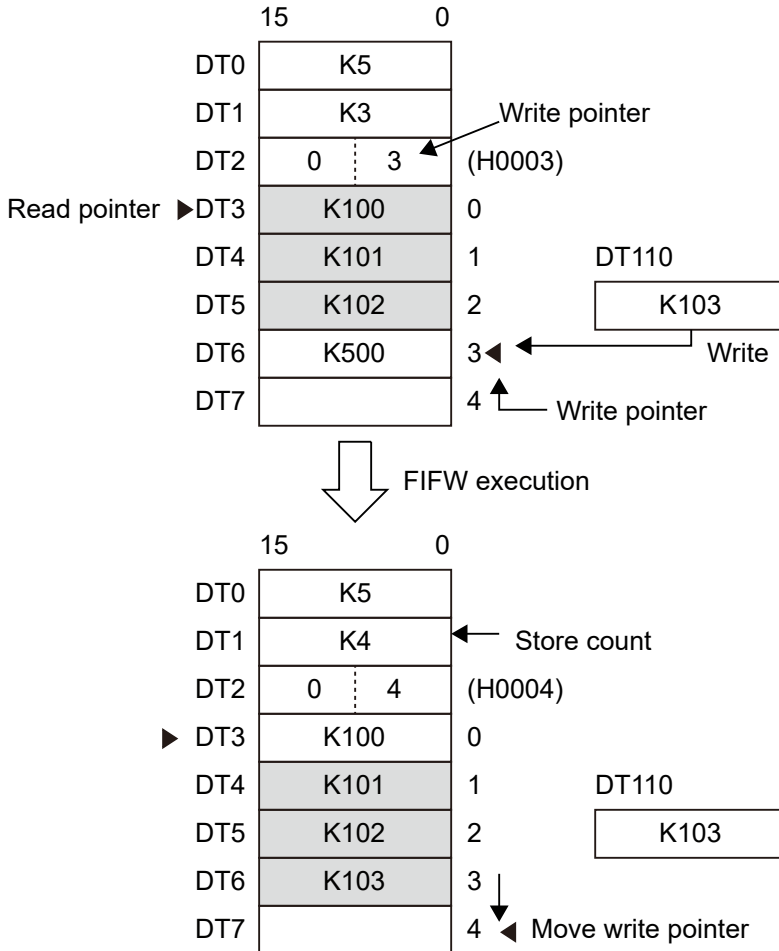

1. The contents "103" of DT110 are sent to DT6, which is indicated by pointer 3.
2. After the data has been written, 1 is added to the contents of DT1 (the number of stored data items), and the write pointer moves to 4. (The next time that writing is executed, the contents of DT110 are written to DT7, which is indicated by 4.)

■ Precautions when using this instruction

If data is received that exceeds the capacity of the buffer, an operation error occurs.

Example: If the write pointer is at the end of the FIFO buffer

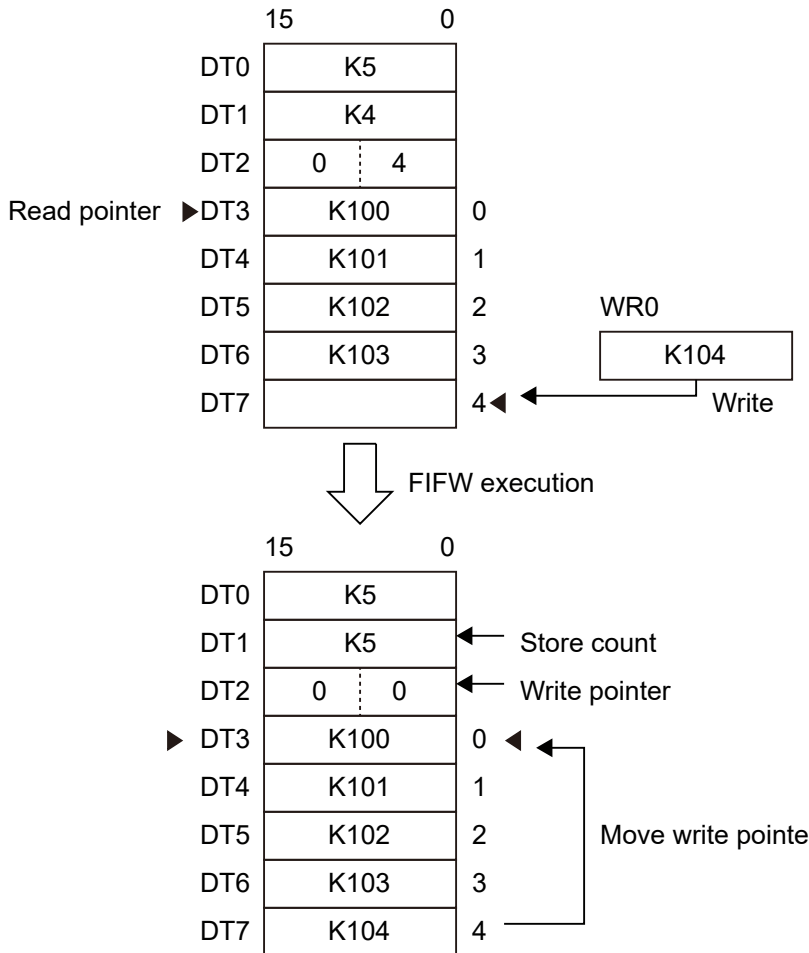

When the F117 FIFW instruction is executed, after data is written to the final address (4) in the buffer, the write pointer becomes the starting address (0).

18.6 F117 FIFW (FIFO Data Write)

Example: When the write pointer has made one complete cycle

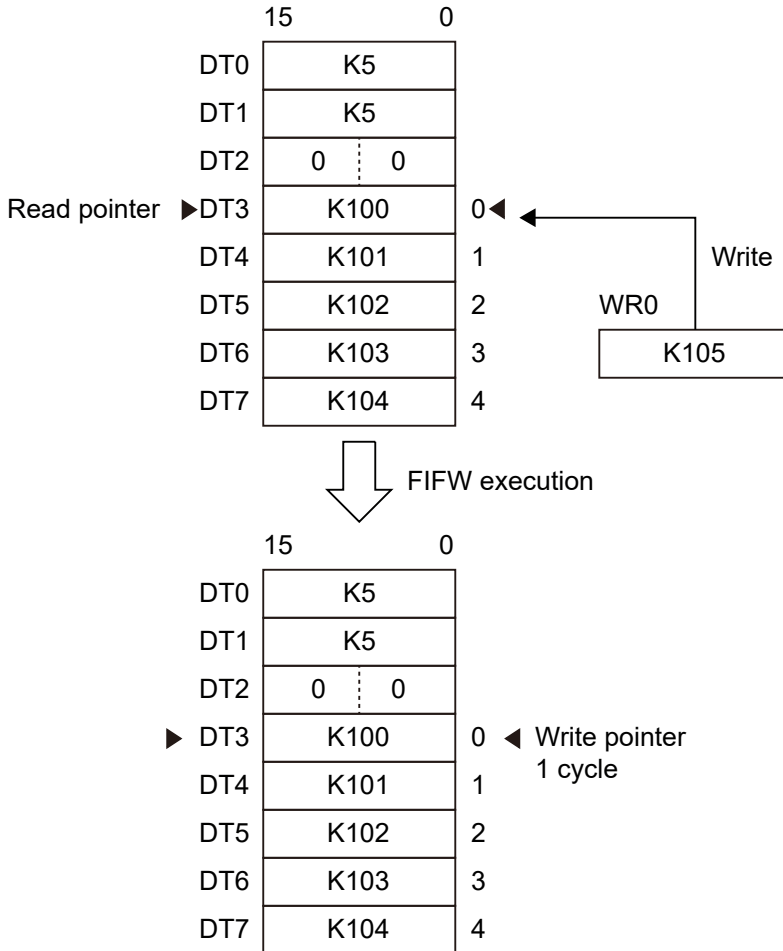

An error occurs and processing is not carried out.

Because the number of data items stored in the FIFO buffer (DT1 = 5) exceeds the size of the FIFO buffer (DT0 = 5), the operation is not executed, and an operation error occurs.

■ Measures to avoid operation errors

1. Do not execute the F117 FIFW instruction using the comparison instruction. Avoid executing the F117 FIFW instruction when the size of the FIFO buffer (DT0) is equal to the number of data items stored in the buffer (DT1).

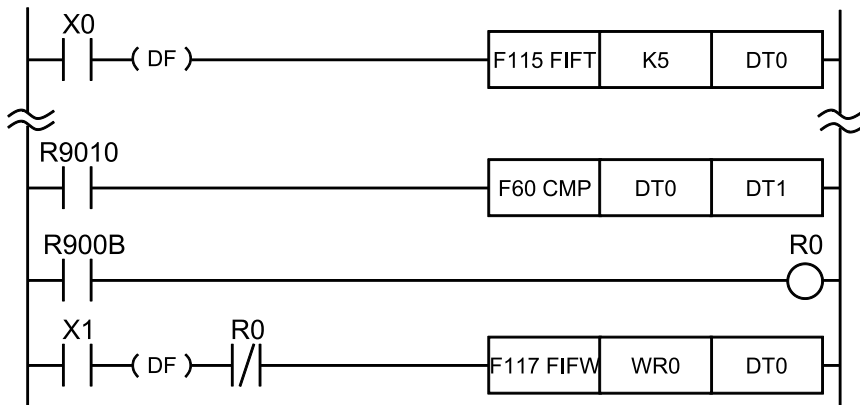

2. Execute the F117 FIFW instruction after executing the F116 FIFR instruction.

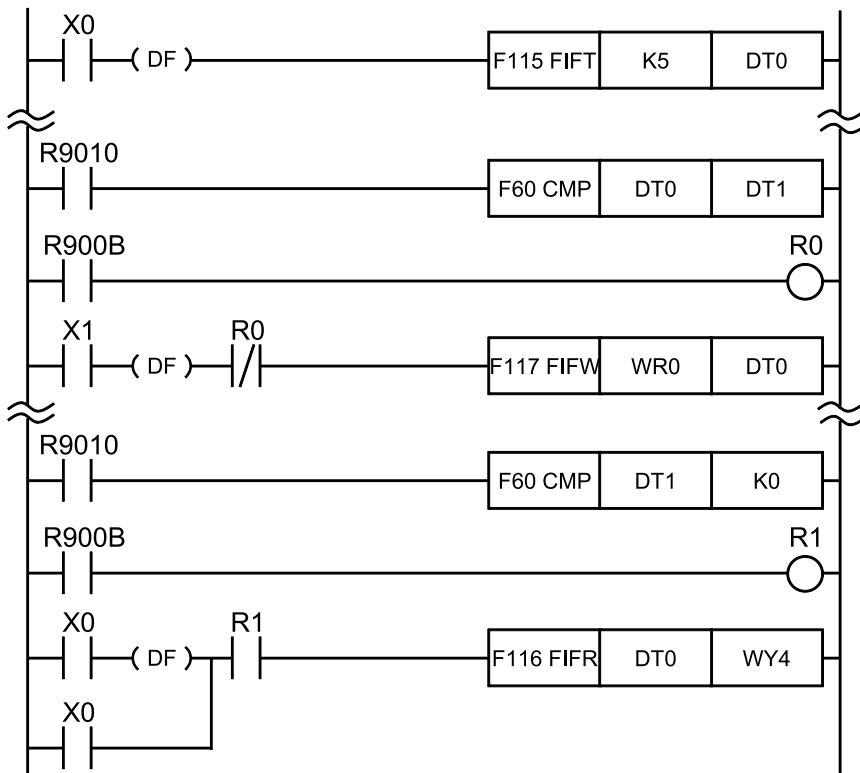

■ Flag operations

Name	Description
R9007 R9008 (ER)	Turns ON when the area is exceeded in index modification.
	Turns ON when the size (n) of the FIFO specified by [D] is n = 0, or when n > 256
	Turns ON when the number of stored data items of the FIFO is larger than the FIFO size (n)
	Turns ON when the final address of the FIFO based on the FIFO size (n) exceeds the area

18.6 F117 FIFW (FIFO Data Write)

Name	Description
	Turns ON when the write pointer of the FIFO is larger than the FIFO size (n)
	Turns ON when the FIFO write pointer is K256 (H100) or higher after the data is written

19 Bit Manipulation Instructions

19.1 F130 BTS (Specified Bit Set)	19-2
19.2 F131 BTR (Specified Bit Reset).....	19-4
19.3 F132 BTI (Specified Bit Inversion)	19-6
19.4 F133 BTT (Specified Bit Test).....	19-8
19.5 F135 BCU (Count ON Bits in 16-bit Data)	19-10
19.6 F136 DBCU (Count ON Bits in 32-bit Data).....	19-12

19.1 F130 BTS (Specified Bit Set)

19.1 F130 BTS (Specified Bit Set)

Turns a bit of the specified 16-bit data ON.

■ Instruction format

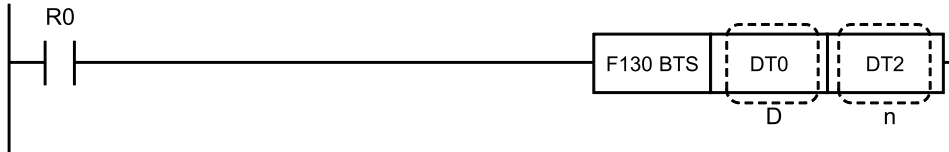

■ Operands

Items	Settings
D	Area in which bit is to be set
n	Area storing position of bit to be set, or constant data

■ Devices that can be specified (indicated by ●)

Operands	WX	WY	WR	WL	SV	EV	DT	LD	I	SWR	SDT	Constant				Index modifier	Integer Device
												K	H	M	f		
D		●	●	●	●	●	●	●	●						●		
n	●	●	●	●	●	●	●	●	●	●	●	●	●		●		

■ Outline of operation

- The bit with the number specified by [n] in the 16-bit data specified by [D] is turned ON. Bits other than the specified bit do not change.
- Set [n] in the range from K0 to K15. Only the lower 4 bits of the 16-bit data are valid.

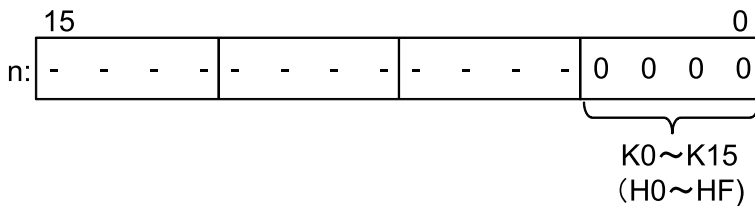

(Note 1) The bits marked with - are invalid.

■ Operation example

Operation of instruction format description program

When internal relay R0 turns ON, the bit specified by DT2 in the data stored in DT0 is turned ON. When DT2 = K7, the operation is as shown below.

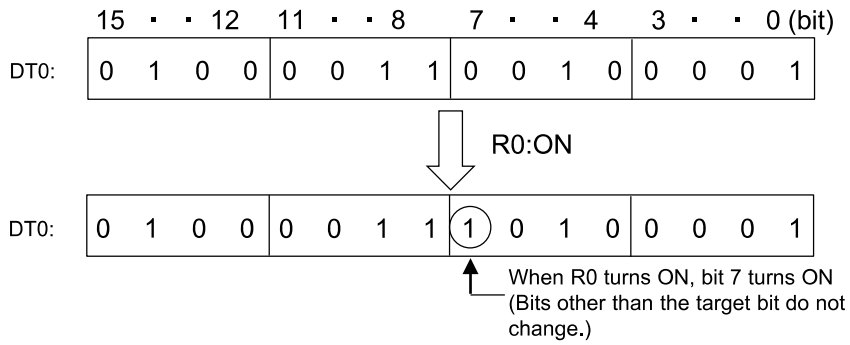

■ Flag operations

Name	Description
R9007 R9008 (ER)	Turns ON when the area is exceeded in index modification.

19.2 F131 BTR (Specified Bit Reset)

19.2 F131 BTR (Specified Bit Reset)

Turns OFF a specified bit of 16-bit data.

■ Instruction format

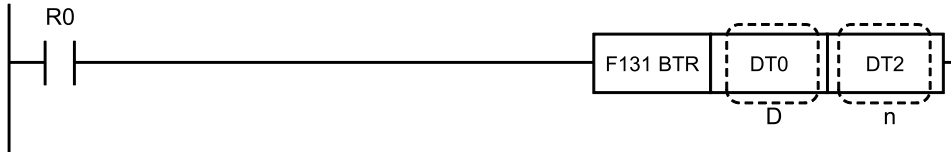

■ Operands

Items	Settings
D	Area where the bit will be reset
n	Area storing the specification of the bit position to be reset, or constant data

■ Devices that can be specified (indicated by ●)

Operands	WX	WY	WR	WL	SV	EV	DT	LD	I	SW R	SD T	Constant				Index modifier	Integer Device
												K	H	M	f		
D		●	●	●	●	●	●	●	●						●		
n	●	●	●	●	●	●	●	●	●	●	●	●	●		●		

■ Outline of operation

- Turns OFF a bit specified by the number [n] in the 16-bit data specified by [D]. Bits other than the specified bit do not change.
- Set [n] in the range from K0 to K15. Only the lower 4 bits of the 16-bit data are valid.

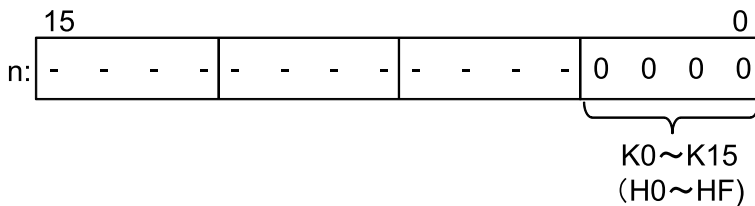

(Note 1) The bits marked with - are invalid.

■ Operation example

Operation of instruction format description program

Turns OFF the bit specified by DT2 in the data stored in DT0 when internal relay R0 turns ON. When DT2 = K7, the operation is as shown below.

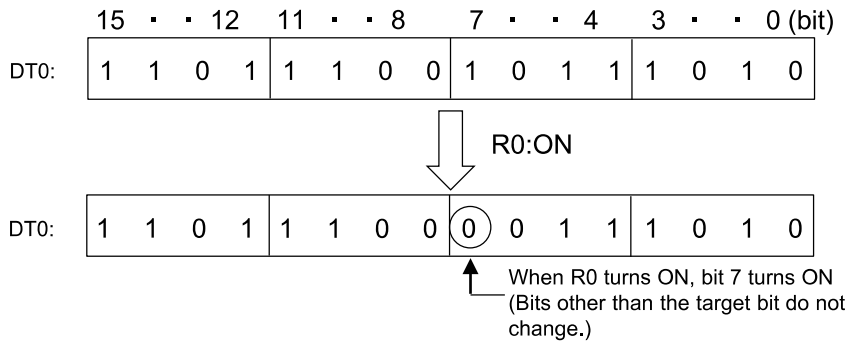

■ Flag operations

Name	Description
R9007 R9008 (ER)	Turns ON when the area is exceeded in index modification.

19.3 F132 BTI (Specified Bit Inversion)

19.3 F132 BTI (Specified Bit Inversion)

Inverts a specific bit in 16-bit data.

■ Instruction format

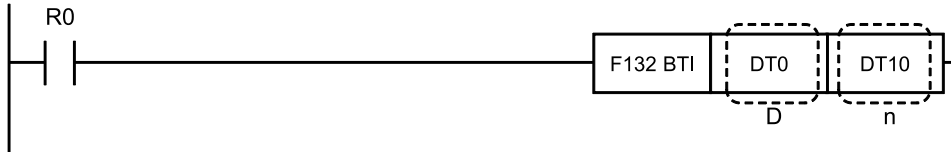

■ Operands

Items	Settings
D	Target area for bit inversion
n	Area storing the number of the bit to be inverted, or constant data

■ Devices that can be specified (indicated by ●)

Operands	WX	WY	WR	WL	SV	EV	DT	LD	I	SWR	SDT	Constant				Index modifier	Integer Device
												K	H	M	f		
D		●	●	●	●	●	●	●	●						●		
n	●	●	●	●	●	●	●	●	●	●	●	●			●		

■ Outline of operation

- Inverts (OFF -> ON or ON -> OFF) the bit number specified by [n] in the 16-bit data specified by [D]. Bits other than the specified bit do not change.
- [n] is in the range of K0 to K15. Only the lower 4 bits of the 16-bit data are valid.

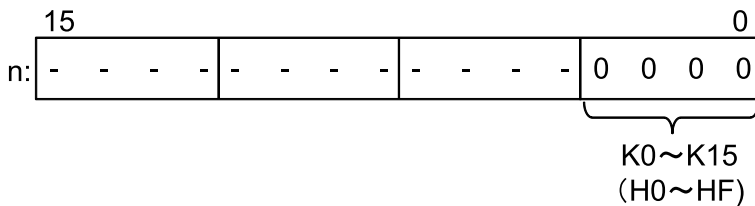

(Note 1) The bits marked with - are invalid.

■ Operation example

Operation of instruction format description program

Inverts the bit specified by DT10 in data stored in DT0 when internal relay R0 turns ON. When DT10 = K7, the operation is as shown below.

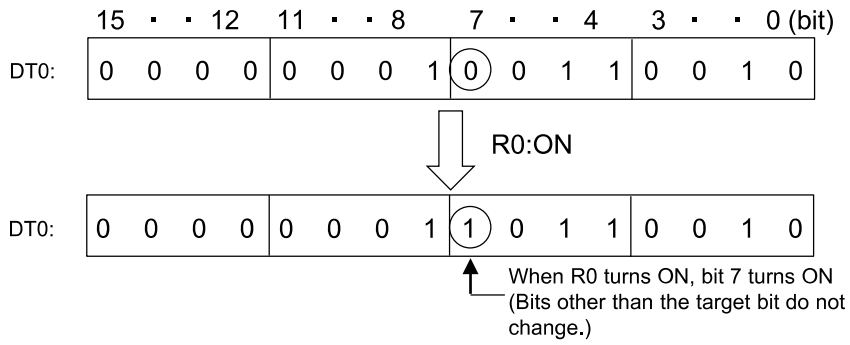

■ Flag operations

Name	Description
R9007 R9008 (ER)	Turns ON when the area is exceeded in index modification.

19.4 F133 BTT (Specified Bit Test)

19.4 F133 BTT (Specified Bit Test)

Tests the specified bit in the specified 16-bit data (to determine whether it is ON or OFF).

■ Instruction format

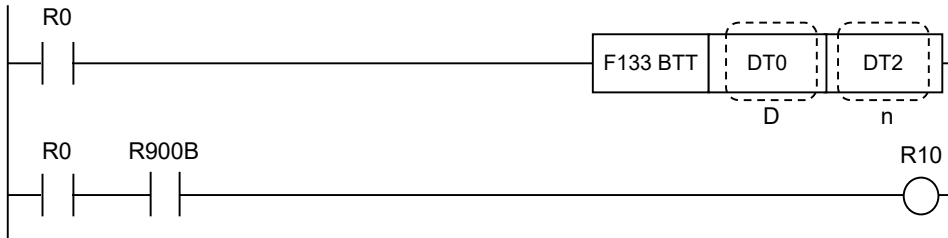

■ Operands

Items	Settings
D	Target area for bit test
n	Area storing the numbers of the bits to be tested, or constant data

■ Devices that can be specified (indicated by ●)

Operands	WX	WY	WR	WL	SV	EV	DT	LD	I	SWR	SDT	Constant				Index modifier	Integer Device
												K	H	M	f		
D		●	●	●	●	●	●	●	●							●	
n	●	●	●	●	●	●	●	●	●	●	●	●	●			●	

■ Outline of operation

- The bit with the number specified by [n] in the 16-bit data specified by [S] is judged to either be ON or OFF, and the judgment result is output to special internal relay R900B ["=(ZERO)"flag].
- The judgment result is as follows.

State of specified bit	"=(ZERO)" flag (R900B)
ON (1)	OFF (0)
OFF (0)	ON (1)

- [n] can be specified in the range of K0 to K15. Only the lower 4 bits of the 16-bit data are valid.

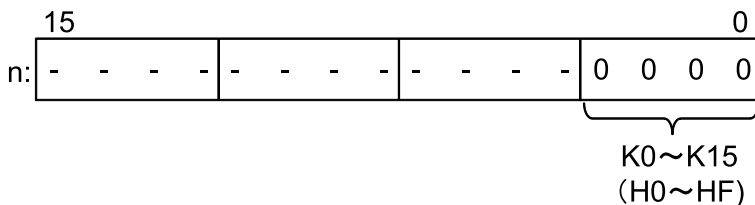

(Note 1) The bits marked with - are invalid.

■ Operation example

Operation of instruction format description program

When internal relay R0 turns ON, the bit specified by DT2 in the data stored in data register DT0 is determined to either be ON or OFF. If the specified bit is OFF, internal relay R10 turns ON. If DT2 = K7, then the following happens.

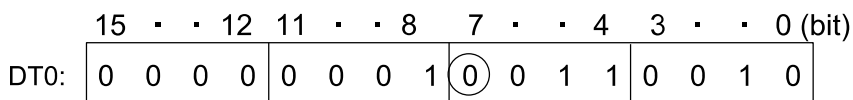

↑
Test bit 7.

As bit 7 is OFF (0), R900B: ON (test result), so R10: ON

■ Precautions when using the judgment flag (R900B) twice or more

- The judgment flag R900B is updated each time an operation instruction or comparison instruction is executed.
- Accordingly, when using the judgment flag twice or more,
 1. the program using the judgment flag should be inserted immediately after the instruction that executes the judgment; and
 2. the flag should be output to an output relay or internal relay for each instruction.

■ Flag operations

Name	Description
R9007 R9008 (ER)	Turns ON when the area is exceeded in index modification.
R900B (=)	Turns ON when the test bit (bit n) is "0"

19.5 F135 BCU (Count ON Bits in 16-bit Data)

19.5 F135 BCU (Count ON Bits in 16-bit Data)

Counts the number of ON bits in the specified 16-bit data.

■ Instruction format

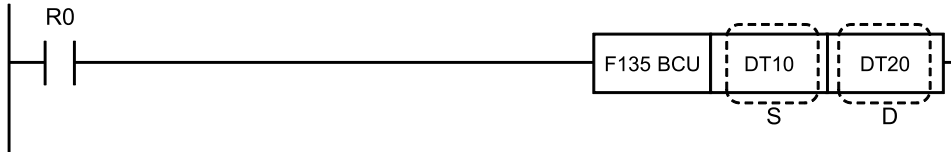

■ Operands

Items	Settings
S	Area storing the 16-bit data subject to the bit count, or constant data
D	Area storing the number of ON bits

■ Devices that can be specified (indicated by ●)

Operands	WX	WY	WR	WL	SV	EV	DT	LD	I	SWR	SDT	Constant				Index modifier	Integer Device
												K	H	M	f		
S	●	●	●	●	●	●	●	●	●	●	●	●	●	●	●	●	
D		●	●	●	●	●	●	●	●							●	

■ Outline of operation

- The number of ON bits (bits with a value of 1) in the 16-bit data specified by [S] is counted, and the result is stored in the area specified by [D].
- The result is stored as a decimal number.

■ Operation example

Operation of instruction format description program

When internal relay R0 turns ON, the number of ON bits in the data stored in DT10 is stored in DT20.

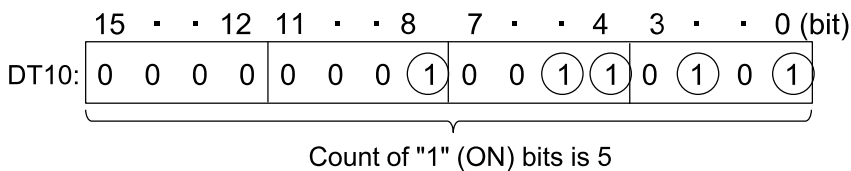

When R0 turns ON, K5 is stored in DT20.

■ Flag operations

Name	Description
R9007 R9008	Turns ON when the area is exceeded in index modification.

19.5 F135 BCU (Count ON Bits in 16-bit Data)

Name	Description
(ER)	

19.6 F136 DBCU (Count ON Bits in 32-bit Data)

19.6 F136 DBCU (Count ON Bits in 32-bit Data)

Counts the number of ON bits in the specified 32-bit data.

■ Instruction format

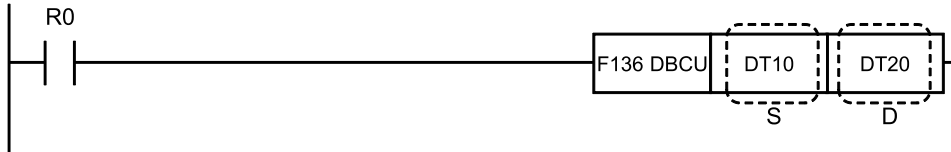

■ Operands

Items	Settings
S	Area storing the 32-bit data subject to the bit count, or constant data
D	Area storing the number of ON bits

■ Devices that can be specified (indicated by ●)

Operands	WX	WY	WR	WL	SV	EV	DT	LD	I	SWR	SDT	Constant				Index modifier	Integer Device
												K	H	M	f		
S	●	●	●	●	●	●	●	●	●	●	●	●	●	●	●		
D		●	●	●	●	●	●	●	●						●		

■ Outline of operation

- The number of ON bits (bits with a value of 1) in the 32-bit data specified by [S] and [S+1] is counted, and the result is stored in the area specified by [D].
- The result is stored as a decimal number.

■ Operation example

Operation of instruction format description program

When internal relay R0 turns ON, the number of ON bits in the data stored in DT10 and DT11 is stored in DT20.

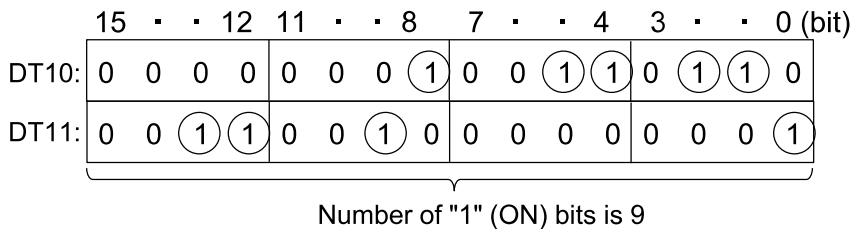

When R0 turns ON, K9 is stored in DT20.

■ Flag operations

Name	Description
R9007	Turns ON when the area is exceeded in index modification.

19.6 F136 DBCU (Count ON Bits in 32-bit Data)

Name	Description
R9008 (ER)	

(MEMO)

20 Special Instructions

20.1 F138 HMSS (Hour, Minute, Second Data to Second Data Conversion).....	20-2
20.2 F139 SHMS (Second Data to Hour, Minute, Second Data Conversion).....	20-4
20.3 F140 STC (Cy Flag Set)	20-6
20.4 F141 CLC (Cy Flag Clear)	20-7
20.5 F143 IORF (Partial I/O refresh).....	20-8
20.6 F147 PR (Printout).....	20-9
20.7 F148 ERR (Self-Diagnostic Error Set)	20-14
20.8 F149 MSG (Character Send to Programming Tool).....	20-16
20.9 F150 READ (Shared Memory Read)	20-17
20.10 F151 WRT (Write to Shared Memory)	20-20
20.11 F157 CADD (Calendar Data Addition)	20-23
20.12 F158 CSUB (Calendar Data Subtraction).....	20-26
20.13 F160 DSQR (32-bit Data Square Root)	20-31

20.1 F138 HMSS (Hour, Minute, Second Data to Second Data Conversion)

20.1 F138 HMSS (Hour, Minute, Second Data to Second Data Conversion)

Converts data representing hours, minutes, and seconds into data representing seconds.

■ Instruction format

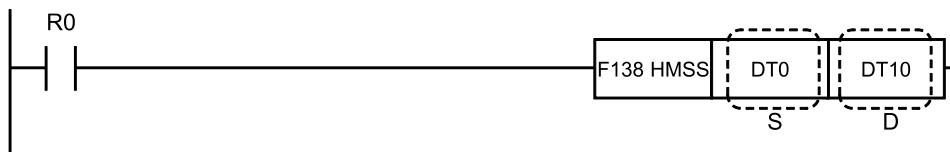

■ Operands

Items	Settings
S	Starting address of the area storing the two-word data representing hours/minutes/seconds
D	Starting address of the area storing the conversion result (second data)

■ Devices that can be specified (indicated by ●)

Operands	WX	WY	WR	WL	SV	EV	DT	LD	I	SWR	SDT	Constant				Index modifier	Integer Device
	K	H	M	f													
S	●	●	●	●	●	●	●	●	●	●	●					●	
D		●	●	●	●	●	●	●	●							●	

■ Outline of operation

- Converts the 2-word time data (hours/minutes/seconds) starting at the address specified by [S], converts it to seconds, and then stores the result in the 2-word area starting from the address specified by [D].

■ Data Structure

- Time data [S] representing hours, minutes, and seconds
 - is composed of 2-word BCD (H constant) data.
 - Specify it as shown below: hours (4-digit), minutes (2-digit), and seconds (2-digit). (Can be specified with a maximum of 9999 hours, 59 minutes, and 59 seconds.)

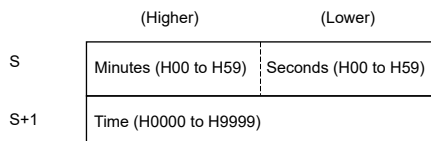

e.g. 3 hours, 45 minutes, and 19 seconds

S = H4519

S+1 = H0003

- Time data [D] representing seconds

20.1 F138 HMSS (Hour, Minute, Second Data to Second Data Conversion)

- is composed of 2-word BCD (H constant, maximum 8-digit) data.
- It is stored as shown below.

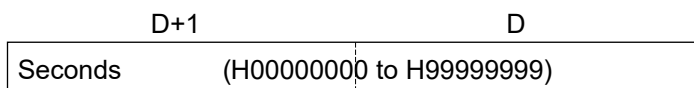

e.g. 35,999,999 seconds

D = H9999

D+1 = H3599

Note: As the maximum time data that can be specified is 9999 hours, 59 minutes, and 59 seconds, the actual maximum value for the seconds that will be stored in [D] is 35,999,999 seconds.

■ Operation example

Operation of instruction format description program

The time data representing hours, minutes, and seconds that is stored in data registers DT0 and DT1 is converted to seconds and then stored in DT10 and DT11 when internal relay R0 turns ON.

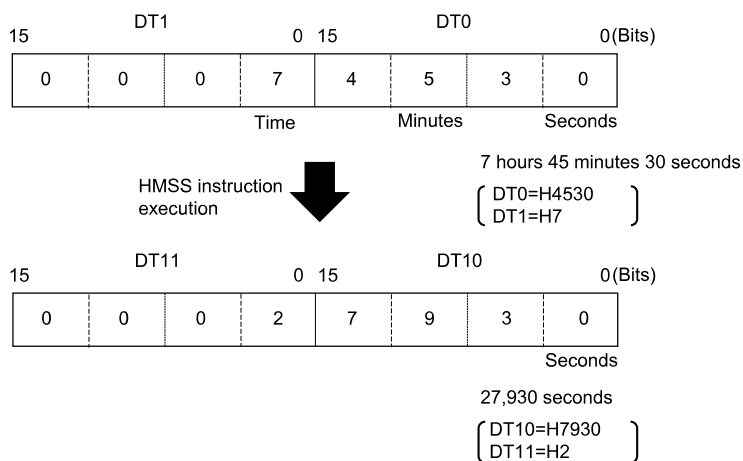

■ Flag operations

Name	Description
R9007 R9008 (ER)	Turns ON when the area is exceeded in index modification.
	Turns ON when the data specified by [S] is not BCD data
	Turns ON when the portion of [S] representing minutes and seconds is exceeds the range of 00 to 59

20.2 F139 SHMS (Second Data to Hour, Minute, Second Data Conversion)

20.2 F139 SHMS (Second Data to Hour, Minute, Second Data Conversion)

Converts data representing seconds (up to 8 digits) to data representing hours, minutes, and seconds.

■ Instruction format

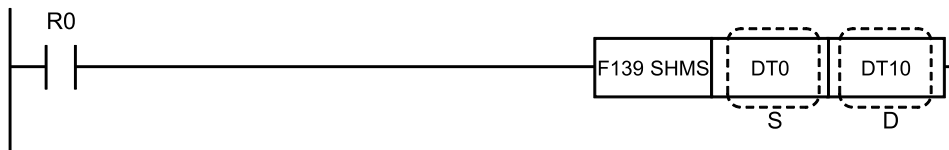

■ Operands

Items	Settings
S	Starting address of the area storing the 2-word data representing seconds
D	Starting address of the area that stores the conversion result (hours, minutes, and seconds data)

■ Devices that can be specified (indicated by ●)

Operands	WX	WY	WR	WL	SV	EV	DT	LD	I	SWR	SDT	Constant				Index modifier	Integer Device
												K	H	M	f		
S	●	●	●	●	●	●	●	●	●	●	●					●	
D		●	●	●	●	●	●	●	●							●	

■ Outline of operation

- Converts the 2-word time data (in seconds) starting from the address specified by [S] to time data expressed in hours, minutes, and seconds (H constant), and stores the result in the 2-word area whose starting address is specified by [D].

■ Data structure

- Time data representing seconds [S]
 - is composed of 2-word BCD (H constant, maximum 8-digit) data.
 - Specify it in seconds as shown below.

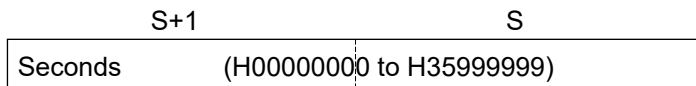

e.g. 35,999,999 seconds

S = H9999

S+1 = H3599

20.2 F139 SHMS (Second Data to Hour, Minute, Second Data Conversion)

Note: The maximum value that can be stored in [D] is 9,999 hours, 59 minutes and 59 seconds, so the maximum value that can be specified for the time data for the seconds unit is 35,999,999 seconds.

- Time data representing hours, minutes, and seconds [D]
 - is composed of 2-word BCD (H constant) data.
 - The time data represents hours (4 digits), minutes (2 digits), and seconds (2 digits) as shown below.

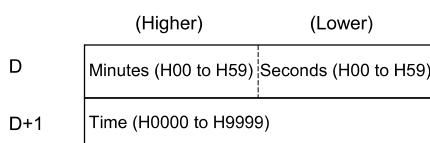

e.g. 3 hours, 45 minutes, and 19 seconds

D = H4519

D+1 = H0003

■ Operation example

Operation of instruction format description program

Converts the seconds data stored in data registers DT0 to DT1 to hour, minute, and second data when internal relay R0 turns ON. The converted hour, minute, and second data is stored in data registers DT10 to DT11.

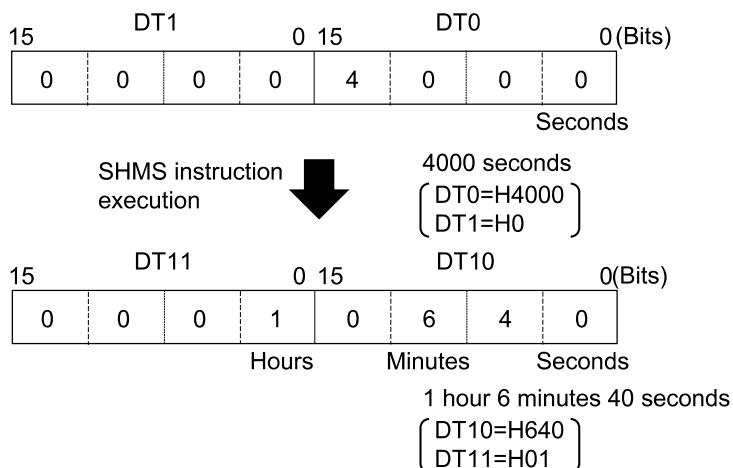

■ Flag operations

Name	Description
R9007	Turns ON when the area is exceeded in index modification.
R9008	Turns ON when the data specified by [S] is not BCD data
(ER)	Turns ON when the content of [S] exceeds 35,999,999

20.3 F140 STC (Cy Flag Set)

20.3 F140 STC (Cy Flag Set)

Turns the CY flag ON.

■ Instruction format

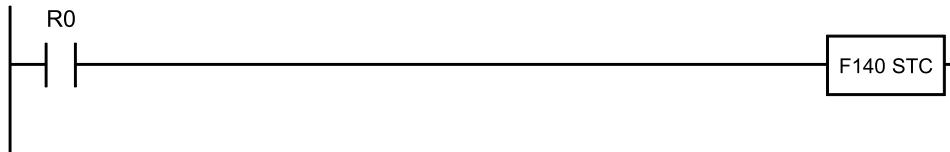

■ Outline of operation

The CY (carry) flag (R9009) is turned ON.

■ Flag operations

Name	Description
R9009 (CY)	Turns ON after this instruction is executed

20.4 F141 CLC (Cy Flag Clear)

Turns the CY flag OFF.

■ Instruction format

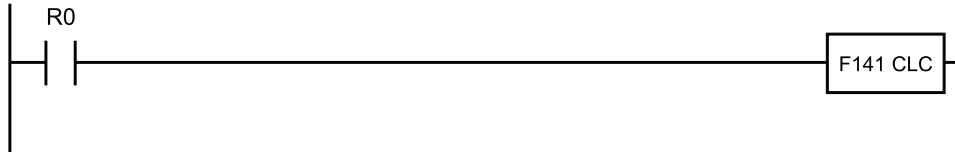

■ Outline of operation

The CY (carry) flag (R9009) is turned OFF.

■ Flag operations

Name	Description
R9009 (CY)	Turns OFF after this instruction is executed

20.5 F143 IORF (Partial I/O refresh)

The input or output of a specified range is refreshed.

■ **Instruction format**

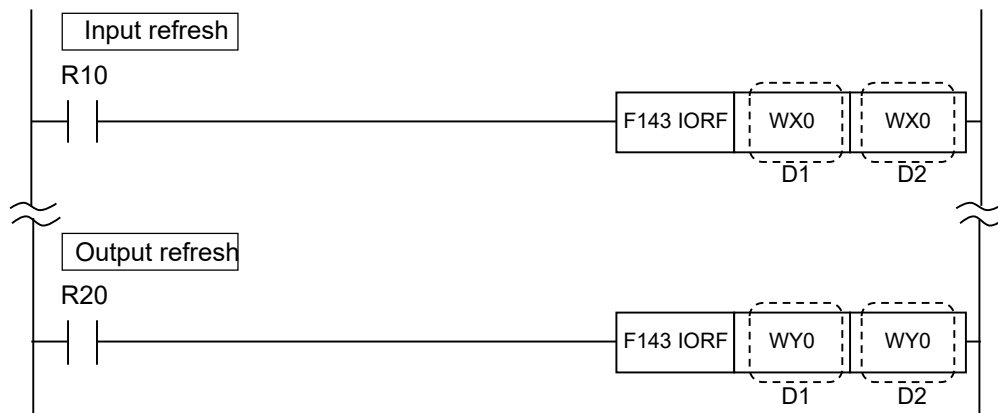

■ **Operands**

Items	Settings
D1	The starting word no. of the I/O to be refreshed.
D2	The ending word no. of the I/O to be refreshed.

■ **Devices that can be specified (indicated by ●)**

Operands	WX	WY	WR	WL	SV	EV	DT	LD	I	SW	SD	Constant				Index modifier	Integer Device
	R	T	K	H	M	f											
D1	●	●														●	
D2	●	●														●	

■ **Outline of operation**

- An I/O refresh (input/output processing) of the external input X or external output Y is executed for a range from the number specified in [D1] to the number specified in [D2].
- When refreshing input, specify WX** to [D1] and [D2].
- When refreshing output, specify WY** to [D1] and [D2].
- Partial refresh of FP0R expansion/FP0 expansion is possible, but will take approx. 1 ms per unit.

■ **Operation example**

Operation of instruction format description program

When internal relay R10 is ON, an I/O refresh of input relay WX0 (X0 to XF) is executed.
 When internal relay R20 is ON, an I/O refresh of output relay WY0 (Y0 to YF) is executed.

20.6 F147 PR (Printout)

Outputs text data (ASCII codes) to the printer.

■ Instruction format

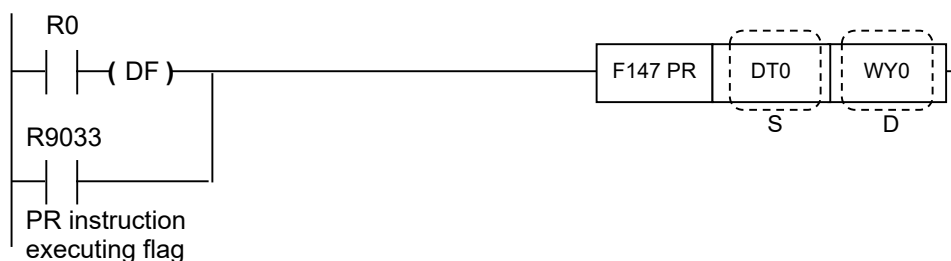

■ Operands

Items	Settings
S	Starting address of the area storing printout data (ASCII codes)
D	Area for output of printout data

■ Devices that can be specified (indicated by ●)

Operands	WX	WY	WR	WL	SV	EV	DT	LD	I	SW R	SD T	Constant				Index modifier	Integer Device
												K	H	M	f		
S	●	●	●	●	●	●	●	●	●	●	●						
D		●															

■ Outline of operation

- Outputs the ASCII codes (for 12 characters) stored in the six-word area starting with the address specified by [S] to the area WY specified by [D].

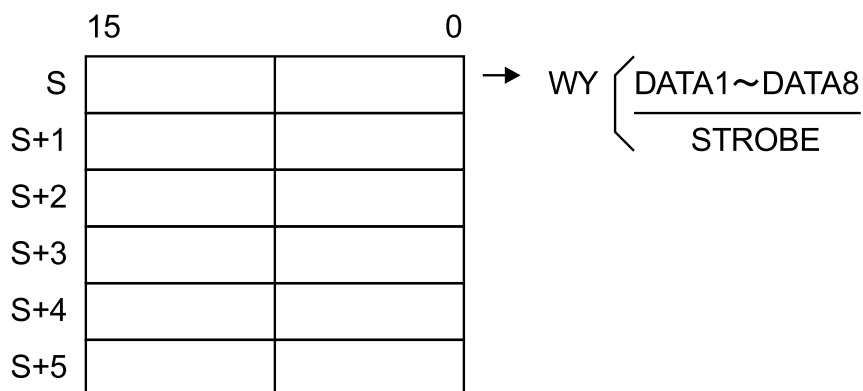

- In the WY area, Y₀ to Y₇ are data signals DATA1 to DATA8, and Y₈ is the strobe signal. Y₉ to Y_F are not used. When the printout instruction is executed, the printout data is output from Y₀ to Y₇ (ASCII code), and the strobe signal is output from Y₈.
- ASCII code is output in order from the starting address.

20.6 F147 PR (Printout)

- Be sure to set the printer control code (LF, CR) as data within the 6-word (12 characters) area above.
- After the start of execution of a printout instruction, 37 scans are required until 12 characters complete output. (See the "P.20-12" Time Chart for more details.)

■ Precautions for programming

- Multiple F147 PR instructions cannot be executed at the same time. The program should be set up so that the printout flag (R9033) is used during execution of a F147 PR instruction to inhibit simultaneous execution.
- The ASCII code conversion instruction (F95 ASC) can be used to convert character constants (M) to ASCII codes.
- Character constants can be input only with programming tool software.
- A transistor-type output unit (output board) is necessary.
- When this instruction is executed, zero <OFF> is set for Y□9 to Y□F in the WY area specified by [D].

■ Operation example

Operation of instruction format description program

The ASCII codes stored in data registers DT0 to DT5 are output to WY0 when internal relay R10 turns ON.

■ Connection method

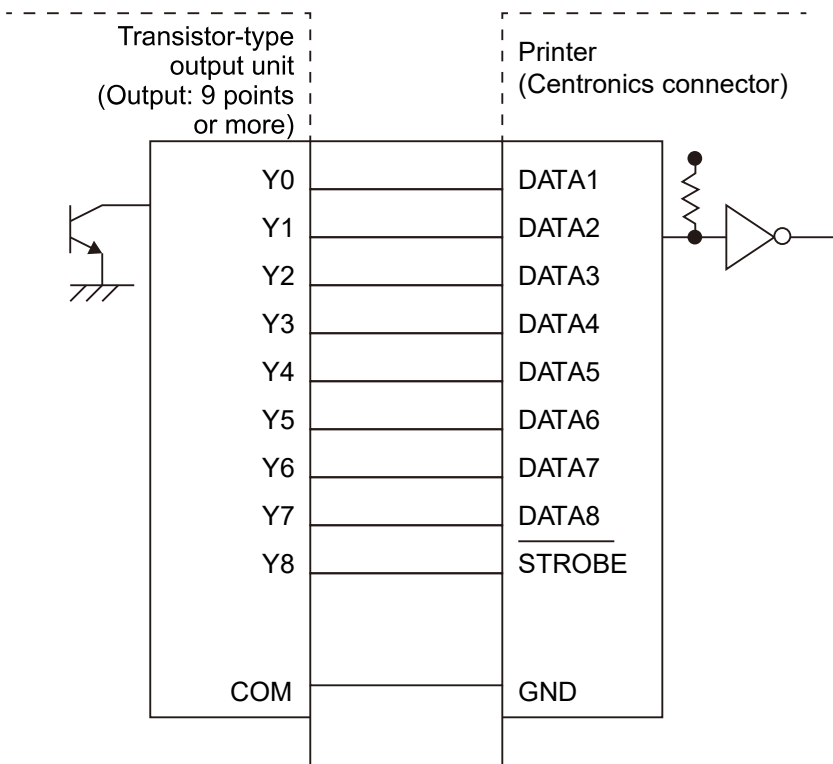

■ Data setting

Set the data to be printed out in order from the lower byte of the first word.

<Example> Outputting 10 characters"ABCDEFGHIJ"to a printer

	15	0
DT0	42	41
DT1	44	43
DT2	46	45
DT3	48	47
DT4	4A	49
DT5	0A	0D

└─┬─> LF
└─┬─> CR

■ Printer output using eight-point output

- When only eight output points are being used, connections should be made as shown below, and the program should be set up so that the strobe signal is output from Y7. However, in this case, only alphanumeric characters can be output.

20.6 F147 PR (Printout)

Connection example

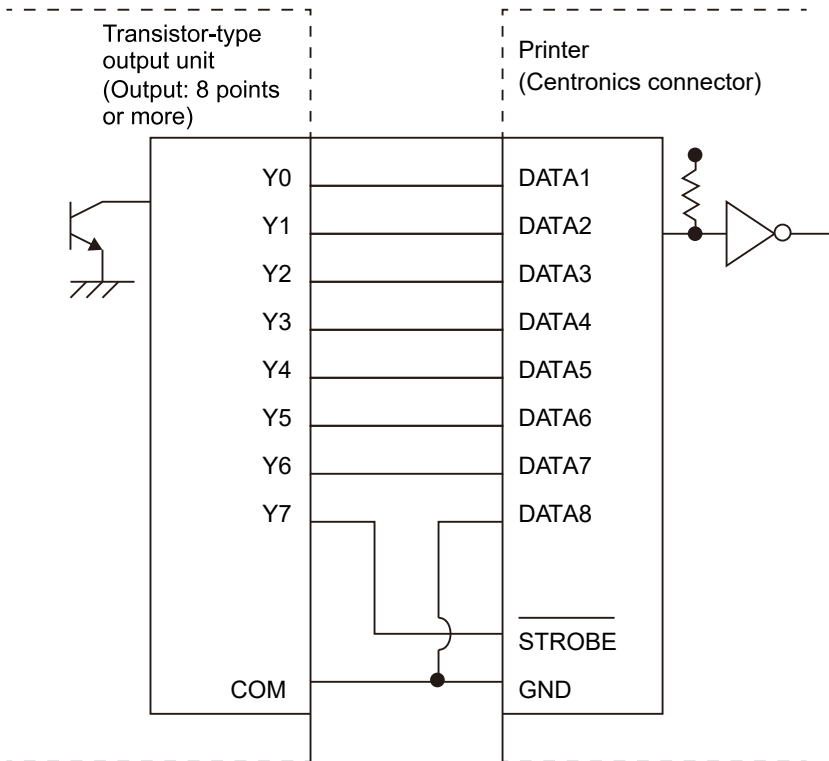

Program example

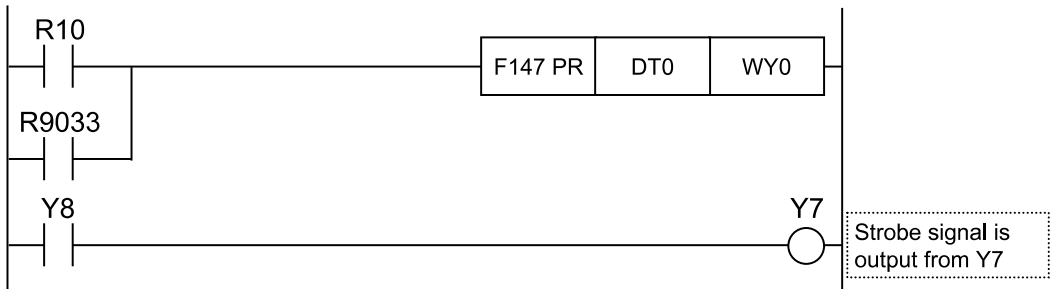

■ Timing chart

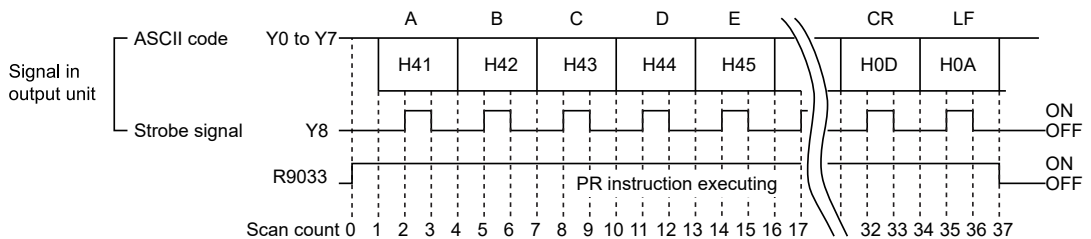

■ Flag operations

Name	Description
R9007	Turns ON when the six words starting with [S] exceed the range of the area
R9008 (ER)	Turns ON when another F147 (PR) instruction attempts execution while one F147 (PR) instruction is being executed

20.7 F148 ERR (Self-Diagnostic Error Set)

20.7 F148 ERR (Self-Diagnostic Error Set)

Detects self-diagnostic errors using a set detection condition.

■ Instruction format

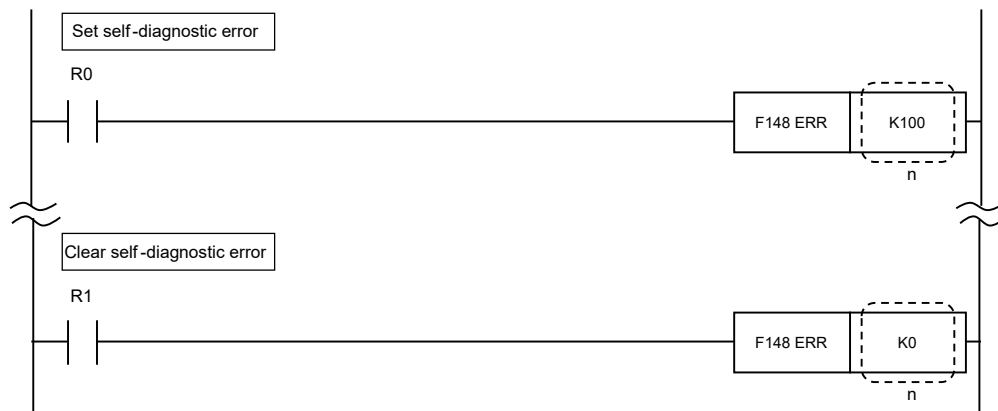

■ Operands

Items	Settings
n	Self-diagnostic error code (0, 100 to 299)

■ Devices that can be specified (indicated by ●)

Operands	WX	WY	WR	WL	SV	EV	DT	LD	I	SWR	SDT	Constant				Index modifier	Integer Device
												K	H	M	f		
n												●	●				

■ Outline of operation

- The self-diagnostic error code specified by [n] is stored in the special data register DT90000 and the self-diagnostic error flag (R9000) is turned ON. Additionally, the ERR/ALM LED flashes.
- [n] (self-diagnostic error code) can be set in the range from K100 to K299. The set value determines whether to stop or continue operation upon execution.

[n] setting	Operation when an error occurs
K100 to K199	Operation stops
K200 to K299	Operation continues

- When K200 to K299 is set for [n], if multiple F148 ERR instructions are processed at the same time, the code with the lower number will be accepted with priority.
- When the F148 ERR instruction is executed with [n] set to 0, self-diagnostic errors with error code 43 or higher are cleared.

Items	Operation when self-diagnostic error is cleared
ERR/ALM LED	- Light switch off

Items		Operation when self-diagnostic error is cleared
R9000	Self-diagnostic error flag	OFF
R9005	Backup battery abnormality flag (current type)	
R9006	Backup battery abnormality flag (hold type)	
R9007	Operation error flag (hold type) (ER flag)	
R9008	Operation error flag (new type) (ER flag)	
R9109	Memory configuration inconsistency detection flag	
R9166	SNTP time update fail	
DT90000	Self-diagnostic error code	0 clear
DT90017	Address with operation error (hold type)	
DT90018	Address with operation error (new type)	
DT90007	Address of system register abnormality	
DT90299	Memory configuration inconsistency details	
DT90590	Network error details	

- F148 ERR instructions with the same error code can be notated in duplicate.

■ Operation example

Operation of instruction format description program

- If internal relay R0 is ON, self-diagnostic error 100 is set. The ERR/ALM LED flashes and operation stops. (Ensure that internal relay R0 is turned ON in situations where the self-diagnostic error 100 is to be set.)
- When internal relay R1 is ON, self-diagnostic errors with error code 43 or higher are cleared.

■ Confirming self-diagnostic errors

- The confirmation method is the same as for normal self-diagnostic errors.
Special data register number: DT90000, DT90017, DT90018

■ Flag operations

Name	Description
R9007 R9008 (ER)	Turns ON when [n] is outside of the specified range

20.8 F149 MSG (Character Send to Programming Tool)

20.8 F149 MSG (Character Send to Programming Tool)

Displays a message on the programming tool.

■ Instruction format

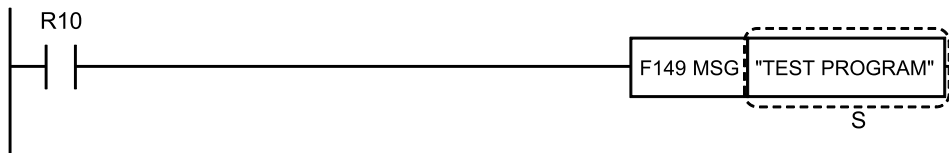

■ Operands

Items	Settings
S	Message (character constant)

■ Devices that can be specified (indicated by ●)

Operands	WX	WY	WR	WL	SV	EV	DT	LD	I	SWR	SDT	Constant				Index modifier	Integer Device
												K	H	M	f		
S														●			

■ Outline of operation

- The characters specified by [S] are displayed on the programming tool connected to the controller.
- The message can also be read from "Message display" on the tool software menu.
- The character constant M can only be input by programming tool software.
- The message flag (R9026) turns ON, and the content of [S] is set to special data registers DT90030 to DT90035.
- If a message is already being displayed, the displayed content does not change even if this instruction is executed. To clear the message displayed, click the "Cancel" button on the "Display PLC Message" screen using the programming tool software.

■ Operation example

Operation of instruction format description program

When internal relay R10 turns ON, the message "TEST PROGRAM" is displayed on the programming tool.

20.9 F150 READ (Shared Memory Read)

Reads data from the memory of the intelligent unit.

■ Instruction format

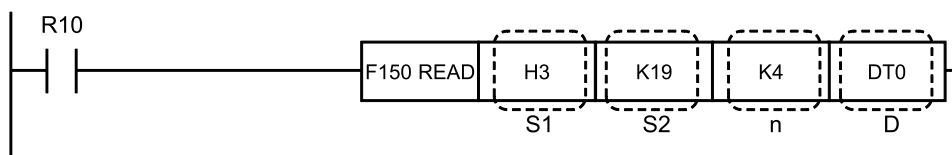

■ Operands

Items	Settings
S1	Slot number and bank number specification
S2	Read start address of the intelligent unit memory
n	Read word count
D	Starting number of area storing read data

■ Devices that can be specified (indicated by ●)

Operands	WX	WY	WR	WL	SV	EV	DT	LD	I	SWR	SDT	Constant				Index modifier	Integer Device
												K	H	M	f		
S1												●	●			●	
S2												●	●			●	
n												●	●			●	
D		●	●	●	●	●	●	●	●							●	

■ Outline of operation

- The number of words [n] of the data stored in the shared memory of the intelligent unit specified by [S1] is read from the address specified by [S2] and is stored from the area specified by [D] in the control unit.

■ Operation example

Operation of instruction format description program

When internal relay R10 turns ON, the four-word data at addresses 19 to 22 is read from the shared memory of the intelligent unit installed in slot number 3 and stored in data registers DT0 to DT3 of the control unit.

20.9 F150 READ (Shared Memory Read)

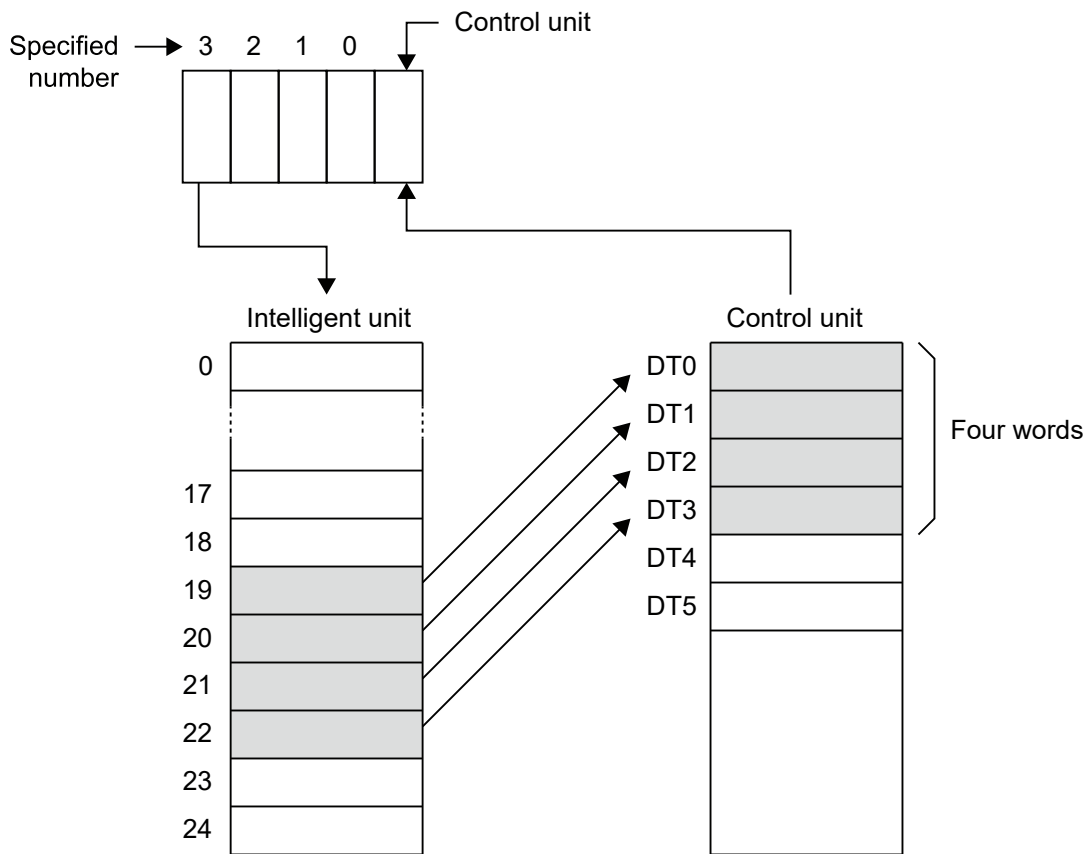

■ Specifying each item

- Specification of slot number and bank number [S1]
Specify the slot where the intelligent unit is installed. If the memory has a bank, specify the bank number as well.
- Read start address of the intelligent unit shared memory [S2]
Specify by referring to the shared memory list for each intelligent unit.
e.g. For address 2, specify K2.
- Read word count [n]
Specify with a K constant.
e.g. To read 10 words of data, specify K10.

■ How to specify S1

(1) For intelligent units without banks

Specify the slot number where the target intelligent unit is installed.

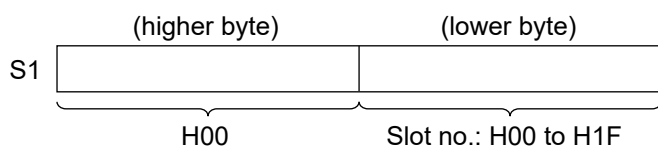

(2) For intelligent units with banks

Specify the slot number (H constant) where the target intelligent unit is installed and the bank number (H constant).

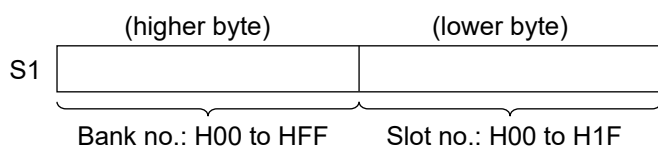

■ How to specify slot numbers

The slot number of the target intelligent unit is automatically allocated according to the installation position.

Slots are numbered from left to right from the control unit side.

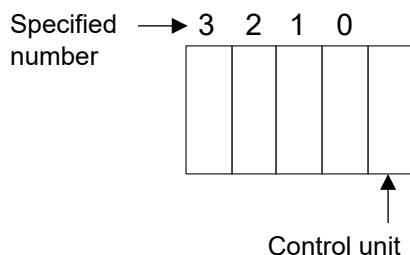

■ Flag operations

Name	Description
R9007	Turns ON when the value of [S1] is out of the specified range
R9008	Turns ON when the area is exceeded in index modification.
(ER)	Turns ON when the read data exceeds the area [D]

20.10 F151 WRT (Write to Shared Memory)

20.10 F151 WRT (Write to Shared Memory)

Writes data into the memory in an intelligent unit.

■ Instruction format

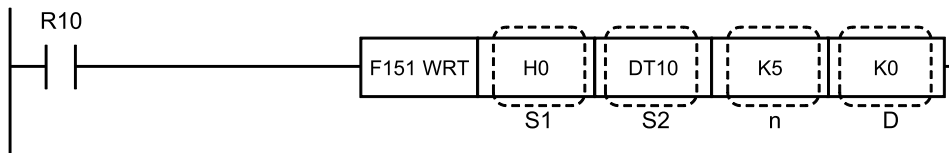

■ Operands

Items	Settings
S1	Slot number and bank number specification
S2	Starting number of area storing the write data
n	Number of words to be written
D	Starting address for writing in the memory of the intelligent unit

■ Devices that can be specified (indicated by ●)

Operands	WX	WY	WR	WL	SV	EV	DT	LD	I	SWR	SDT	Constant				Index modifier	Integer Device
												K	H	M	f		
S1												●	●			●	
S2	●	●	●	●	●	●	●	●	●	●	●	(N ot e 1)	(N ot e 1)			●	
n												●	●			●	
D												●	●			●	

(Note 1) If K/H constants are specified in [S2], the [S2] stored value (one word) is written to the address specified by [D]. The number of words to be written is fixed at 1, so any specification of [n] is ignored.

■ Outline of operation

- With the area in the control unit specified by [S2] as the start, [n] words of data are written to the shared memory of the intelligent unit specified by [S1], starting from the address specified by [D].

■ Operation example

Operation of instruction format description program

Five words of data from data registers DT10 to DT14 of the control unit are written into the addresses 0 to 4 of the intelligent unit shared memory (located in slot 0) when internal relay R10 turns ON.

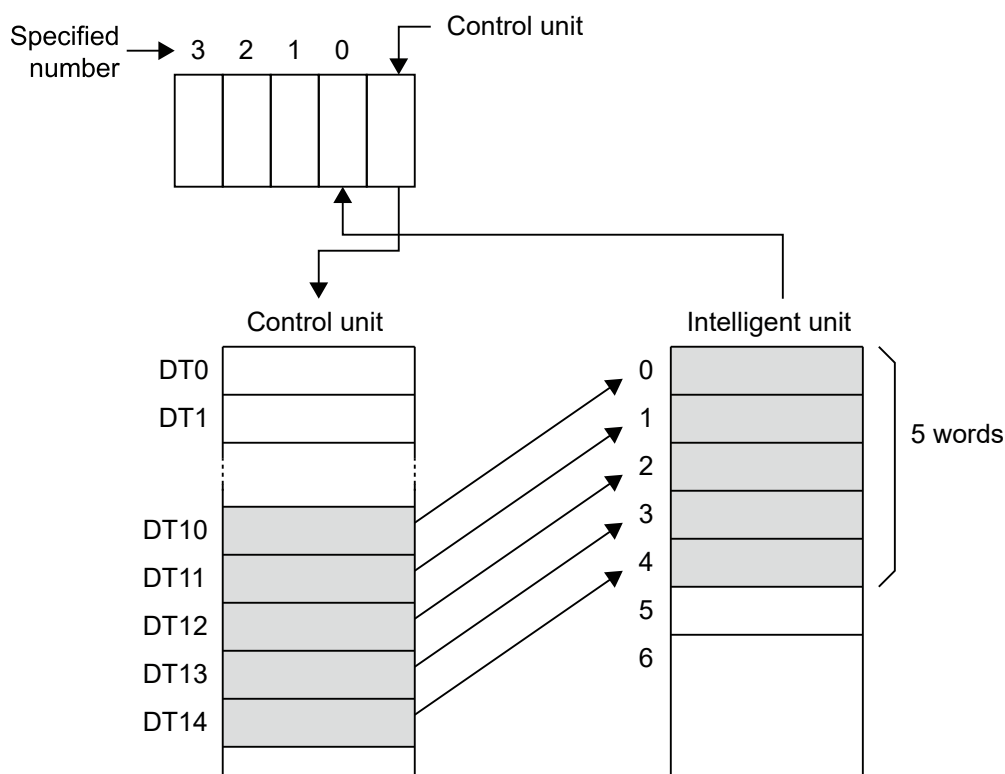

■ Specifying each item

- Specification of slot number and bank number [S1]
Specify the slot where the intelligent unit is installed. If the memory has a bank, specify the bank number as well.
- Number of words to be written [n]
Specify with a K constant.
e.g. To write 10 words of data, specify "K10".
- Starting address [D] for writing in the shared memory of the intelligent unit
Specify by referring to the shared memory list for each intelligent unit.
e.g. To specify address 2, specify "K2".

■ How to specify S1

(1) For intelligent units without banks

Specify the slot number where the target intelligent unit is installed.

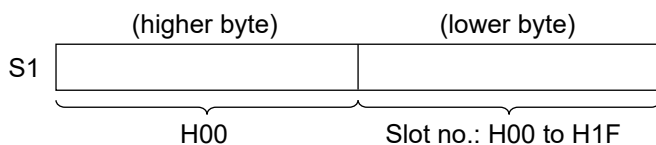

20.10 F151 WRT (Write to Shared Memory)

(2) For intelligent units with banks

Specify the slot number (H constant) where the target intelligent unit is installed and the bank number (H constant).

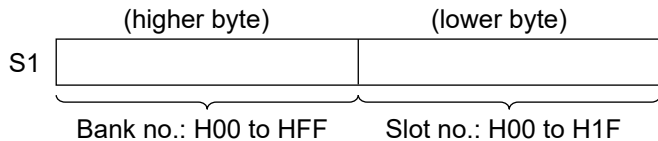

■ How to specify slot numbers

The slot number of the target intelligent unit is automatically allocated according to the installation position.

Slots are number from left to right from the control unit side.

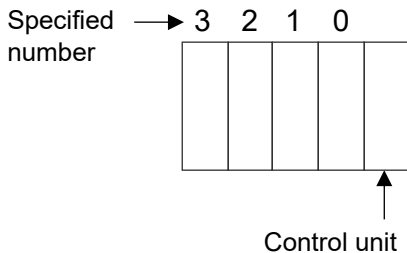

■ Flag operations

Name	Description
R9007	Turns ON when the value of [S1] is out of the specified range
R9008	Turns ON when the area is exceeded in index modification.
(ER)	Turns ON when the range of writing data exceeds the area specified by [S2]

20.11 F157 CADD (Calendar Data Addition)

Calculates the date and time after a specified amount of time (hours, minutes, and seconds) has elapsed since a certain date and time (year, month, day, hour, minute, second).

■ Instruction format

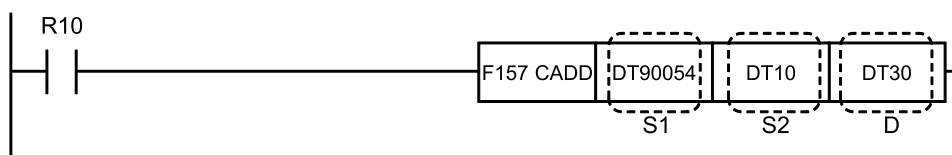

■ Operands

Items	Settings
S1	Starting address of area storing date and time data (three words)
S2	Starting address of area storing date and time data (two words), or constant data
D	Starting address of area storing addition result date and time data (three words)

■ Devices that can be specified (indicated by ●)

Operand s	WX	WY	WR	WL	SV	EV	DT	LD	I	SW R	SD T	Constant				Index modifier	Integer Device
												K	H	M	f		
S1	●	●	●	●	●	●	●	●		●	●					●	
S2	●	●	●	●	●	●	●	●	●	●	●	●	●			●	
D		●	●	●	●	●	●	●								●	

■ Outline of operation

- The three-word date and time data (year, month, day, hour, minute, second) that starts at the address specified by [S1] and the time data (hours, minutes, and seconds) specified by [S2] are added together. The result (time of elapsed value) is stored in the three-word area that starts at the address specified by [D].

20.11 F157 CADD (Calendar Data Addition)

<Time data>	(Higher)	(Lower)
[S1]	Minutes (H00 to H59)	Seconds (H00 to H59)
[S1+1]	Day (H01 to H31)	Hour (H01 to H23)
[S1]+2	Year (H00 to H99)	Month (H00 to H12)

+ (addition)

<Time data>	(Higher)	(Lower)
[S1]	Minutes (H00 to H59)	Seconds (H00 to H59)
[S1+1]	Time (H0000 to H9999)	



<Time data>	(Higher)	(Lower)
[D]	Minutes (H00 to H59)	Seconds (H00 to H59)
[D+1]	Day (H01 to H31)	Hour (H01 to H23)
[D]+2	Year (H00 to H99)	Month (H00 to H12)

- Specify the values for date and time data [S1] and time data [S2] using BCD data (H constant).

[Example of date and time data]

14 hours, 23 minutes, and 31 seconds on August 1, 1992

S1 = H2331 (23 hours, 31 minutes)

S1+1 = H0114 (1st of the month, 14th hour)

S1+2 = H9208 (1992, August)

[Example of time data]

32 hours, 50 minutes, and 45 seconds

S2 = H5045 (50 minutes, 45 seconds)

S2+1 = H0032 (32 hours)

■ Operation example

Operation of instruction format description program

When internal relay R0 turns ON, the built-in calendar timer reads date and time data and adds the time data stored in data registers DT10 and DT11. The date and time resulting from the addition is stored in DT30 to DT32.

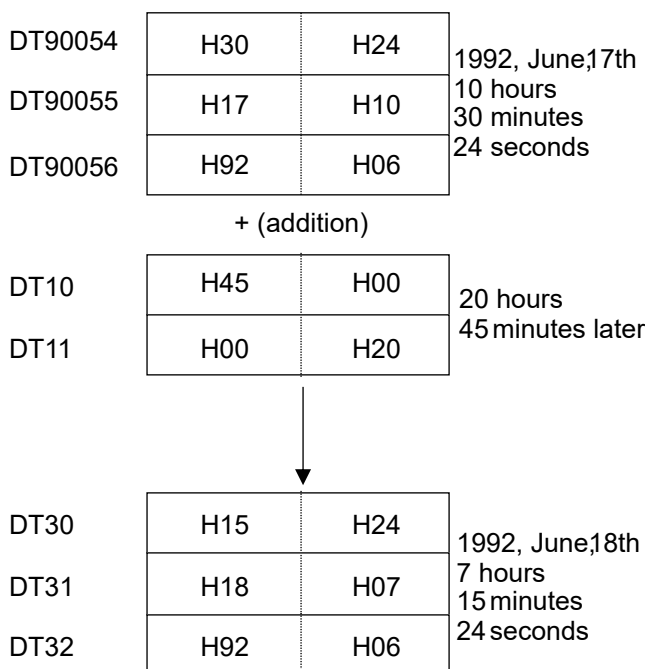

■ Data configuration of built-in calendar timer

	(Higher)	(Lower)
DT90054	Minutes	Seconds
DT90055	Day	Hours
DT90056	Year	Month

■ Precautions for programming

Special data registers DT90054 to DT90056, in which the values of the built-in calendar timer are stored, cannot be specified directly for [D]. To change the values of the built-in calendar timer, store the addition results in a separate memory area, and then use the F0 MV instruction to transfer the values to DT90054 to DT90056.

■ Flag operations

Name	Description
R9007 R9008 (ER)	Turns ON when the area is exceeded in index modification.
	Turns ON when the data specified by [S1] and [S2] is not BCD data
	Turns ON when the data specified by [S1] is not date and time data
	Turns ON when the data specified by [S2] is not time data
	Turns ON when the specified data exceeds the area

20.12 F158 CSUB (Calendar Data Subtraction)

20.12 F158 CSUB (Calendar Data Subtraction)

Calculates the date and time a specified amount of time (hours, minutes, and seconds) before a certain date and time (year, month, day, hour, minute, second).

■ Instruction format

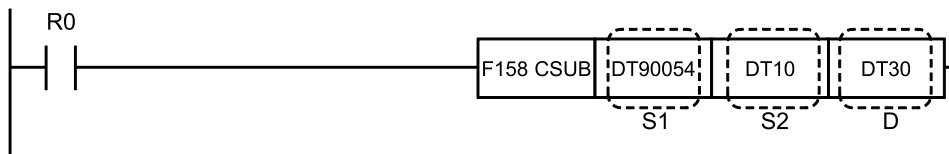

■ Operands

Items	Settings
S1	Starting address of area storing date and time data (three words)
S2	Starting address of area storing date and time data (two words), or constant data
D	Starting address of area storing subtraction result date and time data (three words)

■ Devices that can be specified (indicated by ●)

Operands	WX	WY	WR	WL	SV	EV	DT	LD	I	SW R	SD T	Constant				Index modifier	Integer Device
												K	H	M	f		
S1	●	●	●	●	●	●	●	●		●	●					●	
S2	●	●	●	●	●	●	●	●	●	●	●	●	●			●	
D		●	●	●	●	●	●	●								●	

■ Outline of operation

- The time data (hours, minutes, and seconds) specified by [S2] is subtracted from the three-word date and time data (year, month, day, hour, minute, second) that starts at the address specified by [S1]. The result is stored in the three-word area that starts at the address specified by [D].

<Time data>	(Higher)	(Lower)
[S1]	Minutes (H00 to H59)	Seconds (H00 to H59)
[S1+1]	Day (H01 to H31)	Hour (H01 to H23)
[S1+2]	Year (H00 to H99)	Month (H00 to H12)

- (subtraction)

<Time data>	(Higher)	(Lower)
[S1]	Minutes (H00 to H59)	Seconds (H00 to H59)
[S2+1]	Time (H0000 to H9999)	



<Time data>	(Higher)	(Lower)
[D]	Minutes (H00 to H59)	Seconds (H00 to H59)
[D1+1]	Day (H01 to H31)	Hour (H01 to H23)
[D1+2]	Year (H00 to H99)	Month (H00 to H12)

- Specify the values for date and time data [S1] and time data [S2] using BCD data (H constant).

[Example of date and time data]

14 hours, 23 minutes, and 31 seconds on December 1, 1994

S1 = H2331 (23 hours, 31 minutes)

S1+1 = H0114 (1st of the month, 14th hour)

S1+2 = H9412 (1994, December)

[Example of time data]

32 hours, 50 minutes, and 45 seconds

S2 = H5045 (50 minutes, 45 seconds)

S2+1 = H0032 (32 hours)

■ Operation example

Operation of instruction format description program

When internal relay R0 turns ON, the built-in calendar timer reads date and time data and subtracts the time data stored in data registers DT10 and DT11. The date and time resulting from the subtraction is stored in DT30 to DT32.

20.12 F158 CSUB (Calendar Data Subtraction)

DT90054	H30	H24	1992, June,17th 10 hours 30 minutes 24 seconds
DT90055	H17	H10	
DT90056	H92	H06	
- (subtraction)			
DT10	H30	H30	3 hours 30 minutes 30 second earlier
DT11	H00	H03	
↓			
DT30	H59	H54	1992, June,17th 6 hours 59 minutes 54 seconds
DT31	H17	H06	
DT32	H92	H06	

■ Precautions for programming

Special data registers DT90054 to DT90056, in which the values of the built-in calendar timer are stored, cannot be specified directly for [D]. To change the values of the built-in calendar timer, store the addition results in a separate memory area, and then use the F0 MV instruction to transfer the values to DT90054 to DT90056.

■ Usage example: Calculating elapsed time

The F158 CSUB instruction can be used to calculate elapsed time. Using the calendar timer, the starting date and time and the ending date and time are stored in the data memory and the time that has elapsed between them is calculated.

This is explained using the example of calculating the stopped time for an operation that stopped at 08 hours, 02 minutes, and 15 seconds and restarted at 10 hours, 30 minutes, and 25 seconds.

This can be thought of as "subtracting 8 hours, 2 minutes, and 15 seconds from 10 hours, 30 minutes, and 25 seconds".

Start time [S2]	02	15	2 minutes, 15 seconds
	23	08	23rd day, 8 hours
	94	12	1994, December

Start time [S2]	30	25	30 minutes, 25 seconds
	23	10	23rd day, 10 hours
	94	12	1994, December

The data to be subtracted is taken from the starting date and time data as is shown below.

02	15	2 minutes, 15 seconds
00	08	8 hours

The part representing "day" is set to 0

↓ CSUB instruction executio

The result will be as follows.

[D]	02	10	2 minutes, 10 seconds
	23	02	23rd day, 2 hours
	94	12	1994, December

■ Data configuration of built-in calendar timer

	(Higher)	(Lower)
DT90054	Minutes	Seconds
DT90055	Day	Hours
DT90056	Year	Month

■ Flag operations

Name	Description
R9007 R9008 (ER)	Turns ON when the area is exceeded in index modification.
	Turns ON when the data specified by [S1] and [S2] is not BCD data
	Turns ON when the data specified by [S1] is not date and time data
	Turns ON when the data specified by [S2] is not time data

20.12 F158 CSUB (Calendar Data Subtraction)

Name	Description
	Turns ON when the specified data exceeds the area

20.13 F160 DSQR (32-bit Data Square Root)

Calculates the square root of the specified 32-bit data.

■ **Instruction format**

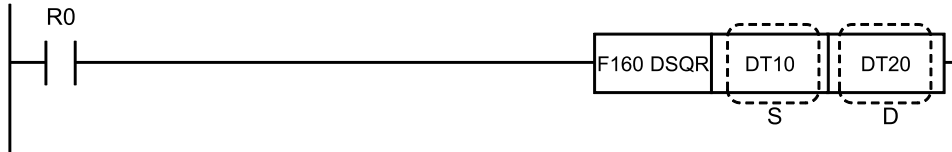

■ **Operands**

Items	Settings
S	Area storing the data for square root calculation, or constant data
D	Area storing the calculated square root

■ **Devices that can be specified (indicated by ●)**

Operands	WX	WY	WR	WL	SV	EV	DT	LD	I	SWR	SDT	Constant				Index modifier	Integer Device
												K	H	M	f		
S	●	●	●	●	●	●	●	●	●			●	●			●	
D		●	●	●	●	●	●	●	●							●	

■ **Outline of operation**

- Calculates the square root of the 32-bit data (K constant) stored in [S] and [S+1], then stores the result (K constant) in [D] and [D+1]. Fractions are rounded down.
 $\sqrt{[S]} \rightarrow [D]$

■ **Operation example**

Operation of instruction format description program

The square root ($\sqrt{\quad}$) of the 32-bit data stored in DT10 and DT11 is calculated and the result stored in DT20 and DT21 when internal relay R0 turns ON. When K64 is stored in DT10 to DT11, it will be as follows.

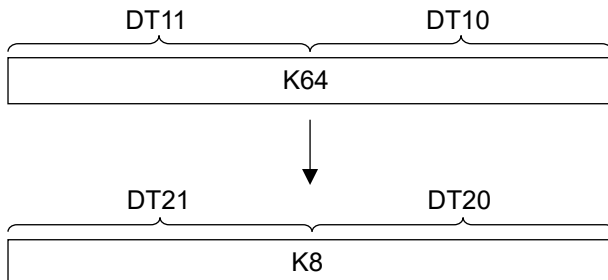

Finds the square root of 64, which is 8.

20.13 F160 DSQR (32-bit Data Square Root)

■ Flag operations

Name	Description
R9007	Turns ON when the area is exceeded in index modification.
R9008 (ER)	ON when the data specified by [S] is a negative value

21 Serial Communication Instructions

21.1 F145 SEND / F146 RECV Instructions: Common Items (Serial Communication)	21-2
21.2 F145 SEND [MEWTOCOL Master Send (Serial Communication)]...21-4	
21.3 F146 REC [MEWTOCOL Master Receiver (Serial Communication)]	21-8
21.4 F145 SEND [MODBUS Master Send: Function Code Specification (Serial Communication)]	21-12
21.5 F146 RECV [MODBUS Master Receiver: Function Code Specification (Serial Communication)]	21-17
21.6 F145 SEND [MODBUS Master Send: No Function Code Specification (Serial Communication)]	21-22
21.7 F146 RECV [MODBUS Master Receiver: No Function Code Specification (Serial Communication)]	21-28
21.8 F159 MTRN [General-purpose Communication Instructions (Serial Communication)]	21-36

21.1 F145 SEND / F146 RECV Instructions: Common Items (Serial Communication)

■ System register settings

Use tool software to set the communication mode of the COM port used.

Mode	System register No. 412
MEWTOCOL master	Computer link
MODBUS master	MODBUS RTU

■ Conditions for execution of the instruction

- Multiple SEND instructions or RECV instructions cannot be executed simultaneously to the same communication port. Set up the program so that SEND/RECV instructions are executed when the SEND/RECV execution enabled flag is ON (1).

Info.

- In global transfer (send implemented by specifying H00 as the unit number), the SEND/RECV execution enabled flag does not turn OFF (0). Set up the program so that after a send is completed, the next send is performed after waiting for at least the maximum scan time.

■ Confirmation of execution of the instruction

- The operation processing time for the SEND/RECV instruction is only for the request to send; the actual send is performed when the ED instruction is executed. Check the SEND/RECV instruction completion flag to confirm the completion of sending.
- When the instruction terminates abnormally, the SEND / RECV done flag turns ON. Also, an error code is stored in the SEND / RECV done code. For details of error codes, refer to the following table.

Special data register	Error code	Description
DT90123 to DT90125	H0	Normal end
	H73	Timeout error occurred while waiting for a response
	Error code of each protocol	For details of error codes, refer to the error codes of each protocol. <ul style="list-style-type: none"> "38.12.3 List of MEWTOCOL-COM/DAT Communication Error Codes" "38.12.4 List of MODBUS Communication Error Codes"

Name	Operation	COM0	COM1	COM2
SEND/RECV Execution enabled flag	0: Execution disabled 1: Execution enabled	R9134	R913C (R9044)	R9144 (R904A)
SEND/RECV Completion flag	0: Normal end 1: Abnormal end	R9135	R913D (R9045)	R9145 (R904B)
SEND/RECV Done codes	In case of abnormal end, the error code is stored.	DT90123	DT90124	DT90125

21.1 F145 SEND / F146 RECV Instructions: Common Items (Serial Communication)

(Note 1) The numbers inside the parentheses indicate the serial numbers of devices that are compatible with the existing products FP0R, FP-X, and FPsigma.

■ **Timeout period setting**

- If the error code is H73, it means that a timeout has occurred while waiting for a response.
- The timeout time can be changed from 10.0 ms to 81.9 s (in 2.5-ms units) by using system register No. 32. By default, the value is set to 10 s.

■ **Other restrictions**

These instructions cannot be executed on special internal relays (R9000 and up) or special data registers (DT90000).

21.2 F145 SEND [MEWTOCOL Master Send (Serial Communication)]

21.2 F145 SEND [MEWTOCOL Master Send (Serial Communication)]

■ Instruction format

For Type without Ethernet Function

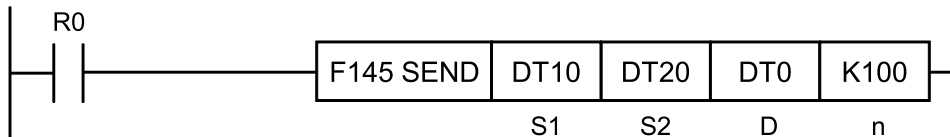

For Type with Ethernet Function



- When using both the serial communication and Ethernet communication within a program, specify the serial communication port using the F469 (UNITSEL) instruction before executing the F145 (SEND) instruction.

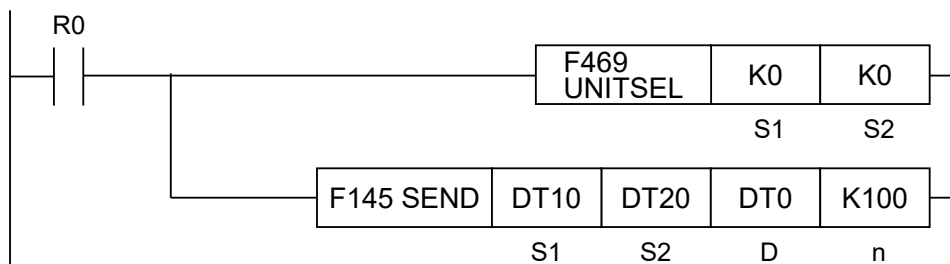

■ Operands

Operands	Settings	
S1	Specify the starting number of the area (2 words) that stores control data.	
	S1	Specify the transfer method. Word transfer: Specify the number of send words. Bit transfer: Specify the bit number of a master unit and that of a destination unit.
	S1+1	Specify the COM port No. of a master unit and the unit number of a destination unit.
S2	Specification of a master unit	Specify the area of a master unit that stores send data.
D	Specification of a destination unit	Specify the area type of a destination unit that stores send data. The number is specified at 0.
n	Specification of a destination unit	Specify the starting address of a destination unit that stores send data. (Specification range: H0 to HFFFF)

21.2 F145 SEND [MEWTOCOL Master Send (Serial Communication)]

■ Devices that can be specified (indicated by ●)

Operands	WX	WY	WR	WL	SV	EV	DT	LD	In	SWR	SDT	Constant		Index modifier (Note 1)
												K	H	
S1	●	●	●	●	●	●	●	●		●	●			●
S2	●	●	●	●	●	●	●	●		●	●			●
D		●	●	●	●	●	●	●						
n		●	●	●	●	●	●	●				●	●	●

(Note 1) A character constant cannot be specified.

■ Control data specification

Specification of [S1]

For [S1], specify the transfer method. The specification method differs depending on word transfer and bit transfer.

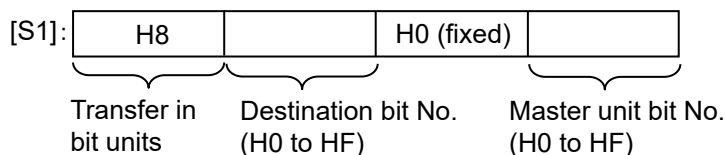
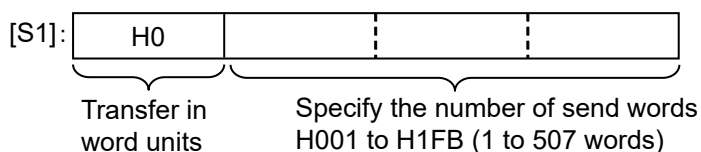

Specification of [S1+1]

For [S1+1], specify the COM port number of a master unit and the unit number of a destination unit.

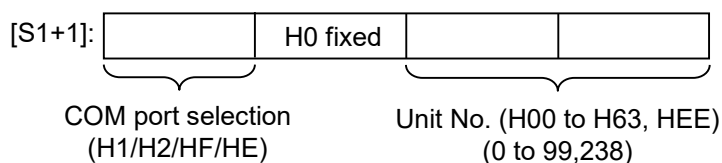

COM port selection

COM ports can be selected as shown in the following table.

COM port selection (upper four bits)	H1	H2	HF	HE
Port number	COM1	COM2	COM0	Port number specified for the F469 (UNITSEL) instruction

21.2 F145 SEND [MEWTOCOL Master Send (Serial Communication)]

Destination unit number selection

On unit firmware Ver. 1.8 or later, adding a specification of HEE (238) for the destination unit number allows for communication to be carried out regardless of destination unit number.

■ Specifying the storage area of a destination unit by using [D] and [n]

Specify "0" for [D] as the device number.

Specify the memory area of a destination unit that stores sent data, by combining [D] (type) and [n] (address).

Example 1: [D]: DT0, [n]: K100

↓
DT100

Example 2: [D]: DT0, [n]: HFFF0

↓
DT65520

■ Specifying a COM port number for the F469 (UNITSEL) instruction (only for the type with Ethernet Function)

Specifying HE in the upper four bits of [S1+1] of F145 (SEND) enables operand [S2] for the F469 (UNITSEL) instruction. The following figure shows that the F469 (UNITSEL) instruction specifies S1=K0 (serial communication port) and S2=K1 (COM1).

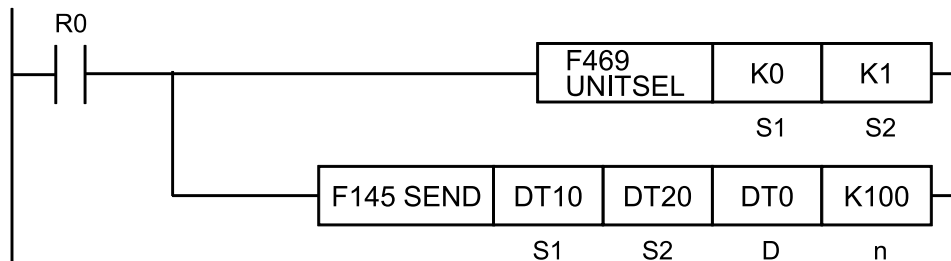

[S2] of F469 (UNITSEL)	K0	K1	K2
Port number	COM0	COM1	COM2

■ Flag operations

Name	Description
R9007 R9008 (ER)	Turns ON when the [S1] / [S1+1] control data value is outside the specified range.
	Turns ON when the [S2] or [D] area is exceeded, if the number of words specified in [S1] is taken during transfer in word units.
	Turns ON when [D]+[n] exceeds the [D] area
	Turns ON when the operation mode of the target COM port is other than computer link.
	Word unit <ul style="list-style-type: none"> If [D] is DT / LD, turns ON when [n] is not from 0 to 99999 If [D] is WY / WR / WL / SV / EV, turns ON when [n] is not from 0 to 9999.
	Bit unit <ul style="list-style-type: none"> Turns ON when [D] is not WY / WR / WL Turns ON when [n] is not from 0 to 999.

21.2 F145 SEND [MEWTOCOL Master Send (Serial Communication)]

Name	Description
	Turns ON when the [D] device No. is not 0.
	Turns ON when a communication cassette is not attached to the target COM port.

21.3 F146 REC [MEWTOCOL Master Receiver (Serial Communication)]

21.3 F146 REC [MEWTOCOL Master Receiver (Serial Communication)]

■ Instruction format

For Type without Ethernet Function

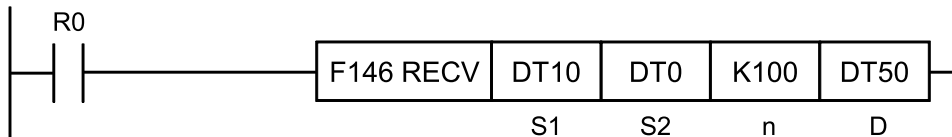

For Type with Ethernet Function



- When using both the serial communication and Ethernet communication within a program, specify the serial communication port using the F469 (UNITSEL) instruction before executing the F146 (RECV) instruction.

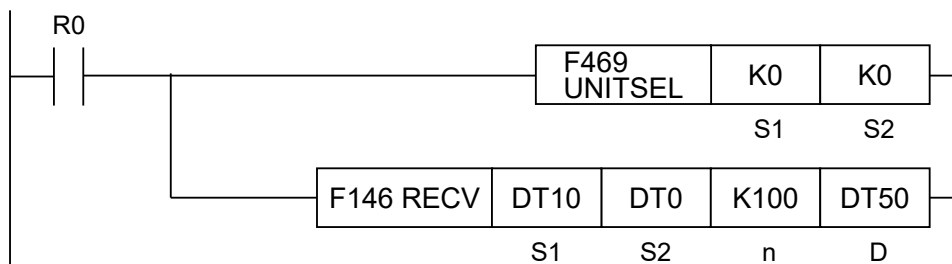

■ Operands

Operands	Settings	
S1	Specify the starting number of the area (2 words) that stores control data.	
	S1	Specify the transfer method. Word transfer: Specify the number of send words. Bit transfer: Specify the bit number of a master unit and that of a destination unit.
	S1+1	Specify the COM port No. of a master unit and the unit number of a destination unit.
S2	Specification of a destination unit	Specify the source data area of a destination unit. (Device No. is fixed to "0")
n	Specification of a destination unit	Specify the starting address of the device in the source data area of a destination unit. (Setting range: H0 to HFFFF)
D	Specification of a master unit	Specify the device starting address of the receive data storage area in the master unit.

■ **Devices that can be specified (indicated by ●)**

Operands	WX	WY	WR	WL	SV	EV	DT	LD	In	SWR	SDT	Constant		Index modifier (Note 1)
												K	H	
S1	●	●	●	●	●	●	●	●		●	●			●
S2	●	●	●	●	●	●	●	●						
n		●	●	●	●	●	●	●				●	●	●
D		●	●	●	●	●	●	●						●

(Note 1) A character constant cannot be specified.

■ **Specifying control data [S1], [S1+1]**

Specification of [S1]

For [S1], specify the transfer method. The specification method differs depending on word transfer and bit transfer.

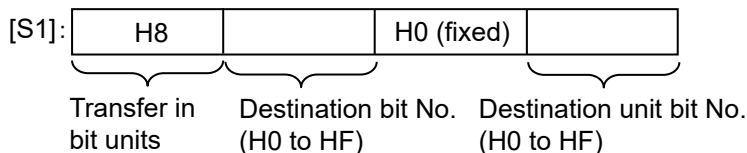
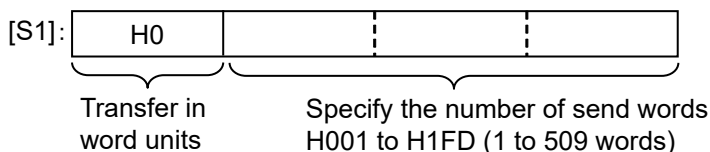

Specification of [S1+1]

For [S1+1], specify the COM port number of a master unit and the unit number of a destination unit.

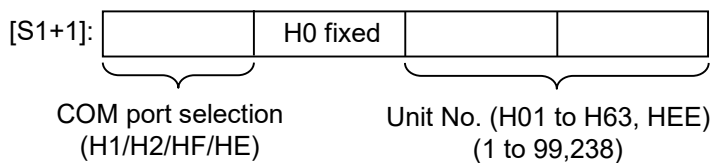

COM port selection

COM ports can be selected as shown in the following table.

COM port selection (upper four bits)	H1	H2	HF	HE
Port number	COM1	COM2	COM0	Port number specified for the F469 (UNITSEL) instruction

21.3 F146 REC [MEWTOCOL Master Receiver (Serial Communication)]

Destination unit number selection

On unit firmware Ver. 1.8 or later, adding a specification of HEE (238) for the destination unit number allows for communication to be carried out regardless of destination unit number.

■ Specifying [S2] as the starting address of the source data area

Specify "0" for [S2] as the device number. Specify the memory area of a destination unit that stores sent data, by combining [S2] (type) and [n] (address).

Example 1: [S2]: DT0, [n]: K100

↓
DT100

Example 2: [S2]: DT0, [n]: HFFF0

↓
DT65520

■ Specifying a COM port number for the F469 (UNITSEL) instruction (only for the type with Ethernet Function)

Specifying HE in the upper four bits of [S1+1] of the F146 (RECV) enables operand [S2] for the F469 (UNITSEL) instruction. The following figure shows that the F469 (UNITSEL) instruction specifies S1=K0 (serial communication port) and S2=K1 (COM1).

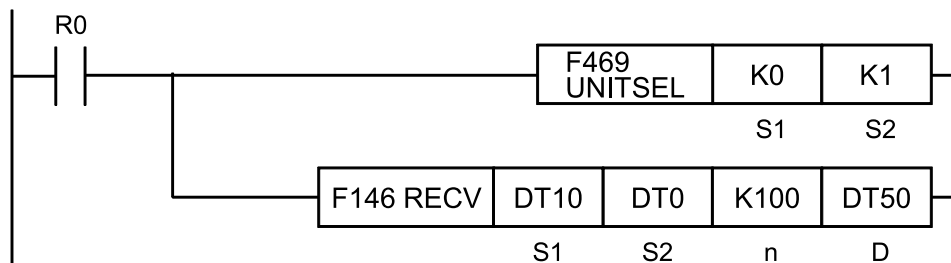

[S2] of F469 (UNITSEL)	K0	K1	K2
Port number	COM0	COM1	COM2

■ Flag operations

Name	Description
R9007 R9008 (ER)	Turns ON when the [S1] / [S1+1] control data value is outside the specified range.
	Turns ON when the [S2] or [D] area is exceeded, if the number of words specified in [S1] is taken during transfer in word units.
	Turns ON when [S2]+[n] exceeds the [S2] area.
	Turns ON when the operation mode of the target COM port is other than computer link.
	Word unit <ul style="list-style-type: none"> If [S2] is DT / LD, turns ON when [n] is not from 0 to 99999. If [S2] is WX / WY / WR / WL / SV / EV, turns ON when [n] is not from 0 to 9999.
Bit unit <ul style="list-style-type: none"> Turns ON when [S2] is not WX / WY / WR / WL. Turns ON when [n] is not from 0 to 999. 	
	Turns ON when the [S2] device No. is not 0.

21.3 F146 REC [MEWTOCOL Master Receiver (Serial Communication)]

Name	Description
	Turns ON when a communication cassette is not attached to the target COM port.

21.4 F145 SEND [MODBUS Master Send: Function Code Specification (Serial Communication)]

21.4 F145 SEND [MODBUS Master Send: Function Code Specification (Serial Communication)]

■ Instruction format

For Type without Ethernet Function

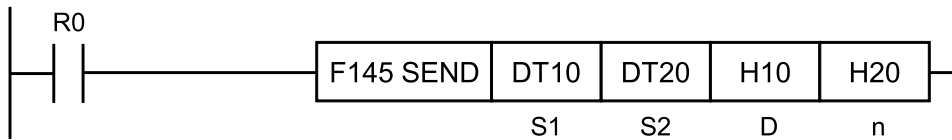

For Type with Ethernet Function



- When using both the serial communication and Ethernet communication within a program, specify the serial communication port using the F469 (UNITSEL) instruction before executing the F145 (SEND) instruction.

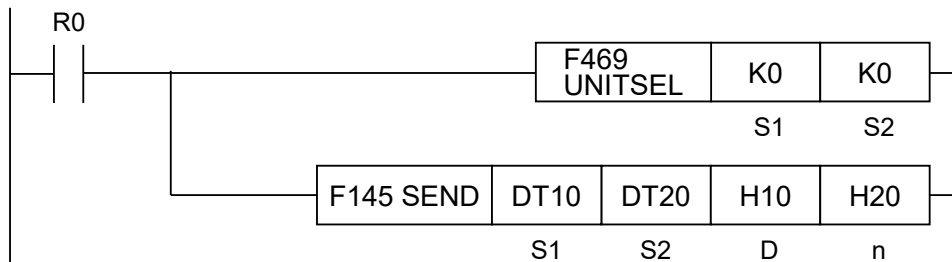

■ Operands

Items	Settings	
S1	Specify the COM port No. of a master unit, send MODBUS command, and the unit number of a destination unit.	
S2	Specification of a master unit	Operation memory area that stores data to be sent.
D	Specification of a destination unit	MODBUS address specification (specification range: H0 to HFFFF)
n	Specification of a destination unit	Specify the number of sent data. Specification range: 1 to 127 words (word specification), 1 to 2040 bits (bit specification)

■ Devices that can be specified (indicated by ●)

Operands	WX	WY	WR	WL	SV	EV	DT	LD	In	SW R	SDT	Constant		Index modifier (Note 1)
												K	H	
S1	●	●	●	●	●	●	●	●		●	●	●	●	●
S2	●	●	●	●	●	●	●	●		●	●			●

21.4 F145 SEND [MODBUS Master Send: Function Code Specification (Serial Communication)]

Operands	WX	WY	WR	WL	SV	EV	DT	LD	In	SW R	SDT	Constant		Index modifier (Note 1)
												K	H	
D		•	•	•	•	•	•	•				•	•	
n		•	•	•	•	•	•	•				•	•	•

(Note 1) A character constant cannot be specified.

■ Specification of [S1]

In [S1], specify the combination of the COM port No. of a master unit, MODBUS function code and the unit number of a destination unit. When the COM port No. is 0, specify HF for the highest digit.

Example: In the case of COM port 1, MODBUS function code 6, and destination unit No. 10, specify H160A.

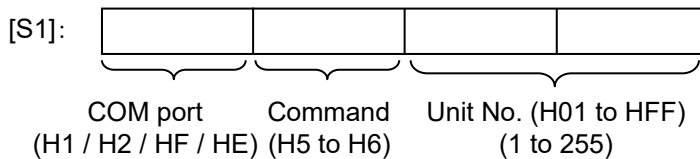

COM port selection (upper four bits)	H1	H2	HF	HE
Port number	COM1	COM2	COM0	Port number specified for the F469 (UNITSEL) instruction

■ Specification of [S2], [n]

Depending on the operation memory type specified in operand [S2] and the number of send data specified in operand [n], the transfer method and the function code of MODBUS command to be sent vary.

For the number of send data [n], specify the number of words in the case of register transfer, and specify the number of bits in the case of bit transfer.

Type of device specified in [S2]	Transfer method	Number of send data [n]	MODBUS command to be sent
16-Bit device: WX, WY, WR, WL, DT, LD	Register transmission	1	Preset single register (06)
		2 to 127	HF: Force multiple coils (15) H10: Preset multiple registers (16)
1-Bit device: X, Y, R, L	Bit transmission	1	H5: Force single coil (05)
		2 to 2040	HF: Force multiple coils (15):

■ Specification of a destination unit [D]

When "0" is specified for the destination unit number, global transfer is applied.

In this process, there is no response message from a destination unit.

21.4 F145 SEND [MODBUS Master Send: Function Code Specification (Serial Communication)]

■ Specifying a COM port number for the F469 (UNITSEL) instruction (only for the type with Ethernet Function)

Specifying HE in the upper four bits of [S1] of F145 (SEND) enables operand [S2] for the F469 (UNITSEL) instruction. The following figure shows that the F469 (UNITSEL) instruction specifies S1=K0 (serial communication port) and S2=K1 (COM1).

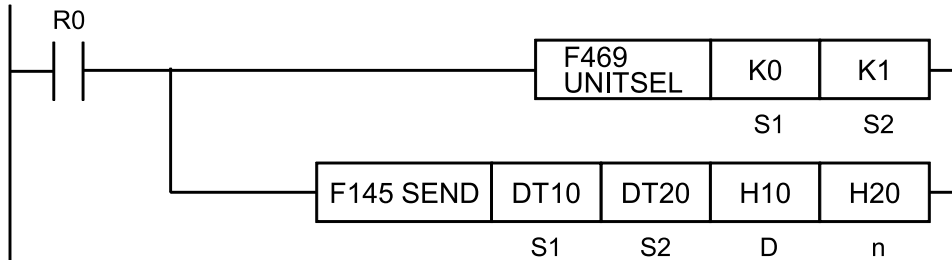

[S2] of F469 (UNITSEL)	K0	K1	K2
Port number	COM0	COM1	COM2

■ MODBUS command specification example

Command 05 (force single coil)

- Example 1) Transfer from COM1 of the value in 0th bit of WR3 to bit in bit address H7788 of unit number 7

[F145(SEND), H1507, WR3, H7788, K1]

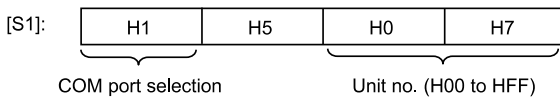

[S1]: H1507

[S2]: WR3 (WR3=0007H)

[D]: H7788

[n]: K1

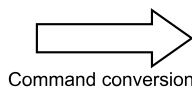

MODBUS command	
1	Slave address 07
2	Command (05H) 05
3	Coil number (H) 77
4	Coil number (L) 88
5	Set state (H) FF
6	Set state (L) 00
7	CRC16(H) 17
8	CRC16(L) C2

(Note 1) Depending on whether WR3 0th bit is ON or OFF, sets settings status.
Set ON=FF00, set OFF=0000

Command 06 (preset single register)

- Example 2: Transfer from COM1 of 1 word of data in WR3 to address H7788 of unit number 7

[F145(SEND), H1607, WR3, H7788, K1]

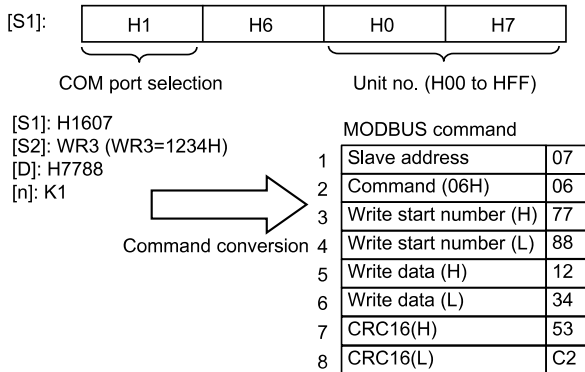

(Note 1) Reads WR3 word data and sets it as write data.

Command 15 (force multiple coils)

- Example 3) Transfer from COM1 of 64 bits of data from WR3 0th bit to WR6 Fth bit to bit address H7788 of unit number 7

[F145(SEND), H1507, WR3, H7788, K64]

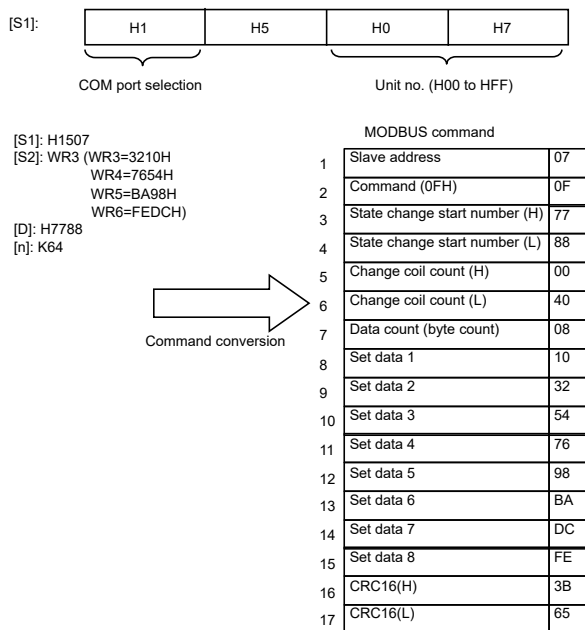

(Note 1) If multiple points are specified for n, the command will be corrected automatically.

H5 bit single write => H15 bit multiple point write status change start number is H7788 (destination unit)

Change coil number will change write bit number to HEX. Change coil number maximum is 2040 (07F8H) (due to MODBUS protocol limits)

Data number (byte number) is calculated as 1 data (1 byte) for 8 coils. [Max 255 (FFH) bytes]

21.4 F145 SEND [MODBUS Master Send: Function Code Specification (Serial Communication)]

Command 16 (preset multiple registers)

- Example 4) Transfer from COM1 of 3 words of data from DT3 to DT5 to address H7788 in unit number 7

[F145(SEND), H1607, DT3, H7788, K3]

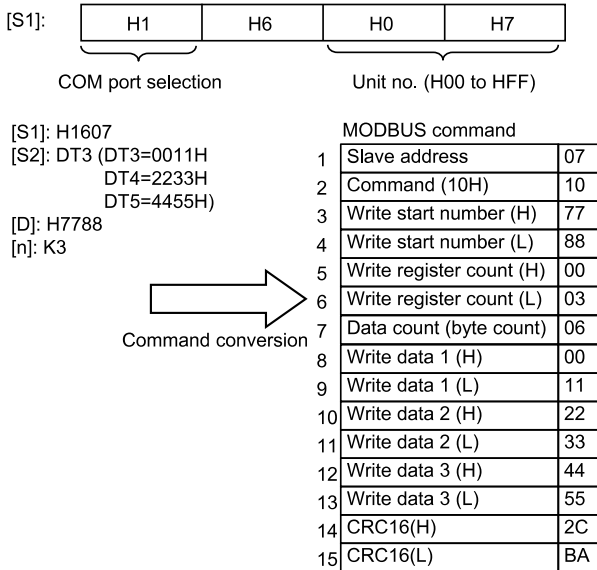

(Note 1) If multiple points are specified for n, the command will be corrected automatically.

(Note 2) Write resistor number maximum is 127 (7FH) (due to MODBUS protocol limits)

Data number (byte number) is calculated as 2 bytes for write resistor number. [Max 254 (FEH) bytes]

■ Flag operations

Name	Description
R9007 R9008 (ER)	Turns ON when the [S1] control data value is outside the specified range.
	Turns ON when the COM port specification of control data specified in [S1] is not MODBUS mode.
	Turns ON when the number of send data [n] is 0.
	Turns ON when the number of send data is negative.
	Turns ON when the number of send data [n] exceeds the operation memory area specified in [S2].
	Turns ON when the number of send data [n] exceeds limitation in MODBUS specification.

21.5 F146 RECV [MODBUS Master Receiver: Function Code Specification (Serial Communication)]

■ Instruction format

For Type without Ethernet Function

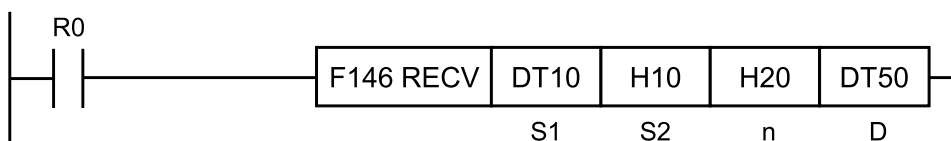

For Type with Ethernet Function



- When using both the serial communication and Ethernet communication within a program, specify the serial communication port using the F469 (UNITSEL) instruction before executing the F146 (RECV) instruction.

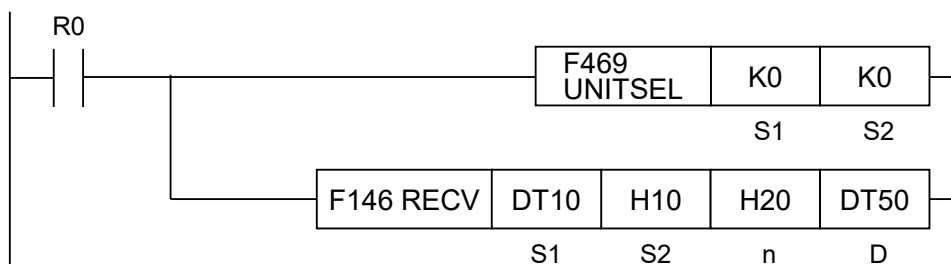

■ Operands

Items	Settings	
S1	Specify the COM port No. of a master unit, transmission MODBUS command, and the unit number of a destination unit.	
S2	Specification of a destination unit	MODBUS address specification (specification range: H0 to HFFFF)
n	Specification of a destination unit	Specify the number of receive data. Resistor transfer specifies the number of words. (Specification range: 1 to 127 words) Specify bit number when transferring bits. (Specification range: 1 to 2040 bits)
D	Specification of a master unit	Operation memory area that stores receive data

■ Devices that can be specified (indicated by ●)

Operands	WX	WY	WR	WL	SV	EV	DT	LD	In	SW R	SDT	Constant		Index modifier (Note 1)
												K	H	
S1	●	●	●	●	●	●	●	●		●	●	●	●	●

21.5 F146 RECV [MODBUS Master Receiver: Function Code Specification (Serial Communication)]

Operands	WX	WY	WR	WL	SV	EV	DT	LD	In	SW R	SDT	Constant		Index modifier (Note 1)
												K	H	
S2	•	•	•	•			•	•				•	•	
n		•	•	•	•	•	•	•				•	•	•
D		•	•	•	•	•	•	•						•

(Note 1) A character constant cannot be specified.

■ Specification of [S1]

In [S1], specify the combination of the COM port No. of a master unit, MODBUS function code and the unit number of a destination unit. When the COM port No. is 0, specify HF for the highest digit.

Example: In the case of COM port No. 1, MODBUS function code 3, and destination unit No.10, specify H130A.

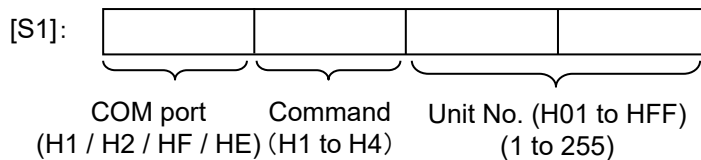

COM port selection (upper four bits)	H1	H2	HF	HE
Port number	COM1	COM2	COM0	Port number specified for the F469 (UNITSEL) instruction

■ Specification of [D]

Depending on the operation memory type specified in operand [D], and the number of receive data specified in operand [n], the transfer method and the function code of MODBUS command vary.

Device specified in [D]	Transfer method	MODBUS command to be sent
16-Bit device: WX, WY, WR, WL, DT, LD	Register transmission	H1: Read coil state (01) H2: Read input state (02) H3: Read hold register (03) H4: Read input register (04)
1-Bit device: X, Y, R, L	Bit transmission	H1: Read coil state (01) H2: Read input state (02)

■ Specifying a COM port number for the F469 (UNITSEL) instruction (only for the type with Ethernet Function)

Specifying HE in the upper four bits of [S1] of F146 (RECV) enables operand [S2] for the F469 (UNITSEL) instruction. The following figure shows that the F469 (UNITSEL) instruction specifies S1=K0 (serial communication port) and S2=K1 (COM1).

21.5 F146 RECV [MODBUS Master Receiver: Function Code Specification (Serial Communication)]

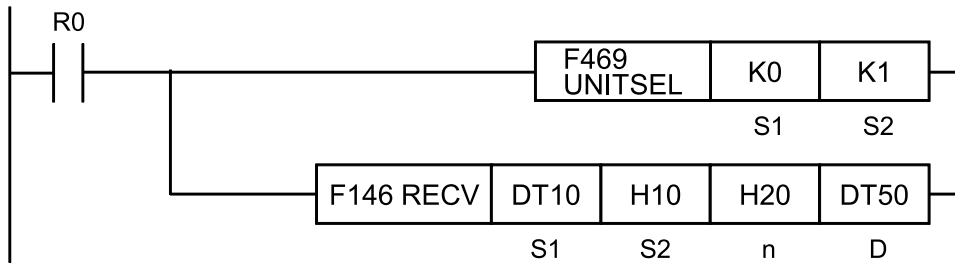

[S2] of F469 (UNITSEL)	K0	K1	K2
Port number	COM0	COM1	COM2

■ MODBUS command specification example

Command 01 (read coil state)

- Example 1) Reading 1 bit from unit number 17 bit address H7788 connected to COM1, and writing to master unit DT100 bit 0

[F146(RECV), H1111, H7788, K1, DT100]

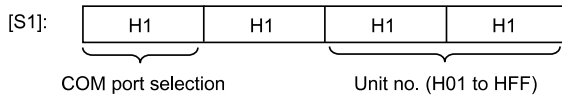

[S1]: H1111
[S2]: H7788
[n]: K1
[D]: DT100

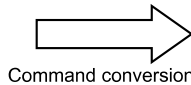

Command conversion

MODBUS command	
1	Slave address 11
2	Command (01H) 01
3	Read start number (H) 77
4	Read start number (L) 88
5	Read count (H) 00
6	Read count (L) 01
7	CRC16(H) 64
8	CRC16(L) C4

- Example 2) Reading 64 bits (4 words) from unit number 17 bit address H7788 connected to COM1, and writing to master unit DT100 starting at bit 0

[F146(RECV), H1111, H7788, K64, DT100]

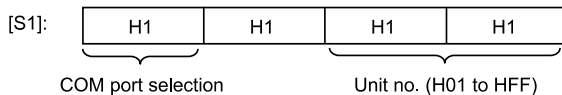

[S1]: H1111
[S2]: H7788
[n]: K64
[D]: DT100

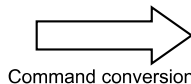

Command conversion

MODBUS command	
1	Slave address 11
2	Command (01H) 01
3	Read start number (H) 77
4	Read start number (L) 88
5	Read count (H) 00
6	Read count (L) 40
7	CRC16(H) A4
8	CRC16(L) F4

21.5 F146 RECV [MODBUS Master Receiver: Function Code Specification (Serial Communication)]

Command 02 (read input state)

- Example 3) Reading 1 bit from unit number 17 bit address H7788 connected to COM1, and writing to master unit DT100 bit 0

[F146(RECV), H1211, H7788, K1, DT100]

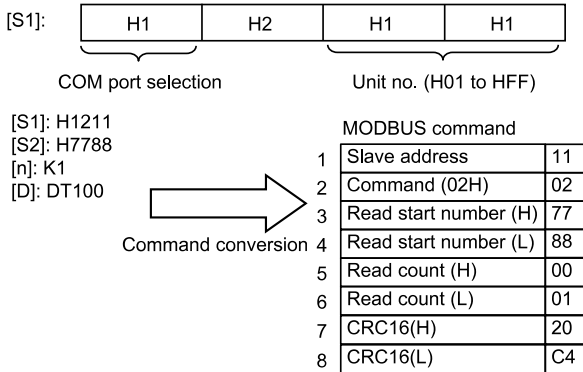

- Example 4) Reading 64 bits (4 words) from unit number 17 bit address H7788 connected to COM1, and writing to master unit DT100 starting at bit 0

[F146(RECV), H1211, H7788, K64, DT100]

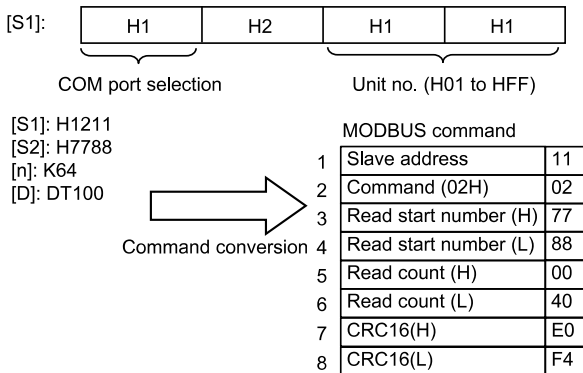

Command 03 (read hold register)

- Example 5) Reading 6 words from unit number 17 address H7788 connected to COM1, and writing to master unit starting at DT100

[F146(RECV), H1311, H7788, K6, DT100]

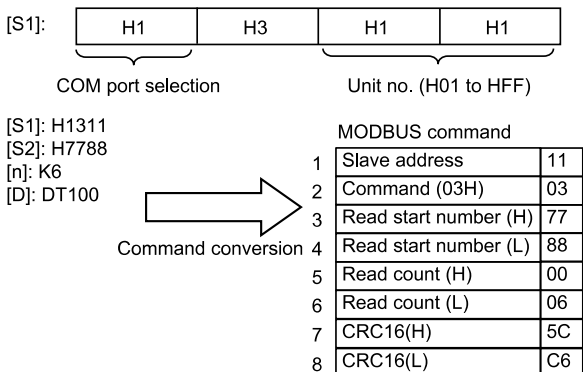

21.5 F146 RECV [MODBUS Master Receiver: Function Code Specification (Serial Communication)]

Command 04 (read input register)

- Example 6) Reading 6 words from unit number 17 address H7788 connected to COM1, and writing to master unit starting at DT100

[F146(RECV), H1411, H7788, K6, DT100]

[S1]: H1411
 [S2]: H7788
 [n]: K6
 [D]: DT100

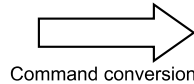

Command conversion

MODBUS command	
1	Slave address 11
2	Command (04H) 04
3	Read start number (H) 77
4	Read start number (L) 88
5	Read count (H) 00
6	Read count (L) 06
7	CRC16(H) E9
8	CRC16(L) 06

■ Flag Operands

Name	Description
R9007 R9008 (ER)	Turns ON when the [S1] control data value is outside the specified range.
	Turns ON when the COM port specification of control data specified in [S1] is not MODBUS mode.
	Turns ON when the number of receive data [n] is 0
	Turns ON when the number of receive data is negative
	Turns ON when the number of receive data [n] exceeds MODBUS specification
	Turns ON when the operation memory area specified in [D] is exceeded if the number of receive data [n] is received.

21.6 F145 SEND [MODBUS Master Send: No Function Code Specification (Serial Communication)]

21.6 F145 SEND [MODBUS Master Send: No Function Code Specification (Serial Communication)]

■ Instruction format

For Type without Ethernet Function

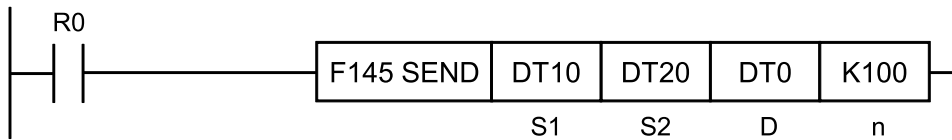

For Type with Ethernet Function



- When using both the serial communication and Ethernet communication within a program, specify the serial communication port using the F469 (UNITSEL) instruction before executing the F145 (SEND) instruction.

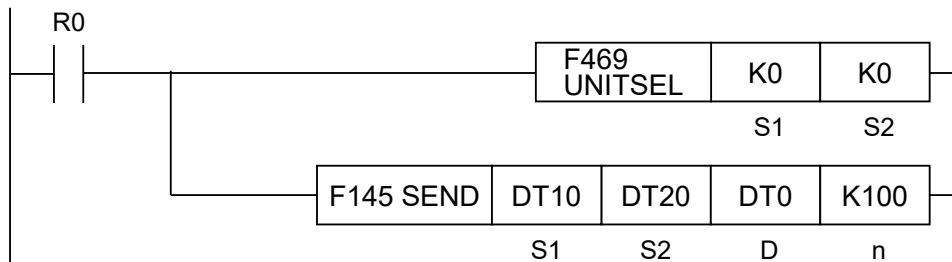

■ Operands

Operands	Settings	
S1	Specify the starting number of the area (2 words) that stores control data.	
	S1	Specify the transfer method. Word transfer: Specify the number of send words. Bit transfer: Specify the bit number of a master unit and that of a destination unit.
	S1+1	Specify the COM port No of a master unit and the unit number of a destination unit.
S2	Specification of a master unit	Specify the area of a master unit that stores send data.
D	Specification of a destination unit	Specify the area type of a destination unit that stores send data. The number is specified at 0.
n	Specification of a destination unit	Specify the starting address of a destination unit that stores send data.

21.6 F145 SEND [MODBUS Master Send: No Function Code Specification (Serial Communication)]

■ Devices that can be specified (indicated by ●)

Operands	WX	WY	WR	WL	SV	EV	DT	LD	In	SW R	SDT	Constant		Index modifier (Note 1)
												K	H	
S1	●	●	●	●	●	●	●	●		●	●			●
S2	●	●	●	●	●	●	●	●		●	●			●
D		●	●				●							
N		●	●	●	●	●	●	●				●	●	●

(Note 1) A character constant cannot be specified.

■ Specifying control data [S1], [S1+1]

Specification of [S1]

Specification of [S1+1]

For [S1+1], specify the COM port number of a master unit and the unit number of a destination unit.

When "0" is specified for the destination unit number, global transfer is applied. In this process, there is no response message from a destination unit.

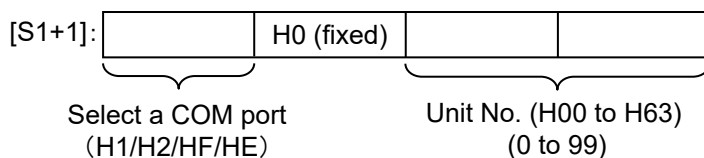

COM port selection (upper four bits)	H1	H2	HF	HE
Port number	COM1	COM2	COM0	Port number specified for the F469 (UNITSEL) instruction

■ MODBUS command specification

Depending on the transfer method specified for operand [S1] and the device type specified for operand [S2], the function code of MODBUS command to be sent varies.

Type of device specified in [S2]	Transfer method specified in [S1]	MODBUS function code to be sent
16-Bit device: WX, WY, WR, WL, DT, LD	Register transmission	Force multiple coils (15) Preset multiple registers (16)
1-Bit device: X, Y, R, L	Bit transmission	Force multiple coils (15)

■ Specifying destination unit area [D], [n]

The area of the destination unit is specified by the combination of operands [D] and [n].

- When [D] = DT0 and [n] = K100, the memory area of the destination unit starts with DT100.

21.6 F145 SEND [MODBUS Master Send: No Function Code Specification (Serial Communication)]

If the firmware of the main unit is earlier than Ver. 1.20, an operation error occurs when [n] is H8000 or higher. If the firmware of the main unit is Ver. 1.20 or later, the following specifications can be used.

- When [D] = DT0 and [n] = HFFF0, the memory area of the destination unit starts with DT65520.

■ Specifying a COM port number for the F469 (UNITSEL) instruction (only for the type with Ethernet Function)

Specifying HE in the upper four bits of [S1+1] of F145 (SEND) enables operand [S2] for the F469 (UNITSEL) instruction. The following figure shows that the F469 (UNITSEL) instruction specifies S1=K0 (serial communication port) and S2=K1 (COM1).

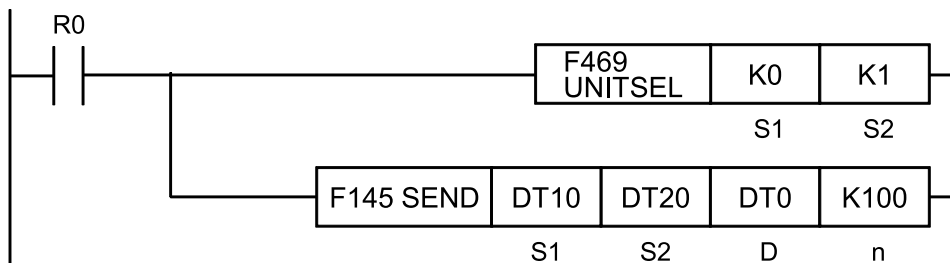

[S2] of F469 (UNITSEL)	K0	K1	K2
Port number	COM0	COM1	COM2

i Info.

- This is convenient to write data into Panasonic's PLC via MODBUS RTU.
- For MODBUS reference Nos. and device Nos., see "[Device No. Correspondence Table](#)".

■ MODBUS command specification example

Sending command 05 (single Y/R write)

- Example 1) Transfer from COM1 of the value in 0th bit of WR3 to 1st bit of WY1 in destination unit number 7

[F145(SEND), DT10, WR3, WY0, K1]

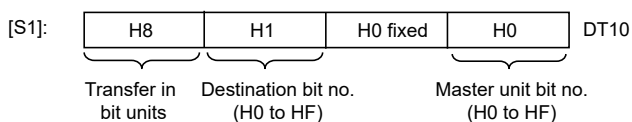

21.6 F145 SEND [MODBUS Master Send: No Function Code Specification (Serial Communication)]

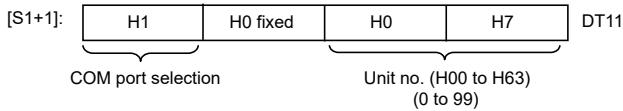

[S1]: DT10 (DT10=8100H, DT11=1007H)
 [S2]: WR3 (WR3=0007H)
 [D]: WY0
 [n]: K1

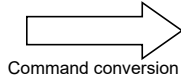

MODBUS command		
1	Slave address	07
2	Command (05H)	05
3	Coil number (H)	00
4	Coil number (L)	11
5	Set state (H)	FF
6	Set state (L)	00
7	CRC16(H)	DC
8	CRC16(L)	59

(Note 1) When sending command 05, set [S1] transfer method specification to bit units (H8).

(Note 2) Depending on whether WR3 0th bit is ON or OFF, [S1+1] settings status will be set.
 Set ON=FF00, set OFF=0000

(Note 3) The write target coil number is specified as Y11. (destination unit)

Sending command 06 (DT1 word write)

- Example 2) Transfer from COM1 of 1 word of data from WR3 to DT1000 in destination unit number 7

[F145(SEND), DT10, WR3, DT0, K1000]

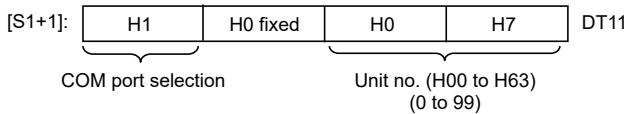
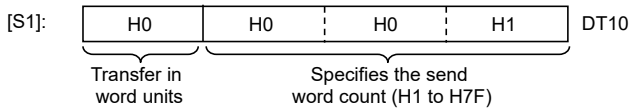

[S1]: DT10 (DT10=0001H, DT11=1007H)
 [S2]: WR3 (WR3=1234H)
 [D]: DT0
 [n]: K1000

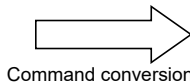

MODBUS command		
1	Slave address	07
2	Command (06H)	06
3	Write start number (H)	03
4	Write start number (L)	E8
5	Write data (H)	12
6	Write data (L)	34
7	CRC16(H)	04
8	CRC16(L)	AB

(Note 1) When sending command 06, set [S1] transfer method specification to word units (H0), and set transfer word number to (H1).

(Note 2) Reads WR3 word data and sets it as write data.

Sending command 15 (multiple point Y/R write)

- Example 3) Transfer from COM1 of 64 bits of data from WR3 0th bit to WR6 Fth bit to Y0–Y3F in destination unit number 7

21.6 F145 SEND [MODBUS Master Send: No Function Code Specification (Serial Communication)]

[F145(SEND), DT10, WR3, WY0, K0]

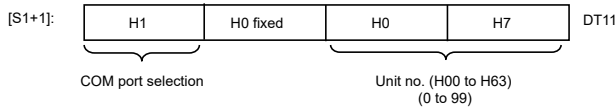
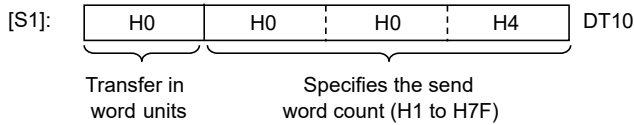

[S1]: DT10 (DT10=0004H, DT11=1007H)

[S2]: WR3 (WR3=3210H
WR4=7654H
WR5=BA98H
WR6=FEDCH)

[D]: WY0
[n]: K0

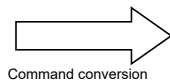

MODBUS command		
1	Slave address	07
2	Command (0FH)	0F
3	State change startnumber (H)	00
4	State change start number (L)	00
5	Change coil count (H)	00
6	Change coil count (L)	40
7	Data count (byte count)	08
8	Set data 1	10
9	Set data 2	32
10	Set data 3	54
11	Set data 4	76
12	Set data 5	98
13	Set data 6	BA
14	Set data 7	DC
15	Set data 8	FE
16	CRC16(H)	6C
17	CRC16(L)	B3

- (Note 1) When sending command 15, set [S1] transfer method specification to word units (H0).
- (Note 2) Status change start number will be set to write target coil number. (destination unit)
- (Note 3) Change coil number will change write bit number to HEX.
- (Note 4) Due to MODBUS protocol limits, change coil number maximum is 2032 (07F0H).

Data number (byte number) is calculated as 1 data (1 byte) for 8 coils. [Max 254 (FEH) bytes]

Sending command 16 (DT multiple word write)

- Example 4) Transfer from COM1 of 3 words of data from WR3 to WR5 to DT500–DT502 in destination unit number 7

[F145(SEND), DT10, WR3, DT0, K500]

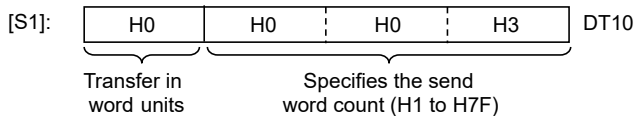

21.6 F145 SEND [MODBUS Master Send: No Function Code Specification (Serial Communication)]

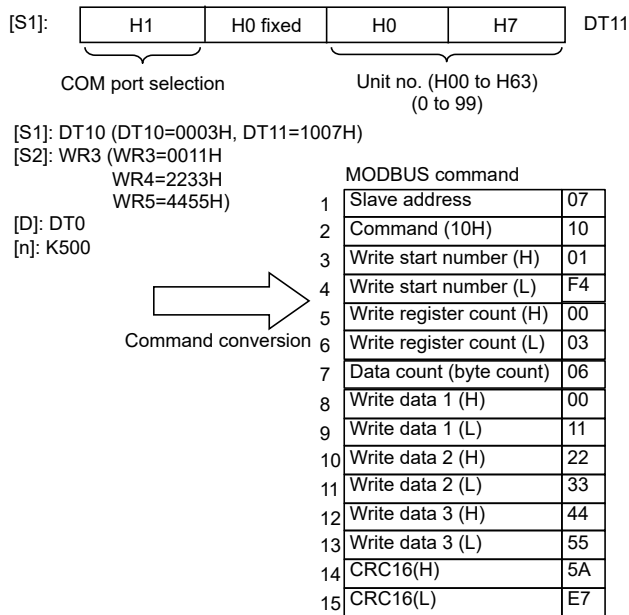

(Note 1) When sending command 16 set [S1] transfer method specification to word units (H0).

(Note 2) Due to MODBUS protocol limits, write resistor number maximum is 127 (7FH).

(Note 3) Data number (byte number) is calculated as 2 bytes for write resistor number. [Max 254 (FEH) bytes]

■ Flag operations

Name	Description
R9007 R9008 (ER)	Turns ON when the [S1] / [S1+1] control data value is outside the specified range.
	Turns ON when the [S2] or [D] area is exceeded, if the number of words specified in [S1] is taken during transfer in word units.
	Turns ON when [D]+[n] exceeds the [D] area
	Turns ON when the COM port specification of control data specified in [S1+1] is not MODBUS mode.
	Turns ON when the [D] area is DT during transfer in bit units.
	Turns ON when the [D] device number is not 0.

21.7 F146 RECV [MODBUS Master Receiver: No Function Code Specification (Serial Communication)]

21.7 F146 RECV [MODBUS Master Receiver: No Function Code Specification (Serial Communication)]

■ **Instruction format**

For Type without Ethernet Function

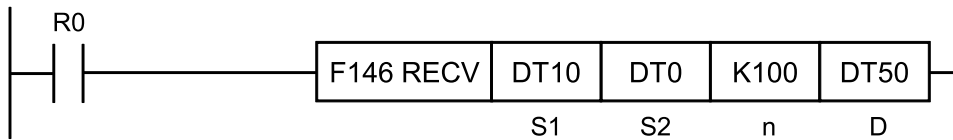

For Type with Ethernet Function

! When using both the serial communication and Ethernet communication within a program, specify the serial communication port using the F469 (UNITSEL) instruction before executing the F146 (RECV) instruction.

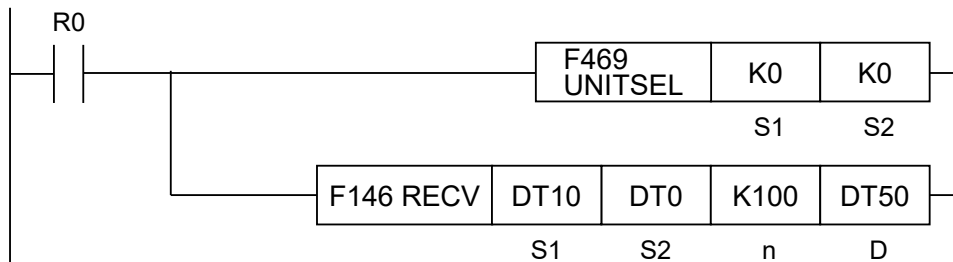

■ **Operands**

Operands	Settings	
S1	Specify the starting number of the area (2 words) that stores control data.	
	S1	Specify the transfer method. Word transfer: Specify the number of send words. Bit transfer: Specify the bit number of a master unit and that of a destination unit.
	S1+1	Specify the COM port No. of a master unit and the unit number of a destination unit.
S2	Specification of a destination unit	Specify the source data area of a destination unit. (Device No. is fixed to "0")
n	Specification of a destination unit	Specify the starting address of the device in the source data area of a destination unit.
D	Specification of a master unit	Specify the device starting address of the receive data storage area in the master unit.

21.7 F146 RECV [MODBUS Master Receiver: No Function Code Specification (Serial Communication)]

■ Devices that can be specified (indicated by ●)

Operands	WX	WY	WR	WL	SV	EV	DT	LD	In	SW R	SDT	Constant		Index modifier (Note 1)
												K	H	
S1	●	●	●	●	●	●	●	●		●	●			●
S2	●	●	●	●			●	●						
n		●	●	●	●	●	●	●				●	●	●
D		●	●	●	●	●	●	●						●

(Note 1) A character constant cannot be specified.

■ Specifying control data [S1]

Specification of [S1]

To [S1], the following specification should be applied. The specification method differs depending on word transfer and bit transfer.

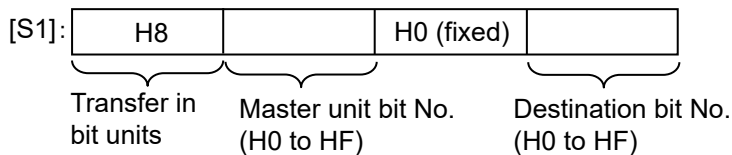
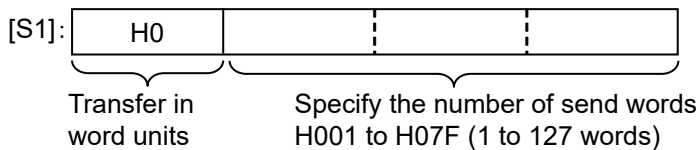

Specification of [S1+1]

To [S1+1], the following specification should be applied.



COM port selection (upper 4 bits)	H1	H2	HF	HE
Port number	COM1	COM2	COM0	Port number specified for the F469 (UNITSEL) instruction

■ Selecting MODBUS function code

Depending on the transfer method specified for operand [S1] and the device type specified for operand [D], the function code of MODBUS command to be sent varies.

21.7 F146 RECV [MODBUS Master Receiver: No Function Code Specification (Serial Communication)]

Device type specified for [D]	Transfer method specified for [S1]	MODBUS function code to be sent
16-Bit device: WX, WY, WR, WL, DT, LD	Register transmission	H1: Read coil state (01) H2: Read input state (02) H3: Read hold register (03) H4: Read input register (04)
1-Bit device: X, Y, R, L	Bit transmission	H1: Read coil state (01) H2: Read input state (02)

■ Specifying destination unit area [S2], [n]

The area of the destination unit is specified by the combination of operands [S2] and [n].

- When [S2] = DT0 and [n] = K100, the memory area of the destination unit starts with DT100. If the firmware of the main unit is earlier than Ver. 1.20, an operation error occurs when [n] is H8000 or higher. If the firmware of the main unit is Ver. 1.20 or later, the following specifications can be used.
- When [S2] = DT0 and [n] = HFFF0, the memory area of the destination unit starts with DT65520.

■ Specifying a COM port number for the F469 (UNITSEL) instruction (only for the type with Ethernet Function)

Specifying HE in the upper four bits of [S1+1] of the F146 (RECV) enables operand [S2] for the F469 (UNITSEL) instruction. The following figure shows that the F469 (UNITSEL) instruction specifies S1=K0 (serial communication port) and S2=K1 (COM1).

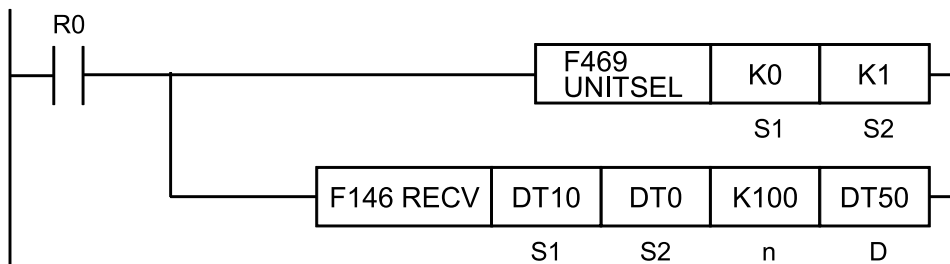

[S2] of F469 (UNITSEL)	K0	K1	K2
Port number	COM0	COM1	COM2

i Info.

- This is convenient to read data from Panasonic PLC via MODBUS-RTU.
- For MODBUS reference Nos. and device Nos., see "[Device No. Correspondence Table](#)".

■ MODBUS command specification example

Sending command 01 (Y/R coil read)

- Example 1) Sending command from COM1 to read 1 bit (Y17) of destination unit number 17 and to transfer read bit data to 5th bit of master unit DT100

21.7 F146 RECV [MODBUS Master Receiver: No Function Code Specification (Serial Communication)]

[F146(RECV), DT10, WY0, K1, DT100]

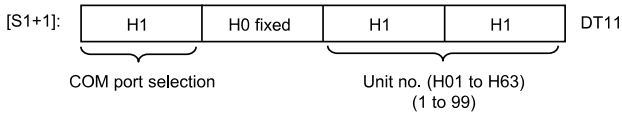
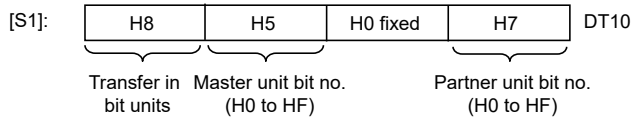

[S1]: DT10 (DT10=8507H, DT11=1011H)
[S2]: WY0
[n]: K1
[D]: DT100

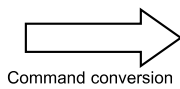

Command conversion

MODBUS command		
1	Slave address	11
2	Command (01H)	01
3	Read start number (H)	00
4	Read start number (L)	17
5	Read count (H)	00
6	Read count (L)	01
7	CRC16(H)	DC
8	CRC16(L)	59

- (Note 1) When reading only 1 bit with command 01, set [S1] transfer method specification to bit units (H8).
(Note 2) The read start number specifies the read location coil number. (Destination unit: Y17)
(Note 3) The read number will be 1.

- Example 2) Sending command from COM1 to read 64 bits (4 words) (Y10–Y4F) from destination unit number 17 and to transfer read bit data to master unit starting at DT100

[F146(RECV), DT10, WY0, K1, DT100]

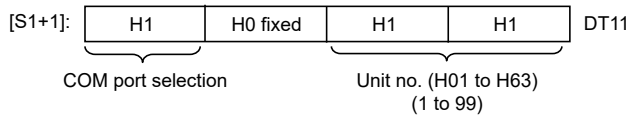
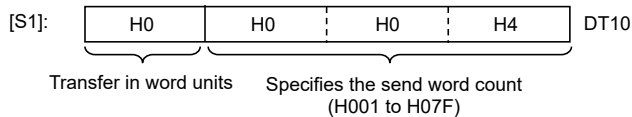

[S1]: DT10 (DT10=0004H, DT11=1011H)
[S2]: WY0
[n]: K1
[D]: DT100

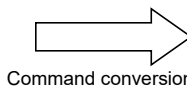

Command conversion

MODBUS command		
1	Slave address	11
2	Command (01H)	01
3	Read start number (H)	00
4	Read start number (L)	10
5	Read count (H)	00
6	Read count (L)	40
7	CRC16(H)	3E
8	CRC16(L)	AF

- (Note 1) When reading word units with command 01, set [S1] transfer method specification to bit units (H0).
(Note 2) The read start number specifies the read location coil number. (Destination unit: Y10)
(Note 3) The read number will be the specified number of words × 16. (64-bit reading)

21.7 F146 RECV [MODBUS Master Receiver: No Function Code Specification (Serial Communication)]

Sending command 02 (X contact reading)

- Example 3) Sending command from COM1 to read 1 bit (X17) from destination unit number 17 and to transfer read bit data to 5th bit of master unit DT100

[F146(RECV), DT10, WX0, K1, DT100]

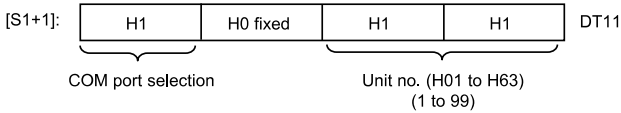
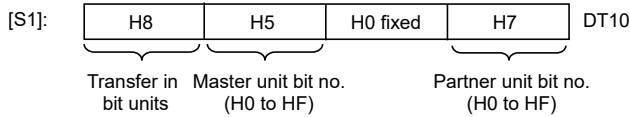

[S1]: DT10 (DT10=8507H, DT11=1011H)
 [S2]: WX0
 [n]: K1
 [D]: DT100

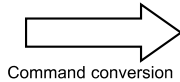

MODBUS command		
1	Slave address	11
2	Command (02H)	02
3	Read start number (H)	00
4	Read start number (L)	17
5	Read count (H)	00
6	Read count (L)	01
7	CRC16(H)	0B
8	CRC16(L)	5E

- (Note 1) When reading only 1 bit with command 02, set [S1] transfer method specification to bit units (H8).
- (Note 2) The read start number specifies the read location coil number. (Destination unit: X17)
- (Note 3) The read number will be 1.

- Example 4) Sending command from COM1 to read 64 bits (4 words) (X10–X4F) from destination unit number 17 and to transfer read bit data to master unit starting at DT100

[F146(RECV), DT10, WX0, K1, DT100]

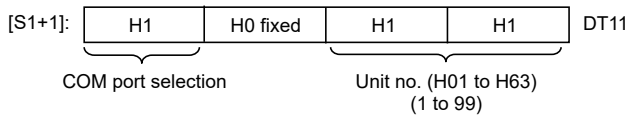
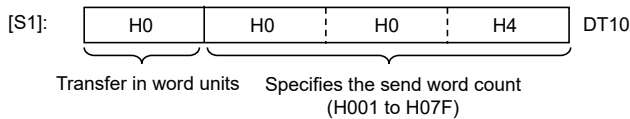

[S1]: DT10 (DT10=0004H, DT11=1011H)
 [S2]: WX0
 [n]: K1
 [D]: DT100

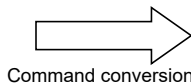

MODBUS command		
1	Slave address	11
2	Command (02H)	02
3	Read start number (H)	00
4	Read start number (L)	10
5	Read count (H)	00
6	Read count (L)	40
7	CRC16(H)	7A
8	CRC16(L)	A0

21.7 F146 RECV [MODBUS Master Receiver: No Function Code Specification (Serial Communication)]

(Note 1) When reading word units with command 02, set [S1] transfer method specification to bit units (H0).

(Note 2) The read start number specifies the read location coil number. (Destination unit: X10)

(Note 3) The read number will be the specified number of words × 16. (64-bit reading)

Sending command 03 (DT read)

- Example 5) Sending command from COM1 to read 6 words (DT500–DT505) from destination unit number 17 and to transfer read bit data to master unit starting at DT100

[F146(RECV), DT10, DT0, K500, DT100]

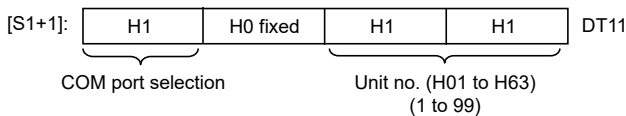
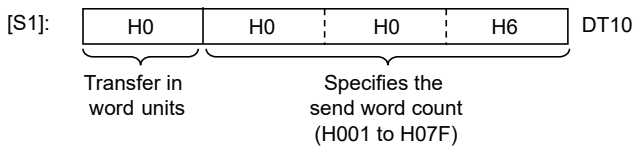

[S1]: DT10 (DT10=0006H, DT11=1011H)

[S2]: DT0

[n]: K500

[D]: DT100

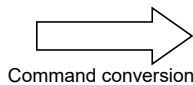

Command conversion

MODBUS command		
1	Slave address	11
2	Command (03H)	03
3	Read start number (H)	01
4	Read start number (L)	F4
5	Read count (H)	00
6	Read count (L)	06
7	CRC16(H)	87
8	CRC16(L)	56

(Note 1) When reading word units with command 03 set [S1] transfer method specification to word units (H0).

(Note 2) The read start number specifies the read location data number. (Destination unit: DT500)

(Note 3) The read number will be the specified number of words. (6-word reading)

Sending command 04 (WL/LD read)

- Example 6) Sending command from COM1 to read 6 words (WL20–WL25) from destination unit number 17 and to transfer read bit data to master unit starting at DT100

[F146(RECV), DT10, WL0, K20, DT100]

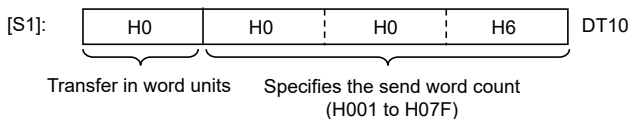

21.7 F146 RECV [MODBUS Master Receiver: No Function Code Specification (Serial Communication)]

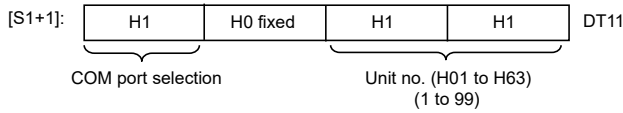

[S1]: DT10 (DT10=0006H, DT11=1011H)
 [S2]: WL0
 [n]: K20
 [D]: DT100

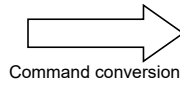

MODBUS command	
1	Slave address 11
2	Command (04H) 04
3	Read start number (H) 00
4	Read start number (L) 14
5	Read count (H) 00
6	Read count (L) 06
7	CRC16(H) 32
8	CRC16(L) 9C

(Note 1) When reading word units with command 04 set [S1] transfer method specification to word units (H0).

(Note 2) The read start number specifies the read location data number. (Destination unit: WL20)

(Note 3) The read number will be the specified number of words. (6-word reading)

- Example 7) Sending command from COM1 to read 6 words (LD100–LD105) from destination unit number 17 and to transfer read bit data to master unit starting at DT100

[F146(RECV), DT10, LD0, K100, DT100]

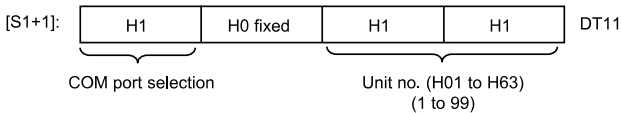
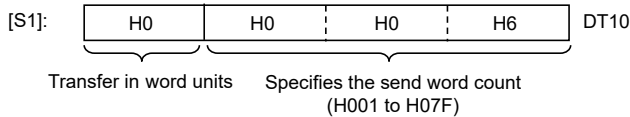

[S1]: DT10 (DT10=0006H, DT11=1011H)
 [S2]: LD0
 [n]: K100
 [D]: DT100

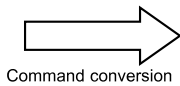

MODBUS command	
1	Slave address 11
2	Command (04H) 04
3	Read start number (H) 08
4	Read start number (L) 34
5	Read count (H) 00
6	Read count (L) 06
7	CRC16(H) 31
8	CRC16(L) 36

(Note 1) When reading word units with command 04 set [S1] transfer method specification to word units (H0).

(Note 2) The read start number specifies the read location data number. (Destination unit: LD100)

(Note 3) The read number will be the specified number of words. (6-word reading)

(Note 4) If LD is specified, it is 07D0H(LD0) onward.

■ Flag operations

Name	Description
R9007 R9008 (ER)	Turns ON when the [S1] / [S1+1] control data value is outside the specified range.
	Turns ON when the [S2] or [D] area is exceeded, if the number of words specified in [S1] is taken during transfer in word units.
	Turns ON when [S2]+[n] exceeds the [S2] area.
	Turns ON when the COM port specification of control data specified in [S1+1] is not MODBUS mode.
	Turns ON when the [S2] area is DT / WL / LD, during transfer in bit units.
	Turns ON when the [S2] device number is not 0.

21.8 F159 MTRN [General-purpose Communication Instructions (Serial Communication)]

■ **Instruction format**

For Type without Ethernet Function

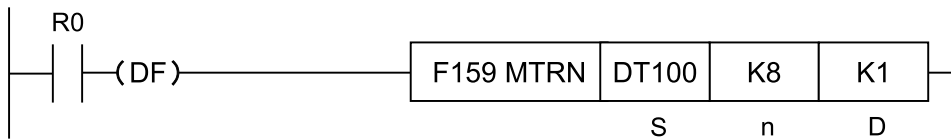

For Type with Ethernet Function

! • When using both the serial communication and Ethernet communication within a program, specify the serial communication port using the F469 (UNITSEL) instruction before executing the F159 (MTRN) instruction.

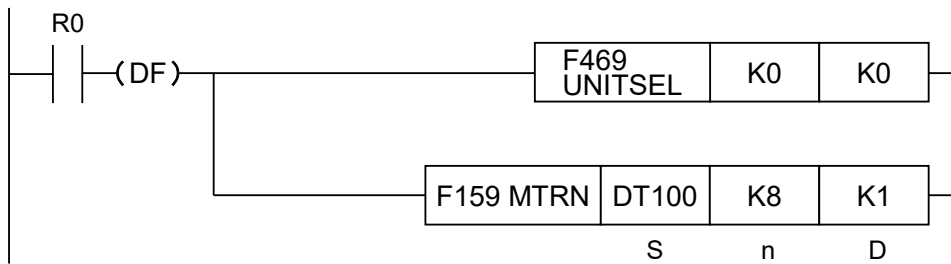

■ **Operands**

Items	Settings
S	Starting area (data register) of the data table
n	Area storing the number of bytes of data to be sent, or constant data <ul style="list-style-type: none"> • Add the terminator (end code) during transmission when the value is positive. • Do not add the terminator (end code) during transmission when the value is negative. • In the case of H8000, the purpose of COM port is switched.
D	COM port number for sending data (K0/K1/K2/K14)

■ **Devices that can be specified (indicated by ●)**

Operands	WX	WY	WR	WL	SV	EV	DT	LD	I	Constant		Index modifier (Note 1)
										K	H	
S							●					●
n	●	●	●	●	●	●	●	●	●	●	●	●
D										●		●

(Note 1) A character constant cannot be specified.

21.8 F159 MTRN [General-purpose Communication Instructions (Serial Communication)]

■ Outline of operation

Data is sent or received with an external device connected to the COM port. F159 (MTRN) instruction has the following three functions.

Items	Description
Send	In the data register starting with [S], data to be sent to an external device is set as a table in advance. By executing the [F159 MTRN] instruction, data of [n] bytes is sent from the COM port to an external device.
Receive	Data sent to COM port is stored in the receive buffer (data register DT) specified by the system register. Once the reception is done, the “reception done flag” turns on, and disables further reception. When the [F159 MTRN] instruction is executed, the “reception done flag” turns OFF, and enables reception. The F159 (MTRN) instruction is used to turn OFF the reception done flag for general-purpose communication (i.e. to enable reception).
Operation mode switching	Operation mode of COM port can be switched between “general-purpose communication mode” and “computer link mode”.

■ System register settings

- Using the system register, it is required to set to “general-purpose communication mode” in COM port.
- Using the system register, it is required to align the baud rate and transmission format with an external device.
- To secure an area for storing receive data in the data register (DT), it is required to specify “Receive buffer starting number in general-purpose communication” and “Receive buffer capacity in general-purpose communication” using the system register.

■ Related flag /system register No.

	Operation	COM0	COM1	COM2
Communication error flag	0: Normal 1: Error	R9130	R9138	R9140
Operation mode flag	0: Other than general-purpose communication 1: General-purpose communication	R9131	R9139	R9141
Reception done flag	0: Reception enabled 1: Reception disabled (reception done)	R9132	R913A	R9142
Transmission done flag	0: Transmission in progress 1: Transmission done (transmission enabled)	R9133	R913B	R9143
Receive buffer starting number	Specify the DT range to be used as a receive buffer, using the system register.	No.420	No.416	No.418
Receive buffer capacity		No.421	No.417	No.419

■ Specifying COM port number [D1]

Specify the COM port number as shown below.

Port specification with the F469 (UNITSEL) instruction is only applicable to the type with Ethernet Function.

21.8 F159 MTRN [General-purpose Communication Instructions (Serial Communication)]

[D]	K0	K1	K2	K14
Port number	COM0	COM1	COM2	Port number specified for the F469 (UNITSEL) instruction

■ Creation of send data table [S]

- Send data is stored as follows in a given memory area (e.g. data register DT). The number of send data bytes [n] is automatically added to the starting word. Send data should be stored in [S+1] and later.
- Do not include the terminator in the send data. The terminator is added automatically. When no terminator is to be added during transmission, specify a negative value for [n]. Alternatively, select “None” from the terminator setting in the system register.
- When the header (start code) is set to “STX” in system register, do not add the header to send data. The header is added automatically.

Example: When 8-byte data “ABCDEFGH” is sent with [S] as DT100

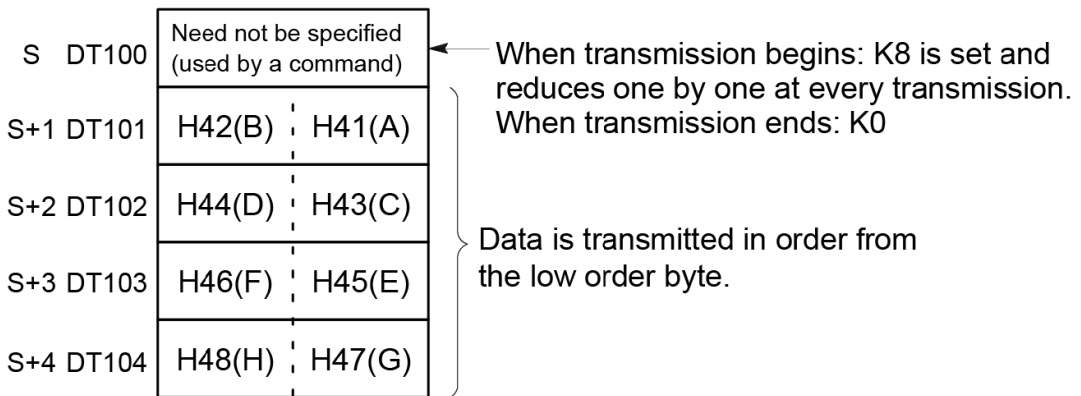

Data table before transmission

■ Precautions during programming

- F159 (MTRN) instruction should be executed after confirming that the transmission done flag for the target COM port has turned ON.
- The maximum data that can be sent in a single session is 2,048 bytes.

■ Structure of receive data

Receive data is stored in the receive buffer (data register DT) specified in the system register. The number of receive data bytes is stored in the starting word.

Example: When 8-byte data “ABCDEFGH” is received

Specify 200 for the “receive buffer starting number”, and 5 for the “receive buffer capacity”, in the system register.

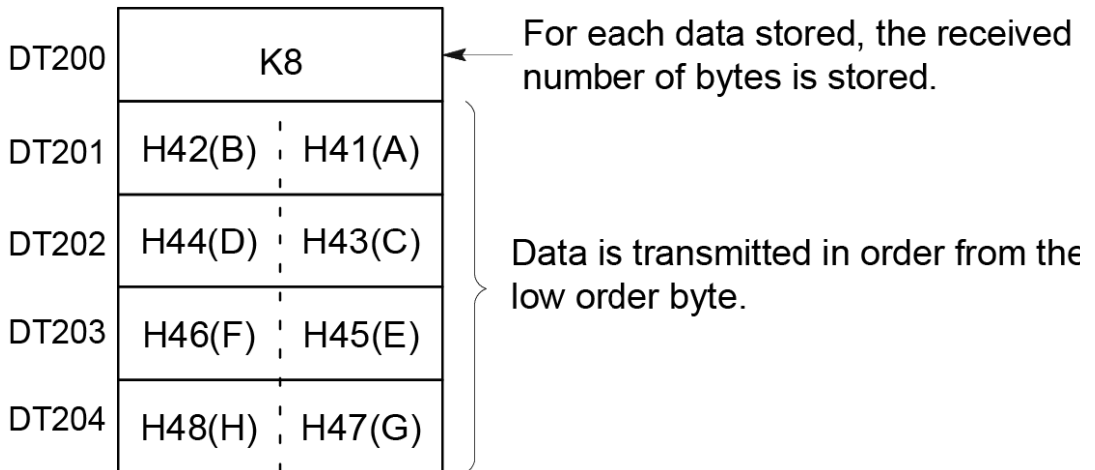

Receive buffer at the time of reception complete

■ Operations when data is received

When the reception done flag is OFF, operation takes place as follows when data is sent from an external device.

	Items	Description
(1)	Storage of receive data	Received data is stored in the receive buffer area (two words) in low byte order. The terminator of the received data is stored in the receive buffer after removing one byte. If the terminator is two bytes, only one byte is stored in the receive buffer. The header is not stored.
(2)	Reception done flag ON	When the terminator (end code) is received, the reception done flag turns ON. Reception of any further data is prohibited.
(3)	Execute F159 (MTRN) instruction	When an F159 (MTRN) instruction is executed, the reception done flag turns OFF. The number of received bytes in the receive buffer starting number is cleared. Data in the receive buffer is not cleared.
(4)	Storage of the following receive data	Reception is enabled when the reception done flag turns OFF, and the storage of receive data is restarted.

Example 1 Send data ABCDEFGH+CR

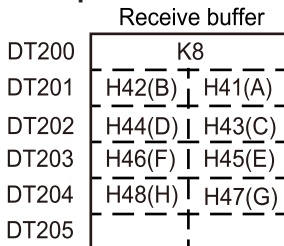

21.8 F159 MTRN [General-purpose Communication Instructions (Serial Communication)]

Example 2 Send data: ABCDEFGH+CR+LF

Receive buffer

DT200	K9	
DT201	H42(B)	H41(A)
DT202	H44(D)	H43(C)
DT203	H46(F)	H45(E)
DT204	H48(H)	H47(G)
DT205		H0D(CR)
DT206		

Info.

- When data with CR+LF as terminator is received, send data with a size that is smaller by more than one byte than the receive buffer capacity.
- **Specifying a COM port number for the F469 (UNITSEL) instruction (only for the type with Ethernet Function)**

Specifying K14 for [D] of F159 (MTRN) enables operand [S2] for F469 (UNITSEL). The following figure shows that the F469 (UNITSEL) instruction specifies S1=K0 (serial communication port) and S2=K1 (COM1).

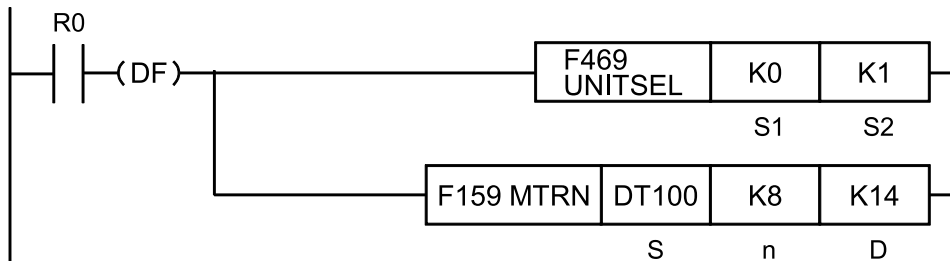

[S2] of F469 (UNITSEL)	K0	K1	K2
Port number	COM0	COM1	COM2

■ Flag operations

Name	Description
R9007	Turns ON when the data table exceeds the area in the specification of bytes in [n].
R9008 (ER)	

22 Ethernet Communication Instructions

22.1 F145 SEND/F146 RECV Common Instruction Items (Ethernet Communication).....	22-2
22.2 F145 SEND [Data Send Instruction (MEWTOCOL Master)].....	22-4
22.3 F146 RECV [Data Receive Instruction (MEWTOCOL Master)].....	22-7
22.4 F145 SEND [Data Send Instruction (MODBUS Master: Function Code Specification)].....	22-10
22.5 F146 RECV [Data Receive Instruction (MODBUS Master: Function Code Specification)].....	22-12
22.6 F145 SEND [Data Send Instruction (MODBUS Master: No Function Code Specification)].....	22-14
22.7 F146 RECV [Data Receive Instruction (MODBUS Master: No Function Code Specification)].....	22-17
22.8 F145 SEND [Data Send Instruction (MC Protocol Master)].....	22-20
22.9 F146 RECV [Data Receive Instruction (MC Protocol Master)].....	22-23
22.10 F159 MTRN (General-purpose Communication Instruction).....	22-26

22.1 F145 SEND/F146 RECV Common Instruction Items (Ethernet Communication)

22.1 F145 SEND/F146 RECV Common Instruction Items (Ethernet Communication)

■ Execution conditions for instructions

- F145 SEND / F146 RECV instruction cannot be executed to the connection during slave communication.
- Up to nine F145 SEND / F146 RECV instructions can be executed at the same time to different connections.

■ Confirmation of execution results of instructions

- The processing of F145 SEND / F146 RECV instruction is handled during the execution of ED instruction. Check the "SEND / RECV instruction execution end flag" to confirm the completion of transmission / reception. When the instruction terminates abnormally, the SEND / RECV done flag turns ON. Also, an error code is stored in the SEND / RECV done code. For details of error codes, refer to the following table.
- To communicate with FP0H or FP7, specify "H1" for the partner station number. The destination is determined by the IP address.

Special data register	Error code	Description
DT90840 to DT90848	H0	Normal end
	HFFFF	Connection is not established or disconnected
	H73	Timeout error occurred while waiting for a response
	Error code of each protocol	For details of error codes, refer to the error codes of each protocol. <ul style="list-style-type: none"> • "38.12.3 List of MEWTOCOL-COM/DAT Communication Error Codes" • "38.12.4 List of MODBUS Communication Error Codes" • "38.12.5 List of MC Protocol Communication Error Codes"

■ I/O allocations

Name	Description
SEND / RECV instruction executable flag	<ul style="list-style-type: none"> • This flag indicates whether the F145 SEND or F146 RECV instruction can be executed or not. OFF: Not executable (execution in progress) ON: Executable • When the connection is general-purpose communication, the flag is OFF.
SEND / RECV instruction end flag	<ul style="list-style-type: none"> • This flag indicates the execution state of the F145 SEND or F146 RECV instruction. An execution done code is stored. OFF: Successful ON: Unsuccessful (communication error has occurred) • When the connection is general-purpose communication, the flag is OFF.
Connection status flag	<ul style="list-style-type: none"> • When the connection is in the state of connected, the flag is ON. • When the connection is in the state of no connection, the flag is OFF.

22.1 F145 SEND/F146 RECV Common Instruction Items (Ethernet Communication)

■ Special relays / special data registers

Name	User connection								
	1	2	3	4	5	6	7	8	9
SEND / RECV instruction executable flag	R9363	R936B	R9373	R937B	R9383	R938B	R9393	R939B	R9403
SEND / RECV instruction end flag	R9364	R936C	R9374	R937C	R9384	R938C	R9394	R939C	R9404
SEND / RECV / MTRN done code	DT9084 0	DT9084 1	DT9084 2	DT9084 3	DT9084 4	DT9084 5	DT9084 6	DT9084 7	DT9084 8
Connection status flag	R9365	R936D	R9375	R937D	R9385	R938D	R9395	R939D	R9405

22.2 F145 SEND [Data Send Instruction (MEWTOCOL Master)]

22.2 F145 SEND [Data Send Instruction (MEWTOCOL Master)]

■ Instruction format

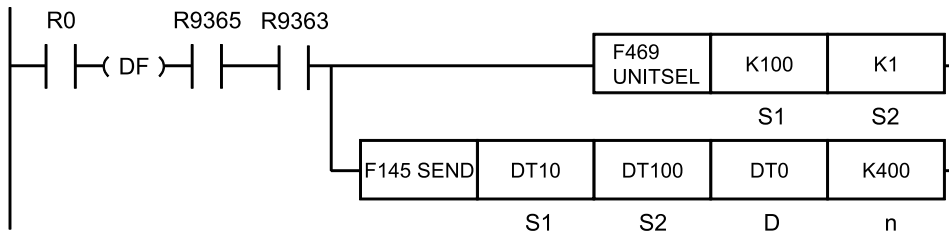

(Note 1) The figure above shows the case of specifying S1=K100 (Ethernet communication) and S2=K1 (connection No. 1) using F469 (UNITSEL) instruction.

■ Operands

Items	Settings
S1	Specify the starting address of the area that stores control data.
S2	Specify the starting address of the source data area.
D	Specify the destination data area of a partner unit. (Device No. is fixed to "0")
n	Specify the starting address of the destination device in the partner unit.

■ Devices that can be specified (indicated by ●)

Operands	WX	WY	WR	WL	SV	EV	DT	LD	I	SWR	SDT	Constant				Index modifier	Integer Device
												K	H	M	f		
S1	●	●	●	●	●	●	●	●		●	●					●	
S2	●	●	●	●	●	●	●	●		●	●					●	
D		●	●	●	●	●	●	●									
n		●	●	●	●	●	●	●				●	●			●	

■ Outline of operation

- Commands are sent from the communication port of the unit to perform data transmission / reception with external devices. Data can be read and written by specifying unit Nos. and memory addresses and executing SEND / RECV instructions in a user program, because PLC automatically creates messages according to the protocol.
- Select a communication mode in the configuration menu of the tool software FPWIN GR7.
- The data specified by [S2] in the master unit is written to the area specified by [D] and [n] in the partner unit in accordance with the specification of two-word data stored in the control data starting at the area specified by [S1].

■ Specifying the control data [S1], [S1+1]

- [S1]: Specify the transfer unit and method
Specify data quantity in the case of transmission in word units, and specify the location of target bits in the case of transmission in bit units.

Transfer in word units

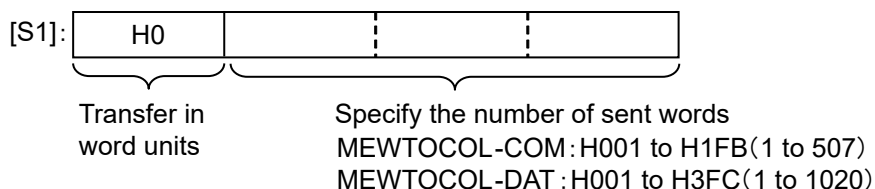

Transfer in bit units

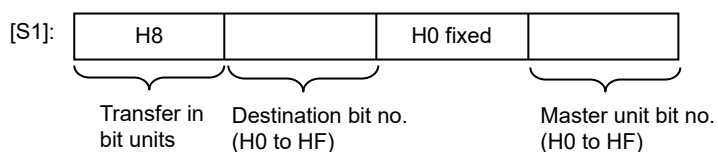

- [S1+1]: Specify the partner station number
Specify the destination unit number. COM port selection is not required in Ethernet communication.

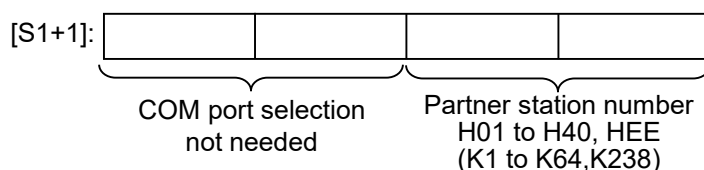

(Note 1) Communication is made possible for the main unit firmware Ver. 1.8 or later regardless of the unit No. of the partner unit since the specification of HEE (K238) is added to partner station numbers.

■ Specify the area of the partner unit for storing by using [D] and [n]

Specify "0" for the [D] device No.

Specify the memory area of a partner unit that stores sent data, combining type [D] and address [n].

Example 1) [D]: DT0, [n]: K100

↓
DT100

Example 2) [D]: DT0, [n]: HFFF0

↓
DT65520

■ Flag operations

MEWTOCOL-COM master mode

Name	Description
R9007 R9008 (ER)	When the [S1], [S1+1] control data value is outside the specified range
	When the [S2] or [D] area is exceeded, if the number of words specified in [S1] is taken during transfer in word units
	When [D] + [n] exceeds the area of [D]

22.2 F145 SEND [Data Send Instruction (MEWTOCOL Master)]

Name	Description
	When the device number of [D] is not 0 Word unit <ul style="list-style-type: none"> • When [n] is not in the range from 0 to 99999 when [D] is DT/LD • When [n] is not in the range from 0 to 9999 when [D] is WY/WR/WL/SV/EV Bit unit <ul style="list-style-type: none"> • When [D] is not WY/WR/WL • When [n] is not between 0 and 999 When the operation mode of the specified user connection is other than MEWTOCOL-COM

MEWTOCOL-DAT master mode

Name	Description
R9007 R9008 (ER)	When the [S1], [S1+1] control data value is outside the specified range
	When the [S2] or [D] area is exceeded, if the number of words specified in [S1] is taken during transfer in word units
	When [D] + [n] exceeds the area of [D]
	When the device number of [D] is not 0
	Word unit <ul style="list-style-type: none"> • When [n] is not between 0 and 0xFFFF Bit unit <ul style="list-style-type: none"> • When [D] is not WX/WY/WR/WL • When [n] is not between 0 and 0xFFFF
	When the operation mode of the specified user connection is other than MEWTOCOL-DAT

22.3 F146 RECV [Data Receive Instruction (MEWTOCOL Master)]

■ Instruction format

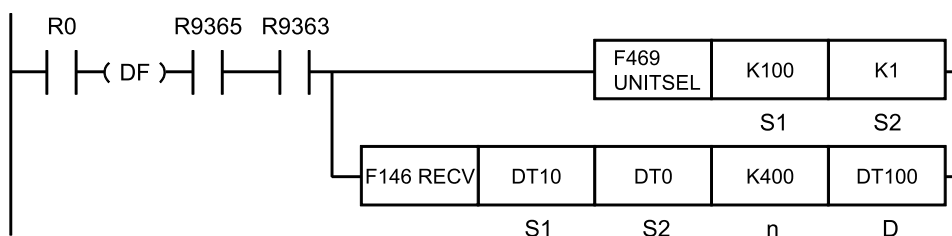

(Note 1) The figure above shows the case of specifying S1=K100 (Ethernet communication) and S2=K1 (connection No. 1) using F469 (UNITSEL) instruction.

■ Operands

Items	Settings
S1	Specify the starting address of the area that stores control data.
S2	Specify the source data area of a partner unit. (Device No. is fixed to "0")
n	Specify the starting address of the device in the source data area of a partner unit.
D	Specify the device starting address of the receive data storage area in the master unit.

■ Devices that can be specified (indicated by ●)

Operands	WX	WY	WR	WL	SV	EV	DT	LD	I	SW R	SD T	Constant				Index modifier	Integer Device
												K	H	M	f		
S1	●	●	●	●	●	●	●	●		●	●					●	
S2	●	●	●	●	●	●	●	●									
n		●	●	●	●	●	●	●				●	●			●	
D		●	●	●	●	●	●	●								●	

■ Outline of operation

- Commands are sent from the Ethernet port of the unit to perform data transmission / reception with external devices.
- Data can be read and written by specifying unit Nos. and memory addresses and executing SEND / RECV instructions in a user program, because PLC automatically creates messages according to the protocol.
- Select a communication mode in the configuration menu of the tool software FPWIN GR7.
- In accordance with the specification of two-word data stored in the control data starting with an area specified in [S1], reading is performed from the area specified by [S2] and [n] in a partner unit, starting with the [D] area of the master unit.

■ Specification of control data [S1] [S1+1]

- [S1]: Specify the transfer unit and method

22.3 F146 RECV [Data Receive Instruction (MEWTOCOL Master)]

Specify data quantity in the case of transmission in word units, and specify the location of target bits in the case of transmission in bit units.

Transfer in word units

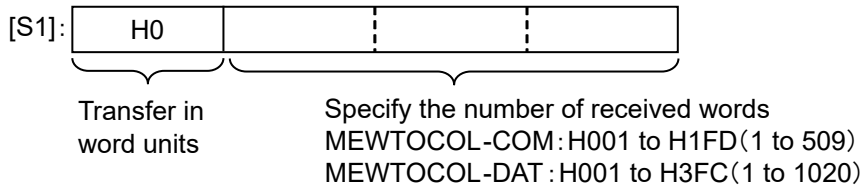

Transfer in bit units

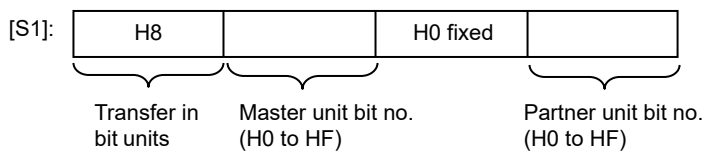

- [S1+1]: Specify the partner station number
 Specify the destination unit number. COM port selection is not required in Ethernet communication.

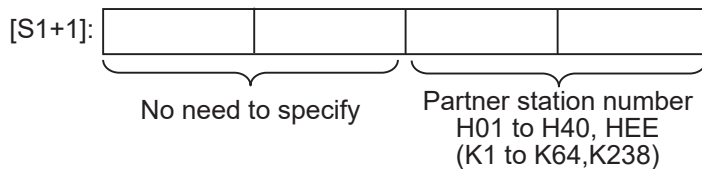

(Note 1) Communication is made possible for the main unit firmware Ver. 1.8 or later regardless of the unit No. of the partner unit since the specification of HEE (K238) is added to partner station numbers.

■ Specify the starting address [S2] of the sender data area

Specify "0" for the device number of [S2]. Specify the memory area of the partner unit storing sent data, combining type [S2] and address [n].

Example 1) [S2]: DT0, [n]: K100

↓
DT100

Example 2) [S2]: DT0, [n]: HFFF0

↓
DT65520

■ Flag operations

MEWTOCOL-COM master mode

Name	Description
R9007 R9008 (ER)	When the [S1], [S1+1] control data value is outside the specified range

22.3 F146 RECV [Data Receive Instruction (MEWTOCOL Master)]

Name	Description
	When the [S2] or [D] area is exceeded, if the number of words specified in [S1] is taken during transfer in word units
	When [S2]+[n] exceeds the [S2] area
	When the [S2] device number is not 0
	Word unit <ul style="list-style-type: none"> • If [S2] is DT/LD, when [n] is not between 0 and 99999 • If [S2] is WX/WY/WR/WL/SV/EV, when [n] is not between 0 and 9999
	Bit unit <ul style="list-style-type: none"> • When [S2] is not WX/WY/WR/WL • When [n] is not between 0 and 999
	When the operation mode of the specified user connection is other than MEWTOCOL-COM

MEWTOCOL-DAT master mode

Name	Description
	When the [S1], [S1+1] control data value is outside the specified range
	When the [S2] or [D] area is exceeded, if the number of words specified in [S1] is taken during transfer in word units
	When [S2]+[n] exceeds the [S2] area
	When the [S2] device number is not 0
R9007 R9008 (ER)	Word unit <ul style="list-style-type: none"> • When [n] is not between 0 and 0xFFFF
	Bit unit <ul style="list-style-type: none"> • When [S2] is not WX/WY/WR/WL • When [n] is not between 0 and 0xFFFF
	When the operation mode of the specified user connection is other than MEWTOCOL-DAT

22.4 F145 SEND [Data Send Instruction (MODBUS Master: Function Code Specification)]

22.4 F145 SEND [Data Send Instruction (MODBUS Master: Function Code Specification)]

■ Instruction format

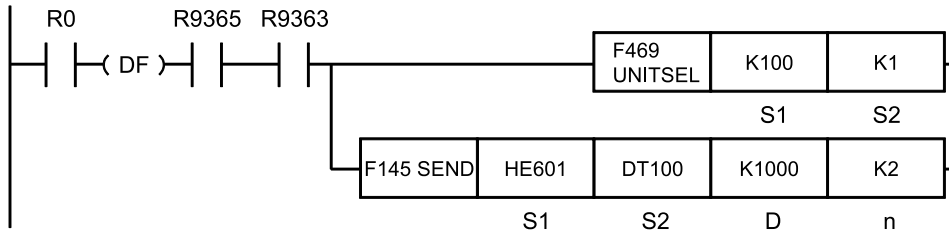

(Note 1) The figure above shows the case of specifying S1=K100 (Ethernet communication) and S2=K1 (connection No. 1) using F469 (UNITSEL) instruction.

■ Operands

Items	Settings	Setting range
S1	Specify the MODBUS function code to be used and the unit No. of a partner unit.	-
S2	Specify the starting address of the source data area of the master unit.	-
D	Specify the MODBUS address of the destination data area of a partner unit.	H0 to HFFFF
n	Specify the number of send data.	1 to 127 words 1 to 2040 bits

■ Devices that can be specified (indicated by ●)

Operands	WX	WY	WR	WL	SV	EV	DT	LD	I	SWR	SDT	Constant				Index modifier	Integer Device
												K	H	M	f		
S1	●	●	●	●	●	●	●	●		●	●	●	●		●		
S2	●	●	●	●	●	●	●	●		●	●				●		
D		●	●	●	●	●	●	●				●	●				
n		●	●	●	●	●	●	●				●	●		●		

■ Outline of operation

- MODBUS commands are sent from the communication port of the unit to perform data transmission / reception with external devices.
- Data can be read and written by specifying unit Nos. and memory addresses and executing SEND / RECV instructions in a user program, because PLC automatically creates messages according to the protocol.
- Select a communication mode in the configuration menu of the tool software FPWIN GR7.
- Specify the sending port, MODBUS function code (5 or 6), and partner unit No. with [S1].

22.4 F145 SEND [Data Send Instruction (MODBUS Master: Function Code Specification)]

- Send data specified by [S2] is sent to the MODBUS address specified by [D], using a MODBUS command. (MODBUS function code 05, 06)

■ [S1]: Specify the port number/sending command/partner unit

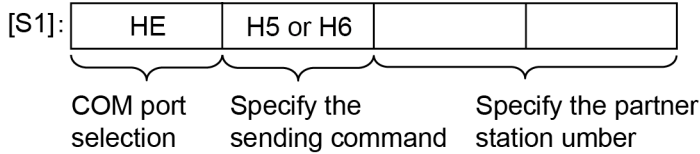

- Specify a COM port
As a LAN port, specify Ethernet communication (HE).
- Set a sending command
H5: Send bit data
H6: Send word data
- Specify the partner station number
Possible to specify from H00 to HFF (K0 to K255). If the firmware version of the main unit is earlier than Ver. 1.50, the unit No. range is from H01 to HF7 (K1 to K247).

■ Flag operations

Name	Description
R9007 R9008 (ER)	When the [S1] control data value is outside the specified range
	When the number of send data [n] is 0
	When the number of send data [n] exceeds the area of operation memory specified in [S2]
	When the number of send data [n] exceeds limitation in MODBUS specification
	When the operation mode of the specified user connection is other than MODBUS-TCP

22.5 F146 RECV [Data Receive Instruction (MODBUS Master: Function Code Specification)]

22.5 F146 RECV [Data Receive Instruction (MODBUS Master: Function Code Specification)]

■ Instruction format

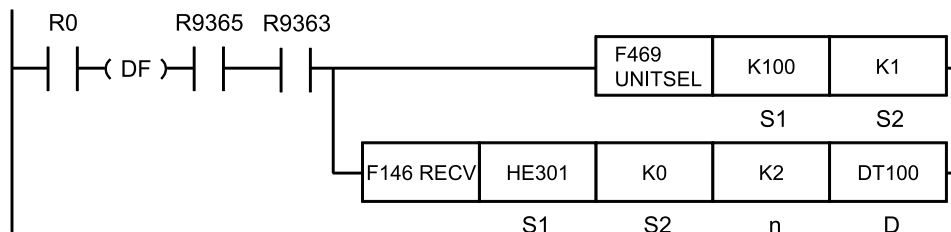

(Note 1) The figure above shows the case of specifying S1=K100 (Ethernet communication) and S2=K1 (connection No. 1) using F469 (UNITSEL) instruction.

■ Operands

Items	Settings	Setting range
S1	Specify the MODBUS function code to be used and the unit No. of a partner unit.	-
S2	Specify the source MODBUS address of a partner unit.	H0 to HFFFF
n	Specify the number of receive data.	1 to 127 words 1 to 2040 bits
D	Specify the device starting address of the receive data storage area in the master unit.	-

■ Devices that can be specified (indicated by ●)

Operands	WX	WY	WR	WL	SV	EV	DT	LD	I	SWR	SDT	Constant				Index modifier	Integer Device
												K	H	M	f		
S1	●	●	●	●	●	●	●	●		●	●	●	●		●		
S2	●	●	●	●			●	●				●	●				
n		●	●	●	●	●	●	●				●	●		●		
D		●	●	●	●	●	●	●							●		

■ Outline of operation

- MODBUS commands are sent from the communication port of the unit to perform data transmission / reception with external devices.
- Data can be read and written by specifying unit Nos. and memory addresses and executing SEND / RECV instructions in a user program, because PLC automatically creates messages according to the protocol.
- In [S1], specify the sending port, MODBUS function code (H1 to H4), and partner unit No.
- Receive data of a size specified by [n] from the MODBUS address specified by [S2].
- Received data is stored in the operation memory specified by [D].

■ **[S1]: Specify the port number/sending command/partner unit**

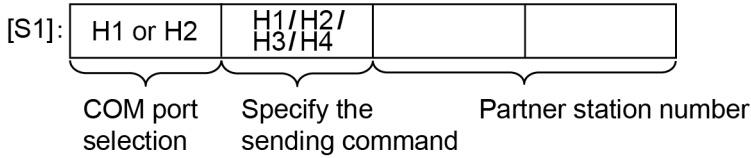

- Specify a COM port
As a LAN port, specify HE (Ethernet communication).
- Set a sending command
H1, H2, H3 or H4 can be specified.
H1: Read coil state (01)
H2: Read input state (02)
H3: Read hold register (03)
H4: Read input register (04)
- Specify the partner station number
Possible to specify from H01 to HFF (K1 to K255). If the firmware version of the main unit is earlier than Ver. 1.50, the unit No. range is from H01 to HF7 (K1 to K247).

■ **Flag operations**

Name	Description
R9007 R9008 (ER)	When the [S1] control data value is outside the specified range
	When the operation mode of the specified user connection is other than MODBUS-TCP
	When the number of received data [n] is 0
	When the area of operation memory specified by [D] is exceeded, if the number of received data [n] is received
	When the number of received data [n] exceeds limitations in the MODBUS specification

22.6 F145 SEND [Data Send Instruction (MODBUS Master: No Function Code Specification)]

22.6 F145 SEND [Data Send Instruction (MODBUS Master: No Function Code Specification)]

■ Instruction format

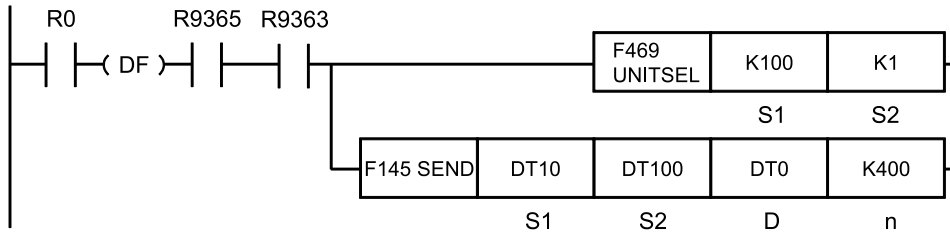

(Note 1) The figure above shows the case of specifying S1=K100 (Ethernet communication) and S2=K1 (connection No. 1) using F469 (UNITSEL) instruction.

■ Operands

Items	Settings
S1	Specify the starting address of the area that stores control data.
S2	Specify the starting address of the source data area.
D	Specify the source data area of a partner unit. (Device No. is fixed to "0")
n	Specify the starting address of the destination device in the partner unit.

■ Devices that can be specified (indicated by ●)

Operands	WX	WY	WR	WL	SV	EV	DT	LD	I	SWR	SDT	Constant				Index modifier	Integer Device
												K	H	M	f		
S1	●	●	●	●	●	●	●	●		●	●					●	
S2	●	●	●	●	●	●	●	●		●	●					●	
D		●	●				●										
n		●	●	●	●	●	●	●				●	●			●	

■ Outline of operation

- Commands are sent from the communication port of the unit to perform data transmission / reception with external devices. Data can be read and written by specifying unit Nos. and memory addresses and executing SEND / RECV instructions in a user program, because PLC automatically creates messages according to the protocol.
- Select a communication mode in the configuration menu of the tool software FPWIN GR7.
- In accordance with the specification of 2-word data stored in the control data starting with the area specified in [S1], the data specified by [S2] in the master unit is written from the area specified by [D] and [n] in a partner unit.

■ Specification of control data [S1] [S1+1]

- [S1]: Specify the transfer unit and method

22.6 F145 SEND [Data Send Instruction (MODBUS Master: No Function Code Specification)]

Specify data quantity in the case of transmission in word units, and specify the location of target bits in the case of transmission in bit units.

Transfer in word units

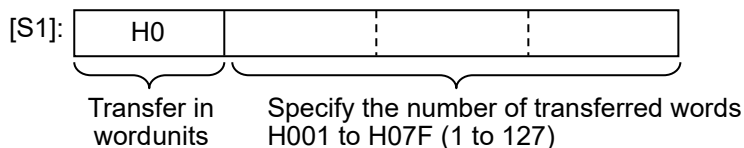

Transfer in bit units

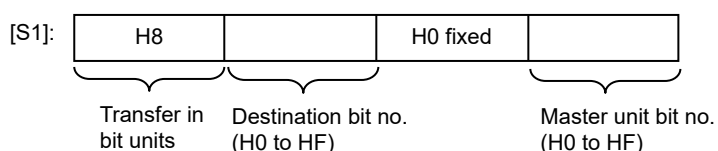

- [S1+1] : Specify the partner station number
Specify the unit No. of a partner unit. COM port selection is not required in Ethernet communication.

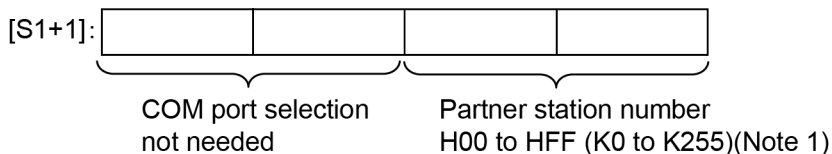

(Note 1) If the firmware version of the main unit is earlier than Ver. 1.50, the unit No. range is from H01 to HF7 (K1 to K247).

■ Specifying a storage area of a partner unit using [D][n]

Specify "0" for the [D] device No.

Specify the memory area of a partner unit that stores sent data, combining type [D] and address [n].

Example 1) [D]: DT0, [n]: K100

↓
DT100

Example 2) [D]: DT0, [n]: HFFF0

↓
DT65520

■ Flag operations

Name	Description
R9007 R9008 (ER)	When the [S1], [S1+1] control data value is outside the specified range
	When the [S2] area is exceeded if the number of words specified in [S1] is taken during transfer in word units
	When [D] + [n] exceeds the area of [D]

22.6 F145 SEND [Data Send Instruction (MODBUS Master: No Function Code Specification)]

Name	Description
	When the device number of [D] is not 0
	When the [D] area is DT during transfer in bit units
	When the operation mode of the specified user connection is other than MODBUS-TCP

22.7 F146 RECV [Data Receive Instruction (MODBUS Master: No Function Code Specification)]

■ Instruction format

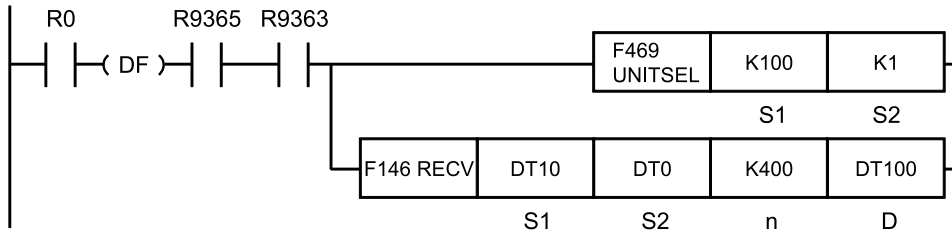

(Note 1) The figure above shows the case of specifying S1=K100 (Ethernet communication) and S2=K1 (connection No. 1) using F469 (UNITSEL) instruction.

■ Operands

Items	Settings
S1	Specify the starting address of the area that stores control data.
S2	Specify the source data area of a partner unit. (Device No. is fixed to "0")
n	Specify the starting address of the device in the source data area of a partner unit.
D	Specify the device starting address of the receive data storage area in the master unit.

■ Devices that can be specified (indicated by ●)

Operands	WX	WY	WR	WL	SV	EV	DT	LD	I	SWR	SDT	Constant				Index modifier	Integer Device
												K	H	M	f		
S1	●	●	●	●	●	●	●	●		●	●					●	
S2	●	●	●	●			●	●									
n		●	●	●	●	●	●	●				●	●			●	
D		●	●	●	●	●	●	●								●	

■ Outline of operation

- Commands are sent from the Ethernet port of the unit to perform data transmission / reception with external devices.
- Data can be read and written by specifying unit Nos. and memory addresses and executing SEND / RECV instructions in a user program, because PLC automatically creates messages according to the protocol.
- Select a communication mode in the configuration menu of the tool software FPWIN GR7.
- In accordance with the specification of two-word data stored in the control data starting with an area specified in [S1], reading is performed from the area specified by [S2] and [n] in a partner unit, starting with the [D] area of the master unit.

■ Specification of control data [S1] [S1+1]

- [S1]: Specify the transfer unit and method

22.7 F146 RECV [Data Receive Instruction (MODBUS Master: No Function Code Specification)]

Specify data quantity in the case of transmission in word units, and specify the location of target bits in the case of transmission in bit units.

Transfer in word units

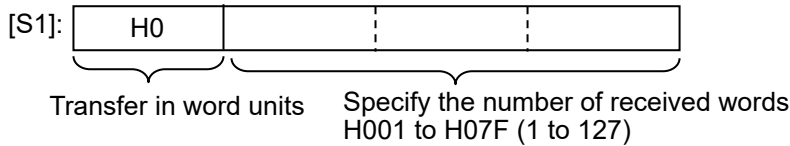

Transfer in bit units

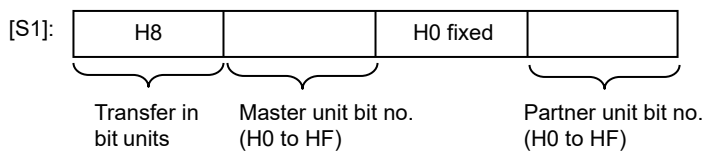

- [S1+1] : Specify the partner station number
Specify the unit No. of a partner unit. COM port selection is not required in Ethernet communication.

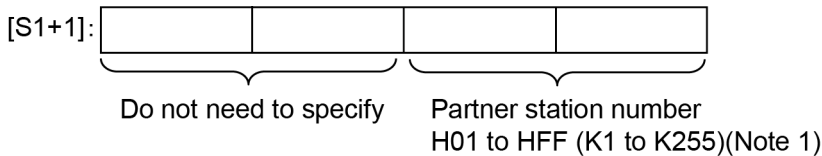

(Note 1) If the firmware version of the main unit is earlier than Ver. 1.50, the unit No. range is from H01 to HF7 (K1 to K247).

■ Specify the starting address [S2] of the sender data area

Specify "0" for the device number of [S2]. Specify the memory area of the partner unit storing sent data, combining type [S2] and address [n].

Example 1) [S2]: DT0, [n]: K100

↓
DT100

Example 2) [S2]: DT0, [n]: HFFF0

↓
DT65520

■ Flag operations

Name	Description
R9007 R9008 (ER)	When the [S1], [S1+1] control data value is outside the specified range
	When the [D] area is exceeded, if the number of words specified in [S1] is taken during transfer in word units
	When [S2]+[n] exceeds the [S2] area
	When the [S2] device number is not 0

22.7 F146 RECV [Data Receive Instruction (MODBUS Master: No Function Code Specification)]

Name	Description
	When the [S2] area is DT/WL/LD during transfer in bit units
	When the operation mode of the specified user connection is other than MODBUS-TCP

22.8 F145 SEND [Data Send Instruction (MC Protocol Master)]

22.8 F145 SEND [Data Send Instruction (MC Protocol Master)]

■ Instruction format

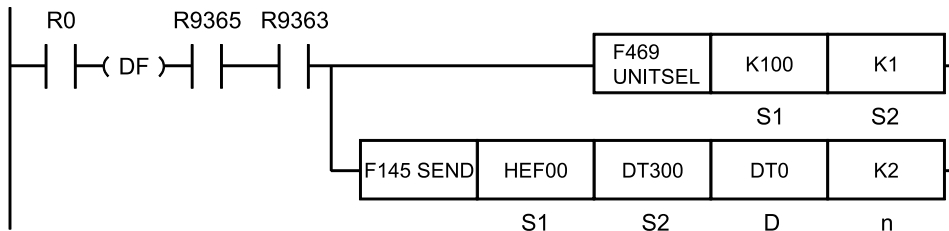

(Note 1) The figure above shows the case of specifying S1=K100 (Ethernet communication) and S2=K1 (connection No. 1) using F469 (UNITSEL) instruction.

■ Operands

Items	Settings	Setting range
S1	Specify communication port settings and transfer methods.	-
S2	Specify the starting address of the source data area.	-
D	By combining [D] and [D+1], specify the partner unit receiver device type and the starting address of the receiver data area.	Refer to "Specifying [D] and [D+1]"
n	Specify the number of send data.	1 to 960 words 1 to 4054 bits

■ Devices that can be specified (indicated by ●)

Operands	WX	WY	WR	WL	SV	EV	DT	LD	I	SWR	SDT	Constant				Index modifier	Integer Device
												K	H	M	f		
S1	●	●	●	●	●	●	●	●		●	●	●	●			●	
S2	●	●	●	●	●	●	●	●		●	●					●	
D		●	●	●	●	●	●	●									
n		●	●	●	●	●	●	●				●	●			●	

■ Outline of operation

- Commands are sent from the communication port of the unit to perform data transmission / reception with devices that support "MC Protocol".
- Data can be read and written by specifying unit Nos. and memory addresses and executing SEND / RECV instructions in a user program, because PLC automatically creates messages according to the protocol.
- Select a communication mode in the configuration menu of the tool software FPWIN GR7.
- When the F145 SEND instruction is executed, [n] pieces of data starting from [S2] are read from a device in the master unit.
- The read data is stored in the data area specified by [D] and [D+1] in the partner unit.

■ Specifying [S1]

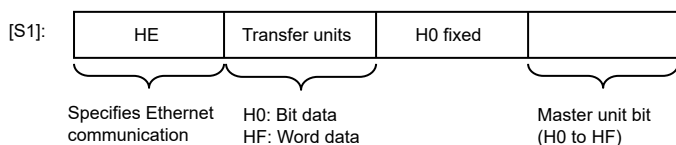

- For bit data transfer, it is necessary to specify the bit No. of the master unit.
- For word data transfer, it is not necessary to specify the bit No. of the master unit.

■ Specifying [D] and [D+1]

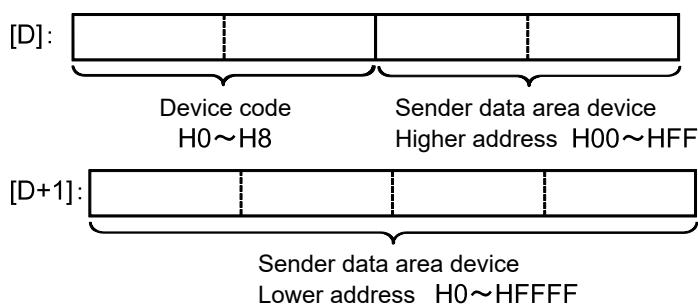

- For device codes, refer to the table below.

Unit	Device type			Device code
Bits	Input	X	Hexadecimal	H0
	Output	Y	Hexadecimal	H1
	Link relay	B	Hexadecimal	H2
	Internal relay	M	Decimal	H3
	Latch relay	L	Decimal	H4
Word	Data register	D	Decimal	H5
	File register	R	Decimal	H6
		ZR	Hexadecimal	H7
Link register	W	Hexadecimal	H8	

- The partner unit device address is specified by the combination of the low byte of [D] and the value of [D+1]. When the address is in the range of H0 to HFFFF, specify "H00" for the low byte of [D].

■ Exit codes when communication error occurs

When a wrong command is sent or an error occurs in the control unit, a different exit code is returned. Exit codes in an error state are as follows.

Code	Timing of occurrence
4031	Address is too long (Starting device + Number of written points)
C051	The number of devices is outside the specified range.
C056	The starting device is outside the specified range.

22.8 F145 SEND [Data Send Instruction (MC Protocol Master)]

Code	Timing of occurrence
C059	Command search: There is no command that matches the receive data command in the MC protocol command table.
C059	The subcommand is outside the specified range.
C05B	The device code is outside the specified range.
C05C	Subcommand is in bit unit (0001) and device code indicates a word device.
C05F	Receive header content check:"Network No."check
C05F	Receive header content check:"PC No."check
C05F	Receive header content check:"Destination unit I/O No."check
C05F	Error in the number of received and written data
C060	Error in written contact data (except 0 / 1)
C061	Receive header content check: the number of receive data is smaller than the minimum received bytes that support header content check.
C061	The number of receive data is smaller than the minimum number of receive bytes.

■ Flag operations

Name	Description
R9007 R9008 (ER)	When the [S1] control data value is outside the specified range
	The number of sent data [n] is incorrect
	When the number of send data [n] exceeds the area of operation memory specified in [S2]
	When bit data is specified by [S1], but the specified device type of the partner unit is word
	If bit data is specified in [S1], when S2 is not WX/WY/WR/WL
	When the device code specified in [D] is out of range
	When the operation mode of the specified user connection is other than MC protocol

22.9 F146 RECV [Data Receive Instruction (MC Protocol Master)]

■ Instruction format

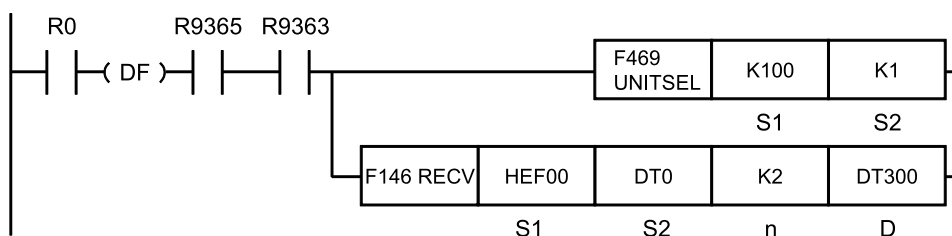

(Note 1) The figure above shows the case of specifying S1=K100 (Ethernet communication) and S2=K1 (connection No. 1) using F469 (UNITSEL) instruction.

■ Operands

Items	Settings	Setting range
S1	Specify communication port settings and transfer methods.	-
S2	Combine [S2] and [S2+1] to specify the partner unit sender device type and the starting address of the sender data area.	Refer to "Specifying [S2] and [S2+1]"
n	Specify the number of receive data.	1 to 960 words 1 to 4054 bits
D	Specify the device starting address in the master unit that stores receive data.	-

Z

■ Devices that can be specified (indicated by ●)

Operands	WX	WY	WR	WL	SV	EV	DT	LD	I	SWR	SDT	Constant				Index modifier	Integer Device
											K	H	M	f			
S1	●	●	●	●	●	●	●	●		●	●	●	●			●	
S2	●	●	●	●			●	●									
n		●	●	●	●	●	●	●				●	●			●	
D		●	●	●	●	●	●	●								●	

■ Outline of operation

- Commands are sent from the communication port of the unit to perform data transmission / reception with devices that support "MC Protocol".
- Data can be read and written by specifying unit Nos. and memory addresses and executing SEND / RECV instructions in a user program, because PLC automatically creates messages according to the protocol.
- Select a communication mode in the configuration menu of the tool software FPCWIN GR7.
- When the F146 RECV instruction is executed, [n] pieces of data are read from the address starting with [S2] lower address + [S2+1] in the partner unit.
- The read data is stored in an area starting from [D] in the master unit.

22.9 F146 RECV [Data Receive Instruction (MC Protocol Master)]

■ Specifying [S1]

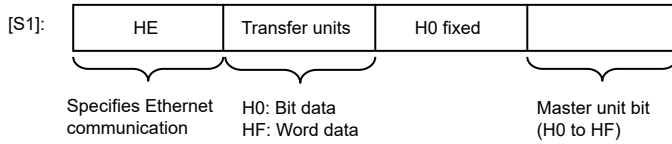

- For bit data transfer, it is necessary to specify the bit No. of the master unit.
- For word data transfer, it is not necessary to specify the bit No. of the master unit.

■ Specifying [S2] and [S2+1]

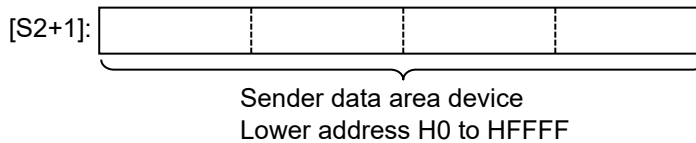
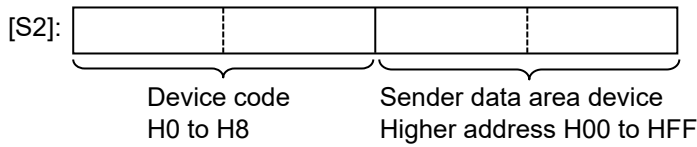

- For device codes, refer to the table below.

Unit	Device type			Device code
Bits	Input	X	Hexadecimal	H0
	Output	Y	Hexadecimal	H1
	Link relay	B	Hexadecimal	H2
	Internal relay	M	Decimal	H3
	Latch relay	L	Decimal	H4
Word	Data register	D	Decimal	H5
	File register	R	Decimal	H6
		ZR	Hexadecimal	H7
	Link register	W	Hexadecimal	H8

- The partner unit device address is specified by the combination of the low byte of [S2] and the value of [S2+1]. When the address is in the range of H0 to HFFFF, specify "H00" for the low byte of [S2].
- The transfer method and the number of sent data specified by [n] vary according to the type of the device specified by the operand [D].

Device specified by [D]	Transfer method	Number of sent data [n]	Remarks
16-Bit device: WX, WY, WR, WL, DT, LD	Word transfer	1 to 960	

22.9 F146 RECV [Data Receive Instruction (MC Protocol Master)]

Device specified by [D]	Transfer method	Number of sent data [n]	Remarks
1-Bit device: X, Y, R, L	Bit transfer	1 to 4054	When the number of receive data is an odd number, a four-bit dummy code H0 is added.

■ Exit codes when communication error occurs

When a wrong command is sent or an error occurs in the control unit, a different exit code is returned. Exit codes in an error state are as follows.

Code	Timing of occurrence
4031	Address is too long (Starting device + Number of written points)
C051	The number of devices is outside the specified range.
C056	The starting device is outside the specified range.
C059	Command search: There is no command that matches the receive data command in the MC protocol command table.
C059	The subcommand is outside the specified range.
C05B	The device code is outside the specified range.
C05C	Subcommand is in bit unit (0001) and device code indicates a word device.
C05F	Receive header content check:"Network No."check
C05F	Receive header content check:"PC No."check
C05F	Receive header content check:"Destination unit I/O No."check
C05F	Error in the number of received and written data
C060	Error in written contact data (except 0 / 1)
C061	Receive header content check: the number of receive data is smaller than the minimum received bytes that support header content check.
C061	The number of receive data is smaller than the minimum number of receive bytes.

■ Flag operations

Name	Description
R9007 R9008 (ER)	When the [S1] control data value is outside the specified range
	The number of sent data [n] is incorrect
	When the number of sent data [n] exceeds the area of operation memory specified by [D]
	When bit data is specified by [S1], but the specified device type of the partner unit is word
	When bit data is specified by [S1], but [D] is not WX/WY/WR/WL
	When the device code specified by [S2] is out of range
	When the operation mode of the specified user connection is other than MC protocol

22.10 F159 MTRN (General-purpose Communication Instruction)

22.10 F159 MTRN (General-purpose Communication Instruction)

■ Instruction format

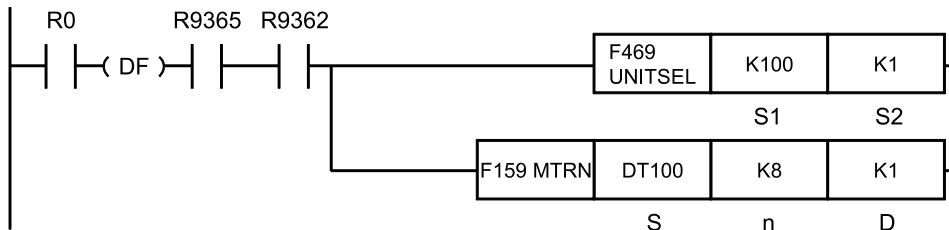

(Note 1) The figure above shows the case of specifying S1=K100 (Ethernet communication) and S2=K1 (connection No. 1) using F469 (UNITSEL) instruction.

■ Operands

Items	Settings
S	Starting area (data register) of the data table
n	Area storing the number of bytes of data to be sent, or constant data
D	Invalid: The user connection No. specified by the F469 UNITSEL instruction determines a destination.

■ Devices that can be specified (indicated by ●)

Operands	WX	WY	WR	WL	SV	EV	DT	LD	I	SWR	SDT	Constant				Index modifier	Integer Device
												K	H	M	f		
S							●									●	
n	●	●	●	●	●	●	●	●	●			●	●			●	
D												●					

■ Outline of operation

Data is sent to or received from an external device using the communication port and connection specified by the F469 UNITSEL instruction.

Items	Description
Transmission	[n] bytes of data from the starting address of the data register specified by [S] are sent to an external device via Ethernet communication port.
Receive	Reception is controlled by the ON/OFF state of the general-purpose communication received flag. When the general-purpose communication received flag is OFF, reception is enabled at any time. The F159 MTRN instruction is used to turn OFF the general-purpose communication received flag (enabling reception). Data sent to Ethernet communication port is stored in the receive buffer (data register DT) specified by the Ethernet setting (user connection setting). Receive data is extracted in the data register (DT), in accordance with the specified "receive buffer starting number in general-purpose communication" and "receive buffer capacity in general-purpose communication".

■ Ethernet Settings

- It is necessary to set the operation mode setting to "General-Purpose Communication" in user connection settings.
- It is necessary to match the port No. and IP address with the connecting external device in user connection settings.
- To secure an area in the data register (DT) to store received data, it is necessary to set the "receive buffer starting address" and "receive buffer capacity" in user connection settings.

■ Related Flags and Ethernet Settings

Name	Operation	User Connection								
		1	2	3	4	5	6	7	8	9
Communication error flag	0: Normal 1: Error	R9360	R9368	R9370	R9378	R9380	R9388	R9390	R9398	R9400
Received flag for general-purpose communication	0: Reception possible 1: Reception impossible (reception done)	R9361	R9369	R9371	R9379	R9381	R9389	R9391	R9399	R9401
Sent flag for general-purpose communication	0: Sending 1: Sending completed (clear to send)	R9362	R936A	R9372	R937A	R9382	R938A	R9392	R939A	R9402
SEND / RECV / MTRN done code	0000h: Successful completion FFFFh: Disconnection	DT9084 0	DT9084 1	DT9084 2	DT9084 3	DT9084 4	DT9084 5	DT9084 6	DT9084 7	DT9084 8
Connection establishment state flag	0: No connection 1: Connected	R9365	R936D	R9375	R937D	R9385	R938D	R9395	R939D	R9405
Receive buffer starting address	Specify the starting number of data register used for the receive buffer of general-purpose communication. (The settable range varies based on the set value for system register No. 0.)									
Receive buffer capacity	Specify the receive buffer size of general-purpose communication. (Setting value × 1 word)									

22.10 F159 MTRN (General-purpose Communication Instruction)

■ Creation of send data table [S]

Send data is stored as follows in a given memory area (e.g. data register DT). The number of send data bytes [n] is automatically added to the starting word. Send data should be stored in [S +1] and after.

e.g. When 8-byte data"ABCDEFGH" is sent with [S] set to DT100

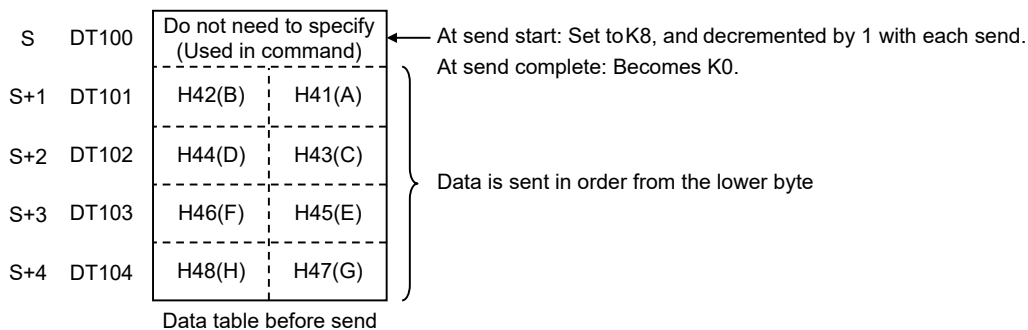

(Note 1) No header or terminator is added to sent data. Depending on the protocol of an external device, if a header and a terminator need to be sent, store them as part of send data.

(Note 2) The maximum number of transmission bytes is 2048.

■ Precautions for programming

- To perform communication, setup is required in the configuration menu of the tool software.
- Include a F469 UNITSEL instruction before the F159 MTRN instruction to specify the target unit and communication port or connection.
- Confirm that the general-purpose communication sent flag and connection status flag have turned ON for the target Ethernet communication port and connection, then execute the F159 MTRN instruction.
- General-purpose communication can use user connections 1 to 9. System connection cannot be used.
- No header or terminator is added to data to be sent. Store the start code and end code as part of the send data if they need to be sent to match the external device protocol.
- The maximum data that can be sent in a single session is 2,048 bytes.

■ Structure of receive data

Receive data is stored in the receive buffer (data register DT) specified in the system register. The number of receive data bytes is stored in the starting word.

Example: When 8-byte data"ABCDEFGH" is received

Specify 200 for the receive buffer starting number, and 5 for the receive buffer capacity.

22.10 F159 MTRN (General-purpose Communication Instruction)

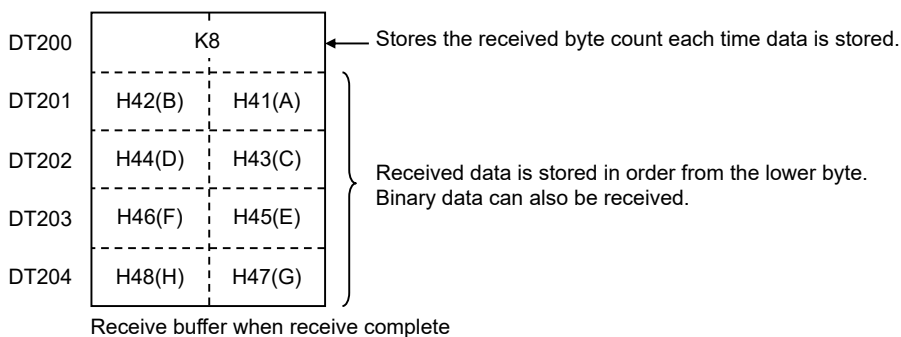

(Note 1) Depending on the communication format of an external device, if a header and a terminator are contained, they are stored in the operation memory as part of receive data. When necessary, insert a program to extract data content.

(Note 2) The maximum number of received bytes is 4096.

■ Flag operations

Name	Description
R9007 R9008 (ER)	Set when the range is exceeded during indirect access (index modification).
	Set when the connection specified by F469 (UNITSEL) is closed (other than "Connect").
	Set when the communication mode of the communication port specified by F469 (UNITSEL) is not "General-purpose communication".
	When the data device specified by [S] exceeds the area
	When the number of sent data specified by [n] is 0. When the maximum value is exceeded
	When the number of sent data specified by [n] exceeds the data area
	Set when executed in an interrupt program.

(MEMO)

23 Sampling Trace Instructions

23.1 Sampling Trace	23-2
23.2 F155 SMPL (Sample Set Data)	23-3
23.3 F156 STRG (Sampling Stop Trigger).....	23-4

23.1 Sampling Trace

23.1 Sampling Trace

This is a function used to sample the ON/OFF status of registered contacts and the data stored in the registers, either periodically or when the appropriate conditions have been established, and store the results in memory. This function can be used to confirm changes in the data.

- 16 contacts and up to three words for registers can be registered.

1 2 Procedure

- 1.** Specify registration of the data to be sampled and the sampling method (such as the number of times or the time interval).
- 2.** Instruct the sampling trace to begin.
- 3.** Execute sampling.
Sampling can be executed as periodic sampling or according to the F155 (SMPL) instruction.
- 4.** Stop the sampling trace.
Apply a stop command trigger by using a programming tool software online operation or by executing the F156 (STRG) instruction. When the trigger is applied, the sampling trace is stopped after sampling of the specified delay count is performed. The programming tool software can also be used to initiate a forced stop.)
- 5.** The programming tool software can be used to read the sampling results from the control unit, and to monitor and confirm them.

23.2 F155 SMPL (Sample Set Data)

Performs sampling when a sampling trace is executed.

■ Instruction format

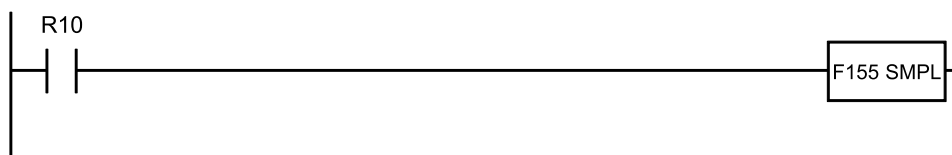

■ Outline of operation

- During a sampling trace, sampling is performed on the specified data (contacts and registers), and the executed data content is stored in the sampling trace memory.
- If the sampling trace settings and startup have not been specified by using the programming tool software, processing is not performed even if the internal relay condition is established.

■ Operation example

Operation of instruction format description program

When the internal relay R10 is ON, sampling is performed on previously registered contacts or registers.

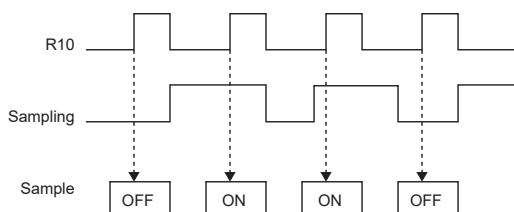

Registration of the data to be sampled, specification of the sampling method (such as the cable and the time interval), and specification of the command to start a sampling trace can only be performed by using the programming tool software.

23.3 F156 STRG (Sampling Stop Trigger)

23.3 F156 STRG (Sampling Stop Trigger)

Applies a stop command trigger during sampling trace execution.

■ Instruction format

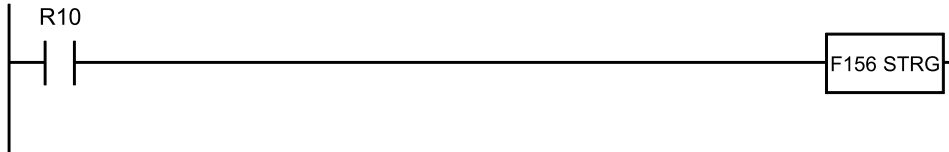

■ Outline of operation

- This instruction applies a sampling trace stop command trigger. When the trigger is applied, the sampling trace is stopped after sampling of the specified delay count is performed.
- If the sampling trace settings and startup have not been specified by using the programming tool software, processing is not performed even if the internal relay condition is established.

■ Operation example

Operation of instruction format description program

When internal relay R10 turns ON, a sampling trace stop command trigger is applied.

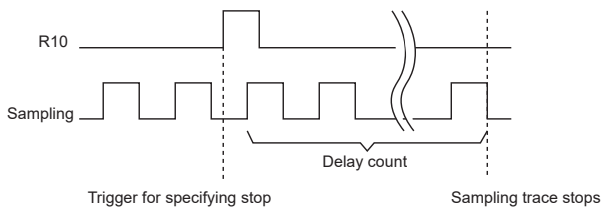

Registration of the data to be sampled, specification of the sampling method (such as the cable and the time interval), and specification of the command to start a sampling trace can only be performed by using the programming tool software.

24 High-speed Counter / PWM Output Instructions

24.1 [F0 MV] High-speed Counter Control Instruction	24-2
24.2 F1 DMV (Pulse Output Elapsed Value Write/Read).....	24-4
24.3 [F165 CAM0] High-speed Counter Cam Control Instruction.....	24-5
24.4 [F166 HC1S] High-speed Counter Target Value Match ON Instruction [F167 HC1R] High-speed Counter Target Value Match OFF Instruction	24-10
24.5 [F173 PWMH] PWM Output Instruction (Frequency Specification) ..	24-12
24.6 [F173 PWMH] PWM Output Instruction (Control Code Specification)	24-14

24.1 [F0 MV] High-speed Counter Control Instruction

24.1 [F0 MV] High-speed Counter Control Instruction

Performs the controls such as the software reset, disabling the count and clearing the high-speed counter instruction.

■ Instruction format

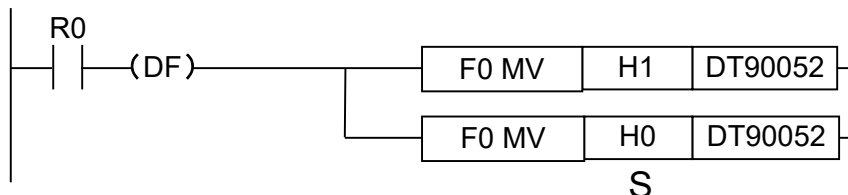

■ Operand

Operand	Settings
S	Area storing the control code of the high-speed counter or constant data

■ Memory area type that can be specified

Operand	WX	WY	WR	WL	SV	EV	DT	LD	I	Constant		Index modifier
										K	H	
S	•	•	•	•	•	•	•	•	•	•	•	•

■ Outline of operation

- Performs the high-speed counter control according to the control code specified by [S].
- This instruction is used when performing the following operations with the high-speed counter.
 1. When performing the software reset
 2. When disabling the count
 3. When disabling the reset input by an external input temporarily
 4. When canceling the control executed by the high-speed counter instruction F165 (CAM0) / F166 (HC1S) / F167 (HC1R), when clearing the target value match interrupt
- The control codes once written are held until the next writing.
- The control code written by the F0 (MV) instruction is written to the special data register DT90052. At the same time, it is written to the control code monitor area. The written data is the data for lower 8 bits only.

■ Precautions during programming

- The setting of disabling the reset input is valid only when allocating the reset input in the system register.
- In the external reset input setting, the reset input (X2 or X5) allocated to the internal input is switched between enable and disable.

■ Allocation of control codes

- The following bits are allocated according to the specified channel and functions.

24.2 F1 DMV (Pulse Output Elapsed Value Write/Read)

24.2 F1 DMV (Pulse Output Elapsed Value Write/Read)

Writes and reads the elapsed value of the high-speed counter.

■ Instruction format

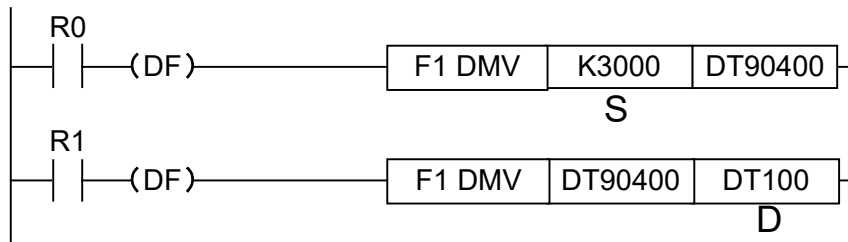

■ Operand

Operand	Settings
S	When setting: Area storing the elapsed value (32-bit) set in the high-speed counter or constant data K-2,147,483,648 to K2,147,483,647
D	When reading: Area reading the elapsed value of the high-speed counter

■ Memory area type that can be specified

Operand	WX	WY	WR	WL	SV	EV	DT	LD	I	Constant		Index modifier
										K	H	
S	•	•	•	•	•	•	•	•	•	•	•	•
D	-	•	•	•	•	•	•	•	•	-	-	•

■ Outline of operation (Reading elapsed value)

- Reads the content of the special data register storing the elapsed value of the high-speed counter and writes to the area specified by [D].

■ Outline of operation (Setting elapsed value)

- At the same time as writing the value to the elapsed value area of the high-speed counter which uses 32-bit data specified by [S], sets it in the elapsed value area of the high-speed counter used within the system.

■ Precautions during programming

- Only F1 (DMV) instruction can perform the writing. The writing cannot be performed by other high-level instructions such as transfer instruction F0 (MV) and arithmetic instructions.
- Specify the memory area of [S] or [D] with the memory area number for the lower 16 bits.

24.3 [F165 CAM0] High-speed Counter Cam Control Instruction

Performs the cam output up to a maximum of 32 points (ON/OFF) according to the elapsed value of the high-speed counter.

■ Instruction format



■ Operand

Operand	Settings
S	Starting number of data table

■ Memory area type that can be specified

Operand	WX	WY	WR	WL	SV	EV	DT	LD	I	Constant		Index modifier
										K	H	
S	-	-	-	-	-	-	•	-	-	-	-	•

■ Outline of operation

- Performs the cam output up to a maximum of 32 points (ON/OFF) according to the elapsed value of the high-speed counter in the pattern specified for the data table starting with [S]. The output device can be selected from internal relay, output relay and link relay.
- The ON set value and OFF set value can be arbitrarily specified as a paired target values for a single cam output regardless of the magnitude of target values or the order for one cam output. The pattern of ON/OFF varies according to the setting.

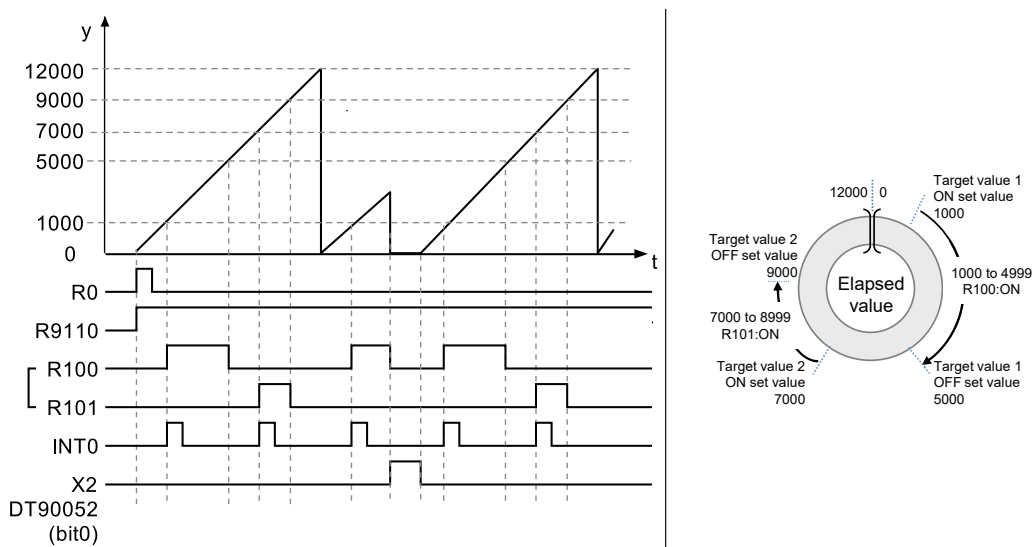

24.3 [F165 CAM0] High-speed Counter Cam Control Instruction

■ Upper limit control

With the F165 (CAM0) instruction, the control with a specified upper limit can be performed. The settings for enabling/disabling the upper limit control and the upper limit are specified in the data table.

		Upper limit control: Enable	Upper limit control: Disable
Counting range		0 to Upper limit	Negative min. value to Positive max. value
Operation when exceeding the counting range	When added	When the elapsed value exceeds the upper limit, it returns to 0.	When the elapsed value exceeds the positive maximum value, it returns to the negative minimum value.
	When subtracted	When the elapsed value falls below 0, it returns to the upper limit.	When the elapsed value falls below the negative minimum value, it returns to the positive maximum value.

■ Data table settings

Operand	Settings	Description
S, S+1	High-speed counter channel Upper and lower limit control	<p>Specify the high-speed counter channel where the cam control is performed and whether or not to execute the upper and lower limit control as a hexadecimal constant.</p> <div style="text-align: center;"> </div>
S+2, S+3	Output device type (Note 1)	Specify the device type set for the cam output. H0: Link relay (L), H1: Internal relay (R), H2: Output relay (Y)
S+4, S+5	Starting word no. of output device	Specify the starting word number of the device set for the cam output. (Note 2)
S+6, S+7	No. of target values	Settable range: K1 to K32 (Note 2)
S+8, S+9	Target value 1: ON set value	<p>Set the ON set value and OFF set value according to the number of target values. (Note 3)</p> <p>Settable range: K-2147483647 to K2147483646 (H80000001 to H7FFFFFFE)</p> <p>The cam output described in the next page is acquired according to the magnitude of the ON set values and elapsed value.</p>
S+10, S+11	Target value 1: OFF set value	
S+12, S+13	Target value 2: ON set value	
S+14, S+15	Target value 2: OFF set value	
-----	-----	
S+(m-1)x4+8 S+(m-1)x4+9	Target value m: ON set value	
S+(m-1)x4+10 S+(m-1)x4+11	Target value m: OFF set value	

24.3 [F165 CAM0] High-speed Counter Cam Control Instruction

Operand	Settings	Description
S+(m-1)x4+12 S+(m-1)x4+13	Upper limit (Note 4)	Settable range: K1 to K2147483646 (H1 to H7FFFFFFE)

- (Note 1) When specifying the output relay (Y), values are also output to the CPU output as well as operation memories.
- (Note 2) When the number of target values [S+6, S+7] is set to 1-16, the cam output is allocated to one word of output device. When set to 17-32, it is allocated to two words of output device. Refer to the next page for details.
- (Note 3) The number of target values specified after [S+8, S+9] varies according to the number of target values specified in [S+6, S+7].
- (Note 4) The upper limit of the data table end is valid only when the upper limit control is set to "Yes" in [S, S+1]. This setting can be omitted when the upper limit control is set to "No".
- (Note 5) The data table varies in the range of 12 to 138 words according to the number of target values and the specified upper limit setting.

■ Specification of output device: [S+2] to [S+5]

- When the number of target values is set to 1-16, one word is used. When the number of target values is set to 17-32, two words are used.
- One device is allocated to a paired target values (ON set value and OFF set value).
(Example): When the output device type is set to "Internal relay", the starting word number of output device is set to "0", and the number of target values is set to "32", R0 to R1F are allocated as the device for the cam output.

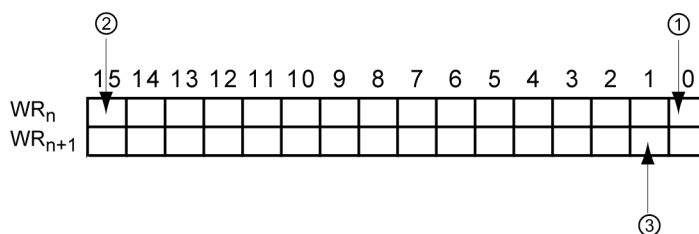

(1)	When the elapsed value reaches the target value 1, R0 turns on or off.
(2)	When the elapsed value reaches the target value 16, RF turns on or off.
(3)	When the elapsed value reaches the target value 18, R11 turns on or off.

■ Specification of target values: From [S+8]

The acquired output varies according to the ON set value and OFF set value.

	ON set value < OFF set value	ON set value > OFF set value	ON set value = OFF set value
When added			

24.3 [F165 CAM0] High-speed Counter Cam Control Instruction

	ON set value < OFF set value	ON set value > OFF set value	ON set value = OFF set value
When subtracted			
Description	When the elapsed value is larger than or equal to the ON set value and smaller than the OFF set value, the corresponding output bit turns on. When the elapsed value is out of the range, the corresponding bit turns off.	When the elapsed value is smaller than the ON set value and larger than or equal to the OFF set value, the corresponding output bit turns off. When the elapsed value is out of the range, the corresponding bit turns on.	When the elapsed value is out of the range, the corresponding bit turns off.

■ Precautions during programming

- This instruction cannot be used when the high-speed counter function is not used. Allocate arbitrary channels and contacts in the system register "high-speed counter setting".
- The high-speed counter control flag corresponding to the specified channel turns on until the execution of the high-speed counter control instruction F0 (MV) is cleared after the execution condition of the F165 (CAM0) instruction has turned on. When the high-speed counter control flag is on, the high-speed counter control instruction F165 (CAM0)/F166 (HC1S)/F167 (HC1R) for which the same channel is specified cannot be executed.
- This instruction can be activated for up to two channels simultaneously.
- To stop the control of this instruction, execute "Clear high-speed counter instruction" by the high-speed counter control instruction F0 (MV). Even when executing "Clear high-speed counter instruction", the output allocated to the cam output is held. Also, the counting of the high-speed counter continues and the upper limit control becomes disabled.
- Reset or preset the high-speed counter elapsed value before activating the instruction.
- Do not rewrite the elapsed value for the control using the F1 (DMV) instruction after the execution of the instruction. After the execution of the instruction, the setting of the active target values do not change even if the operation memory of the specified target values (ON set value/OFF set value) is changed.
- When controlling the output device using the main program, set each target value so that "minimum moving time between each target value" is larger than "1 scan time".
- When controlling the output device using an interrupt program, set each target value so that "minimum moving time between each target value" is larger than "maximum execution time of interrupt program".
- When the maximum value control and the hardware/software reset is used at the same time, do not operate them intensively in a short time.
- When hardware/software reset is used, set the minimum target value to an integer value that is 1 or more.
- When the hardware reset or software reset is executed during the high-speed counter control, the high-speed counter elapsed value is reset to 0. The output allocated to the cam output will be the output according to the elapsed value 0.
- It is also possible to start the interrupt program INTn every time the elapsed value reaches each target value. For this operation, the activation of the interrupt program should be permitted by the interrupt control instruction ICTL.

Info.

- For details of the allocations of I/O and flags, refer to "[38.5.4 When Using High-speed Counter Function](#)".
- For details of the FPsigma mode, refer to "[38.6 FPsigma Mode](#)".

24.4 [F166 HC1S] High-speed Counter Target Value Match ON Instruction [F167 HC1R] High-speed Counter Target Value Match OFF Instruction

24.4 [F166 HC1S] High-speed Counter Target Value Match ON Instruction [F167 HC1R] High-speed Counter Target Value Match OFF Instruction

Turns on or off the specified output when the elapsed value of the high-speed counter matches the target value set by the operand.

■ Instruction format

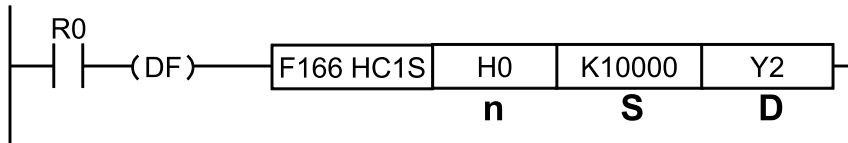

■ Operand

Operand	Settings
n	Target channel number of the high-speed counter for the match output
S	Target value data of the high-speed counter or the starting number of the area storing data
D	Output coil which turns on or off when the values match (Y0 to Y1F)

■ Memory area type that can be specified

Operand	WX	WY	WR	WL	SV	EV	DT	LD	I	Constant		Index modifier
										K	H	
n	-	-	-	-	-	-	-	-	-	•	•	-
S	•	•	•	•	•	•	•	•	•	•	•	•
D	-	-	-	-	-	-	-	-	-	-	-	-

■ Outline of operation

- Sets the value specified by [S] as the target value of the high-speed counter, and controls the specified output [Yn] when the elapsed value matches the target value. This operation is executed as an interrupt processing.
- In the case of [F166 HC1S] instruction, the output turns on from off. In the case of [F167 HC1R] instruction, the output turns off from on.
- Stores the value of [S] in the target value area when the instruction is executed.
- Clears the setting of the target value and the control of the target value match output when the value matches the target value.
- For resetting the output turned ON/OFF when the values match, use the RST instruction or F0 (MV) instruction, or use the F166 (HC1R) instruction and F167 (HC1R) instruction in a pair.

■ Example of program

The following example shows the program for setting the output Y0 when the elapsed value of the high-speed counter CH0 matches K10000.

24.4 [F166 HC1S] High-speed Counter Target Value Match ON Instruction [F167 HC1R] High-speed Counter Target Value Match OFF Instruction

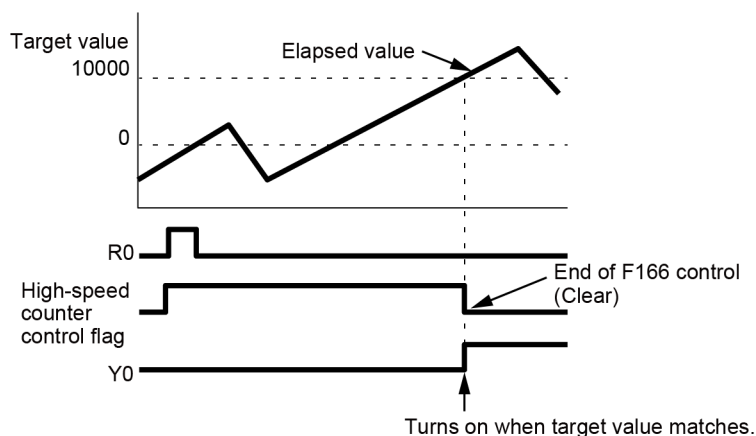
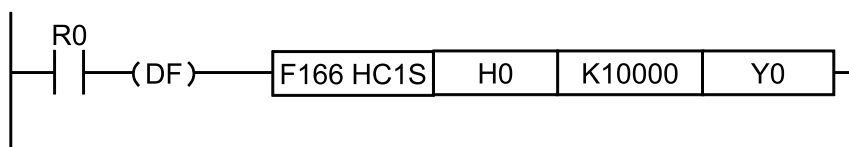

■ Precautions during programming

- The high-speed counter control flag turns on until the value matches the target value after the execution condition of the instruction has turned on. During this processing, the high-speed counter instruction F165 (CAM0)/F166 (HC1S)/F167 (HC1R) cannot be executed for the high-speed counter of the same channel.
- When the hardware reset is performed before the elapsed value matches the target value, the elapsed value will be reset. However, the settings of the target value and the target value match output will not be cleared.
- For the output Y specified for the target value match output, it is not checked whether the output is overlapped with the OT, KP and other high-level instructions.
- When describing the same channel in both the normal program and the interrupt program, be sure to program not to execute them simultaneously.

i Info.

- For details of the allocations of I/O and flags, refer to "[38.5.4 When Using High-speed Counter Function](#)".
- For details of the FPsigma mode, refer to "[38.6 FPsigma Mode](#)".

24.5 [F173 PWMH] PWM Output Instruction (Frequency Specification)

24.5 [F173 PWMH] PWM Output Instruction (Frequency Specification)

Performs the PWM output according to the set parameters.

■ Instruction format

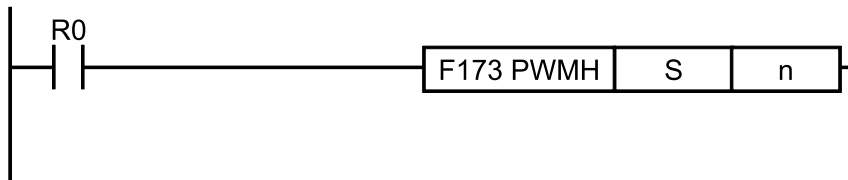

■ Operand

Operand	Settings	
	Starting address the memory area storing the parameters of the PWM output.	
S	S	Specify the control code HFF.
	S+1	Specify the output frequency in 2-word 32-bit data.
	S+2	Setting range: K1 to K100000 (1 Hz to 100 kHz: in 1 Hz increments)
	S+3	Duty ratio (Resolution of 1000 or 100) For the output frequencies 1 to K70000, Setting range: K0 to K1000 (0.0% to 100.0%) For the output frequencies K70001 to K100000, Setting range: K0 to K1000 (0% to 100%)
n	Channel nos. used for PWM output: FPOH mode: 0 (CH0: Y0), 1 (CH1: Y3), 2 (CH2: Y8), 3 (CH3: YB) FPsigma mode: 0 (CH0: Y0), 2 (CH2: Y3)	

■ Memory area type that can be specified

Operand	WX	WY	WR	WL	SV	EV	DT	LD	I	Constant		Index modifier
										K	H	
S	-	-	-	-	-	-	•	-	-	-	-	•
n	-	-	-	-	-	-	-	-	-	•	•	-

■ Outline of operation

- The PWM output is performed from a specified output. The output is performed when the trigger (execution condition) is on.
- The output frequency and duty ratio is specified in the operands [S1+1] to [S1+3].

■ Precautions during programming

- This instruction cannot be executed when a control flag corresponding to each channel is on.
- The duty may be different from the set ratio according to the load voltage and load current especially in the vicinity of minimum and maximum values. The duty can be changed for each scan. However, the control code cannot be changed during the execution of an instruction.

24.5 [F173 PWMH] PWM Output Instruction (Frequency Specification)

- When rewriting during RUN is performed during the operation, the PWM output stops while a program is being rewritten.

■ Example of program

The following sample shows the program for performing the PWM output with 10 kHz and the duty ratio of 50% from CH0 (Y0).

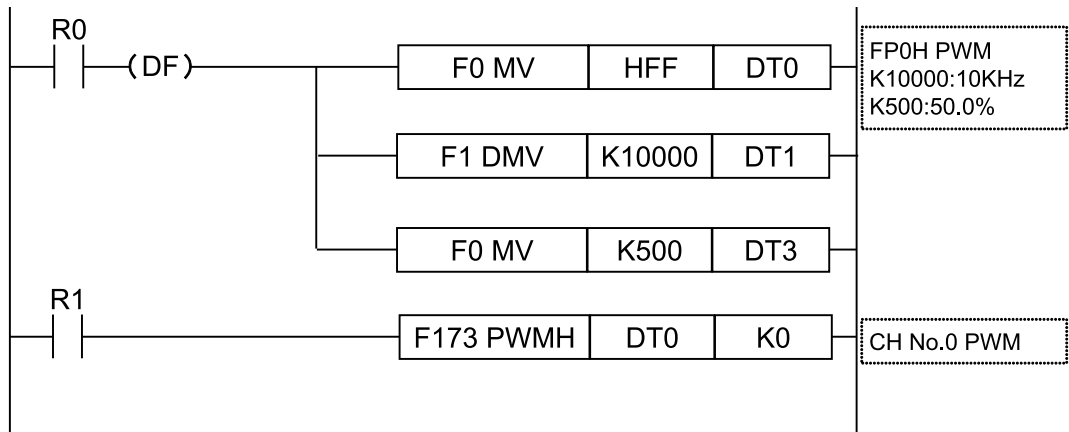

i Info.

- For details of the allocations of I/O and flags, refer to "[38.5.3 When Using PWM Output Function](#)".
- For details of the FPsigma mode, refer to "[38.6 FPsigma Mode](#)".

24.6 [F173 PWMH] PWM Output Instruction (Control Code Specification)

24.6 [F173 PWMH] PWM Output Instruction (Control Code Specification)

The PWM output is performed according to the set parameters.

■ Instruction format

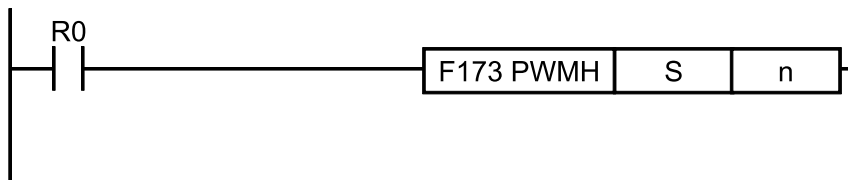

■ Operand

Operand	Settings
S	Starting address the memory area storing the parameters of the PWM output.
	S Specify the control code. K0 to K30
	S+1 Duty ratio (Resolution of 1000 or 100) For the control codes K0 to K27, Setting range: K0 to K1000 (0.0% to 100.0%) For the control codes K28 to K30, Setting range: K0 to K1000 (0% to 100%)
n	Channel nos. used for PWM output: FP0H mode: 0 (CH0: Y0), 1 (CH1: Y3), 2 (CH2: Y8), 3 (CH3: YB) FPsigma mode: 0 (CH0: Y0), 2 (CH2: Y3)

■ Memory area type that can be specified

Operand	WX	WY	WR	WL	SV	EV	DT	LD	I	Constant		Index modifier
										K	H	
S	-	-	-	-	-	-	•	-	-	-	-	•
n	-	-	-	-	-	-	-	-	-	•	•	-

■ Outline of operation

- The PWM output is performed from a specified output. The output is performed when the trigger (execution condition) is on.
- The output frequency and cycle are determined by a specified control code. The duty ratio is specified in the operand [S1+1].

■ Precautions during programming

- This instruction cannot be executed when a control flag corresponding to each channel is on.
- The duty may be different from the set ratio according to the load voltage and load current especially in the vicinity of minimum and maximum values. The duty can be changed for each scan. However, the control code cannot be changed during the execution of an instruction.
- When rewriting during RUN is performed during the operation, the PWM output stops while a program is being rewritten.

24.6 [F173 PWMH] PWM Output Instruction (Control Code Specification)

■ Control code

S	Frequency (Hz)	Cycle (ms)	Resolution	S	Frequency (Hz)	Cycle (ms)	Resolution	
K0	1.5	666.67	1000	K16	2000.0	0.50	1000	
K1	2.0	500.00		K17	3000.0	0.33		
K2	4.0	250.00		K18	6000.0	0.17		
K3	6.0	166.67		K19	12500.0	0.08		
K4	8.0	125.00		K20	15000.0	0.067		
K5	10.0	100.00		K21	20000.0	0.050		
K6	20.0	50.00		K22	25000.0	0.040		
K7	50.0	20.00		K23	30000.0	0.033		
K8	100.0	10.00		K24	40000.0	0.025		
K9	200.0	5.00		K25	50000.0	0.020		
K10	400.0	2.50		K26	60000.0	0.017		
K11	500.0	2.00		K27	70000.0	0.0143		
K12	700.0	1.48		K28	80000.0	0.0125		
K13	1000.0	1.00		K29	90000.0	0.0111		100
K14	1300.0	0.77		K30	100000.0	0.010		
K15	1600.0	0.625	-	-	-	-		

■ Example of program

The following sample shows the program for performing the PWM output with 1kHz and the duty ratio of 50% from CH0 (Y0).

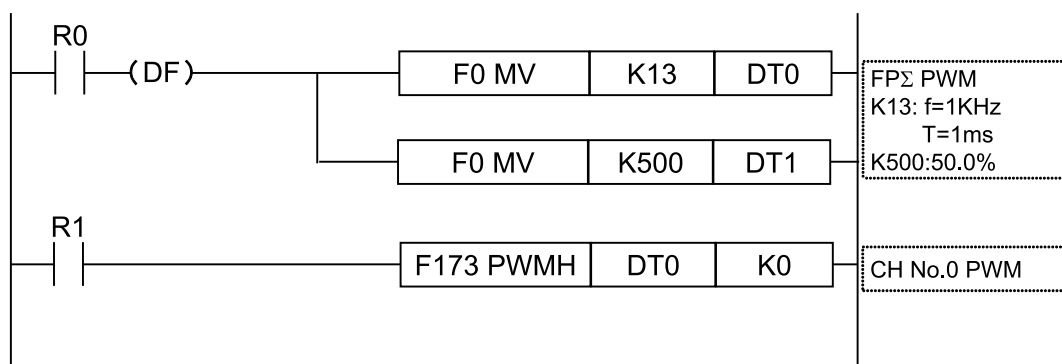

i Info.

- For details of the allocations of I/O and flags, refer to "38.5.3 When Using PWM Output Function".
- For details of the FPsigma mode, refer to "38.6 FPsigma Mode".

(MEMO)

25 Character String Instructions

25.1 F95 ASC (Character Constant to ASCII Code Conversion)	25-2
25.2 F250 BTOA (Multiple Binary Data to ASCII Data String Conversion).....	25-5
25.3 F251 ATOB (Multiple ASCII Data Strings to Binary Data Conversion).....	25-11
25.4 F252 ACHK (Multiple ASCII Data Strings ASCII Code Check).....	25-18
25.5 F253 SSET (Character Constant → ASCII Code Conversion: with Storage Area Size).....	25-20
25.6 F254 PRINT (Create Text)	25-24
25.6.1 F254 PRINT Instruction Conversion Form Table	25-32
25.7 Overview of String Instructions F257 SCMP to F265 SREP.....	25-37
25.8 F257 SCMP (Comparing Character Strings)	25-38
25.9 F258 SADD (Character String Addition)	25-40
25.10 F259 LEN (Character String Length)	25-42
25.11 F260 SSRC (Search for Character String).....	25-44
25.12 F261 RIGHT (Right Retrieve from Character String).....	25-46
25.13 F262 LEFT (Left Retrieve from Character String).....	25-48
25.14 F263 MIDR (Read from Any Position in Character String)	25-50
25.15 F264 MIDW (Write to Any Position in Character String).....	25-52
25.16 F265 SREP (Replace Character Strings)	25-54

25.1 F95 ASC (Character Constant to ASCII Code Conversion)

25.1 F95 ASC (Character Constant to ASCII Code Conversion)

Converts the specified character constants into ASCII codes.

■ Instruction format

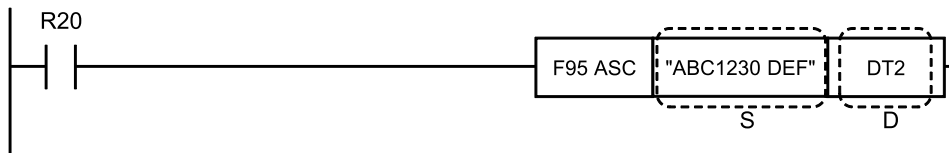

■ Operands

Items	Settings
S	Character constants (12 characters)
D	Number at the start of the area storing the ACSII codes

■ Devices that can be specified (indicated by ●)

Operands	WX	WY	WR	WL	SV	EV	DT	LD	I	SWR	SDT	Constant				Index modifier	Integer Device	
												K	H	M	f			
S																		
D		●	●	●	●	●	●	●	●									

■ Outline of operation

The character constants specified by [S] (12 characters) are converted into ASCII codes and stored in the 6-word area starting from [D].

■ Operation example

Operation of instruction format description program

When internal relay R20 turns ON, the specified character constants (ABC1230 DEF) are converted into ASCII codes and stored in DT2 to DT7.

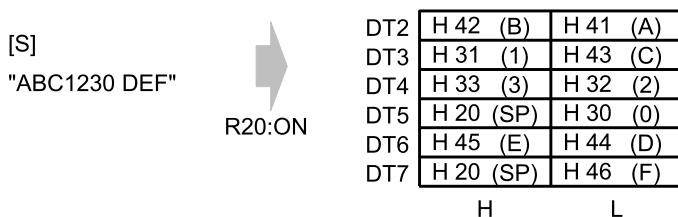

If the number of character constants specified by [S] is less than 12, the blanks in the destination storage area are filled with spaces (H20).

■ Precautions for programming

The character constant M can only be input by programming tool software.

Conversion example

25.1 F95 ASC (Character Constant to ASCII Code Conversion)

When converting one letter (A), there are three possible input methods.

1. At the start of the specified character constants (1st character)
2. At the end of the specified character constants (12th character)
3. In the middle of the specified character constants (2nd to 11th character)

(1) At the start (1st character)

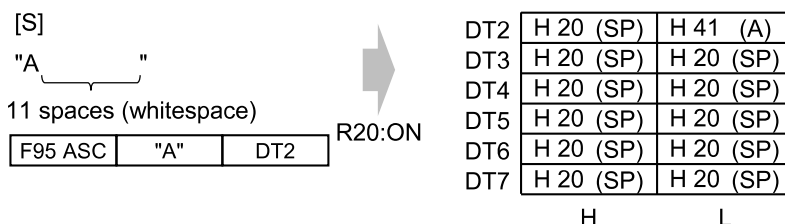

The letter is input as above. A is only input to the low byte of DT2. The blanks are all filled with spaces (H20) in the destination storage area.

(2) At the end (12th character)

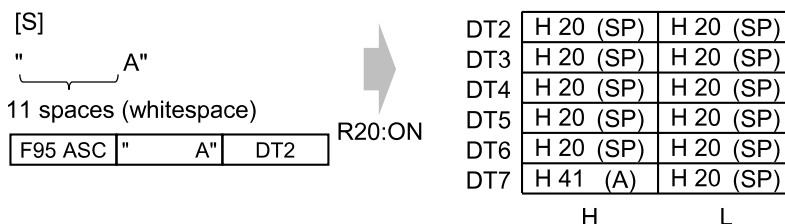

The letter is input as above. A is only input to the high byte of DT7. DT2 to DT6 and the low byte of D27 are all filled with spaces (H20) in the destination storage area.

(3) In the middle (7th character)

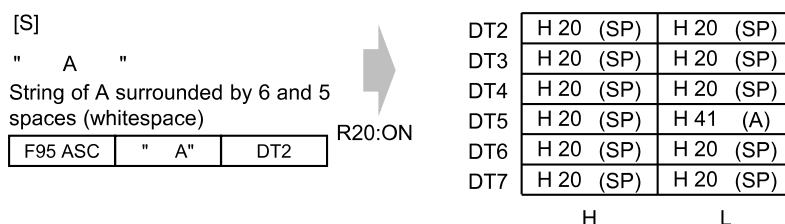

The letter is input as above. A is only input to the low byte of DT5. The rest of the destination storage area is filled with spaces (H20).

25.1 F95 ASC (Character Constant to ASCII Code Conversion)

■ Reference: JIS8 code table

								0	0	0	0	0	0	0	0	1	1	1	1	1	1	1	1	1			
								0	0	0	0	1	1	1	1	0	0	0	0	1	1	1	1	1			
								0	0	1	1	0	0	1	1	0	0	1	1	0	0	1	1	0	1		
								0	1	0	1	0	1	0	1	0	1	0	1	0	1	0	1	0	1		
b ₇	b ₆	b ₅	b ₄	b ₃	b ₂	b ₁	b ₀	Column Row	0	1	2	3	4	5	6	7	8	9	A	B	C	D	E	F			
0	0	0	0	0	0	0	0	NUL	TC ₇ (DEL)	(SP)	0	@	P	~	p	↑	↑	Undefined	-	タ	ミ	↑	↑				
0	0	0	1	1				TC ₁ (SOH)	DC ₁	!	1	A	Q	a	q				。	ア	チ	ム					
0	0	1	0	2				TC ₂ (STX)	DC ₂	"	2	B	R	b	r				「	イ	ツ	メ					
0	0	1	1	3				TC ₃ (ETX)	DC ₃	#	3	C	S	c	s				」	ウ	テ	モ					
0	1	0	0	4				TC ₄ (EOT)	DC ₄	\$	4	D	T	d	t				,	エ	ト	ヤ					
0	1	0	1	5				TC ₅ (ENQ)	TC ₅ (NAK)	%	5	E	U	e	u				・	オ	ナ	ユ					
0	1	1	0	6				TC ₆ (ACK)	TC ₆ (SYN)	&	6	F	V	f	v			Undefined	Undefined	フ	カ	ニ	ヨ				
0	1	1	1	7				BEL	TC ₁₀ (ETB)	'	7	G	W	g	w			Undefined	Undefined	ア	キ	ヌ	ラ				
1	0	0	0	8				EE ₉ (BS)	CAN	(8	H	X	h	x						イ	ク	ネ	リ			
1	0	0	1	9				EE ₁ (HT)	EM)	9	I	Y	i	y						ウ	ケ	ノ	ル			
1	0	1	0	A				EE ₂ (LF)	SUB	*	:	J	Z	j	z						エ	コ	ハ	レ			
1	0	1	1	B				EE ₃ (VT)	ESC	+	;	K	[k							オ	サ	ヒ	ロ			
1	1	0	0	C				EE ₄ (FF)	IS ₄ (FS)	,	<	L	¥	l							ヤ	シ	フ	ワ			
1	1	0	1	D				EE ₅ (CR)	IS ₃ (GS)	-	=	M]	m								ユ	ス	ヘ	ン		
1	1	1	0	E				SO	IS ₂ (RS)	.	>	N	^	n	-							ヨ	セ	ホ	。		
1	1	1	1	F				SI	IS ₁ (US)	/	?	O	_	o	DEL	↓	↓					ッ	ソ	マ	。	↓	↓

(Note 1) Only the character constants in the range indicated by in the table above can be input by programming tool software.

■ Flag operations

Name	Description
R9007 R9008 (ER)	Turns ON when the area exceeds the 6-word area starting from [D]

25.2 F250 BTOA (Multiple Binary Data to ASCII Data String Conversion)

Converts 16-bit/32-bit binary data to an ASCII code character string.

■ **Instruction format**

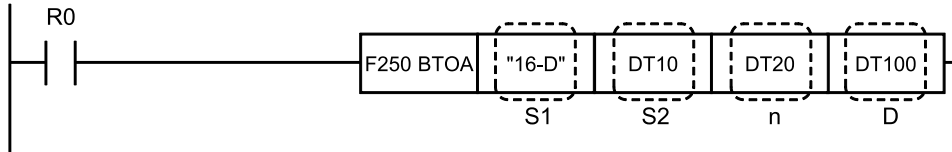

■ **Operands**

Items	Settings
S1	Control character string
S2	Starting number of area storing binary data
n	Conversion method
D	Starting number of the area storing the ASCII code of conversion result

■ **Devices that can be specified (indicated by ●)**

Operand s	WX	WY	WR	WL	SV	EV	DT	LD	I	SW R	SD T	Constant				Index modifier (Note 1)	Integer Device
												K	H	M	f		
S1	●	●	●	●	●	●	●	●	●	●	●				●		
S2	●	●	●	●	●	●	●	●	●	●	●					●	
n	●	●	●	●	●	●	●	●	●	●	●	●	●			●	
D		●	●	●	●	●	●	●	●							●	

(Note 1) A character constant cannot be specified.

■ **Outline of operation**

Converts the binary data stored in the area specified by S2 to ASCII data using the conversion method of n according to the 4 control characters specified by S1. The converted result is stored in the area specified by D.

■ **Specifying each item**

Specifying control character strings and their meanings [S1]

"16-D"	Converts 16-bit data to decimal ASCII data
"32-D"	Converts 32-bit data to decimal ASCII data
"16+H"	Converts 16-bit data to hexadecimal ASCII data (normal direction)
"32+H"	Converts 32-bit data to hexadecimal ASCII data (normal direction)
"16-H"	Converts 16-bit data to hexadecimal ASCII data (reverse direction)
"32-H"	Converts 32-bit data to hexadecimal ASCII data (reverse direction)

25.2 F250 BTOA (Multiple Binary Data to ASCII Data String Conversion)

(Note 1) Details of normal and reverse directions are described later

Specifying the conversion method [n]

Example of converting 16-bit data (K1234 and K56) to decimal ASCII codes

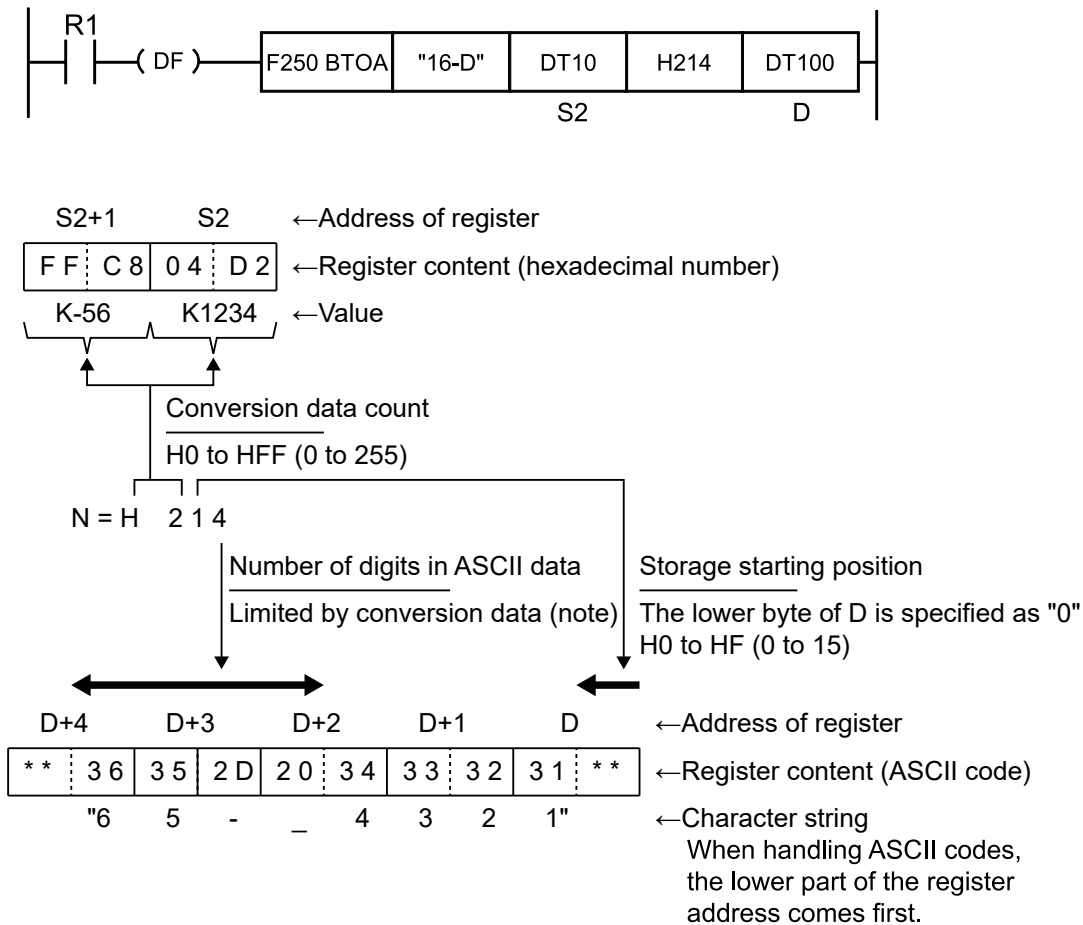

25.2 F250 BTOA (Multiple Binary Data to ASCII Data String Conversion)

Note

- Number of digits in ASCII data

When the number of digits of the ASCII data is larger than the converted result, a "_" (space) is stored before the data.

- When converting 16-bit data to hexadecimal ASCII data

Specified range: H1 to H4

When less than H4, the specified number of digits is stored from the lower bytes. If the digit number of the original data is larger with a specification less than H4, this is an error

- When converting 32-bit data to hexadecimal ASCII data

Specified range: H1 to H8

When less than H8, the specified number of digits is stored from the lower bytes. If the digit number of the original data is larger with a specification less than H8, this is an error

- When converting to decimal ASCII data

Specified range: H1 to HF

Source data is treated as signed binary data. When it is a negative number, the minus sign "-" is added.

About normal direction and reverse direction (only when converting to hexadecimal ASCII data)

■ Conversion example

- Converting 16-bit data (K1234 and K56) to decimal ASCII data

DT10 = K 1234 → "1234__56"
DT11 = K 56

Number of converted data is "2", starting position for storage is "0", and size of the storage area is "4"

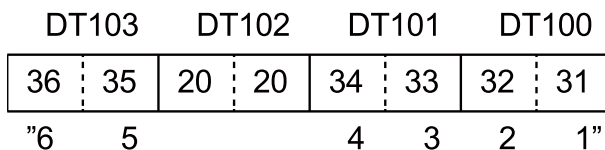
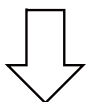
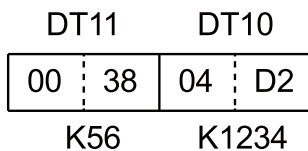
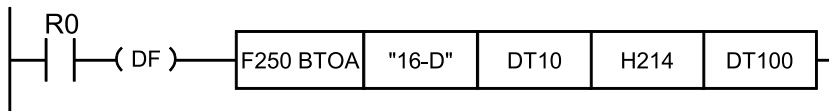

- Converting 32-bit data (K1234 and K56789) to decimal ASCII data

DT10,11 = K 1234 → "_ 1234__56789"

25.2 F250 BTOA (Multiple Binary Data to ASCII Data String Conversion)

DT12,13 = K 56789

Number of converted data is "2", starting position for storage is "1", and size of the storage area is "7"

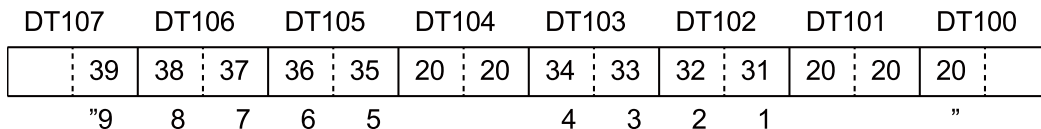
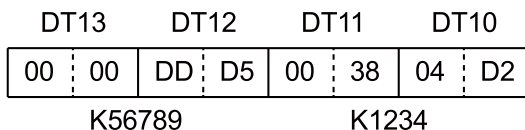

- Converting 16-bit data (H0123 and H89AB) to hexadecimal ASCII data

DT10 = H 123 → "2301AB89"

DT11 = H 89AB

Number of converted data is "2", starting position for storage is "1", and size of the storage area is "4" (normal direction)

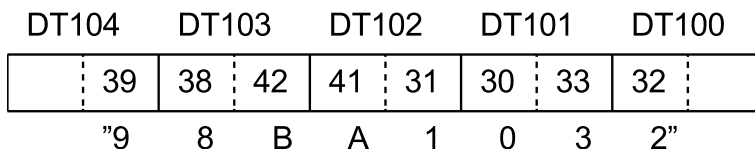
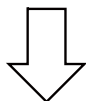
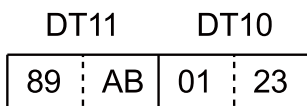
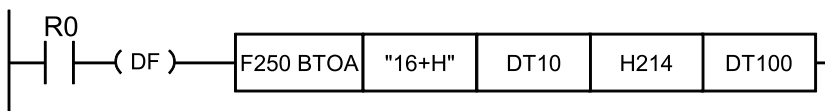

25.2 F250 BTOA (Multiple Binary Data to ASCII Data String Conversion)

For the reverse direction (when "16+H" is "16-H")

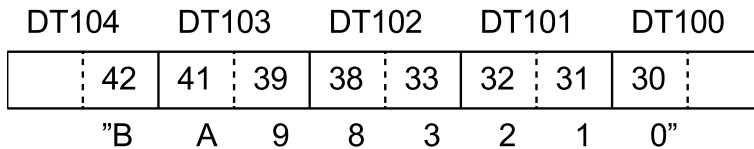

- Converting 32-bit data (H00000123 and H0089ABCD) to hexadecimal ASCII data (normal direction)

DT10,11 = H 123 → "230100CDAB89"
 DT12,13 = H 89ABCD

Number of converted data is "2", starting position for storage is "0", and size of the storage area is "6"

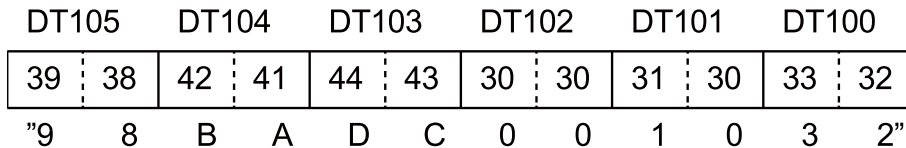
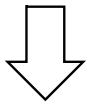
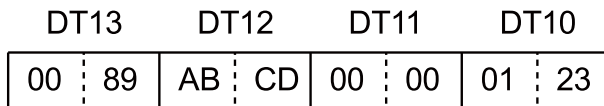
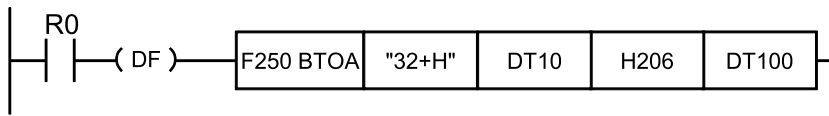

For the reverse direction (when "32+H" is "32-H")

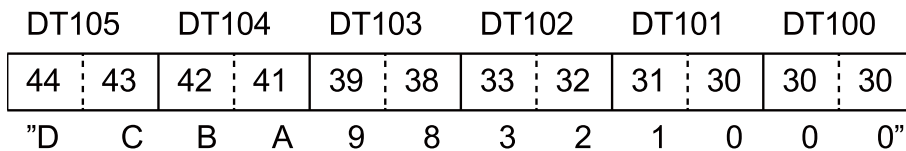

■ Flag operations

Name	Description
R9007 R9008 (ER)	When there is an error in the control string specified by S1
	When the conversion format specified by S1 is in decimal, and the direction of converted data is changed to the normal direction
	When the conversion format specified by S1 is in hexadecimal, and the size of the area for storing ASCII codes specified by N exceeds the rated value (Rated value for 16-bit data: 4) (Rated value for 32-bit data: 8)

25.2 F250 BTOA (Multiple Binary Data to ASCII Data String Conversion)

Name	Description
	When the number of the conversion data specified by N is 0
	When the converted result exceeds the size of the area for storing ASCII codes specified by N
	When the converted result exceeds the area
	When the area is exceeded in index modification

25.3 F251 ATOB (Multiple ASCII Data Strings to Binary Data Conversion)

Converts ASCII code character strings to 16-bit/32-bit binary data.

■ Instruction format

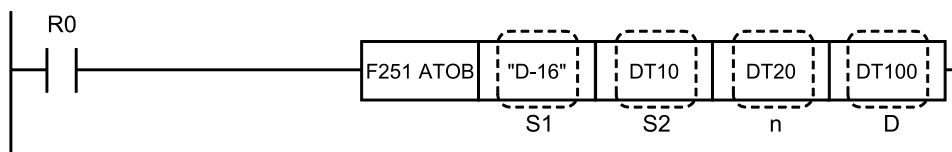

■ Operands

Items	Settings
S1	Control character string
S2	Starting number of the area storing the ASCII code
n	Conversion method
D	Starting number of the area for storing the binary data of the converted result

■ Devices that can be specified (indicated by ●)

Operand s	WX	WY	WR	WL	SV	EV	DT	LD	I	SW R	SD T	Constant				Index modifier (Note 1)	Integer Device
												K	H	M	f		
S1	●	●	●	●	●	●	●	●	●	●	●				●		
S2	●	●	●	●	●	●	●	●	●	●	●				●		
n	●	●	●	●	●	●	●	●	●	●	●	●	●		●		
D		●	●	●	●	●	●	●	●						●		

(Note 1) A character constant cannot be specified.

■ Outline of operation

Converts the ASCII data stored in the area specified by S2 to binary data using the conversion method in n, according to the four control characters specified in S1. The converted result is stored in the area specified by D.

■ Specifying each item

- Specifying control character strings and their meanings [S1]

		Range of data that can be handled
"D-16"	Convert decimal ASCII data to 16-bit data	-32,768 to +32767
"D-32"	Convert decimal ASCII data to 32-bit data	-2,147,483,648 to +2,147,483,647
"H+16"	Convert hexadecimal ASCII data to 16-bit data (forward direction)	0 to FFFF

25.3 F251 ATOB (Multiple ASCII Data Strings to Binary Data Conversion)

		Range of data that can be handled
"H+32"	Convert hexadecimal ASCII data to 32-bit data (forward direction)	0 to FFFFFFFF
"H-16"	Convert hexadecimal ASCII data to 16-bit data (reverse direction)	0 to FFFF
"H-32"	Convert hexadecimal ASCII data to 32-bit data (reverse direction)	0 to FFFFFFFF

(Note 1) Details of normal and reverse directions are described later

- Specifying the conversion method [n]

- Example of converting the ASCII data string "123456789012" to four sets of three decimal digits

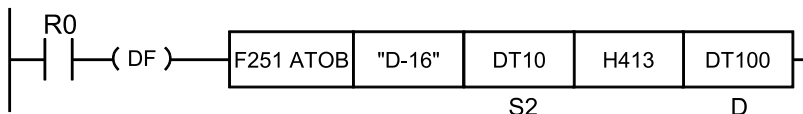
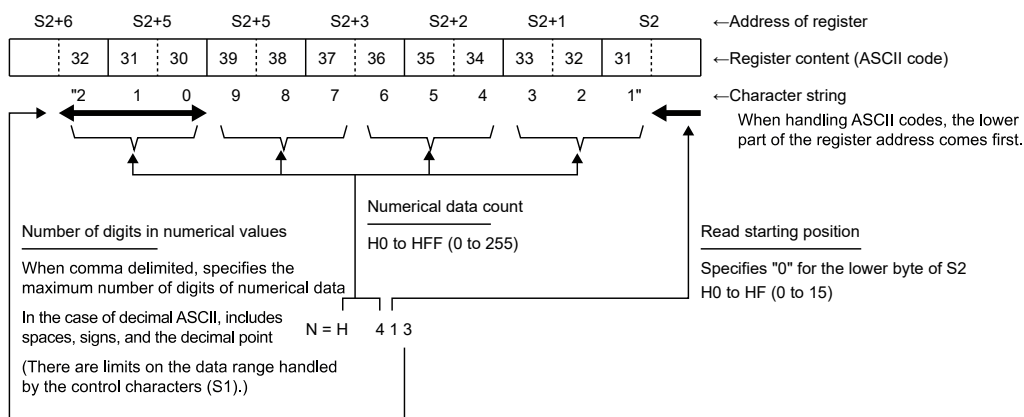

- When converting via the above program

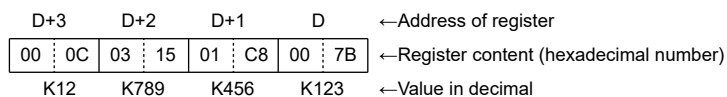

- About normal direction and reverse direction (only when converting to hexadecimal ASCII data)

For hexadecimal ASCII data, conversions in the forward and reverse directions are possible. Example of converting "0123456789ABCDEF"

25.3 F251 ATOB (Multiple ASCII Data Strings to Binary Data Conversion)

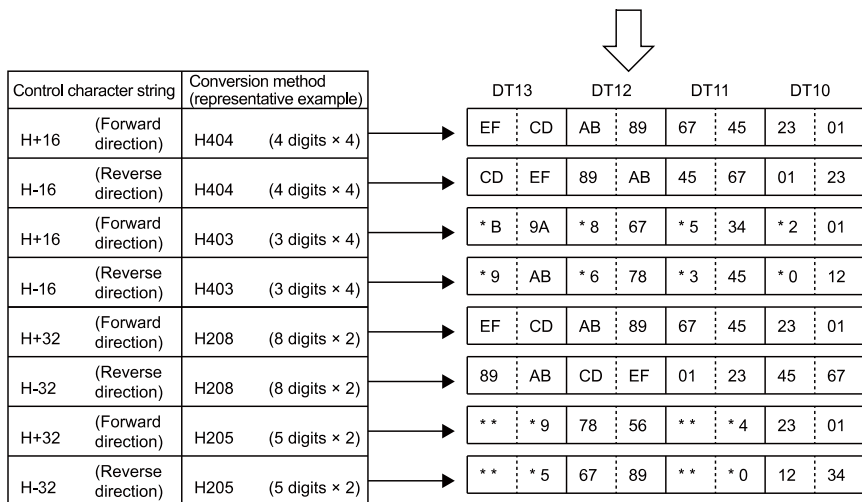
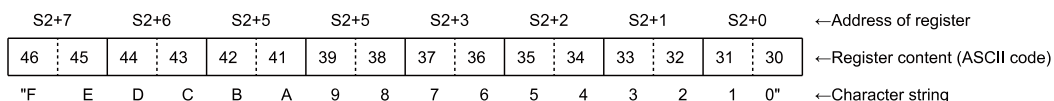

*"0" is entered to unused digits.

■ Conversion example

- Example of converting to four sets of three decimal digits (when there is no comma",")

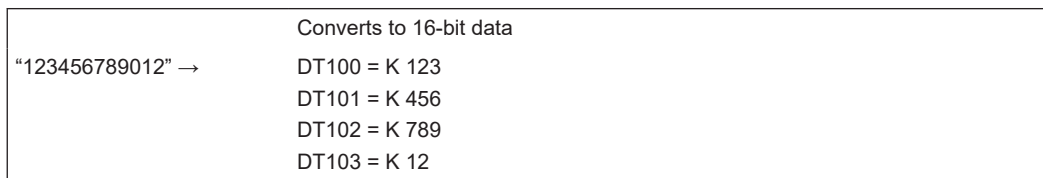

- When the number of numeric data items is "4", starting position for reading is "1", number of digits is "3"

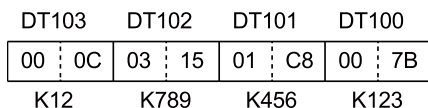
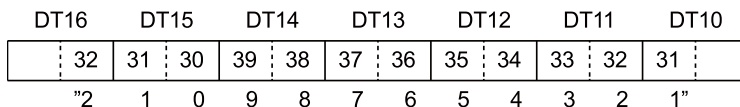
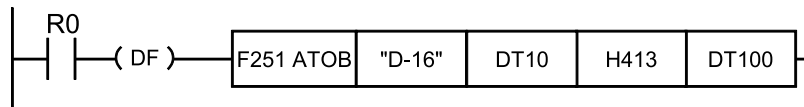

- When converting to 32-bit data (when "D-16" is "D-32")

25.3 F251 ATOB (Multiple ASCII Data Strings to Binary Data Conversion)

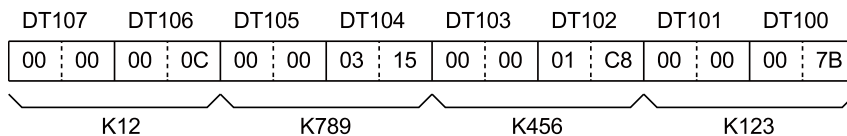

- Example of converting to three sets of four hexadecimal digits

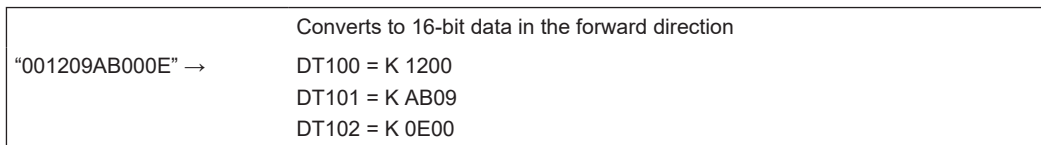

- When the number of numeric data items is "3", starting position for reading is "1", number of digits to be converted is "4"

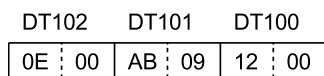
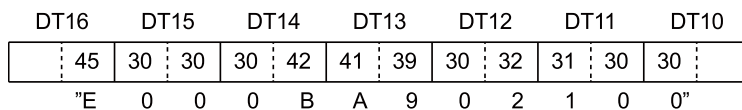
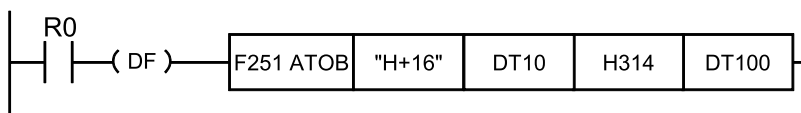

- When converting to 16-bit data in the reverse direction (when "H+16" is "H-16")

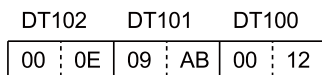

- When converting to 32-bit data in the forward direction (when "H+16" is "H+32")

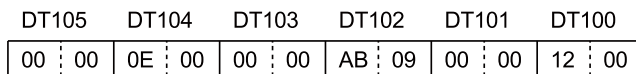

- When converting to 32-bit data in the reverse direction (when "H+16" is "H-32")

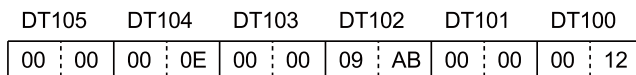

- Example of converting to four sets of decimal numbers (when there is a comma, "separator")

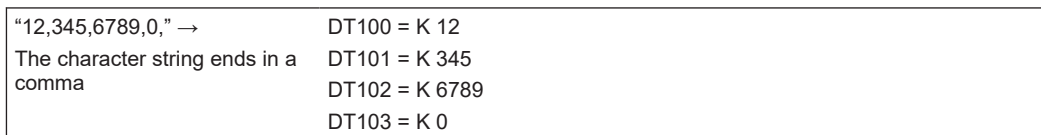

- When the number of numeric data items is "4", starting position for reading is "1", number of digits is "4" (Converts to 16-bit data)

25.3 F251 ATOB (Multiple ASCII Data Strings to Binary Data Conversion)

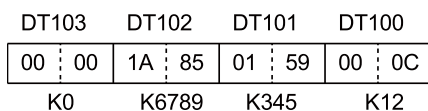
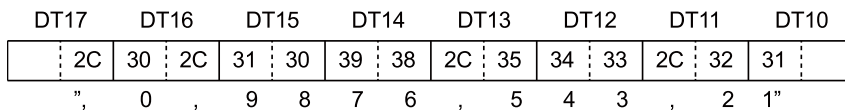
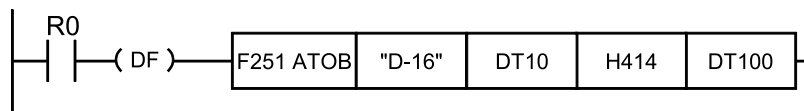

(Note 1) Specify the maximum number of digits.

- Example of converting to two sets of five decimal digits with decimal points (when there is no comma,")

"1234.50006.7" →	DT100 = K 12345
	DT101 = K 67

- When the number of numeric data items is "2", starting position for reading is "0", number of digits is "6", when converting to 16-bit data

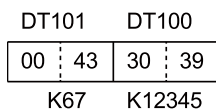
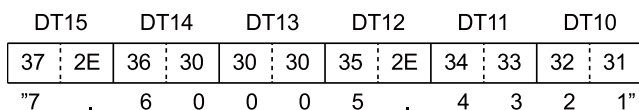
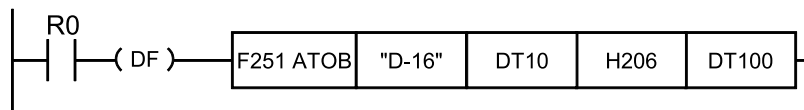

(Note 1) A decimal point is also counted as a digit

- Example of converting to two sets of decimal digits with decimal points (when there is a comma,"separator)

"1234.5,6.7" →	DT100 = K 12345
The character string ends in a comma	DT101 = K 67

25.3 F251 ATOB (Multiple ASCII Data Strings to Binary Data Conversion)

- When the number of numeric data items is "2", starting position for reading is "0", number of digits is "6", when converting to 16-bit data

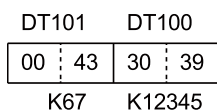
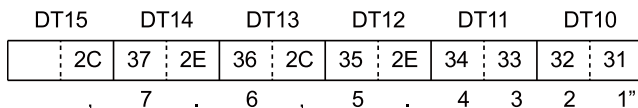
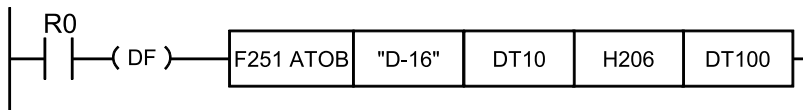

(Note 1) A decimal point is also counted as a digit

■ Particular examples

- If there is numeric data larger than the specified number of digits between commas (example: four sets of decimal numbers, and number of digits is four)

"1234, 567890, 12, 345" →	K 1234 K 5678 K90: The overflowed numbers become one numeric data K12 K345: Ignored
---------------------------	---

- If there is no value between commas (example: four sets of decimal numbers)

"123, 456,, 78" →	Operation error
-------------------	-----------------

- If there is only a decimal point between commas (example: three sets of decimal numbers with decimal points)

"1234. 5,,6.7" →	Operation error *If there is any number, for example "2." or ".2", it is converted
------------------	---

■ Flag operations

Name	Description
R9007 R9008 (ER)	When there is an error in the control string specified by S1
	When the conversion format specified by S1 is in decimal, and the direction of converted data is changed to the normal direction
	When the conversion format specified by S1 is hexadecimal, and the size of the area for storing ASCII codes specified by n exceeds the rated value (Rated value for 16-bit data: 4)

25.3 F251 ATOB (Multiple ASCII Data Strings to Binary Data Conversion)

Name	Description
	(Rated value for 32-bit data: 8)
	The ASCII code specified by S2 contains any code other than 0 to F, a sign, a space, a dot, or a comma
	The number of converted blocks specified by n is 0
	The size of the area for storing ASCII codes specified by n is 0
	The ASCII code to be converted exceeds the area
	When the converted result exceeds the area
	The converted result exceeds the converted data scale specified by n
	When the area is exceeded in index modification

25.4 F252 ACHK (Multiple ASCII Data Strings ASCII Code Check)

25.4 F252 ACHK (Multiple ASCII Data Strings ASCII Code Check)

Checks whether the specified ASCII data is correct.

■ Instruction format

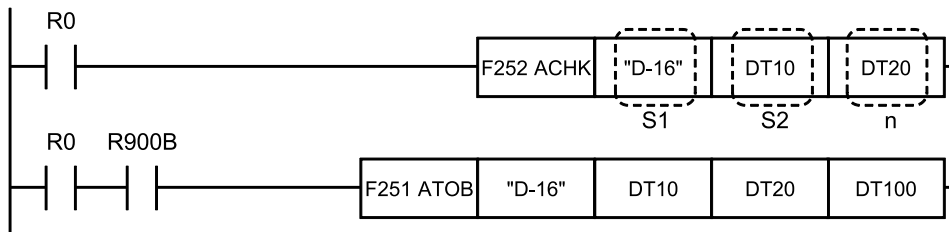

■ Operands

Items	Settings
S1	Area storing the control character string, or character string data
S2	Starting number of the area storing the ASCII code
n	Area storing the conversion method, or constant data

■ Devices that can be specified (indicated by ●)

Operands	WX	WY	WR	WL	SV	EV	DT	LD	I	SW R	SD T	Constant				Index modifier (Note 1)	Integer Device
												K	H	M	f		
S1	●	●	●	●	●	●	●	●	●	●	●			●			
S2	●	●	●	●	●	●	●	●	●	●	●						
n	●	●	●	●	●	●	●	●	●	●	●	●	●				

(Note 1) A character constant cannot be specified.

■ Outline of operation

- This instruction checks whether the ASCII code stored in the area specified by S2 can be correctly converted using the conversion method specified by n in accordance with the 4-character control characters specified by S1.
- It checks whether the character string to be converted by the F251 ATOB instruction can be converted.

This instruction can be executed before the character string is converted by the F251 ATOB instruction and if an error is found in the data, can control to not execute the F251 ATOB instruction. Specify S1, S2, and n to be the same values as in the F251 ATOB instruction. As a result of the check, the special relay R900B turns ON if the data is correct and OFF if there is an error.

■ Specifying each item

The method to specify S1, S2, and n is the same as for the F251 ATOB instruction, so refer to the description of F251 ATOB ASCII to Binary Conversion.

■ Flag operations

Name	Description
R9007 R9008 (ER)	When there is an error in the control string specified by S1
	When the conversion format specified by S1 is in decimal, and the direction of converted data is changed to the normal direction
	When the conversion format specified by S1 is hexadecimal, and the size of the area for storing ASCII codes specified by n exceeds the rated value (Rated value for 16-bit data: 4) (Rated value for 32-bit data: 8)
	The number of converted blocks specified by n is 0
	The size of the area for storing ASCII codes specified by n is 0
	The ASCII code to be converted exceeds the area
	When the area is exceeded in index modification

25.5 F253 SSET (Character Constant → ASCII Code Conversion: with Storage Area Size)

■ Instruction format

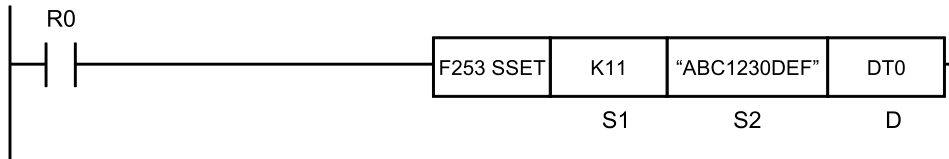

■ Operands

Items	Settings
S1	Storage area size (permissible range: K1 to K32767, H8000)
S2	Character constant to be converted (permissible range: 0 to 256 characters)
D	Starting device address of the destination

■ Devices that can be specified (indicated by ●)

Operands	WX	WY	WR	WL	SV	EV	DT	LD	I	SW R	SDT	Constant			Index modifier (Note 1)
												K	H	M	
S1	●	●	●	●	●	●	●	●	●			●	●		●
S2														●	
D		●	●	●	●	●	●	●	●						●

(Note 1) A character constant cannot be specified.

■ Outline of operation

- When **S1** (storage area size) is K1 to K32767:
The storage area size specified in **S1** is stored in **D**.
The character constant specified by **S2** is converted into ASCII code. The number of characters (1 word) is stored in **D+1**, and ASCII converted character data is stored in **D+2** and the subsequent area, in ascending order from lower bytes.
- When **S1** (storage area size) is H8000:
The character constant specified by **S2** is converted into ASCII code. The number of characters (1 word) is stored in **D**, and ASCII converted character data is stored in **D+1** and the subsequent area, in ascending order from lower bytes.
- A character constant is bracketed in "" (double quotation marks).
- Character constants can be set from 0 to 256 characters.
- A string that consists of "" (double quotation marks) only is regarded as NULL characters.
- NULL(00) is not added to the end of characters during setting.

■ Processing

Example 1) When a string "ABC1230 DEF" (11 characters including a space) is to be converted

S1...K12 S2... "ABC1230 DEF" D...DT0

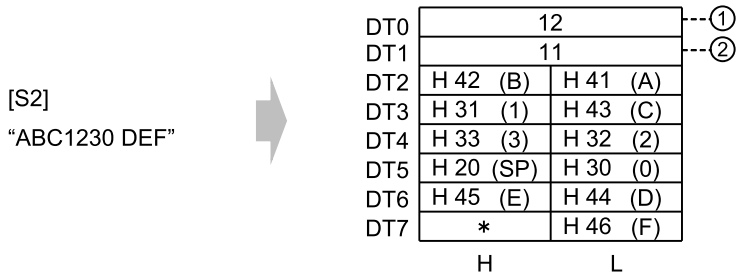

(Note 1) Data outside the range in the destination (*) (bytes higher than DT7) does not change.

(1)	Storage area size	(2)	Number of characters
-----	-------------------	-----	----------------------

Example 2) With the 16 characters from A to P as one set, when 16 sets (256 characters in total) are to be repeatedly converted

S1...K256 S2... "ABCDEF...KLMNOP" D...DT0

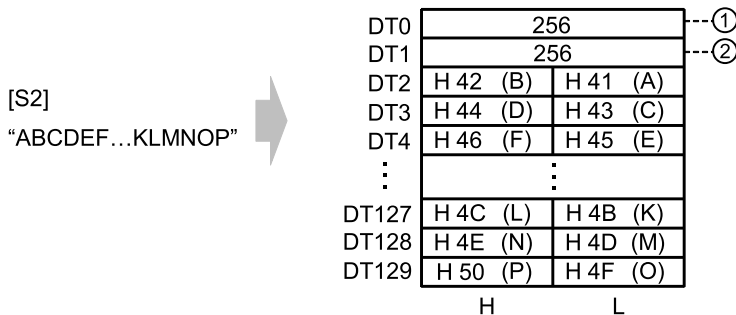

(1)	Storage area size	(2)	Number of characters
-----	-------------------	-----	----------------------

Example 3) A string of zero character bracketed by "" (i.e. double quotation marks in sequel) is converted

S1...K1 S2... "" D...DT0

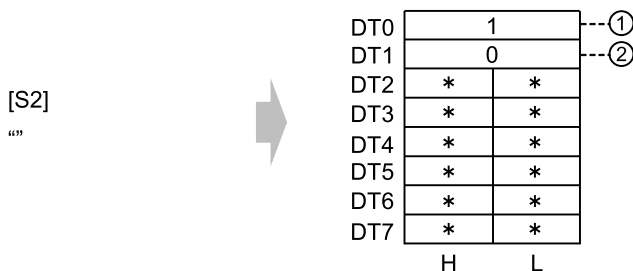

(Note 1) Data outside the range in the destination (*) (DT2 to DT7) does not change.

25.5 F253 SSET (Character Constant → ASCII Code Conversion: with Storage Area Size)

(1)	Storage area size	(2)	Number of characters
-----	-------------------	-----	----------------------

Example 4) When a string “ABC1230 DEF” (11 characters including a space) is to be converted

S1...H8000 S2... “ABC1230 DEF” D...DT0

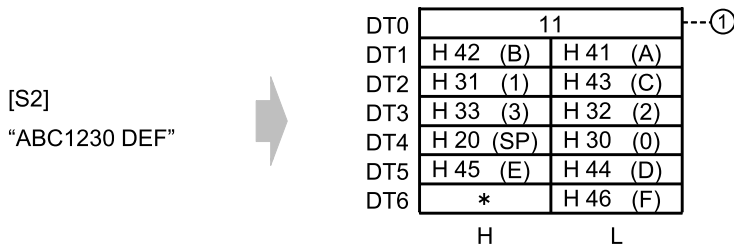

(Note 1) Data outside the range in the destination (*) (bytes higher than DT6) does not change.

(1)	No. of characters
-----	-------------------

Example 5) With the 16 characters from A to P as one set, when 16 sets (256 characters in total) are to be repeatedly converted

S1...H8000 S2... “ABCDEF...KLMNOP” D...DT0

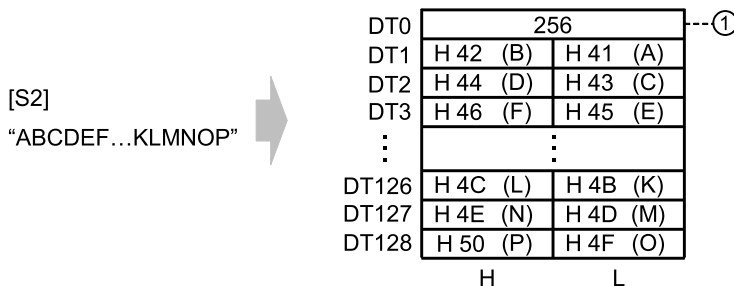

(1)	No. of characters
-----	-------------------

Example 6) A string of zero character bracketed by “” (i.e. double quotation marks in sequel) is to be converted

S1...H8000 S2... “” D...DT0

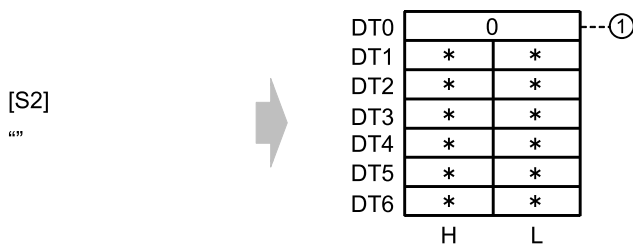

(Note 1) Data outside the range in the destination (*) (DT1 to DT6) does not change.

(1)	No. of characters
-----	-------------------

■ Flag operations

Name	Description
R9007 R9008 (ER)	Turns ON when the area is exceeded in index modification.
	Turns ON when the accessible range is exceeded if the storage area size starting with D is secured.
	Turns ON when a value outside the permissible range is specified for S1 .
	Turns ON when the number of characters is larger than the storage area size.

25.6 F254 PRINT (Create Text)

25.6 F254 PRINT (Create Text)

Specifies the create text form and the data to be output in text format and creates text in ASCII code. The F254 PRINT instruction can be used with the unit firmware Ver. 1.7 or later.

■ Instruction format

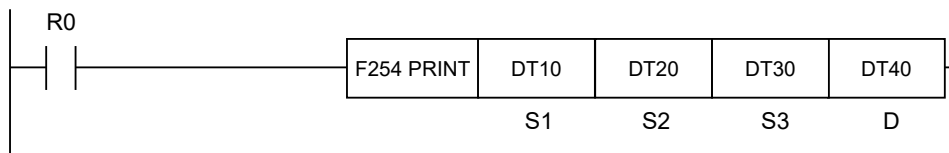

■ Operands

Items	Settings
S1	S1: Storage area size (Settable range: K1 to K32767, H8000)
S2	Starting address of the device storing the string data which indicates the create text form or a character constant
S3	Starting address of the device storing the data to be output in text format
D	Starting address of the device storing the text

■ Devices that can be specified (indicated by ●)

Operands	WX	WY	WR	WL	SV	EV	DT	LD	I	SW R	SDT	Constant			Index modifier
												K	H	M	
S1	●	●	●	●	●	●	●	●	●			●	●		●
S2	●	●	●	●	●	●	●	●	●					●	
S3	●	●	●	●	●	●	●	●	●						●
D		●	●	●	●	●	●	●	●						●

■ Outline of operation

- Creates text in ASCII code using the device's data specified in **S3**.
- The text is created according to the create text form specified in **S2**.
- The data to be stored varies depending on the value in **S1**.

When S1 (storage area size) is K1 to K32767:

The storage area size specified in **S1** is stored in **D**.

The number of characters (1 word) is stored in **D+1**, and created text data is stored in **D+2** and the subsequent area, in ascending order from lower bytes.

When S1 (storage area size) is H8000:

The number of characters (1 word) is stored in **D**, and created text data is stored in **D+1** and the subsequent area, in ascending order from lower bytes.

■ Operand S1 setting

- Specify the storage area size. (Settable range: 1 to 32767)

- When not specifying the storage area size, specify H8000.

■ Operand S2 setting

- Specify the address of the device storing the create text form or a character constant (maximum 256 characters).
- The create text form consists of a body text, conversion form (%d, %e, etc.), line break code (\n), and tab code (\t).
- The create text form can be specified up to 4096 characters. An operation error occurs when it exceeds 4096 characters.
- The number of digits of a conversion form can be specified up to 16 digits per form. An operation error occurs when it exceeds 16 digits.
- The number of characters of one data after conversion is a maximum of 32 characters excluding %s and %S. An operation error occurs when it exceeds 32 characters.
- The number of characters of %s and %S after conversion is a maximum of 4096 characters.
- All the character strings that are not recognized as conversion form are treated as the body text.

Example:

- Conversion forms that do not allow upper case characters (%D, etc.)
- Character strings that contain characters not recognized as discriminant characters of conversion forms (%A, %Z, etc.)
- When entering “%” in the body text, specify “%%” (two percent symbols).

Example of the create text form

The data specified in **S3** according to the conversion form is stored in the place where a conversion form is described.

- Refer to "25.6.1 F254 PRINT Instruction Conversion Form Table" for conversion forms.
- The line break code (\n) is converted to CR (0Dh) + LF (0Ah).
- The tab code (\t) is converted to HT (09h).

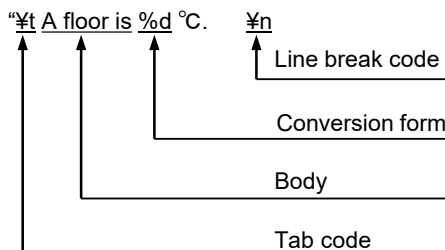

■ Operand S3 setting

- Specify the starting address of the device storing the data to be output in the create text form.
- Place the conversion data in the order specified by the conversion form.

Example 1: When S1 (storage area size) is H8000

The character data for %s and %S specifies data that starts with the number of characters (half-width). It can be set using the SSET instruction.

25.6 F254 PRINT (Create Text)

SSET H8000 "AB12" DT110

S1 = H8000

S2 = "%d %u %x %b %f %e %g %s"

S3 = DT100

Transfer result: -1 32767 FFFF 1000 123.4567 1.234567e+02 123.457 AB12

DT100	K-1	Data for %d	
DT101	K32767	Data for %u	
DT102	HFFFF	Data for %x	
DT103	H1000	Data for %b	
DT104	SF123.4567	Data for %f	
DT105			
DT106	SF123.4567	Data for %e	
DT107			
DT108	SF123.4567	Data for %g	
DT109			
DT110	4	Data for %s	
DT111	H42(B)	No. of bytes Data part	H41(A)
DT112	H32(2)		H31(1)

Example 2: When S1 (storage area size) is K1 to K32767

The character data for %s and %S specifies data that starts with the storage area size and the number of characters (half-width). It can be set using the SSET instruction.

SSET H4 "AB12" DT110

S1 = H4

S2 = "%d %u %x %b %f %e %g %s"

S3 = DT100

Transfer result:

DT100	K-1	Data for %d	
DT101	K32767	Data for %u	
DT102	HFFFF	Data for %x	
DT103	H1000	Data for %b	
DT104	SF 123.4567	Data for %f	
DT105			
DT106	SF 123.4567	Data for %e	
DT107			
DT108	SF 123.4567	Data for %g	
DT109			
DT110	4	Data for %s	
DT111	4	Storage area size	
DT112	H42(B)	No. of bytes Data part	H41(A)
DT113	H32(2)		H31(1)

■ Setting examples

Example 1: When creating the following text

- Text image

Floor A humidity: 25 %.
Floor B humidity: 28 %.

- Set value

S1=K50

S2="Floor A humidity: %d %%.%nFloor B humidity: %d %%%"

S3=DT100

D=DT200

DT100	K 25
DT101	K 28
DT102	



DT200	50 (Storage area size)	
DT201	48 (Number of characters)	
DT202	H6C(l)	H46(F)
DT203	H6F(o)	H6F(o)
DT204	H20(SPACE)	H72(r)
DT205	H20(SPACE)	H41(A)
DT206	H75(u)	H68(h)
DT207	H69(i)	H6D(m)
DT208	H69(i)	H64(d)
DT209	H79(y)	H74(t)
DT210	H20(SPACE)	H3A(:)
DT211	H35(5)	H32(2)
DT212	H25(%)	H20(SPACE)
DT213	H0D(CR)	H2E(.)
DT214	H46(F)	H0A(LF)
DT215	H6F(o)	H6C(l)
DT216	H72(r)	H6F(o)
DT217	H42(B)	H20(SPACE)
DT218	H68(h)	H20(SPACE)
DT219	H6D(m)	H75(u)
DT220	H64(d)	H69(i)
DT221	H74(t)	H79(y)
DT222	H3A(:)	H20(SPACE)
DT223	H32(2)	H20(SPACE)
DT224	H20(SPACE)	H38(8)
DT225	H2E(.)	H25(%)
DT226	(Note 1)	(Note 1)

(Note 1) The data outside the transfer range does not change.

25.6 F254 PRINT (Create Text)

Example 2: When creating the following text

•Text image

Production volume: 5

•Set value

S1=H8000

S2="Production volume: %d"

S3=DT1

D=DT50

DT1	K5
DT2	
DT3	



DT150	20 (Number of characters)	
DT151	H72(r)	H50(P)
DT152	H64(d)	H6F(o)
DT153	H63(c)	H75(u)
DT154	H79(i)	H84(t)
DT155	H6E(n)	H6F(o)
DT156	H76(v)	H20(SPACE)
DT157	H6C(l)	H6F(o)
DT158	H6D(m)	H75(u)
DT159	H3A(:)	H65(e)
DT160	H35(5)	H20(SPACE)

Example 3: When creating the following text

•Text image

Normal operation

•Set value

S1=K18

S2="¥tNormal operation"

S3=DT1

D=DT50

DT1	(Note 1)
DT2	(Note 1)
DT3	(Note 1)



DT150	18 (Storage area size)	
DT151	17 (Number of characters)	
DT152	H4E(N)	H09(HT)
DT153	H72(r)	H6F(o)
DT154	H61(a)	H6D(m)
DT155	H20(SPACE)	H6C(l)
DT156	H70(p)	H6F(o)
DT157	H72(r)	H65(e)
DT158	H74(t)	H61(a)
DT159	H6F(o)	H69(i)
DT160	(注2)	H6E(n)

(Note 1) Since there is no specification for the conversion form, the S3 value is not set.

(Note 2) The data outside the transfer range does not change.

Example 4: When creating the following text

• Text image

Location: Nagoya, Aichi

• Set value

S1=H8000

S2="Location: %s, %s"

S3=DT1

D=DT50

DT1	K6	
DT2	H61(a)	H4E(N)
DT3	H6F(o)	H67(g)
DT4	H61(a)	H79(y)
DT5	K5	
DT6	H69(i)	H41(A)
DT7	H68(h)	H63(c)
DT8	(Note 1)	H69(i)



DT50	23 (Number of characters)	
DT51	H6F(o)	H4C(L)
DT52	H61(a)	H63(c)
DT53	H69(i)	H74(t)
DT54	H6E(n)	H6F(o)
DT55	H20(SPACE)	H3A(:)
DT56	H61(a)	H4E(n)
DT57	H6F(o)	H67(g)
DT58	H61(a)	H79(y)
DT59	H20(SPACE)	H2C(,)
DT60	H69(i)	H41(A)
DT61	H68(h)	H63(c)
DT62	(Note 2)	H69(i)

(Note 1) Indefinite value

(Note 2) The data outside the transfer range does not change.

25.6 F254 PRINT (Create Text)

Example 5: When the specified number of characters is larger than the number of characters

•Text image

Location: [_ _ Nagoya], [Aichi_ _ _] (Note 1) (Note 2)

Right align

Left align

•Set value

S1=K30

S2="Location: %-8s, %8s"

S3=DT1

D=DT50

DT1	K6	
DT2	K6	
DT3	H61(a)	H4E(N)
DT4	H6F(o)	H67(g)
DT5	H61(a)	H79(y)
DT6	K6	
DT7	K5	
DT8	H69(i)	H41(A)
DT9	H68(h)	H63(c)
DT10	(Note 3)	H69(i)



DT50	30 (Storage area size)	
DT51	28 (Number of characters)	
DT52	H6F(o)	H4C(L)
DT53	H61(a)	H63(c)
DT54	H69(i)	H74(t)
DT55	H6E(n)	H6F(o)
DT56	H20(SPACE)	H3A(:)
DT57	H20(SPACE)	H20(SPACE)
DT58	H61(a)	H4E(n)
DT59	H6F(o)	H67(g)
DT60	H61(a)	H79(y)
DT61	H20(SPACE)	H2C(,)
DT62	H69(i)	H41(A)
DT63	H68(h)	H63(c)
DT64	H20(SPACE)	H69(i)
DT65	H20(SPACE)	H20(SPACE)
DT66	(Note 4)	(Note 4)

(Note 1) The default of %s is left align.

(Note 2) (_) represents a space.

(Note 3) Indefinite value

(Note 4) The data outside the transfer range does not change.

Example 6: When the created text exceeds the storage area size specified in D and CY is set

•Text image

Nagoya humidity : 25 %

 (Note 1)

•Set value

S1=K20

S2="%s humidity : %d %%"

S3=DT1

D=DT50

DT1	K8	
DT2	K6	
DT3	H61(a)	H4E(N)
DT4	H6F(o)	H67(g)
DT5	H61(a)	H79(y)
DT6	(Note 2)	(Note 2)
DT7	K25	



DT50	20 (Storage area size)	
DT51	20 (Number of characters)	
DT52	H61(a)	H4E(N)
DT53	H6F(o)	H67(g)
DT54	H61(a)	H79(y)
DT55	H68(h)	H20(SPACE)
DT56	H6D(m)	H75(u)
DT57	H64(d)	H69(i)
DT58	H74(t)	H69(i)
DT59	H20(SPACE)	H79(y)
DT60	H20(SPACE)	H3A(:)
DT61	H35(5)	H32(2)

(Note 1) The characters beyond the storage area size are not set.

(Note 2) Indefinite value

(Note 3) CY (R9009) is set.

Example 7: When keeping the position of data after the character string unchanged, use %S.

•Text image

Nagoya humidity : 25 %

•Set value

S1=H8000

S2="%S humidity : %d %%"

S3=DT1

D=DT50

DT1	K10	
DT2	H61(a)	H4E(N)
DT3	H6F(o)	H67(g)
DT4	H61(a)	H79(y)
DT5	(Note 1)	H00(NULL)
DT6	(Note 1)	(Note 1)
DT7	K25	



DT50	22 (Number of characters)	
DT51	H61(a)	H4E(N)
DT52	H6F(o)	H67(g)
DT53	H61(a)	H79(y)
DT54	H68(h)	H20(SPACE)
DT55	H6D(m)	H75(u)
DT56	H64(d)	H69(i)
DT57	H74(t)	H69(i)
DT58	H20(SPACE)	H79(y)
DT59	H20(SPACE)	H3A(:)
DT60	H35(5)	H32(2)
DT61	H25(%)	H20(SPACE)

(Note 1) Indefinite value

(Note 2) For details of %S, refer to "25.6.1 F254 PRINT Instruction Conversion Form Table".

25.6 F254 PRINT (Create Text)

■ Flag operations

Name	Description
R9007 R9008 (ER)	Turns ON when the area is exceeded in index modification.
	Turns ON when the accessible range is exceeded if the storage area size starting with D is secured.
	Turns ON when a value outside the settable range is specified for S1 .
	Turns ON when conversion data that is not real number is specified for the conversion form specified to be real number.
	Turns ON when the size that is specified with conversion forms other than %s or %S exceeds 32 characters.
	Turns ON when the create text form exceeds 4096 characters.
R9009	Turns ON when the text exceeds 4096 bytes.
	Turns ON when the created text exceeds the storage area size specified in D .

25.6.1 F254 PRINT Instruction Conversion Form Table

■ Specification of the control string S2

Specifies the conversion data type, number of characters, precision, etc. using the string data of the following formats.

Depending on the conversion data type, various option items such as insertion of a sign or space can be selected.

[S2] = “ % + 12.5 L d , “

Optional specification (1)

- 0 : Zero padding
- + : Addition of the sign (plus sign)
- ␣ : Insertion of a space
- : Left align (Default is right align.)
- # : Addition of a character by conversion data

Number of characters and precision after conversion

Specify total number of characters (n) and the number of characters of precision (m) as “n.m”, “n”, or “.m”. The number of characters of precision (m) varies depending on the conversion data type.

Conversion data type	m: Number of characters of precision
d, Ld, i, Li, u, Lu, x, Lx, b, Lb	Represents the number of characters of a numerical string.
f, Lf, e, Le, E, LE	Represents the number of characters below the decimal point.
g, Lg, G, LG	Represents the number of effective digits.

Optional specification (2)

- , : Addition of comma sign
- BCD : Addition of a suffix
- H : Addition of a suffix

Conversion data type (1)

- d : Signed integer → Decimal ASCII
- u : Unsigned integer → Decimal ASCII
- x : Unsigned integer → Hexadecimal ASCII
- b : BDC integer → Hexadecimal ASCII
- f : Floating point real number
→ Floating point notation ASCII
- e : Floating point real number
→ Exponential notation ASCII
- g : Floating point real number
→ Floating point notation or exponential notation ASCII
- s : String data → ASCII

Conversion data type (2)

- L: Specify this for 32-bit integer data or 64-bit integer data.

■ Conversion form table

Conversion form	Before conversion Binary data	After conversion ASCII data	Usage example
"%d" or "%i"	16-bit data (signed integer)	Decimal ASCII data	"%d", "%5d", "%+5d", "%-5d", "%05d", "%10.5d", "% d"
"%Ld" or "%Li"	32-bit data (signed integer)	Decimal ASCII data	"%Ld", "%5Ld", "%+5Ld", "%-5Ld", "%05Ld", "%10.5Ld", "% Ld"
"%u"	16-bit data (unsigned integer)	Decimal ASCII data	"%u", "%5u", "%-5u", "%05u", "%10.5u"
"%Lu"	32-bit data (unsigned integer)	Decimal ASCII data	"%Lu", "%5Lu", "%-5Lu", "%05Lu", "%10.5Lu"
"%x"	16-bit data	Hexadecimal ASCII data	"%x", "%5x", "%-5x", "%05x", "%10.5x", "%#x", "%X"
"%Lx"	32-bit data	Hexadecimal ASCII data	"%Lx", "%5Lx", "%-5Lx", "%05Lx", "%10.5Lx", "%#Lx", "%LX"
"%b"	16-bit BCD data	Decimal ASCII data	"%b", "%5b", "%-5b", "%05b", "%10.5b"
"%Lb"	32-bit BCD data	Decimal ASCII data	"%Lb", "%5Lb", "%-5Lb", "%05Lb", "%10.5Lb"
"%f"	32-bit single-precision real number data	Floating point number ASCII data	"%f", "%5.2f", "%+5.2f", "%-5.2f", "%05.2f", "%#f", "% f"
"%e"	32-bit single-precision real number data	Exponential notation ASCII data	"%e", "%5.2e", "%+5.2e", "%-5.2e", "%05.2e", "%#5.2e", "% e", "%E"
"%g"	32-bit single-precision real number data	exponential notation ASCII data or floating-point ASCII data (shorter one that can be expressed)	"%g", "%5.2g", "%+5.2g", "%-5.2g", "%05.2g", "%#5.2g", "%G"
"%s"	String data	String data (for the specified number of characters)	"%s", "%5s", "%-5s", "%-05s"
"%S"	String data	String data (converted for the specified number of characters or up to 0x00)	"%S", "%5S", "%-5S", "%-05S"

(Note 1) The number of conversion digits of a conversion form can be specified up to 16 digits.

(Note 2) Conversion modifier 'L' can also specified in a lower case character.

■ Conversion form S2 option (BIN data to ASCII data)

Items	Conversion form	Before conversion Binary data	After conversion ASCII data	Description
Specification of upper / lower case characters	%x	HABCD	"abcd"	Specifies upper or lower case alphabets used for hexadecimal / exponential notation ASCII data.
	%X	HABCD	"ABCD"	
	%e	SF1234.567	"1.234567e+03"	Upper case characters used for %d, %u, %b, %f, or %s are treated as body text data.
	%E	SF1234.567	"1.234567E+03"	

25.6 F254 PRINT (Create Text)

Items	Conversion form	Before conversion Binary data	After conversion ASCII data	Description
				When specifying the number of display digits with [f , e , E], be sure to specify the number of characters below the decimal point.
Specification of the number of display digits	%d	K100	"100"	Specify the number of display digits by specifying "total number of characters" and "number of characters of precision". If not specified, the default is used. It is specified with "n.m", "n", or ".m", etc. n: Total number of characters, m: Number of characters of precision <Number of characters of precision> <ul style="list-style-type: none"> [d , ld , i , Li , u , Lu , x , Lx , X , LX , b , Lb] represents the number of characters of numerical strings. [f , e , E] represents the number of characters below the decimal point. [g , G] represents the number of effective digits.
	%5d	K100	"_100"	
	%10.5d	K100	"____00100"	
	%x	H12A	"12a"	
	%5x	H12A	"_12a"	
	%10.5x	H12A	"____0012a"	
	%b	H123	"123"	
	%5b	H123	"_123"	
	%f	SF123.4567	"123.4567"	
	%8.3f	SF123.4567	"_123.457"	
	%e	SF1234.567	"1.234567e+03"	
	%10.3e	SF1234.567	"_1.235e+03"	
	%g	SF1234.567	"1234.57"	
%8.6g	SF1234.567	"_1234.57"		
Specification of zero padding	%05d	K100	"00100"	When the setting for the display digit is available, zero padding can be specified. Put zero (0) before the display digit.
	%05x	H12A	"0012a"	
	%05b	H123	"00123"	
	%08.3f	SF123.4567	"0123.457"	
	%010.3e	SF1234.567	"01.235e+03"	
Specification of right align and left align	%-5d	K100	"100_"	Default is right align. To set to left align, add minus (-) before the specified number of digits.
	%-5x	H12A	"12a_"	
	%-5b	H123	"123_"	
	%-8.3f	SF123.4567	"123.457_"	
	%-010.3e	SF1234.567	"1.235e+03_"	
Specification of sign	%+d	K100	"+100"	To add a plus sign (+), add (+). A plus sign (+) is not added by default. Even if (+) is added when specifying %u, %x, %b or %s, it will not be reflected in the results. Example: %+u K100 → Output data is "100", and the sign is not added.
	%+d	K-100	"-100"	
	%+5d	K100	"_+100"	
	%+8.3f	SF123.4567	"_+123.457"	
	%+10.3e	SF1234.567	"_+1.235e+03"	
Specification of numerical position	_%d	K100	"_100"	In the case of a positive number, a space is added to align the position in the case of a negative number. When aligning the position, add a blank space.
	_%d	K-100	"-100"	
	_%8.3f	SF123.4567	"_123.457"	

Items	Conversion form	Before conversion Binary data	After conversion ASCII data	Description	
	%_8.3f	SF-123.4567	"-123.457"	Even if space () is added when specifying %u, %x, %b or %s, it will not be reflected in the results. Example: %_u K100 → Output data is "100", and the blank space is not added.	
	%_10.3e	SF1234.567	"_1.235e+03"		
	%_10.3e	SF-1234.567	"-1.235e+03"		
Specification of another output format for numerical data type	##x	H12A	"0x12a"	Add "0x".	By adding (#), another output format is automatically added. Even if (#) is added when specifying %u, %x, %b or %s, it will not be reflected in the results. Example: ##u K100 → Output data is "100", and the output format is not changed.
	##X	H12A	"0X12A"	Add "0X".	
	##8.0f	SF123.45678	"____123."	Be sure to add ".".	
	##10.0e	SF1234.5678	"____1.e+03"		
	##10.0E	SF1234.5678	"____1.E+03"		
	##9.0g	SF1234	"_1.e+03"	Be sure to add ".", and do not omit "0" that follows the decimal point.	
	##.9G	SF1234	"1234.00000"		

(Note 1) () represents a space.

(Note 2) When both (+) and () are used at the same time and if () comes before (+), both "sign indication" and "specification of numerical position" are not reflected. If (+) comes before (), "sign indication" is reflected. This is the same for all form where (+) and () are applied.

Example 1: %_+d K100 → Output data is "100" with no space or sign.

Example 2: %+_d K100 → Output data is "+100" with (+) sign.

■ Processing when conversion forms are combined (BIN data to ASCII data)

Conversion form	Before conversion Binary data	After conversion ASCII data	Remarks
%-10.3e	SF123.4567	"1.235e+02_"	The exponent is output with at least two digits.
%+u	K1234	"1234"	Even if a plus sign (+) is contained in the conversion form when specifying %u, %x, %b or %s, it will not be reflected in the results.
% u	K1234	"1234"	Even if a space () is contained in the conversion form when %u, %x, %b or %s is specified, it will not be reflected in the results.
##u	K1234	"1234"	Even if (#) is contained in the conversion form when specifying %u, %x, %b or %s, it will not be reflected in the results.
%_+d	K1234	"1234"	When both (+) and () are used at the same time and if () comes before (+), both "sign indication" and "specification of numerical position" are not reflected. If (+) comes before (), "sign indication" is reflected.
%+_d	K1234	"+1234"	

25.6 F254 PRINT (Create Text)

Conversion form	Before conversion Binary data	After conversion ASCII data	Remarks
			Example 1: %_+d K100 → Output data is "100" with no space or sign. Example 2: %+_d K100 → Output data is "+100" with (+) sign.

(Note 1) () represents a space.

■ Conversion form S2 option (String data to ASCII data)

Items	Conversion form	Before conversion Character data	After conversion ASCII data	Description
Specification of the number of display digits	%s	"abcdef"	"abcdef"	The default of "%s" is left align.
	%10s	"abcdef"	"abcdef_..."	The number of digits of "%s" is counted as halfwidth character. A fullwidth character needs two digits. When the number of digits is insufficient, an operation error occurs. If the decimal part is specified with "%s", the setting after (.) is not reflected. Example: %10.5s → Outputs 10-character data (%10s).
	%10.5s	"abcdef"	"abcdef_..."	
Specification of zero padding	%-010s	"abcdef"	"0000abcdef"	
	%010s	"abcdef"	"abcdef_..."	
Specification of right align and left align	%-10s	"abcdef"	"_...abcdef"	Default is right align. To set to left align, add minus (-) before the specified number of digits.

(Note 1) () represents a space.

25.7 Overview of String Instructions F257 SCMP to F265 SREP

■ Data table structure

The character string data table sets the character string size, number of characters, and character data.

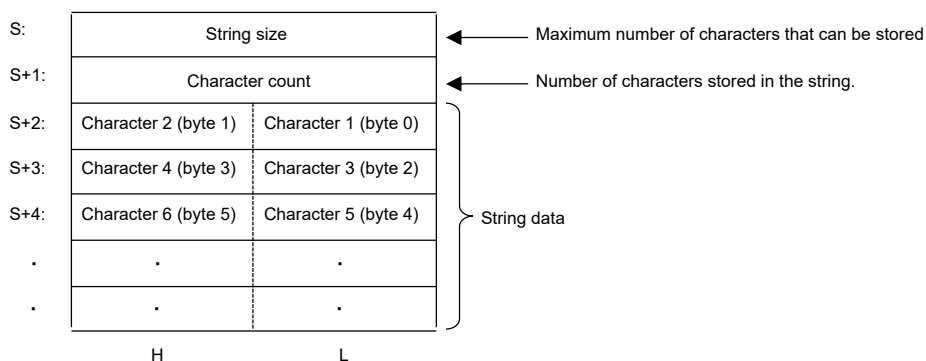

e.g. When a [character string size (20 characters), number of characters (12 characters), character data "ABCDEFGHJKLM"] data table is specified for DT0

The F253 SSET instruction is used to set the character string data table.

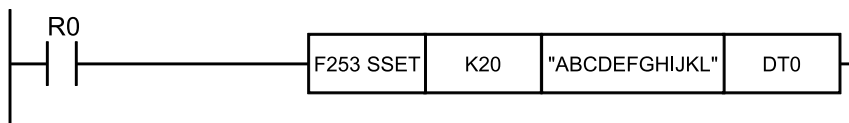

DT0	20	
DT1	12	
DT2	"B"	"A"
DT3	"D"	"C"
DT4	"F"	"E"
DT5	"H"	"G"
DT6	"J"	"I"
DT7	"L"	"K"
	H	L

25.8 F257 SCMP (Comparing Character Strings)

25.8 F257 SCMP (Comparing Character Strings)

Compares two specified character strings, and outputs the judgment result to a special internal relay.

■ Instruction format

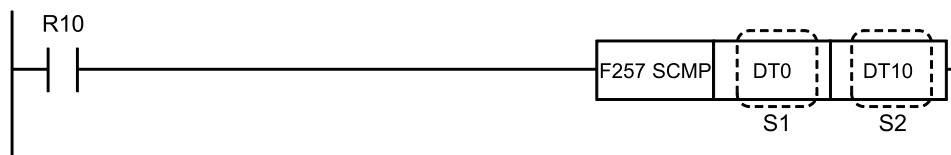

■ Operands

Items	Settings
S1	Character string 1 for comparison
S2	Character string 2 for comparison

■ Devices that can be specified (indicated by ●)

Operands	WX	WY	WR	WL	SV	EV	DT	LD	I	SWR	SDT	Constant				Index modifier	Integer Device
												K	H	M	f		
S1	●	●	●	●	●	●	●	●	●	●	●					●	
S2	●	●	●	●	●	●	●	●	●	●	●					●	

■ Outline of operation

- The character string specified for [S1] is compared to the character string specified for [S2], and the judgment result is output to special internal relays R9009 to R900C (judgment flags for comparison instructions).
- R9009 to R900C are assigned based on whether [S1] or [S2] is larger or smaller, as shown in the table below.

Relationship of S1 and S2	Flag			
	R900A	R900B	R900C	R9009
	>	=	<	Carry
S1 < S2	OFF	OFF	ON	Indefinite
S1 = S2	OFF	ON	OFF	OFF
S1 > S2	ON	OFF	OFF	Indefinite

■ Operation example

Operation of instruction format description program

When internal relay R10 is ON, data registers DT1 and DT11 are compared. In this case, it is determined that [S1] < [S2], and R900C turns ON.

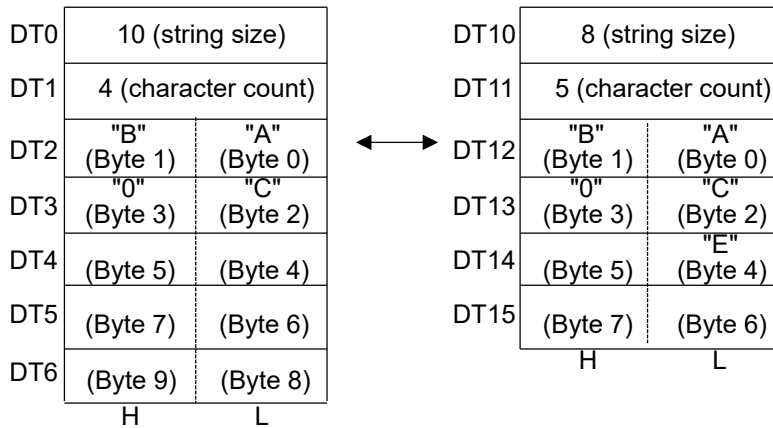

■ **Precautions for programming**

- If the number of characters is different, the greater/lesser relationship is as shown below.

S1	Greater/lesser	S2
"ABCDE"	=	"ABCDE"
"ABCD"	<	"ABCDE"
"B"	>	"ABCDE"

- Comparison of character strings is performed in sequence from byte 0, one character at a time.
- If one character string has fewer characters than the other, it may still be handled as larger if a large character code is used when the comparison is made.
e.g. "B">"ABCDE"
- To specify a character string, indicate the number of the area in which the character string size and number of characters have been specified. For detailed information about the table configuration of the data area, refer to "P.25-37".

■ **Flag operations**

Name	Description
R9007	Turns ON when the area is exceeded in index modification.
R9008 (ER)	Turns ON when number of characters is greater than the character string size

25.9 F258 SADD (Character String Addition)

25.9 F258 SADD (Character String Addition)

Concatenates one character string with another.

■ Instruction format

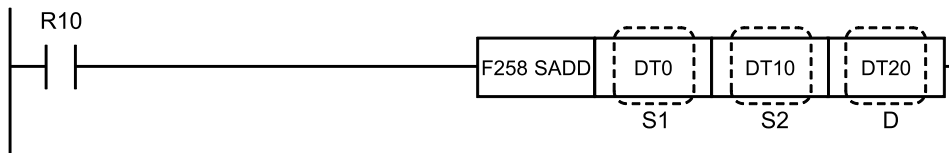

■ Operands

Items	Settings
S1	Character string to be concatenated
S2	Character string to be concatenated
D	Area in which the concatenated character strings are stored

■ Devices that can be specified (indicated by ●)

Operands	WX	WY	WR	WL	SV	EV	DT	LD	I	SWR	SDT	Constant				Index modifier	Integer Device
												K	H	M	f		
S1	●	●	●	●	●	●	●	●	●	●	●					●	
S2	●	●	●	●	●	●	●	●	●	●	●					●	
D		●	●	●	●	●	●	●	●							●	

■ Outline of operation

- The character string specified by [S1] is concatenated with the character string specified by [S2], and the result is stored in the character string specified by [D].
- At the start of the area for storing results [D], specify the character string size via the user program.

■ Operation example

Operation of instruction format description program

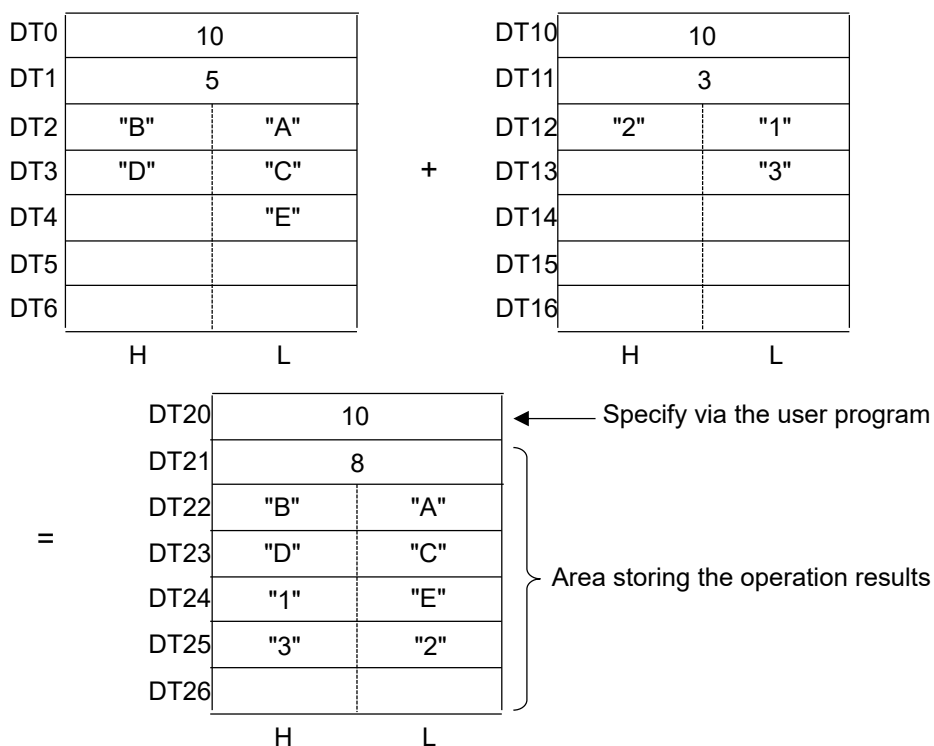

■ Precautions for programming

If the result of the concatenation operation is larger than the character string size of [D], only as many characters as will fit in [D] are stored.

■ Flag operations

Name	Description
R9007	Turns ON when the area is exceeded in index modification.
R9008 (ER)	Turns ON when number of characters is greater than the character string size
R9009 (CY)	Turns ON when the operation result is greater than the size of the character string specified by [D]

25.10 F259 LEN (Character String Length)

25.10 F259 LEN (Character String Length)

Determines the number of characters stored in a character string.

■ Instruction format

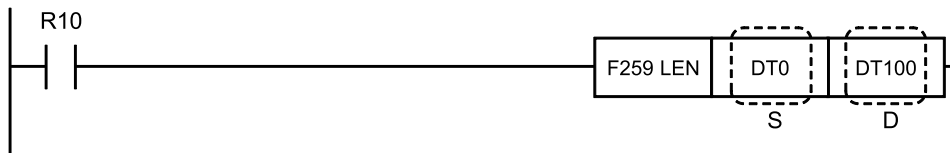

■ Operands

Items	Settings
S	Character string
D	Area that stores the number of characters in the calculation result

■ Devices that can be specified (indicated by ●)

Operands	WX	WY	WR	WL	SV	EV	DT	LD	I	SWR	SDT	Constant				Index modifier	Integer Device
												K	H	M	f		
S	●	●	●	●	●	●	●	●	●	●	●					●	
D	●	●	●	●	●	●	●	●	●							●	

■ Outline of operation

The number of characters in the character string specified by [S] is determined, and the result is stored in [D].

■ Operation example

Operation of instruction format description program

DT0	10	
DT1	8	
DT2	"B"	"A"
DT3	"D"	"C"
DT4	"1"	"E"
DT5	"3"	"2"
DT6		

H L

= DT100 8

■ Precautions for programming

If the number of characters is greater than the character string size, an operation error occurs.

■ Flag operations

Name	Description
R9007	Turns ON when the area is exceeded in index modification.
R9008 (ER)	Turns ON when number of characters is greater than the character string size

25.11 F260 SSRC (Search for Character String)

25.11 F260 SSRC (Search for Character String)

Searches for the specified character string.

■ Instruction format

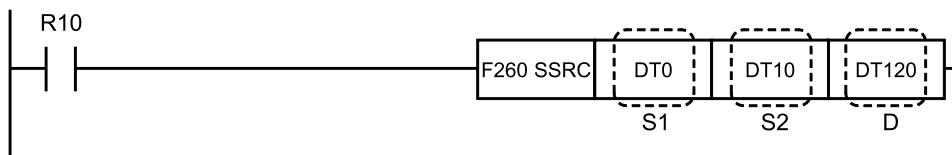

■ Operands

Items	Settings
S1	Area storing the character data to be searched (character string or character constant)
S2	Character string to be searched
D	Area storing the search result

■ Devices that can be specified (indicated by ●)

Operands	WX	WY	WR	WL	SV	EV	DT	LD	I	SWR	SDT	Constant				Index modifier	Integer Device
												K	H	M	f		
S1	●	●	●	●	●	●	●	●	●	●	●					●	
S2	●	●	●	●	●	●	●	●	●	●	●					●	
D		●	●	●	●	●	●	●	●							●	

■ Outline of operation

- The character data specified by [S1] is searched for the character string specified by [S2].
- The number of characters that are the same based on the search result is stored in [D] and the first matching relative position (in byte units) is stored in [D+1].

■ Operation example

Operation of instruction format description program

The characters in DT0 are searched from the character string in DT10 and the result is stored in DT120.

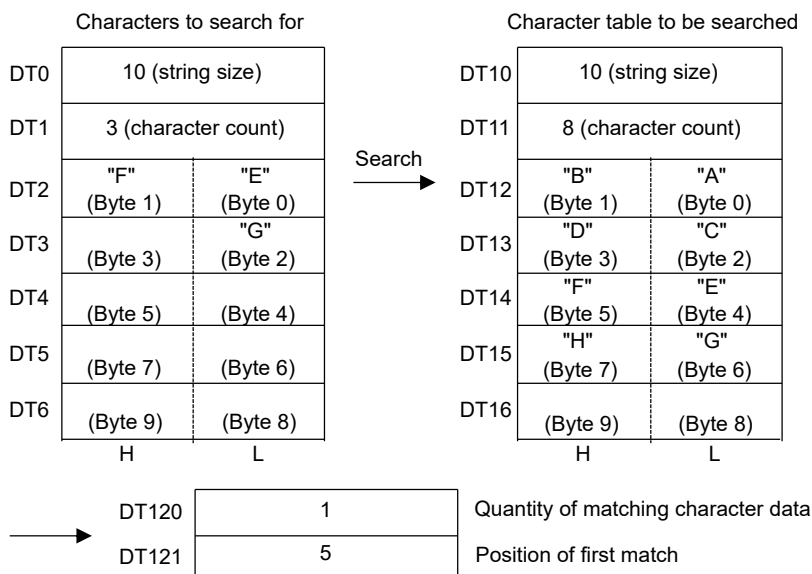

■ Precautions for programming

- Specify a number of characters so that [S1] is less than or equal to [S2].
- For [S1+1], the number of characters in the character string on the search side, specify a value for the number of characters to be searched.

e.g.

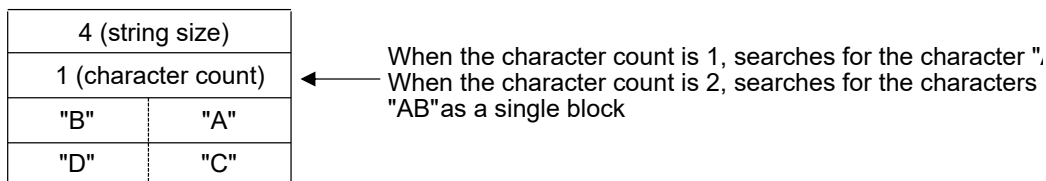

■ Flag operations

Name	Description
R9007	Turns ON when the area is exceeded in index modification.
R9008 (ER)	Turns ON when number of characters is greater than the character string size

25.12 F261 RIGHT (Right Retrieve from Character String)

25.12 F261 RIGHT (Right Retrieve from Character String)

Retrieves a character string with the specified number of characters from the right side of a character string.

■ Instruction format

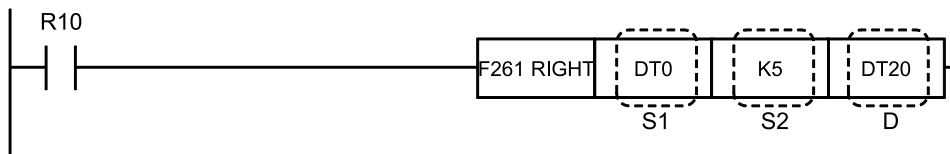

■ Operands

Items	Settings
S1	Character string
S2	Area storing the number of characters, or constant data
D	Area storing the character string

■ Devices that can be specified (indicated by ●)

Operands	WX	WY	WR	WL	SV	EV	DT	LD	I	SW R	SD T	Constant				Index modifier	Integer Device
												K	H	M	f		
S1	●	●	●	●	●	●	●	●	●	●	●					●	
S2	●	●	●	●	●	●	●	●	●	●	●	●	●			●	
D		●	●	●	●	●	●	●	●							●	

■ Outline of operation

- The number of characters specified by [S2] are retrieved from the right side of the character string (the end of character data) specified by [S1], and are transferred to the character string specified by [D].
- At the start of the area for storing results [D], specify the character string size via the user program.

■ Operation example

Operation of instruction format description program

Five characters are retrieved from the end of character string DT0 and transferred to DT20.

25.12 F261 RIGHT (Right Retrieve from Character String)

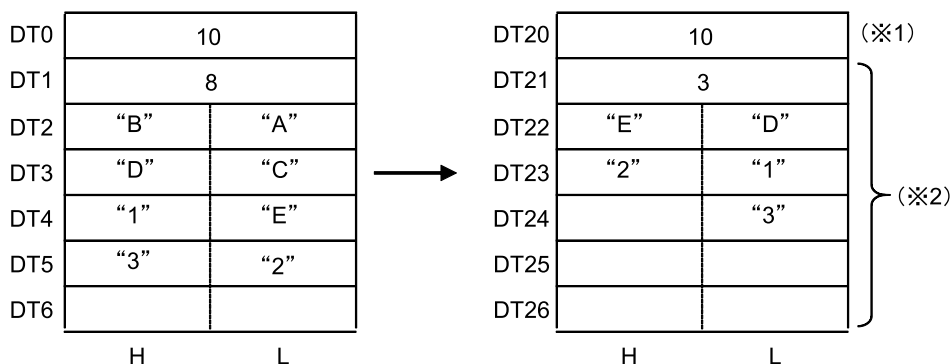

(*1): Specify via the user program

(*2): Area storing the operation results

■ Precautions for programming

- The character data of [D] prior to the operation is cleared.
- If the number of characters in [S2] is greater than the number of characters in the [S1] character string, the number of characters of the [S1] character string is sent.
- If the number of characters specified by [S2] is greater than the size of the character string specified by [D], then the number of characters equal to the size of the character string specified by [D] are transferred.

■ Flag operations

Name	Description
R9007	Turns ON when the area is exceeded in index modification.
R9008 (ER)	Turns ON when number of characters is greater than the character string size
R9009 (CY)	Turns ON when the operation result is greater than the size of the character string specified by [D]

25.13 F262 LEFT (Left Retrieve from Character String)

25.13 F262 LEFT (Left Retrieve from Character String)

Retrieves the specified number of characters from the left side of a character string.

■ Instruction format

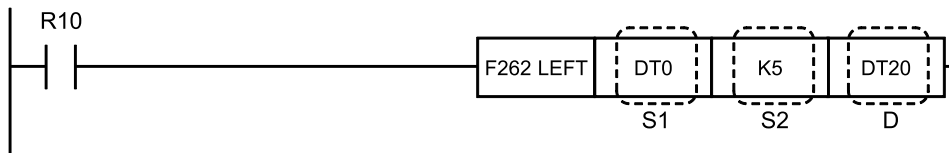

■ Operands

Items	Settings
S1	Character string
S2	Area storing the number of characters, or constant data
D	Area storing the character string

■ Devices that can be specified (indicated by ●)

Operands	WX	WY	WR	WL	SV	EV	DT	LD	I	SWR	SDT	Constant				Index modifier	Integer Device
												K	H	M	f		
S1	●	●	●	●	●	●	●	●	●	●	●					●	
S2	●	●	●	●	●	●	●	●	●	●	●	●	●			●	
D		●	●	●	●	●	●	●	●							●	

■ Outline of operation

- The number of characters specified by [S2] are retrieved from the left side of the character string (the start of character data) specified by [S1], and are transferred to the character string specified by [D].
- At the start of the area for storing results [D], specify the character string size via the user program.

■ Operation example

Operation of instruction format description program

Five characters are retrieved from the start of the character string in DT0 and transferred to DT20.

25.13 F262 LEFT (Left Retrieve from Character String)

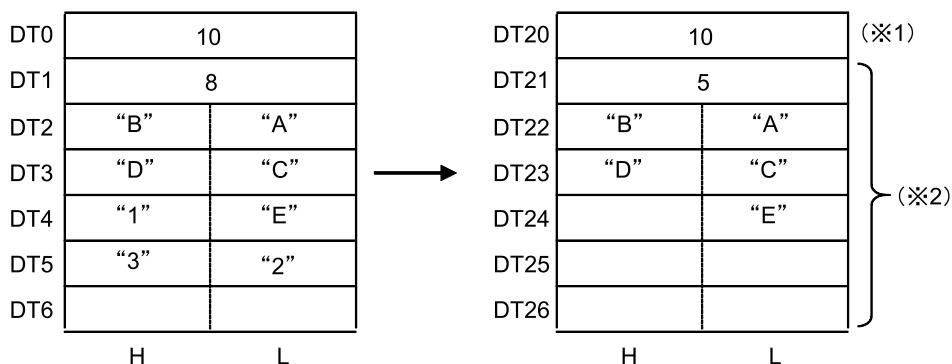

(*1): Specify via the user program

(*2): Area storing the operation results

■ Precautions for programming

- The character data of [D] prior to the operation is cleared.
- If the number of characters specified by [S2] is greater than the number of characters in the character string specified by [S1], then the number of characters in the character string specified by [S1] are transferred.
- If the number of characters specified by [S2] is greater than the size of the character string specified by [D], then the number of characters equal to the size of the character string specified by [D] are transferred.

■ Flag operations

Name	Description
R9007	Turns ON when the area is exceeded in index modification.
R9008 (ER)	
R9009 (CY)	Turns ON when the operation result is greater than the size of the character string specified by [D]

25.14 F263 MIDR (Read from Any Position in Character String)

25.14 F263 MIDR (Read from Any Position in Character String)

Retrieves a character string of the specified number of characters from the specified position in a character string.

■ Instruction format

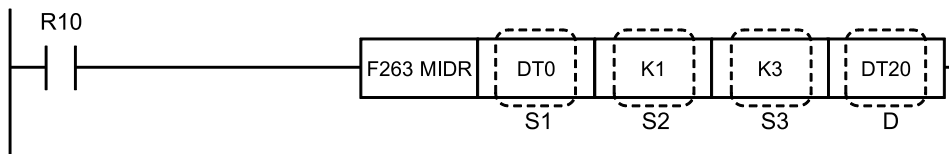

■ Operands

Items	Settings
S1	Character string
S2	Area storing the character string position, or constant data
S3	Area storing the number of characters, or constant data
D	Area storing the character string

■ Devices that can be specified (indicated by ●)

Operands	WX	WY	WR	WL	SV	EV	DT	LD	I	SWR	SDT	Constant				Index modifier	Integer Device
												K	H	M	f		
S1	●	●	●	●	●	●	●	●	●	●	●					●	
S2	●	●	●	●	●	●	●	●	●	●	●	●	●			●	
S3	●	●	●	●	●	●	●	●	●	●	●	●	●			●	
D		●	●	●	●	●	●	●	●							●	

■ Outline of operation

- The number of characters specified by [S3] is retrieved from the position specified by [S2] in the character string specified by [S1], and is transferred to the character string specified by [D].
- At the start of the area for storing results [D], specify the character string size via the user program.

■ Operation example

Operation of instruction format description program

Three characters are retrieved from position byte 1 (2nd character) of the DT0 character string, and are transferred to DT20.

25.14 F263 MIDR (Read from Any Position in Character String)

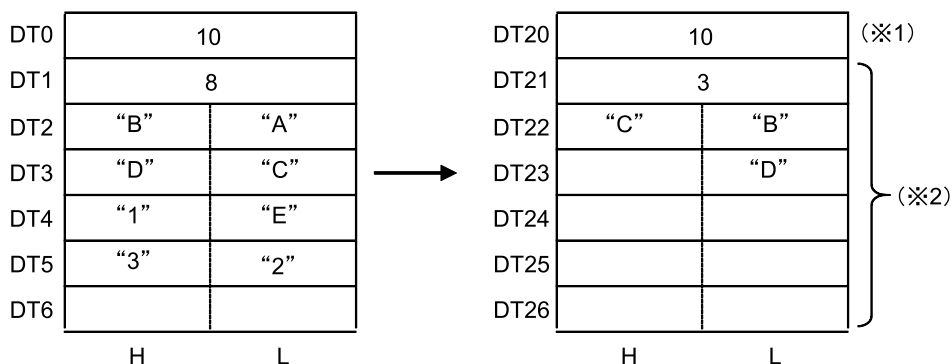

(*1): Specify via the user program

(*2): Area storing the operation results

■ Precautions for programming

- The character data of [D] prior to the operation is cleared.
- If the number of characters specified by [S3] is greater than the number of characters in the character string specified by [S1] from the position specified by [S2], then the number of characters in the character string specified by [S1] are transferred.
- If the number of characters of the operation result is greater than the size of the character string specified by [D], then the number of characters equal to the size of the character string specified by [D] are transferred.
- The position specified by [S2] has K0 specified for the least significant byte (byte 0), and the positions are counted in the order of 0, 1, 2, etc., starting from the least significant byte.

■ Flag operations

Name	Description
R9007	Turns ON when the area is exceeded in index modification.
R9008	Turns ON when number of characters is greater than the character string size
(ER)	Turns ON when the number of characters specified by [S1] is less than [S2]
R9009	Turns ON when the operation result is greater than the size of the character string specified by [D]
(CY)	

25.15 F264 MIDW (Write to Any Position in Character String)

25.15 F264 MIDW (Write to Any Position in Character String)

These instructions write a specified number of characters from a character string to a specified position in the character string.

■ Instruction format

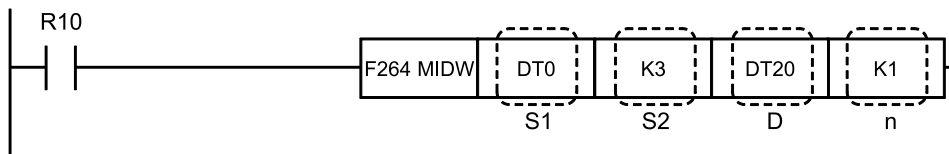

■ Operands

Items	Settings
S1	Character string
S2	Area storing the number of characters, or constant data
D	Starting address of the area storing a character string
n	Area storing the character string position, or constant data

■ Devices that can be specified (indicated by ●)

Operands	WX	WY	WR	WL	SV	EV	DT	LD	I	SW R	SD T	Constant				Index modifier (Note 1)	Integer Device
												K	H	M	f		
S1	●	●	●	●	●	●	●	●	●	●	●			●			
S2	●	●	●	●	●	●	●	●	●	●	●	●	●				
D		●	●	●	●	●	●	●	●								
n	●	●	●	●	●	●	●	●	●	●	●	●	●				

(Note 1) A character constant cannot be specified.

■ Outline of operation

The number of characters specified by [S2] is retrieved from the character string specified by [S1], and is transferred to the [n] position of the character string specified by [D].

■ Operation example

Operation of instruction format description program

Retrieves 3 characters from the DT0 character string, and transfers these to the byte 1 position (second character) of the DT20 character string block.

25.15 F264 MIDW (Write to Any Position in Character String)

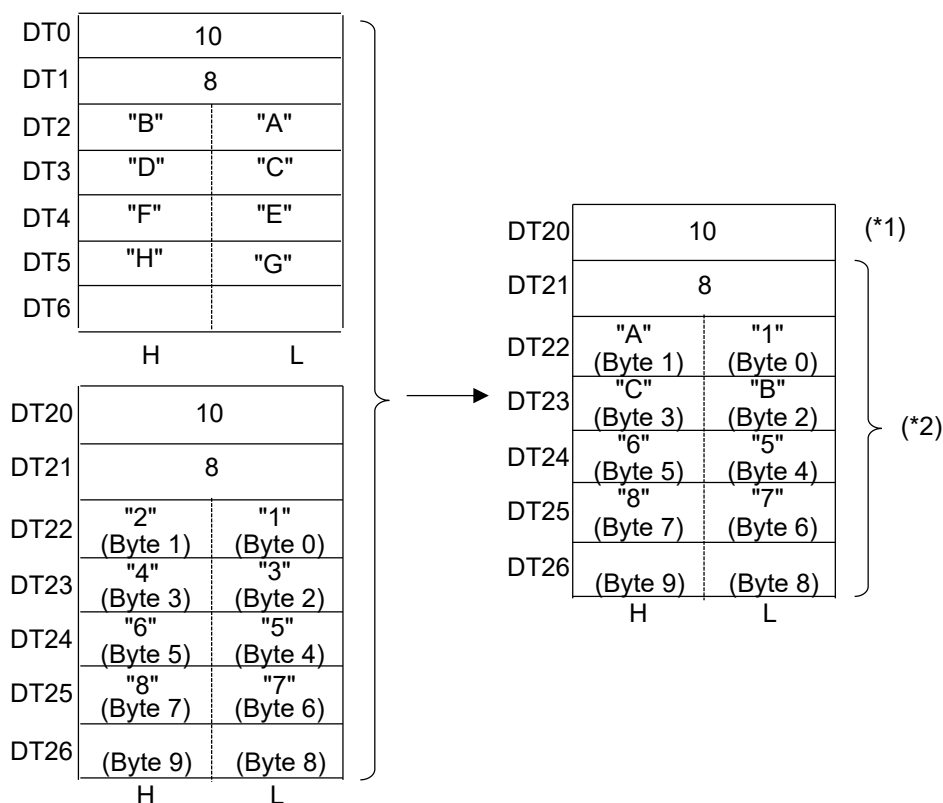

(*1): Specify via the user program

(*2): Area storing the operation results

■ Precautions for programming

- The [D] character data before calculation is not cleared. (This is overwritten.)
- If the number of characters in [S2] is greater than the number of characters in the [S1] character string, the number of characters of the [S1] character string is sent.
- If the position of [n] is greater than number of characters in the [D] character string, an operation error occurs.
- If the number of characters in the operation result is greater than the size of the [D] character string, then replacement is done only within a range the size of the [D] character string.
- The [n] position sets the least significant byte as K0 (byte 0), counting up in the order of 0, 1, 2, etc. starting from the least significant byte.

■ Flag operations

Name	Description
R9007	Turns ON when the area is exceeded in index modification.
R9008 (ER)	Turns ON when number of characters is greater than the character string size
	Turns ON when the number of characters of [D] < [n]
R9009 (CY)	Turns ON when the operation result is greater than the size of the character string specified by [D]

25.16 F265 SREP (Replace Character Strings)

25.16 F265 SREP (Replace Character Strings)

Replaces the specified number of characters in a character string with the same number of different characters, starting from the specified position.

■ Instruction format

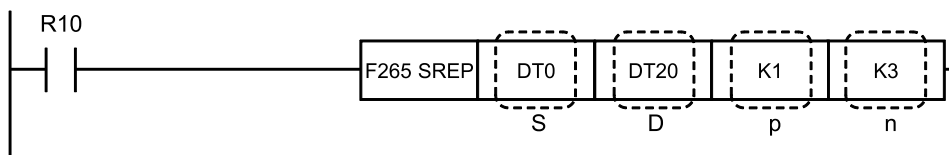

■ Operands

Items	Settings
S	Replacement character string
D	Starting address of the area storing a character string
p	Area storing the first byte position of the characters to be replaced, or constant data
n	Area storing the number of characters to be replaced from the source data, or constant data

■ Devices that can be specified (indicated by ●)

Operands	WX	WY	WR	WL	SV	EV	DT	LD	I	SWR	SDT	Constant				Index modifier (Note 1)	Integer Device
												K	H	M	f		
S	●	●	●	●	●	●	●	●	●	●	●			●			
D		●	●	●	●	●	●	●	●						●		
p	●	●	●	●	●	●	●	●	●	●	●	●	●		●		
n	●	●	●	●	●	●	●	●	●	●	●	●	●		●		

(Note 1) A character constant cannot be specified.

■ Outline of operation

The number of characters specified by [n] are replaced with the character string specified by [S], starting from position [p] in the character string specified by [D].

■ Operation example

Operation of instruction format description program

The DT0 character string is replaced with the number of characters in DT1 (five characters) from byte p = 1 in DT20. In this case, n = 3 characters of the data stored in the source are deleted and replaced.

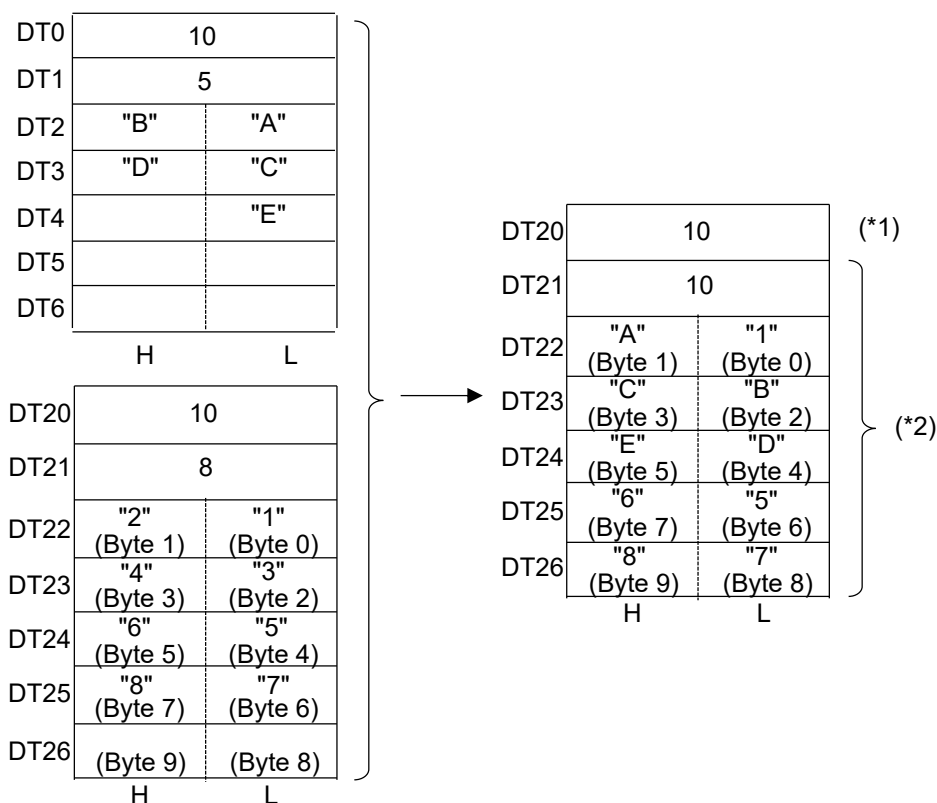

(*1): Specify via the user program

(*2): Area storing the operation results

■ Precautions for programming

- The character data from [D] prior to the operation is not cleared. (This is overwritten.)
- If the number of characters in [n] is larger than the number of characters in the character string [S] subsequent to the point specified by [p], the number of characters in character string [S] subsequent to the point specified by [p] are replaced.
- If the position specified by [p] exceeds the number of characters in the character string specified by [D], an operation error occurs.
- The position specified by [p] sets the low byte as K0 (byte 0), and the positions are counted in the order 0, 1, 2, ... starting from the low byte.

■ Flag operations

Name	Description
R9007	Turns ON when the area is exceeded in index modification.
R9008 (ER)	Turns ON when number of characters is greater than the character string size
	Turns ON when the number of characters of [D] is less than [n]
R9009 (CY)	Turns ON when the operation result is greater than the size of the character string specified by [D]

(MEMO)

26 Data Manipulation Instructions

26.1	F270 MAX (Search Maximum Value from 16-bit Data Block)	26-2
26.2	F271 DMAX (Search Maximum Value from 32-bit Data Block)	26-4
26.3	F272 MIN (Search Minimum Value from 16-bit Data Block)	26-6
26.4	F273 DMIN (Search Minimum Value from 32-bit Data Block)	26-8
26.5	F275 MEAN (16-bit Data Sum and Average)	26-10
26.6	F276 DMEAN (32-bit Data Sum and Average)	26-12
26.7	F277 SORT (16-bit Data Block Sort)	26-14
26.8	F278 DSORT (32-bit Data Block Sort)	26-16
26.9	F282 SCAL (16-bit Data Linearization)	26-18
26.10	F283 DSCAL (32-bit Data Linearization)	26-21
26.11	F284 RAMP (16-bit Data Ramp Output)	26-24
26.12	F285 LIMT (16-bit Data Upper and Lower Limit Control)	26-26
26.13	F286 DLIMIT (32-bit Data Upper and Lower Limit Control)	26-28
26.14	F287 BAND (16-bit Data Deadband Control)	26-30
26.15	F288 DBAND (32-bit Data Deadband Control)	26-32
26.16	F289 ZONE (16-bit Data Zone Control)	26-34
26.17	F290 DZONE (32-bit Data Zone Control)	26-36

26.1 F270 MAX (Search Maximum Value from 16-bit Data Block)

26.1 F270 MAX (Search Maximum Value from 16-bit Data Block)

Finds the maximum value in the specified memory area range (word data table).

■ Instruction format

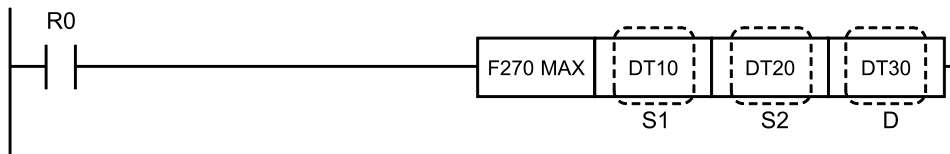

■ Operands

Items	Settings
S1	Starting area that stores word data
S2	Ending area that stores word data
D	Area storing the operation results (two words)

■ Devices that can be specified (indicated by ●)

Operands	WX	WY	WR	WL	SV	EV	DT	LD	I	SWR	SDT	Constant				Index modifier	Integer Device
												K	H	M	f		
S1	●	●	●	●	●	●	●	●	●	●	●					●	
S2	●	●	●	●	●	●	●	●	●	●	●					●	
D		●	●	●	●	●	●	●	●							●	

■ Outline of operation

- Searches for the maximum value in the word data tables from the area specified by [S1] to the area specified by [S2], stores the result in the area specified by [D], and stores the relative address value from [S1] in [D+1].

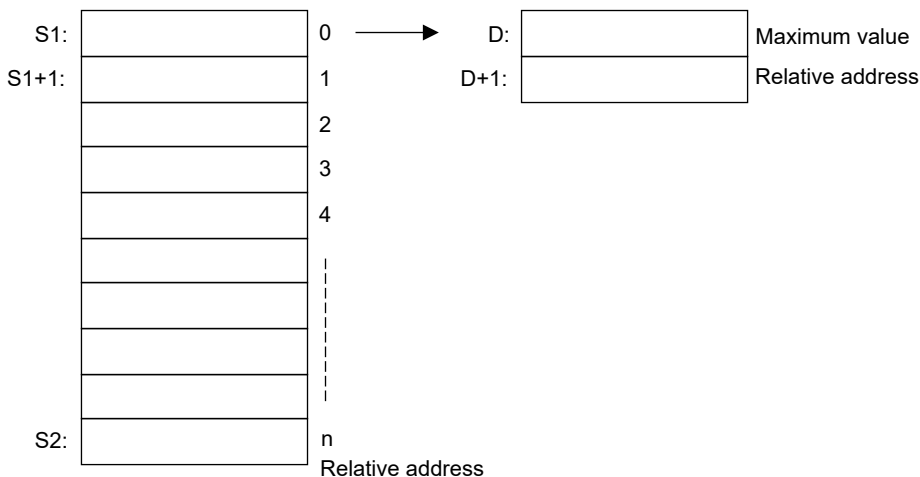

26.1 F270 MAX (Search Maximum Value from 16-bit Data Block)

- If there is multiple data with the same value as the maximum value, the relative address of the first value found searching from [S1] is stored in [D+1].

■ Precautions for programming

[D+1] will stored even if it overflows the specified device area, so it may corrupt the start of other device areas. (Area overflow checks are not performed.)

■ Flag operations

Name	Description
R9007	Turns ON when the area is exceeded in index modification.
R9008	ON when [S1] is greater than [S2]
(ER)	Turns ON when S1 and S2 are different devices

26.2 F271 DMAX (Search Maximum Value from 32-bit Data Block)

26.2 F271 DMAX (Search Maximum Value from 32-bit Data Block)

Calculates the maximum value of the specified memory area range (double word data table).

■ Instruction format

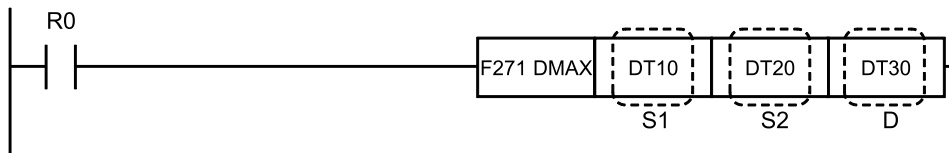

■ Operands

Items	Settings
S1	Starting area storing double word data
S2	Ending area storing double word data
D	Area storing the result of the operation (three words)

■ Devices that can be specified (indicated by ●)

Operands	WX	WY	WR	WL	SV	EV	DT	LD	I	SWR	SDT	Constant				Index modifier	Integer Device
												K	H	M	f		
S1	●	●	●	●	●	●	●	●	●	●	●					●	
S2	●	●	●	●	●	●	●	●	●	●	●					●	
D		●	●	●	●	●	●	●	●							●	

■ Outline of operation

- The maximum value is searched for in the double word data table between the area specified by [S1] and the area specified by [S2] and the result is stored in the area specified by [D]. The address relative to [S1] is stored in [D+2].

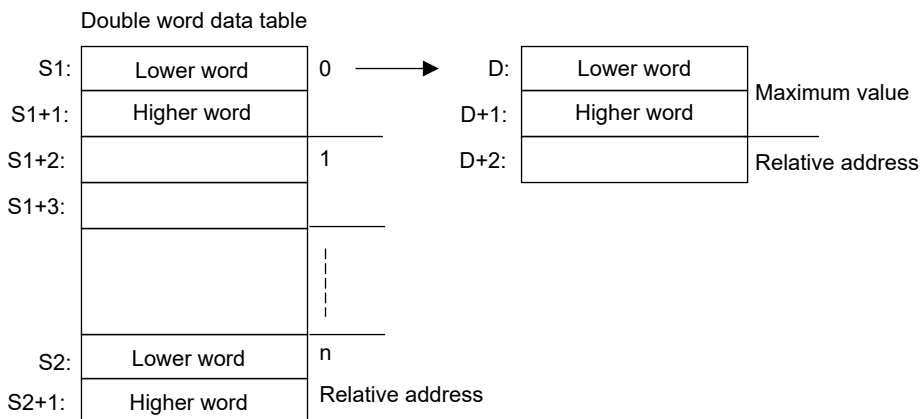

- If [S2] specifies a high word of double word data, processing will take place over the same area as if a low word had been specified.

26.2 F271 DMAX (Search Maximum Value from 32-bit Data Block)

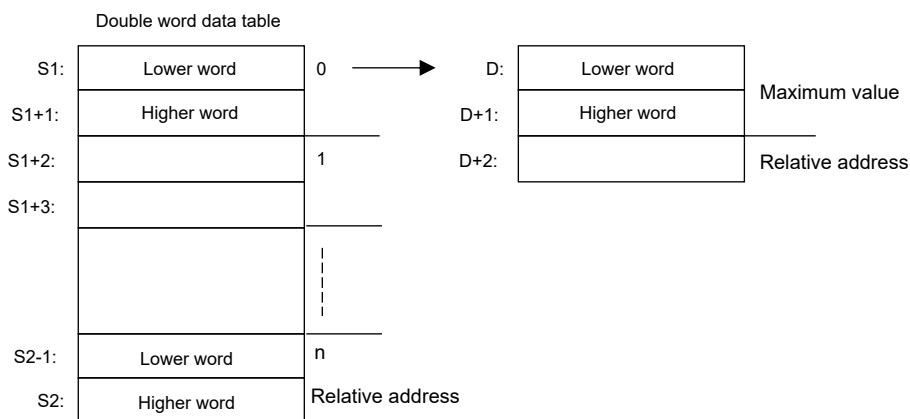

- If there is multiple data with the same value as the maximum value, the relative address of the first value found searching from [S1] is stored in [D+2].

■ Precautions for programming

- [D+2] will stored even if it overflows the specified device area, so it may corrupt the start of other device areas. (Area overflow checks are not performed.)
- The stored relative address value is counted in 32-bit units.

■ Flag operations

Name	Description
R9007	Turns ON when the area is exceeded in index modification.
R9008	ON when [S1] is greater than [S2]
(ER)	Turns ON when S1 and S2 are different devices

26.3 F272 MIN (Search Minimum Value from 16-bit Data Block)

26.3 F272 MIN (Search Minimum Value from 16-bit Data Block)

Finds the minimum value in the specified memory area range (word data table).

■ Instruction format

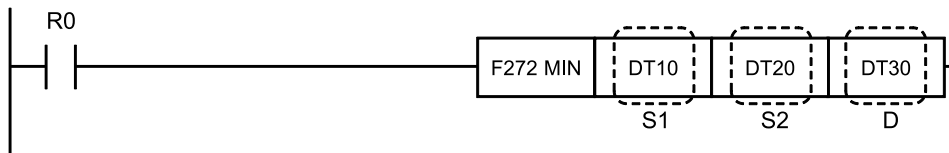

■ Operands

Items	Settings
S1	Starting area that stores word data
S2	Ending area that stores word data
D	Area storing the operation results (two words)

■ Devices that can be specified (indicated by ●)

Operands	WX	WY	WR	WL	SV	EV	DT	LD	I	SWR	SDT	Constant				Index modifier	Integer Device
												K	H	M	f		
S1	●	●	●	●	●	●	●	●	●	●	●					●	
S2	●	●	●	●	●	●	●	●	●	●	●					●	
D		●	●	●	●	●	●	●	●							●	

■ Outline of operation

- Searches for a minimum value in the word data table from the area specified in [S1] to the area specified in [S2], stores the result in the area specified in [D], and stores the relative address value from [S1] in [D+1].

26.3 F272 MIN (Search Minimum Value from 16-bit Data Block)

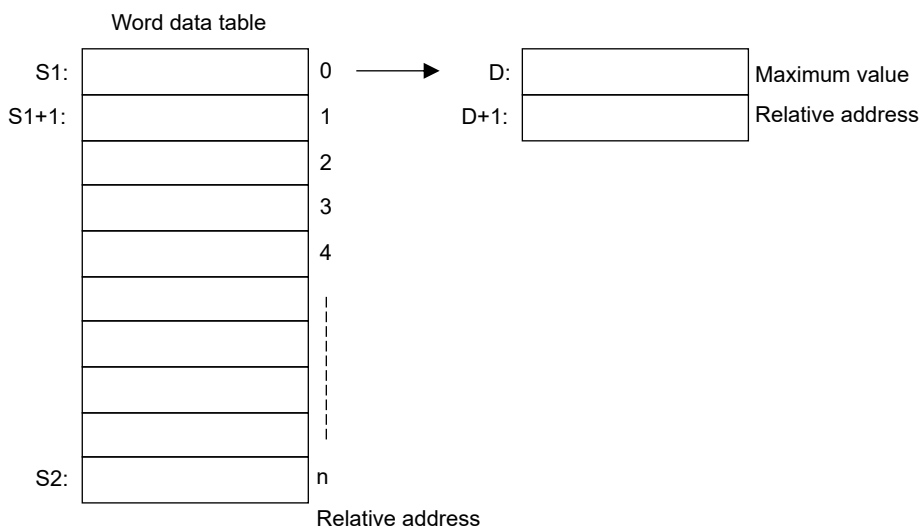

- When there is multiple data sharing the same minimum value, the relative address of the first result found searching from [S1] is stored in [D+1].

■ Precautions for programming

[D+1] will stored even if it overflows the specified device area, so it may corrupt the start of other device areas. (Area overflow checks are not performed.)

■ Flag operations

Name	Description
R9007	Turns ON when the area is exceeded in index modification.
R9008	ON when [S1] is greater than [S2]
(ER)	Turns ON when S1 and S2 are different devices

26.4 F273 DMIN (Search Minimum Value from 32-bit Data Block)

26.4 F273 DMIN (Search Minimum Value from 32-bit Data Block)

Finds the minimum value of the specified memory area range (double word data table).

■ Instruction format

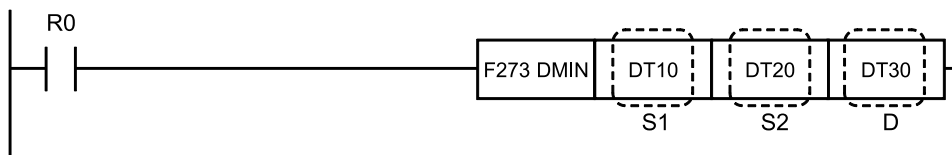

■ Operands

Items	Settings
S1	Starting area storing double word data
S2	Ending area storing double word data
D	Area storing the result of the operation (three words)

■ Devices that can be specified (indicated by ●)

Operands	WX	WY	WR	WL	SV	EV	DT	LD	I	SWR	SDT	Constant				Index modifier	Integer Device
												K	H	M	f		
S1	●	●	●	●	●	●	●	●	●	●	●					●	
S2	●	●	●	●	●	●	●	●	●	●	●					●	
D		●	●	●	●	●	●	●	●							●	

■ Outline of operation

- Searches for the minimum value in the double word data table between the area specified by [S1] and the area specified by [S2] and stores the result in the area specified by [D]. The relative address value relative to [S1] is stored in [D+2].

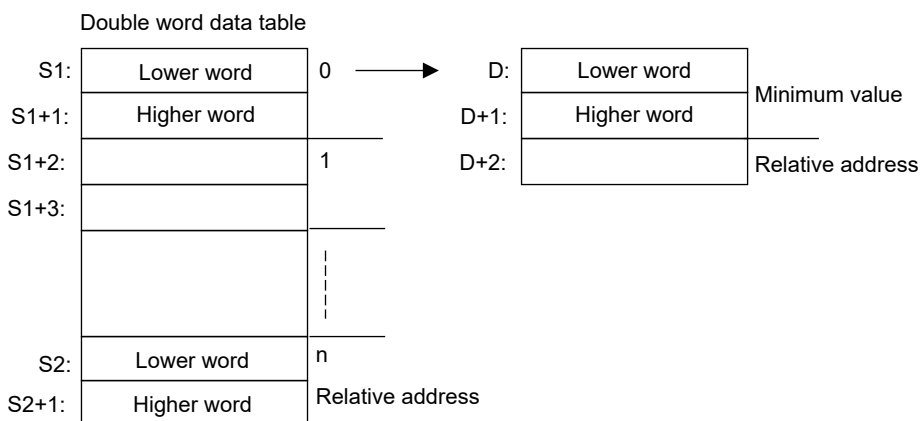

- If [S2] specifies a high word of double word data, processing will take place over the same area as if a low word had been specified.

26.4 F273 DMIN (Search Minimum Value from 32-bit Data Block)

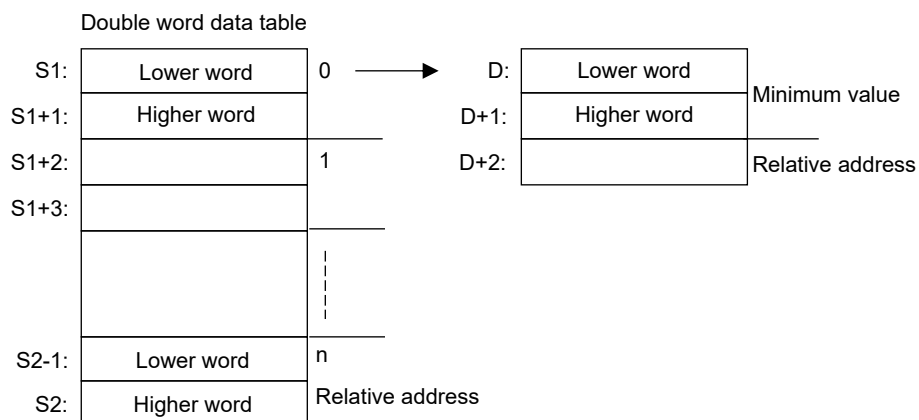

- When there is multiple data sharing the same minimum value, the relative address of the first result found searching from [S1] is stored in [D+2].

■ Precautions for programming

- [D+2] will stored even if it overflows the specified device area, so it may corrupt the start of other device areas. (Area overflow checks are not performed.)
- The stored relative address value is counted in 32-bit units.

■ Flag operations

Name	Description
R9007	Turns ON when the area is exceeded in index modification.
R9008	ON when [S1] is greater than [S2]
(ER)	Turns ON when S1 and S2 are different devices

26.5 F275 MEAN (16-bit Data Sum and Average)

26.5 F275 MEAN (16-bit Data Sum and Average)

Calculates the total value and mean value of the specified memory area range (word data).

■ Instruction format

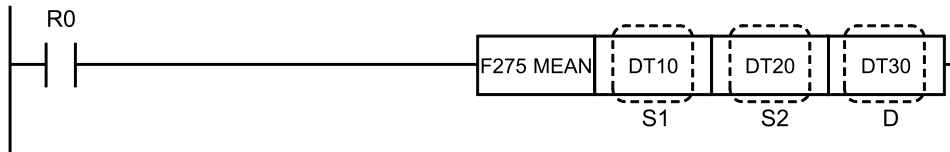

■ Operands

Items	Settings
S1	Starting area that stores word data
S2	Ending area that stores word data
D	Area storing the result of the operation (three words)

■ Devices that can be specified (indicated by ●)

Operands	WX	WY	WR	WL	SV	EV	DT	LD	I	SWR	SDT	Constant				Index modifier	Integer Device
												K	H	M	f		
S1	●	●	●	●	●	●	●	●	●	●	●					●	
S2	●	●	●	●	●	●	●	●	●	●	●					●	
D		●	●	●	●	●	●	●	●							●	

■ Outline of operation

- The total value and mean value of the word data (signed) from the area specified by [S1] to the area specified by [S2] are obtained and stored in the area specified by [D].

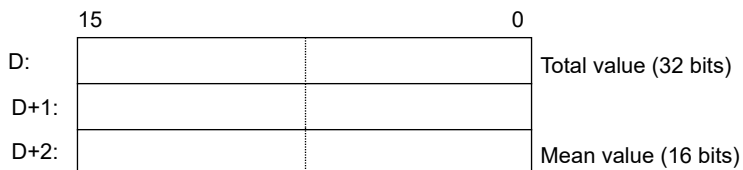

- For the mean value, the decimal is rounded down to make an integer.

■ Precautions for programming

[D+2] will be stored even if it overflows the specified device area, so it may corrupt the start of other device areas. (Area overflow checks are not performed.)

■ Flag operations

Name	Description
R9007	Turns ON when the area is exceeded in index modification.

26.5 F275 MEAN (16-bit Data Sum and Average)

Name	Description
R9008 (ER)	ON when [S1] is greater than [S2] Turns ON when S1 and S2 are different devices
R9009 (CY)	Turns ON when overflow/underflow occurs during calculation

26.6 F276 DMEAN (32-bit Data Sum and Average)

26.6 F276 DMEAN (32-bit Data Sum and Average)

Calculates the total and mean values of the specified memory area range (double word data).

■ Instruction format

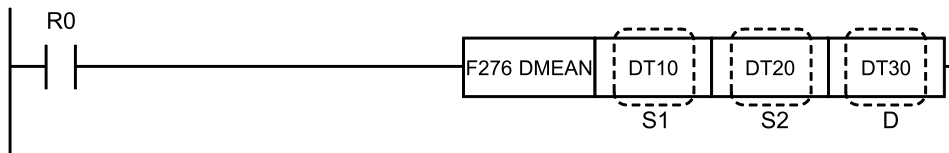

■ Operands

Items	Settings
S1	Starting area storing double word data
S2	Ending area storing double word data
D	Area storing the operation results (6 words)

■ Devices that can be specified (indicated by ●)

Operands	WX	WY	WR	WL	SV	EV	DT	LD	I	SWR	SDT	Constant				Index modifier	Integer Device
												K	H	M	f		
S1	●	●	●	●	●	●	●	●	●	●	●					●	
S2	●	●	●	●	●	●	●	●	●	●	●					●	
D		●	●	●	●	●	●	●	●							●	

■ Outline of operation

- The total and mean values of the double word data (signed) from the area specified by [S1] to the area specified by [S2] are stored in the area specified by [D].

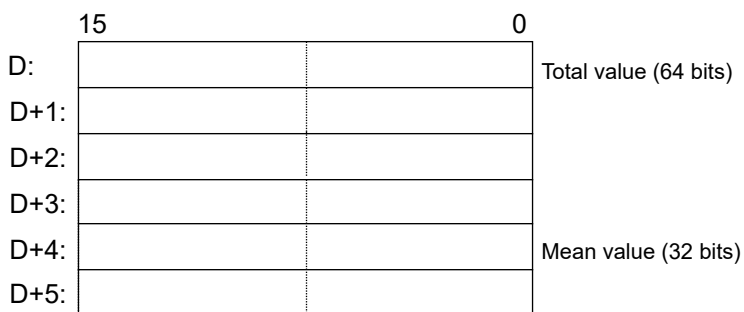

- If [S2] specifies a high word of double word data, processing will take place over the same area as if a low word had been specified.

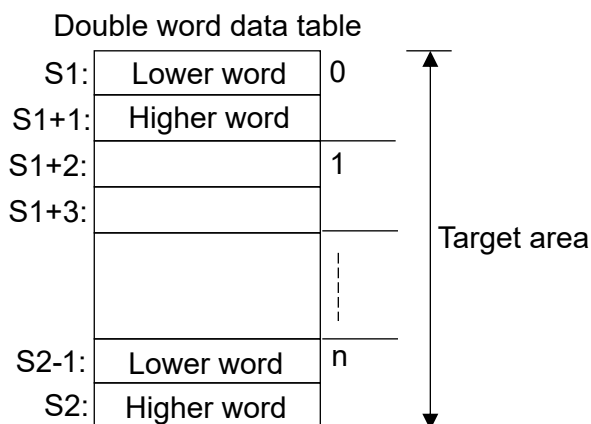

- For the mean value, the decimal is rounded down to make an integer.

■ Precautions for programming

[D+5] will be stored even if it overflows the specified device area, so it may corrupt the start of other device areas. (Area overflow checks are not performed.)

■ Flag operations

Name	Description
R9007	Turns ON when the area is exceeded in index modification.
R9008 (ER)	ON when [S1] is greater than [S2] Turns ON when S1 and S2 are different devices
R9009 (CY)	Turns ON when overflow/underflow occurs during calculation

26.7 F277 SORT (16-bit Data Block Sort)

26.7 F277 SORT (16-bit Data Block Sort)

Sorts the strings (word data) in the specified memory area range into ascending or descending order.

■ Instruction format

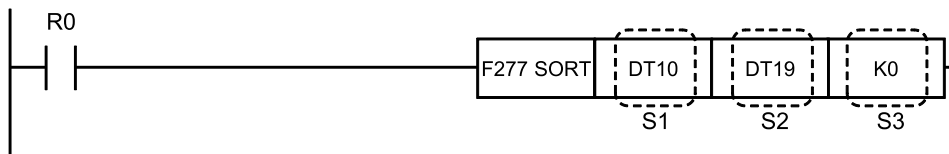

■ Operands

Items	Settings
S1	Starting area storing sort data
S2	Ending area storing sort data
S3	Area storing sort conditions, or constant data

■ Devices that can be specified (indicated by ●)

Operands	WX	WY	WR	WL	SV	EV	DT	LD	I	SW R	SD T	Constant				Index modifier	Integer Device
												K	H	M	f		
S1		●	●	●	●	●	●	●	●							●	
S2		●	●	●	●	●	●	●	●							●	
S3	●	●	●	●	●	●	●	●	●	●	●	●	●			●	

■ Outline of operation

- The word data (signed) from the area specified by [S1] to the area specified by [S2] is sorted into ascending or descending order.
- When S1 = S2, no operation takes place.
- The sort conditions are specified in [S3].
K0: Ascending order
K1: Descending order
- During sorting, the data from [S1] to [S2] is sorted in sequential order in accordance with the sort procedure. Note that the number of times data is compared increases proportionally to the square of the number of data words, and therefore the operation time will increase if there is a large number of data words to be sorted.

■ Operation example

Operation of instruction format description program

- Ascending order
If data is stored in DT10 to DT19 as shown below and [S3] = K0, the following operation is performed.

DT10:	K300
11:	K10
12:	K3
13:	K-1
14:	K1000
15:	K-30
16:	K100
17:	K30
18:	K1
19:	K-3

DT10:	K-30
11:	K-3
12:	K-1
13:	K1
14:	K3
15:	K10
16:	K30
17:	K1000
18:	K300
19:	K1000

- Descending order

If data is stored in DT10 to DT19 as shown below and [S3] = K1, the following operation is performed.

DT10:	K300
11:	K10
12:	K3
13:	K-1
14:	K1000
15:	K-30
16:	K100
17:	K30
18:	K1
19:	K-3

DT10:	K1000
11:	K300
12:	K100
13:	K30
14:	K10
15:	K3
16:	K1
17:	K-1
18:	K-3
19:	K-30

■ Flag operations

Name	Description
R9007	Turns ON when the area is exceeded in index modification.
R9008	ON when [S1] is greater than [S2]
(ER)	Turns ON when S1 and S2 are different devices

26.8 F278 DSORT (32-bit Data Block Sort)

26.8 F278 DSORT (32-bit Data Block Sort)

Sorts strings (double word data) in the specified memory area in ascending or descending order.

■ Instruction format

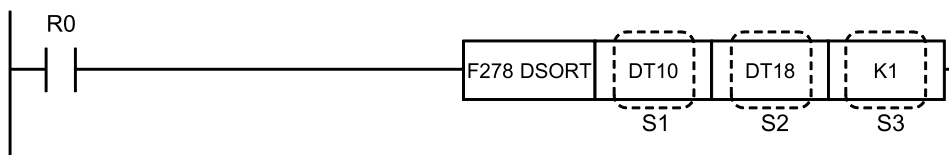

■ Operands

Items	Settings
S1	Starting area storing sort data
S2	Ending area storing sort data
S3	Area storing sort conditions, or constant data

■ Devices that can be specified (indicated by ●)

Operands	WX	WY	WR	WL	SV	EV	DT	LD	I	SWR	SDT	Constant				Index modifier	Integer Device
												K	H	M	f		
S1		●	●	●	●	●	●	●	●							●	
S2		●	●	●	●	●	●	●	●							●	
S3	●	●	●	●	●	●	●	●	●	●	●	●	●			●	

■ Outline of operation

- Sorts the double word data (signed) in the areas specified by [S1] and [S2] into ascending or descending order.
- When S1 = S2, no operation takes place.
- The sort conditions are specified in [S3].
K0: Ascending order
K1: Descending order
- During sorting, the data from [S1] to [S2] is sorted in sequential order in accordance with the sort procedure. Note that the number of times data is compared increases proportionally to the square of the number of data words, and therefore the operation time will increase if there is a large number of data words to be sorted.
- If [S2] specifies a high word of double word data, processing will take place over the same area as if a low word had been specified.

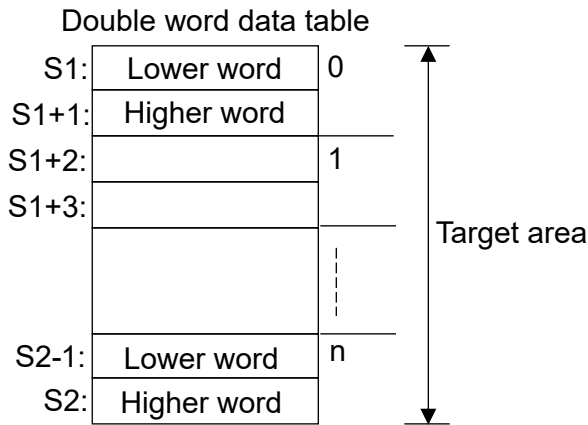

■ Operation example

Operation of instruction format description program

- Ascending order

If data is stored in DT10 to DT19 as below and [S3] = K0, the following operation will be performed.

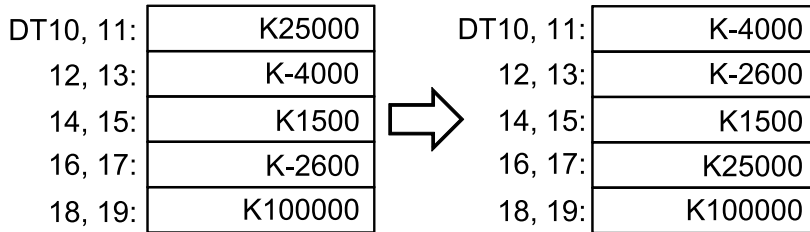

- Descending order

If data is stored in DT10 to DT19 as shown below and [S3] = K1, the following operation is performed.

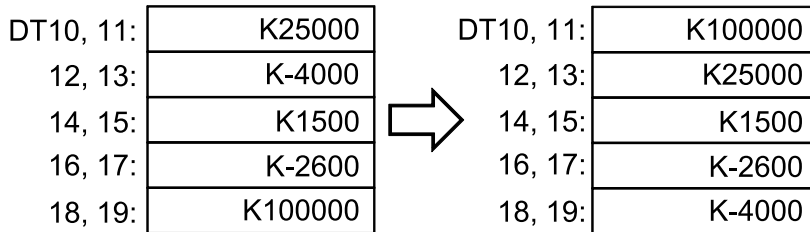

■ Flag operations

Name	Description
R9007	Turns ON when the area is exceeded in index modification.
R9008	ON when [S1] is greater than [S2]
(ER)	Turns ON when S1 and S2 are different devices

26.9 F282 SCAL (16-bit Data Linearization)

26.9 F282 SCAL (16-bit Data Linearization)

Performs scaling of the given data table and finds output value Y with regards to input value X.

■ Instruction format

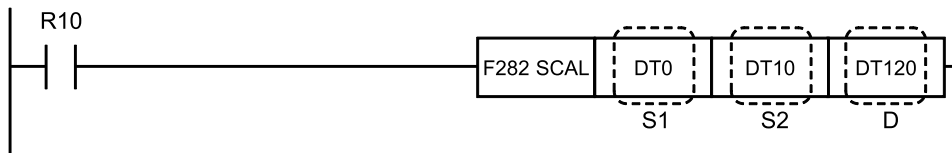

■ Operands

Items	Settings
S1	Source 16-bit data equivalent to input value X, or the area where it is stored
S2	Starting address of the data table used for scaling (linearization)
D	Area where output result Y is stored

■ Devices that can be specified (indicated by ●)

Operands	WX	WY	WR	WL	SV	EV	DT	LD	I	SWR	SDT	Constant				Index modifier	Integer Device
												K	H	M	f		
S1	●	●	●	●	●	●	●	●	●	●	●	●	●		●		
S2	●	●	●	●	●	●	●	●	●	●	●				●		
D		●	●	●	●	●	●	●	●						●		

■ Outline of operation

- The 16-bit data specified by [S1] is scaled in accordance with the data table specified by [S2], and the output value for input value X is calculated.
- The number of items in the data table n is determined by the value [n] specified in [S2] at the top of the data table.

Structure of the data table used in scaling (linearization) (if S2 = DT10 and n = K10)

S2:	n	DT10
S2+1:	x1	DT11
S2+2:	x2	DT12
S2+3:	x3	DT13
~~~~~		
S2+n-1:	xn-1	DT19
S2+n:	xn	DT20
S2+n+1:	y1	DT21
S2+n+2:	y2	DT22
S2+n+3:	y3	DT23
~~~~~		
S2+2n-1:	yn-1	DT29
S2+2n:	yn	DT30

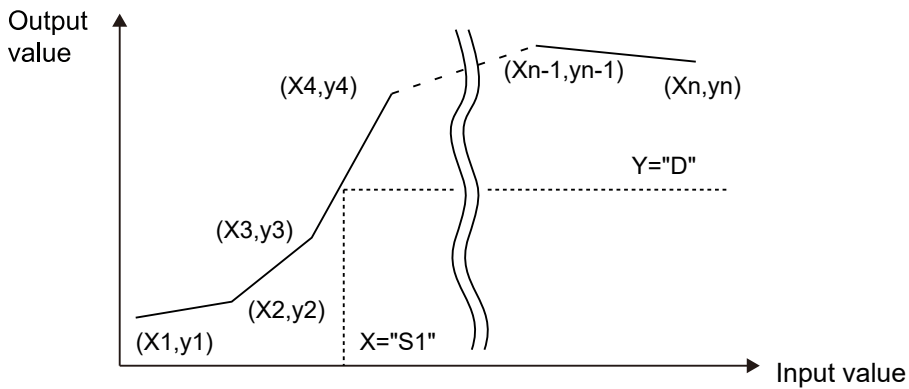

■ **Operation example**

Operation of instruction format description program

The data table is referenced starting from DT10, output value Y for the input value stored in DT0 is calculated, and the result is stored in DT120.

■ **Precautions for programming**

- Make $X_{t-1} < X_t$.
- Create xt and yt as signed 16-bit data.
- If $X(S1) < x1$, then $Y(D) = y1$.
- If $X(S1) > xn$, then $Y(D) = yn$. n has a maximum of 99.

■ **Flag operations**

Name	Description
R9007	Turns ON when the area is exceeded in index modification.

26.9 F282 SCAL (16-bit Data Linearization)

Name	Description
R9008 (ER)	Turns ON when $n < 2$ or $n > 99$ in [S2]
	Turns ON when data table in [S2] exceeds area
	Turns ON when X_n is not in ascending order

26.10 F283 DSCAL (32-bit Data Linearization)

Performs scaling of the given data table and finds output value Y with regards to input value X.

■ Instruction format

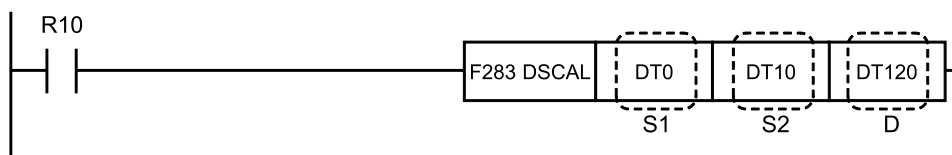

■ Operands

Items	Settings
S1	Original 32-bit data corresponding to input value X, or storage area
S2	Starting address of the data table used for scaling (linearization)
D	Area where output result Y is stored

■ Devices that can be specified (indicated by ●)

Operands	WX	WY	WR	WL	SV	EV	DT	LD	I	SWR	SDT	Constant				Index modifier	Integer Device
												K	H	M	f		
S1	●	●	●	●	●	●	●	●	●	●	●	●				●	
S2	●	●	●	●	●	●	●	●	●	●	●					●	
D		●	●	●	●	●	●	●	●							●	

■ Outline of operation

- Performs scaling of the 32-bit data specified in [S1] according to the data table specified in [S2], and finds output value Y with regards to input value X.
- The number of items in the data table n is determined by the value [n] specified in [S2] at the top of the data table.

Structure of the data table used in scaling (linearization) (if S2 = DT10 and n = K10)

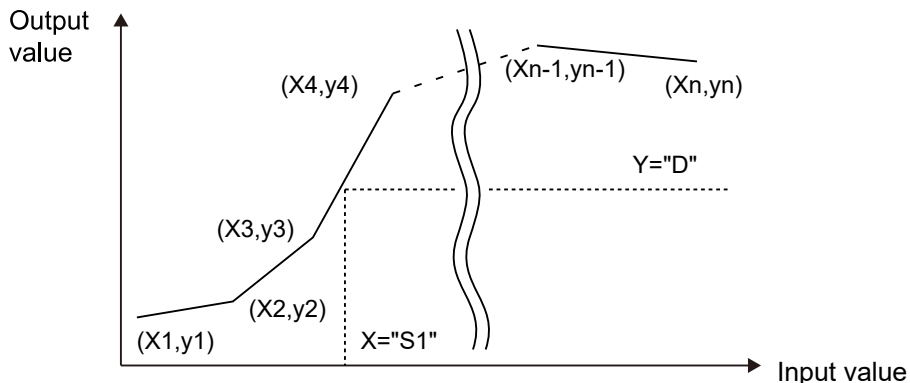
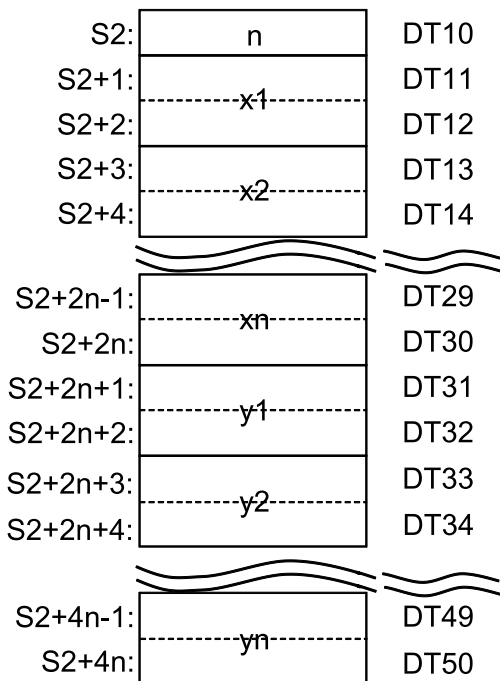

■ **Operation example**

Operation of instruction format description program

Finds output value Y with regards to input value X stored in DT0, with reference to the data table starting from DT10, and stores the result in DT120 to DT121.

■ **Precautions for programming**

- Make $X_{t-1} < X_t$.
- Create xt and yt as signed 32-bit data.
- If $X(S1) < x1$, then $Y(D) = y1$.
- If $X(S1) > xn$, then $Y(D) = yn$. n has a maximum of 99.

■ Flag operations

Name	Description
R9007 R9008 (ER)	Turns ON when the area is exceeded in index modification.
	Turns ON when $n < 2$ or $n > 99$ in [S2]
	Turns ON when data table in [S2] exceeds area
	Turns ON when X_n is not in ascending order

26.11 F284 RAMP (16-bit Data Ramp Output)

Linear output is executed based on the elapsed time from the start of execution, by performing scaling from the output default value, target value, and time width.

■ **Instruction format**

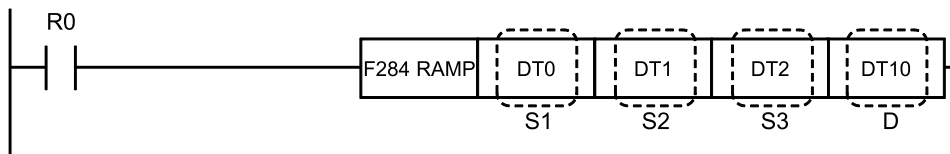

■ **Operands**

Items	Settings
S1	Area storing the default value, or constant data
S2	Area storing the target value, or constant data
S3	Area storing the time width, or constant data
D	Data output area

■ **Devices that can be specified (indicated by ●)**

Operands	WX	WY	WR	WL	SV	EV	DT	LD	I	SWR	SDT	Constant				Index modifier	Integer Device
												K	H	M	f		
S1	●	●	●	●	●	●	●	●	●	●	●	●	●	●	●		
S2	●	●	●	●	●	●	●	●	●	●	●	●	●	●	●		
S3	●	●	●	●	●	●	●	●	●	●	●	●	●	●	●		
D		●	●	●	●	●	●	●	●						●		

■ **Outline of operation**

Scaling is performed from the 16-bit output default value of the area specified by [S1], the 16-bit output target value of the area specified by [S2], and the 16-bit output time width (in ms units) of the area specified by [S3], and linear output is performed according to the elapsed time from the start of execution.

■ **Precautions for programming**

It is possible that a maximum error of 1 scan may occur in the output time width.

<Example> If the following values are set in a program

- DT0 (default value) = K1000
- DT1 (target value) = K5000
- DT2 (time width) = K400

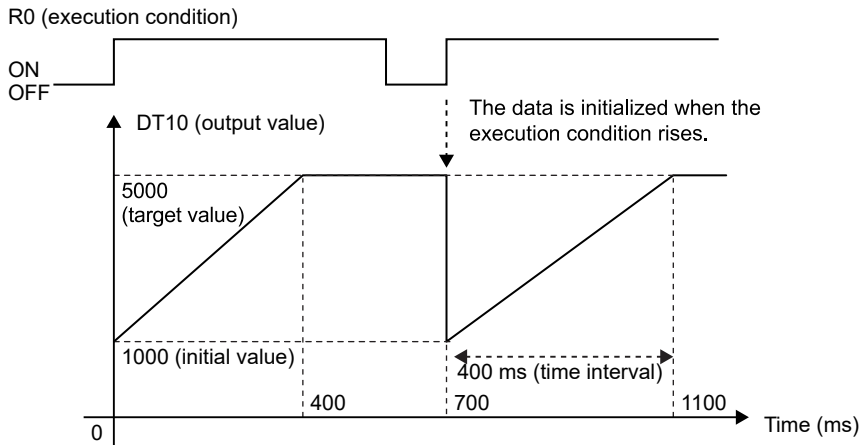

DT0 (default value) = K5000

DT1 (target value) = K1000

DT2 (time width) = K400

R0 (execution condition)

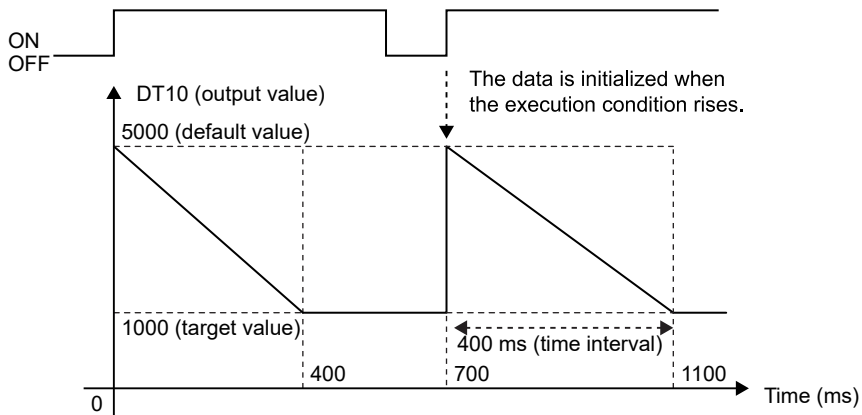

■ Flag operations

Name	Description
R9007	Turns ON when the area is exceeded in index modification.
R9008 (ER)	If the output time width specified in S3 is out of range of K1 to K30000

26.12 F285 LIMT (16-bit Data Upper and Lower Limit Control)

26.12 F285 LIMT (16-bit Data Upper and Lower Limit Control)

Performs upper and lower limit control (word data).

■ Instruction format

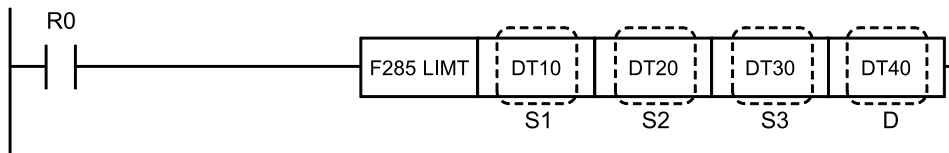

■ Operands

Items	Settings
S1	Area storing the lower limit or lower limit data
S2	Area storing the upper limit or upper limit data
S3	Area storing the input value or input value data
D	Area storing the output value

■ Devices that can be specified (indicated by ●)

Operands	WX	WY	WR	WL	SV	EV	DT	LD	I	SWR	SDT	Constant				Index modifier	Integer Device
												K	H	M	f		
S1	●	●	●	●	●	●	●	●	●	●	●	●	●	●	●	●	
S2	●	●	●	●	●	●	●	●	●	●	●	●	●	●	●	●	●
S3	●	●	●	●	●	●	●	●	●	●	●	●	●	●	●	●	●
D		●	●	●	●	●	●	●	●							●	

■ Outline of operation

- The output value (word data) stored in the area specified by [D] is controlled according to whether or not the input value (word data) specified by [S3] falls within the range bounded by the upper and lower limits specified by [S1] and [S2].
- The output value is determined based on the following conditions.
 - If lower limit value [S1] is greater than input value [S3], then lower limit value [S1] becomes output value [D]
 - If upper limit value [S2] is less than input value [S3], then upper limit value [S2] becomes output value [D]
 - If lower limit value [S1] is equal to or less than input value [S3], which is equal to or less than upper limit value [S2], then input value [S3] becomes output value [D]

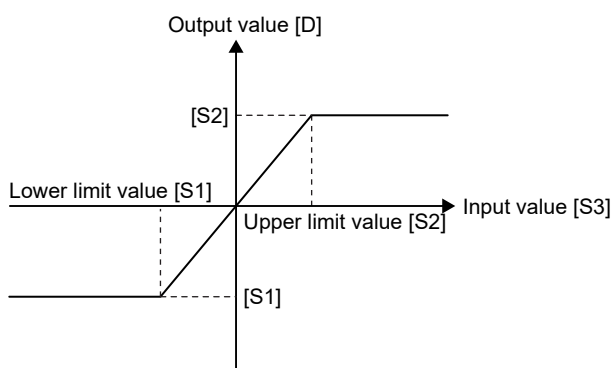

- For control using only the upper limit value
Specify K-32768 (or H8000) for the lower limit value [S1].
- For control using only the lower limit value
Specify K32767 (or H7FFF) for the upper limit value [S2].

■ Flag operations

Name	Description
R9007	Turns ON when the area is exceeded in index modification.
R9008 (ER)	ON when [S1] is greater than [S2]
R900B (=)	Turns ON when the operation result falls within the upper/lower limit range

26.13 F286 DLIMIT (32-bit Data Upper and Lower Limit Control)

26.13 F286 DLIMIT (32-bit Data Upper and Lower Limit Control)

Performs upper and lower limit control (double word).

■ Instruction format

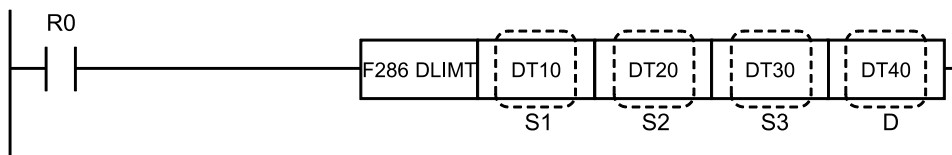

■ Operands

Items	Settings
S1	Area storing the lower limit, or lower limit data (two words)
S2	Area storing the upper limit, or upper limit data (two words)
S3	Area storing the input value, or input value data (two words)
D	Area storing the output value (two words)

■ Devices that can be specified (indicated by ●)

Operands	WX	WY	WR	WL	SV	EV	DT	LD	I	SWR	SDT	Constant				Index modifier	Integer Device
												K	H	M	f		
S1	●	●	●	●	●	●	●	●	●	●	●	●	●	●	●		
S2	●	●	●	●	●	●	●	●	●	●	●	●	●	●	●		
S3	●	●	●	●	●	●	●	●	●	●	●	●	●	●	●		
D		●	●	●	●	●	●	●	●							●	

■ Outline of operation

- The output value (double-word data) stored in the area specified by [D] is controlled according to whether or not the input value (double-word data) specified by [S3] falls within the range bounded by the upper and lower limits specified by [S1] and [S2].
- The output value is determined based on the following conditions.
 - If lower limit value [S1, S1+1] is greater than input value [S3, S3+1], then lower limit value [S1, S1+1] becomes output value [D, D+1]
 - If upper limit value [S2, S2+1] is less than input value [S3, S3+1], then upper limit value [S2, S2+1] becomes output value [D, D+1]
 - If lower limit value [S1, S1+1] is equal to or less than input value [S3, S3+1], which is equal to or less than upper limit value [S2, S2+1], then input value [S3, S3+1] becomes output value [D, D+1]

26.13 F286 DLIMIT (32-bit Data Upper and Lower Limit Control)

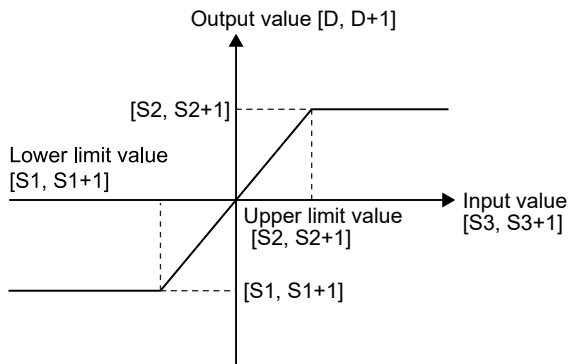

- For control using only the upper limit value
Set K-2147483648 (or H80000000) for lower limit [S1, S1+1].
- For control using only the lower limit value
Set K2147483647 (or H7FFFFFFF) for upper limit [S2, S2+1].

■ Flag operations

Name	Description
R9007	Turns ON when the area is exceeded in index modification.
R9008 (ER)	ON when [S1] is greater than [S2]
R900B (=)	Turns ON when the operation result falls within the upper/lower limit range

26.14 F287 BAND (16-bit Data Deadband Control)

26.14 F287 BAND (16-bit Data Deadband Control)

Performs deadband control (word).

■ Instruction format

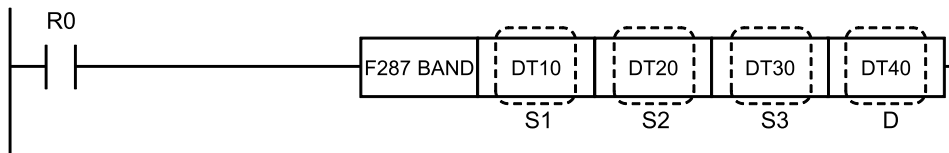

■ Operands

Items	Settings
S1	Area storing the lower limit or lower limit data
S2	Area storing the upper limit or upper limit data
S3	Area storing the input value or input value data
D	Area storing the output value

■ Devices that can be specified (indicated by ●)

Operands	WX	WY	WR	WL	SV	EV	DT	LD	I	SWR	SDT	Constant				Index modifier	Integer Device
												K	H	M	f		
S1	●	●	●	●	●	●	●	●	●	●	●	●	●	●	●		
S2	●	●	●	●	●	●	●	●	●	●	●	●	●	●	●		
S3	●	●	●	●	●	●	●	●	●	●	●	●	●	●	●		
D		●	●	●	●	●	●	●	●							●	

■ Outline of operation

- The output value (word data) stored in the area specified by [D] is controlled based in whether or not the input value (word data) specified by [S3] is inside or outside of the deadband bounded by the upper and lower limits specified by [S1] and [S2].
- The output value is determined based on the following conditions.
 - When the lower limit [S1] is greater than the input value [S3], input value [S3] minus lower limit [S1] equals output value [D]
 - When the upper limit [S2] is less than the input value [S3], input value [S3] minus upper limit [S2] equals output value [D]
 - When the lower limit [S1] is equal to or less than the input value [S3] that is equal to or less than the upper limit [S2], 0 equals output value [D]

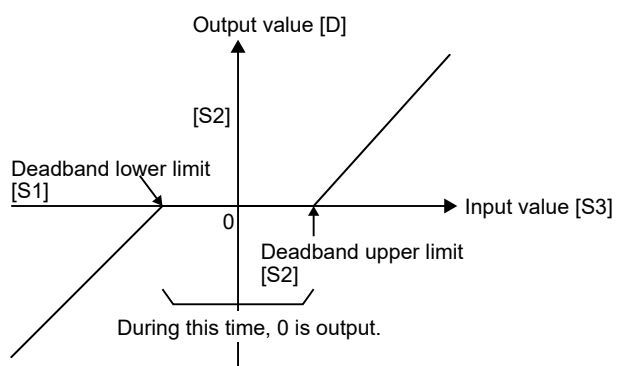

■ Operation example

Operation of instruction format description program

When K-100 is stored in DT10 and K100 in DT20, the following operation will be performed.

Value of DT30	Value stored in DT40
K-300	K-200
K-200	K-100
K-100 to K100	K0
K200	K100
K300	K200

■ Flag operations

Name	Description
R9007	Turns ON when the area is exceeded in index modification.
R9008 (ER)	ON when [S1] is greater than [S2]
R9009 (CY)	ON when the calculation result overflows or underflows
R900B (=)	Turns ON when the calculation result is "0"

26.15 F288 DBAND (32-bit Data Deadband Control)

Carries out deadband control (double word).

■ **Instruction format**

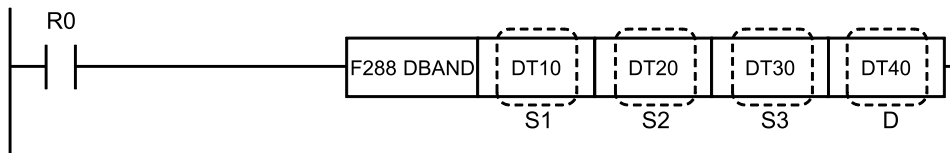

■ **Operands**

Items	Settings
S1	Area storing the lower limit, or lower limit data (two words)
S2	Area storing the upper limit, or upper limit data (two words)
S3	Area storing the input value, or input value data (two words)
D	Area storing the output value (two words)

■ **Devices that can be specified (indicated by ●)**

Operands	WX	WY	WR	WL	SV	EV	DT	LD	I	SWR	SDT	Constant				Index modifier	Integer Device
												K	H	M	f		
S1	●	●	●	●	●	●	●	●	●	●	●	●	●	●	●		
S2	●	●	●	●	●	●	●	●	●	●	●	●	●	●	●		
S3	●	●	●	●	●	●	●	●	●	●	●	●	●	●	●		
D		●	●	●	●	●	●	●	●						●		

■ **Outline of operation**

- The output value (double word data) stored in the area specified by [D] is controlled according to whether or not the input value (double word data) specified by [S3] is inside the range of the upper and lower limits of the deadband specified by [S1] and [S2].
- The output value is determined based on the following conditions.
 - When the lower limit [S1, S1+1] > input value [S3, S3+1], the input value [S3, S3+1] - the lower limit [S1, S1+1] becomes the output value [D, D+1]
 - When the upper limit [S2, S2+1] < input value [S3, S3+1], the input value [S3, S3+1] - the upper limit [S2, S2+1] becomes the output value [D, D+1]
 - When the lower limit [S1, S1+1] ≤ input value [S3, S3+1] ≤ the upper limit [S2, S2+1], 0 becomes the output value [D, D+1]

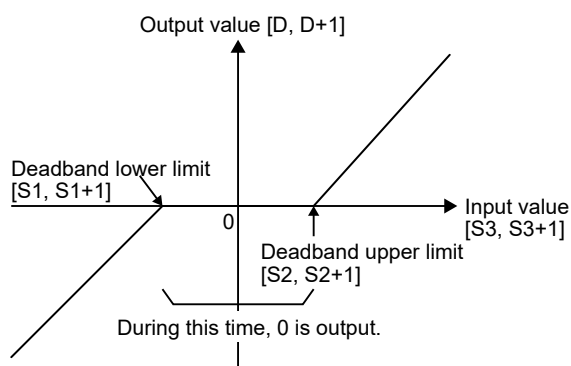

■ Operation example

Operation of instruction format description program

If K-10000 is stored in DT10 and DT11, and K10000 is stored in DT20 and DT21, the following operation is performed.

Values of DT30, and DT31	Values stored in DT40 and DT41
K-30000	K-20000
K-20000	K-10000
K-10000 to K10000	K0
K20000	K10000
K30000	K20000

■ Flag operations

Name	Description
R9007	Turns ON when the area is exceeded in index modification.
R9008 (ER)	ON when [S1] is greater than [S2]
R9009 (CY)	ON when the calculation result overflows or underflows
R900B (=)	Turns ON when the calculation result is "0"

26.16 F289 ZONE (16-bit Data Zone Control)

26.16 F289 ZONE (16-bit Data Zone Control)

Performs zone control (word).

■ Instruction format

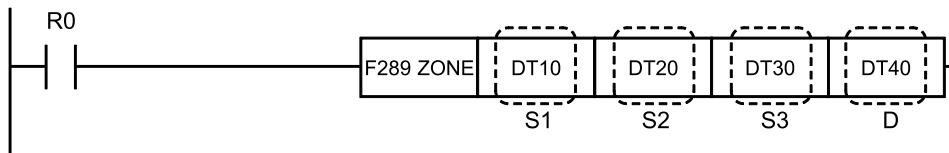

■ Operands

Items	Settings
S1	Area where negative bias value is stored, or negative bias value data
S2	Area where positive bias value is stored, or positive bias value data
S3	Area storing the input value or input value data
D	Area storing the output value

■ Devices that can be specified (indicated by ●)

Operands	WX	WY	WR	WL	SV	EV	DT	LD	I	SWR	SDT	Constant				Index modifier	Integer Device
												K	H	M	f		
S1	●	●	●	●	●	●	●	●	●	●	●	●	●		●		
S2	●	●	●	●	●	●	●	●	●	●	●	●	●		●		
S3	●	●	●	●	●	●	●	●	●	●	●	●	●		●		
D		●	●	●	●	●	●	●	●						●		

■ Outline of operation

- The bias value specified by [S1] or [S2] is added to the input value (word data) specified by [S3], and the output value is stored in the area specified by [D].
- The output value is determined based on the following conditions.
 - When input value [S3] < 0, input value [S3] + negative bias value [S1] → output value [D]
 - When input value [S3] = 0, 0 → output value [D]
 - When input value [S3] > 0, input value [S3] + positive bias value [S2] → output value [D]

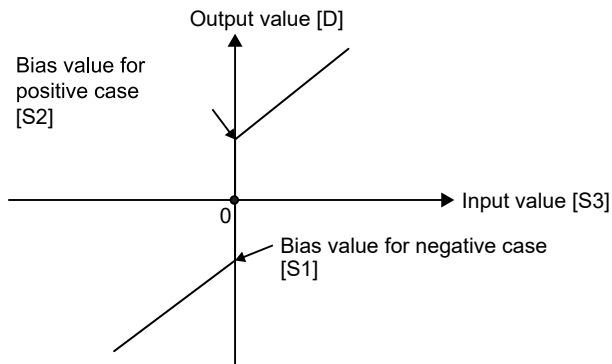

■ Operation example

Operation of instruction format description program

When K-100 is stored in DT10, and K100 is stored in DT20

Value of DT30	Value stored in DT40
K-300	K-400
K-200	K-300
K-100	K-200
K0	K0
K100	K200
K200	K300
K300	K400

■ Flag operations

Name	Description
R9007 R9008 (ER)	Turns ON when the area is exceeded in index modification.
R9009 (CY)	ON when the calculation result overflows or underflows
R900B (=)	Turns ON when the input value is "0"

26.17 F290 DZONE (32-bit Data Zone Control)

Carries out zone control (double word).

■ **Instruction format**

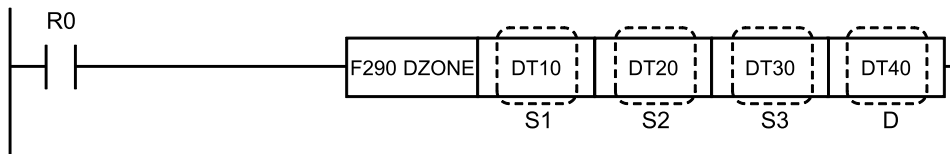

■ **Operands**

Items	Settings
S1	Area storing negative bias values, or negative bias value data (two words)
S2	Area storing positive bias values, or positive bias value data (two words)
S3	Area storing the input value, or input value data (two words)
D	Area storing the output value (two words)

■ **Devices that can be specified (indicated by ●)**

Operands	WX	WY	WR	WL	SV	EV	DT	LD	I	SWR	SDT	Constant				Index modifier	Integer Device
												K	H	M	f		
S1	●	●	●	●	●	●	●	●	●	●	●	●	●	●	●		
S2	●	●	●	●	●	●	●	●	●	●	●	●	●	●	●		
S3	●	●	●	●	●	●	●	●	●	●	●	●	●	●	●		
D		●	●	●	●	●	●	●	●						●		

■ **Outline of operation**

- The bias value specified by [S1] or [S2] is added to the input value (double-word data) specified by [S3], and stored in the area specified by [D].
- The output value is determined based on the following conditions.
 - When the input value [S3, S3+1] is less than 0, the input value [S3, S3+1] + the negative bias value [S1, S1+1] is the output value [D, D+1]
 - When the input values [S3, S3+1] equal zero, zero is stored in [D, D+1] as the output values
 - When the input values [S3, S3+1] are greater than zero, the input values [S3, S3+1] plus the positive bias values [S2, S2+1] are stored in [D, D+1] as the output values

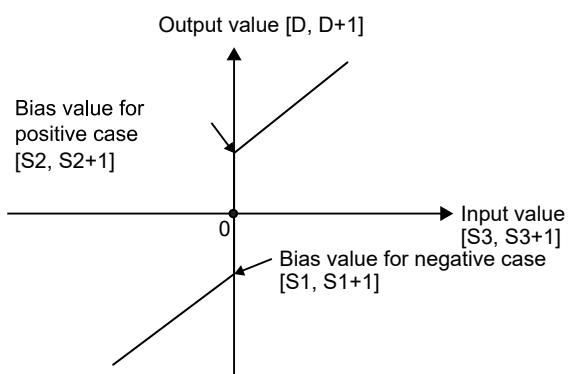

■ Operation example

Operation of instruction format description program

If K-10000 is stored in DT10 and DT11, and K10000 is stored in DT20 and DT21, the following operation is performed.

Values of DT30, and DT31	Values stored in DT40 and DT41
K-30000	K-40000
K-20000	K-30000
K-10000	K-20000
K0	K0
K10000	K20000
K20000	K30000
K30000	K40000

■ Flag operations

Name	Description
R9007 R9008 (ER)	Turns ON when the area is exceeded in index modification.
R9009 (CY)	ON when the calculation result overflows or underflows
R900B (=)	Turns ON when the input value is "0"

(MEMO)

27 Floating-point Instruction

27.1	F309 FMV (Floating Point Data Move)	27-3
27.2	F310 F+ (Floating Point Data Addition)	27-5
27.3	F311 F- (Floating Point Data Subtraction)	27-7
27.4	F312 F* (Floating Point Data Multiplication)	27-9
27.5	F313 F% (Floating Point Data Division)	27-11
27.6	F314 SIN (Floating Point Data Sine Operation)	27-13
27.7	F315 COS (Floating Point Data Cosine Operation)	27-15
27.8	F316 TAN (Floating Point Data Tangent Operation)	27-17
27.9	F317 ASIN (Floating Point Data Arcsine Operation)	27-19
27.10	F318 ACOS (Floating Point Data Arccosine Operation)	27-21
27.11	F319 ATAN (Floating Point Data Arctangent Operation)	27-23
27.12	F320 LN (Floating Point Data Natural Logarithmic Operation)	27-25
27.13	F321 EXP (Floating Point Data Exponent Operation)	27-27
27.14	F322 LOG (Floating Point Data Logarithm Operation)	27-29
27.15	F323 PWR (Floating Point Data Power Operation)	27-31
27.16	F324 FSQR (Floating Point Data Square Root Operation)	27-33
27.17	F325 FLT (16-bit Integer to Floating Point Data Conversion)	27-35
27.18	F326 DFLT (32-bit Integer to Floating Point Data Conversion)	27-36
27.19	F327 INT [Floating Point Data to 16-bit Integer Conversion (Largest Integer Not Exceeding the Floating-point Data)]	27-38
27.20	F328 DINT [Floating Point Data to 32-bit Integer Conversion (Largest Integer Not Exceeding the Floating-point Data)]	27-40
27.21	F329 FIX [Floating Point Data to 16-bit Integer Conversion (Round-down)]	27-42
27.22	F330 DFIX [Floating Point Data to 32-bit Integer Conversion (Round-down)]	27-44
27.23	F331 ROFF [Floating Point Data to 16-bit Integer Conversion (Round-off)]	27-46
27.24	F332 DROFF [Floating Point Data to 16-bit Integer Conversion (Round-off)]	27-48
27.25	F333 FINT (Floating Point Data Round-down)	27-50
27.26	F334 FRINT (Floating Point Data Round-off)	27-52

27 Floating-point Instruction

27.27 F335 F+/- (Floating Point Data Sign Conversion).....	27-54
27.28 F336 FABS (Floating Point Data Absolute Value Conversion)	27-56
27.29 F337 RAD (Degree to Radian Conversion)	27-58
27.30 F338 DEG (Radian to Degree Conversion)	27-60

27.1 F309 FMV (Floating Point Data Move)

Transfers the specified real number data to the specified area.

■ Instruction format

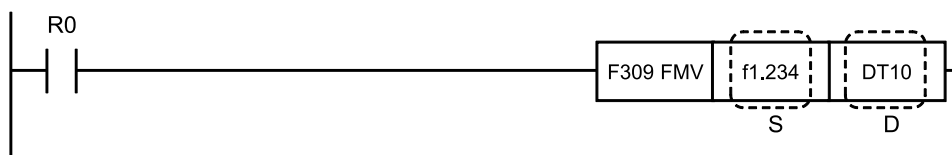

■ Operands

Items	Settings
S	Transfer data: Area storing real number data (32-bit), or constant data
D	Destination: Data transfer destination area

■ Devices that can be specified (indicated by ●)

Operands	WX	WY	WR	WL	SV	EV	DT	LD	I	SWR	SDT	Constant				Index modifier	Integer Device
												K	H	M	f		
S																●	
D		●	●	●	●	●	●	●	●							●	

■ Outline of operation

- The floating-point type real number data (32-bit) specified by [S] is transferred to the memory area specified by [D].
Specify a lower 16-bit memory area for the memory area.

Floating point real number data

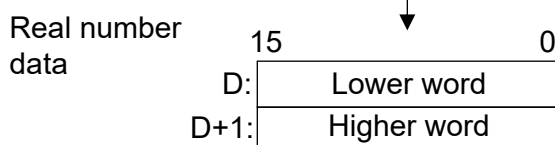

- The range of constants that can be specified in [S] is as follows.
Positive numbers f 0.0000001 to f 9999999
Negative numbers f -9999999 to f -0.000001

■ Operation example

Operation of instruction format description program

When the execution condition R0 is ON, the floating-point type constant value f 1.234 is transferred to data registers DT10 to DT11.

27.1 F309 FMV (Floating Point Data Move)

DT10:

(f1.234)

DT11:

■ Flag operations

Name	Description
R9007 R9008 (ER)	Turns ON when the area is exceeded in index modification.

27.2 F310 F+ (Floating Point Data Addition)

Adds real number data.

■ Instruction format

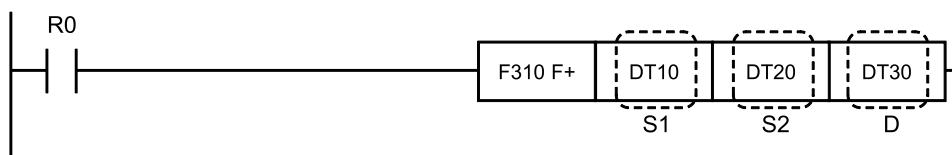

■ Operands

Items	Settings
S1	Area storing augend data, or augend data (two words)
S2	Area storing addend data, or addend data (two words)
D	Area storing the addition result (two words)

■ Devices that can be specified (indicated by ●)

Operands	WX	WY	WR	WL	SV	EV	DT	LD	I	SW R	SD T	Constant				Index modifier	Integer Device
												K	H	M	f		
S1	●	●	●	●	●	●	●	●	●	●	●	●	●	●	●	●	●
S2	●	●	●	●	●	●	●	●	●	●	●	●	●	●	●	●	●
D		●	●	●	●	●	●	●	●						●		●

■ Outline of operation

- The real number data specified by [S1, S1+1] and [S2, S2+1] is added, and the result is stored in [D, D+1].
[S1, S1+1] + [S2, S2+1] → [D, D+1]
- If [S1] and [S2] are specified with an integer device, the operation occurs after the integer data is internally converted to real numbers.

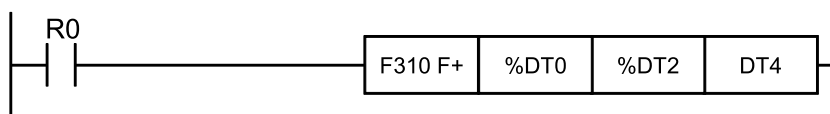

- If [D] is specified with an integer device, the real number is converted to integer data and stored.

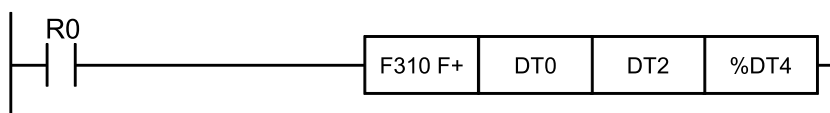

27.2 F310 F+ (Floating Point Data Addition)

- If a K constant is specified for [S1] or [S2], the same process is performed as if an integer device was specified.

■ Program example

- When R0 is turned ON, f 4.554 is stored in DT30 and DT31.

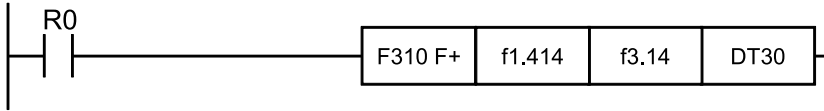

- When R0 is turned ON, f 135.795 is stored in DT30 and DT31.

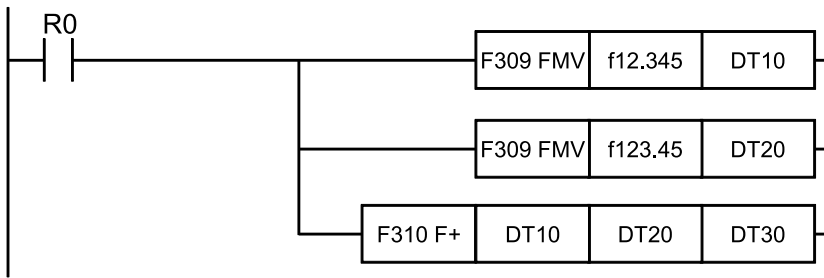

■ Flag operations

Name	Description
R9007	Turns ON when the area is exceeded in index modification.
R9008 (ER)	Turns ON when non-real-number data is specified in [S1, S1+1] or [S2, S2+1] Turns ON when the operation result exceeds the integer range when an integer device is specified in [D, D+1]
R9009 (CY)	Turns ON when operation result overflows

27.3 F311 F- (Floating Point Data Subtraction)

Subtracts real number data.

■ Instruction format

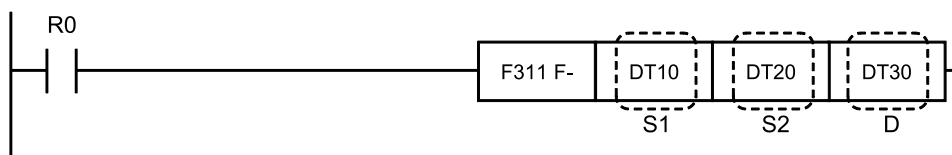

■ Operands

Items	Settings
S1	Area storing the minuend data, or the minuend data (two words)
S2	Area storing the subtrahend data, or the subtrahend data (two words)
D	Area storing the operation results (two words)

■ Devices that can be specified (indicated by ●)

Operands	WX	WY	WR	WL	SV	EV	DT	LD	I	SW R	SD T	Constant				Index modifier	Integer Device
												K	H	M	f		
S1	●	●	●	●	●	●	●	●	●	●	●	●	●	●	●	●	●
S2	●	●	●	●	●	●	●	●	●	●	●	●	●	●	●	●	●
D		●	●	●	●	●	●	●	●							●	●

■ Outline of operation

- The subtrahend data specified by [S2, S2+1] is subtracted from the minuend data specified by [S1, S1+1], and the result is stored in [D, D+1].
 $[S1, S1+1] - [S2, S2+1] \rightarrow [D, D+1]$
- If [S1] and [S2] are specified with an integer device, the operation occurs after the integer data is internally converted to real numbers.

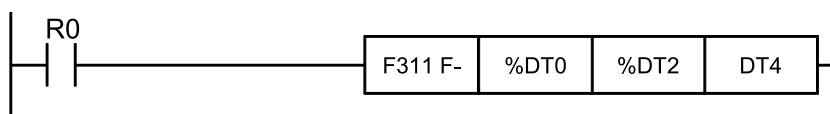

- If [D] is specified with an integer device, the real number is converted to integer data and stored.

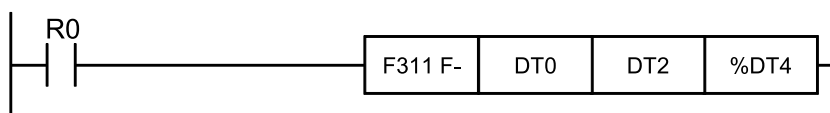

27.3 F311 F- (Floating Point Data Subtraction)

- If a K constant is specified for [S1] or [S2], the same process is performed as if an integer device was specified.

■ Program example

- When R0 turns ON, f 0.445 is stored in DT30 and DT31.

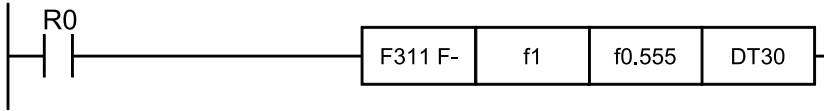

- When R0 turns ON, f 100.05 is stored in DT30 and DT31.

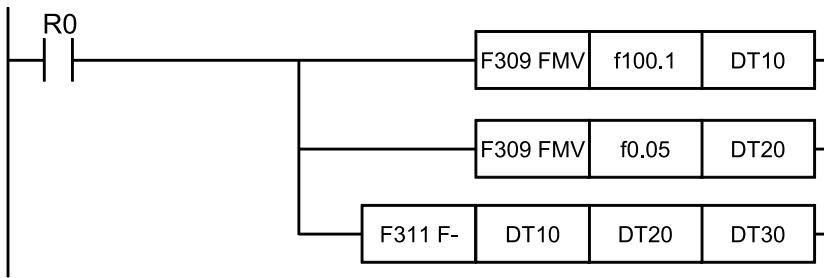

■ Flag operations

Name	Description
R9007	Turns ON when the area is exceeded in index modification.
R9008 (ER)	Turns ON when non-real-number data is specified in [S1, S1+1] or [S2, S2+1] Turns ON when the operation result exceeds the integer range when an integer device is specified in [D, D+1]
R9009 (CY)	Turns ON when operation result overflows

27.4 F312 F* (Floating Point Data Multiplication)

Multiplies real number data items.

■ Instruction format

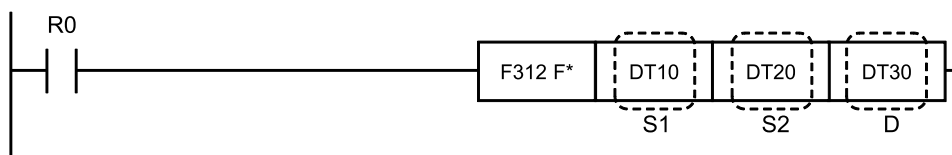

■ Operands

Items	Settings
S1	Area storing the multiplicand data, or the multiplicand data (two words)
S2	Area storing the multiplier data, or the multiplier data (two words)
D	Area storing the operation results (two words)

■ Devices that can be specified (indicated by ●)

Operands	WX	WY	WR	WL	SV	EV	DT	LD	I	SW R	SD T	Constant				Index modifier	Integer Device
												K	H	M	f		
S1	●	●	●	●	●	●	●	●	●	●	●	●	●	●	●	●	●
S2	●	●	●	●	●	●	●	●	●	●	●	●	●	●	●	●	●
D		●	●	●	●	●	●	●	●							●	●

■ Outline of operation

- Multiplies the multiplicand data specified by [S1, S1+1] and the multiplier data specified by [S2, S2+1], and stores the result in [D, D+1].
 $[S1, S1+1] \times [S2, S2+1] \rightarrow [D, D+1]$
- If [S1] and [S2] are specified with an integer device, the operation occurs after the integer data is internally converted to real numbers.

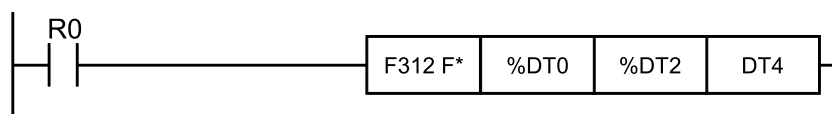

- If [D] is specified with an integer device, the real number is converted to integer data and stored.

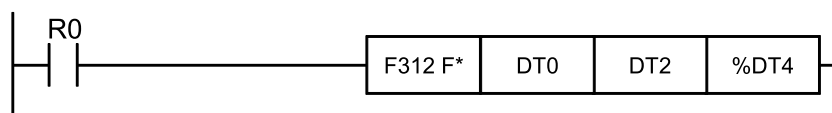

27.4 F312 F* (Floating Point Data Multiplication)

- If a K constant is specified for [S1] or [S2], the same process is performed as if an integer device was specified.

■ Program example

The f123.4000 is stored to DT30 and DT31 when the R0 turns ON.

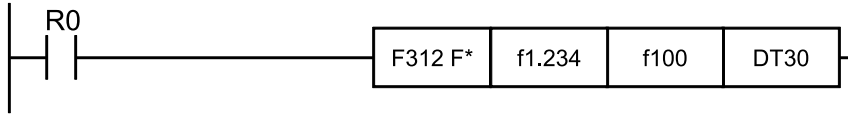

■ Flag operations

Name	Description
R9007	Turns ON when the area is exceeded in index modification.
R9008	Turns ON when non-real-number data is specified in [S1, S1+1] or [S2, S2+1]
(ER)	Turns ON when the operation result exceeds the integer range when an integer device is specified in [D, D+1]
R9009	Turns ON when operation result overflows
(CY)	

27.5 F313 F% (Floating Point Data Division)

Divides real number data.

■ Instruction format

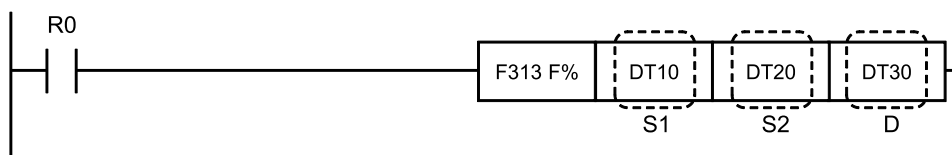

■ Operands

Items	Settings
S1	Area storing the dividend data, or dividend data (two words)
S2	Area storing the divisor data, or divisor data (two words)
D	Area storing the operation results (two words)

■ Devices that can be specified (indicated by ●)

Operands	WX	WY	WR	WL	SV	EV	DT	LD	I	SW R	SD T	Constant				Index modifier	Integer Device
												K	H	M	f		
S1	●	●	●	●	●	●	●	●	●	●	●	●	●	●	●	●	●
S2	●	●	●	●	●	●	●	●	●	●	●	●	●	●	●	●	●
D		●	●	●	●	●	●	●	●							●	●

■ Outline of operation

- Divides the dividend data specified by [S1, S1+1] by the divisor data specified by [S2, S2+1], and stores the result in [D, D+1].
 $[S1, S1+1] \div [S2, S2+1] \rightarrow [D, D+1]$
- If [S1] and [S2] are specified with an integer device, the operation occurs after the integer data is internally converted to real numbers.

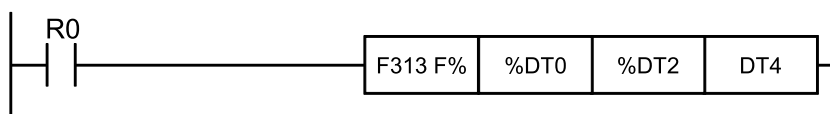

- If [D] is specified with an integer device, the real number is converted to integer data and stored.

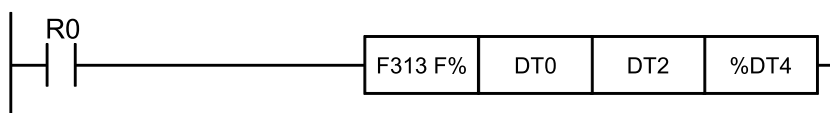

27.5 F313 F% (Floating Point Data Division)

- If a K constant is specified for [S1] or [S2], the same process is performed as if an integer device was specified.

■ Program example

When R0 turns ON, f5.432100 is stored to DT30 to DT31.

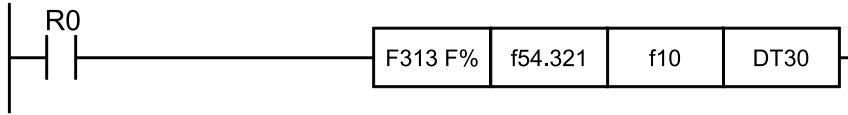

■ Flag operations

Name	Description
R9007 R9008 (ER)	Turns ON when the area is exceeded in index modification.
	Turns ON when non-real-number data is specified in [S1, S1+1] or [S2, S2+1]
	Turns ON when the operation result exceeds the integer range when an integer device is specified in [D, D+1]
	Turns ON when divided by 0.0
R9009 (CY)	Turns ON when operation result overflows

27.6 F314 SIN (Floating Point Data Sine Operation)

Calculates the trigonometric function $\sin()$.

■ Instruction format

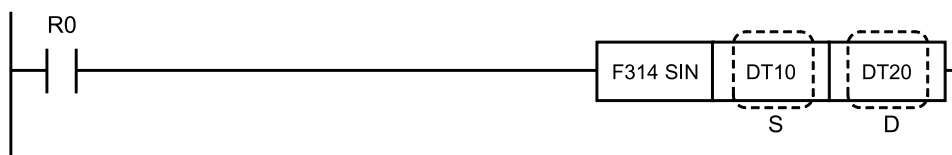

■ Operands

Items	Settings
S	Area storing angle data, or angle data (two words)
D	Area storing the operation results (two words)

■ Devices that can be specified (indicated by ●)

Operands	WX	WY	WR	WL	SV	EV	DT	LD	I	SWR	SDT	Constant				Index modifier	Integer Device
												K	H	M	f		
S	●	●	●	●	●	●	●	●	●	●	●	●	●	●	●	●	●
D		●	●	●	●	●	●	●	●						●		●

■ Outline of operation

- $\sin([S, S+1])$ of the angle data specified by $[S, S+1]$ (unit: radian) is calculated, and the result is stored in $[D, D+1]$.
 $\sin([S, S+1]) \rightarrow [D, D+1]$
- If $[S]$ is specified with an integer device, the operation occurs after the integer data is internally converted to real numbers.

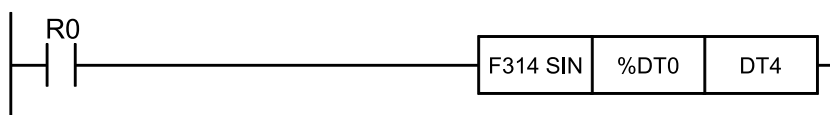

- If $[D]$ is specified with an integer device, the real number is converted to integer data and stored.

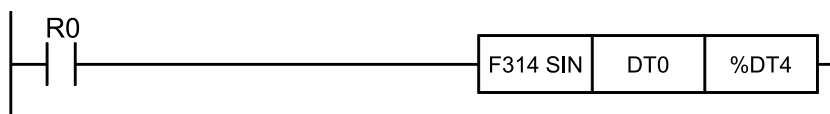

- If a K constant is specified for $[S]$, the same process is performed as if an integer device was specified.

27.6 F314 SIN (Floating Point Data Sine Operation)

■ Precautions for programming

The accuracy decreases as the absolute value of the input value increases. Where possible, use angle data within the range -2π radians \leq input $\leq 2\pi$ radians.

■ Program example

When R0 turns ON, f0.4999999 is stored in DT20 and DT21.

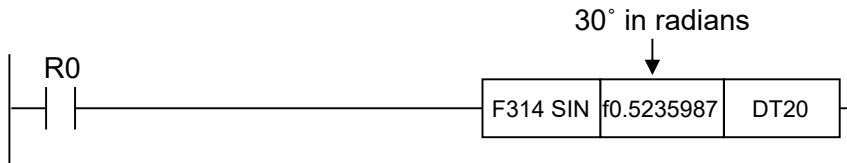

■ Flag operations

Name	Description
R9007 R9008 (ER)	Turns ON when the area is exceeded in index modification.
	Turns ON when non-real number data is specified in [S, S+1]
	Turns ON when the operation result exceeds the integer range when an integer device is specified in [D, D+1]
	Turns ON when the absolute value of the input value is 52707176 or higher
R9009 (CY)	Turns ON when operation result overflows
R900B (=)	Turns ON when the calculation result is "0"

27.7 F315 COS (Floating Point Data Cosine Operation)

Operates the trigonometric function $\cos()$.

■ Instruction format

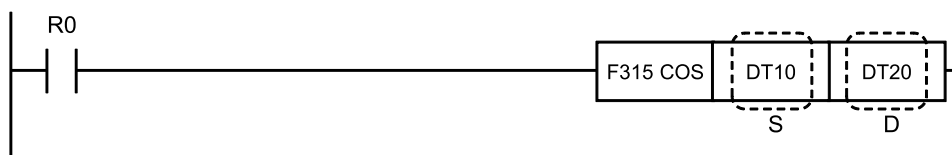

■ Operands

Items	Settings
S	Area storing angle data, or angle data (two words)
D	Area storing the operation results (two words)

■ Devices that can be specified (indicated by ●)

Operands	WX	WY	WR	WL	SV	EV	DT	LD	I	SWR	SDT	Constant				Index modifier	Integer Device
												K	H	M	f		
S	●	●	●	●	●	●	●	●	●	●	●	●	●	●	●	●	●
D		●	●	●	●	●	●	●	●						●		●

■ Outline of operation

- Calculates $\cos([S, S+1])$ of angle data (unit: radians) specified in $[S, S+1]$, and stores the result in $[D, D+1]$.
 $\cos([S, S+1]) \rightarrow [D, D+1]$
- If $[S]$ is specified with an integer device, the operation occurs after the integer data is internally converted to real numbers.

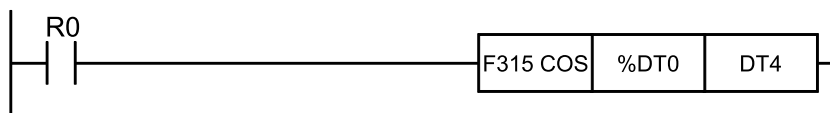

- If $[D]$ is specified with an integer device, the real number is converted to integer data and stored.

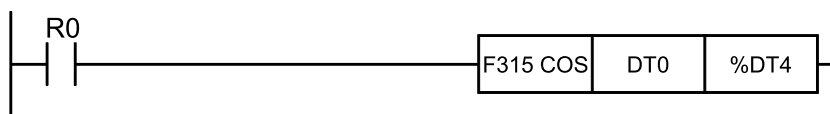

- If a K constant is specified for $[S]$, the same process is performed as if an integer device was specified.

27.7 F315 COS (Floating Point Data Cosine Operation)

■ Precautions for programming

The accuracy decreases as the absolute value of the input value increases. Where possible, use angle data within the range -2π radians \leq input $\leq 2\pi$ radians.

■ Program example

When R0 is ON, f 0.7071068 is stored in DT20 to DT21.

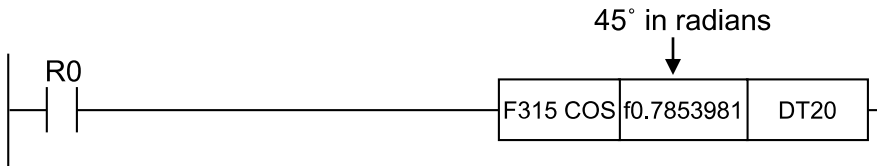

■ Flag operations

Name	Description
R9007 R9008 (ER)	Turns ON when the area is exceeded in index modification.
	Turns ON when non-real number data is specified in [S, S+1]
	Turns ON when the operation result exceeds the integer range when an integer device is specified in [D, D+1]
	Turns ON when the absolute value of the input value is 52707176 or higher
R9009 (CY)	Turns ON when operation result overflows
R900B (=)	Turns ON when the calculation result is "0"

27.8 F316 TAN (Floating Point Data Tangent Operation)

Calculates the trigonometrical function $\tan()$.

■ Instruction format

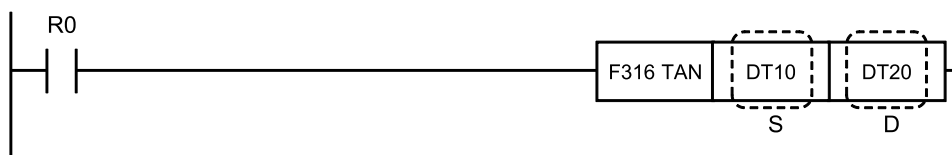

■ Operands

Items	Settings
S	Area storing angle data, or angle data (two words)
D	Area storing the operation results (two words)

■ Devices that can be specified (indicated by ●)

Operand s	WX	WY	WR	WL	SV	EV	DT	LD	I	SW R	SD T	Constant				Index modifier	Integer Device
												K	H	M	f		
S	●	●	●	●	●	●	●	●	●	●	●	●	●	●	●	●	●
D		●	●	●	●	●	●	●	●							●	●

■ Outline of operation

- The $\tan([S \text{ and } S+1])$ of angle data (unit: radians) specified by S and S+1 is calculated and the result stored in D and D+1.
 $\tan([S, S+1]) \rightarrow [D, D+1]$
- If [S] is specified with an integer device, the operation occurs after the integer data is internally converted to real numbers.

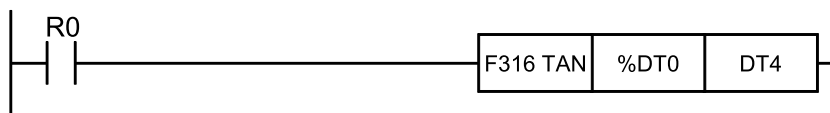

- If [D] is specified with an integer device, the real number is converted to integer data and stored.

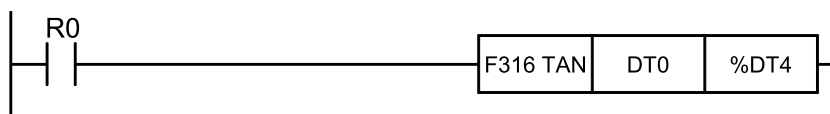

- If a K constant is specified for [S], the same process is performed as if an integer device was specified.

27.8 F316 TAN (Floating Point Data Tangent Operation)

■ Precautions for programming

The accuracy decreases as the absolute value of the input value increases. Where possible, use angle data within the range -2π radians \leq input $\leq 2\pi$ radians.

■ Program example

f 1.732048 is stored in DT20 and DT21 when R0 turns ON.

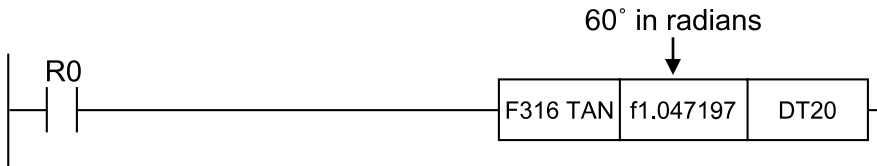

■ Flag operations

Name	Description
R9007 R9008 (ER)	Turns ON when the area is exceeded in index modification.
	Turns ON when non-real number data is specified in [S, S+1]
	Turns ON when the operation result exceeds the integer range when an integer device is specified in [D, D+1]
	Turns ON when the absolute value of the input value is 52707176 or higher
R9009 (CY)	Turns ON when operation result overflows
R900B (=)	Turns ON when the calculation result is "0"

27.9 F317 ASIN (Floating Point Data Arcsine Operation)

Calculates the trigonometric function $\text{SIN}^{-1}()$.

■ Instruction format

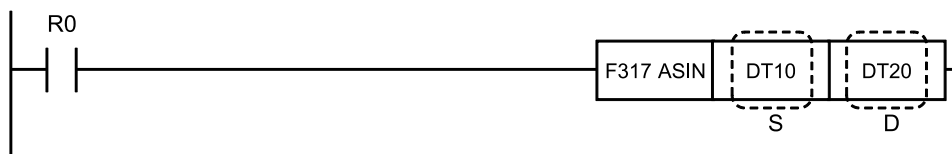

■ Operands

Items	Settings
S	Area storing angle data, or angle data (two words)
D	Area storing the operation results (two words)

■ Devices that can be specified (indicated by ●)

Operands	WX	WY	WR	WL	SV	EV	DT	LD	I	SWR	SDT	Constant				Index modifier	Integer Device
												K	H	M	f		
S	●	●	●	●	●	●	●	●	●	●	●	●	●	●	●	●	●
D		●	●	●	●	●	●	●	●							●	●

■ Outline of operation

- Calculates an angle from the SIN value specified in [S, S+1] and stores the result in [D, D+1] (in radians).

$$\text{SIN}^{-1}([S, S+1]) \rightarrow [D, D+1]$$

- If [S] is specified with an integer device, the operation occurs after the integer data is internally converted to real numbers.

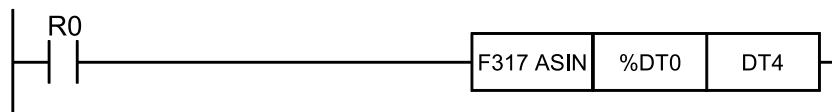

- If [D] is specified with an integer device, the real number is converted to integer data and stored.

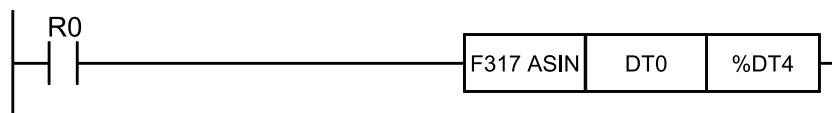

- If a K constant is specified for [S], the same process is performed as if an integer device was specified.

27.9 F317 ASIN (Floating Point Data Arcsine Operation)

■ Precautions for programming

[D, D+1] is stored in the following range:

$$-\pi/2 \leq [D, D+1] \leq \pi/2$$

[radians]

[radians]

■ Program example

f0.5235986 (30° radians) is stored in DT20 to DT21 when R0 turns ON.

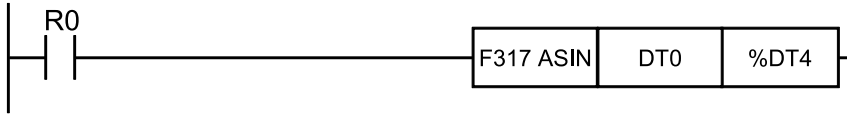

■ Flag operations

Name	Description
R9007 R9008 (ER)	Turns ON when the area is exceeded in index modification.
	Turns ON when non-real number data is specified in [S, S+1]
	Turns ON when [S, S+1] is not within the range $-1.0 \leq [S, S+1] \leq 1.0$
R9009 (CY)	Turns ON when the operation result exceeds the integer range when an integer device is specified in [D, D+1]
R900B (=)	Turns ON when the calculation result is "0"

27.10 F318 ACOS (Floating Point Data Arccosine Operation)

Calculates the trigonometric function $\text{COS}^{-1}()$.

■ Instruction format

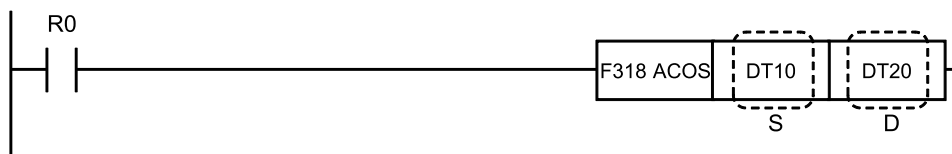

■ Operands

Items	Settings
S	Area storing angle data, or angle data (two words)
D	Area storing the operation results (two words)

■ Devices that can be specified (indicated by ●)

Operands	WX	WY	WR	WL	SV	EV	DT	LD	I	SW R	SD T	Constant				Index modifier	Integer Device
												K	H	M	f		
S	●	●	●	●	●	●	●	●	●	●	●	●	●	●	●	●	●
D		●	●	●	●	●	●	●	●							●	●

■ Outline of operation

- The angle from the COS value specified by [S, S+1] is calculated and the result (unit: radian) is stored in [D, D+1].

$$\text{COS}^{-1}([S, S+1]) \rightarrow [D, D+1]$$

- If [S] is specified with an integer device, the operation occurs after the integer data is internally converted to real numbers.

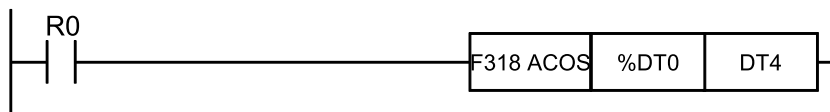

- If [D] is specified with an integer device, the real number is converted to integer data and stored.

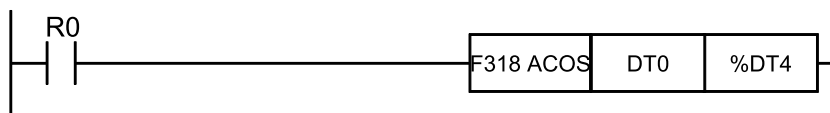

- If a K constant is specified for [S], the same process is performed as if an integer device was specified.

27.10 F318 ACOS (Floating Point Data Arccosine Operation)

■ Precautions for programming

[D, D+1] is stored in the following range:

$$0.0 \leq [D, D+1] \leq \pi$$

[radians] [radians]

■ Program example

When R0 turns ON, f0.7853980 (45° in radians) is stored in DT20 and DT21.

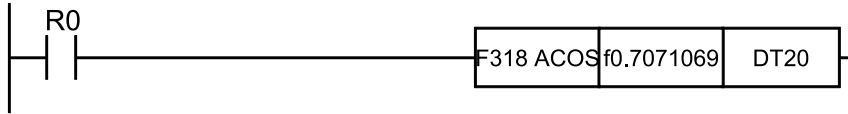

■ Flag operations

Name	Description
R9007 R9008 (ER)	Turns ON when the area is exceeded in index modification.
	Turns ON when non-real number data is specified in [S, S+1]
	Turns ON when [S, S+1] is not $-1.0 \leq [S, S+1] \leq 1.0$
R9009 (CY)	Turns ON when the operation result exceeds the integer range when an integer device is specified in [D, D+1]
R900B (=)	Turns ON when the calculation result is "0"

27.11 F319 ATAN (Floating Point Data Arctangent Operation)

Calculates the trigonometrical function $TAN^{-1}()$.

■ Instruction format

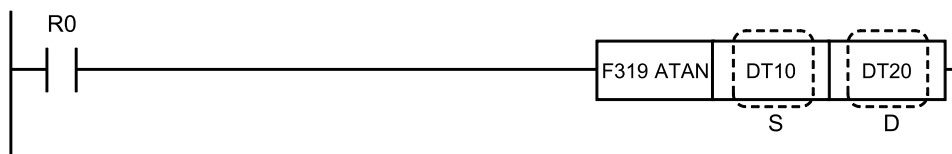

■ Operands

Items	Settings
S	Area storing angle data, or angle data (two words)
D	Area storing the operation results (two words)

■ Devices that can be specified (indicated by ●)

Operands	WX	WY	WR	WL	SV	EV	DT	LD	I	SW R	SD T	Constant				Index modifier	Integer Device
												K	H	M	f		
S	●	●	●	●	●	●	●	●	●	●	●	●	●	●	●	●	●
D		●	●	●	●	●	●	●	●							●	●

■ Outline of operation

- The angle from the TAN value specified by [S, S+1] is calculated and the result (unit: radian) is stored in [D, D+1].

$$TAN^{-1}([S, S+1]) \rightarrow [D, D+1]$$

- If [S] is specified with an integer device, the operation occurs after the integer data is internally converted to real numbers.

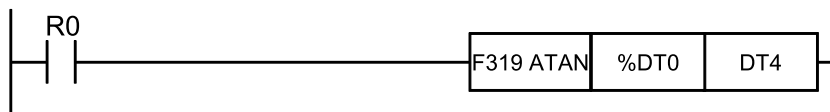

- If [D] is specified with an integer device, the real number is converted to integer data and stored.

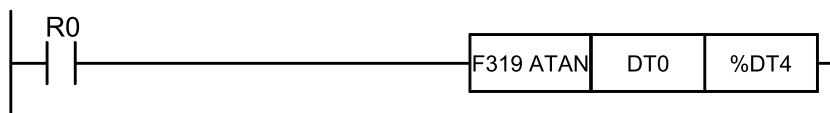

- If a K constant is specified for [S], the same process is performed as if an integer device was specified.

27.11 F319 ATAN (Floating Point Data Arctangent Operation)

■ Precautions for programming

[D, D+1] is stored in the following range:

$$-\pi/2 < [D, D+1] < \pi/2$$

[radians]

[radians]

■ Program example

f1.047197 (60° in radians) is stored in DT20 to DT21 when R0 turns ON.

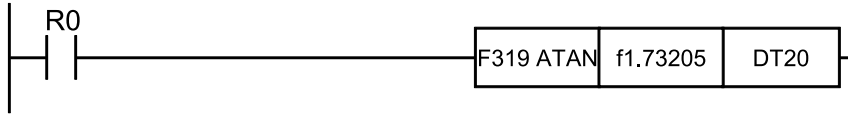

■ Flag operations

Name	Description
R9007	Turns ON when the area is exceeded in index modification.
R9008	Turns ON when non-real number data is specified in [S, S+1]
(ER)	Turns ON when the operation result exceeds the integer range when an integer device is specified in [D, D+1]
R9009	Turns ON when operation result overflows
(CY)	
R900B	Turns ON when the calculation result is "0"
(=)	

27.12 F320 LN (Floating Point Data Natural Logarithmic Operation)

Calculates the natural logarithm LN().

■ **Instruction format**

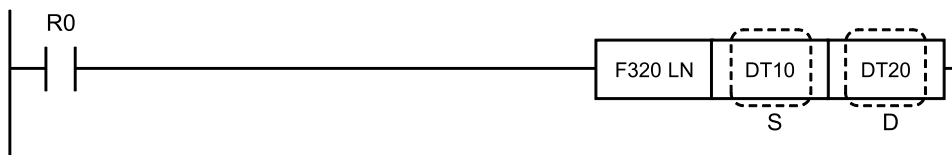

■ **Operands**

Items	Settings
S	Area storing angle data, or angle data (two words)
D	Area storing the operation results (two words)

■ **Devices that can be specified (indicated by ●)**

Operands	WX	WY	WR	WL	SV	EV	DT	LD	I	SWR	SDT	Constant				Index modifier	Integer Device
												K	H	M	f		
S	●	●	●	●	●	●	●	●	●	●	●	●	●	●	●	●	●
D		●	●	●	●	●	●	●	●							●	●

■ **Outline of operation**

- The natural logarithm LN ([S, S+1]) is calculated from the operation data specified by [S, S+1], and the result is stored in [D, D+1].
LN([S, S+1]) → [D, D+1]
- If [S] is specified with an integer device, the operation occurs after the integer data is internally converted to real numbers.

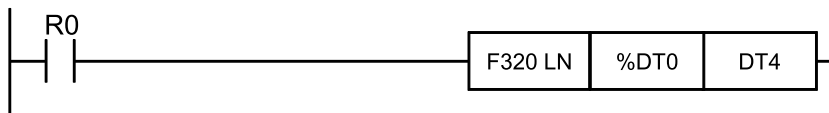

- If [D] is specified with an integer device, the real number is converted to integer data and stored.

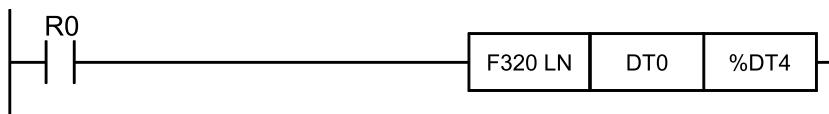

27.12 F320 LN (Floating Point Data Natural Logarithmic Operation)

■ Program example

- When R0 turns ON, f1.6094379 is stored in DT20 and DT21.

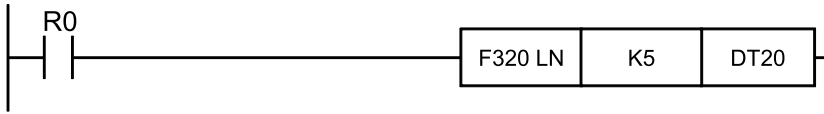

- When R0 turns ON, f-0.3160815 is stored in DT30 and DT31.

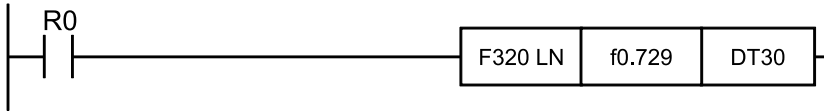

■ Flag operations

Name	Description
R9007 R9008 (ER)	Turns ON when the area is exceeded in index modification.
	Turns ON when non-real number data is specified in [S, S+1]
	Turns ON when [S, S+1] is not 0 < [S, S+1]
R9009 (CY)	Turns ON when the operation result exceeds the integer range when an integer device is specified in [D, D+1]
R900B (=)	Turns ON when the calculation result is "0"

27.13 F321 EXP (Floating Point Data Exponent Operation)

Calculates the exponent EXP().

■ **Instruction format**

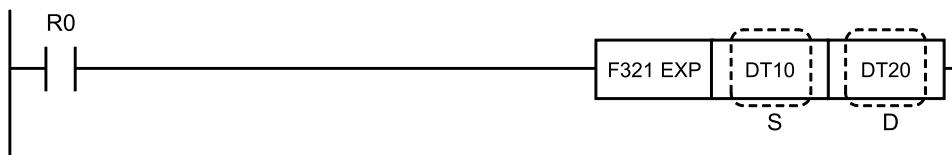

■ **Operands**

Items	Settings
S	Area storing angle data, or angle data (two words)
D	Area storing the operation results (two words)

■ **Devices that can be specified (indicated by ●)**

Operand s	WX	WY	WR	WL	SV	EV	DT	LD	I	SW R	SD T	Constant				Index modifier	Integer Device
												K	H	M	f		
S	●	●	●	●	●	●	●	●	●	●	●	●	●	●	●	●	●
D		●	●	●	●	●	●	●	●						●		●

■ **Outline of operation**

- The exponent EXP ([S, S+1]) is calculated from the operation data specified by [S, S+1], and the result is stored in [D, D+1].
 $EXP([S, S+1]) \rightarrow [D, D+1]$
 The calculation is performed with exponent base (e) equal to "2.718282".
- If [S] is specified with an integer device, the operation occurs after the integer data is internally converted to real numbers.

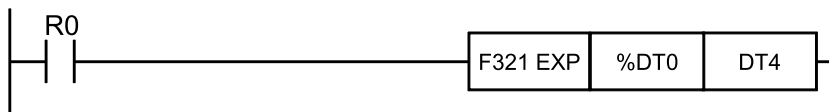

- If [D] is specified with an integer device, the real number is converted to integer data and stored.

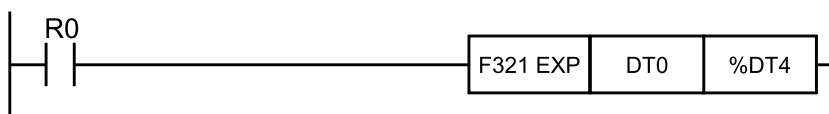

27.13 F321 EXP (Floating Point Data Exponent Operation)

■ Program example

- When R0 turns ON, f7.389056 is stored in DT20 and DT21.

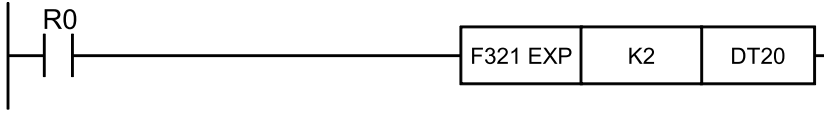

- When R0 turns ON, f221.406402 is stored in DT30 and DT31.

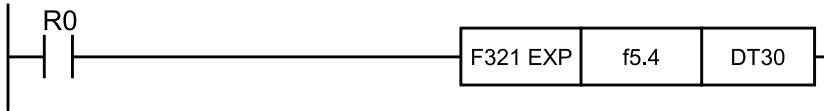

■ Flag operations

Name	Description
R9007	Turns ON when the area is exceeded in index modification.
R9008	Turns ON when non-real number data is specified in [S, S+1]
(ER)	Turns ON when the operation result exceeds the integer range when an integer device is specified in [D, D+1]
R9009 (CY)	Turns ON when operation result overflows
R900B (=)	Turns ON when the calculation result is "0"

27.14 F322 LOG (Floating Point Data Logarithm Operation)

Calculates the logarithm LOG().

■ **Instruction format**

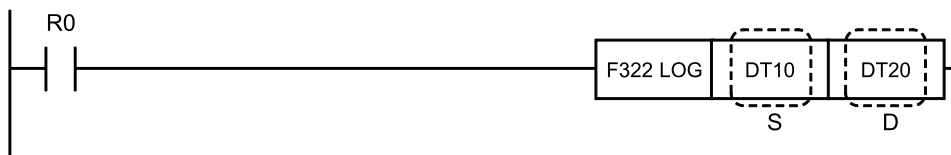

■ **Operands**

Items	Settings
S	Area storing angle data, or angle data (two words)
D	Area storing the operation results (two words)

■ **Devices that can be specified (indicated by ●)**

Operands	WX	WY	WR	WL	SV	EV	DT	LD	I	SWR	SDT	Constant				Index modifier	Integer Device
												K	H	M	f		
S	●	●	●	●	●	●	●	●	●	●	●	●	●	●	●	●	●
D		●	●	●	●	●	●	●	●							●	●

■ **Outline of operation**

- The logarithm LOG (S and S+1) is calculated using the data specified by S and S+1 and the result stored in D and D+1.
LOG([S, S+1]) -> [D, D+1]
- If [S] is specified with an integer device, the operation occurs after the integer data is internally converted to real numbers.

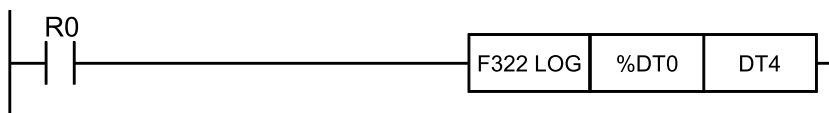

- If [D] is specified with an integer device, the real number is converted to integer data and stored.

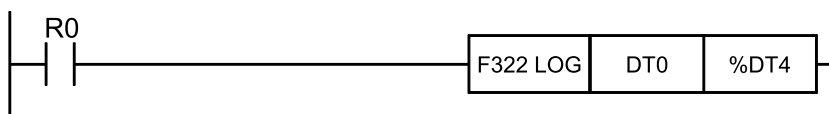

- If a K constant is specified for [S], the same process is performed as if an integer device was specified.

27.14 F322 LOG (Floating Point Data Logarithm Operation)

■ Program example

- f 1.30103 is stored in DT20 and DT21 when R0 turns ON.

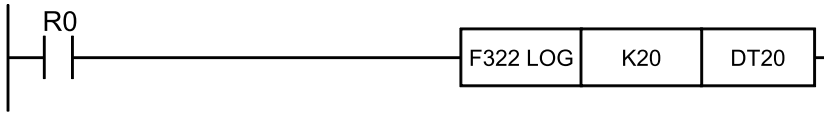

- f 0.0108932 is stored in DT30 and DT31 when R0 turns ON.

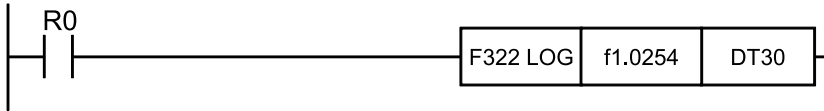

■ Flag operations

Name	Description
R9007 R9008 (ER)	Turns ON when the area is exceeded in index modification.
	Turns ON when non-real number data is specified in [S, S+1]
	Turns ON when [S, S+1] is not 0 < [S, S+1]
R9009 (CY)	Turns ON when the operation result exceeds the integer range when an integer device is specified in [D, D+1]
R900B (=)	Turns ON when the calculation result is "0"

27.15 F323 PWR (Floating Point Data Power Operation)

Calculates powers for real number data.

■ Instruction format

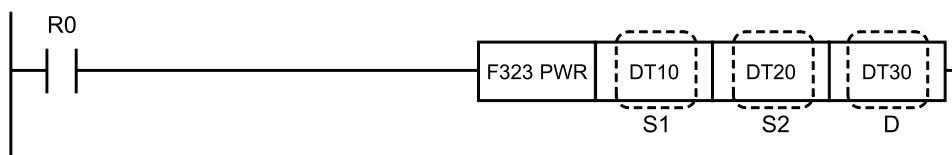

■ Operands

Items	Settings
S1	Area storing the base data, or base data (two words)
S2	Area storing the power data, or power data (two words)
D	Area storing the operation results (two words)

■ Devices that can be specified (indicated by ●)

Operands	WX	WY	WR	WL	SV	EV	DT	LD	I	SWR	SDT	Constant				Index modifier	Integer Device
												K	H	M	f		
S1	●	●	●	●	●	●	●	●	●	●	●	●	●	●	●	●	
S2	●	●	●	●	●	●	●	●	●	●	●	●	●	●	●	●	
D		●	●	●	●	●	●	●	●						●	●	

■ Outline of operation

- Raises the base data specified by [S1, S1+1] to the power data specified by [S2, S2+1], and stores the result in [D, D+1].

$$[S1, S1+1]^{[S2, S2+1]} \rightarrow [D, D+1]$$

- If [S1] and [S2] are specified with an integer device, the operation occurs after the integer data is internally converted to real numbers.

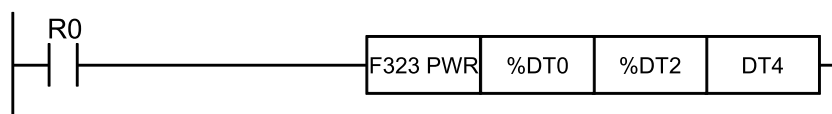

- If [D] is specified with an integer device, the real number is converted to integer data and stored.

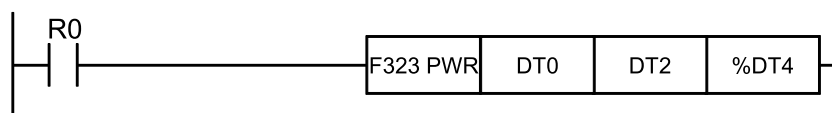

27.15 F323 PWR (Floating Point Data Power Operation)

- If a K constant is specified for [S1] or [S2], the same process is performed as if an integer device was specified.

■ Program example

- When R0 turns ON, f 625.0 is stored to DT20 to DT21.



- When R0 turns ON, f 30.51758 is stored to DT30 to DT31.



■ Flag operations

Name	Description
R9007 R9008 (ER)	Turns ON when the area is exceeded in index modification.
	Turns ON when non-real-number data is specified in [S1, S1+1] or [S2, S2+1]
	Turns ON when the power of negative number data is not an integer
R9009 (CY)	Turns ON when the operation result exceeds the integer range when an integer device is specified in [D, D+1]
R900B (=)	Turns ON when operation result overflows
	Turns ON when the calculation result is "0"

27.16 F324 FSQR (Floating Point Data Square Root Operation)

Calculates the square root of real number data.

■ Instruction format

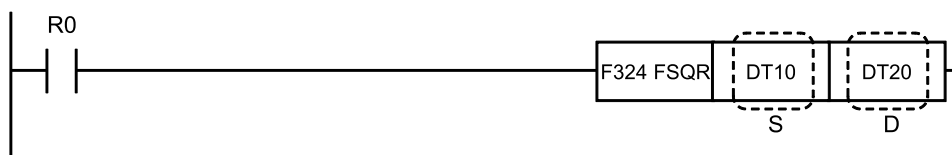

■ Operands

Items	Settings
S	Area storing operation data, or operation data (two words)
D	Area storing the operation results (two words)

■ Devices that can be specified (indicated by ●)

Operands	WX	WY	WR	WL	SV	EV	DT	LD	I	SWR	SDT	Constant				Index modifier	Integer Device
												K	H	M	f		
S	●	●	●	●	●	●	●	●	●	●	●	●	●	●	●	●	●
D		●	●	●	●	●	●	●	●						●		●

■ Outline of operation

- The square root of the operation data specified by [S, S+1] is calculated and the result is stored in [D, D+1].

$$\sqrt{[S, S+1]} \rightarrow [D, D+1]$$

- If [S] is specified with an integer device, the operation occurs after the integer data is internally converted to real numbers.

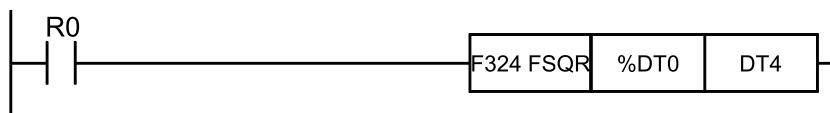

- If [D] is specified with an integer device, the real number is converted to integer data and stored.

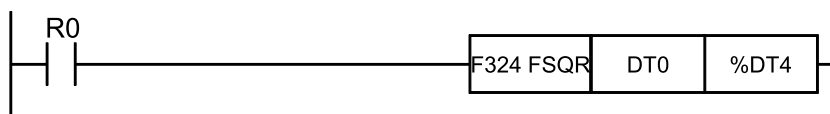

- If a K constant is specified for [S], the same process is performed as if an integer device was specified.

27.16 F324 FSQR (Floating Point Data Square Root Operation)

■ Program example

When R0 turns ON, f1.41421 is stored in DT20 and DT21.

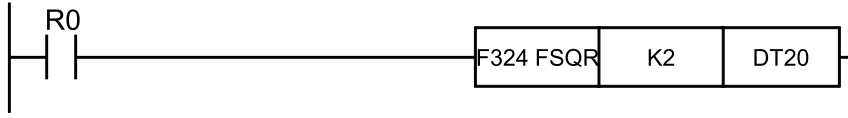

■ Flag operations

Name	Description
R9007 R9008 (ER)	Turns ON when the area is exceeded in index modification.
	Turns ON when non-real number data is specified in [S, S+1]
	Turns ON when [S, S+1] is not $0 \leq [S, S+1]$
R9009 (CY)	Turns ON when the operation result exceeds the integer range when an integer device is specified in [D, D+1]
R900B (=)	Turns ON when the calculation result is "0"

27.17 F325 FLT (16-bit Integer to Floating Point Data Conversion)

Converts 16-bit integer data to real number data.

■ Instruction format

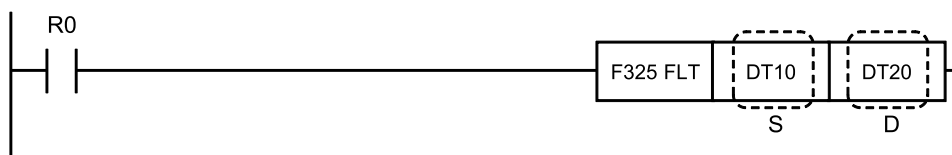

■ Operands

Items	Settings
S	Area storing operation data, or operation data (two words)
D	Area storing the operation results (two words)

■ Devices that can be specified (indicated by ●)

Operands	WX	WY	WR	WL	SV	EV	DT	LD	I	SWR	SDT	Constant				Index modifier	Integer Device
												K	H	M	f		
S	●	●	●	●	●	●	●	●	●	●	●	●	●	●	●	●	
D		●	●	●	●	●	●	●	●							●	

■ Outline of operation

Converts the operation data (signed 16-bit integer data) specified by [S] to real number data, and stores this in [D].

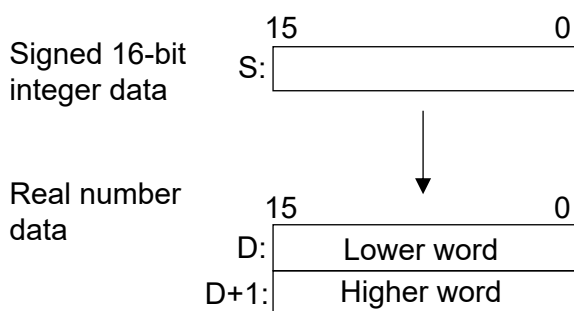

■ Flag operations

Name	Description
R9007 R9008 (ER)	Turns ON when the area is exceeded in index modification.
R900B (=)	Turns ON when the calculation result is "0"

27.18 F326 DFLT (32-bit Integer to Floating Point Data Conversion)

Converts 32-bit integers to real number data.

■ **Instruction format**

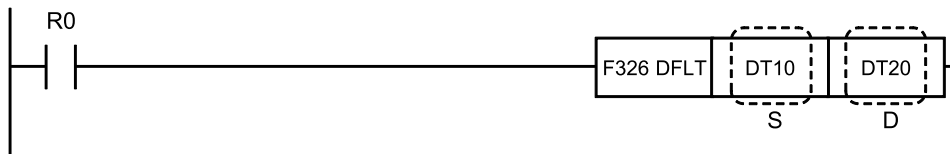

■ **Operands**

Items	Settings
S	Area storing operation data, or operation data (two words)
D	Area storing the operation results (two words)

■ **Devices that can be specified (indicated by ●)**

Operands	WX	WY	WR	WL	SV	EV	DT	LD	I	SWR	SDT	Constant				Index modifier	Integer Device
												K	H	M	f		
S	●	●	●	●	●	●	●	●	●	●	●	●	●	●	●	●	
D		●	●	●	●	●	●	●	●							●	

■ **Outline of operation**

The operation data (signed 32-bit integer data) specified by [S, S+1] is converted to real number data and stored in [D, D+1].

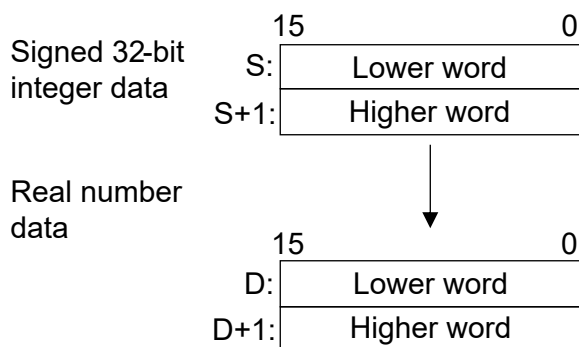

■ **Flag operations**

Name	Description
R9007 R9008 (ER)	Turns ON when the area is exceeded in index modification.

27.18 F326 DFLT (32-bit Integer to Floating Point Data Conversion)

Name	Description
R9009 (CY)	Turns ON when the significant digits of the mantissa for the operation result real number data cannot be obtained
R900B (=)	Turns ON when the calculation result is"0"

27.19 F327 INT [Floating Point Data to 16-bit Integer Conversion (Largest Integer Not Exceeding the Floating-point Data)]

27.19 F327 INT [Floating Point Data to 16-bit Integer Conversion (Largest Integer Not Exceeding the Floating-point Data)]

Converts real number data to 16-bit integers (largest integer not exceeding floating point real number).

■ Instruction format

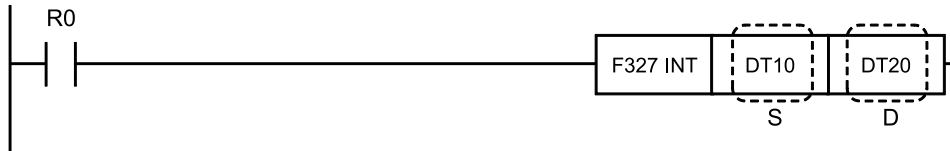

■ Operands

Items	Settings
S	Area storing operation data, or operation data (two words)
D	Area storing the operation results (two words)

■ Devices that can be specified (indicated by ●)

Operands	WX	WY	WR	WL	SV	EV	DT	LD	I	SWR	SDT	Constant				Index modifier	Integer Device
												K	H	M	f		
S	●	●	●	●	●	●	●	●	●	●	●	●	●	●	●		
D		●	●	●	●	●	●	●	●						●		

■ Outline of operation

The real number data (-32767.99 to +32767.99) specified by [S, S+1] is converted to signed 16-bit integers (largest integer not exceeding floating point real number) and stored in [D].

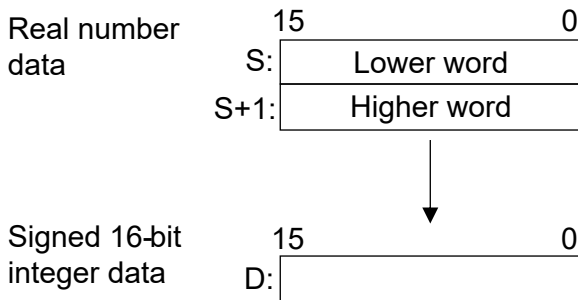

■ Operation example

Operation of instruction format description program

- If the real number 1.234 is stored in DT10 and DT11, the following operation is performed.

27.19 F327 INT [Floating Point Data to 16-bit Integer Conversion (Largest Integer Not Exceeding the Floating-point Data)]

DT10: (f1.234)
DT11:



DT20: (K1)

- If the real number -1.234 is stored in DT10 and DT11, the following operation is performed.

DT10: (f-1.234)
DT11:



DT20: (K-2)

■ Flag operations

Name	Description
R9007	Turns ON when the area is exceeded in index modification.
R9008	Turns ON when non-real number data is specified in [S, S+1]
(ER)	Turns ON when [D] exceeds the 16-bit integer range
R900B	Turns ON when the calculation result is "0"
(=)	

27.20 F328 DINT [Floating Point Data to 32-bit Integer Conversion (Largest Integer Not Exceeding the Floating-point Data)]

27.20 F328 DINT [Floating Point Data to 32-bit Integer Conversion (Largest Integer Not Exceeding the Floating-point Data)]

Converts real number data to 32-bit integers (largest integer not exceeding floating point real number).

■ Instruction format

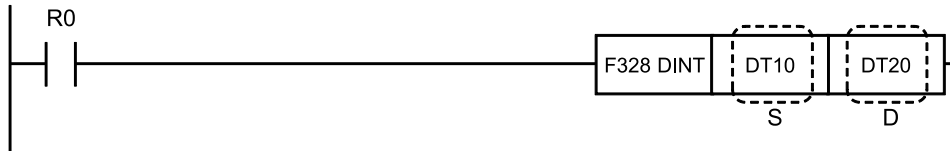

■ Operands

Items	Settings
S	Area storing operation data, or operation data (two words)
D	Area storing the operation results (two words)

■ Devices that can be specified (indicated by ●)

Operands	WX	WY	WR	WL	SV	EV	DT	LD	I	SWR	SDT	Constant				Index modifier	Integer Device
												K	H	M	f		
S	●	●	●	●	●	●	●	●	●	●	●	●	●	●	●		
D		●	●	●	●	●	●	●	●						●		

■ Outline of operation

The real number data (-2,147,483,000 to +2,147,483,000) specified by [S, S+1] is converted to signed 32-bit integers (largest integer not exceeding floating point real number) and stored in [D, D+1].

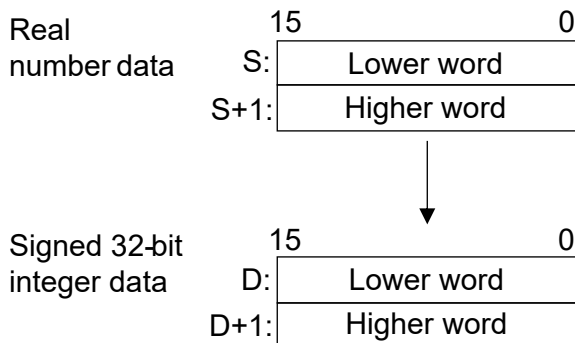

■ Operation example

Operation of instruction format description program

- If the real number 12345.67 is stored in DT10 and DT11, the following operation is performed.

27.20 F328 DINT [Floating Point Data to 32-bit Integer Conversion (Largest Integer Not Exceeding the Floating-point Data)]

DT10: (f12345.67)
DT11:



DT20: (K12345)
DT21:

- If the real number -12345.67 is stored in DT10 and DT11, the following operation is performed.

DT10: (f-12345.67)
DT11:



DT20: (K-12346)
DT21:

■ Flag operations

Name	Description
R9007	Turns ON when the area is exceeded in index modification.
R9008	Turns ON when non-real number data is specified in [S, S+1]
(ER)	Turns ON when [D, D+1] exceeds the 32-bit integer range
R900B (=)	Turns ON when the calculation result is "0"

27.21 F329 FIX [Floating Point Data to 16-bit Integer Conversion (Round-down)]

27.21 F329 FIX [Floating Point Data to 16-bit Integer Conversion (Round-down)]

Converts real number data to a 16-bit integer (rounded down to the nearest integer).

■ Instruction format

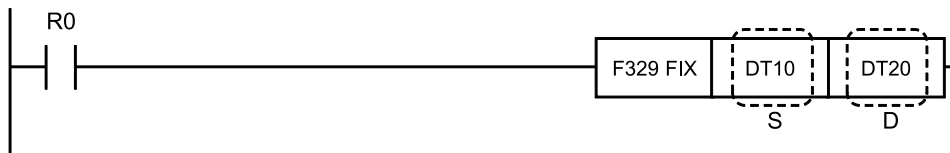

■ Operands

Items	Settings
S	Area storing operation data, or operation data (two words)
D	Area storing the operation results (two words)

■ Devices that can be specified (indicated by ●)

Operands	WX	WY	WR	WL	SV	EV	DT	LD	I	SW R	SD T	Constant				Index modifier	Integer Device
												K	H	M	f		
S	●	●	●	●	●	●	●	●	●	●	●	●	●	●	●	●	
D		●	●	●	●	●	●	●	●							●	

■ Outline of operation

Converts real number data specified in [S, S+1] (-32767.99 to +32767.99) to a signed 16-bit integer (rounded down to the nearest integer), and stores it in [D].

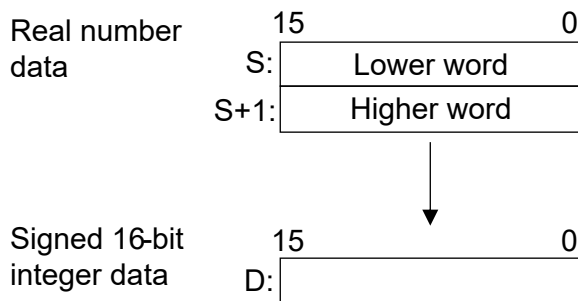

■ Operation example

Operation of instruction format description program

- When the real number 1.234567 is stored in DT10 and DT11, the following operation is performed.

DT10: (f1.234567)
 DT11:



DT20: (K1)

- When the real number -1.234567 is stored in DT10 and DT11, the following operation is performed.

DT10: (f-1.234567)
 DT11:



DT20: (K-1)

■ Flag operations

Name	Description
R9007	Turns ON when the area is exceeded in index modification.
R9008	Turns ON when non-real number data is specified in [S, S+1]
(ER)	Turns ON when [D] exceeds the 16-bit integer range
R900B	Turns ON when the calculation result is "0"
(=)	

27.22 F330 DFIX [Floating Point Data to 32-bit Integer Conversion (Round-down)]

27.22 F330 DFIX [Floating Point Data to 32-bit Integer Conversion (Round-down)]

Converts real number data to 32-bit integers (rounding down the decimal point).

■ Instruction format

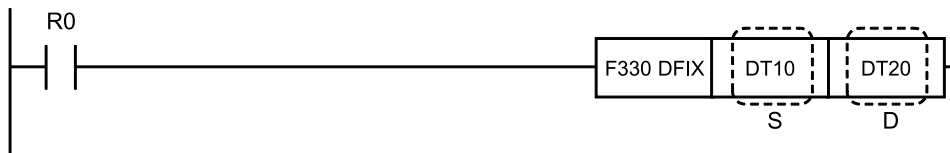

■ Operands

Items	Settings
S	Area storing operation data, or operation data (two words)
D	Area storing the operation results (two words)

■ Devices that can be specified (indicated by ●)

Operands	WX	WY	WR	WL	SV	EV	DT	LD	I	SW R	SD T	Constant				Index modifier	Integer Device
												K	H	M	f		
S	●	●	●	●	●	●	●	●	●	●	●	●	●	●	●		
D		●	●	●	●	●	●	●	●						●		

■ Outline of operation

The real number data (-2,147,483,000 to +2,147,483,000) specified by [S, S+1] is converted to signed 32-bit integers (rounding down the decimal point), and stored in [D, D+1].

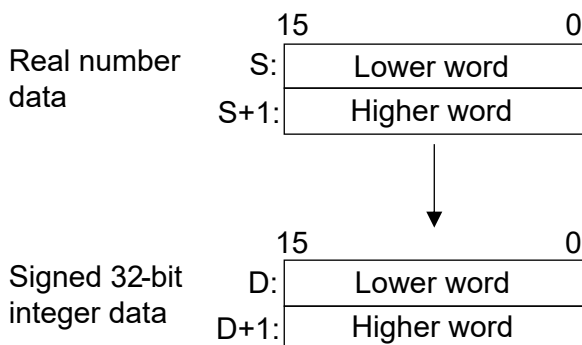

■ Operation example

Operation of instruction format description program

- If the real number 123456.7 is stored in DT10 to DT11, the following operation is performed.

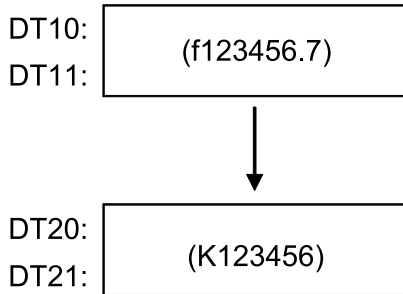

- If the real number -123456.7 is stored in DT10 to DT11, the following operation is performed.

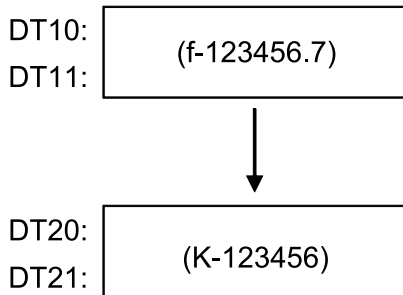

■ Flag operations

Name	Description
R9007	Turns ON when the area is exceeded in index modification.
R9008	Turns ON when non-real number data is specified in [S, S+1]
(ER)	Turns ON when [D, D+1] exceeds the 32-bit integer range
R900B	Turns ON when the calculation result is "0"
(=)	

27.23 F331 ROFF [Floating Point Data to 16-bit Integer Conversion (Round-off)]

27.23 F331 ROFF [Floating Point Data to 16-bit Integer Conversion (Round-off)]

Converts real number data to a 16-bit integer (rounded off to the nearest integer).

■ Instruction format

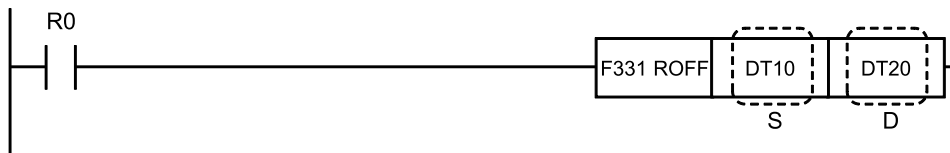

■ Operands

Items	Settings
S	Area storing operation data, or operation data (two words)
D	Area storing the operation results (two words)

■ Devices that can be specified (indicated by ●)

Operands	WX	WY	WR	WL	SV	EV	DT	LD	I	SWR	SDT	Constant				Index modifier	Integer Device
												K	H	M	f		
S	●	●	●	●	●	●	●	●	●	●	●	●	●	●	●	●	
D		●	●	●	●	●	●	●	●							●	

■ Outline of operation

Converts the real number data (-32767.99 to +32767.99) specified in [S, S+1] to a signed 16-bit integer (rounded off to the nearest integer) and stores it in [D].

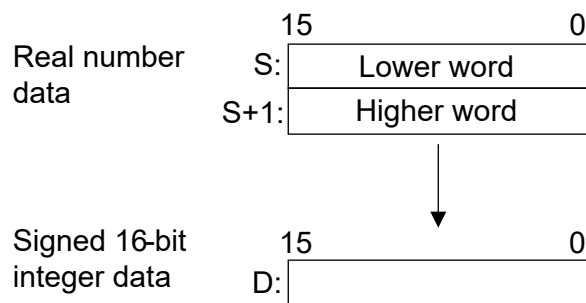

■ Operation example

Operation of instruction format description program

- When the real number 1234.567 is stored in DT10 and DT11, the following operation will be performed.

DT10: (f1234.567)
 DT11:



DT20: (K1235)

- When the real number -1234.567 is stored in DT10 and DT11, the following operation will be performed.

DT10: (f-1234.567)
 DT11:



DT20: (K-1235)

■ Flag operations

Name	Description
R9007	Turns ON when the area is exceeded in index modification.
R9008	Turns ON when non-real number data is specified in [S, S+1]
(ER)	Turns ON when [D] exceeds the 16-bit integer range
R900B	Turns ON when the calculation result is"0"
(=)	

27.24 F332 DROFF [Floating Point Data to 16-bit Integer Conversion (Round-off)]

27.24 F332 DROFF [Floating Point Data to 16-bit Integer Conversion (Round-off)]

Converts real number data to 32-bit integers (rounding off at the decimal point).

■ Instruction format

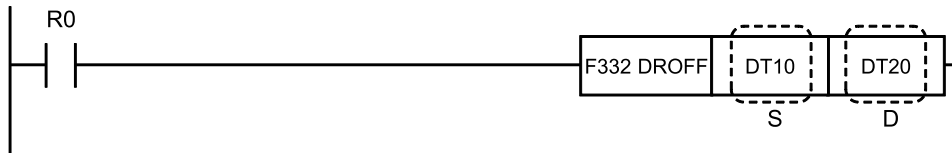

■ Operands

Items	Settings
S	Area storing operation data, or operation data (two words)
D	Area storing the operation results (two words)

■ Devices that can be specified (indicated by ●)

Operands	WX	WY	WR	WL	SV	EV	DT	LD	I	SW R	SD T	Constant				Index modifier	Integer Device
												K	H	M	f		
S	●	●	●	●	●	●	●	●	●	●	●	●	●	●	●		
D		●	●	●	●	●	●	●	●						●		

■ Outline of operation

The real number data specified by [S, S+1] (-2,147,483,000 to +2,147,483,000) is converted to signed 32-bit integers (rounding off at the decimal point) and stored in [D, D+1].

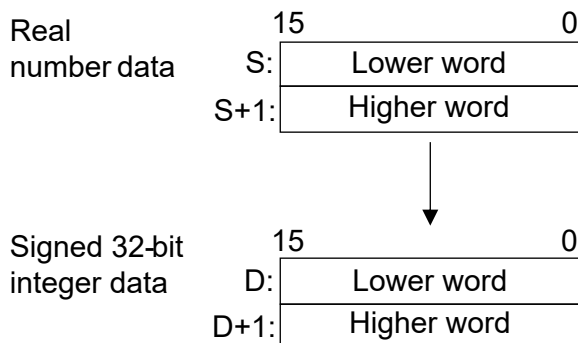

■ Operation example

Operation of instruction format description program

- If the real number 45678.51 is stored in DT10 and DT11, the following operation is performed.

DT10: (f45678.51)
DT11:



DT20: (K45679)
DT21:

- If the real number -45678.51 is stored in DT10 and DT11, the following operation is performed.

DT10: (f-45678.51)
DT11:



DT20: (K-45679)
DT21:

■ Flag operations

Name	Description
R9007	Turns ON when the area is exceeded in index modification.
R9008	Turns ON when non-real number data is specified in [S, S+1]
(ER)	Turns ON when [D, D+1] exceeds the 32-bit integer range
R900B (=)	Turns ON when the calculation result is "0"

27.25 F333 FINT (Floating Point Data Round-down)

Rounds down real number data at the decimal point. (The largest integer not exceeding the floating point type data)

■ **Instruction format**

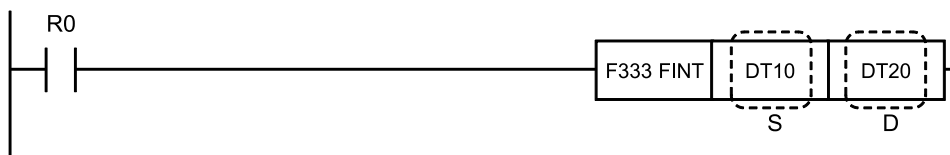

■ **Operands**

Items	Settings
S	Area storing operation data, or operation data (two words)
D	Area storing the operation results (two words)

■ **Devices that can be specified (indicated by ●)**

Operands	WX	WY	WR	WL	SV	EV	DT	LD	I	SWR	SDT	Constant				Index modifier	Integer Device
												K	H	M	f		
S	●	●	●	●	●	●	●	●	●	●	●	●	●	●	●		
D		●	●	●	●	●	●	●	●						●		

■ **Outline of operation**

The real number data specified by [S, S+1] is rounded down at the decimal point and the result is stored in [D, D+1].

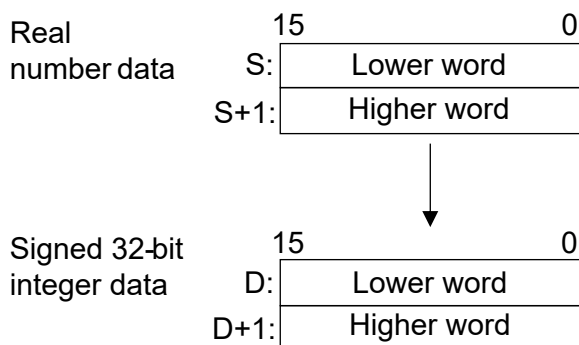

■ **Operation example**

Operation of instruction format description program

- When the real number 1234.567 is stored in DT10 and DT11, the following operation will be performed.

DT10: (f1234.567)
DT11:



DT20: (f1234.000)
DT21:

- When the real number -1234.567 is stored in DT10 and DT11, the following operation will be performed.

DT10: (f-1234.567)
DT11:



DT20: (f-1235.000)
DT21:

■ Flag operations

Name	Description
R9007	Turns ON when the area is exceeded in index modification.
R9008 (ER)	Turns ON when non-real number data is specified in [S, S+1]
R9009 (CY)	Turns ON when operation result overflows
R900B (=)	Turns ON when the calculation result is "0"

27.26 F334 FRINT (Floating Point Data Round-off)

Rounds off real number data to the first decimal place.

■ **Instruction format**

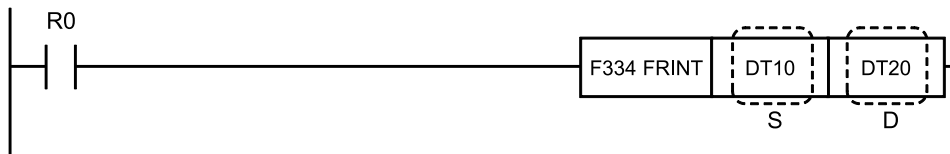

■ **Operands**

Items	Settings
S	Area storing operation data, or operation data (two words)
D	Area storing the operation results (two words)

■ **Devices that can be specified (indicated by ●)**

Operands	WX	WY	WR	WL	SV	EV	DT	LD	I	SWR	SDT	Constant				Index modifier	Integer Device
												K	H	M	f		
S	●	●	●	●	●	●	●	●	●	●	●	●	●	●	●		
D		●	●	●	●	●	●	●	●						●		

■ **Outline of operation**

The decimal part of the real number data specified by [S, S+1] is rounded off to the first decimal place, and the result is stored in [D, D+1].

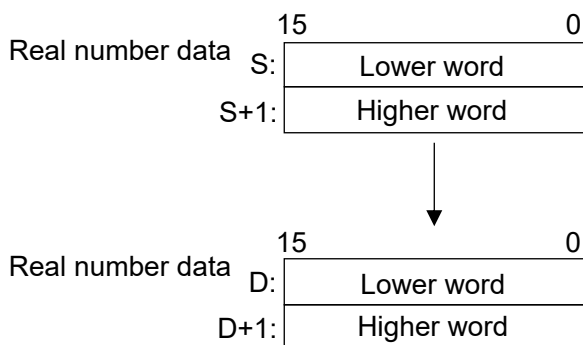

■ **Operation example**

Operation of instruction format description program

- When the real number 1234.567 is stored in DT10 and DT11, the following operation will be performed.

DT10: (f1234.567)
DT11:



DT20: (f1235.000)
DT21:

- When the real number -1234.567 is stored in DT10 and DT11, the following operation will be performed.

DT10: (f-1234.567)
DT11:



DT20: (f-1235.000)
DT21:

■ Flag operations

Name	Description
R9007	Turns ON when the area is exceeded in index modification.
R9008 (ER)	Turns ON when non-real number data is specified in [S, S+1]
R9009 (CY)	Turns ON when operation result overflows
R900B (=)	Turns ON when the calculation result is "0"

27.27 F335 F+/- (Floating Point Data Sign Conversion)

Changes the sign of real number data.

■ **Instruction format**

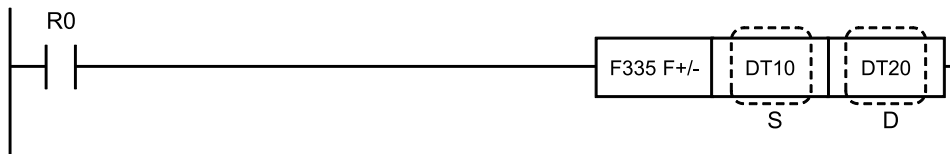

■ **Operands**

Items	Settings
S	Area storing operation data, or operation data (two words)
D	Area storing the operation results (two words)

■ **Devices that can be specified (indicated by ●)**

Operands	WX	WY	WR	WL	SV	EV	DT	LD	I	SWR	SDT	Constant				Index modifier	Integer Device
												K	H	M	f		
S	●	●	●	●	●	●	●	●	●	●	●	●	●	●	●	●	●
D		●	●	●	●	●	●	●	●							●	

■ **Outline of operation**

The sign for the real number data specified by [S, S+1] is changed and the result stored in [D, D+1].

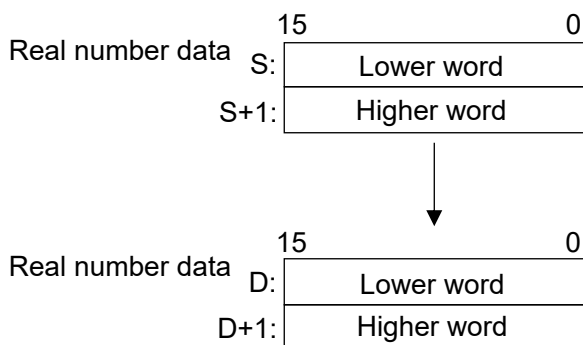

■ **Operation example**

Operation of instruction format description program

- If the real number "-60000.00" is stored in DT10 to DT11, the following operation will be performed.

DT10: (f-60000.00)
DT11:



DT20: (f60000.00)
DT21:

- If the real number "-30000.00" is stored in DT10 to DT11, the following operation will be performed.

DT10: (f-30000.00)
DT11:



DT20: (f30000.00)
DT21:

■ **Flag operations**

Name	Description
R9007	Turns ON when the area is exceeded in index modification.
R9008 (ER)	Turns ON when non-real number data is specified in [S, S+1]
R9009 (CY)	Turns ON when operation result overflows

27.28 F336 FABS (Floating Point Data Absolute Value Conversion)

27.28 F336 FABS (Floating Point Data Absolute Value Conversion)

Calculates the absolute value of real number data.

■ Instruction format

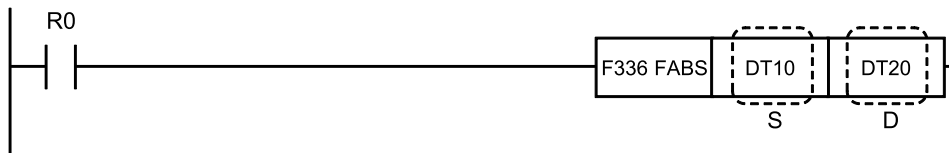

■ Operands

Items	Settings
S	Area storing operation data, or operation data (two words)
D	Area storing the operation results (two words)

■ Devices that can be specified (indicated by ●)

Operands	WX	WY	WR	WL	SV	EV	DT	LD	I	SWR	SDT	Constant				Index modifier	Integer Device
												K	H	M	f		
S	●	●	●	●	●	●	●	●	●	●	●	●	●	●	●	●	
D		●	●	●	●	●	●	●	●						●		

■ Outline of operation

- Calculates the absolute value of the real number data specified in [S, S+1], then stores the result in [D, D+1].

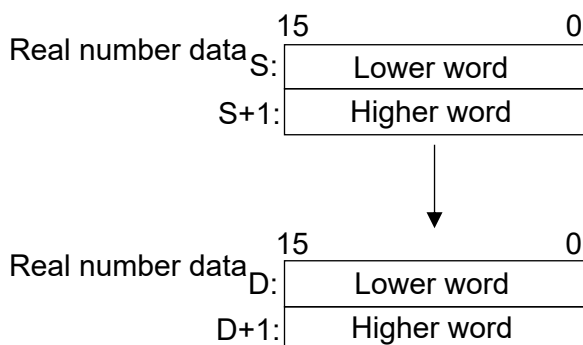

- If [S] is specified with an integer device, the operation occurs after the integer data is internally converted to real numbers.
- If a K constant is specified for [S], the same process is performed as if an integer device was specified.

■ Operation example

Operation of instruction format description program

27.28 F336 FABS (Floating Point Data Absolute Value Conversion)

- When the real number 1234.567 is stored in DT10 and DT11, the following operation will be performed.

DT10: (f1234.567)
DT11:



DT20: (f1234.567)
DT21:

- When the real number -1234.567 is stored in DT10 and DT11, the following operation will be performed.

DT10: (f-1234.567)
DT11:



DT20: (f1234.567)
DT21:

■ Flag operations

Name	Description
R9007	Turns ON when the area is exceeded in index modification.
R9008 (ER)	Turns ON when non-real number data is specified in [S, S+1]
R9009 (CY)	Turns ON when operation result overflows
R900B (=)	Turns ON when the calculation result is "0"

27.29 F337 RAD (Degree to Radian Conversion)

27.29 F337 RAD (Degree to Radian Conversion)

Converts the unit of an angle from [degrees] to [radians].

■ Instruction format

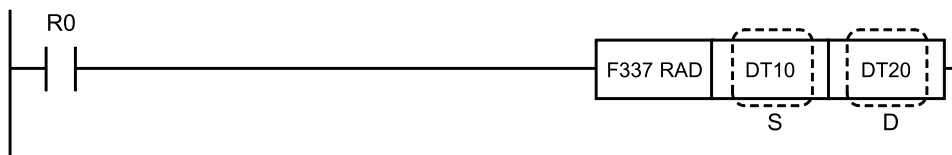

■ Operands

Items	Settings
S	Area storing angle [degrees] data, or angle [degrees] (two words)
D	Area (two word) to store the conversion result

■ Devices that can be specified (indicated by ●)

Operands	WX	WY	WR	WL	SV	EV	DT	LD	I	SWR	SDT	Constant				Index modifier	Integer Device
												K	H	M	f		
S	●	●	●	●	●	●	●	●	●	●	●	●	●	●	●	●	●
D		●	●	●	●	●	●	●	●						●		

■ Outline of operation

- The angle [degrees] specified by [S, S+1] is converted into an angle [radians] (real number data), and the result is stored in [D, D+1].

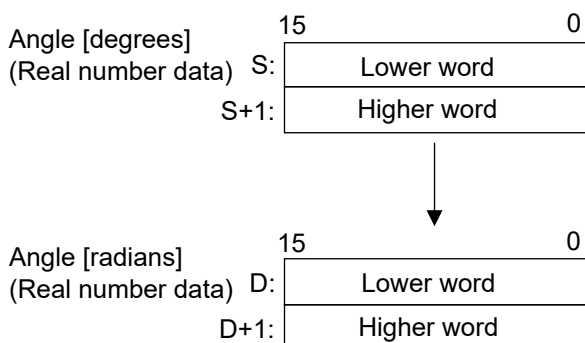

- If [S] is specified with an integer device, the operation occurs after the integer data is internally converted to real numbers.
- If a K constant is specified for [S], the same process is performed as if an integer device was specified.

■ Program example

When R0 turns ON, f0.7853981 is stored in DT20 and DT21.

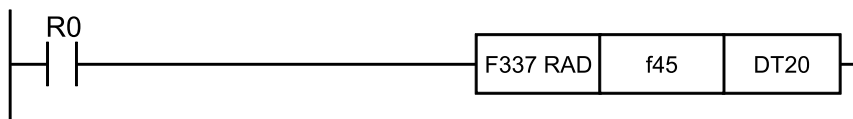

■ **Flag operations**

Name	Description
R9007	Turns ON when the area is exceeded in index modification.
R9008 (ER)	Turns ON when non-real number data is specified in [S, S+1]
R9009 (CY)	Turns ON when operation result overflows
R900B (=)	Turns ON when the calculation result is "0"

27.30 F338 DEG (Radian to Degree Conversion)

27.30 F338 DEG (Radian to Degree Conversion)

Converts the unit of an angle from radians to degrees.

■ Instruction format

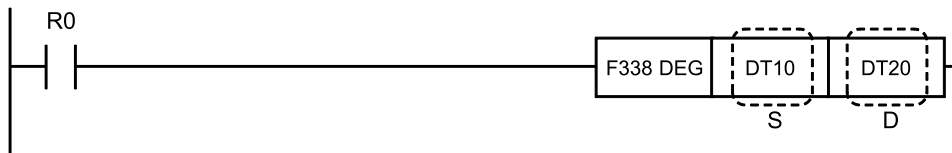

■ Operands

Items	Settings
S	Area storing angle data (radians), or angle data (radians) (two words)
D	Area (two words) to store the conversion result

■ Devices that can be specified (indicated by ●)

Operands	WX	WY	WR	WL	SV	EV	DT	LD	I	SWR	SDT	Constant				Index modifier	Integer Device
												K	H	M	f		
S	●	●	●	●	●	●	●	●	●	●	●	●	●	●	●	●	
D		●	●	●	●	●	●	●	●							●	●

■ Outline of operation

- The angle data in radians (real number data) specified by [S, S+1] is converted to angle data in degrees, and the result is stored in [D, D+1].

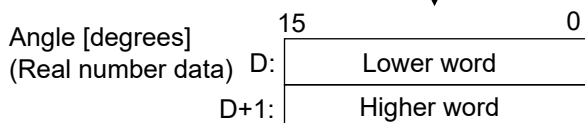
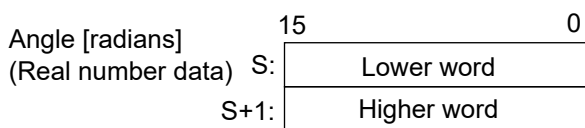

- If [D] is specified with an integer device, the real number is converted to integer data and stored.

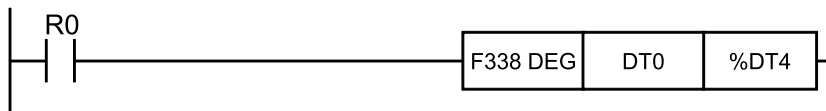

27.30 F338 DEG (Radian to Degree Conversion)

- If a K constant is specified for [S], the same process is performed as if an integer device was specified.

■ Program example

When R0 turns to ON, f30.00000 is stored in DT20 and DT21.

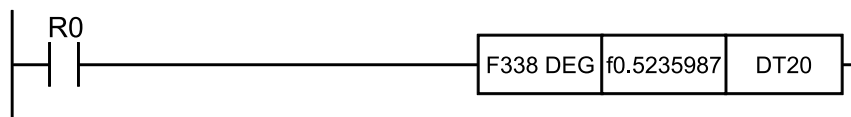

■ Precautions for programming

When a constant is specified for [S], an integer device cannot be specified for [D].

■ Flag operations

Name	Description
R9007	Turns ON when the area is exceeded in index modification.
R9008 (ER)	Turns ON when non-real number data is specified in [S, S+1] Turns ON when the operation result exceeds the integer range when an integer device is specified in [D, D+1]
R9009 (CY)	Turns ON when operation result overflows
R900B (=)	Turns ON when the calculation result is "0"

(MEMO)

28 Real Number Data Processing Instructions

28.1 F345 FCMP (Floating Point Data Comparison)	28-2
28.2 F346 FWIN (Floating Point Data Band Comparison).....	28-4
28.3 F347 FLIMIT (Floating Point Data Upper/Lower Limit Control).....	28-6
28.4 F348 FBAND (Floating Point Data Deadband Control)	28-8
28.5 F349 FZONE (Floating Point Data Zone Control).....	28-10
28.6 F354 FSCAL (Scaling of real number data).....	28-12

28.1 F345 FCMP (Floating Point Data Comparison)

28.1 F345 FCMP (Floating Point Data Comparison)

Compares real number data and outputs the judgment result to special internal relays.

■ Instruction format

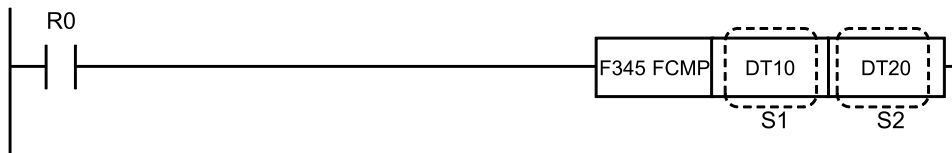

■ Operands

Items	Settings
S1	Area storing the real number data, or real number data (comparison data 1) (two words)
S2	Area storing the real number data, or real number data (comparison data 2) (two words)

■ Devices that can be specified (indicated by ●)

Operands	WX	WY	WR	WL	SV	EV	DT	LD	I	SWR	SDT	Constant				Index modifier	Integer Device
												K	H	M	f		
S1	●	●	●	●	●	●	●	●	●	●	●	●	●	●	●	●	●
S2	●	●	●	●	●	●	●	●	●	●	●	●	●	●	●	●	●

■ Outline of operation

- The real number data specified by [S1, S1+1] is compared with the real number data specified by [S2, S2+1], and the judgment result is output to the special internal relay flags (R9009 to R900C).
- The size relationship between [S1, S1+1] and [S2, S2+1] affects R9009 to R900C as follows.

Relationship between [S1, S1+1] and [S2, S2+1]	Flag			
	R900A	R900B	R900C	R9009
	>	=	<	Carry
[S1, S1+1]<[S2, S2+1]	OFF	OFF	ON	Indefinite
[S1, S1+1]=[S2, S2+1]	OFF	ON	OFF	OFF
[S1, S1+1]>[S2, S2+1]	ON	OFF	OFF	Indefinite

- If [S1] and [S2] are specified with an integer device, the operation occurs after the integer data is internally converted to real numbers.
- If a K constant is specified for [S1] or [S2], the same processing is performed as when an integer device is specified.

■ Flag operations

Name	Description
R9007 R9008	Turns ON when the area is exceeded in index modification.

28.1 F345 FCMP (Floating Point Data Comparison)

Name	Description
(ER)	Turns ON when non-real-number data is specified in [S1, S1+1] or [S2, S2+1]

28.2 F346 FWIN (Floating Point Data Band Comparison)

28.2 F346 FWIN (Floating Point Data Band Comparison)

Compares real number data with a band and outputs the judgment result to special internal relays.

■ Instruction format

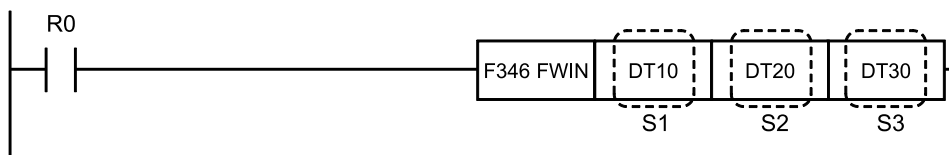

■ Operands

Items	Settings
S1	Comparison data: Area storing real number data, or real number data (two words)
S2	Lower limit data: Area storing real number data, or real number data (two words)
S3	Upper limit data: Area storing real number data, or real number data (two words)

■ Devices that can be specified (indicated by ●)

Operands	WX	WY	WR	WL	SV	EV	DT	LD	I	SWR	SDT	Constant				Index modifier	Integer Device
												K	H	M	f		
S1	●	●	●	●	●	●	●	●	●	●	●	●	●	●	●	●	●
S2	●	●	●	●	●	●	●	●	●	●	●	●	●	●	●	●	●
S3	●	●	●	●	●	●	●	●	●	●	●	●	●	●	●	●	●

■ Outline of operation

- A band comparison is performed on real number data.
The real number data specified by [S1, S1+1] is compared with the range specified by [S2, S2+1] (lower limit value) and [S3, S3+1] (upper limit value) to determine whether it falls in that range, and the comparison result is output to the special internal relays R9009 to R900C (comparison instruction judgment flags).
- The relationship between [S1, S1+1], [S2, S2+1], and [S3, S3+1] affects R9009 to R900C as follows.
x: Does not change.

Relationship between [S1, S1+1], [S2, S2+1], [S3, S3+1]	Flag			
	R900A	R900B	R900C	R9009
	>	=	<	Carry
[S1, S1+1] < [S2, S2+1]	OFF	OFF	ON	x
[S2, S2+1] ≤ [S1, S1+1] ≤ [S3, S3+1]	OFF	ON	OFF	x
[S3, S3+1] < [S1, S1+1]	ON	OFF	OFF	x

28.2 F346 FWIN (Floating Point Data Band Comparison)

- If [S1] to [S3] are specified with an integer device, the operation occurs after the integer data is internally converted to real numbers.
- If a K constant is specified for [S1], [S2], or [S3], the same process is performed as if an integer device was specified.

■ Flag operations

Name	Description
R9007	Turns ON when the area is exceeded in index modification.
R9008	Turns ON when non-real-number data is specified in [S1, S1+1], [S2, S2+1] or [S3, S3+1]
(ER)	Turns ON when [S2, S2+1] is greater than [S3, S3+1]

28.3 F347 FLIMT (Floating Point Data Upper/Lower Limit Control)

28.3 F347 FLIMT (Floating Point Data Upper/Lower Limit Control)

Performs upper and lower limit control (real number data).

■ Instruction format

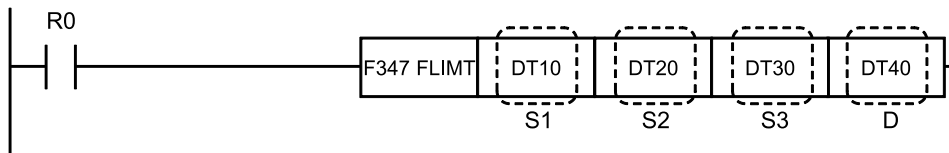

■ Operands

Items	Settings
S1	Area storing the lower limit, or lower limit data (two words)
S2	Area storing the upper limit, or upper limit data (two words)
S3	Area storing the input value, or input value data (two words)
D	Area storing the output value (two words)

■ Devices that can be specified (indicated by ●)

Operands	WX	WY	WR	WL	SV	EV	DT	LD	I	SWR	SDT	Constant				Index modifier	Integer Device
												K	H	M	f		
S1	●	●	●	●	●	●	●	●	●	●	●	●	●	●	●	●	●
S2	●	●	●	●	●	●	●	●	●	●	●	●	●	●	●	●	●
S3	●	●	●	●	●	●	●	●	●	●	●	●	●	●	●	●	●
D		●	●	●	●	●	●	●	●						●	●	●

■ Outline of operation

- The output value (real number data) stored in the area specified by [D] is controlled according to whether or not the input value (real number data) specified by [S3] falls within the range bounded by the upper and lower limits (real number data) specified by [S1] and [S2].
- The output value is determined based on the following conditions.
 - If lower limit value [S1, S1+1] is greater than input value [S3, S3+1], then lower limit value [S1, S1+1] becomes output value [D, D+1]
 - If upper limit value [S2, S2+1] is less than input value [S3, S3+1], then upper limit value [S2, S2+1] becomes output value [D, D+1]
 - If lower limit value [S1, S1+1] is equal to or less than input value [S3, S3+1], which is equal to or less than upper limit value [S2, S2+1], then input value [S3, S3+1] becomes output value [D, D+1]

28.3 F347 FLIMT (Floating Point Data Upper/Lower Limit Control)

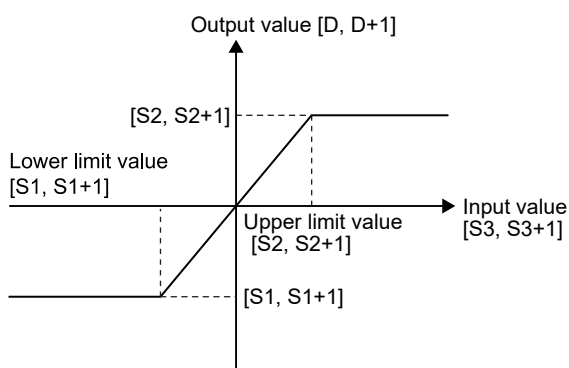

- If [S1] to [S3] are specified with an integer device, the operation occurs after the integer data is internally converted to real numbers.

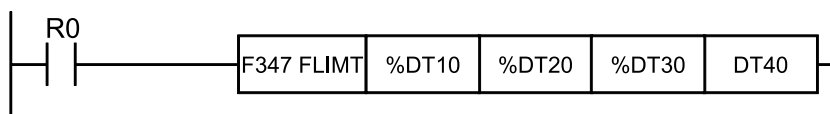

- If [D] is specified with an integer device, the real number is converted to integer data and stored.

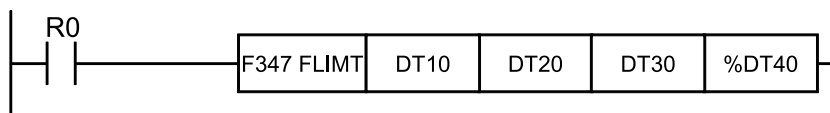

- If a K constant is specified for [S1], [S2], or [S3], the same process is performed as if an integer device was specified.

■ Flag operations

Name	Description
R9007 R9008 (ER)	Turns ON when the area is exceeded in index modification.
	Turns ON when non-real-number data is specified in [S1, S1+1], [S2, S2+1] or [S3, S3+1]
	Turns ON when [S1, S1+1] is greater than [S2, S2+1]
R900B (=)	Turns ON when the operation result exceeds the integer range when an integer device is specified in [D, D+1]
R900B (=)	Turns ON when the operation result falls within the upper/lower limit range

28.4 F348 FBAND (Floating Point Data Deadband Control)

28.4 F348 FBAND (Floating Point Data Deadband Control)

Performs dead-band control (real number data).

■ Instruction format

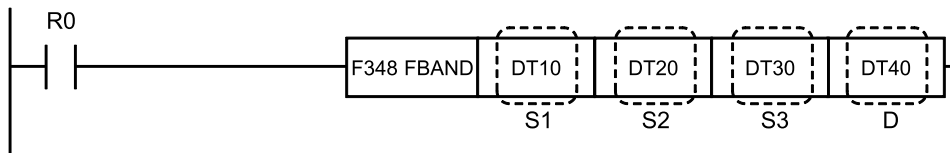

■ Operands

Items	Settings
S1	Area storing the lower limit, or lower limit data (two words)
S2	Area storing the upper limit, or upper limit data (two words)
S3	Area storing the input value, or input value data (two words)
D	Area storing the output value (two words)

■ Devices that can be specified (indicated by ●)

Operands	WX	WY	WR	WL	SV	EV	DT	LD	I	SWR	SDT	Constant				Index modifier	Integer Device
												K	H	M	f		
S1	●	●	●	●	●	●	●	●	●	●	●	●	●	●	●	●	●
S2	●	●	●	●	●	●	●	●	●	●	●	●	●	●	●	●	●
S3	●	●	●	●	●	●	●	●	●	●	●	●	●	●	●	●	●
D		●	●	●	●	●	●	●	●						●	●	●

■ Outline of operation

- The output value (real number data) stored in the area specified by [D] is controlled according to whether the input value (real number data) specified by [S3] is within the range of the upper and lower limits (real number data) of the dead-band specified by [S1] and [S2].
- The output value is determined based on the following conditions.
 - When the lower limit [S1, S1+1] > input value [S3, S3+1], the input value [S3, S3+1] - the lower limit [S1, S1+1] becomes the output value [D, D+1]
 - When the upper limit [S2, S2+1] < input value [S3, S3+1], the input value [S3, S3+1] - the upper limit [S2, S2+1] becomes the output value [D, D+1]
 - When the lower limit [S1, S1+1] ≤ input value [S3, S3+1] ≤ the upper limit [S2, S2+1], 0.0 becomes the output value [D, D+1]

28.4 F348 FBAND (Floating Point Data Deadband Control)

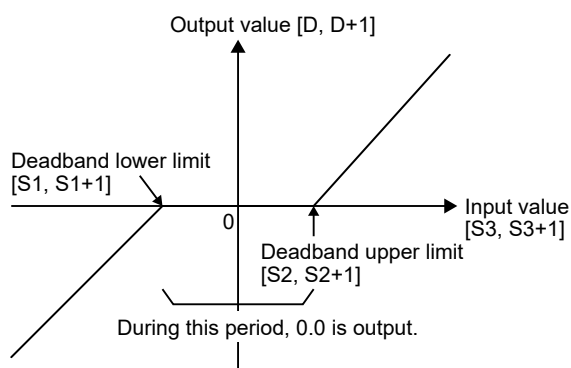

- If [S1] to [S3] are specified with an integer device, the operation occurs after the integer data is internally converted to real numbers.

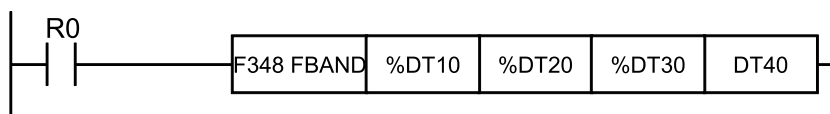

- If [D] is specified with an integer device, the real number is converted to integer data and stored.

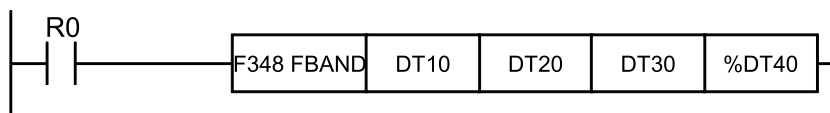

- If a K constant is specified for [S1], [S2], or [S3], the same process is performed as if an integer device was specified.

■ Flag operations

Name	Description
R9007 R9008 (ER)	Turns ON when the area is exceeded in index modification.
	Turns ON when non-real-number data is specified in [S1, S1+1], [S2, S2+1] or [S3, S3+1]
	Turns ON when [S1, S1+1] is greater than [S2, S2+1]
R9009 (CY)	Turns ON when the operation result exceeds the integer range when an integer device is specified in [D, D+1]
R900B (=)	Turns ON when operation result overflows
	Turns ON when the operation result falls within the upper/lower limit range

28.5 F349 FZONE (Floating Point Data Zone Control)

28.5 F349 FZONE (Floating Point Data Zone Control)

Performs zone control (real number data).

■ Instruction format

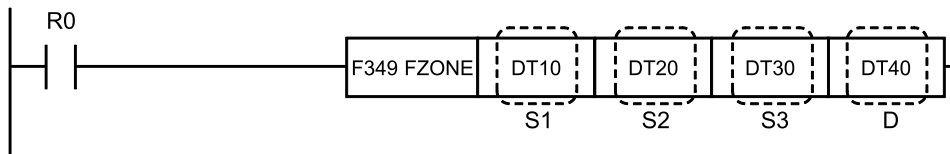

■ Operands

Items	Settings
S1	Area storing negative bias values, or negative bias value data (two words)
S2	Area storing positive bias values, or positive bias value data (two words)
S3	Area storing the input value, or input value data (two words)
D	Area storing the output value (two words)

■ Devices that can be specified (indicated by ●)

Operands	WX	WY	WR	WL	SV	EV	DT	LD	I	SWR	SDT	Constant				Index modifier	Integer Device
												K	H	M	f		
S1	●	●	●	●	●	●	●	●	●	●	●	●	●	●	●	●	●
S2	●	●	●	●	●	●	●	●	●	●	●	●	●	●	●	●	●
S3	●	●	●	●	●	●	●	●	●	●	●	●	●	●	●	●	●
D		●	●	●	●	●	●	●	●						●	●	●

■ Outline of operation

- The bias value specified in [S1] or [S2] is added to the input value (real number data) specified in [S3], and the result is stored in the area specified in [D].
- The output value is determined based on the following conditions.
 - When the input value [S3, S3+1] is less than 0.0, the input value [S3, S3+1] + the negative bias value [S1, S1+1] is the output value [D, D+1]
 - When the input value [S3, S3+1] is equal to 0.0, 0.0 is the output value [D, D+1]
 - When the input value [S3, S3+1] is more than 0.0, the input value [S3, S3+1] + the positive bias value [S2, S2+1] is the output value [D, D+1]

28.5 F349 FZONE (Floating Point Data Zone Control)

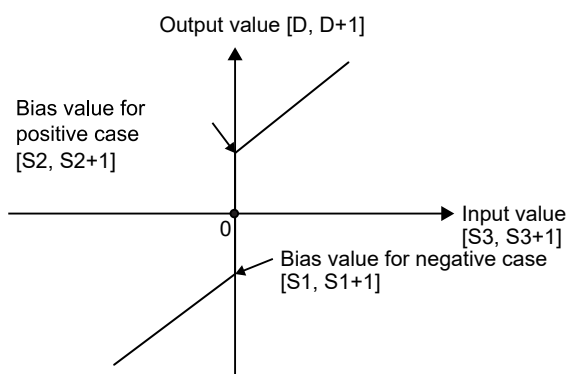

- If [S1] to [S3] are specified with an integer device, the operation occurs after the integer data is internally converted to real numbers.

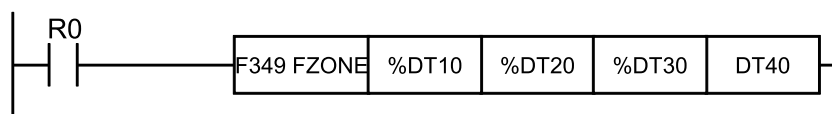

- If [D] is specified with an integer device, the real number is converted to integer data and stored.

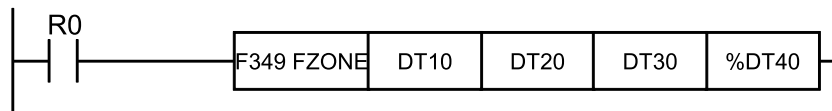

- If a K constant is specified for [S1], [S2], or [S3], the same process is performed as if an integer device was specified.

■ Flag operations

Name	Description
R9007	Turns ON when the area is exceeded in index modification.
R9008	Turns ON when non-real-number data is specified in [S1, S1+1], [S2, S2+1] or [S3, S3+1]
(ER)	Turns ON when the operation result exceeds the integer range when an integer device is specified in [D, D+1]
R9009	Turns ON when operation result overflows
(CY)	
R900B	Turns ON when the input value is "0"
(=)	

28.6 F354 FSCAL (Scaling of real number data)

28.6 F354 FSCAL (Scaling of real number data)

Performs scaling (linearization) using a real number data table and calculates the output (Y) for the input value (X).

■ Instruction format

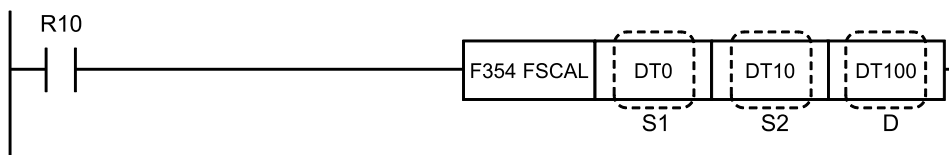

■ Operands

Items	Settings
S1	Real value or area representing the input value (X)
S2	Starting area of data table used for scaling
D	Area storing output value (Y)

■ Devices that can be specified (indicated by ●)

Operands	WX	WY	WR	WL	SV	EV	DT	LD	I	SWR	SDT	Constant				Index modifier	Integer Device
												K	H	M	f		
S1	●	●	●	●	●	●	●	●	●	●	●	●	●	●	●	●	
S2	●	●	●	●	●	●	●	●	●	●	●					●	
D		●	●	●	●	●	●	●	●							●	●

■ Outline of operation

- The input real value [S1] is scaled (linearized) according to the real number data table specified by [S2], and the output value is stored in [D].
- The section corresponding to the input value [S1] is searched from the table specified by [S2], the linear interpolation between these two points is calculated, and the output value is obtained.

When the specified input value is outside the registration range in the table, the start point (x0) or end point (xn) is stored for the output value (Y0 or Yn).

$[S1] \leq x0 [D] \leftarrow y0$

$[S1] \geq xn [D] \leftarrow yn$

■ Operation example

Operation of instruction format description program

The output value Y for the input value stored in DT0 is obtained by referring to the data table starting from DT10, and the result is stored in DT100.

S2:	Registration point count ($m \leftarrow n+1$)	DT10
S2+1:	x_0	DT11
S2+2:	(Real number value)	DT12
S2+3:	x_1	DT13
S2+4:	(Real number value)	DT14
~~~~~		
S2+2n+1:	$x_n$	DT29
S2+2n+2:	(Real number value)	DT30
S2+2n+3:	$y_0$	DT31
S2+2n+4:	(Real number value)	DT32
S2+2n+5:	$y_1$	DT33
S2+2n+6:	(Real number value)	DT34
~~~~~		
S2+4n+3:	y_n	DT49
S2+4n+4:	(Real number value)	DT50

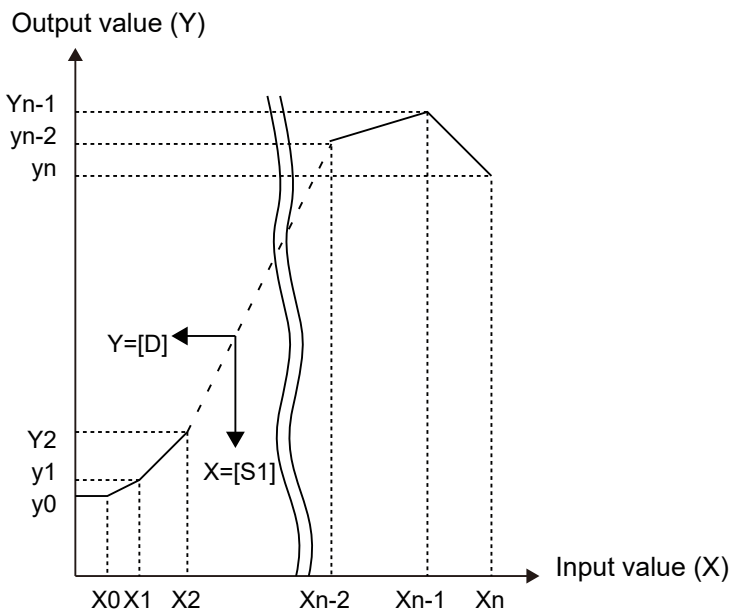

- The data table [S2] used for scaling must have two or more sections registered. In addition, the points must be registered in order from the smallest number on the X axis to the largest number.

$2 \leq \text{Number of registered points (m)} \leq 99$ [Number of registered points (m) = $n + 1$]

$x_{t-1} < x_t$ ($1 \leq t \leq n$)

- When the distance between two points on the data table is very large, an operation error will occur.

28.6 F354 FSCAL (Scaling of real number data)

(This occurs when the distance between two points cannot be represented by a real number.)

e.g.

First point: $(x_0, y_0) = (\text{HFF000000}, \text{HFF000000}) = (-1.7 \times 10^{34}, -1.7 \times 10^{34})$

Second point: $(x_1, y_1) = (\text{H7F000000}, \text{H7F000000}) = (+1.7 \times 10^{34}, +1.7 \times 10^{34})$

- The measurement error of the output result is proportional to the distance between two points of the data table.
- When an integer device is specified for the input value [S1], scaling is performed after converting it to a real value.
- When an integer device is specified for the output value [S2], the output result is converted to an integer value and stored.

■ Flag operations

Name	Description
R9007 R9008 (ER)	Turns ON when the area is exceeded in index modification.
	Turns ON when a non-real value is entered in [S1]
	Turns ON when $m < 2$ or $m > 99$ in the registered points of [S2]
	Turns ON when a non-real value is specified for the real value (xt, yt) specified in [S2]
	Turns ON when the data table of [S2] is not registered in ascending order of the X axis
	Turns ON when data table in [S2] exceeds area
	Turns ON when an overflow (calculation not possible) occurs in the scaling calculation
	Turns ON when the output result exceeds the integer range when an integer device is specified in [D]

29 Process Control Instructions

29.1 F355 PID (PID Operation).....	29-2
29.2 F356 EZPID (PID Operation: PWM Output Possible).....	29-9

29.1 F355 PID (PID Operation)

29.1 F355 PID (PID Operation)

PID operation is performed.

■ Instruction format

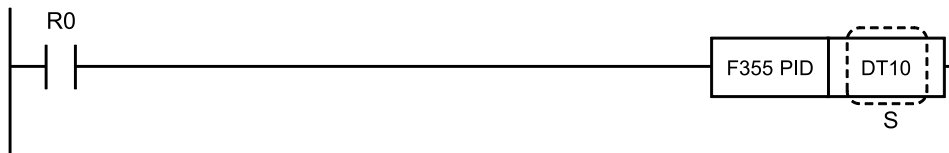

■ Operands

Items	Settings
S	Starting number of parameter area (30 word) for PID operation

■ Devices that can be specified (indicated by ●)

Operands	WX	WY	WR	WL	SV	EV	DT	LD	I	SWR	SDT	Constant				Index modifier	Integer Device
												K	H	M	f		
S							●										

■ Outline of operation

- PID operation is performed to match and hold the measurement value [S+2] at the setting value [S+1], and the result is output to [S+3].
- Derivative priority type or proportional-derivative priority type can be selected for PID operation.
- Set the coefficients (proportional gain, integral time, derivative time) used for PID operation and the operation type/interval in the parameter table. PID operation will be performed according to the specified content.

■ Types of PID operation

(1) Reverse operation / Forward operation

The vertical direction of output when there is a change to the process can be selected.

- Specify "Reverse operation" if increasing the output when the measured value falls. (Heating, etc.)
- Specify "Forward operation" if decreasing the output when the measured value rises. (Cooling, etc.)

(2) Derivative priority type PID / Proportional-derivative priority type PID

- In general, with "Derivative priority type PID control", there is increased fluctuation in the output when the set value changes, but convergence is faster.
- In general, with "Proportional-derivative priority type PID control", there is less output fluctuation when the set value changes, but convergence is slower.

Parameter table settings

[S]		Control mode
[S+1]		Set point value (SP)
[S+2]		Measured process value (PV)
[S+3]		Output value (MV)
[S+4]		Output lower limit
[S+5]		Output upper limit
[S+6]		Proportional gain (Kp)
[S+7]		Integral time (Ti)
[S+8]		Derivative time (Td)
[S+9]		Control interval (Ts)
[S+10]		Auto-tuning progress status
[S+11]		} Work area for PID operation
⋮		
⋮		
⋮		
⋮		
⋮		
⋮		
⋮		
⋮		
[S+29]		

Description of each parameter

(1) Control mode [S]

Specify the PID operation type and auto-tuning with H constants.

Control mode		[S] value	
		When not executing auto-tuning	When executing auto-tuning
Derivative type	Reverse	H0	H8000
	Forward	H1	H8001
Proportional-derivative type	Reverse	H2	H8002
	Forward	H3	H8003

- Auto-tuning

The optimal values for the PID parameters Kp, Ti, and Td are measured by measuring the process response.

When auto-tuning is executed, the estimated results are reflected in the parameter area after auto-tuning is complete. (Depending on the process, execution of auto-tuning may not be possible. In such cases, the process will return to the original parameter operation.)

For precautions regarding the execution of auto-tuning, please refer to "P.29-5".

- Reverse operation, forward operation

The vertical direction of output when there is a change to the process is determined.

Reverse	The output is increased if the measured value of the process falls. (e.g. heating)
Forward	The output is increased if the measured value of the process rises. (e.g. cooling)

29.1 F355 PID (PID Operation)

- Derivative priority type, proportional-derivative priority type PID

There is a change in output when the setting value is changed.

Derivative type	Generally, there is significant fluctuation when the setting value is changed, but convergence is fast.
Proportional-derivative type	Generally, there is less fluctuation when the setting value is changed, but convergence is slow.

(2) Set value (SP) [S+1]

Set the target value for the process control within the following range.

K0 to K10000

(3) Measured value (PV) [S+2]

Use an A/D conversion unit, etc., to input the current value of process control. Make sure it is within the following range.

K0 to K10000

(4) Output value (MV) [S+3]

The value from PID processing is stored. Use a D/A conversion unit, etc., to output to the process.

K0 to K10000

(5) Output lower limit [S+4]

K0 to K9999 (< upper limit)

(6) Output upper limit [S+5]

K1 to K10000 (> lower limit)

Specify the output value (MV) range. Values for the specified range are output.

Make sure that $0 \leq \text{output lower limit} < \text{output upper limit} \leq 10000$.

(7) Proportional gain (Kp) [S+6]

Specify the coefficient used for PID operation.

The setting value $\times 0.1$ is the actual proportional gain.

The setting value range is K1 to K9999 (0.1 to 999.9, specified in units of 0.1).

If auto-tuning is specified in the operation mode specifications, the setting value is automatically adjusted and rewritten.

(8) Integral time (Ti) [S+7]

Specify the coefficient used for PID operation.

Actual integral time is set point value $\times 0.1$.

The setting value range is K1 to K30000 (0.1 to 3000 seconds, specified in units of 0.1 second).

If 0 is specified, integration will not be executed.

If auto-tuning is specified in the operation mode specifications, the setting value is automatically adjusted and rewritten.

(9) Derivative time (Td) [S+8]

Specify the coefficient used for PID operation.

Actual derivative time is set point value $\times 0.1$.

The setting value range is K0 to K10000 (0 to 1000 seconds, specified in units of 0.1 second).

If auto-tuning is specified in the operation mode specifications, the setting value is automatically adjusted and rewritten.

(10) Control interval (Ts) [S+9]

Specify the interval for executing the PID operation. The setting value $\times 0.01$ is the actual control interval.

The setting value range is K1 to K6000 (0.01 to 60.0 seconds, specified in units of 0.01 second).

(11) Auto-tuning progress status [S+10]

When auto-tuning is specified in the operation mode, the degree of progress of auto-tuning is displayed. The values of K1 to K5 are stored according to the progress status from the default value [0], and are returned to the default value after auto-tuning is completed.

(12) Work area for PID operation [S+11] to [S+29]

The work area used by the system that is required for operations.

■ Precautions when executing auto-tuning

Note the following points if "Auto-tuning Execution" is set in the parameter table (control mode [S]).

- After auto-tuning is complete, the area of control mode [S] is automatically rewritten from H8000 to H8003, to H0 to H3. Make sure that it is not rewritten again by the program, etc.
- After auto-tuning is complete, the optimal values for proportional gain [Kp], integral time [Ti], and derivative time [Td] are stored, but it is necessary to specify appropriate values within the setting range (for example, the lower limit) before execution.
- After auto-tuning is complete, the optimal values for proportional gain [Kp], integral time [Ti], and derivative time [Td] are stored. Be careful that the stored values are not rewritten.
- The optimal values for Kp, Ti, and Td are calculated by auto-tuning determining the set point value (SP) by measuring the change of the measured value (PV) when the output value (MV) is set to the upper limit, causing the measured value (PV) to fluctuate, and then measuring the change of the measured value (PV) when the output value (MV) is set to the lower limit.
- The change of the output value (MV) for auto-tuning is completed after a minimum of 3 changes: upper limit output -> lower limit output -> upper limit output. If the auto-tuning progress status is still at 0 after several changes, shorten the control synchronization Ts and execute auto-tuning again.

■ Precautions for programming

- Including the work area for operation, a 30 word area is required for the parameter table. Take care that the values in this area are not rewritten by other instructions.
- Even if the parameter table exceeds the area, an error will not be detected. When specifying [S], specify a number that is within a minimum of 30 words from the last number.
- Take care that the area is not exceeded by index modification. Even if the area is exceeded, an error will not be detected.
- Use an A/D conversion unit, etc., to input the current value of the measured value [S+2].
- Use a D/A conversion unit, etc., to output the result of PID processing [S+3] to the process.
- If two or more PID instructions specifying the same table are included in the program, it may not operate correctly.

<Example>

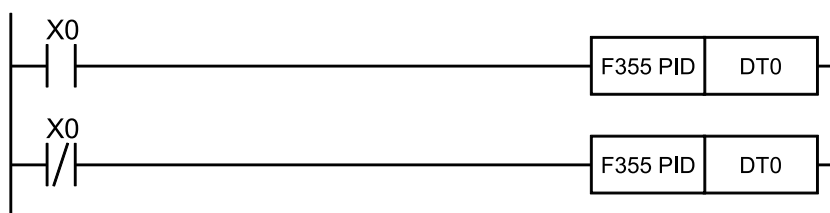

29.1 F355 PID (PID Operation)

(Reason) This is because the F355 PID instruction operates internally using the specified table, even when the execution condition is not met.

In such cases, set the tables to separate addresses.

i Info.

- See the following operational expressions regarding PID operation.

■ Outline of operation of PID control

PID control is a feedback control method widely used in the instrumentation field to control process quantities such as temperature, pressure, flow rate, and fluid levels.

(1) Proportional operation

Control operation that produces an output proportional to the size of the input

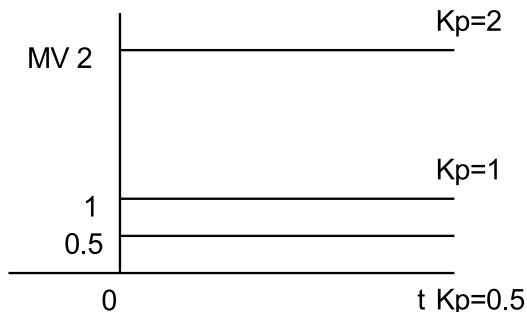
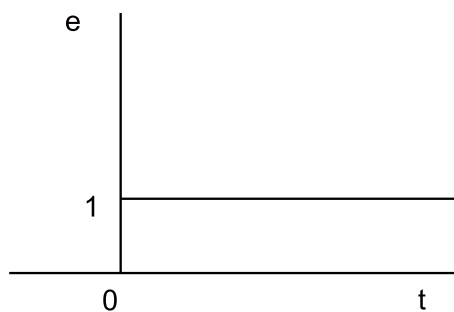
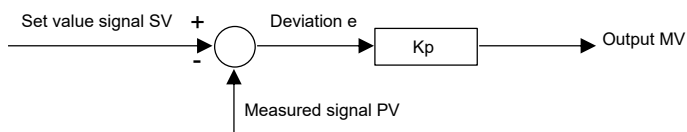

A constant control quantity is maintained.

An offset (regular deviation) remains.

The larger the K_p value, the stronger the action of the proportional operation.

(2) Integral operation

Control operation that produces an output proportional to the integral time of the input.

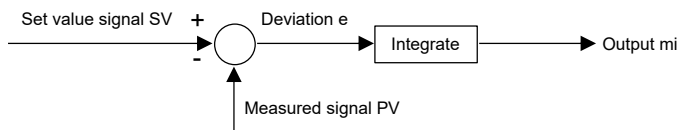

$$m_i = \frac{1}{T_i} \int e dt$$

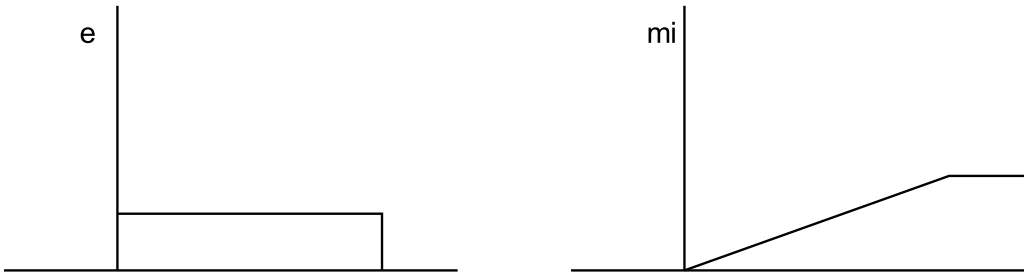

The resulting offset is removed by combining with proportional operation or proportional-derivative operation.

The smaller the T_i value, the stronger the action of the integral operation.

(3) Derivative operation

Control operation that produces an output proportional to the time derivative value of the input.

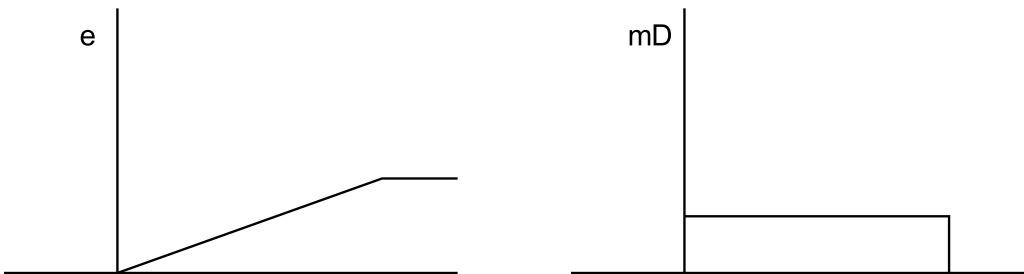
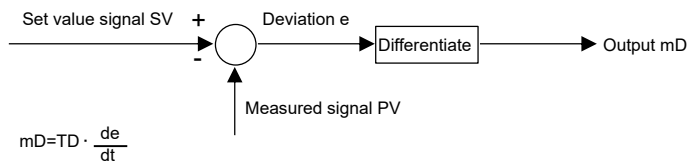

The advancing property of derivative operation reduces the negative effects that the delaying property of the process has on control.

The larger the T_d value, the stronger the action of the derivative operation.

Pure derivative operation becomes temporarily inoperative if noise, etc., is input. This has a negative effect on the controlled process, so incomplete derivative operation is executed.

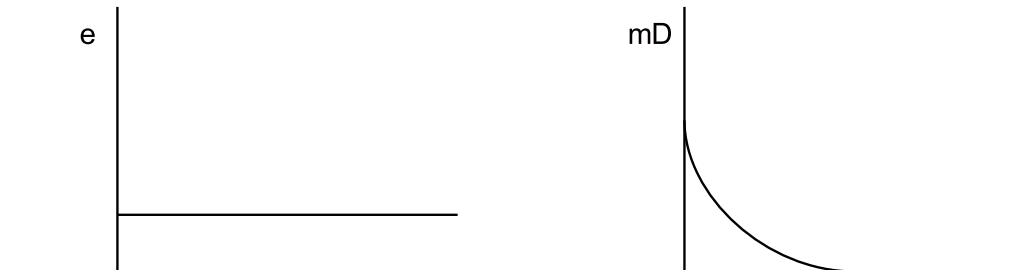

(4) PID operation

A combination of proportional, integral, and derivative operation is called PID operation.

29.1 F355 PID (PID Operation)

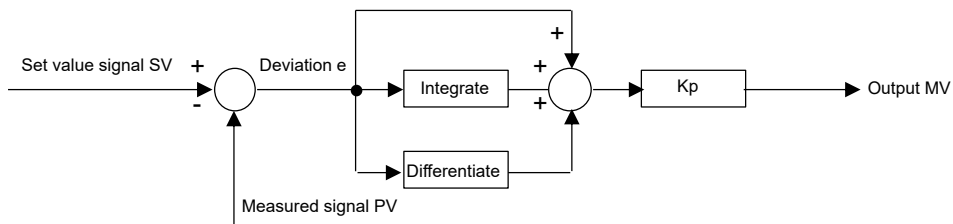

If the parameters in PID control are set to their optimal values, the control quantity can be quickly matched to the target value and maintained.

■ Flag operations

Name	Description
R9007	Turns ON when the parameter setting value is out of range
R9008 (ER)	Turns ON when the area is exceeded in index modification.

29.2 F356 EZPID (PID Operation: PWM Output Possible)

Temperature control (PID) can be easily performed using the image of a temperature controller.

■ Instruction format

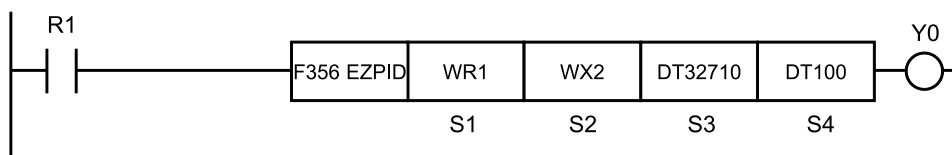

■ Operands

Items	Settings
S1	Control data
S2	Measured process value (PV)
S3	Starting No. of area storing PID control parameters
S4	Starting No. of calculation work area

■ Devices that can be specified (indicated by ●)

Operands	WX	WY	WR	WL	SV	EV	DT	LD	I	SWR	SDT	Constant				Index modifier	Integer Device
												K	H	M	f		
S1		●	●	●	●	●	●	●	●								
S2	●	●	●	●	●	●	●	●	●	●	●						
S3		●	●	●	●	●	●	●									
S4		●	●	●	●	●	●	●									

■ Outline of operation

- PID processing is performed to hold the measured process value (PV) at the set point value (SP).

Writing the OUT instruction immediately after this instruction enables the PWM output (ON-OFF output) similar to a temperature controller.

An auto-tuning function is also available to calculate the PID control parameters automatically.

It can also be used with analog output as it outputs numerical values as well as PWM output.

■ General explanation of the memory areas used

S1	Starts auto-tuning of the control data (one word) and reports its completion. Specifying a non-hold type area (e.g. WR) is recommended to allow operation on a per-bit basis.	
	When bit 0 is 1	Auto-tuning request. This instruction resets the bit if auto-tuning is completed. Reset this bit to cancel auto-tuning.
	When bit 0 is 0	PID control
	Bit 1	When auto-tuning has completed successfully, 1 is set.

29.2 F356 EZPID (PID Operation: PWM Output Possible)

	Bit 2	Turn this bit ON to hold the output MV (S4) when the execution condition of this instruction changes from OFF to ON. When this bit is OFF, MV is cleared.
	When bit 3 is 0	Specifies PWM output
	When bit 3 is 1	Specifies analog output
	When bit 4 is 0	The maximum value and minimum value of the internal output are +20% and -20% of the output range (output upper limit value - output lower limit value) respectively.
	When bit 4 is 1	The maximum value and minimum value of the internal output are the output upper limit value and output lower limit value respectively. *The output lower limit value is specified by S4+1, and the output upper limit value is specified by S4+2.
	Bits 5 to F	Reserved bits. Normally use 0.
S2	Area storing the measured process value (PV) (one word) The input WXn of a temperature input unit can be directly specified. Effective range: K-30000 to K+30000	
S3	Area to specify the target value (SP) and control parameters. (Four words) It is recommended that this area is allocated to hold-type operation memory.	
	S3	Stores the set point value (SP). Must be set from the instruction or a display. Setting range: K-30000 to K+30000
	S3+1	Stores the proportional gain (KP). Actual gain is set point value \times 0.1. Automatically set after auto-tuning is completed. Setting range: K1 to K9999 (0.1 to 999.9)
	S3+2	Stores the integral time (TI) Actual integral time is set point value \times 0.1. Automatically set after auto-tuning is completed. Setting range: K0 to K30000 (0 to 3000 s)
	S3+3	Stores the derivative time (TD). Actual derivative time is set point value \times 0.1. Automatically set after auto-tuning is completed. Setting range: K0 to K10000 (0 to 1000 s)
S4	Divided into output (MV), specified area of control mode, auto-tuning related area, and operation work area. The area in the range of S4 to S4+29 is necessary for the instruction. (See below for details.) It is recommended to allocate it in the non-hold area. Also, do not use the data in this area for other purposes.	

■ Easy usage

<PWM output in reverse operation (heating)>

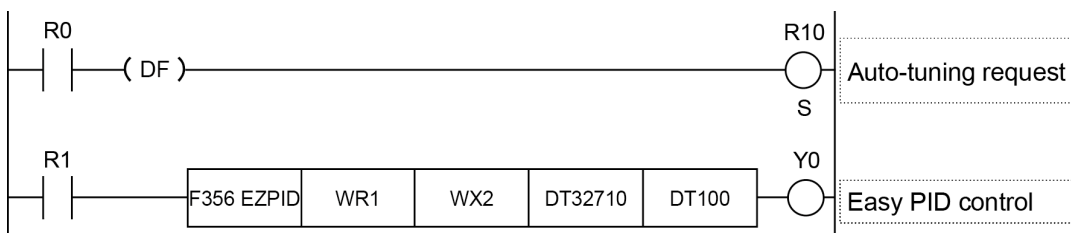

29.2 F356 EZPID (PID Operation: PWM Output Possible)

- Specify the set point value (SP) with the instruction or a display before the operation.
- If auto-tuning is requested with a device such as a display, the above auto-tuning request program is not necessary.
- Work areas DT100 to DT129 return to the default value when R1 turns on. (However, only DT100 (MV) can be held.)
- The control conditions are as follows: operation cycle 1 s, derivative-type reverse operation (heating), PWM resolution = 1000.
- PID control starts from the next scan, and PWM output is executed for Y0.
- Program as described above to start auto-tuning with the instruction, and turn ON R1 after turning ON R0.
- When auto-tuning has completed successfully, R11 turns ON and KP, TI, and TD are set.
- After that, if R1 is ON continuously, it will change to PID control automatically, and PWM output will be executed for Y0.

Note

- If execution condition R1 has turned OFF during PID control, PWM output Y0 also turns OFF. However, the output manipulated value MV is held.

■ When changing control conditions

- The area S4+1 to S4+9 must be changed to change control conditions. Change it before the second execution of the F356 EZPID instruction.

<Details of S4>

S4: Divided into output (MV), specified area of control mode, auto-tuning related area, and operation work area. It is recommended to allocate it in the non-hold area. Also, do not use the data in this area for other purposes.

Output (MV) and control mode area (Used with the normal default values.)

Memory	Function	Default	Range:																		
S4	The output manipulated value (MV) of the calculation result is stored	K0	K-10000 to K10000																		
S4+1	Specify the lower limit of the output manipulated value (MV)	K0	Minimum K-10000																		
S4+2	Specify the upper limit of the manipulated value (MV)	K10000	Maximum K+10000																		
S4+3	Specify the 100% output band (range where PID control is not performed)	K0	K0 to K80 (%)																		
S4+4	Specify the control cycle (TS). Setting unit = 10 ms, default value = 1 s	K100	K1 to K3000 (0.01 to 30 s)																		
S4+5	Specify the control mode (see table below)	K0	K0 to K3																		
<table border="1"> <thead> <tr> <th colspan="2">Control mode</th> <th>Value</th> <th>Example</th> </tr> </thead> <tbody> <tr> <td rowspan="2">Derivative type</td> <td>Reverse</td> <td>K0</td> <td>Heating</td> </tr> <tr> <td>Forward</td> <td>K1</td> <td>Cooling</td> </tr> <tr> <td rowspan="2">Proportional-derivative type</td> <td>Reverse</td> <td>K2</td> <td>Heating</td> </tr> <tr> <td>Forward</td> <td>K3</td> <td>Cooling</td> </tr> </tbody> </table>		Control mode		Value	Example	Derivative type	Reverse	K0	Heating	Forward	K1	Cooling	Proportional-derivative type	Reverse	K2	Heating	Forward	K3	Cooling		
Control mode		Value	Example																		
Derivative type	Reverse	K0	Heating																		
	Forward	K1	Cooling																		
Proportional-derivative type	Reverse	K2	Heating																		
	Forward	K3	Cooling																		
Reverse operation and forward operation Reverse operation: If the measured process value drops, the output is increased (example: heating)																					

29.2 F356 EZPID (PID Operation: PWM Output Possible)

Memory	Function	Default	Range:
	Forward operation: If the measured process value increases, the output is increased (example: cooling) Derivative-type and proportional-derivative type Derivative type: Approaches the set point value faster, but is more likely to overshoot. Proportional-derivative type: Approaches the set point value slower, but is less likely to overshoot.		

Auto-tuning related area (Used with the normal default values.)

Memory	Function	Default	Range:
S4+6	Specify the bias value for performing auto-tuning.	K0	From K0
S4+7	Specify the correction data (a1) of the auto-tuning result (KP).	K125	K50 to K500%
S4+8	Specify the correction data (a2) of the auto-tuning result (TI).	K200	K50 to K500%
S4+9	Specify the correction data (a3) of the auto-tuning result (TD).	K100	K50 to K500%
S4+10	Stores the status while auto-tuning is being performed.	K0	K0 to K5

Operation work area

Memory	Function	Default	Range:
S4+11 to S4+29	The area up to S4+29 is the work area for the PID and auto-tuning operations.	0	

(Note 1) The default value is written when the execution condition turns on.

The output manipulated value (MV) is output only within the range of the upper limit value and lower limit value.

Configure the settings so that $-10000 \leq \text{lower limit value} < \text{upper limit value} \leq 10000$.

■ How to output PWM

- The PWM output cycle is determined by the value set for S4+4. The default value is a cycle of 1 s. The PWM duty cycle is determined by what percentage of K0 to K10000 is comprised of the output MV (S4).
- When either the lower or upper limit value of output MV, specified by S4+1 and S4+2, is a negative value, the PMW output is always OFF.
- The PWM output is always OFF when the output MV is K0, and it is always ON when the output MV is K10000.

■ Explanation of specific usage

1. Only changing control mode with PWM output

- Change the content of the control mode (S4+5) to K1 to K3, using an instruction such as F0 MV.

Example: Change the control mode from the default = derivative type to the proportional-derivative type.

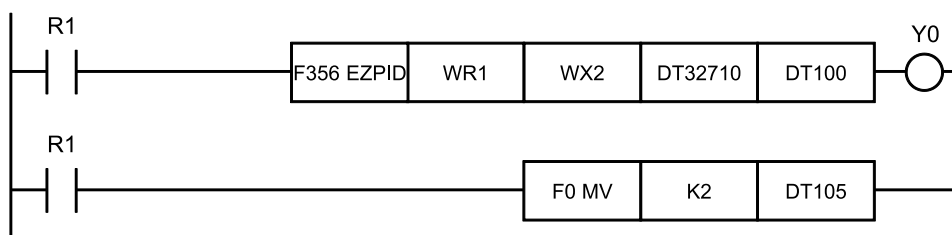

2. Using an analog output unit for output

1. Set the analog output flag (bit 3 of S1) to 1.
2. Set the output lower limit value (S4+1) and the output upper limit value (S4+2) according to the output range of the analog output unit.

e.g. <Lower limit value=K0, upper limit value=K2000>, <lower limit value=K0, upper limit value=K4000>

3. Control cycle (TS): Change the value of (S4+4) according to the input update cycle of the temperature input unit (normally 0.1 s or more)

e.g. TS=K10 (100 ms)

4. Change the control mode if necessary.
5. Transmit the output manipulated value (MV) to WY on the analog output unit.

Note

- When analog output is used for the output, it is not necessary to write an OUT instruction immediately after this instruction.

Also, when using analog output, PWM output is fixed to OFF.

Example: Control with the output upper limit value (S4+2) set to K4000 and the control cycle (S4+4) set to 10 s

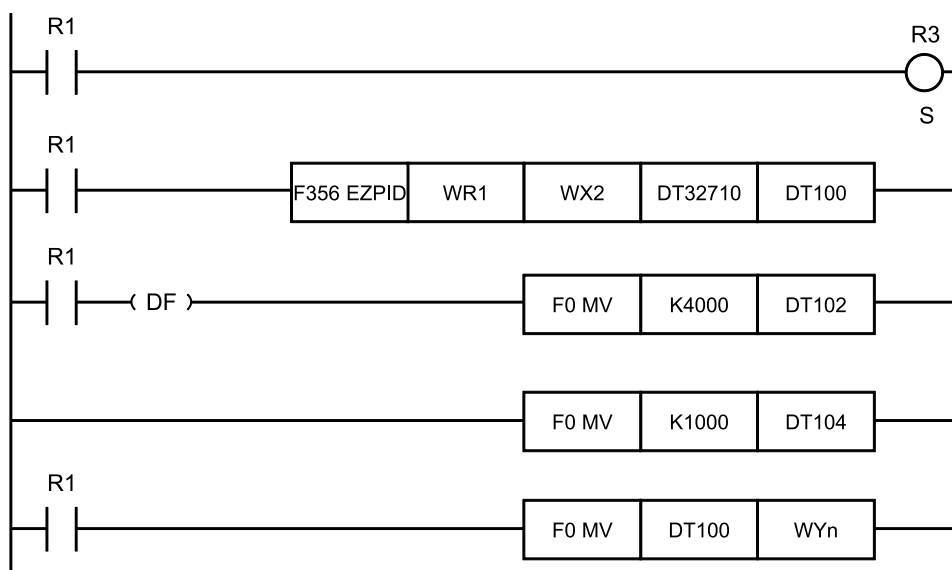

■ More details on setting methods

1. Setting the 100% output band (S4+3)

The 100% output band specifies the percentage of the set value for the measured process value (PV) to be above when PID control is started.

100% output is performed in the area up to the specified process value.

If the measured process value (PV) is less than the set point value (SP) × this setting, it has the effect of shortening the time to reach the set point value (SP), during which 100% output is performed.

For example, if this setting is set to K80, 100% output is performed up to 80% of the set point value (SP), and PID control starts from there.

If this setting has K0=the default value, PID control is performed from the beginning.

2. Fine adjustment of auto-tuning

1. Correction of auto-tuning results (S4+7, S4+8, and S4+9)

When auto-tuning has completed, the parameters KP, TI, and TD are stored in (S3+1, S3+2, and S3+3). The result can be corrected with these parameters at this time.

e.g. To correct KP to 2 times its value, set S4+7 to K200 (meaning 200%) and perform auto-tuning.

To correct TI to 1.25 times its value, set S4+8 to K125 (meaning 125%) and perform auto-tuning.

To correct TD to 0.75 times its value, set S4+9 to K75 (meaning 75%) and perform auto-tuning.

2. Auto-tuning bias value (S4+6)

Auto-tuning is executed with the set point value (SP') as [set point value (SP) - auto-tuning bias value].

This is used to control excessive temperature rise while auto-tuning is performed.

For the forward operation, auto-tuning is executed with the value set to [set point value (SP) + this set value].

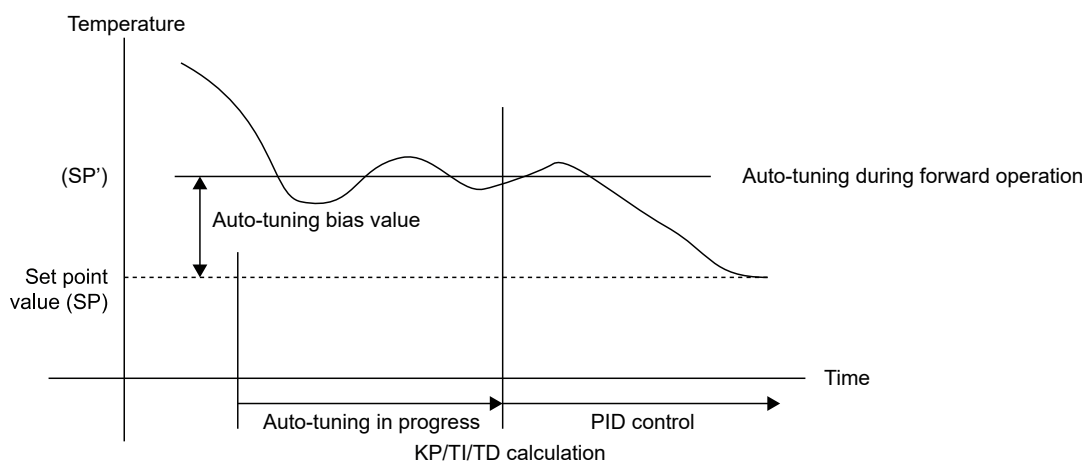
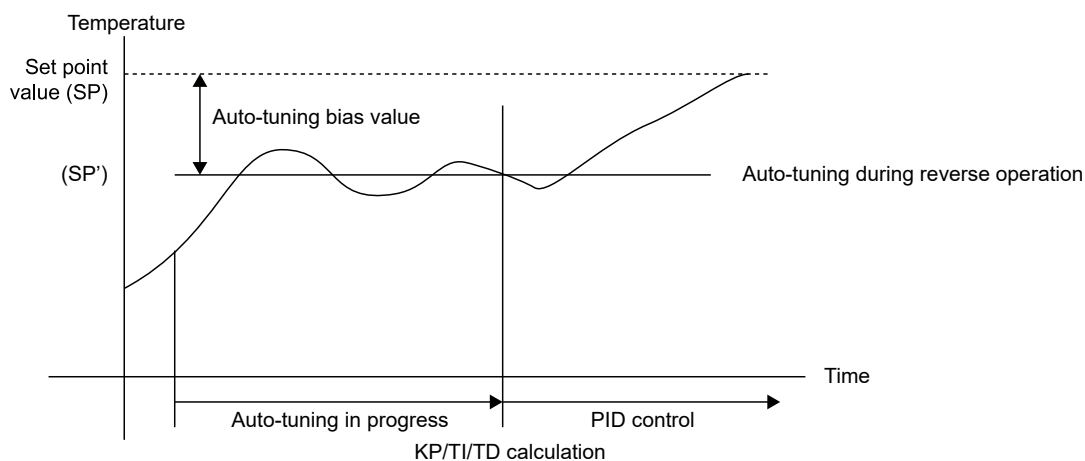

(Note 1) Even if auto-tuning is started when the measured process value (PV) is close to the set point value (SP), auto-tuning is performed with the above SP'.

■ Precautions for programming

- When the execution condition turns on, the area S4 to S4+29 is initialized.
If the values are set to non-default values, write using the always-ON relay R9010 as the execution condition, with an instruction such as the F0 MV instruction.
- The PID operation instruction always calculates the operation cycle and PWM output timing internally, so be sure to perform only one operation during a single scan. Additionally, do not attempt to execute it during a subroutine or interrupt program. This instruction cannot be written more than once with the same operand specified.
- Do not turn OFF the execution condition during PID processing. Otherwise, PID processing will be disabled.
- If you do not want to synchronize the PWM output cycle for controlling multiple objects, you can delay the startup timing, for example by adjusting the startup condition rise time.
- After executing this instruction, the execution conditions will change. This means that subsequent instructions will not work correctly in the program shown below.

29.2 F356 EZPID (PID Operation: PWM Output Possible)

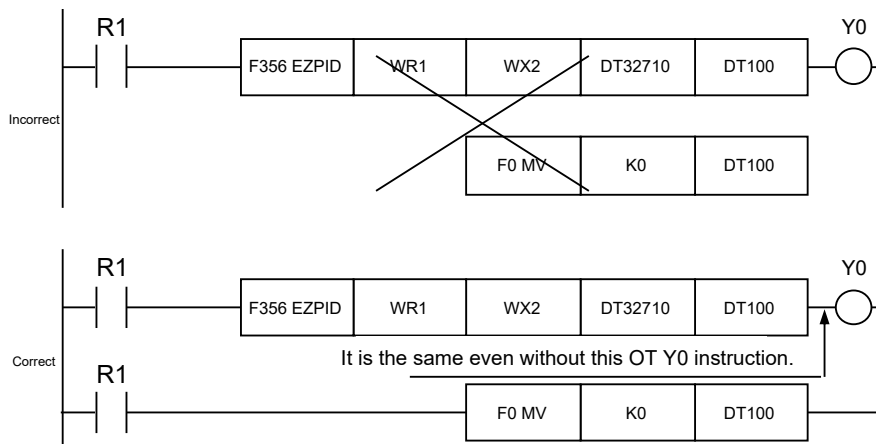

■ Conditions when operation errors occur

- When the following parameters are out of the setting range: S2: measured process value (PV), S3: set point value (SP), S3+1: KP, S3+2: TI, S3+3: TD, S4+1 to S4+9
- When the area specified by S3 or S4 exceeds the upper limit of the specified operation device

■ Internal operation specifications

- When the execution condition turns on, the operation work is initialized.
- If the parameters KP, TI, and TD are all 0 when PID operation starts, they are initialized at 1, 0, and 0 respectively, and the operation is continued.
- At the rising edge of the AT signal, the AT successful completion flag and AT completion code are cleared.
- The AT set value operates with <set point value (SP) - bias value> as the target value. The default bias value is 0.
- When AT successfully completes, it stores the result obtained by multiplying the calculation results KP, TI, and TD by correction data a1, a2, and a3. The default value is 100%.
- When AT successfully completes, the AT successful completion flag is set, and the AT completion code is stored in AT step.
- If AT terminates abnormally, the parameters KP, TI, and TD are unchanged.
- PWM output is output at the duty cycle when the MV output range is 0 to 10000.
- For analog output (when bit 3 of S1 is 1), the internal calculated value is output in the range 0 to 10000 and converted to the specified range.
- Conversion formula: $(\text{upper limit value} - \text{lower limit value}) \times \text{internal calculated value} / 10000 + \text{lower limit value}$
e.g. When upper limit value = 40000, lower limit value = 0, and internal calculated value = 5000: output manipulated value MV = 2000

■ Precautions when using MV holding function

- When using the MV holding function, use the default upper and lower limit values.

30 Positioning Control Instructions (Table Setting Mode)

30.1 F380 POSST (Positioning Table Start)	30-2
30.2 F381 JOGST (JOG Operation Start).....	30-4
30.3 F382 ORGST (Home Return Start).....	30-6
30.4 F383 MPOST (Positioning Simultaneous Start).....	30-7
30.5 F384 PTBLR (Positioning Parameter Read).....	30-9
30.6 F385 PTBLW (Positioning Parameter Write)	30-11

30.1 F380 POSST (Positioning Table Start)

30.1 F380 POSST (Positioning Table Start)

Starts the positioning operation according to the data specified in the positioning memory (positioning table area). This instruction is used to start the E point control, P point control, C point control, J point control or linear interpolation control.

■ Instruction format

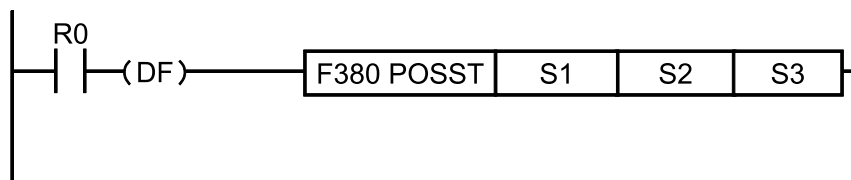

■ Operand

Operand	Settings	Setting range
S1	Channel number to start the positioning operation (Unsigned 16-bit integer)	0 to 3
S2	Table number to start (Unsigned 16-bit integer)	1 to 20
S3	Output assignment	0 (Pulse output), 1 (Calculation only)

■ Memory area type that can be specified

Operand	WX	WY	WR	WL	SV	EV	DT	LD	I	Constant		Index modifier
										K	H	
S1	•	•	•	•	•	•	•	•	•	•	•	•
S2	•	•	•	•	•	•	•	•	•	•	•	•
S3	•	•	•	•	•	•	•	•	•	•	•	•

■ Outline of operation

- Starts the positioning operation according to the data specified in the positioning memory (positioning table area).
- When Calculation only is specified for [S3], only the table calculation is executed. When starting the positioning operation for the same channel and the same table from the next scan after executing the calculation, the startup time of the positioning control is reduced.

■ Precautions during programming

- If an operand is an out-of-range value, an operation error occurs.
- The stop operation has priority when the conditions of system stop, emergency stop, limit stop and deceleration stop are satisfied.
- An operation error occurs when the system register of a specified channel is other than "Pulse output [Table operation]".
- A self-diagnostic error (positioning operation error) occurs when the set value or the value of the positioning memory (axis setting area) is abnormal.

- When the channel to be started has been already operating, the positioning control does not start and it terminates.

■ Flag operations

Name	Explanation
	When the area is exceeded at the time of index modification
R9007	When the [S1] value is outside the set range
R9008	When the [S2] value is outside the set range
(ER)	When the [S3] value is outside the set range
	When the pulse output (table operation) has not been set in the system register

30.2 F381 JOGST (JOG Operation Start)

30.2 F381 JOGST (JOG Operation Start)

Starts the JOG operation according to the parameters specified in the positioning memory (axis setting area).

■ Instruction format

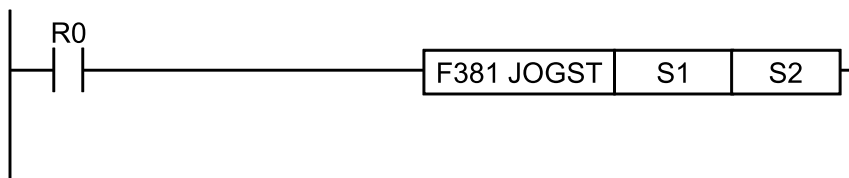

■ Operand

Operand	Settings	Setting range
S1	Channel number to start the JOG operation (Unsigned 16-bit integer)	0 to 3
S2	Operating direction (Unsigned 16-bit integer)	0 (Forward), 1 (Reverse)

■ Memory area type that can be specified

Operand	WX	WY	WR	WL	SV	EV	DT	LD	I	Constant		Index modifier
										K	H	
S1	•	•	•	•	•	•	•	•	•	•	•	•
S2	•	•	•	•	•	•	•	•	•	•	•	•

■ Outline of operation

- Executes the JOG operation according to the JOG operation parameters specified in the positioning memory (axis setting area). While the execution condition is valid, the JOG operation continues.
- The target speed can be changed by rewriting the positioning parameter area with a user program. The change is executed after it becomes a constant speed.

■ Precautions during programming

- If an operand is an out-of-range value, an operation error occurs.
- The stop operation has priority when the conditions of system stop, emergency stop, limit stop and deceleration stop are satisfied.
- An operation error occurs when the system register of a specified channel is other than "Pulse output [Table operation]".
- A self-diagnostic error (positioning operation error) occurs when the set value or the value of the positioning memory (axis setting area) is abnormal.
- The JOG operation needs to be stopped for switching between the forward rotation and reverse rotation.
- In case of changing a speed, when the target speed after the change is an out-of-range value, the speed change is not executed and the operation continues.

■ Flag operations

Name	Explanation
R9007 R9008 (ER)	When the area is exceeded at the time of index modification
	When the [S1] value is outside the set range
	When the [S2] value is outside the set range
	When the pulse output (table operation) has not been set in the system register

30.3 F382 ORGST (Home Return Start)

30.3 F382 ORGST (Home Return Start)

Starts the home return operation according to the parameters specified in the positioning memory (axis setting area).

■ Instruction format

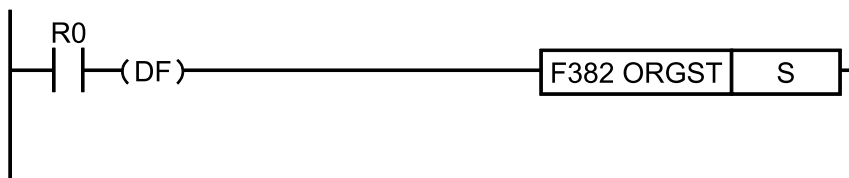

■ Operand

Operand	Settings	Setting range
S	Channel number to start the home return (Unsigned 16-bit integer)	0 to 3

■ Memory area type that can be specified

Operand	WX	WY	WR	WL	SV	EV	DT	LD	I	Constant		Index modifier
										K	H	
S	•	•	•	•	•	•	•	•	•	•	•	•

■ Outline of operation

- Starts the home return operation according to the home return parameters specified in the positioning memory (axis setting area).

■ Precautions during programming

- If an operand is an out-of-range value, an operation error occurs.
- The stop operation has priority when the conditions of system stop, emergency stop, limit stop and deceleration stop are satisfied.
- An operation error occurs when the system register of a specified channel is other than "Pulse output [Table operation]".

■ Flag operations

Name	Explanation
R9007	When the area is exceeded at the time of index modification
R9008	When the value of [S] exceeds the set range
(ER)	When the pulse output (table operation) has not been set in the system register

30.4 F383 MPOST (Positioning Simultaneous Start)

Starts the positioning tables for multiple axes specified on Configurator PMX. The tables of the E point control, P point control and C point control can be started.

■ Instruction format

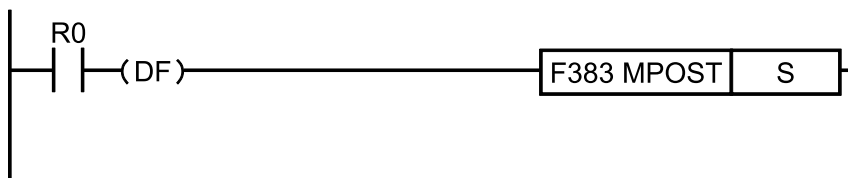

■ Operand

Operand	Settings
S	The starting area of the data register storing the data table numbers (unsigned 16-bit integer) to be started simultaneously

■ Memory area type that can be specified

Operand	WX	WY	WR	WL	SV	EV	DT	LD	I	Constant		Index modifier
										K	H	
S	—	—	—	—	—	—	•	—	—	—	—	•

■ Outline of operation

- Starts the positioning table numbers of the channels specified in the area starting with [S] simultaneously.
- Positioning tables that can be specified are those for the single-axis control only.
- Table numbers are specified in the range of 0 to 20. In the case of 0, the table is not executed simultaneously with other tables.

S	Output specification (0: Pulse output, 1: Calculation only)
S+1	CH0 Positioning table number (0 to 20)
S+2	CH1 Positioning table number (0 to 20)
S+3	CH2 Positioning table number (0 to 20)
S+4	CH3 Positioning table number (0 to 20)

■ Precautions during programming

- If an operand is an out-of-range value, an operation error occurs.
- The stop operation has priority when the conditions of system stop, emergency stop, limit stop and deceleration stop are satisfied.
- An operation error occurs when the system register of a specified channel is other than "Pulse output [Table operation]".
- Only when all the specified channels can be started, they are executed simultaneously. When the BUSY flag of any channel is on, tables are not started simultaneously and the process is terminated.

30.4 F383 MPOST (Positioning Simultaneous Start)

- Use F380 POSST instruction to start linear interpolation. When the table of the interpolation axis control has been specified with F383 MPOST instruction, a self-diagnostic error (positioning operation error) occurs.

■ Flag operations

Name	Explanation
R9007 R9008 (ER)	When the area is exceeded at the time of index modification
	When the [S] data table exceeds the area
	When the value of [S] exceeds the set range
	When the pulse output (table operation) has not been set in the system register

30.5 F384 PTBLR (Positioning Parameter Read)

Reads the positioning parameter data stored in the positioning memory of the unit to the operation memory area.

■ Instruction format



■ Operand

Operand	Settings			
S1	Specification of channel numbers and positioning memory area			
	<table border="1"> <tr> <td>(Higher 8 bits) channel no.:</td> <td>H0 to H3</td> </tr> <tr> <td>(Lower 8 bits) Area no.:</td> <td>H00 (Common area), H01 (Axis information area), H02 (Axis setting area), H03 (Positioning table area)</td> </tr> </table>	(Higher 8 bits) channel no.:	H0 to H3	(Lower 8 bits) Area no.:
(Higher 8 bits) channel no.:	H0 to H3			
(Lower 8 bits) Area no.:	H00 (Common area), H01 (Axis information area), H02 (Axis setting area), H03 (Positioning table area)			
S2	Starting address of the positioning memory storing read data (offset address) or operation memory area storing the starting address			
n	No. of read words			
D	Operation memory storing read data			

(Note 1) When reading the common area, the setting of channel numbers is invalid.

(Note 2) The operand S1 is specified using a combination of hexadecimal numbers. For the axis information area of channel number 3, specify H301.

■ Memory area type that can be specified

Operand	WX	WY	WR	WL	SV	EV	DT	LD	I	Constant		Index modifier
										K	H	
S1	•	•	•	•	•	•	•	•	•	•	•	•
S2	•	•	•	•	•	•	•	•	•	•	•	•
n	•	•	•	•	•	•	•	•	•	•	•	•
D	—	•	•	•	•	•	•	•	•	—	—	•

■ Outline of operation

- Reads [n] words of the data stored in the positioning memory starting with [S2], and stores it in the operation memory area starting with [D].
- Channel numbers and the type of positioning memory is specified by [S1].

■ Precautions during programming

- If an operand is an out-of-range value, an operation error occurs.

30.5 F384 PTBLR (Positioning Parameter Read)

■ Flag operations

Name	Explanation
R9007	When the [S1] value is outside the set range
R9008	When the [S2] value exceeds the positioning area specified by [S1]
(ER)	When the no. of read words is "0"
	When the read data exceeds the area of [D]

30.6 F385 PTBLW (Positioning Parameter Write)

This instruction is used to write positioning parameters and positioning table data with user programs.

■ Instruction format

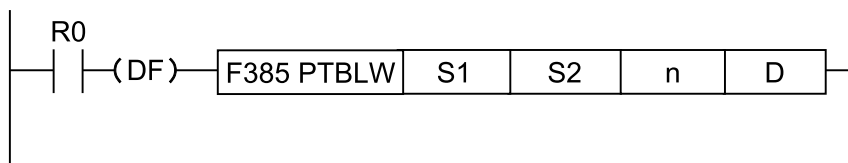

■ Operand

Operand	Settings
S1	Specification of channel numbers and positioning memory area
	(Higher 8 bits) channel no.: H0 to H3 (Not save in FROM), H80 to H83 (Save in FROM)
	(Lower 8 bits) Area no.: H00 (Common area), H01 (Axis information area), H02 (Axis setting area), H03 (Positioning table area)
S2	Operation memory area storing written data
n	No. of written data
D	Starting address of the positioning memory storing data (offset address) or operation memory area storing the starting address

(Note 1) When writing data to the common area, the setting of channel numbers is invalid.

(Note 2) The operand S1 is specified using a combination of hexadecimal numbers. For the axis setting area of channel number 3, specify H302.

■ Memory area type that can be specified

Operand	WX	WY	WR	WL	SV	EV	DT	LD	I	Constant		Index modifier
										K	H	
S1	•	•	•	•	•	•	•	•	•	•	•	•
S2	•	•	•	•	•	•	•	•	•	-	-	•
n	•	•	•	•	•	•	•	•	•	•	•	•
D	•	•	•	•	•	•	•	•	•	•	•	•

■ Outline of operation

- Reads [n] words of the data stored in the area starting with [S2], and stores it in the positioning memory area starting with [D].
- Channel numbers and the type of positioning memory are specified by [S1].

■ Precautions during programming

- If an operand is an out-of-range value, an operation error occurs.

30.6 F385 PTBLW (Positioning Parameter Write)

- When specifying [H80 to H83 (Save in FROM)] for the higher 8 bits of operand [S1] (the most significant bit is 1), specified data is written into the F-ROM of the control unit. Writing to F-ROM can be performed up to 10000 times. We recommend using differential execution to prevent the writing from being executed continuously.

■ Flag operations

Name	Explanation
R9007	When the [S1] value is outside the set range
R9008	When the [D] value exceeds the positioning area specified by [S1]
(ER)	When the range of the data written from [D] exceeds the positioning area specified by [S1]
	When the no. of written data is "0"
	When the written data exceeds the area of [S2]

31 Positioning Control Instructions

31.1 F1 DMV (Pulse Output Elapsed Value Write/Read).....	31-2
31.2 [F171(SPDH)] Pulse Output (Trapezoidal Control).....	31-3
31.3 [F171(SPDH)] Pulse Output (Home Return).....	31-9
31.4 [F172(PSLH)] Pulse Output (JOG Operation).....	31-14
31.5 [F174(SP0H)] Pulse Output (Selectable Data Table Control Operation)	31-17
31.6 [F175(SPSH)] Pulse Output (Linear Interpolation)	31-22

31.1 F1 DMV (Pulse Output Elapsed Value Write/Read)

31.1 F1 DMV (Pulse Output Elapsed Value Write/Read)

Writes and reads the elapsed value of the high-speed counter.

■ Instruction format

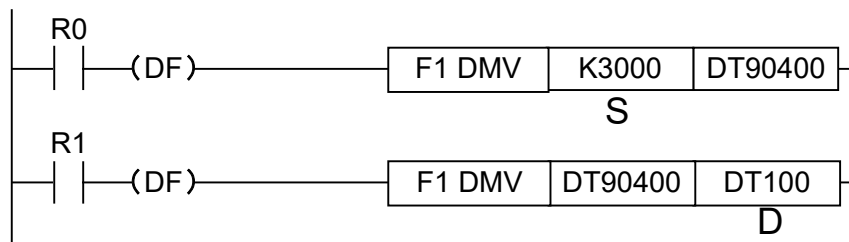

■ Operand

Operand	Settings
S	When setting: Area storing the elapsed value (32-bit) set in the high-speed counter or constant data K-2,147,483,648 to K2,147,483,647
D	When reading: Area reading the elapsed value of the high-speed counter

■ Memory area type that can be specified

Operand	WX	WY	WR	WL	SV	EV	DT	LD	I	Constant		Index modifier
										K	H	
S	•	•	•	•	•	•	•	•	•	•	•	•
D	-	•	•	•	•	•	•	•	•	-	-	•

■ Outline of operation (Reading elapsed value)

- Reads the content of the special data register storing the elapsed value of the high-speed counter and writes to the area specified by [D].

■ Outline of operation (Setting elapsed value)

- At the same time as writing the value to the elapsed value area of the high-speed counter which uses 32-bit data specified by [S], sets it in the elapsed value area of the high-speed counter used within the system.

■ Precautions during programming

- Only F1 (DMV) instruction can perform the writing. The writing cannot be performed by other high-level instructions such as transfer instruction F0 (MV) and arithmetic instructions.
- Specify the memory area of [S] or [D] with the memory area number for the lower 16 bits.

31.2 [F171(SPDH)] Pulse Output (Trapezoidal Control)

This instruction outputs pulses from a specified pulse output channel according to specified parameters.

■ Instruction format

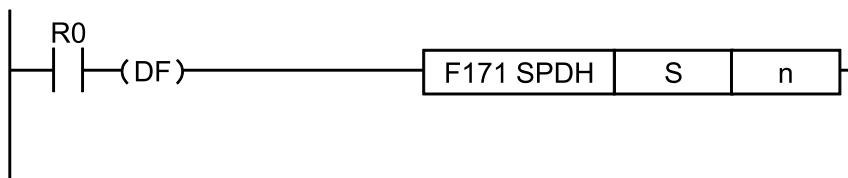

■ Operand

Operand	Settings
S	Starting number of the area in which data tables are registered
n	Target channel for pulse output

■ Memory area type that can be specified

Operand	WX	WY	WR	WL	SV	EV	DT	LD	I	Constant		Index modifier
										K	H	
S	-	-	-	-	-	-	•	-	-	-	-	•
n	-	-	-	-	-	-	-	-	-	•	•	-

■ Outline of operation

- Outputs pulses from a specified channel when a corresponding control active flag is OFF and the execution condition is ON.
- The control code, initial speed, maximum speed, acceleration/deceleration time, and target value are specified by creating data tables [S] to [S+11] described on the next page using a user program.
- Switches the frequency from the initial speed to the maximum speed in the specified acceleration/deceleration time. At the time of deceleration, switches the frequency with the same inclination as that for acceleration.
- For setting the frequency to 50 kHz or more, specify the duty of 1/4 (25%).

■ Operation mode

Incremental <Relative value control>

Outputs the pulses set with the target value.

Target value	Selection			
	CW/CCW	PLS+SIGN Forward OFF Reverse ON	PLS+SIGN Forward ON Reverse OFF	Elapsed value
When plus	Pulse output from CW	Pulse output when	Pulse output when	Addition

31.2 [F171(SPDH)] Pulse Output (Trapezoidal Control)

Selection				
Target value	CW/CCW	PLS+SIGN Forward OFF Reverse ON	PLS+SIGN Forward ON Reverse OFF	Elapsed value
		direction output is OFF	direction output is ON	
When minus	Pulse output from CCW	Pulse output when direction output is ON	Pulse output when direction output is OFF	Subtraction

Absolute <Absolute value control>

Outputs the pulses of the difference between the set target value and current value.

Selection				
Target value	CW/CCW	PLS+SIGN Forward OFF Reverse ON	PLS+SIGN Forward ON Reverse OFF	Elapsed value
When target value is larger than current value	Pulse output from CW	Pulse output when direction output is OFF	Pulse output when direction output is ON	Addition
When target value is smaller than current value	Pulse output from CCW	Pulse output when direction output is ON	Pulse output when direction output is OFF	Subtraction

■ Data table settings

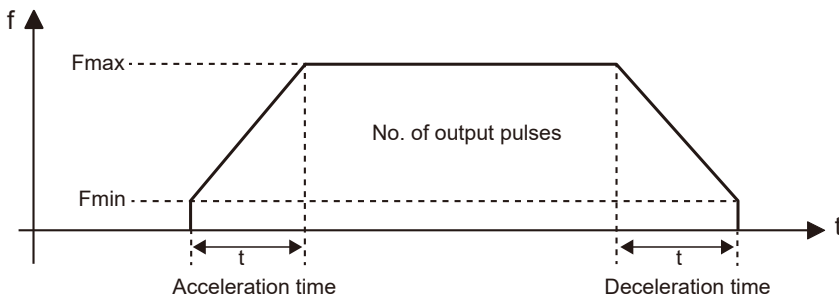

31.2 [F171(SPDH)] Pulse Output (Trapezoidal Control)

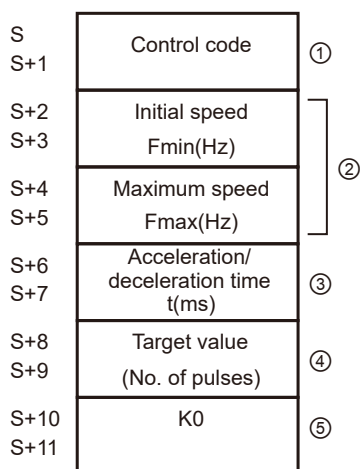

	Operand	Settings	Description									
(1)	S, S+1	Control code	<p>Specify the control code by setting the H constant.</p> <p style="text-align: right;">H <input type="checkbox"/><input type="checkbox"/><input type="checkbox"/><input type="checkbox"/><input type="checkbox"/><input type="checkbox"/><input type="checkbox"/><input type="checkbox"/><input type="checkbox"/><input type="checkbox"/><input type="checkbox"/></p> <p>0: Fixed</p> <p>Acceleration/deceleration time setting 0: Normal 1: Acceleration/deceleration time priority</p> <p>Output setting 0: Pulse output 1: Calculate only</p> <p>Acceleration/deceleration steps 0: 30 steps 1: 60 steps</p> <p>Duty (on width) 0: Duty 1/2 (50%) 1: Duty 1/4 (25%)</p> <p>Frequency range Not used</p> <p>Operation mode and output method 0: Incremental CW/CCW 2: Incremental PLS+SIGN (forward off/reverse on) 3: Incremental PLS+SIGN (forward on/reverse off) 10: Absolute CW/CCW 12: Absolute PLS+SIGN (forward off/reverse on) 13: Absolute PLS+SIGN (forward on/reverse off)</p>									
(2)	S+2, S+3	Initial speed Fmin(Hz)	<p>The setting range of the settable maximum speed varies according to the setting of the initial speed as shown in the table below.</p> <table border="1" style="width: 100%; border-collapse: collapse;"> <thead> <tr style="background-color: #d9e1f2;"> <th style="width: 10%;">Range</th> <th style="width: 40%;">Initial speed</th> <th style="width: 50%;">Maximum speed</th> </tr> </thead> <tbody> <tr> <td style="text-align: center;">Low speed</td> <td>K1 to K49 (1 to 49Hz)</td> <td>Initial speed to K22000 (to 22kHz)</td> </tr> <tr> <td style="text-align: center;">High speed</td> <td>K50 to K100000 (50Hz to 100kHz)</td> <td>Initial speed to K100000 (to 100kHz)</td> </tr> </tbody> </table>	Range	Initial speed	Maximum speed	Low speed	K1 to K49 (1 to 49Hz)	Initial speed to K22000 (to 22kHz)	High speed	K50 to K100000 (50Hz to 100kHz)	Initial speed to K100000 (to 100kHz)
Range	Initial speed	Maximum speed										
Low speed	K1 to K49 (1 to 49Hz)	Initial speed to K22000 (to 22kHz)										
High speed	K50 to K100000 (50Hz to 100kHz)	Initial speed to K100000 (to 100kHz)										
	S+4, S+5	Maximum speed Fmax(Hz)										

31.2 [F171(SPDH)] Pulse Output (Trapezoidal Control)

	Operand	Settings	Description
			(Note 1) If the initial speed is set to a value less than K1 or if the maximum speed is set to a value exceeding K100000, an operation error occurs. (Note 2) If the initial speed is set to the low-speed range and if the maximum speed is set to a value exceeding K22000, an operation error occurs.
(3)	S+6, S+7	Acceleration/ deceleration time t(ms)	Acceleration/deceleration time (ms) With 30 steps: K30 to K32760 (Specify in 30 ms increments.) With 60 steps: K60 to K32760 (Specify in 60 ms increments.) (Note 1) When the time is not specified in 30 ms nor 60 ms increments, it will be automatically corrected to the multiple value (larger value) of 30 ms or 60 ms.
(4)	S+8, S+9	Target value	Target value K-2147483648 to K2147483647 pulses
(5)	S+10, S+11	K0	Set K0 to the last two words of the data table.

■ Example of program

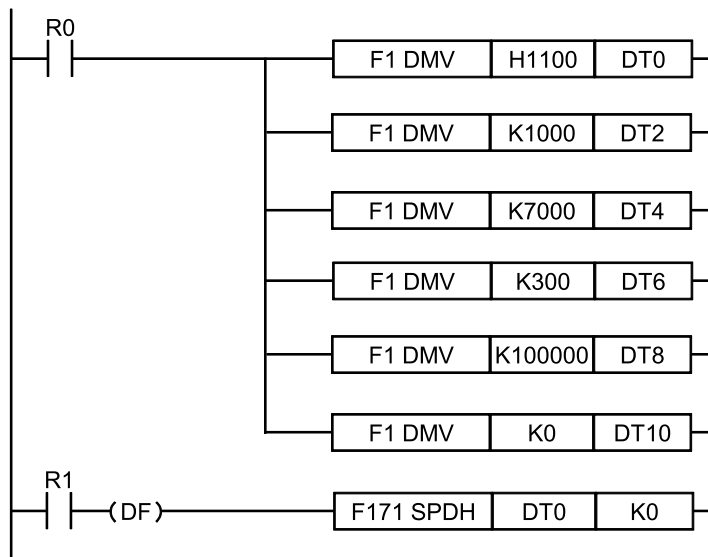

31.2 [F171(SPDH)] Pulse Output (Trapezoidal Control)

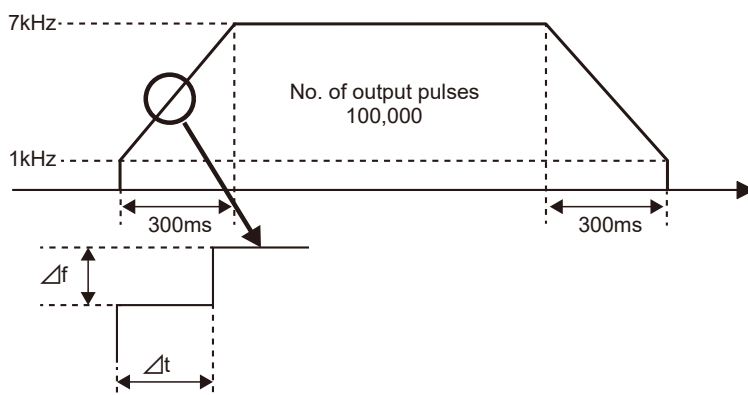

- With 30 steps
 $\Delta f = (7000 - 1000) / 30 \text{ steps} = 200 \text{ (Hz)}$
 $\Delta t = 300 \text{ ms} / 30 \text{ steps} = 10 \text{ ms}$
- With 60 steps
 $\Delta f = (7000 - 1000) / 60 \text{ steps} = 100 \text{ (Hz)}$
 $\Delta t = 300 \text{ ms} / 60 \text{ steps} = 5 \text{ ms}$

■ Regarding the specification of acceleration/deceleration time

For specifying acceleration/deceleration time, No. of steps and initial speed, set the value to be calculated by the formula below. Specify acceleration/deceleration time in 30 ms increments with 30 steps, and in 60 ms increments with 60 steps. When the time is not specified in 30 ms nor 60 ms increments, it will be automatically corrected to the multiple values (larger value) of 30 ms or 60 ms.

Acceleration/deceleration time t [ms] (No. of steps \times 1000) / Initial speed f_0 [Hz]

- When "Acceleration/deceleration time priority" is specified for the control code, the initial speed is corrected according to the time.
The corrected speed is stored in the correction speed area of initial speed of special data registers (from DT90400).
(Example): When the initial speed is 10 Hz, and acceleration/deceleration time is 1 msec, the initial speed is corrected to 1000 Hz.
- When the corrected initial speed exceeds the maximum speed, the initial speed is corrected to the maximum speed.
(Example): When the initial speed is 10 Hz, the maximum speed is 500 Hz, acceleration/deceleration time is 1 msec, and acceleration/deceleration time priority is specified, it takes 100 msec for outputting one pulse at the initial speed and it exceeds 1 msec of acceleration/deceleration time.
Although the initial speed is corrected to 1000 Hz as "Acceleration/deceleration time priority" is specified, it is corrected to 500 Hz because it exceeds the maximum speed.

■ Supplement to pulse output operation

When outputting pulses with the PLS+SIGN (direction output) method, pulses will be output approx. 300 μ s later after the output of direction signal (SIGN). (The characteristics of a motor driver are considered.)

31.2 [F171(SPDH)] Pulse Output (Trapezoidal Control)

■ Precautions during programming

- When describing the same channel in both the normal program and the interrupt program, be sure to program not to execute them simultaneously.
- This instruction cannot be executed when a control flag corresponding to each channel is on.
- For the FP0H mode, select "Pulse output" for the channel setting corresponding to the system register no. 402.
- For the FPsigma mode, select "Do not use high-speed counter" for the channel setting corresponding to the system register nos. 400 and 401.
- By performing the rewriting during RUN while outputting pulses, more pulses than the setting may be output.

Info.

- For details of the allocations of I/O and flags, refer to "[38.5.2 When Using Pulse Output Function \(FPsigma Compatible Instruction Mode\)](#)".
- For details of the FP mode, refer to "[38.6 FPsigma Mode](#)".

31.3 [F171(SPDH)] Pulse Output (Home Return)

This instruction outputs pulses from a specified pulse output channel according to specified parameters.

■ Instruction format

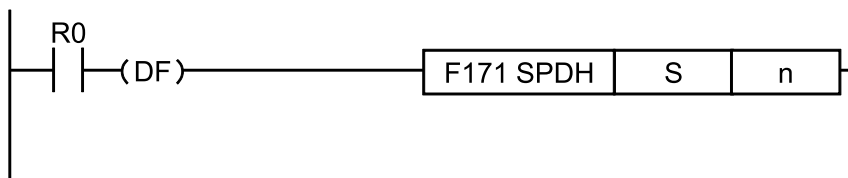

■ Operand

Operand	Settings
S	Starting number of the area in which data tables are registered
n	Target channel for pulse output

■ Memory area type that can be specified

Operand	WX	WY	WR	WL	SV	EV	DT	LD	I	Constant		Index modifier
										K	H	
S	-	-	-	-	-	-	•	-	-	-	-	•
n	-	-	-	-	-	-	-	-	-	•	•	-

■ Outline of operation

- Outputs pulses from a specified channel when a corresponding control active flag is OFF and the execution condition is ON.
- The control code, initial speed, maximum speed, acceleration/deceleration time, and deviation counter clear signal are specified by creating data table described on the next page using a user program.
- Switches the frequency from the initial speed to the maximum speed in the specified acceleration/deceleration time. At the time of deceleration, switches the frequency with the same inclination as that for acceleration.
- For setting the frequency to 50 kHz or more, specify the duty of 1/4 (25%).

■ Explanation of operation mode

Home return

The pulses are continuously output until the home input (X2 or X5) is enabled. To shift to deceleration operation when detecting the near home, turn the corresponding bit of special data register DT90052 to OFF ON OFF by the near home input. The value in the elapsed value area during the home return operation differs from the current value.

Home return mode I (Home return by home input only)

When the home input is enabled, the pulse output will stop. Set the control code (low byte) on the next page to H20 to H27.

31.3 [F171(SPDH)] Pulse Output (Home Return)

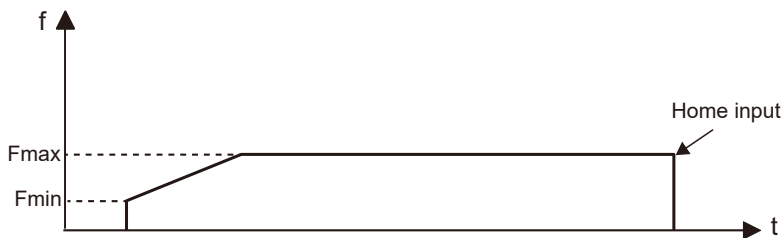

Home return mode II (Home return by near home input and home input)

When the near home input is enabled, deceleration will be performed, and the pulse output will stop after the home input. The operation varies according to the setting of the control code (low byte) described on the next page to H30 to H37.

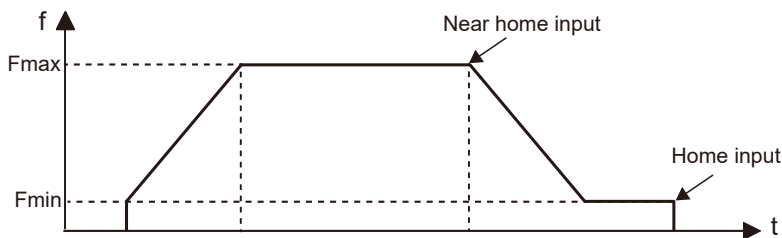

■ Data table settings

S	Control code	①
S+1		
S+2	Initial speed	②
S+3	$F_{min}(\text{Hz})$	
S+4	Maximum speed	
S+5	$F_{max}(\text{Hz})$	
S+6	Acceleration/	③
S+7	deceleration time	
	$t(\text{ms})$	
S+8	Deviation counter clear	④
S+9	signal output time $t_r(\text{ms})$	

	Operand	Settings	Description
(1)	S, S+1	Control code	Specify the control code by setting the H constant.

31.3 [F171(SPDH)] Pulse Output (Home Return)

	Operand	Settings	Description									
			<p style="text-align: right;">H <input type="checkbox"/> <input type="checkbox"/> <input type="checkbox"/> <input type="checkbox"/> <input type="checkbox"/> <input type="checkbox"/> <input type="checkbox"/> <input type="checkbox"/> <input type="checkbox"/> <input type="checkbox"/></p> <p>0: Fixed</p> <p>Acceleration/deceleration time setting 0: Normal 1: Acceleration/deceleration time priority</p> <p>Output setting 0: Pulse output 1: Calculate only</p> <p>Acceleration/deceleration steps 0: 30 steps 1: 60 steps</p> <p>Duty (on width) 0: Duty 1/2 (50%) 1: Duty 1/4 (25%)</p> <p>Frequency range Not used</p> <p>Operation mode and output method 20: Homing mode 1 CW 21: Homing mode 1 CCW 22: Homing mode 1 Directional output off 23: Homing mode 1 Directional output on 24: Homing mode 1 CW + deviation counter reset 25: Homing mode 1 CCW + deviation counter reset 26: Homing mode 1 Direction output off + deviation counter reset 27: Homing mode 1 Direction output on + deviation counter reset 30: Homing mode 2 CW 31: Homing mode 2 CCW 32: Homing mode 2 Directional output off 33: Homing mode 2 Direction output on 34: Homing mode 2 CW + deviation counter reset 35: Homing mode 2 CCW + deviation counter reset 36: Homing mode 2 Direction output off + deviation counter reset 37: Homing mode 2 Direction output on + deviation counter reset</p>									
(2)	S+2, S+3	Initial speed Fmin(Hz)	<p>The setting range of the settable maximum speed varies according to the setting of the initial speed as shown in the table below.</p> <table border="1"> <thead> <tr> <th>Range</th> <th>Initial speed</th> <th>Maximum speed</th> </tr> </thead> <tbody> <tr> <td>Low speed</td> <td>K1 to K49 (1 to 49Hz)</td> <td>Initial speed to K22000 (to 22kHz)</td> </tr> <tr> <td>High speed</td> <td>K50 to K100000 (50Hz to 100kHz)</td> <td>Initial speed to (to 100kHz)</td> </tr> </tbody> </table> <p>(Note 1) If the initial speed is set to a value less than K1 or if the maximum speed is set to a value exceeding K100000, an operation error occurs.</p> <p>(Note 2) If the initial speed is set to the low-speed range and if the maximum speed is set to a value exceeding K22000, an operation error occurs.</p>	Range	Initial speed	Maximum speed	Low speed	K1 to K49 (1 to 49Hz)	Initial speed to K22000 (to 22kHz)	High speed	K50 to K100000 (50Hz to 100kHz)	Initial speed to (to 100kHz)
	Range	Initial speed		Maximum speed								
Low speed	K1 to K49 (1 to 49Hz)	Initial speed to K22000 (to 22kHz)										
High speed	K50 to K100000 (50Hz to 100kHz)	Initial speed to (to 100kHz)										
	S+4, S+5	Maximum speed Fmax(Hz)										
(3)	S+6, S+7	Acceleration/ deceleration time t(ms)	Acceleration/deceleration time (ms) With 30 steps: K30 to K32760 With 60 steps: K60 to K32760									
(4)	S+8, S+9	Deviation counter clear signal output time	Set the output time of the deviation counter clear signal. 0.5 ms to 100 ms [K0 to K100] Setting value + error (0.5 ms or less)									

31.3 [F171(SPDH)] Pulse Output (Home Return)

Operand	Settings	Description
	tr(ms)	When this signal is not used or the time is set to less than 0.5 ms, specify K0.

■ Example of program

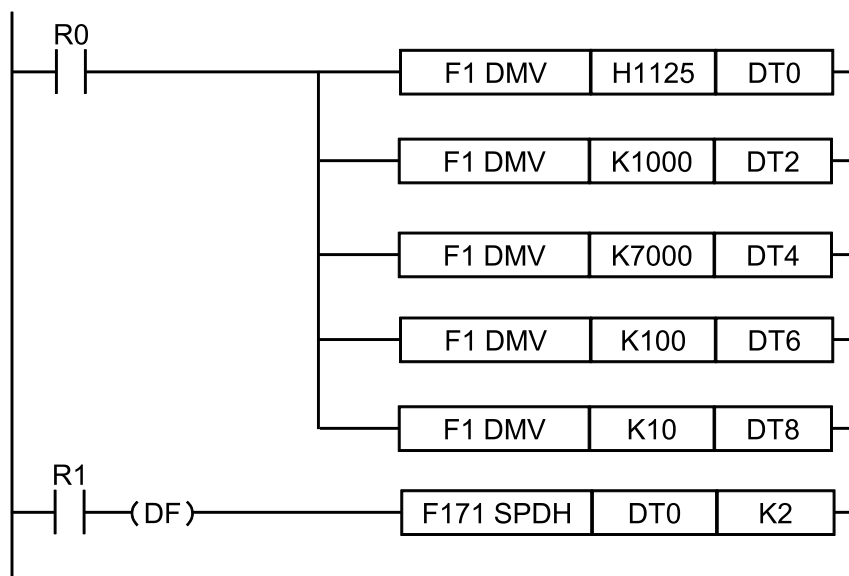

■ Regarding the specification of acceleration/deceleration time

For specifying acceleration/deceleration time, No. of steps and initial speed, set the value to be calculated by the formula below. Specify acceleration/deceleration time in 30 ms increments with 30 steps, and in 60 ms increments with 60 steps. When the time is not specified in 30 ms nor 60 ms increments, it will be automatically corrected to the multiple values (larger value) of 30 ms or 60 ms.

Acceleration/deceleration time $t[\text{ms}] = (\text{No. of steps} \times 1000) / \text{Initial speed } f_0[\text{Hz}]$

- When "Acceleration/deceleration time priority" is specified for the control code, the initial speed is corrected according to the time.

The corrected speed is stored in the correction speed area of initial speed of special data registers (from DT90400).

(Example): When the initial speed is 10 Hz, and acceleration/deceleration time is 1 msec, the initial speed is corrected to 1000 Hz.

- When the corrected initial speed exceeds the maximum speed, the initial speed is corrected to the maximum speed.

(Example): When the initial speed is 10 Hz, the maximum speed is 500 Hz, acceleration/deceleration time is 1 msec, and acceleration/deceleration time priority is specified, it takes 100 msec for outputting one pulse at the initial speed and it exceeds 1 msec of acceleration/deceleration time.

Although the initial speed is corrected to 1000 Hz as "Acceleration/deceleration time priority" is specified, it is corrected to 500 Hz because it exceeds the maximum speed.

■ Supplement to pulse output operation

When outputting pulses with the PLS+SIGN (direction output) method, pulses will be output approx. 300 μ s later after the output of direction signal (SIGN). (The characteristics of a motor driver are considered.)

■ Precautions during programming

- When the control code (low byte) is H20 to H27 (home return mode I), the home input is enabled even after the near home input, the completion of deceleration, or in the middle of deceleration.
- When the control code (low byte) is H30 to H37 (home return mode II), the home input is enabled only after the near home input and the completion of deceleration up to the value of initial speed.
- Even when the home input is enabled, the pulse output starts by the execution of this instruction.
- When the near home input is enabled during acceleration, the deceleration operation will start.
- When describing the same channel in both the normal program and the interrupt program, be sure to program not to execute them simultaneously.
- This instruction cannot be executed when a control flag corresponding to each channel is on.
- For the FP0H mode, select "Pulse output" for the channel setting corresponding to the system register no. 402.
- For the FPsigma mode, select "Do not use high-speed counter" for the channel setting corresponding to the system register nos. 400 and 401.
- By performing the rewriting during RUN while outputting pulses, more pulses than the setting may be output.
- For performing the software reset, disabling the counting, stopping the pulse output or near home processing, refer to the F0(MV) instruction, pulse output control.

Info.

- For the details of the allocations of I/O and flags, refer to "[38.5.2 When Using Pulse Output Function \(FPsigma Compatible Instruction Mode\)](#)".
- For details of the FPsigma mode, refer to "[38.6 FPsigma Mode](#)".

31.4 [F172(PSLH)] Pulse Output (JOG Operation)

31.4 [F172(PSLH)] Pulse Output (JOG Operation)

Outputs the pulse of a specified parameter from a specified channel.

■ Instruction format

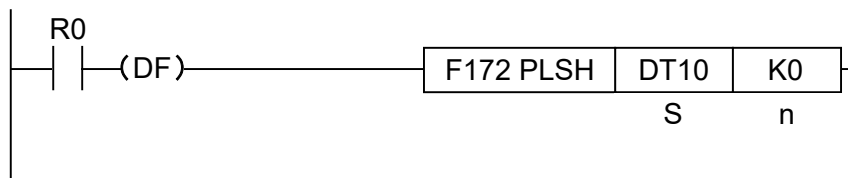

■ Operand

Operand	Settings
S	Starting number of the area in which data tables are registered
n	Target channel for pulse output

■ Memory area type that can be specified

Operand	WX	WY	WR	WL	SV	EV	DT	LD	I	Constant		Index modifier
										K	H	
S	-	-	-	-	-	-	•	-	-	-	-	•
n	-	-	-	-	-	-	-	-	-	•	•	-

■ Outline of operation

- Outputs pulses from a specified channel when a corresponding control active flag is OFF and the execution condition is ON. The output is performed when the trigger (execution condition) is on.
- By specifying the addition counting or subtraction counting mode for the control code, it can be used for the instruction for activating JOG operation.
- The frequency can be changed in each scan, or the target value can be changed asynchronously. However, the control code cannot be changed during the execution of an instruction.
- For setting the frequency to 50 kHz or more, specify the duty of 1/4 (25%).

■ Data table settings

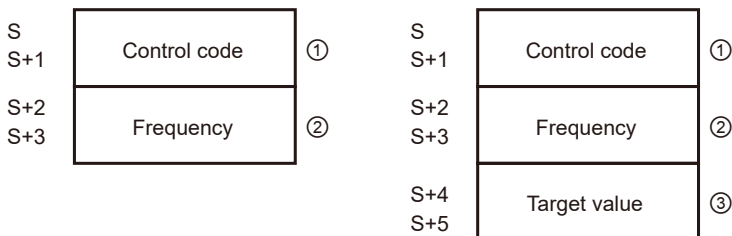

	Operand	Settings	Description
(1)	S, S+1	Control code	Specify the control code by setting the H constant.

31.4 [F172(PSLH)] Pulse Output (JOG Operation)

	Operand	Settings	Description									
			<div style="text-align: right; margin-bottom: 10px;"> H <input type="checkbox"/> <input type="checkbox"/> <input type="checkbox"/> <input type="checkbox"/> <input type="checkbox"/> <input type="checkbox"/> <input type="checkbox"/> <input type="checkbox"/> </div> <p>0: Fixed</p> <p>Acceleration/deceleration steps 0: Mode with no target value 1: Target value match stop mode</p> <p>Duty (on width) 0: Duty 1/2 (50%) 1: Duty 1/4 (25%)</p> <p>Frequency range Not used</p> <p>Output method 00: No counting CW 01: No counting CCW 10: Addition counting CW 12: Addition counting Directional output off 13: Addition counting Directional output on 21: Subtraction counting CW 22: Subtraction counting Directional output off 23: Subtraction counting Directional output on</p>									
(2)	S+2, S+3	Frequency	<p>The setting range of the settable maximum speed varies according to the setting of the initial speed as shown in the table below.</p> <table border="1" style="width: 100%; border-collapse: collapse; margin-bottom: 10px;"> <thead> <tr style="background-color: #d9e1f2;"> <th style="width: 15%;">Range</th> <th style="width: 35%;">Initial speed</th> <th style="width: 50%;">Change the speed setting range</th> </tr> </thead> <tbody> <tr> <td>Low speed</td> <td>K1 to K49 (1 to 49Hz)</td> <td>K1 to K22000 (1Hz to 22kHz)</td> </tr> <tr> <td>High speed</td> <td>K50 to K100000 (50Hz to 100kHz)</td> <td>K50 to K100000 (50Hz to 100kHz)</td> </tr> </tbody> </table> <p>(Note 1) If the initial speed is set to a value less than K1 or exceeding K100000, an operation error occurs.</p> <p>(Note 2) When the initial speed is set to the low-speed range, if the frequency is set to a value less than K1, it is corrected to 1 Hz and, if the frequency is set to a value exceeding K22000, it is corrected to 22 KHz.</p> <p>(Note 3) When the initial speed is set to the high-speed range, if the frequency is set to a value less than K50, it is corrected to 50 Hz and, if the frequency is set to a value exceeding K100000, it is corrected to 100 KHz.</p>	Range	Initial speed	Change the speed setting range	Low speed	K1 to K49 (1 to 49Hz)	K1 to K22000 (1Hz to 22kHz)	High speed	K50 to K100000 (50Hz to 100kHz)	K50 to K100000 (50Hz to 100kHz)
Range	Initial speed	Change the speed setting range										
Low speed	K1 to K49 (1 to 49Hz)	K1 to K22000 (1Hz to 22kHz)										
High speed	K50 to K100000 (50Hz to 100kHz)	K50 to K100000 (50Hz to 100kHz)										
(3)	S+4, S+5	Target value	<p>Target value (absolute value)</p> <p>It is used when setting the target value match stop mode. (Absolute only)</p> <p>Specify the target value in the following range. If a value outside of the range is specified, the number of pulses different from the specified value is output. When specifying the no counting mode, the target value setting is ignored.</p> <table border="1" style="width: 100%; border-collapse: collapse; margin-top: 10px;"> <thead> <tr style="background-color: #d9e1f2;"> <th style="width: 20%;">Output method</th> <th style="width: 80%;">Settable range of target value</th> </tr> </thead> <tbody> <tr> <td>Addition counting</td> <td>Values larger than the current value</td> </tr> </tbody> </table>	Output method	Settable range of target value	Addition counting	Values larger than the current value					
Output method	Settable range of target value											
Addition counting	Values larger than the current value											

31.4 [F172(PSLH)] Pulse Output (JOG Operation)

	Operand	Settings	Description	
			Output method	Settable range of target value
			Subtraction counting	Values smaller than the current value

■ Supplement to pulse output operation

When outputting pulses with the PLS+SIGN (direction output) method, pulses will be output approx. 300 μ s later after the output of direction signal (SIGN). (The characteristics of a motor driver is considered.)

■ Precautions during programming

- This instruction cannot be executed when a control flag corresponding to each channel is on.
- When describing the same channel in both the normal program and the interrupt program, be sure to program not to execute them simultaneously.
- For the FP0H mode, select "Pulse output" for the channel setting corresponding to the system register no. 402.
- For the FPsigma mode, select "Do not use high-speed counter" for the channel setting corresponding to the system register nos. 400 and 401.
- When rewriting during RUN is performed during the operation, the pulse output stops while a program is being rewritten.
- Even if the control code is changed after starting the instruction, the change is invalid. It does not affect on the operation.
- When the frequency is changed to a value outside of the settable range after executing the instruction, the operation is performed with the minimum or maximum value in the specification range without causing an operation error.

Info.

- For the details of the allocations of I/O and flags, refer to ["38.5.2 When Using Pulse Output Function \(FPsigma Compatible Instruction Mode\)"](#).
- For details of the FPsigma mode, refer to ["38.6 FPsigma Mode"](#).

31.5 [F174(SP0H)] Pulse Output (Selectable Data Table Control Operation)

Outputs pulses from a specified pulse output channel according to a specified data table.

■ **Instruction format**

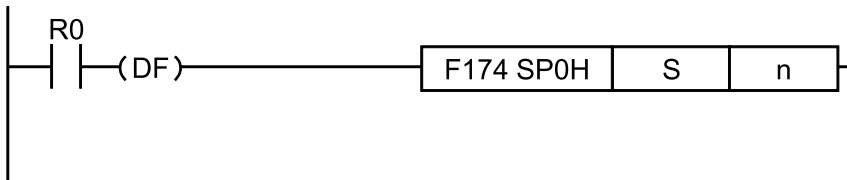

■ **Operand**

Operand	Settings
S	Starting number of the area in which data tables are registered
n	Target channel for pulse output

■ **Memory area type that can be specified**

Operand	WX	WY	WR	WL	SV	EV	DT	LD	I	Constant		Index modifier
										K	H	
S	-	-	-	-	-	-	•	-	-	-	-	•
n	-	-	-	-	-	-	-	-	-	•	•	-

■ **Outline of operation**

- Outputs pulses from a specified channel according to the settings specified in the data table starting with the address specified by [S] when a corresponding control active flag is OFF and the execution condition is ON.
- Switches the pulse frequency when the elapsed value of the high-speed counter reaches the target value set in the data table. (It is performed by the interrupt processing.)
- Stops the pulse output when the elapsed value reaches the final target value.
- For setting the frequency to 50 kHz or more, specify the duty of 1/4 (25%).

31.5 [F174(SP0H)] Pulse Output (Selectable Data Table Control Operation)

■ Data table settings

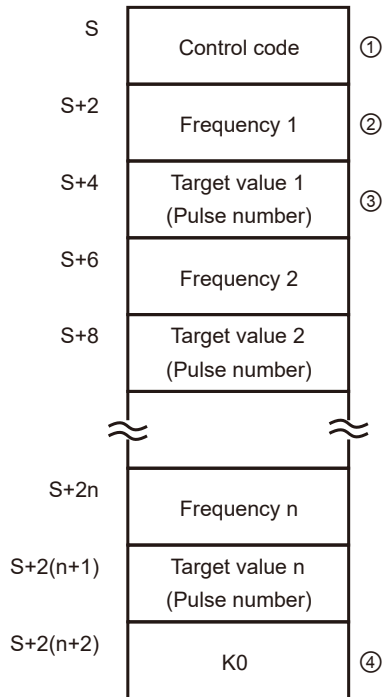

	Operand	Settings	Description						
(1)	S	Control code	<p>Specify the control code by setting the H constant.</p> <p style="text-align: center;">H <input type="checkbox"/><input type="checkbox"/><input type="checkbox"/><input type="checkbox"/><input type="checkbox"/><input type="checkbox"/><input type="checkbox"/><input type="checkbox"/><input type="checkbox"/></p> <p>0: Fixed</p> <p>Duty (on width) 0: Duty 1/2 (50%) 1: Duty 1/4 (25%)</p> <p>Frequency range Not used</p> <p>Operation mode 0: Specify Incremental movement amount (pulse no.). 1: Specify Absolute target value (absolute value).</p> <p>Output method 0: Addition counting CW 1: Subtraction counting CCW 2: Addition counting PLS+SIGN (forward off) 3: Subtraction counting PLS+SIGN (reverse on) 4: Addition counting PLS+SIGN (forward on) 5: Subtraction counting PLS+SIGN (reverse off)</p>						
(2)	S+2, S+2n	Frequency n	<p>The setting range of the settable maximum speed varies according to the setting of the initial speed as shown in the table below.</p> <table border="1"> <thead> <tr> <th>Range</th> <th>Initial speed</th> <th>Maximum speed</th> </tr> </thead> <tbody> <tr> <td>Low speed</td> <td>K1 to K49 (1 to 49Hz)</td> <td>K1 to K22000 (1Hz to 22kHz)</td> </tr> </tbody> </table>	Range	Initial speed	Maximum speed	Low speed	K1 to K49 (1 to 49Hz)	K1 to K22000 (1Hz to 22kHz)
Range	Initial speed	Maximum speed							
Low speed	K1 to K49 (1 to 49Hz)	K1 to K22000 (1Hz to 22kHz)							

31.5 [F174(SP0H)] Pulse Output (Selectable Data Table Control Operation)

	Operand	Settings	Description																	
			Range	Initial speed	Maximum speed															
			High speed	K50 to K100000 (50Hz to 100kHz)	K50 to K100000 (50Hz to 100kHz)															
			<p>When the frequency 1 (initial speed) is the low speed range and the frequency n is not in the range between 1 Hz to 22 kHz, the pulse output stops.</p> <p>When the frequency 1 (initial speed) is the high speed range and the frequency n is not in the range between 50 Hz to 100 kHz, the pulse output stops.</p>																	
(3)	S+4, S+2(n+1)	Target value n	<p>Target value (K-2147483648 to K2147483647)</p> <p>The values of 32-bit data specified as target values should be within the range as shown in the table below.</p> <table border="1"> <thead> <tr> <th colspan="2">Control code setting</th> <th rowspan="2">Settable range of target value</th> </tr> <tr> <th>Operation mode</th> <th>Output method</th> </tr> </thead> <tbody> <tr> <td rowspan="2">Incremental</td> <td>Addition counting</td> <td>Positive values</td> </tr> <tr> <td>Subtraction counting</td> <td>Negative values</td> </tr> <tr> <td rowspan="2">Absolute</td> <td>Addition counting</td> <td>Values larger than the current value</td> </tr> <tr> <td>Subtraction counting</td> <td>Values smaller than the current value</td> </tr> </tbody> </table>			Control code setting		Settable range of target value	Operation mode	Output method	Incremental	Addition counting	Positive values	Subtraction counting	Negative values	Absolute	Addition counting	Values larger than the current value	Subtraction counting	Values smaller than the current value
Control code setting		Settable range of target value																		
Operation mode	Output method																			
Incremental	Addition counting	Positive values																		
	Subtraction counting	Negative values																		
Absolute	Addition counting	Values larger than the current value																		
	Subtraction counting	Values smaller than the current value																		
(4)	S+2(n+2)	K0	End of table (Pulse output stop setting)																	

■ Example of program

[Operation]

- (1) Starts the pulse output at 1000 Hz from the specified channel ch0 when the execution condition R10 of F174 (SP0H) instruction turns ON.
- (2) Switches the frequency to 2500 Hz when 1000 pulses are counted at 1000 Hz.
- (3) Switches the frequency to 5000 Hz when 3000 pulses are counted at 2500 Hz.
- (4) Switches the frequency to 1000 Hz when 8000 pulses are counted at 5000 Hz.
- (5) Stops the pulse output when 10000 pulses are counted.

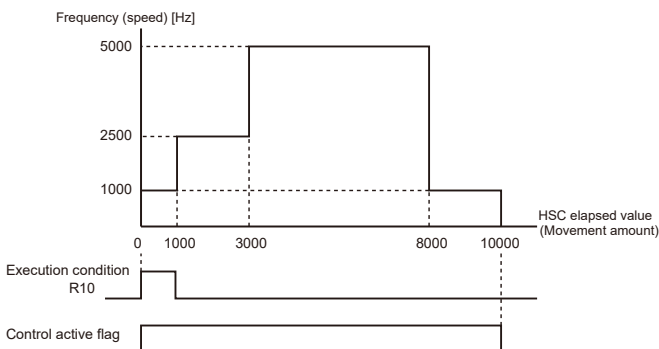

31.5 [F174(SP0H)] Pulse Output (Selectable Data Table Control Operation)

(Note 1) When the execution condition R10 of F174(SP0H) instruction turns ON, the control active flag will turn ON. When the elapsed value reaches 10000 and the pulse output stops, the control active flag will turn OFF. For details of the allocation of control active flags, refer to "38.5.2 When Using Pulse Output Function (FPsigma Compatible Instruction Mode)".

[Settings and program]

Set the frequency range to 191 Hz to 100 kHz and duty 1/4 (25%), and the operation mode to Incremental and the output method to CW.

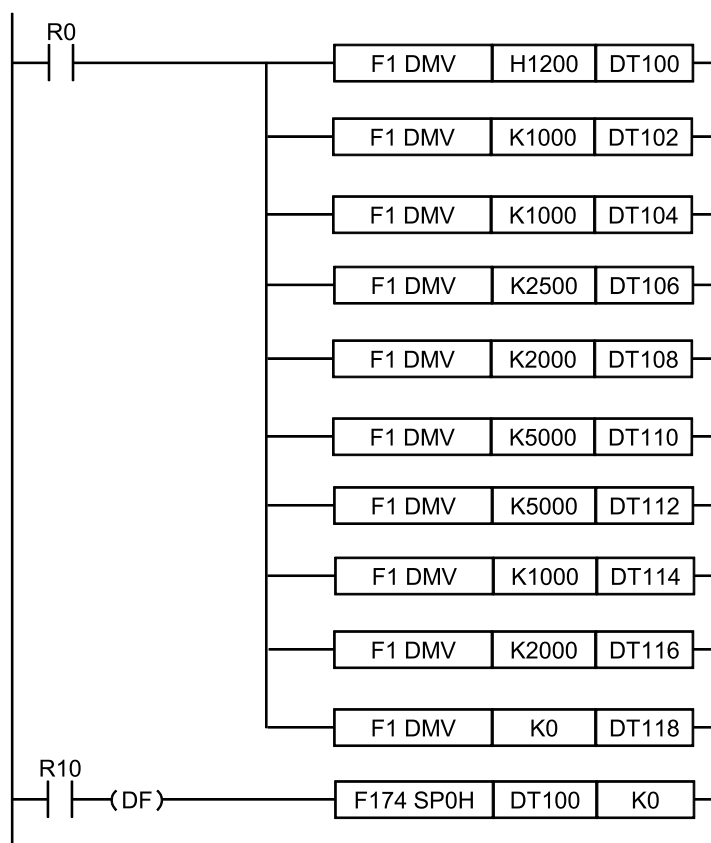

■ Supplement to pulse output operation

When outputting pulses with the PLS+SIGN (direction output) method, pulses will be output approx. 300 μ s later after the output of direction signal (SIGN). (The characteristics of a motor driver is considered.)

■ Precautions during programming

- The control active flag turns ON until the pulse output stops after the execution condition of F174(SP0H) instruction has turned ON.
- This instruction cannot be executed when a control flag corresponding to each channel is ON.
- For the FP0H mode, select "Pulse output" for the channel setting corresponding to the system register no. 402.
- For the FPsigma mode, select "Do not use high-speed counter" for the channel setting corresponding to the system register nos. 400 and 401.

31.5 [F174(SP0H)] Pulse Output (Selectable Data Table Control Operation)

- When the control code or frequency 1 is any value outside of the settable range, an operation error occurs. (When the data of the frequency 1 is 0, nothing is executed and the operation ends.)
- When the frequency after the second step is 0 or outside of the settable range, the pulse output stops.
- When the table pointer exceeds the area of data registers DT during the pulse output, the pulse output control will be canceled and the control active flag will turn OFF.
- The target values should be set in the range shown on the next page. If a value outside of the range is specified, the number of pulses different from the specified value is output.

Info.

- For the details of the allocations of I/O and flags, refer to "[38.5.2 When Using Pulse Output Function \(FPsigma Compatible Instruction Mode\)](#)".
- For details of the FPsigma mode, refer to "[38.6 FPsigma Mode](#)".

31.6 [F175(SPSH)] Pulse Output (Linear Interpolation)

31.6 [F175(SPSH)] Pulse Output (Linear Interpolation)

Pulses are output from channel for 2 pulse output, in accordance with the parameters in the designated data table, so that the path to the target position forms a straight line.

■ Instruction format

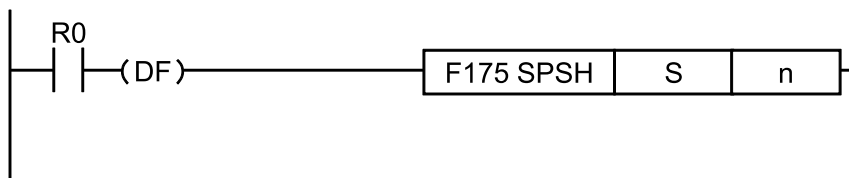

■ Operand

Operand	Settings
S	Starting number of the area in which data tables are registered
n	FP0H mode: 0 or 2, FPsigma mode: 0 (Fixed)

■ Memory area type that can be specified

Operand	WX	WY	WR	WL	SV	EV	DT	LD	I	Constant		Index modifier
										K	H	
S	-	-	-	-	-	-	•	-	-	-	-	•
n	-	-	-	-	-	-	-	-	-	•	•	-

■ Outline of operation

- Outputs pulses from a specified channel when a corresponding control active flag is OFF and the execution condition is ON.
- The control code, initial speed, maximum speed, acceleration/deceleration time, and target value are specified by creating data tables [S] to [S+11] described on the next page using a user program.
- For setting the frequency to 40kHz or more, specify the duty of 1/4 (25%).

■ Data table settings

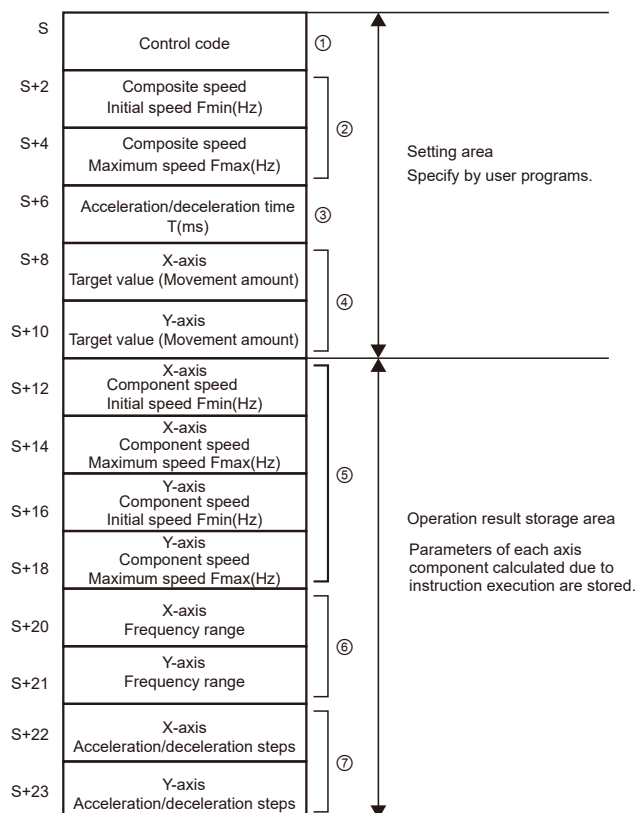

Setting area

	Operand	Settings	Description
(1)	S	Control code	Specify the control code by setting the H constant. <div style="text-align: center; margin: 10px 0;"> </div> <ul style="list-style-type: none"> 0: Fixed Duty (on width) <ul style="list-style-type: none"> 0: Duty 1/2 (50%) 1: Duty 1/4 (25%) 0: Fixed Operation mode and output method <ul style="list-style-type: none"> 00: Incremental CW/CCW 02: Incremental PLS+SIGN (forward off/reverse on) 03: Incremental PLS+SIGN (forward on/reverse off) 10: Absolute CW/CCW 12: Absolute PLS+SIGN (forward off/reverse on) 13: Absolute PLS+SIGN (forward on/reverse off)
(2)	S+2	Composite speed Initial speed	Composite speed (Initial speed, maximum speed) (Hz) <K constant> 1.5 Hz to 100 kHz [k1 to K100000]

31.6 [F175(SPSH)] Pulse Output (Linear Interpolation)

	Operand	Settings	Description
	S+4	Fmin(Hz) Composite speed Maximum speed Fmax(Hz)	<p>(However, for 1.5 Hz, the angle is 0 degree or 90 degrees only. Also, for specifying 1.5 Hz, specify K1.)</p> <ul style="list-style-type: none"> When the component speed becomes lower than the minimum speed in each frequency range, it will be a corrected component speed. Do not set 60 kHz or more when using any two of the high-speed counter, periodical interrupt and PLC link are used simultaneously. When the initial speed is set to the maximum speed, the pulse output is performed without acceleration and deceleration. Specify the composite speed to make the component speed of each axis be 1.5Hz or more. Composite speed (Initial speed): 30 kHz or less <p>Notes on the specification of composite speed (initial speed) When each initial component speed of CH0 and CH2 is not 1.5 Hz or more by the following arithmetic expression, the path may not be linear. (When the following formula is not satisfied)</p> $f \geq \frac{1.5 \sqrt{(\Delta X^2 + \Delta Y^2)}}{\Delta X}$ <p>Δx: Channel whose distance of (target value - current value) is short Δy: Channel whose distance of (target value - current value) is long</p>
(3)	S+6	Acceleration/ deceleration time T(ms)	<p>Acceleration/deceleration time (ms) <K constant> K0 to K32767</p> <p>In the case of 0, the pulse output is performed at the initial speed (composite speed) without acceleration and deceleration.</p>
(4)	S+8	X-axis Target value (Movement amount)	<p>K-8388608 to K8388607</p> <p>When only one axis is activated;</p> <ol style="list-style-type: none"> For the incremental mode, set the target value of the axis that is not activated to 0. For the absolute mode, set the target value of the axis that is not activated to the same as the current value. <p>(Note): In the case of linear interpolation, infinite rotation cannot be performed.</p>
	S+10	Y-axis Target value (Movement amount)	

Operation result storage area

	Operand	Settings	Description
(5)	S+12	X-axis Component speed Initial speed Fxmin	<p>The component speed (initial speed and maximum speed of each axis) is stored as 2 words in real type.</p> $\text{X-axis component speed} = \frac{(\text{Composite speed}) \times (\text{X-axis movement amount})}{\sqrt{((\text{X-axis movement amount})^2 + (\text{Y-axis movement amount})^2)}$ $\text{Y-axis component speed} = \frac{(\text{Composite speed}) \times (\text{Y-axis movement amount})}{\sqrt{((\text{X-axis movement amount})^2 + (\text{Y-axis movement amount})^2)}$ <p>Example) Even when the initial speed is corrected, the calculated value is stored as is in the operation result storage area.</p>
	S+14	X-axis Component speed Maximum speed Fxmax	

31.6 [F175(SPSH)] Pulse Output (Linear Interpolation)

	Operand	Settings	Description
	S+16	Y-axis Component speed Initial speed Fymin	
	S+18	Y-axis Component speed Maximum speed Fymax	
(6)	S+20	X-axis Frequency range	The frequency ranges are automatically selected by the system for the components of each axis. 0: Low speed range (1 Hz to 22 kHz) 1: High speed range (50Hz to 100 kHz)
	S+21	Y-axis Frequency range	When the initial speed (X/Y axis) is the low speed range and the maximum speed (X/Y axis) exceeds 22 kHz, the initial speed (X/Y axis) is corrected to 50 Hz. When the initial speed (X/Y axis) is less than 1Hz and the maximum speed (X/Yaxis) exceeds 22 kHz or less, the initial speed (X/Y axis) is corrected to 1 Hz.
(7)	S+22	X-axis Acceleration/ deceleration steps	The acceleration/deceleration steps are automatically calculated by the system in the range of 0 to 60 steps. <ul style="list-style-type: none"> When the operation result is 0, the pulse output is performed at the initial speed (composite speed) without acceleration and deceleration. The acceleration/deceleration steps are calculated by the following formula; Acceleration/deceleration time (ms) x Initial component speed (Hz).
	S+23	Y-axis Acceleration/ deceleration steps	Example) When the settings are as follows; Incremental, Initial speed=5 kHz, Acceleration/deceleration time=0.5 s, CH0 target value=1000, and CH2 target value=50. $\text{CH0 Initial component speed} = \frac{300 \times 1000}{\sqrt{(1000^2 + 50^2)}} = 299.626 \text{ Hz}$ $\text{CH2 Initial component speed} = \frac{300 \times 50}{\sqrt{(1000^2 + 50^2)}} = 14.981 \text{ Hz}$ <p>CH0 Acceleration/deceleration steps = $500 \times 10^{-3} \times 299.626 \approx 147.8 \rightarrow 60$ steps CH2 Acceleration/deceleration steps = $500 \times 10^{-3} \times 14.981 \approx 7.4 \rightarrow 7$ steps</p>

■ Supplement to pulse output operation

When outputting pulses with the PLS+SIGN (direction output) method, pulses will be output approx. 300μs later after the output of direction signal (SIGN). (The characteristics of a motor driver is considered.)

■ Precautions during programming

- Set the target value and movement amount to be within the following range.

31.6 [F175(SPSH)] Pulse Output (Linear Interpolation)

-8,388,608 to +8,388,607

When using this instruction in combination with other positioning instructions such as F171, also set the target values for those instructions to be within the above range.

- When using this instruction for a purpose for which high accuracy is required, confirm the operation using a real machine.
- When describing the same channel in both the normal program and the interrupt program, be sure to program not to execute them simultaneously.
- For the FP0H mode, select "Pulse output" for the channel setting corresponding to the system register no. 402.
- For the FPsigma mode, select "Do not use high-speed counter" for the channel setting corresponding to the system register nos. 400 and 401.
- By performing the rewriting during RUN while outputting pulses, more pulses than the setting may be output.

Info.

- For the details of the allocations of I/O and flags, refer to "[38.5.2 When Using Pulse Output Function \(FPsigma Compatible Instruction Mode\)](#)".
- For details of the FPsigma mode, refer to "[38.6 FPsigma Mode](#)".

32 Logging/Trace Control Instruction

32.1 F420 LOGST (Logging trace start request)	32-2
32.2 F421 LOGED (Logging trace stop request)	32-3
32.3 F422 LOGSMPL (Sampling Trace)	32-4

32.1 F420 LOGST (Logging trace start request)

32.1 F420 LOGST (Logging trace start request)

Requests to start a logging trace.

■ Instruction format

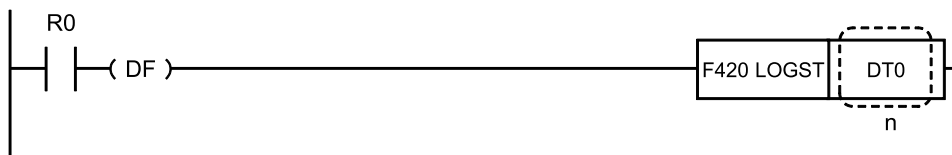

■ Operands

Items	Settings
n	Number of logging trace requested to start

■ Devices that can be specified (indicated by ●)

Operands	WX	WY	WR	WL	SV	EV	DT	LD	I	SWR	SDT	Constant				Index modifier	Integer Device
												K	H	M	f		
n	●	●	●	●	●	●	●	●	●			●	●			●	

■ Outline of operation

A request is made to start a logging trace of the number specified by [n] (0 to 3).

■ Precautions for programming

- There is no issue with requesting to start a logging trace while a logging trace is running or being processed.
- It is not necessary to execute an F420 LOGST instruction if a logging trace is set to automatically start or when starting a logging trace via a command.

■ Flag operations

Name	Description
R9007	When a request via a communication command is currently being received (logging trace start/logging trace stop/logging trace registration)
R9008	When a logging trace stop is being requested
(ER)	When the logging trace number is out of range
	When a sampling trace is being performed

32.2 F421 LOGED (Logging trace stop request)

Requests to stop a logging trace.

■ Instruction format

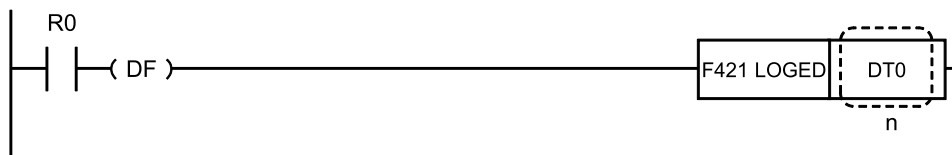

■ Operands

Items	Settings
n	Number of logging trace requested to stop

■ Devices that can be specified (indicated by ●)

Operands	WX	WY	WR	WL	SV	EV	DT	LD	I	SWR	SDT	Constant				Index modifier	Integer Device
												K	H	M	f		
n	●	●	●	●	●	●	●	●	●			●	●			●	

■ Outline of operation

A request is made to stop a logging trace of the number specified by [n] (0 to 3).

■ Precautions for programming

- There is no issue with requesting to stop a logging trace while a logging trace is stopped or a logging trace stop is being processed.

■ Flag operations

Name	Description
R9007	When a request via a communication command is currently being received (logging trace start/logging trace stop/logging trace registration)
R9008	When a logging trace start is being requested
(ER)	When the logging trace number is out of range

32.3 F422 LOGSMPL (Sampling Trace)

32.3 F422 LOGSMPL (Sampling Trace)

Requests data logging for logging trace.

■ Instruction format

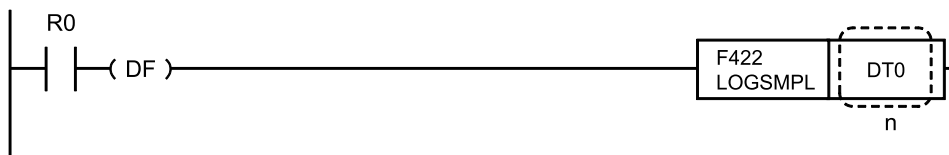

■ Operands

Items	Settings
n	Logging trace number for data logging

■ Devices that can be specified (indicated by ●)

Operands	WX	WY	WR	WL	SV	EV	DT	LD	I	SWR	SDT	Constant				Index modifier	Integer Device
												K	H	M	f		
n	●	●	●	●	●	●	●	●	●			●	●			●	

■ Outline of operation

Data logging is performed for the logging trace of the number specified in [n] (0 to 3).

■ Precautions for programming

- This instruction is used when the trigger condition for the start of data logging is set by the user program.

It is not necessary to execute the F422 LOGSMPL instruction when the trigger condition to start logging is set to bit device, interval, or time.

■ Flag operations

Name	Description
R9007	When the data logging condition for the logging trace number is something other than "Instruction"
R9008 (ER)	When the logging trace number is out of range
	When logging trace is stopped

33 SD Card Access Instructions

33.1	Common Precautions for SD Memory Card Access Instructions	33-2
33.2	F425 CDTWT (File Write of Operation Memory in BIN Format)	33-6
33.3	F426 CDTRD (Read from BIN Format File to Operation Memory) ...	33-8
33.4	F427 CWT (File Data Write Instruction).....	33-10
33.5	F428 CRD (Read File Data).....	33-23
33.6	F429 CMKDIR (create directory)	33-32
33.7	F430 CRMDIR/F431 CRMDIRFL (Directory Deletion).....	33-35
33.8	F432 CFDEL (delete file)	33-39
33.9	F433 CPR (ASCII Data Write into File).....	33-41
33.10	F434 CRD1 (Read one line from file).....	33-44
33.11	F435 CREN (Rename File)	33-50
33.12	F436 CCOPY (File Copy)	33-52
33.13	F437 CMV (File Transfer)	33-55
33.14	F438 CFREE (SD memory card free space acquisition: byte units)	33-58
33.15	F439 CFREEK (SD Memory Card Free Space Acquisition: Kilobyte Units)	33-60
33.16	F440 CFLS (File status acquisition).....	33-62
33.17	F441 PanaSD (Read of lifetime information of Panasonic SD card).....	33-65

33.1 Common Precautions for SD Memory Card Access Instructions

33.1 Common Precautions for SD Memory Card Access Instructions

■ Instruction operation

- At the start of instruction execution, checks are conducted to confirm whether a SD memory card is inserted or not, if the cover is closed, and whether the card is write-protected or not.
- During execution, the SD memory card access instruction active flag (R917A) is ON, and the execution completion flag (R917B) is OFF.
- On completion of execution, the SD memory card access instruction active flag (R917A) turns OFF, and the execution completion flag (R917B) turns ON.
- Instruction execution is performed over multiple scans.
- On completion of execution, the SD memory card access instruction execution result flag (R917C) turns ON or OFF according to the result, and the execution end code is stored in system data register DT90530.
- Use the execution result flag to judge whether the SD memory card access instruction has completed normally or abnormally when the execution completion flag turns ON. The contents of errors are stored in system data register DT90530.
- Only one SD memory card access instruction can be executed at a time. To execute more than one instruction, perform exclusive control using flags such as the SD memory card access instruction active flag.
- If another SD memory card access instruction is being executed when starting an instruction, the new instruction cannot be executed.

■ Flag operation

SD memory card access instruction execution condition

R917A: SD memory card access instruction execution in progress flag

R917B: SD memory card access instruction execution complete flag

R917C: SD memory card access instruction execution results flag

DT90530: SD memory card access instruction execution result code

The above flags and registers are all set when the instruction is executed.

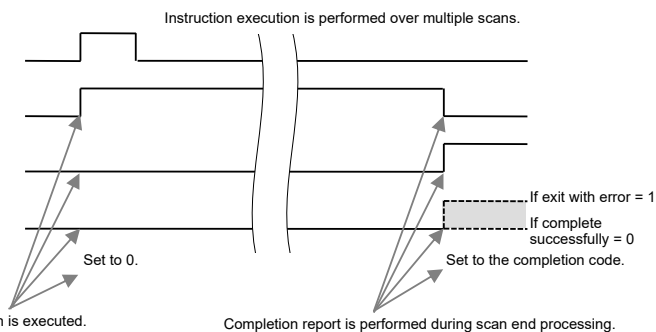

(Note 1) If an error such as a no SD memory card, SD memory card write-protected, or improper SD memory card file name length error is detected, instruction execution is reported as complete at the start of execution without the active flag being turned ON.

■ Error Codes Table

Code	Name	Description	Related instructions
0	Normal end		
1	No SD memory card	No SD memory card is inserted, or the cover is open.	All SD memory card access instructions, at the start of instruction execution
2	SD memory card write-protected	The SD memory card is write-protected.	Write, delete, move, copy, and rename instructions

33.1 Common Precautions for SD Memory Card Access Instructions

Code	Name	Description	Related instructions
3	Specified file name error	Code that cannot be specified for a file name is used. There are too many hierarchies for the specified folder.	Folder access and file access instructions
4	No specified file	The specified file does not exist.	Folder access and file access instructions
5	File already exists	The specified file already exists.	Move, copy, and rename instructions
6	File read error		At the time of reading
7	File write error	A write-protect attribute is set for the specified file.	Write, delete, move, copy, and rename instructions
8	File access position error	The reading position or writing position is incorrect.	At execution of the F437 CWT, F428 CRD, and F434 CRD1 instruction.
9	SD memory card capacity shortage	Cannot be executed because there is not enough free space on the SD memory card.	Write, delete, move, copy, and rename instructions
10	Read format error	Error in the conversion format when reading a file.	At execution of the F428 CRD instruction.
11	File access contention	A file that is being logged is specified. A file that is being accessed via FTP is specified.	Write, delete, move, copy, and rename instructions
12	Deletion of non-empty directory	An attempt is made to delete a non-empty directory.	At execution of the F430 CRMDIR instruction.
-1 to -99	Others		All instructions

■ How to specify folder and file names in SD memory card access instructions

- Specify the full path (up to 256 characters). Do not specify the drive name.
<Example>
When specifying abc.txt directly under the root directory: When specifying def.txt under the folder A:
`\abc.txt \a\def.txt`
- When the F253 SSET instruction is used and ([S1] is K1 to K32767) (storage area size specification)
`F253 SSET K8 "\abc.txt" DT0`
Specify as above, and specify DT1 in the file name specification of the SD memory card access instruction.
*Because the storage specifications are DT0: Storage area size; DT1: Number of characters; DT2 and after: Character codes.
- When the F253 SSET instruction is used and ([S1] is H8000) (specification of no storage area size)
`F253 SSET H8000 "\abc.txt" DT0`
Specify as above, and specify DT0 in the file name specification of the SD memory card access instruction.
*Because the storage specifications are DT0: Number of characters; DT1 and after: Character codes.

33.1 Common Precautions for SD Memory Card Access Instructions

- When specifying a non-existent folder when using instructions F437 CWT, F429 CMKDIR or F433 CPR, only a subfolder directly under the parent folder can be automatically created. Two or more new folders cannot be created by one instruction. If specifying more than two folders, a no specified file error occurs.

■ SD memory card control specifications

	SD	SDHC
File system	FAT16	FAT32
Max. length of file name	Supports long file names (VFAT)	
Max. volume size	2GB	32GB
Max. file size	2GB	4GB
Max. number of files (8.3 format): Root directory	512	65535
Max. number of files (8.3 format): Sub directory	65534	65534
Max. number of files (long format): Root directory	170	21845
Max. number of files (long format): Sub directory	56634	65534

Items	Description
Long file name	256 bytes for full path (when specifying route with \; 255 bytes when omitting route \.)
File name/Directory name	ASCII characters (H20 - H7E)/Half-width Katakana (HA1 - HDF)
	Japanese (S-JIS code) (H'8140 to H'9FFC, H'E040 to H'EAA4)

■ Common precautions

- Error flags are not cleared even when normal arithmetic operations are performed. Use the F148 ERR instruction to clear error flags.
- An SD memory card access instruction cannot be executed when another SD memory card access instruction is already being executed. Do not execute the SD memory card access instruction until the active instruction is complete.
- It may take several scans for the processing to complete.
- Use in an interrupt program is not possible.
- Character string data is set in the order of number of characters then character data.

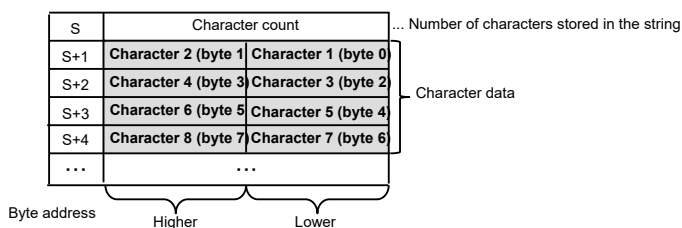

33.1 Common Precautions for SD Memory Card Access Instructions

<Example> When specifying 5 for the number of characters, and "ABCDE" for the character data table

DT0	5	
DT1	"B"	"A"
DT2	"D"	"C"
DT3		"E"
DT4		

Byte address Higher Lower

- Include the extension in the file name specification.

33.2 F425 CDTWT (File Write of Operation Memory in BIN Format)

33.2 F425 CDTWT (File Write of Operation Memory in BIN Format)

■ Instruction format

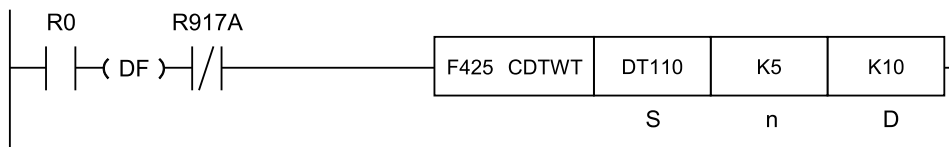

■ Operands

Items	Settings
S	Starting address of the operation memory device storing the data to be written.
n	Number of data items to be written. Range: 0 to 32767
D	File number (3-digit) to be attached to the file names of files created or overwritten. Range: 0 to 999

■ Devices that can be specified (indicated by ●)

Operands	WX	WY	WR	WL	SV	EV	DT	LD	I	SWR	SDT	Constant				Index modifier	Integer Device
												K	H	M	f		
S	●	●	●	●	●	●	●	●	●							●	
n	●	●	●	●	●	●	●	●	●			●	●			●	
D	●	●	●	●	●	●	●	●	●			●	●			●	

■ Outline of operation

- [n] words of binary data are read from the area starting from [S] and is written as a binary format file to an SD memory card.
- The folder name is \data, the file name is dtxxx.bin. The xxx in the file name is the number specified by operand [D].
- If the specified folder does not exist, it is newly created. If a file with the same name already exists in the specified folder, the file is overwritten.

■ Processing examples

- Five words of data are read from device DT110 specified by [S] and a binary format file (.bin) is written to the \data folder on the SD memory card.
- The file name, "dt010.bin", includes the file number of 10 specified by [D].

33.2 F425 CDTWT (File Write of Operation Memory in BIN Format)

[S] ...DT110 [n] ...K5 [D] ...10

DT108	H 0108
DT109	H 0109
DT110	H 0110
DT111	H 0111
DT112	H 0112
DT113	H 0113
DT114	H 0114
DT115	H 0115
DT116	H 0116
DT117	H 0117
DT118	H 0118

File dt**010**.bin (16-bit binary format)



1001110112 0113011401

■ Precautions for programming

- Also refer to section "[33.1 Common Precautions for SD Memory Card Access Instructions](#)".
- When rewriting a file, if the attribute of the target file for rewriting is set to read only, it cannot be rewritten.
- The SD memory card access instruction execution in progress flag (R917A) turns ON from when the execution condition turns ON to when execution of the instruction is complete. During this time other SD memory card access instructions cannot be executed.
- Confirm that the SD memory card access instruction execution completion flag (R917B) is OFF before setting the execution condition to OFF.

■ Flag operations

Name	Description
R917A (SD memory card access instruction execution in progress)	Turns ON when instruction execution starts. Turns OFF when instruction execution is complete.
R917B (SD memory card access instruction execution complete)	Turns OFF when instruction execution starts. Turns ON when instruction execution is complete.
R917C (SD memory card access instruction execution result)	Indicates the execution results when instruction execution is complete. Normal end = 0, abnormal end = 1
R9007 R9008 (ER)	Turns ON if the specified destination is an out-of-range device when the device specification is indirect access (index modification). Turns ON when a value outside the range is specified for [n]. Turns ON when an out of range value is specified for [D].

33.3 F426 CDTRD (Read from BIN Format File to Operation Memory)

33.3 F426 CDTRD (Read from BIN Format File to Operation Memory)

■ Instruction format

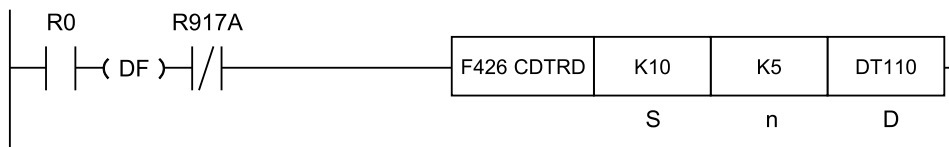

■ Operands

Items	Settings
S	Number of the file (three digits) in the SD memory card on which the data to be read is stored. Range: 0 to 999
n	Number of data items to be read. Range: 0 to 32767
D	Starting address of the device for arithmetic operations that stores the data to be read

■ Devices that can be specified (indicated by ●)

Operands	WX	WY	WR	WL	SV	EV	DT	LD	I	SWR	SDT	Constant				Index modifier	Integer Device
												K	H	M	f		
S	●	●	●	●	●	●	●	●	●			●	●			●	
n	●	●	●	●	●	●	●	●	●			●	●			●	
D		●	●	●	●	●	●	●	●							●	

■ Outline of operation

- [n] items of data are read from a binary format file in the SD memory card and stored on the data device at the address starting from [D].
- The folder name is \data, and the file name is dtxxx.bin. xxx in the file name is the file number specified by the operand [S].

■ Processing examples

- A binary format file is read from the folder \data in the SD memory card and stored on the device for arithmetic operations starting from [D].
- The binary format file name becomes "dt010.bin", which has the file number 10 specified by [S] added.

33.3 F426 CDTRD (Read from BIN Format File to Operation Memory)

[S] ...10 [n] ...K5 [D] ...DT110

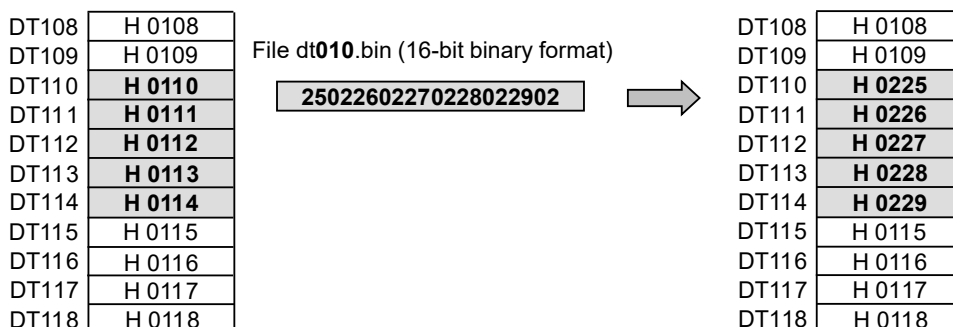

■ Precautions for programming

- Also refer to section "33.1 Common Precautions for SD Memory Card Access Instructions".
- The SD memory card access instruction execution in progress flag (R917A) turns ON from when the execution condition turns ON to when execution of the instruction is complete. During this time other SD memory card access instructions cannot be executed.
- During execution of the F426 CDTRD instruction, the data values read from the SD memory card are written in order from the start of the specified data device. As a result, do not read data within the range of the data device involved in processing by the F426 CDTRD instruction until read processing is complete.
- If the number of data items stored in the file is smaller than the specified number of read data items, the SD card access instruction execution result (R917C) turns ON and an execution error occurs.
- If a folder does not exist, or if there is no file with the specified file number in the folder, an error occurs.

■ Flag operations

Name	Description
R917A (SD memory card access instruction execution in progress)	Turns ON when instruction execution starts. Turns OFF when instruction execution is complete.
R917B (SD memory card access instruction execution complete)	Turns OFF when instruction execution starts. Turns ON when instruction execution is complete.
R917C (SD memory card access instruction execution results)	Indicates the execution results when instruction execution is complete. Normal end = 0, abnormal end = 1
R9007 R9008 (ER)	Turns ON if the specified destination is an out-of-range device when the device specification is indirect access (index modification). Turns ON when a value outside the range is specified for [n]. Turns ON when a value outside the range is specified for [S].

33.4 F427 CWT (File Data Write Instruction)

33.4 F427 CWT (File Data Write Instruction)

■ Instruction format

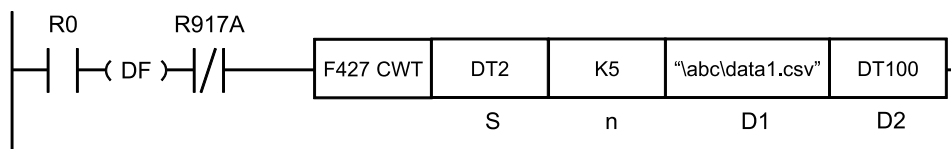

■ Operands

Items	Settings
S	Starting address of the device storing the data to be written (data format: unsigned 16-bit integer)
n	Number of write data items (data format: unsigned 16-bit integer)
D1	Starting address of the device storing the path name and number of characters of the file to be written Specify the number of characters in [D1] and the path name (folder name + file name: maximum 256 characters) in [D1+1] and following addresses
D2	Starting address of the device storing the parameters related to the write save format, etc. (data format: unsigned 16-bit integer)

■ Devices that can be specified (indicated by ●)

Operands	WX	WY	WR	WL	SV	EV	DT	LD	I	SWR	SDT	Constant				Index modifier (Note 1)	Integer Device
												K	H	M	f		
S	●	●	●	●	●	●	●	●	●						●		
n	●	●	●	●	●	●	●	●	●			●	●		●		
D1	●	●	●	●	●	●	●	●	●				●		●		
D2	●	●	●	●	●	●	●	●	●						●		

(Note 1) A character constant cannot be specified.

■ Outline of operation

- [n] items of data stored at the device address starting from [S] are read and written to the SD memory card file specified by [D1] according to the parameters specified by [D2].

■ [n]: Specification of number of write data items

Saving format	Set value of [D2]	Setting range of [n]
16-bit data	K1, K2, K7, K11	0 to 32767
32-bit data	K3, K4, K5, K8	0 to 32766
64-bit data	K9	0 to 16383
ASCII	K10	0 to 1999

(Note 1) When "0" is specified for [n], the result is as follows.

- 1: When creating a new file, a 0-byte file is created.

33.4 F427 CWT (File Data Write Instruction)

2: When rewriting a file, a 0-byte file is created.

3: When appending to a file, only the file date is changed.

■ [D1]: Specification of folder and file name

Setting device	Description
D1	Specifies the number of characters used in the folder name and file name of the file to be written. (Full path specification)
D1+1 to D1+128	Specifies the folder name and file name of the file to be written. Specify the full path, up to 256 characters including the folder name and filename

(Note 1) When using the tool software FPWIN GR7, you can directly enter the path name (folder name and file name) as character constants.

(Note 2) If specifying data register DT or another memory area, use the F253 (SSET) instruction to store the path name (folder name and filename) as character data.

■ [D2] to [D2+6]: Parameters related to write format, etc.

Setting device	Description
D2	Write format
D2+1	Write mode
D2+2	Options
D2+3	Write position (file pointer)
D2+4	Number of bytes from the start or end of the file
D2+5	Number of data items that could be written
D2+6	

■ [D2]: Specification of write format

Set value of D2	Write contents		Fixed number of digits	Extension	
K0	-	-	-	-	
K1	DEC	Unsigned 16-bit integer	5	.CSV (comma-separated text)	
K2		Signed 16-bit integer	6		
K3		Unsigned 32-bit integer	10		
K4		Signed 32-bit integer	11		
K5	Floating point real number	32bit	13		
K7	HEX	1 word	4		
K8		Two words	8		
K9		Four words	16		
K10	ASCII	Character string	-		
K11	BIN	16bit	-		.BIN (BIN data)

33.4 F427 CWT (File Data Write Instruction)

■ [D2+1]: Specification of write mode

Set value of D2+1	Description
0: New file mode	Deletes the file contents and then writes data. When no file exists, a new one is created.
1: Add mode	Writes additional data from the end of the file. When no file exists, a new one is created.
2: Write position specification mode 1	Writes data from the position offset by the number of bytes stored in [D2+3] and [D2+4] from the start of the file.
3: Write position specification mode 2	Writes data from the position offset by the number of bytes stored in [D2+3] and [D2+4] from the end of the file.

Example 1: When the addition a file is specified

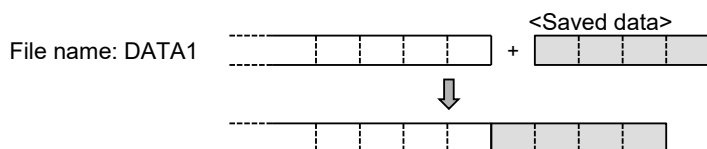

Example 2: When the write position is specified from the start of the file

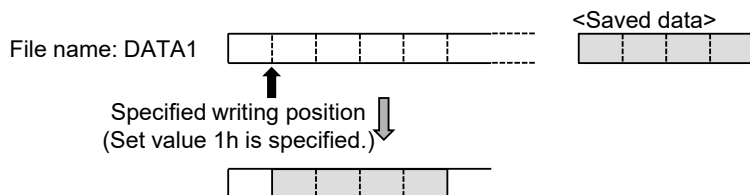

Example 3: When the write position is specified from the end of the file

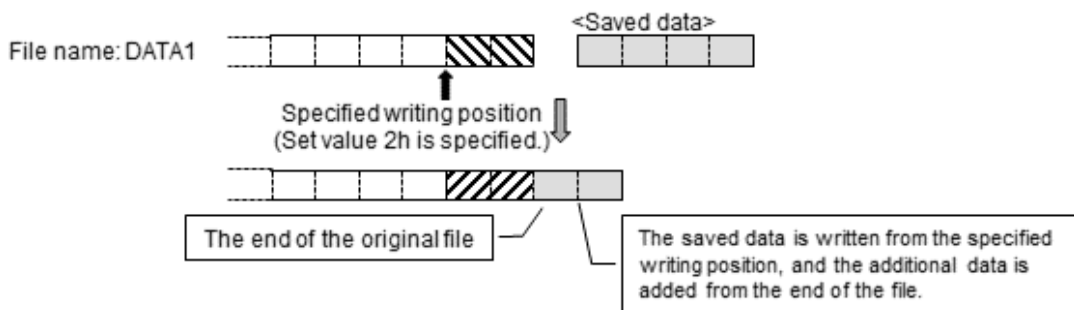

■ [D2+2]: Specification of options

Specified bits	Description	
bit0 to 7	Line break	<ul style="list-style-type: none"> Line break setting for lines other than the end of the file when outputting to a CSV file. 0: Line break is not used except at the end of the file.

33.4 F427 CWT (File Data Write Instruction)

Specified bits	Description	
		1 to 255: Line breaks are inserted in comma-separated data the specified number of times. [D2] When K10 ASCII or K11 BIN is specified for the save format, the line break setting is invalid.
bit8	Postfix	<ul style="list-style-type: none"> Specifies the data to be added to the end of the write data when outputting to a CSV file. 0: Insert a line break (0Dh+0Ah). 1: Insert a comma (2Ch). However, lines with line breaks do not have a trailing comma.
bit9	Zero suppression	<ul style="list-style-type: none"> When outputting to a CSV file, specify whether to perform zero suppression or not. 0: Zero suppression OFF (no zero suppression) 1: Zero suppression ON (zero suppression performed) (Unnecessary zeros are deleted and the file is output right-aligned.)
Bit10 to 15	Reserved for system (set to 0)	

Example of option settings

- When the writing format is [D2] = 7 (HEX 16-bit), [D2+2] bit 9 = 0 (no zero suppression), and the write data is "1 2 3 4 5", the data to be written is indicated by the value of bits 0-7 of [D2+2].

[D2+2] bit0 to 7	Data to be written (data specified to be appended)									
0	0001	,	0002	,	0003	,	0004	,	0005	
1	0001	0D0A	0002	0D0A	0003	0D0A	0004	0D0A	0005	
2	0001	,	0002	0D0A	0003	,	0004	0D0A	0005	
3	0001	,	0002	,	0003	0D0A	0004	,	0005	
4	0001	,	0002	,	0003	,	0004	0D0A	0005	
5	0001	,	0002	,	0003	,	0004	,	0005	
6	0001	,	0002	,	0003	,	0004	,	0005	

(Note 1) 0D0A in the table indicates a line break (0Dh+0Ah).

Examples of conversion when zero suppression is ON and OFF

[D2] Write format		Number of digits	Zero suppression: ON (zero suppression performed)	Zero suppression: OFF (no zero suppression)
1	Unsigned 16-bit integer	5	_____0	00000
2	Signed 16-bit integer	6	_____0	_.00000
			_____-1	-00001
3	Unsigned 32-bit integer	10	_____0	0000000000
4	Signed 32-bit integer	11	_____0	_.0000000000

33.4 F427 CWT (File Data Write Instruction)

[D2] Write format		Number of digits	Zero suppression: ON (zero suppression performed)	Zero suppression: OFF (no zero suppression)
			_____ - 1	-0000000001
5	Floating point real number 32bit	13	_____ 0	_000000000000
			_____ - 1	-000000000001
			_____1E-10	_00000001E-10
			_____.1.234567	_00001.234567
			_____-3.402823E+38	-3.402823E+38
6	HEX 1-word	4	___ 0	0000
7	HEX 2-word	8	_____ 0	00000000
8	HEX 4-word	16	_____ 0	0000000000000000

(Note 1) The "_" symbol in the table indicates a space (H20).

■ [D2+3], [D2+4]: Specification of write position (file pointer)

- This is effective when the write position specification mode is selected for [D2+1].

The write position (file pointer) indicates the position separated in 1-byte units from the start (or end) of the data of the stored file.

16-bit integer bin. format	01	00	17	00	59	01	D7	11	D5	DD	01	00	17	00	59	01	FF	FF		
16-bit integer csv. format	(20H)	(20H)	(20H)	(20H)	1 (31H)	,	(20H)	(20H)	(20H)	2 (32H)	3 (33H)	,	(20H)	(20H)	3 (33H)	4 (34H)	5 (35H)	,	(2CH)	
ASCII csv. format	" (22H)	A (41H)	B (42H)	C (43H)	D (44H)	E (45H)	" (22H)	,	(2CH)	(22H)	a (61H)	b (62H)	c (63H)	d (64H)	" (22H)	,	(2CH)	(22H)	1 (31H)	2 (32H)
Writing position (File pointer)	0	1	2	3	4	5	6	7	8	9	A	B	C	D	E	F	10	11	12	

- Operation at the end of writing to the SD memory card

Write mode	Operation
Write position specification mode 1	Counting from the start of the file, the position of the end of the newly saved data is stored in the [D2+3] and [D2+4] areas.
Write position specification mode 2	Counting from the end of the file, the position of the end of the newly saved data is stored in the [D2+3] and [D2+4] areas.

- When the writing process is performed again, the operation is as follows.

Write mode	Operation
Write position specification mode 1	Data is written to the file from the write position (file pointer) counted from the start of the file.
Write position specification mode 2	Data is written to the file from the write position (file pointer) counted from the end of the file.
New file mode	Data is written from the start of the file unconditionally. The writing position (file pointer) is not stored after the writing process is completed.

Write mode	Operation
Add mode	Data is written from the end of the file unconditionally. The writing position (file pointer) is not stored after the writing process is completed.

■ **[D2+5], [D2+6]: Number of data items that could be written**

- Stores the number of data items that could be written after writing to the file.

Example 1: If the number of data items to be written is 40 and the file has 100 free spaces, 40 is stored for the number of written data.

Example 2: If the number of data items to be written is 40 and the file has 30 free spaces, 30 is stored for the number of written data.

Example 3: If the number of characters to be written is 40 and the file has free space for 100 characters, 40 is stored for the number of characters written.

Example 4: If the number of characters to be written is 40 and the file has free space for 30 characters, 30 is stored for the number of characters written.

■ **Processing examples (.csv format file)**

Example 1)

- Five items of unsigned 16-bit integer data (five words) are read from the area starting from device DT2. The read data is written to the file "abc\data1.csv" in the SD memory card in new file mode.
- A blank line is inserted in the data through zero suppression, and a comma (2Ch) is inserted at the end.

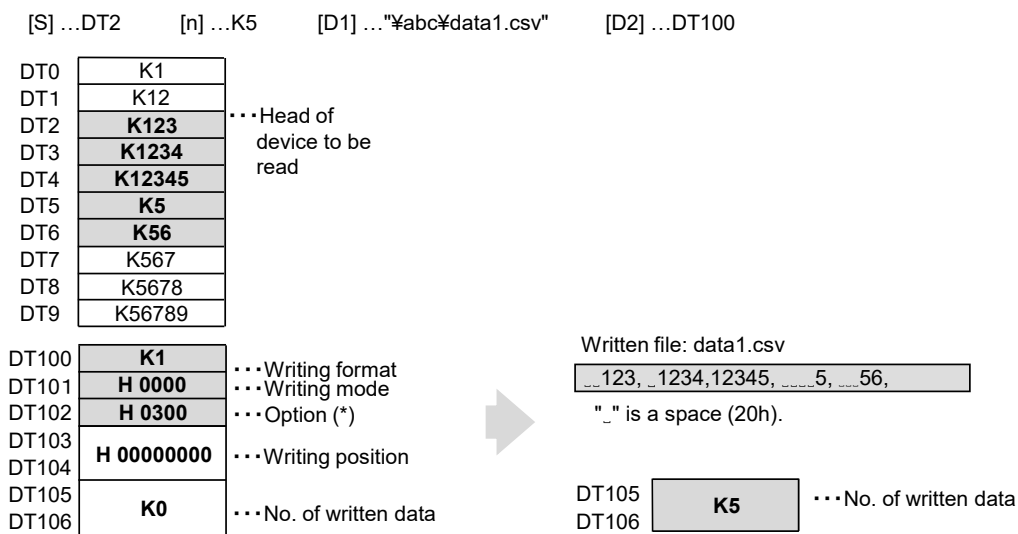

- (*) Option
- bit0-7(0): Line break- Not insert line breaks except at the end of file.
 - bit8(1) : Postfix - Insert a comma (2Ch).
 - bit9(1) : Zero suppression - ON

33.4 F427 CWT (File Data Write Instruction)

Example 2)

- Five items of unsigned 32-bit integer data (10 words) are read from the area starting from device DT4. The read data is written to the file "\abc\data1.csv" in the SD memory card in new file mode.
- A blank line is inserted in the data through zero suppression, and a comma (2Ch) is inserted at the end.

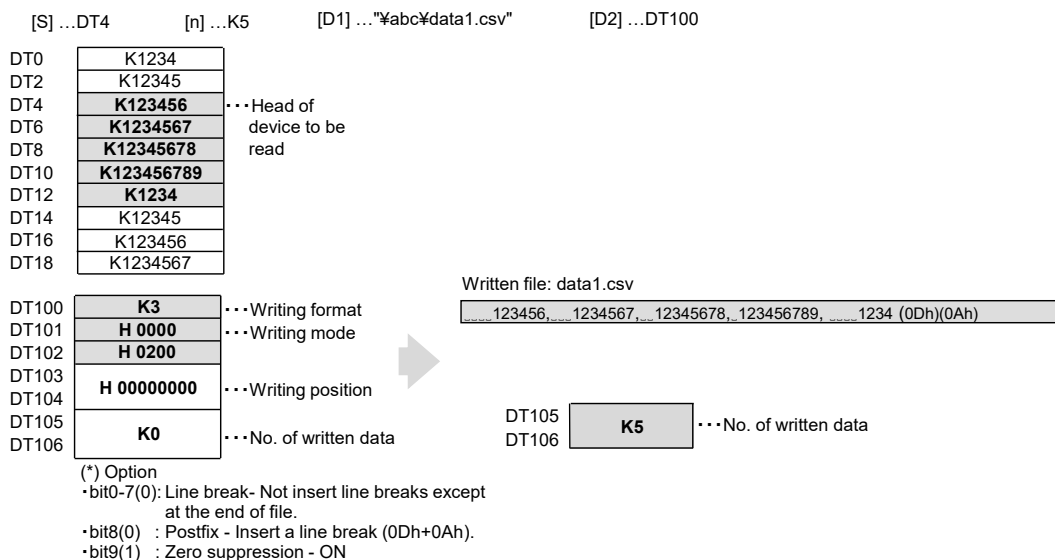

Example 3)

- Five items of unsigned 16-bit integer data (five words) are read from the area starting from device DT2. The read data is written to the file "\abc\data1.csv" in the SD memory card in new file mode.
- A line break (0Dh+0Ah) is inserted at the third data separation and at the end of the file.

33.4 F427 CWT (File Data Write Instruction)

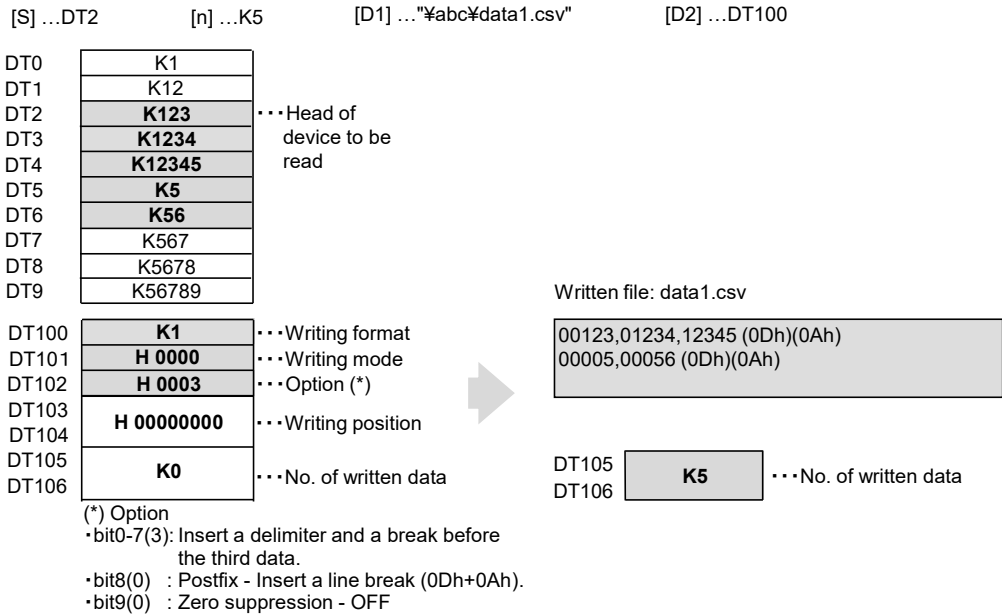

Example 4)

- Five items of ASCII data (five characters) are read in order from the low byte from the area starting from device DT2. The read data is written to the file "\abc\data1.csv" in the SD memory card in new file mode.
- A comma (2Ch) is inserted at the end of the file.

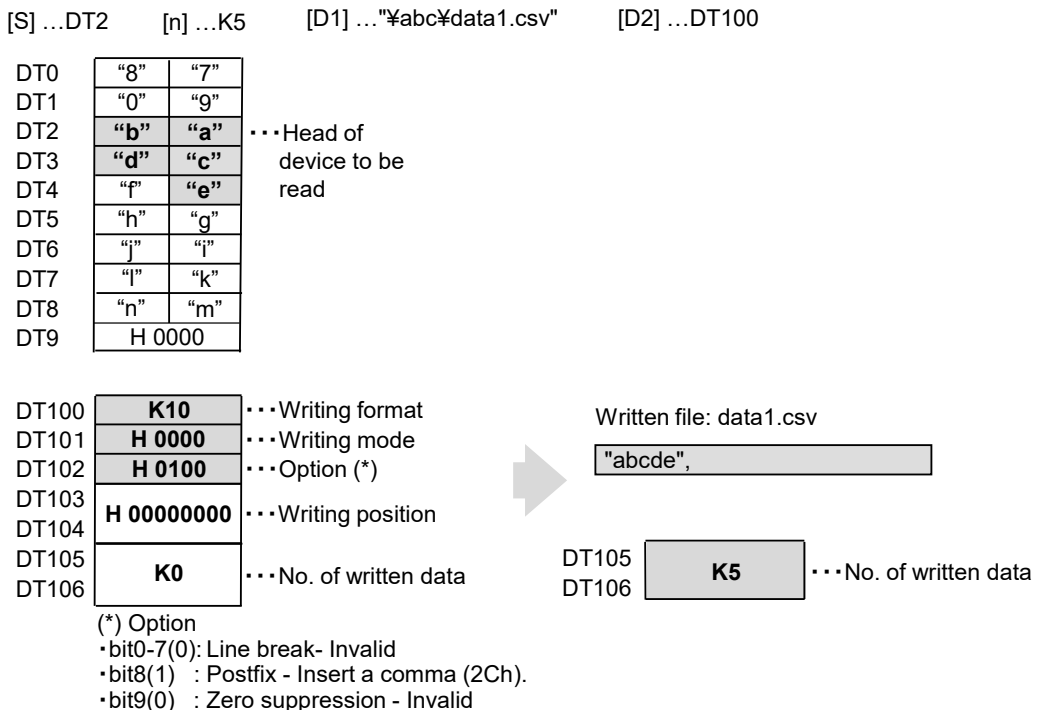

33.4 F427 CWT (File Data Write Instruction)

Example 5)

- Six items of ASCII data (six characters) are read from the area starting from device DT2. The read data is written from the file pointer position of the existing file "\abc\data1.csv" in the SD memory card.
- A comma (2Ch) is inserted at the end of the file.

[S] ...DT2 [n] ...K6 [D1] ..."¥abc¥data1.csv" [D2] ...DT100

DT0	"8"	"7"	
DT1	"0"	"9"	
DT2	"b"	"a"	...Head of device to be read
DT3	"d"	"c"	
DT4	"f"	"e"	
DT5	"h"	"g"	
DT6	"j"	"i"	
DT7	"l"	"k"	
DT8	"n"	"m"	
DT9	H 0000		

Byte address High Low

DT100	K10	...Writing format	
DT101	H 0002	...Writing mode	
DT102	H 0100	...Option (*)	(*) Option
DT103	H 00000007	...Writing position	•bit0-7(0): Line break- Invalid
DT104			•bit8(1) : Postfix - Insert a comma (2Ch).
DT105	K0	...No. of written data	•bit9(0) : Zero suppression - Invalid
DT106			

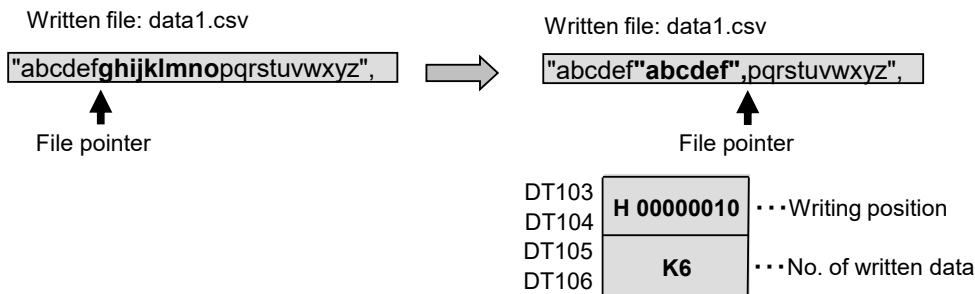

Example 6)

- 10,000 items of signed 16-bit integer data (10,000 words) are read from the area starting from device DT10000. The read data is written to "\FP0H\DT.CSV" in the SD memory card in new file mode.
- A blank line is inserted in the data through zero suppression, and a line break (0Dh+0Ah) is inserted at the 10th data separation and at the end of the file.

33.4 F427 CWT (File Data Write Instruction)

[S] ...DT10000 [n] ...K10000 [D1] ..."¥FP0H¥DT.CSV" [D2] ...DT50

DT10000	K10000	...	Head of
DT10001	K10001		device to be
DT10002	K10002		read
.			
.			
.			
DT19997	K19997		
DT19998	K19998		
DT19999	K19999		
DT20000	K0		

DT50	K2	...	Writing format
DT51	H 0000	...	Writing mode
DT52	H 020A	...	Option (*)
DT53	H 00000000	...	Writing position
DT54			
DT55	K0		
DT56			

(*) Option

- bit0-7(0Ah): Line break- Insert a delimiter and a break before the 10th data.
- bit8(0) : Postfix - Insert a line break (0Dh+0Ah).
- bit9(1) : Zero suppression - ON



Written file: ¥FP0H¥DT.CSV

```
_10000,_10001,_10002,_10003,_10004,_10005,_10006,_10007,_10008,_10009 0Dh0Ah
_10010,_10011,_10012,_10013,_10014,_10015,_10016,_10017,_10018,_10019 0Dh0Ah
      :
      :
_19990,_19991,_19992,_19993,_19994,_19995,_19996,_19997,_19998,_19999 0Dh0Ah
```

"_" is a space (20h).

DT55	K10000	...	No. of written data
DT56			

■ Processing examples (.bin format file)

Example 1)

- Five items of 16-bit data (five words) are read from the area starting from device DT2. The read data is written to the file "\\abc\data1.bin" in the SD memory card in new file mode.

33.4 F427 CWT (File Data Write Instruction)

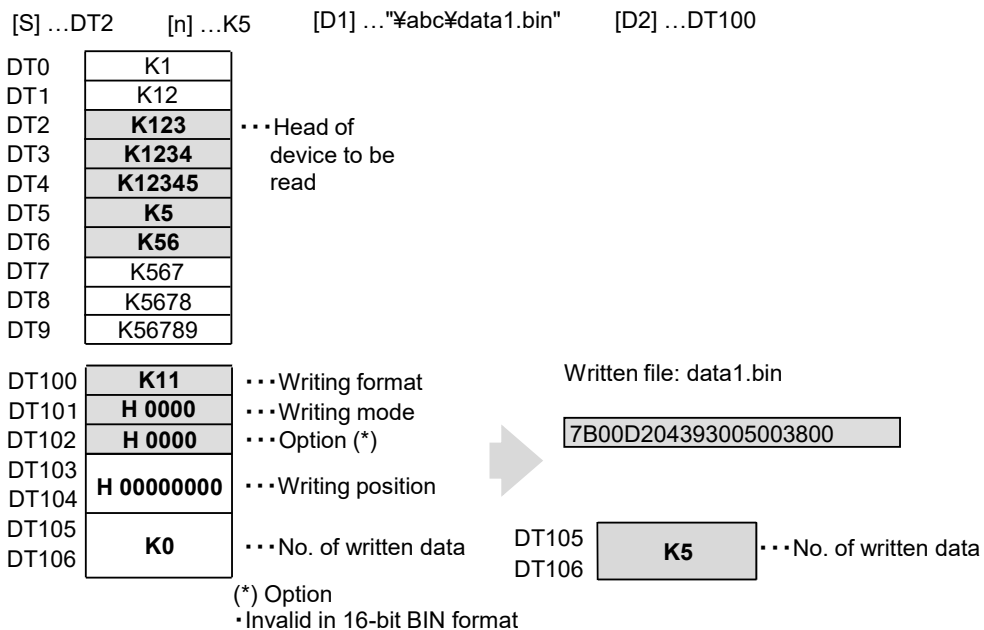

Example 2)

- Five items of 16-bit data (five words) are read from the area starting from device DT2. The read data is written from the file pointer position of the existing file "¥abc¥data1.bin" in the SD memory card.

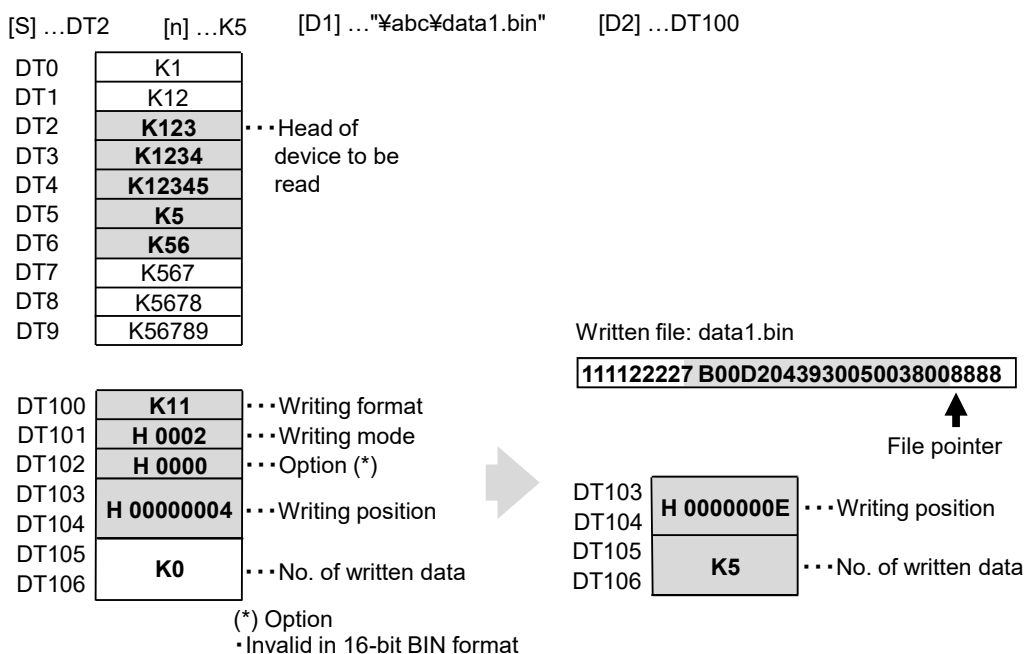

■ Precautions for programming

- Also refer to section "33.1 Common Precautions for SD Memory Card Access Instructions".
- The SD memory card access instruction execution in progress flag (R917A) turns ON from when the execution condition turns ON to when execution of the instruction is complete. During this time other SD memory card access instructions cannot be executed.
- For save format 10 (ASCII character string), the character string to be written from D2 is output enclosed in double quotation marks ("").
- Double quotation marks (") in character strings are converted to two double quotes (" ").
- If the attribute of the file to be written is set to read only, data cannot be written.

■ Flag operations

Name	Description
R917A (SD memory card access instruction execution in progress)	Turns ON when instruction execution starts. Turns OFF when instruction execution is complete.
R917B (SD memory card access instruction execution complete)	Turns OFF when instruction execution starts. Turns ON when instruction execution is complete.
R917C (SD memory card access instruction execution result)	Indicates the execution results when instruction execution is complete. Normal end = 0, abnormal end = 1
R9007 R9008 (ER)	Turns ON if the specified destination is an out-of-range device when the device specification is indirect access (index modification). Turns ON when a value outside the range is specified for a parameter.

33.4 F427 CWT (File Data Write Instruction)

Name	Description
	Turns ON when a value outside the specifiable range is specified in the area reserved for the system.

33.5 F428 CRD (Read File Data)

■ Instruction format



■ Operands

Items	Description
S1	Starting address of the device storing the path name and number of characters in the file from which to read data Specify number of characters in [S1] and the path name in [S1+1] and later (folder name + filename: maximum 256 characters)
S2	Starting address of the device where parameters related to data to be read are stored
n	Number of data items to be read
D	Starting address of the device where the read data is stored

■ Devices that can be specified (indicated by ●)

Operand s	WX	WY	WR	WL	SV	EV	DT	LD	I	SW R	SD T	Constant				Index modifier (Note 1)	Integer Device
												K	H	M	f		
S1	●	●	●	●	●	●	●	●	●					●			
S2	●	●	●	●	●	●	●	●	●						●		
n	●	●	●	●	●	●	●	●	●			●	●		●		
D		●	●	●	●	●	●	●	●						●		

(Note 1) A character constant cannot be specified.

■ Outline of operation

- [n] items of data are read from the file in the SD memory card specified by [S1] in accordance with the parameters specified by [S2]. The read data is stored in the device starting from [D].
- The delimiters used between data items are commas (",") and line break codes (LF or CR +LF).
- If you specify ASCII data and read an odd number of bytes, only the lowest byte of the last word is stored.
- If you specify binary data and read an odd number of bytes, H00 is stored in the highest byte of the last word.

■ [S1], [S1+1]: Specification of folder name and file name

Setting device	Description
S1	Specifies the number of characters in the filename of the read file. (Full path specification)

33.5 F428 CRD (Read File Data)

Setting device	Description
S1+1 to S1+128	Specify the file path of the file to be read. <ul style="list-style-type: none"> Specify the full path, up to 256 characters including the folder name and file name

(Note 1) When using the tool software FPWIN GR7, you can directly enter the path name (folder name and file name) as character constants.

(Note 2) If specifying data register DT or another memory area, use the F253 (SSET) instruction to store the path name (folder name and file name) as character data.

■ [n]: Specification of number of data items to be read

Saving format	Set value of [S2]	Setting range of n
16-bit data	K1, K2, K7, K11	0 to 32767
32-bit data	K3, K4, K5, K8	0 to 32766
64-bit data	K9	0 to 16383
ASCII	K10	0 to 1999

■ [S2] to [S2+6]: Parameters related to the format of the data to be read, etc.

Setting device	Description
S2	Reading format
S2+1	Reading mode
S2+2	Reserved for system
S2+3	Reading position (file pointer)
S2+4	Number of bytes from the beginning or end of the file
S2+5	Number of data items that were read
S2+6	

■ [S2]: Specification of reading format

Set value of S2	Read contents		Fixed number of digits	Extension	
K0	-	-	-	-	
K1	DEC	Unsigned 16-bit integer	5	.CSV (comma-separated text)	
K2		Signed 16-bit integer	6		
K3		Unsigned 32-bit integer	10		
K4		Signed 32-bit integer	11		
K5	Floating point real number	32bit	13		
K7	HEX	One word	4		
K8		Two words	8		
K9		Four words	16		
K10	ASCII	Character string	-		
K11	BIN	16bit	-		.BIN (BIN data)

■ [S2+1]: Specification of reading mode

Set value of S2+1	Description
0: Normal mode	Always reads data from the beginning of the file.
1: Normal mode	Always reads data from the beginning of the file. *The same operation as mode 0.
2: Reading position specification mode 1	Reads data from a position offset by the number of bytes stored in [S2+3] and [S2+4] from the beginning of the file.
3: Reading position specification mode 2	Reads data from a position offset by the number of bytes stored in [S2+3] and [S2+4] from the end of the file.

Example 1: When specifying the reading position from the beginning of file

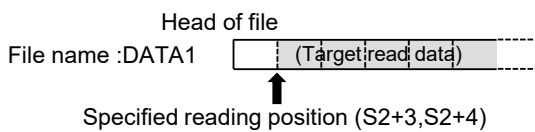

Example 2: When specifying the reading position from the end of file

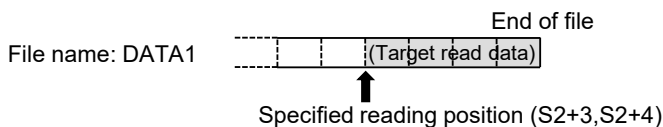

■ [S2+3] and [S2+4]: Specification of reading position (file pointer)

- Available only when the reading position specification mode 1 or mode 2 is set in [S2+1].
- When reading into the file completes, the end position of the read data is stored at the reading position (file pointer). If the reading operation is performed again in this state, the next data will be read.

Reading mode	Description
Reading position specification mode 1	Data is read from the reading position (file pointer) counted from the beginning of the file.
Reading position specification mode 2	Data is read from the reading position (file pointer) counted from the end of the file.
Normal mode	This is invalid. Data is always read from the beginning of the file. In this case, storage to the reading position (file pointer) is not performed after the reading process.

- The reading position (file pointer) is specified in units of bytes.

■ [S2+5], [S2+6] Number of data items that were read

- Stores the number of data items that could be read as a result of reading from the file.

Example 1: When the number of data items to be read is 40 and 100 data items exist in the file, the first 40 data items read from the beginning of the file are stored.

33.5 F428 CRD (Read File Data)

Example 2: When the number of data items to be read is 40 and 30 data items exist in the file, the first 30 data items read from the beginning of the file are stored.

Example 3: When the number of read characters is 40 and 100 characters exist in the file, the first 40 characters read from the beginning of the file are stored.

Example 4: When the number of read characters is 40 and 30 characters exist in the file, the first 30 characters read from the beginning of the file are stored.

■ Processing examples

Example 1)

- Read five data items (five words) of 16-bit BIN data from the file "\abc\data1.bin" in an SD memory card. The read data is stored in the area starting from DT102.
- As the "Reading position specification mode 1" is selected, the file pointer moves after reading.

[S1] ..."\abc\data1.bin" [S2] ...DT50 [n] ...K5 [D] ...DT102

DT50	H 000B	...Reading format
DT51	H 0002	...Reading mode
DT52	H 0000	...Reserved for system
DT53	H 00000000	...Reading position
DT54		
DT55	K0	...No. of read data
DT56		

Data content of file "data1.bin" (16-bit BIN format)

1027112712271327142715271627172718271927



File pointer

DT100	H 0000	➔	DT100	H 0000
DT101	H 0000		DT101	H 0000
DT102	H 0000		DT102	H 2710
DT103	H 0000		DT103	H 2711
DT104	H 0000		DT104	H 2712
DT105	H 0000		DT105	H 2713
DT106	H 0000		DT106	H 2714
DT107	H 0000		DT107	H 0000
DT108	H 0000		DT108	H 0000
DT109	H 0000		DT109	H 0000

Data content of file "data1.bin" (16-bit BIN format)

1027112712271327142715271627172718271927



File pointer

Example 2)

- Read five data items from the file "\abc\data1.csv" in an SD memory card. The read data is stored in an area starting from DT102 (5 words) as 16-bit unsigned integer data.

- As the "Reading position specification mode 1" is selected, the file pointer moves after reading.

[S1] ..."%abc\data1.csv" [S2] ...DT50 [n] ...K5 [D] ...DT102

DT50	K1	...Reading format
DT51	H 0002	...Reading mode
DT52	H 0000	...Reserved for system
DT53	H 00000000	...Reading position
DT54		
DT55	K0	...No. of read data
DT56		

Data content of file "data1.csv" (16-bit DEC format)

12,123,1234,12345,5,56,567,5678,56789,1,



File pointer

DT100	K0
DT101	K0
DT102	K0
DT103	K0
DT104	K0
DT105	K0
DT106	K0
DT107	K0
DT108	K0
DT109	K0



DT100	K0
DT101	K0
DT102	K12
DT103	K1234
DT104	K12345
DT105	K5
DT106	K0
DT107	K0
DT108	K0
DT109	K0

Data content of file "data1.csv" (16-bit DEC format)

12,123,1234,12345,5,56,567,5678,56789,1,



File pointer

Example 3)

- Read five data items from the file "\abc\data1.csv" in an SD memory card. The read data is stored in the area starting from DT102 (10 words) as 32-bit unsigned integer data.
- As the "Reading position specification mode 1" is selected, the file pointer moves after reading.

33.5 F428 CRD (Read File Data)

[S1] ..."¥abc¥data1.csv" [S2] ...DT50 [n] ...K5 [D] ...DT102

DT50	K3	...Reading format
DT51	H 0002	...Reading mode
DT52	H 0000	...Reserved for system
DT53	H 00000000	...Reading position
DT54		
DT55	K0	...No. of read data
DT56		

Data content of file "data1.csv" (32-bit DEC format)

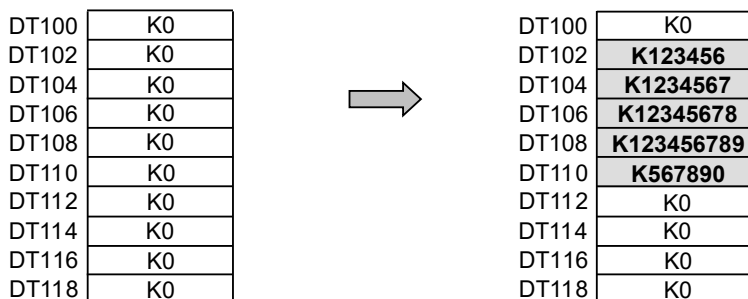
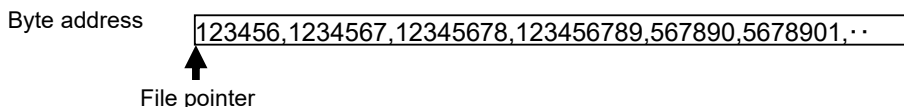

Data content of file "data1.csv" (32-bit DEC format)

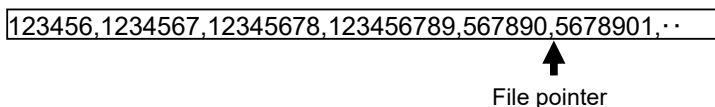

Example 4)

- Read ten data items (ten characters) of ASCII data from the file "\abc\data1.csv" in an SD memory card.
- If there are consecutive double quotes (""), they are read as a single quote character (").
- The character data is stored in the area starting with DT102.
- As the "Reading position specification mode 1" is selected, the file pointer moves after reading.

[S1] ... "¥abc¥data1.csv" [S2] ...DT50 [n] ...K10 [D] ...DT102

DT50	K10	...Reading format
DT51	H 0002	...Reading mode
DT52	H 0000	...Reserved for system
DT53	H 00000000	...Reading position
DT54		
DT55	K0	...No. of read data
DT56		

Data content of file "data1.csv" (ASCII string format)

"ABC"DE"FGHIJ", "KLMNOP",



File pointer

DT100	H 0000	
DT101	H 0000	
DT102	H 00	H 00
DT103	H 00	H 00
DT104	H 00	H 00
DT105	H 00	H 00
DT106	H 00	H 00
DT107	H 0000	
DT108	H 0000	



DT100	H 0000	
DT101	H 0000	
DT102	"B"	"A"
DT103	"D"	"C"
DT104	"F"	"E"
DT105	"H"	"G"
DT106	"J"	"I"
DT107	H 0000	
DT108	H 0000	

Data content of file "data1.csv" (ASCII string format)

"ABC"DE"FGHIJ", "KLMNOP",



File pointer

Example 5)

- Read 10000 data items from the file "\FP0H\DT.CSV" in an SD memory card. The read data is stored in the area starting from DT10000 (10000 words) as 16-bit signed integer data.
- As the "Normal mode 0" is selected, data is always read from the beginning of the file.

33.5 F428 CRD (Read File Data)

[S1] ..."¥FP0H¥DT.CSV" [S2] ...DT50 [n] ...K10000 [D] ...DT10000

DT50	K2	...Reading format
DT51	H 0000	...Reading mode
DT52	H 0000	...Reserved for system
DT53	H 00000000	...Reading position
DT54		
DT55	K0	...No. of read data
DT56		

Data content of file "DT.CSV" (Signed 16-bit DEC format)

_10000,_10001,_10002,_10003,·····,_19990Dh0Ah

↑
File pointer

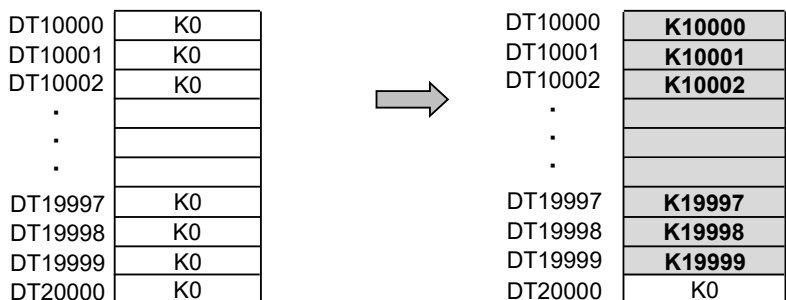

Data content of file "DT.CSV" (Signed 16-bit DEC format)

_10000,_10001,_10002,_10003,·····,_19990Dh0Ah

↑
File pointer

■ Precautions for programming

- Also refer to section "[33.1 Common Precautions for SD Memory Card Access Instructions](#)".
- The SD memory card access instruction execution in progress flag (R917A) turns ON from when the execution condition turns ON to when execution of the instruction is complete. During this time other SD memory card access instructions cannot be executed.
- Consecutive double quotes (") in character strings are read as a single quote character ("). Double quotes alone are ignored.
- If a space, comma or line break is inserted at the position of the file pointer after reading a CSV file, the file pointer output to the result data is at the next data position after the comma or line break. A space, comma or line break at the end of data is skipped.
- When reading a CSV file, empty fields (such as parts with successive commas) are skipped, and the data is not stored in the device. The next data to be read (not the empty field that was skipped) is stored in the next device. In this case, the skipped data is counted as part of the data count.
- During the execution of the F428 CRD instruction, the data values read from the SD memory card are written in order from the beginning of the specified device. Do not read data from the device specified in the F428 CRD instruction until the F428 CRD instruction is complete.

- When reading ASCII data, correct processing may not be possible if there are delimiters (commas and/or line break codes) in the data.
- Specify the points at which each data is separated for [S2+3] and [S2+4] reading positions (file pointers). "A" in the figure below shows the positions where data can be read properly.

Example 1: 16-bit integer data (bin. format file)

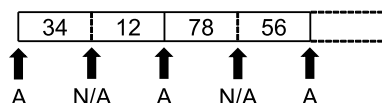

Example 2: ASCII data (csv. format file)

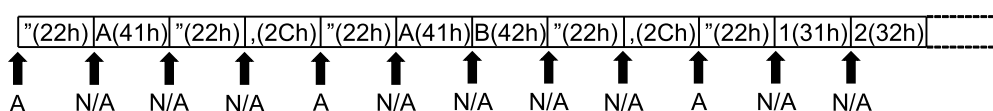

A: Position where data can be properly read

N/A: Position where data cannot be properly read

■ Flag operations

Name	Description
R917A (SD memory card access instruction execution in progress)	Turns ON when instruction execution starts. Turns OFF when instruction execution is complete.
R917B (SD memory card access instruction execution complete)	Turns OFF when instruction execution starts. Turns ON when instruction execution is complete.
R917C (SD memory card access instruction execution results)	Indicates the execution results when instruction execution is complete. Normal end = 0, abnormal end = 1
R9007	Turns ON if the specified destination is an out-of-range device when the device specification is indirect access (index modification).
R9008	Turns ON when a value outside the range is specified for a parameter.
(ER)	Turns ON when a value outside the specifiable range is specified in the area reserved for the system.

33.6 F429 CMKDIR (create directory)

33.6 F429 CMKDIR (create directory)

■ Instruction format

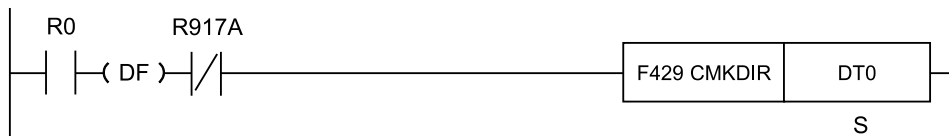

■ Operands

Items	Settings
S	Starting address of device storing the path name and number of characters of the folder to be created Specify number of characters in [S] and path name in [S+1] onwards (folder name: maximum 256 characters)

■ Devices that can be specified (indicated by ●)

Operand s	WX	WY	WR	WL	SV	EV	DT	LD	I	SW R	SD T	Constant				Index modifier (Note 1)	Integer Device
												K	H	M	f		
S	●	●	●	●	●	●	●	●	●						●		

(Note 1) A character constant cannot be specified.

■ Outline of operation

- Creates a folder within an SD memory card.
- Specify by storing the number of characters in the folder name in [S], and the characters indicating the folder name as ASCII data in [S+1] onwards.

■ [S], [S+1]: Specification of folder name

Setting device	Description
S	Sets the number of characters in the folder name to be created. (Full path specification)
S+1 to S+128	Configures the created folder name. <ul style="list-style-type: none"> ● The folder name up to 256 characters when the full path is specified

(Note 1) Path names (folder names) can be directly input with character constants using the tool software FWIN GR7.

(Note 2) When specifying memory areas such as data register DT, use F253 SSET instruction to store path names (folder names) as character data.

■ Processing examples

Example 1) When creating folder "abc" within the SD memory card

DT0	K4		... No. of characters of folder name
DT1	"a"	"¥"	... Folder name
DT2	"c"	"b"	
DT3	H 0000		
DT4	H 0000		
DT5	H 0000		
Byte address	High	Low	

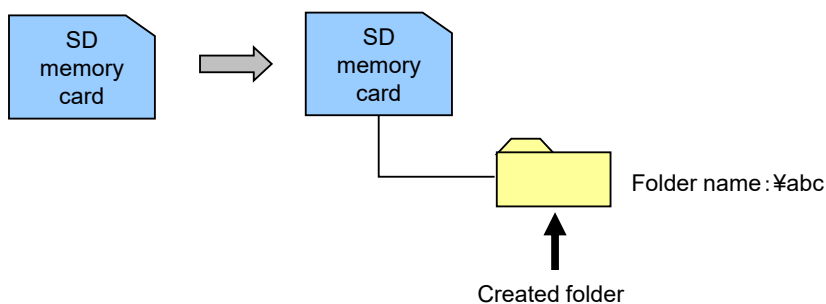

Example 2) When creating folder "abc\def" within the SD memory card

DT0	K8		...No. of characters of folder name
DT1	"a"	"¥"	...Folder name
DT2	"c"	"b"	
DT3	"d"	"¥"	
DT4	"f"	"e"	
DT5	H 0000		
Byte address	High	Low	

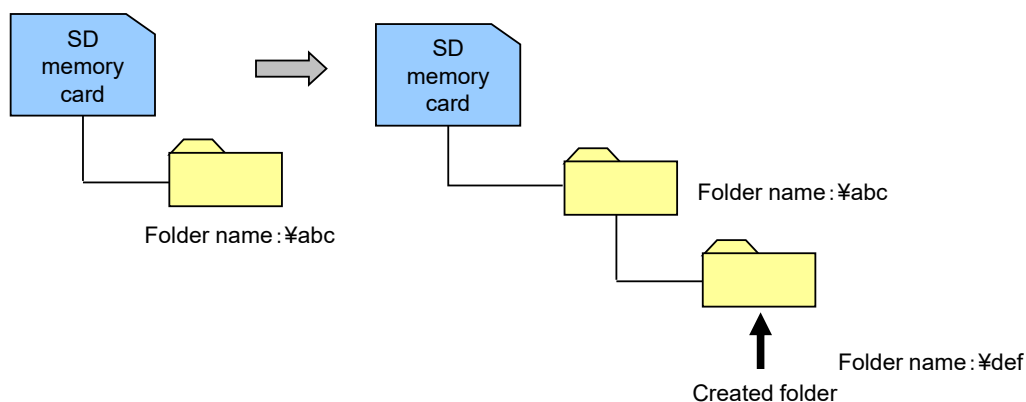

■ Precautions for programming

- Also refer to section "33.1 Common Precautions for SD Memory Card Access Instructions".

33.6 F429 CMKDIR (create directory)

- The SD memory card access instruction execution in progress flag (R917A) turns ON from when the execution condition turns ON to when execution of the instruction is complete. During this time other SD memory card access instructions cannot be executed.
- As with folder "\abc\def", when creating a folder in a lower level, create a folder in a higher level in advance. Folders cannot be created at the same time.
- If a non-existent folder is specified to a higher level, an error will result.
- If the folder to be created already exists, no operation is performed and it ends normally.

■ Flag operations

Name	Description
R917A (SD memory card access instruction execution in progress)	Turns ON when instruction execution starts. Turns OFF when instruction execution is complete.
R917B (SD memory card access instruction execution complete)	Turns OFF when instruction execution starts. Turns ON when instruction execution is complete.
R917C (SD memory card access instruction execution results)	Indicates the execution results when instruction execution is complete. Normal end = 0, abnormal end = 1
R9007 R9008 (ER)	Turns ON if the specified destination is an out-of-range device when the device specification is indirect access (index modification).

33.7 F430 CRMDIR/F431 CRMDIRFL (Directory Deletion)

■ Instruction format

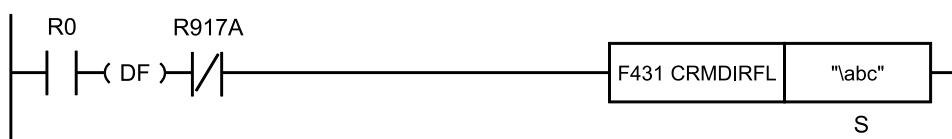
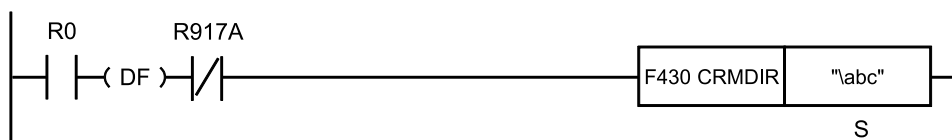

■ Operands

Items	Settings
S	Starting address of the device storing the path name and number of characters of the folder to be deleted Specify the number of characters in [S] and the path name in [S+1] and later (folder name: maximum 256 characters)

■ Devices that can be specified (indicated by ●)

Operand s	WX	WY	WR	WL	SV	EV	DT	LD	I	SW R	SD T	Constant				Index modifier (Note 1)	Integer Device
												K	H	M	f		
S	●	●	●	●	●	●	●	●	●					●			

(Note 1) A character constant cannot be specified.

■ Outline of operation

- The directory in the SD memory card specified by [S] is deleted.
- Specify by storing the number of characters in the folder name in [S], and the characters indicating the folder name as ASCII data in [S+1] onwards.
- Differences between the F430 CRMDIR instruction and the F431 CRMDIRFL instruction

Instruction	Differences
F430 CRMDIR instruction	Not possible to delete a directory that has files inside.
F431 CRMDIRFL instruction	Directory can be deleted even if it has files inside. However, it is not possible to delete a directory that has a subdirectory inside.

■ [S], [S+1]: Specification of folder name

Setting device	Description
S	Specifies the number of characters in the name of the folder to be deleted. (Full path specification)

33.7 F430 CRMDIR/F431 CRMDIRFL (Directory Deletion)

Setting device	Description
S+1 to S+128	Specifies the name of the folder to be deleted. (Full path specification of folder name up to 256 characters)

(Note 1) Path names (folder names) can be directly input with character constants using the tool software FPCWIN GR7.

(Note 2) When specifying memory areas such as data register DT, use F253 SSET instruction to store path names (folder names) as character data.

■ Processing examples

Example 1: When deleting folder "\abc" from the SD memory card

DT0	K4		...No. of characters of folder name
DT1	"a"	"¥"	...Folder name
DT2	"c"	"b"	
DT3	H 0000		
DT4	H 0000		
DT5	H 0000		

Byte address High Low

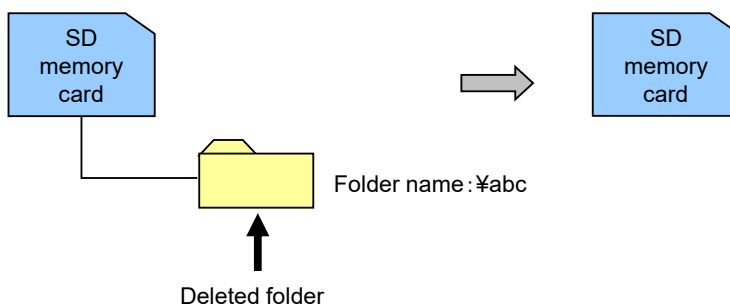

Example 2: When deleting folder "abc\def" from the SD memory card

DT0	K8		...No. of characters of folder name
DT1	"a"	"¥"	... Folder name
DT2	"c"	"b"	
DT3	"d"	"¥"	
DT4	"f"	"e"	
DT5	H 0000		
Byte address	High	Low	

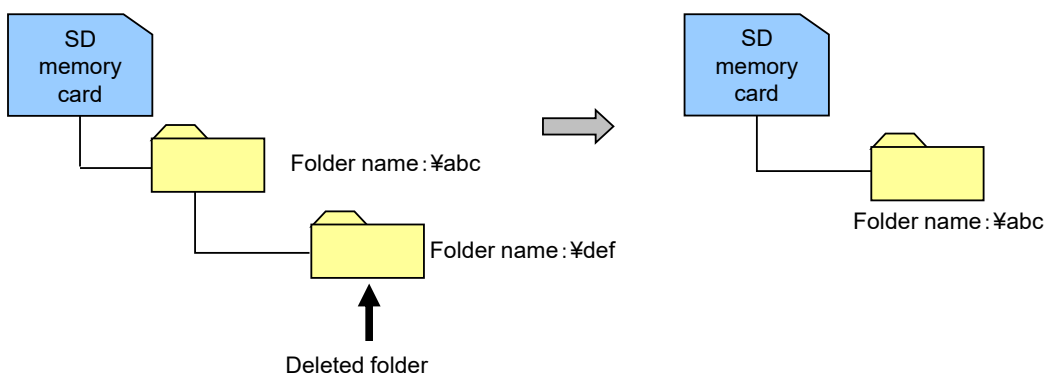
**■ Precautions for programming**

- Also refer to section "33.1 Common Precautions for SD Memory Card Access Instructions".
- The SD memory card access instruction execution in progress flag (R917A) turns ON from when the execution condition turns ON to when execution of the instruction is complete. During this time other SD memory card access instructions cannot be executed.
- When the folder to be deleted does not exist an error occurs.

[F430 CRMDIR instruction]

- If there is a file or folder inside the specified folder an error occurs. Check inside the folder.

[F431 CRMDIRFL instruction]

- Even if there is a file inside the specified folder the folder is deleted. If there is a folder inside the folder an error occurs.
- If the file inside the folder is open for writing, an error occurs.
- If the file inside the folder is open for reading, the folder is deleted. The read-open processing causes an error.

■ Flag operations

Name	Description
R917A (SD memory card access instruction execution in progress)	Turns ON when instruction execution starts. Turns OFF when instruction execution is complete.
R917B (SD memory card access instruction execution complete)	Turns OFF when instruction execution starts. Turns ON when instruction execution is complete.
R917C (SD memory card access instruction execution results)	Indicates the execution results when instruction execution is complete. Normal end = 0, abnormal end = 1

33.7 F430 CRMDIR/F431 CRMDIRFL (Directory Deletion)

Name	Description
R9007 R9008 (ER)	Turns ON if the specified destination is an out-of-range device when the device specification is indirect access (index modification).

33.8 F432 CFDEL (delete file)

■ Instruction format

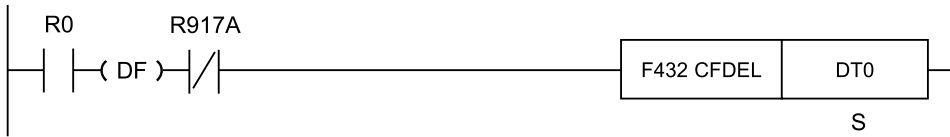

■ Operands

Items	Settings
S	Starting address of the device storing the path name and number of characters of the file to be deleted Specify number of characters in [S] and path name in [S+1] onwards (folder name + file name: maximum 256 characters)

■ Devices that can be specified (indicated by ●)

Operand s	WX	WY	WR	WL	SV	EV	DT	LD	I	SW R	SD T	Constant				Index modifier (Note 1)	Integer Device
												K	H	M	f		
S	●	●	●	●	●	●	●	●	●					●			

(Note 1) A character constant cannot be specified.

■ Outline of operation

- Files in the SD memory card specified by [S] are deleted.

■ [S], [S+1]: Specification of folder name and file name

Setting device	Description
S	Sets the number of characters in the deleted path name (folder name + file name). (Full path specification)
S+1 to S+128	Specifies the path name to be deleted (folder name + file name). <ul style="list-style-type: none"> The folder name up to 256 characters when the full path is specified

(Note 1) Path names (folder names + file names) can be directly input with character constants using the tool software FPWIN GR7.

(Note 2) When specifying memory areas such as data register DT, use F253 SSET instruction to store path names (folder names + file names) as character data.

33.8 F432 CFDEL (delete file)

■ Processing examples

e.g. Deleting the file "\abc\data1.csv" within the SD memory card

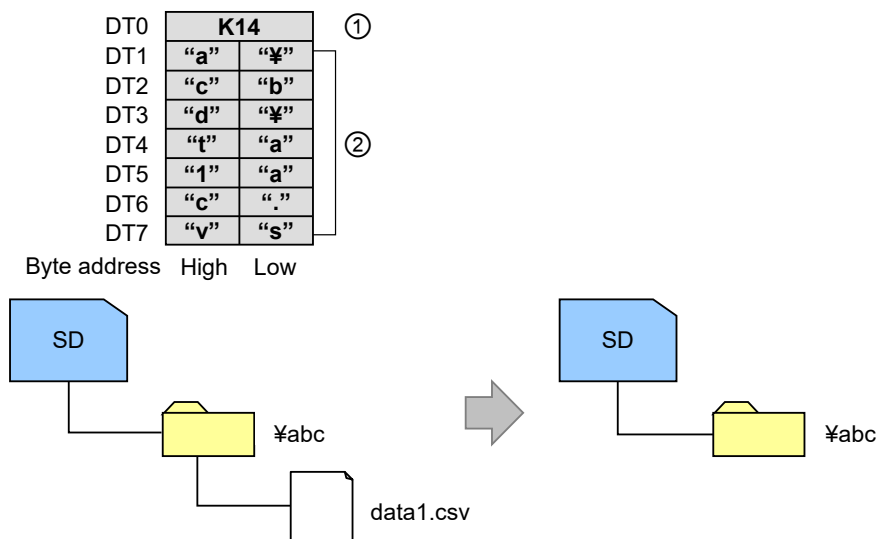

■ Precautions for programming

- Also refer to section "[33.1 Common Precautions for SD Memory Card Access Instructions](#)".
- The SD memory card access instruction execution in progress flag (R917A) turns ON from when the execution condition turns ON to when execution of the instruction is complete. During this time other SD memory card access instructions cannot be executed.
- If the file to be deleted does not exist, an error will result.

■ Flag operations

Name	Description
R917A (SD memory card access instruction execution in progress)	Turns ON when instruction execution starts. Turns OFF when instruction execution is complete.
R917B (SD memory card access instruction execution complete)	Turns OFF when instruction execution starts. Turns ON when instruction execution is complete.
R917C (SD memory card access instruction execution results)	Indicates the execution results when instruction execution is complete. Normal end = 0, abnormal end = 1
R9007 R9008 (ER)	Turns ON if the specified destination is an out-of-range device when the device specification is indirect access (index modification).

33.9 F433 CPR (ASCII Data Write into File)

■ Instruction format

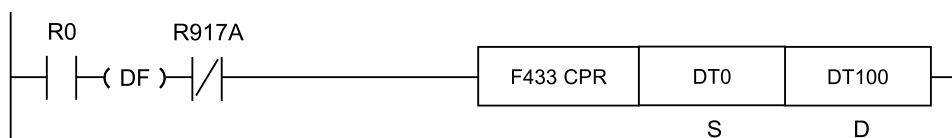

■ Operands

Items	Description
S	Starting address of the device that stores the string data to be written, or the string Specify the number of characters in [S] and the string data (maximum 4096 characters) in [S+1] and following addresses
D	Starting address of the device that stores the path name of the file to be written to and the number of characters Specify the number of characters in [D] and the path name (folder name + file name: maximum 256 characters) in [D+1] and following addresses

■ Devices that can be specified (indicated by ●)

Operand s	WX	WY	WR	WL	SV	EV	DT	LD	I	SW R	SD T	Constant				Index modifier (Note 1)	Integer Device
												K	H	M	f		
S	●	●	●	●	●	●	●	●	●					●			
D	●	●	●	●	●	●	●	●	●					●			

(Note 1) A character constant cannot be specified.

■ Outline of operation

- Adds the character string specified by [S] to the end of the file named with the character string specified by [D].
- When the file specified by [D] does not exist, create a new file.

■ [S] to [S+1]: Specification of character string data

- Parameters related to the character string data written into a file name in a SD memory card

Setting device	Description
S	Number of characters written (maximum 4096)
S+1 or more	Write character string data

■ [D] to [D+1]: Specification of folder name and file name

- Starting device storing the file name to be written into a SD memory card (folder name + file name: 1 to 256 characters) and the number of characters

33.9 F433 CPR (ASCII Data Write into File)

Setting device	Description
D	Specify the number of characters of the file name to be written. (Full path specification)
D+1 to D+128	Specify the file to be written. <ul style="list-style-type: none"> The full path configuration is up to a maximum of 256 characters including the folder name + filename

■ Processing examples

When character string "2013/04/05,12:00:00,abcde01238" is written to file "\abc\data1"

[D] ...DT0 [S] ...DT100

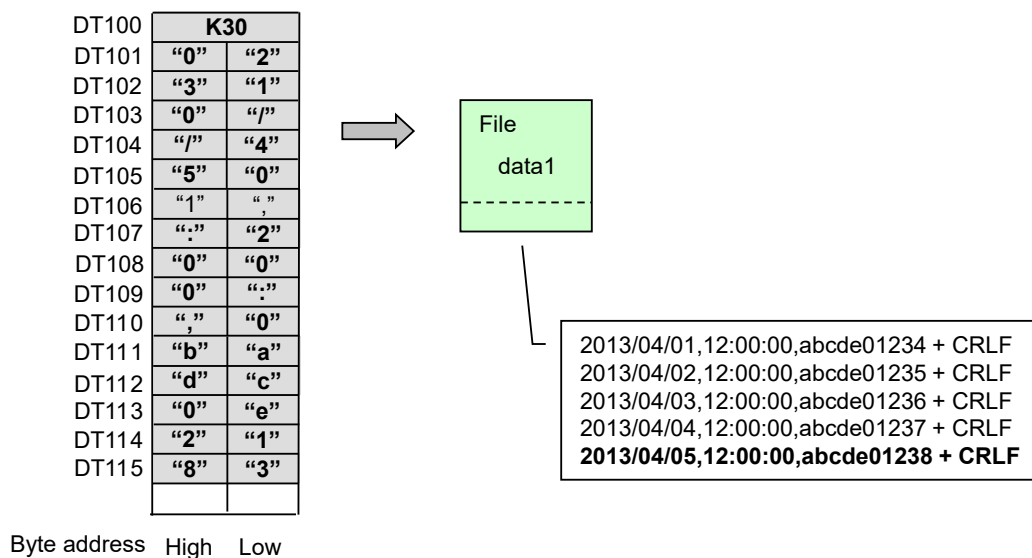
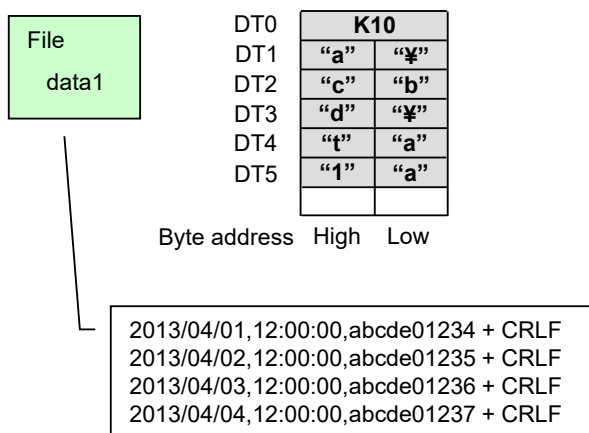

■ Precautions for programming

- Also refer to section "33.1 Common Precautions for SD Memory Card Access Instructions".
- The SD memory card access instruction execution in progress flag (R917A) turns ON from when the execution condition turns ON to when execution of the instruction is complete. During this time other SD memory card access instructions cannot be executed.

■ Flag operations

Name	Description
R917A (SD memory card access instruction execution in progress)	Turns ON when instruction execution starts. Turns OFF when instruction execution is complete.
R917B (SD memory card access instruction execution complete)	Turns OFF when instruction execution starts. Turns ON when instruction execution is complete.
R917C (SD memory card access instruction execution results)	Indicates the execution results when instruction execution is complete. Normal end = 0, abnormal end = 1
R9007 R9008 (ER)	Turns ON if the specified destination is an out-of-range device when the device specification is indirect access (index modification).
	Turns ON when the character string specified by [S] exceeds 4096 characters.

33.10 F434 CRD1 (Read one line from file)

33.10 F434 CRD1 (Read one line from file)

■ Instruction format

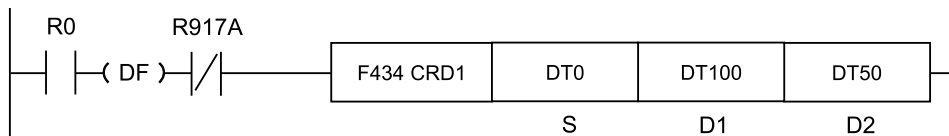

■ Operands

Items	Settings
S	Starting address of the device storing the path name and number of characters in the file from which to read data Specify number of characters in [S] and the path name in [S+1] and later (folder name + filename: maximum 256 characters)
D1	Starting address of the device storing the character string data that was read
D2	Starting address of the device storing the parameter data relating to the position and upper limit of the read data

■ Devices that can be specified (indicated by ●)

Operands	WX	WY	WR	WL	SV	EV	DT	LD	I	SWR	SDT	Constant				Index modifier (Note 1)	Integer Device
												K	H	M	f		
S	●	●	●	●	●	●	●	●	●						●		
D1	●	●	●	●	●	●	●	●	●						●		
D2	●	●	●	●	●	●	●	●	●						●		

(Note 1) A character constant cannot be specified.

■ Outline of operation

- The file specified by [S] is read from the position specified by [D2], and the data is stored at the device address starting with [D1]. Read is executed up to the specified upper limit of the number of bytes to be read, or until LF or CR+LF are detected.

■ [S] to [S+1]: Specification of folder name and filename

- Starting device storing the folder name (folder name + filename: from 1 to 256 characters) and number of characters stored in the SD memory card

Setting device	Description
S	Specifies the number of characters in the filename of the read file. (Full path specification)
S+1 to S+128	Specifies the file to be read. <ul style="list-style-type: none"> ● The full path configuration is up to a maximum of 256 characters including the folder name + filename

■ [D2] to [D2+3]: Specification of read position and upper limit

Setting device	Settings	Details
D2	Read position (File pointer)	Specifies the byte position from the start of the file. Line break characters [CR(0DH) or LF(0AH)] are each counted as one character. After the instruction is executed, [D2, D2+1] is updated with a read pointer value that has had the number of bytes that were read added to it. If read processing is performed again in that state, the next data will be read. The read position can be specified in 8-bit units (1-byte units).
D2+1		
D2+2	Maximum number of bytes to be read (Setting range: 1 to 4,096)	Sets the maximum number of bytes in the read data. The setting range becomes 1 to 4,096. If this value is set to 0, the operation is performed as if the value was set to 4,096. If line break characters [LF(0AH) or CR+LF] exist before the set maximum number of bytes is reached, the read operation terminates at that time.
D2+3	Reserved for system	Set to 0.

33.10 F434 CRD1 (Read one line from file)

■ Processing examples

Example 1: When file "data1.txt" is read with file start set as the read position

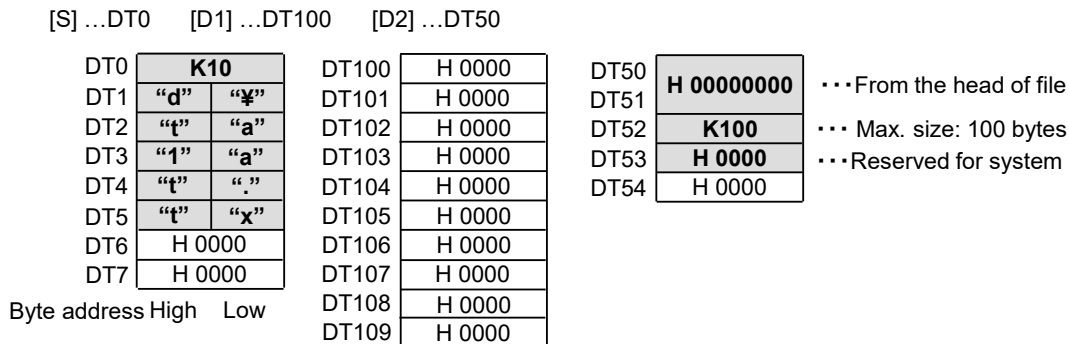

Contents of file "data1.txt"

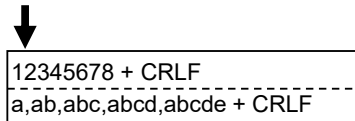

↓ : Position of file pointer

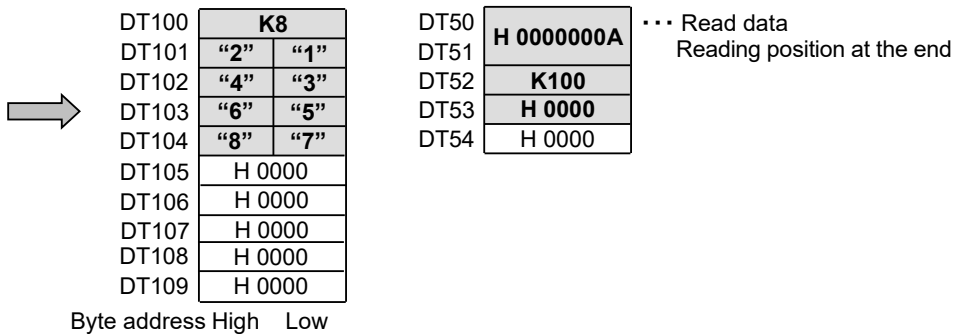

Contents of file "data1.txt"

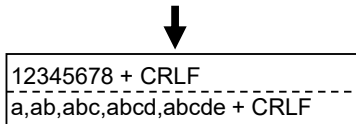

Example 2: When file "data1.txt" is read with the 4th byte from the file start set as the read position

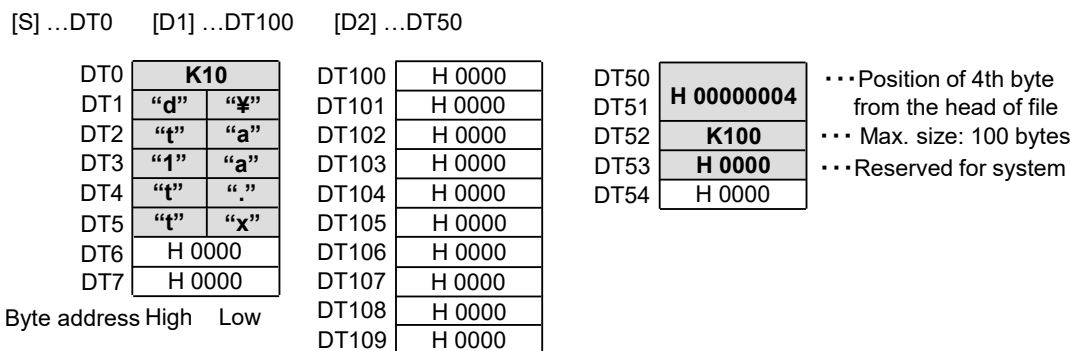

Contents of file "data1.txt"

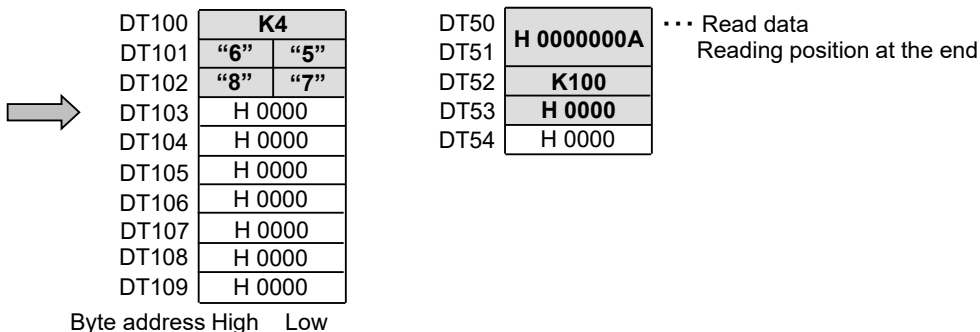
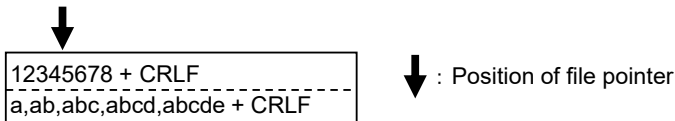

Contents of file "data1.txt"

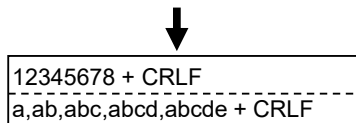

33.10 F434 CRD1 (Read one line from file)

Example 3: When file "abc\data1.txt" is read with the 10th byte from the file start set as the read position

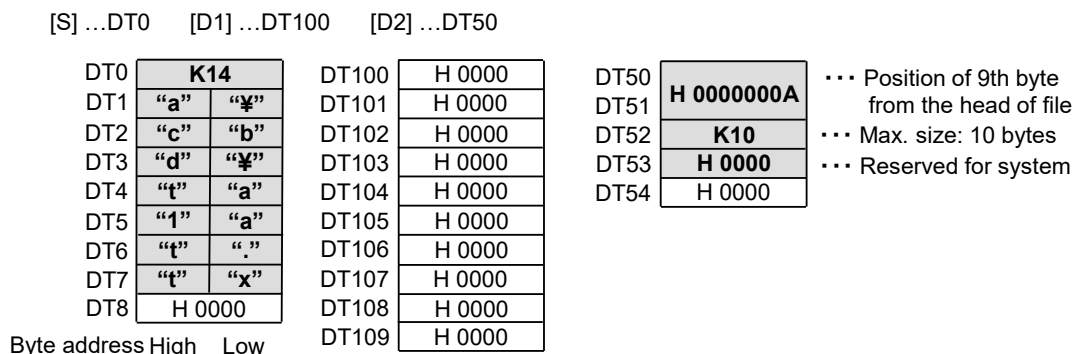

Contents of file "data1.txt"

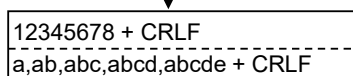

↓ : Position of file pointer

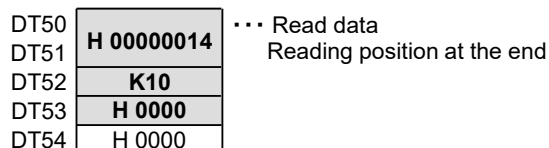
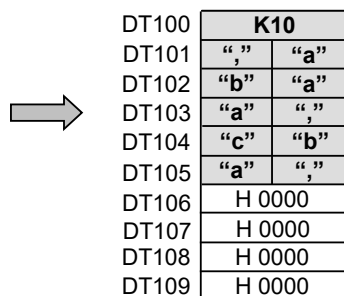

Contents of file "data1.txt"

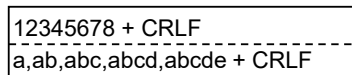

■ Precautions for programming

- Also refer to section "33.1 Common Precautions for SD Memory Card Access Instructions".
- The SD memory card access instruction execution in progress flag (R917A) turns ON from when the execution condition turns ON to when execution of the instruction is complete. During this time other SD memory card access instructions cannot be executed.
- During execution of the F434 CRD1 instruction, the data read from the SD memory card is written in order from the start of the specified data device. Therefore, until this instruction is complete, do not read data within the range of the data device specified to store the data.

■ Flag operations

Name	Description
R917A (SD memory card access instruction execution in progress)	Turns ON when instruction execution starts. Turns OFF when instruction execution is complete.
R917B (SD memory card access instruction execution complete)	Turns OFF when instruction execution starts. Turns ON when instruction execution is complete.
R917C (SD memory card access instruction execution results)	Indicates the execution results when instruction execution is complete. Normal end = 0, abnormal end = 1
R9007 R9008 (ER)	Turns ON if the specified destination is an out-of-range device when the device specification is indirect access (index modification).
	Turns ON if the value of [D2+2] exceeds 4,096 characters.
	Turns ON if [D1] + [D2+2] is an out-of-range device.

33.11 F435 CREN (Rename File)

■ **Instruction format**

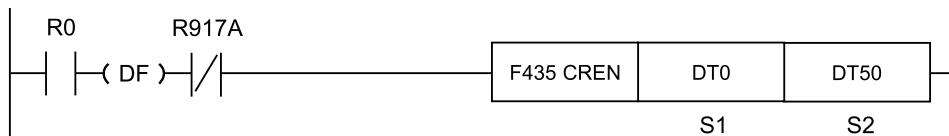

■ **Operands**

Items	Settings
S1	Starting address of the device storing the path name and number of characters of the file to be renamed Specify number of characters in [S1] and the path name in [S1+1] and later (folder name + filename: maximum 256 characters)
S2	Starting address of the device storing the path name and number of characters of the renamed file Specify number of characters in [S2] and the path name in [S2+1] and later (folder name + filename: maximum 256 characters) The folder name can be omitted

■ **Devices that can be specified (indicated by ●)**

Operands	WX	WY	WR	WL	SV	EV	DT	LD	I	SWR	SDT	Constant				Index modifier (Note 1)	Integer Device
												K	H	M	f		
S1	●	●	●	●	●	●	●	●	●					●			
S2	●	●	●	●	●	●	●	●	●					●			

(Note 1) A character constant cannot be specified.

■ **Outline of operation**

- The file name specified by [S1] is changed to the file name specified by [S2].

■ **Processing examples**

e.g. When renaming the file "\abc\data1.csv" to "\abc\data2.csv"

(1)	by conversion method	(2)	Path name (folder name and filename)
-----	----------------------	-----	--------------------------------------

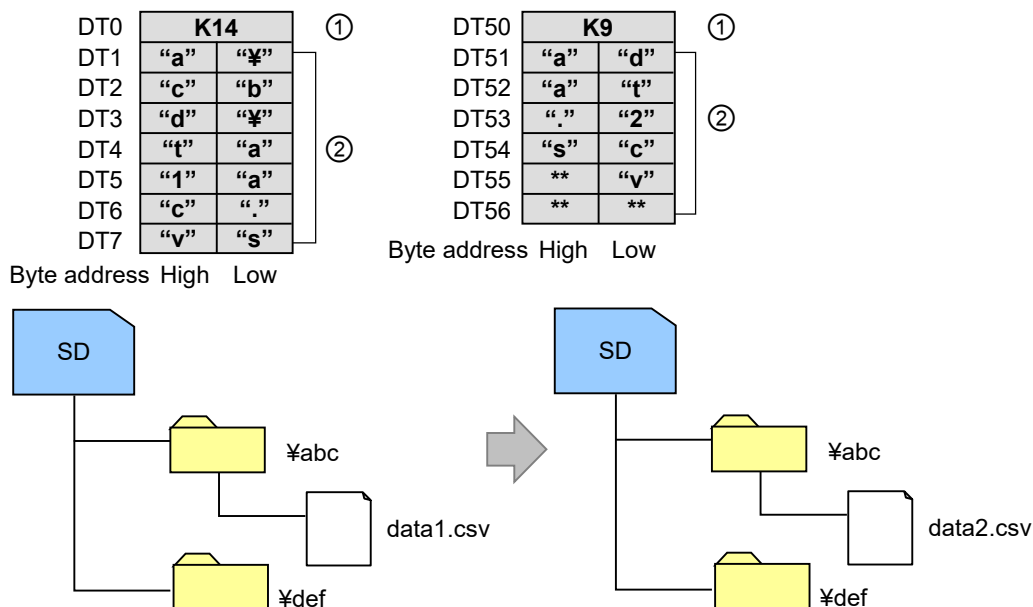

■ Precautions for programming

- Also refer to section "33.1 Common Precautions for SD Memory Card Access Instructions".
- The SD memory card access instruction execution in progress flag (R917A) turns ON from when the execution condition turns ON to when execution of the instruction is complete. During this time other SD memory card access instructions cannot be executed.
- The F435 CREN instruction cannot be executed when the SD memory card access instruction is being executed.

■ Flag operations

Name	Description
R917A (SD memory card access instruction execution in progress)	Turns ON when instruction execution starts. Turns OFF when instruction execution is complete.
R917B (SD memory card access instruction execution complete)	Turns OFF when instruction execution starts. Turns ON when instruction execution is complete.
R917C (SD memory card access instruction execution results)	Indicates the execution results when instruction execution is complete. Normal end = 0, abnormal end = 1
R9007 R9008 (ER)	Turns ON if the specified destination is an out-of-range device when the device specification is indirect access (index modification).

33.12 F436 CCOPY (File Copy)

■ **Instruction format**

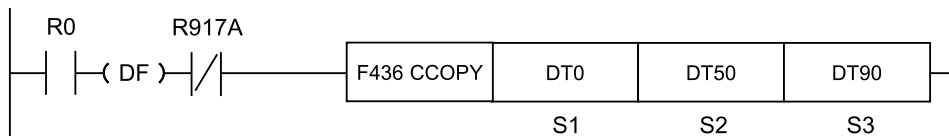

■ **Operands**

Items	Settings
S1	Starting address of the device storing the path name and number of characters of the copy source file Specify number of characters in [S1], path name in [S1+1] and later (folder name + filename: maximum 256 characters)
S2	Starting address of the device storing the path name and number of characters of the copy destination file Specify number of characters in [S2] and path name in [S2+2] onwards (folder name + file name: maximum 256 characters)
S3	Setting of copy format

■ **Devices that can be specified (indicated by ●)**

Operands	WX	WY	WR	WL	SV	EV	DT	LD	I	SWR	SDT	Constant				Index modifier (Note 1)	Integer Device
												K	H	M	f		
S1	●	●	●	●	●	●	●	●	●					●			
S2	●	●	●	●	●	●	●	●	●					●			
S3	●	●	●	●	●	●	●	●	●			●	●			●	

(Note 1) A character constant cannot be specified.

■ **Outline of operation**

- Copies the file specified by [S1] to the file specified by [S2] in accordance with the parameters specified by [S3].
- If the folder is specified in [S1], all of the files directly under the folder in [S1] are copied directly under the folder specified by [S2].
- Does not copy folders in lower levels further than the [S1] folder.
- If [S1] and [S2] are exactly the same, an error is returned regardless of the value of [S3].
- If a file is specified in [S1] and a folder is specified in [S2], the file specified by [S1] is copied into the folder specified by [S2].

■ **[S1] to [S1+1]: Specification of the copy source folder name and file name**

- Starting device storing the folder name (folder name + filename: from 1 to 256 characters) and number of characters stored in the SD memory card

Setting device	Description
S1	Set the number of characters of the name of the file to be copied. (Full path specification)
S1+1 to S1+128	Specify the file to be copied. <ul style="list-style-type: none"> The full path configuration is up to a maximum of 256 characters including the folder name + filename

■ **[S2] to [S2+1]: Specification of the copy destination folder name and file name**

- Starting device storing the folder name (folder name + file name: 1 to 256 characters) and number of characters to be stored in the SD memory card

Setting device	Description
S2	Set the number of characters of the copy destination file name. (Full path specification)
S2+1 to S2+128	Specify the copy destination file. <ul style="list-style-type: none"> The full path configuration is up to a maximum of 256 characters including the folder name + filename

■ **[S3]: Specification of copy format**

Operands	Specified bits	Description
S3	bit0	0: Overwrites if there is a file with the same name in the copy destination. Files with the read-only attribute are not overwritten. 1: Terminates with an error without overwriting if there is a file with the same name in the copy destination.
	Bit1 to 15	(Reserved for system)

■ **Processing examples**

e.g. When copying file "\abc\data1.csv" to "\def\test1.csv"

(1)	by conversion method	(2)	Path name (folder name and filename)
-----	----------------------	-----	--------------------------------------

33.12 F436 CCOPY (File Copy)

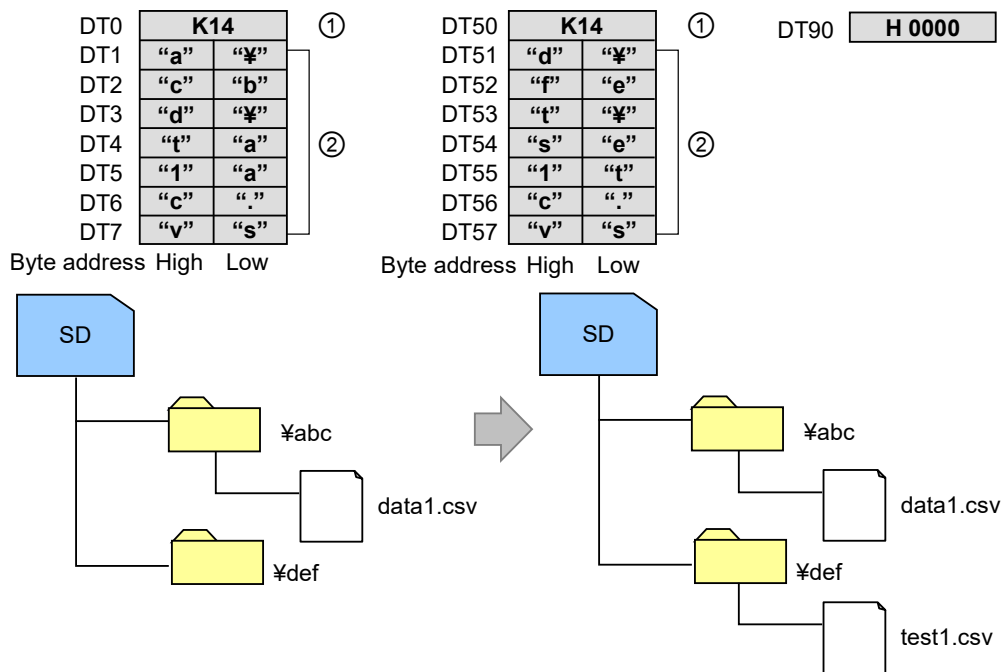

■ Precautions for programming

- Also refer to section "33.1 Common Precautions for SD Memory Card Access Instructions".
- The SD memory card access instruction execution in progress flag (R917A) turns ON from when the execution condition turns ON to when execution of the instruction is complete. During this time other SD memory card access instructions cannot be executed.
- If a folder is specified in [S1] and a file is specified in [S2], a "file name error" is returned.

■ Flag operations

Name	Description
R917A (SD memory card access instruction execution in progress)	Turns ON when instruction execution starts. Turns OFF when instruction execution is complete.
R917B (SD memory card access instruction execution complete)	Turns OFF when instruction execution starts. Turns ON when instruction execution is complete.
R917C (SD memory card access instruction execution results)	Indicates the execution results when instruction execution is complete. Normal end = 0, abnormal end = 1
R9007 R9008 (ER)	Turns ON if the specified destination is an out-of-range device when the device specification is indirect access (index modification).

33.13 F437 CMV (File Transfer)

■ Instruction format

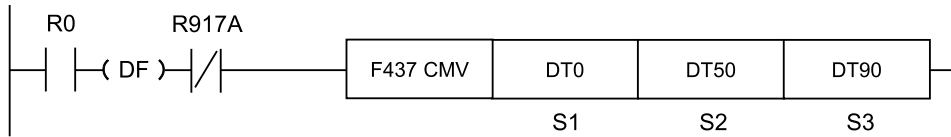

■ Operands

Items	Settings
S1	Starting address of the device that stores the path name and number of characters of the file to be transferred Specify number of characters in [S1], path name in [S1+1] and later (folder name + filename: maximum 256 characters)
S2	Starting address of the device that stores the path name and number of characters of the destination file Specify number of characters in [S2] and path name in [S2+2] onwards (folder name + file name: maximum 256 characters)
S3	Setting of transfer format

■ Devices that can be specified (indicated by ●)

Operands	WX	WY	WR	WL	SV	EV	DT	LD	I	SWR	SDT	Constant				Index modifier (Note 1)	Integer Device
												K	H	M	f		
S1	●	●	●	●	●	●	●	●	●					●			
S2	●	●	●	●	●	●	●	●	●					●			
S3	●	●	●	●	●	●	●	●	●			●	●			●	

(Note 1) A character constant cannot be specified.

■ Outline of operation

- Transfers a file specified by the string data starting at [S1] to a file path specified by the string data starting at [S2].
- When a folder is specified in [S1], all files in the [S1] folder are transferred to the folder specified in [S2].
- Any folders within the folder specified in [S1] are not transferred.
- Read-only files remain read-only after transfer.
- When executing the instruction, the card must have free space of at least the file size.
- When a file is specified in [S1] and a folder is specified in [S2], the file specified in [S1] will be transferred to the folder specified in [S2].

■ [S1] to [S1+1]: Specifying the folder or file name for transfer

- Starting device storing the folder name (folder name + filename: from 1 to 256 characters) and number of characters stored in the SD memory card

33.13 F437 CMV (File Transfer)

Setting device	Description
S1	Set the number of characters in the name of the file to be transferred. (Full path specification)
S1+1 to S1+128	Specify the file to be transferred. <ul style="list-style-type: none"> The full path configuration is up to a maximum of 256 characters including the folder name + filename

■ [S2] to [S2+1]: Specifying the destination folder or file name

- Starting device storing the destination folder name (folder name + file name: 1 to 256 characters) and number of characters to be saved on an SD memory card

Setting device	Description
S2	Set the number of characters in the destination file name. (Full path specification)
S2+1 to S2+128	Specify the destination file. <ul style="list-style-type: none"> The full path configuration is up to a maximum of 256 characters including the folder name + filename

■ [S3]: Specifying the transfer format

Operands	Specified bits	Description
S3	bit0	0: If there is a file with the same name in the destination, it will be overwritten. 1: If there is a file with the same name in the destination, it will not be overwritten and an error termination will occur.
	Bit1 to 15	(Reserved for system)

■ Processing examples

e.g. Transferring the file "\abc\data1" to "\def\test2"

(1)	by conversion method	(2)	Path name (folder name and filename)
-----	----------------------	-----	--------------------------------------

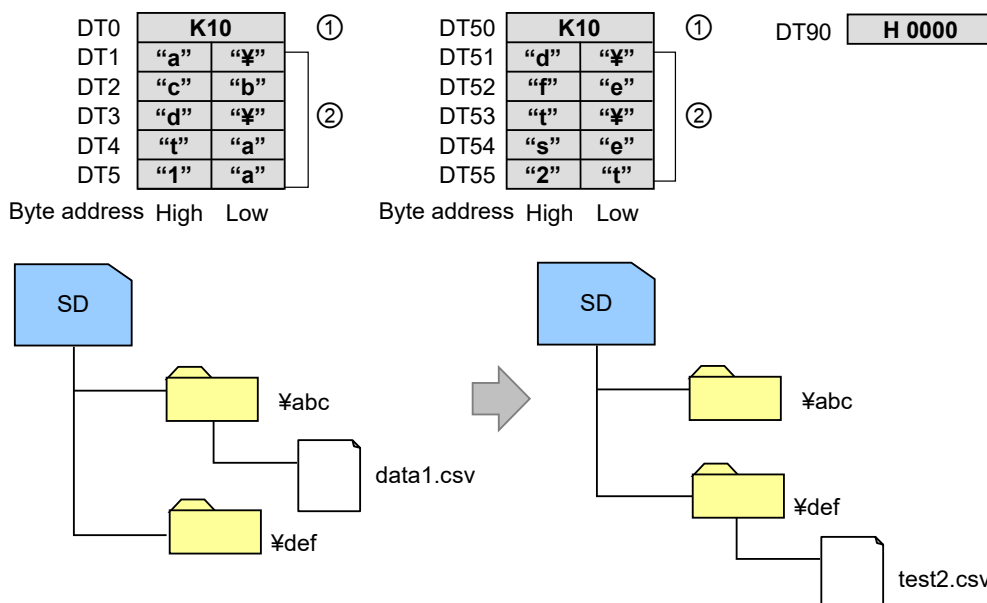

■ Precautions for programming

- Also refer to section "33.1 Common Precautions for SD Memory Card Access Instructions".
- The SD memory card access instruction execution in progress flag (R917A) turns ON from when the execution condition turns ON to when execution of the instruction is complete. During this time other SD memory card access instructions cannot be executed.
- If the folder specified in [S2] does not exist, the error "The file or folder does not exist" will occur.
- If there is insufficient free space, the error "Not enough space on memory card" will occur.
- If a folder is specified in [S1] and a file is specified in [S2], a "file name error" is returned.

■ Flag operations

Name	Description
R917A (SD memory card access instruction execution in progress)	Turns ON when instruction execution starts. Turns OFF when instruction execution is complete.
R917B (SD memory card access instruction execution complete)	Turns OFF when instruction execution starts. Turns ON when instruction execution is complete.
R917C (SD memory card access instruction execution results)	Indicates the execution results when instruction execution is complete. Normal end = 0, abnormal end = 1
R9007 R9008 (ER)	Turns ON if the specified destination is an out-of-range device when the device specification is indirect access (index modification).

33.14 F438 CFREE (SD memory card free space acquisition: byte units)

33.14 F438 CFREE (SD memory card free space acquisition: byte units)

■ Instruction format

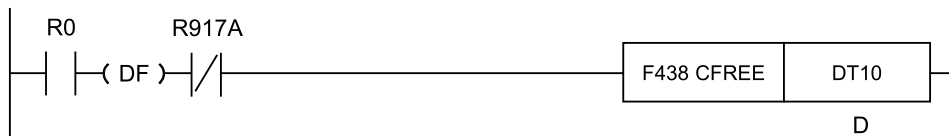

■ Operands

Items	Settings
D	Starting address of the device storing the acquired free space in byte units

■ Devices that can be specified (indicated by ●)

Operands	WX	WY	WR	WL	SV	EV	DT	LD	I	SWR	SDT	Constant				Index modifier	Integer Device
											K	H	M	f			
D		●	●	●	●	●	●	●	●							●	

■ Outline of operation

- The SD memory card free space is stored in byte units in the area specified by [D].

e.g. When the SD memory card has 4 GB of free space

[D] ...DT10

DT10	H 0000	} H 1 0000 0000 (4,294,967,296 byte)
DT11	H 0000	
DT12	H 0001	
DT13	H 0000	
DT14	H 0000	
DT15	H 0000	

■ Precautions for programming

- Also refer to section "[33.1 Common Precautions for SD Memory Card Access Instructions](#)".
- The SD memory card access instruction execution in progress flag (R917A) turns ON from when the execution condition turns ON to when execution of the instruction is complete. During this time other SD memory card access instructions cannot be executed.

■ Flag operations

Name	Description
R917A (SD memory card access instruction execution in progress)	Turns ON when instruction execution starts. Turns OFF when instruction execution is complete.
R917B (SD memory card access instruction execution complete)	Turns OFF when instruction execution starts. Turns ON when instruction execution is complete.

33.14 F438 CFREE (SD memory card free space acquisition: byte units)

Name	Description
R917C (SD memory card access instruction execution results)	Indicates the execution results when instruction execution is complete. Normal end = 0, abnormal end = 1
R9007 R9008 (ER)	Turns ON if the specified destination is an out-of-range device when the device specification is indirect access (index modification).

33.15 F439 CFREEK (SD Memory Card Free Space Acquisition: Kilobyte Units)

33.15 F439 CFREEK (SD Memory Card Free Space Acquisition: Kilobyte Units)

■ Instruction format



■ Operands

Items	Settings
D	Starting address of the device storing the acquired free space in kilobyte units

■ Devices that can be specified (indicated by ●)

Operands	WX	WY	WR	WL	SV	EV	DT	LD	I	SWR	SDT	Constant				Index modifier	Integer Device
												K	H	M	f		
D		●	●	●	●	●	●	●	●							●	

■ Outline of operation

- The SD memory card free space is stored in kilobyte units in the area specified by [D].

e.g. When the SD memory card has 4 GB of free space

[D] ...DT10

DT10	H 0000	H 0040 0000 (4,194,304 Kbyte)
DT11	H 0040	
DT12	H 0000	

■ Precautions for programming

- Also refer to section "[33.1 Common Precautions for SD Memory Card Access Instructions](#)".
- The SD memory card access instruction execution in progress flag (R917A) turns ON from when the execution condition turns ON to when execution of the instruction is complete. During this time other SD memory card access instructions cannot be executed.

■ Flag operations

Name	Description
R917A (SD memory card access instruction execution in progress)	Turns ON when instruction execution starts. Turns OFF when instruction execution is complete.
R917B (SD memory card access instruction execution complete)	Turns OFF when instruction execution starts. Turns ON when instruction execution is complete.

33.15 F439 CFREEK (SD Memory Card Free Space Acquisition: Kilobyte Units)

Name	Description
R917C (SD memory card access instruction execution results)	Indicates the execution results when instruction execution is complete. Normal end = 0, abnormal end = 1
R9007 R9008 (ER)	Turns ON if the specified destination is an out-of-range device when the device specification is indirect access (index modification).

33.16 F440 CFLS (File status acquisition)

33.16 F440 CFLS (File status acquisition)

■ Instruction format

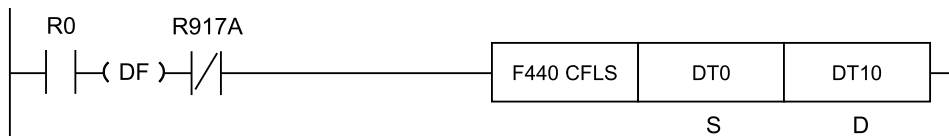

■ Operands

Items	Settings
S	Starting address of the device storing the path name and number of characters to acquire from the file from which the file status is to be read. Specify number of characters in [S] and the path name in [S+1] and later (folder name + filename: maximum 256 characters)
D	Starting address of the device storing the acquired file status

■ Devices that can be specified (indicated by ●)

Operands	WX	WY	WR	WL	SV	EV	DT	LD	I	SWR	SDT	Constant				Index modifier (Note 1)	Integer Device
												K	H	M	f		
S	●	●	●	●	●	●	●	●	●					●			
D		●	●	●	●	●	●	●	●						●		

(Note 1) A character constant cannot be specified.

■ Outline of operation

- The file name status specified by [S] is acquired and the result is stored in the 10-word area from [D] (D to D+9).

■ Details of stored content

Device storing acquired result	Acquired contents		
D	File attributes	Bit position	Description
		0	Turns ON in the case of a read-only file
		1	Turns ON in the case of a hidden file
		2	Turns ON in the case of a system file
		3	Turns ON in the case of a volume label
		4	Turns ON in the case of a directory
		5	Turns ON in the case of an archive
	6 to 15	(Reserved: Fixed to 0)	
D+1	(Reserved)		

Device storing acquired result	Acquired contents	
D+2	File size: Stored as a decimal number.	
D+3		
D+4	Last modified: Stored as a decimal number.	Year (0 to 99)
D+5		Month (1 to 12)
D+6		Day (1 to 31)
D+7		Hours (0 to 23)
D+8		Minutes (0 to 59)
D+9		Seconds (0 to 59)

■ Processing examples

e.g. When the status of file "\abc\data1.csv" is acquired

- File attribute: Read-only
- File size: 123,456 bytes
- Last modified: January 23, 2012 at 12:34:56

DT0	K14		①
DT1	"a"	"#"	
DT2	"c"	"b"	②
DT3	"d"	"y"	
DT4	"t"	"a"	
DT5	"1"	"a"	
DT6	"c"	"."	
DT7	"v"	"s"	

Byte address High Low

DT10	H 0000
DT11	H 0000
DT12	H 0000
DT13	H 0000
DT14	H 0000
DT15	H 0000
DT16	H 0000
DT17	H 0000
DT18	H 0000
DT19	H 0000
DT20	H 0000



DT10	H 0001
DT11	H 0000
DT12	K123456
DT13	
DT14	K12
DT15	K1
DT16	K23
DT17	K12
DT18	K34
DT19	K56
DT20	H 0000

■ Precautions for programming

- Also refer to section "[33.1 Common Precautions for SD Memory Card Access Instructions](#)".
- The SD memory card access instruction execution in progress flag (R917A) turns ON from when the execution condition turns ON to when execution of the instruction is complete. During this time other SD memory card access instructions cannot be executed.

33.16 F440 CFLS (File status acquisition)

■ Flag operations

Name	Description
R917A (SD memory card access instruction execution in progress)	Turns ON when instruction execution starts. Turns OFF when instruction execution is complete.
R917B (SD memory card access instruction execution complete)	Turns OFF when instruction execution starts. Turns ON when instruction execution is complete.
R917C (SD memory card access instruction execution results)	Indicates the execution results when instruction execution is complete. Normal end = 0, abnormal end = 1
R9007 R9008 (ER)	Turns ON if the specified destination is an out-of-range device when the device specification is indirect access (index modification).

33.17 F441 PanaSD (Read of lifetime information of Panasonic SD card)

■ Instruction format

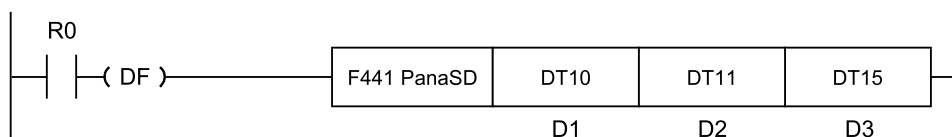

■ Operands

Items	Settings
D1	Execution result code storage device address
D2	Starting address of device storing SD memory card lifetime information acquisition time
D3	Number of rewrites information storage device address

■ Devices that can be specified (indicated by ●)

Operands	WX	WY	WR	WL	SV	EV	DT	LD	I	SW R	SD T	Constant				Index modifier	Integer Device
												K	H	M	f		
D1		●	●	●	●	●	●	●	●								
D2		●	●	●	●	●	●	●	●								
D3		●	●	●	●	●	●	●	●								

■ Outline of operation

- This instruction is used to read Panasonic SD memory card lifetime information.
- This instruction and the SD card access instruction can be used at the same time.
- The results of executing this instruction are stored in the areas starting from [D1], [D2], and [D3].
- This instruction cannot be executed in duplicate.
- It is recommended to avoid frequent execution of this instruction and to execute it as a differential instruction.
- This is a dedicated instruction for use with SD memory cards manufactured by Panasonic. It cannot be used with any other SD memory cards. The Panasonic SD memory card series compatible with this instruction are shown below.

■ Compatible SD memory cards

Type	Series	Conventional product
SLC	EX	FX
MLC	GD	JD, PC

33.17 F441 PanaSD (Read of lifetime information of Panasonic SD card)

■ Execution result storage area

Operands	Items	Description
[D1]	Execution result code (Note 1)	Stores the execution result code. HFFFF: Executing H0: Normal end H1: Dual-boot error H2: SD memory card cover open error H3: SD memory card not installed error H4: Incompatible SD memory card error
[D2]	Acquisition time	Year and month The SD memory card lifetime information acquisition time is stored as three-word BCD data.
[D2+1]		Day and hour e.g. When the acquisition time is 15 hours 55 minutes and 30 seconds on October 3, 2014, it is stored as follows. [D2] H1410
[D2+2]		Minute and second [D2+1] H0315 [D2+2] H5530
[D3]	Number of rewrite information	Percentage (%) of (average number of control block rewrites) to (maximum possible number of rewrites) = Number of rewrites (average of all control blocks) / maximum possible number of rewrites × 100

(Note 1) The most significant bit of the execution result code can be used as a flag during execution.

■ Processing examples

Example 1: F441 PanaSD instruction execution result: Normal

[D1]...DT10	[D2]...DT11~DT13	[D3]...DT15
When executing instruction	During reading of SD card information	When reading of SD card is finished (Normal end)
DT10	DT10	DT10
DT11	DT11	DT11
DT12	DT12	DT12
DT13	DT13	DT13
DT14	DT14	DT14
DT15	DT15	DT15
H FFFF	H FFFF	H 0
		H 1410
		H 0318
		H 5530
		H 0052
		Execution result code :0
		Year, month :1410
		Day, hour :318
		Minute, second :5530
		Number of rewrites information (%) :82

Example 2: F441 PanaSD instruction execution result: Error

[D1]...DT10	[D2]...DT11~DT13	[D3]...DT15
When executing instruction	During reading of SD card information	When reading of SD card is finished (Incompatible SD memory card error)
DT10	DT10	DT10
DT11	DT11	DT11
DT12	DT12	DT12
DT13	DT13	DT13
DT14	DT14	DT14
DT15	DT15	DT15
H FFFF	H FFFF	H 3
		H 0
		H 0
		H 0
		H 0
		Execution result code :3
		Year, month :0
		Day, hour :0
		Minute, second :0
		Number of rewrites information (%) :0

■ Flag operations

Name	Description
R9007	Set when the [D2] to [D2+2] range exceeds the accessible range.
R9008 (ER)	Set when executed in an interrupt program.

(MEMO)

34 Ethernet Instructions

34.1 F460 IPv4SET (Ipv4 Address Setting).....	34-2
34.2 F461 CONSET (Connection Setting).....	34-7
34.3 F462 OPEN (Connection Open).....	34-14
34.4 F463 CLOSE (Connection Close).....	34-16
34.5 F464 RDET (Ethernet Status Read).....	34-18
34.6 F465 ETSTAT (EtherNet Information Acquisition).....	34-21
34.7 P466 NTPcREQ (Time Adjustment Request).....	34-25
34.8 F467 NTPcSV (NTP Destination Server Setting).....	34-31
34.9 P468 PINGREQ (PING Send Request).....	34-36
34.10 F469 UNITSEL (Specify Communication Unit Slot Port).....	34-40

34.1 F460 IPv4SET (IPv4 Address Setting)

34.1 F460 IPv4SET (IPv4 Address Setting)

■ Instruction format

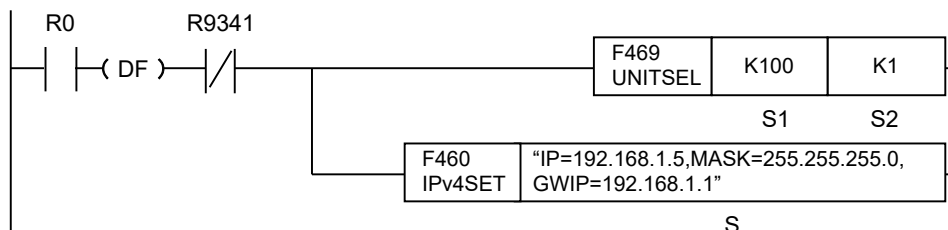

(Note 1) The figure above shows the case of specifying S1=K100 (Ethernet communication) and S2=K1 (connection No. 1) using F469 (UNITSEL) instruction.

(Note 2) By copying & pasting the the following text into the instruction list box of FPWIN GR7, the operand section of the program example above can be entered.

IPv4SET "IP=192.168.1.5, MASK=255.255.255.0, GWIP=192.168.1.1"

■ Operands

Items	Settings
S	The starting address of a device that stores string data representing the parameter to be set, or a character constant

■ Devices that can be specified (indicated by ●)

Operands	WX	WY	WR	WL	SV	EV	DT	LD	I	SW R	SDT	Constant			Index modifier (Note 1)
												K	H	M	
S	●	●	●	●	●	●	●	●	●					●	●

(Note 1) A character constant cannot be specified.

■ Outline of operation

Perform the setting of IP address (IPv4).

■ Processing

- Store the IPv4 setting parameter specified by **S** into an operation work area, and initialize the built-in Ethernet IP address (essential), subnet mask mask (optional), and gateway (optional). Values specified by tool software are applied to items that are not modified by instructions.
- Communication is not available while Ethernet initialization is in progress.
- The establishment of IPv4 address, cable disconnection, etc. can be checked using a special relay (R9340 to R9342).

R9340	Ethernet cable disconnection detection"1: Disconnected / 0: Connected"
R9341	Ethernet initialization in progress"1: Initialization in progress / 0: Initialization complete"
R9342	IP address established"1: Established / 0: Not established"

- If this instruction is executed when IP address is outside the permissible range, a special relay R9009 (carry flag CY) is set, and no operation is performed. Check "[List of usable IP addresses](#)".
- This instruction can be executed when the Ethernet initialization in progress flag (R9341) is OFF. As execution conditions for the instruction, insert a program to check the flag state. If this instruction is executed when the flag is ON, a special relay R9009 (carry flag CY) is set, and no operation is performed.
- When the instruction is completed successfully, the special relay R9009 (carry flag CY) and the special data register DT90529 (Ethernet communication error code) are cleared.
- Settings by this instruction is not retained when power failure occurs or when the unit is switched to the PROG. mode. When the unit is switched back from PROG. mode to RUN mode, the configuration information set by the tool software will be preset.

■ Precautions for programming

- Immediately before this instruction, insert F469 (UNITSEL) instruction, and specify the unit (Ethernet communication) and connection No.
- If the IP address setting is changed during communication, the process in progress will fail.
- Execute this instruction only once at the startup of PLC. Do not execute it repeatedly.
- It takes three seconds or longer to complete initialization following setting. Communication is disconnected until the completion of the initialization. All connections using the Ethernet function are disconnected during execution.
- This instruction is not available in an interrupt program.

■ OperandSetting

- Specify the starting address of a device that stores string data representing the parameter to be set, or a character constant.
- Upper and lower case characters can be used. "Abcd", "ABCD" and "abcd" are all synonymous.
- When specifying a device for an operand, set string data using F253 (SSET) instruction in advance.
- When specifying string data, the number of characters should not exceed 256.
- A part of parameters can be omitted. The settings are not changed when parameters are omitted partially.
- When omitting the part before a specified keyword, omit only "keyword" without omitting <, >.
- When omitting the part after a specified keyword, omit both <, > and "keyword".
- It is prohibited to specify the same keyword redundantly. An error is caused in the case of redundant specification.

Items	Settings	
S	IPv4 address	Specify an IP address (IPv4). Specify the keyword "IP=" at the beginning. IP=111.122.133.144 (Default: 192.168.1.5)
	Subnet mask	Specify a subnet mask. Specify the keyword "MASK=" at the beginning. MASK=255.255.255.0 (Default: 255.255.255.0)
	Default gateway	Specify an IP address for default gateway. Specify the keyword "GWIP=" at the beginning. GWIP=111.122.133.4 (Default: 192.168.1.1) Specify "0" when default gateway is not to be used.

(Note 1) Setting parameters should be entered with each setting parameter separated by a comma " , ".

(Note 2) Both upper and lower cases can be used for specifying keywords.

34.1 F460 IPv4SET (IPv4 Address Setting)

(Note 3) Specify keywords in the order indicated in the table above.

Setting example

Example 1	S	"IP=192.168.1.5, MASK=255.255.255.0, GWIP=192.168.1.1"
Settings		IP address = 192.168.1.5; Subnet mask = 255.255.255.0; Default gateway = 192.168.1.1
Example 2	S	"IP=192.168.1.5, MASK=255.255.255.0, GWIP=0"
Settings		IP address = 192.168.1.5; Subnet mask = 255.255.255.0; Default gateway = Not used

- When an invalid address is specified for the parameter, the special relay R9009 (carry flag CY) turns ON, and 1(IP address error) to 4(Default gateway error) is set to the special data register DDT90527 (Ethernet communication error code), and the process is terminated.
- For more details of permissible address setting range, refer to "[38.8.1 IP Address Setting Specification](#)".

■ Setting status when parameters are omitted

- IPv4 address is essential. It must be indicated.
- "Subnet mask" and "Default gateway" can be omitted. Omitted parameters are not changed.

Parameter			How to specify	Result reflected in parameters		
IP	MASK	GWIP		IP address	Subnet mask	Default gateway
Essential	Omitted	Setting	"IP=○○○○, GWIP=○○○○"	Changed	Not changed	Changed
Essential	Setting	Omitted	"IP=○○○○, MASK=○○○○"	Changed	Changed	Not changed
Essential	Omitted	Omitted	"IP=○○○○"	Changed	Not changed	Not changed

Setting example

Example 1	S	"IP=192.168.1.5, GWIP=192.168.1.1"
Settings		IP address = 192.168.1.5; Subnet mask = Not changed; Default gateway = 192.168.1.1
Example 2	S	"IP=192.168.1.5, MASK=255.255.255.0"
Settings		IP address: 192.168.1.5; Subnet mask: 255.255.255.0; Default gateway: not changed
Example 3	S	"IP=192.168.1.5"
Settings		IP address: 192.168.1.5; Subnet mask: not changed; Default gateway: not changed

■ Program example

- Confirm that the Ethernet initialization in progress flag (R9341) is off, and execute the instruction.
- Using F469 (UNITSEL) instruction, specify the slot number (LAN port: K100) and the connection No. (K1 to K9).
- Once the instruction is executed, the IPv4 setting parameter will be written into the system work area, and initialization will be requested to the unit.

34.1 F460 IPv4SET (IPv4 Address Setting)

- Once initialization is requested, the unit will close all connections and disconnect communication.
- The unit turns OFF the IP address established flag (R9342) and initializes the Ethernet unit with the value specified in the system work area.
- The unit starts auto negotiation at the time of initialization.
- The IP address established flag (R9342) turns ON upon the completion of initialization. It takes about three seconds to complete initialization.
- Each communication task such as FTPc starts up according to the settings. It is possible to confirm those states with the ready flag for each operation.
- Each connection that is set to automatic connection is established, and the clear to send flag turns ON when connection is complete.

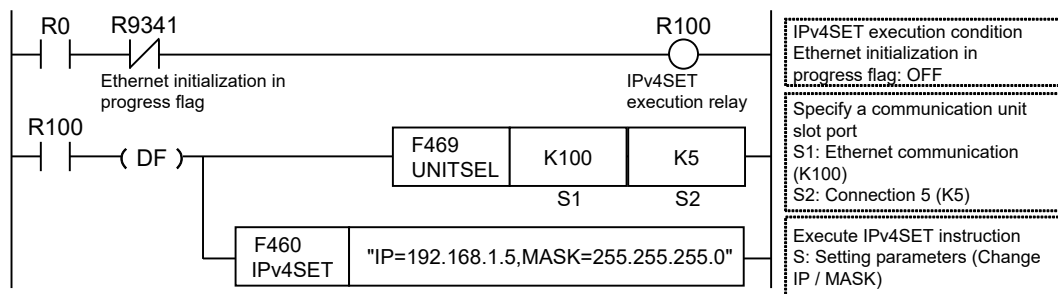

■ Timing chart

The following figure shows the case for executing F460 (IPv4SET) instruction.

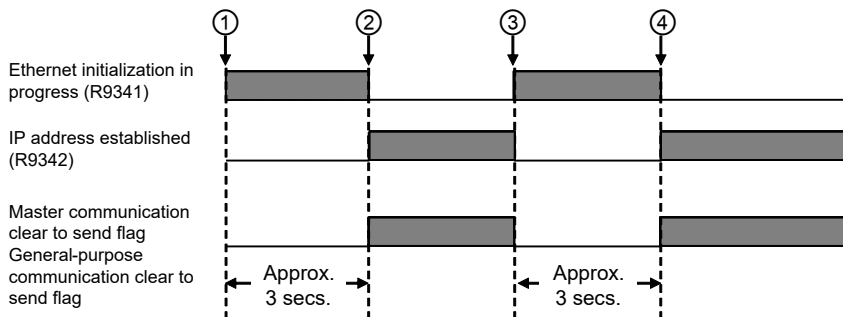

(1)	PROG > RUN (Power ON)	(3)	IP address setting (execute F460 to IPv4SET instruction)
(2)	Ethernet initialization complete Connection established	(4)	Ethernet initialization complete Connection established

■ Flag operations

Name	Description
R9007 R9008 (ER)	Set when a value outside the range is specified for the parameter.
	Set when the same keyword is specified redundantly.
	Set when the slot No. specified by F469 (UNITSEL) is not S1=100 (Ethernet communication).
	To be set when the setting is other than IPv4.

34.1 F460 IPv4SET (IPv4 Address Setting)

Name	Description
	To be set when executed in an interrupt program.
	Set when the number of characters for operand specifying character constant exceeds 256.
R9009 (CY)	Set in the case of execution while IP address is incorrect. The detailed code to be set in DT90529 is"1: Incorrect IP address specification".
	Set in the case of execution while subnet mask is incorrect. The detailed code to be set in DT90529 is"2: Incorrect subnet mask specification mask specified".
	Set in the case of execution while default gateway is incorrect. The detailed code to be set in DT90529 is"3: Incorrect default gateway specified".
	Set in the case of execution while IP address combination is incorrect. The detailed code to be set in DT90529 is"4: Incorrect IP address combination".
	To be set in the case of execution during Ethernet initialization. The detailed code to be set in DT90529 is"11: Ethernet initialization in progress".

(Note 1) For error codes stored in the special data register R90529, refer to.

34.2 F461 CONSET (Connection Setting)

■ Instruction format

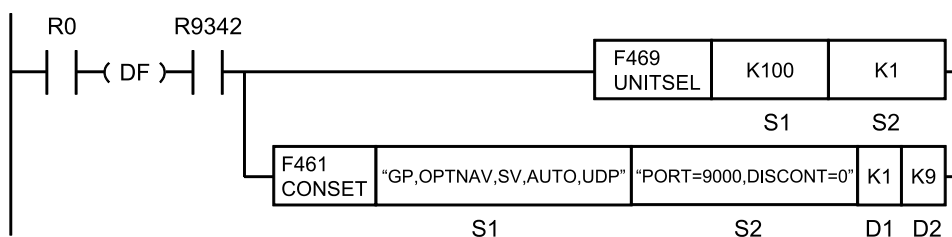

(Note 1) Specify S1=K100 (Ethernet communication) in advance using F469 UNITSEL instruction.

(Note 2) By copying & pasting the following text into the instruction list box of FPWIN GR7, the operand section of the program example above can be entered.

```
CONSET "GP,OPTNAV,SV,AUTO,UDP" "PORT=9000,DISCONT=0" K1 K9
```

■ Operands

Items	Settings
S1	Either the starting address of a device that stores string data representing the parameter for operation setting, or a character constant
S2	Either the starting address of a device that stores string data representing the parameter for port setting, or a character constant
D1	Either the device address storing a setting start connection number, or a constant
D2	Either the device address storing a setting end connection number, or a constant

■ Devices that can be specified (indicated by ●)

Operands	WX	WY	WR	WL	SV	EV	DT	LD	I	SW R	SDT	Constant			Index modifier (Note 1)
												K	H	M	
S1	●	●	●	●	●	●	●	●	●					●	●
S2	●	●	●	●	●	●	●	●	●					●	●
D1	●	●	●	●	●	●	●	●	●	●	●	●	●		●
D2	●	●	●	●	●	●	●	●	●	●	●	●	●		●

(Note 1) A character constant cannot be specified.

■ Outline of operation

- Set connection setting parameters specified by **S1** and **S2** to the connection in the range specified by **D1** and **D2**.

■ Processing

- Set connection setting parameters specified by **S1** and **S2** to the connection in the range specified by **D1** and **D2**.

34.2 F461 CONSET (Connection Setting)

- If the connection within the range specified by **D1** and **D2** includes the connection of a multi-connection server, an operation error occurs.
- If an incorrect IP address is specified, a special relay R9009 (carry flag CY) is set, and no operation is performed.
- This instruction can be executed when the IP address established flag (R9342) is ON. As execution conditions for the instruction, insert a program to check the flag (R9342) state. If this instruction is executed when the flag (R9342) is OFF, a special relay R9009 (carry flag CY) is set, and no operation is performed.
- When the instruction is completed successfully, the special relay R9009 (carry flag CY) and the special data register DT90529 (Ethernet communication error code) are cleared.

■ Precautions for programming

- Immediately before this instruction, insert F469 (UNITSEL) instruction, and specify the unit (Ethernet communication). Specifying the connection number with the operand **S2** of F469 (UNITSEL) instruction is invalid with this instruction.
- In **S1** and **S2**, specify either the starting address of a device that stores string data representing the parameter to be set, or a character constant. When specifying a device for an operand, set string data using F253 (SSET) instruction in advance. Both upper case and lower case can be used. "Abcd", "ABCD" and "abcd" are all synonymous.
- Specify values so that **D1** is equal to or smaller than **D2**.
- The maximum number for **D1** and **D2** settable connection Nos. should be the "Number of user connection information settings" in the Ethernet unit configuration data.
- When the open method is set to Client connection, perform setting by incrementing the destination IP address by one from the setting start connection to the setting end connection.
- When the open method is set to server connection, perform setting by incrementing the master unit port No. by one from the setting start connection number to the setting end connection.
- Specify **D1** and **D2** so that the destination unit IP address or the master unit port does not exceed the settable range.
- If the target connection is already accepting a setting request or F145 (SEND) / F146 (RECV), an operation error results. Note that, when multiple connections are set, the settings for the connections before the connection in which an operation error occurs will be changed. The settings for connections after the connection in which an operation error occurs will not be changed.
- Settings by this instruction is not retained when power failure occurs or when the unit is switched to the PROG. mode. When the unit is switched back from PROG. mode to RUN mode, the configuration information set by the tool software will be preset.
- This instruction is not available in an interrupt program.

■ Operand **S1** setting

- Specify either the starting address of a device that stores string data representing the operation setting parameter, or a character constant.
- When "INITIAL" is specified without specifying parameters, the unit performs operation according to the table of special keywords.

Items	Settings	
S1	Operation Mode Setting (Essential)	Specify an operation mode. MEWCOM : Specify MEWTOCOL-COM. MODBUS : Specify MODBUS-TCP.

34.2 F461 CONSET (Connection Setting)

Items	Settings			
		MEWDAT : Specify MEWTOCOL-DAT. MC3EBIN : Specify MC Protocol (3E BINARY). GP : Specify general-purpose communication.		
	Option setting (Essential)	Specify protocol options. Available options differ according to operation modes. OPTAV: Option available; OPTNAV: Option not available		
		Operation mode selection	Option is available.	Option is not available.
		MEWTOCOL-COM	Connect with FP2 ET-LAN	No connection
		MODBUS-TCP	Invalid	-
		MEWTOCOL-DAT	Connect with FP2 ET-LAN	No connection
		MC Protocol (3E BINARY)	Invalid	
	General-purpose communication	Not append a special header	Append a special header	
	Open method setting Server / Client (Essential)	Specify an open method (Server / Client). CL: Client connection; SV: Server connection (any destination unit)		
	Open method setting Automatic / Manual (Essential)	Specify an open method (Automatic / Manual). Select an open method (Automatically Open/ Manually Open). AUTO: Automatic, MANU: Manual		
	Communication method setting (Essential)	Specify a communication method (TCP / UDP). When the server is specified for the open method, only TCP/IP setting can be specified. TCP: TCP/IP setting; UDP: UDP/IP setting		

(Note 1) Operation setting should be entered with each setting parameter separated by a comma “,”.

(Note 2) Both upper and lower cases can be used for specifying keywords.

(Note 3) Operation setting parameters may not be omitted, and should be specified in order indicated in the table above.

(Note 4) There is a difference as follows between high-level instructions and configuration data when UDP is specified for the communication method. Although the open method (Server / Client) setting is not available for configuration data, a server or client needs to be specified in high-level instructions. Specify “SV” for use in slave connection, and “CL” for use in master connection.

Setting example

Example 1	S1	“MEWCOM,OPTAV,CL,AUTO,UDP”
Settings		Operation mode setting: MEWCOM, Option setting: Option available, Open method (Server / Client): Client, Open method (Automatic / Manual): Open automatically, Communication type: UDP/IP
Example 2	S1	“MODBUS,OPTNAV,SV,AUTO,TCP”
Settings		Operation mode setting: MODBUS, Option setting: Option not available, Open method (Server / Client): Server (any destination unit),

34.2 F461 CONSET (Connection Setting)

		Open method (Automatic / Manual): Open automatically, Communication type: TCP/IP
Example 3	S1	"GP,OPTNAV,SV,AUTO,TCP"
Settings		Operation mode setting: GP, Option setting: Option not available, Open method (Server / Client): Server (any destination unit), Open method (Automatic / Manual): Open automatically, Communication type: TCP/IP

■ Special keywords for operandS1

Special keyword	Description
"INITIAL"	Set initial values for the following items. Operation mode setting: MEWCOL-COM, Option setting: Option not available, Open method (Server / Client): Client, Open method (Automatic / Manual): Open automatically, Communication type: TCP/IP

■ OperandS2setting

- Specify either the starting address of a device that stores string data representing the port setting parameter, or a character constant.
Setting items differ between Client specification and Server specification. It is prohibited to specify the same setting parameter redundantly. An error is caused in the case of redundant specification.

< When specifying Client >

- Perform setting by incrementing the destination IP address by one from the setting start connection number to the setting end connection number. The increment range is the lower one block only.
- Destination unit port Nos. and unused connection disconnect time are not incremented.
- An error occurs when the IPv4 address value exceeds 255 when incremented.
- When specifying for each connection, change the destination unit IP address and destination unit port number to those of other connection specified by the client. If the setting is duplicated, an operation error occurs. For the master unit port number, "0" is set automatically.
- When the operation mode of S1 is set to general-purpose communication, a general-purpose receive buffer can be set.

Perform setting by adding a general-purpose receive buffer size to the general-purpose receive buffer starting address, from the setting start connection number to the setting end connection number.

When the range of DT (data register) is exceeded while adding a buffer size, an error will result.

- When the general-purpose receive buffer size is omitted, the general-purpose receive buffer starting address is set by adding a general-purpose receive buffer size of each connection that has already been specified.

[(When none is specified, the general-purpose receive buffer size is set to "0" (default value).]

Items	Settings
S2	Destination unit IP address Specify the destination unit IP address of the setting start connection. Specify the keyword "IPv4=" at the beginning. <ul style="list-style-type: none"> In the case of IPv4 address, IPv4=111.122.133.144

34.2 F461 CONSET (Connection Setting)

Items	Settings
(Essential)	<p>* When specifying IPv4, 000.000.000.000 (0.0.0.0) cannot be specified.</p> <p>* When specified, CY flag (R9009) turns ON and "1" (IP address error) is set to DT90529, and the process is terminated.</p> <p>* An operation error does not occur. The setting is not made.</p>
Destination unit port No. (Essential)	<p>Specify the port No. (1 to 65535) of a destination unit.</p> <p>Specify the keyword "PORT=" at the beginning.</p> <p>PORT=xxxx</p>
Unused connection disconnect time (Essential)	<p>Specify unused connection disconnect time (0 to 4294967295, by 10 ms).</p> <p>When 0 is specified, automatic disconnection is not performed.</p> <p>Specify the keyword "DISCONT=" at the beginning.</p> <p>DISCONT=xxxx</p>
General-purpose receive buffer starting address (Can be omitted)	<p>When the operation mode of S1 is set to general-purpose communication, a general-purpose receive buffer starting address (DT0 to DT at maximum) can be set.</p> <p>Specify the keyword "BUFTOP=" at the beginning.</p> <p>BUFTOP = xxxx</p>
General-purpose receive buffer size (Can be omitted)	<p>When the operation mode of S1 is set to general-purpose communication, a general-purpose receive buffer size (0 to 2048) can be set.</p> <p>Specify the keyword "BUFSIZE=" at the beginning.</p> <p>BUFSIZE = xxxx</p>

(Note 1) Both upper and lower cases can be used for specifying keywords.

Setting example

Example 1	S2	"IPv4=192.255.2.10, PORT=9000, DISCONT=0"
Settings		Destination unit IP address: 192.155.2.10, Destination port No.: 9000, Unused connection disconnect time: 0
Example 2	S2	"IPv4=192.255.100.11, PORT=2500, DISCONT=50"
Settings		Destination unit IP address: 192.155.2.11, Destination port No.: 2500, Unused connection disconnect time: 50
Example 3	S2	"IPv4=192.168.1.5, PORT=4000, DISCONT=100, BUFTOP=DT4, BUFSIZE=256"
Settings		Destination unit IP address: 192.168.1.5; Destination port No.: 4000; Unused connection disconnect time: 100; General-purpose receive buffer starting address: DT4; General-purpose receive buffer size: 256

< When specifying Server >

- Perform setting by incrementing the master unit port No. by one from the setting start connection number to the setting end connection number. Unused connection disconnect time is not incremented.
- An error occurs when the port No. exceeds 65535 when incremented.
- When specifying for each connection, change the master unit port number to the one of other connection specified by the server. If the setting is duplicated, an operation error occurs.

34.2 F461 CONSET (Connection Setting)

- When the operation mode of S1 is set to general-purpose communication, a general-purpose receive buffer can be set.

Perform setting by adding a general-purpose receive buffer size to the general-purpose receive buffer starting address, from the setting start connection number to the setting end connection number.

When the range of DT (data register) is exceeded while adding a buffer size, an error will result.

- When the general-purpose receive buffer size is omitted, the general-purpose receive buffer starting address is set by adding a general-purpose receive buffer size of each connection that has already been specified.

[When none is specified, the general-purpose receive buffer size is set to "0" (default value).]

Items	Settings	
S2	Master unit port No. (Essential)	Specify the master unit port No. (1 to 65535) of the setting start connection. Specify the keyword "PORT=" at the beginning. PORT=xxxx
	Unused connection disconnect time (Essential)	Specify unused connection disconnect time (0 to 2147483647, by 10 ms). When 0 is specified, automatic disconnection is not performed. Specify the keyword "DISCONT=" at the beginning. DISCONT=xxxx
	General-purpose receive buffer starting address (Can be omitted)	When the operation mode of S1 is set to general-purpose communication, a general-purpose receive buffer starting address (DT0 to DT at maximum) can be set. Specify the keyword "BUFTOP=" at the beginning. BUFTOP = xxxx
	General-purpose receive buffer size (Can be omitted)	When the operation mode of S1 is set to general-purpose communication, a general-purpose receive buffer size (0 to 2048) can be set. Specify the keyword "BUFSIZE=" at the beginning. BUFSIZE = xxxx

Setting example

Example 1	S2	"PORT=9000, DISCONT=0"
Settings	Master unit port No.: 9000; Unused connection disconnect time: 0	
Example 2	S2	"PORT=10000, DISCONT=30000"
Settings	Master unit port No.: 10000; Unused connection disconnect time: 30000	
Example 3	S2	"PORT=10000, DISCONT=70"
Settings	Master unit port No.: 10000; Unused connection disconnect time: 70	
Example 4	S2	"PORT=4000, DISCONT=1000, BUFTOP=DT4, BUFSIZE=256"
Settings	Master unit port No.: 4000; Unused connection disconnect time: 100; General-purpose receive buffer starting address: DT4; General-purpose receive buffer size: 256	

■ OperandD1setting

- Specify either the device address storing a setting start connection number, or a constant.

Items	Settings	Setting range
D1	Setting start connection No.	Specify a setting start connection No. 1 to max. 9

■ OperandD2setting

- Specify either the device address storing a setting end connection number, or a constant.

Items	Settings	Setting range
D2	Setting end connection No.	Specify a setting end connection No. 1 to max. 9

■ Flag operations

Name	Description
R9007 R9008 (ER)	To be set when D1 is larger than D2 .
	Set when D1 and D2 exceed the number of user connection information settings.
	Set when the connection within the range specified by D1 and D2 includes the connection of a multi-connection server.
	Set when a value outside the range is specified for the parameter.
	Set when the same keyword is specified redundantly.
	Set when the unit specified with F469 UNITSEL is not Ethernet communication.
	Set when the lower one block of IP address exceeds the settable range when incremented.
	Set when the master unit port No. exceeds the settable range when incremented.
	Set when the settable range of the general-purpose receive buffer is exceeded.
	To be set when executed in an interrupt program.
	Set when the number of characters for operand specifying character constant exceeds 256.
	Set when the target connection is already receiving a setting request.
	Set when the same number as the master unit port number is used for other connection specified by the server during server connection setting.
R9009 (CY)	Set in the case of execution while IP address is incorrect. The detailed code to be set in DT90529 is "1: Incorrect IP address specification".
	To be set in the case of execution while IP address is unestablished. The detailed code to be set in DT90529 is "12: IP address unestablished".

(Note 1) For error codes stored in the special data register DT90529, refer to.

34.3 F462 OPEN (Connection Open)

34.3 F462 OPEN (Connection Open)

■ Instruction format

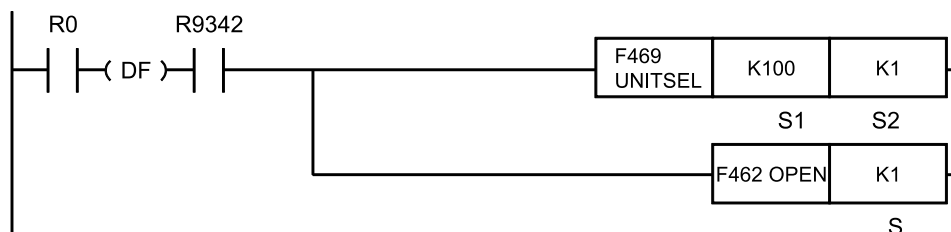

(Note 1) Specify S1=K100 (Ethernet communication) in advance using F469 UNITSEL instruction.

■ Operand

Items	Settings
S	Either the device address storing a connection number to be opened, or a constant.

■ Devices that can be specified (indicated by ●)

Operand	WX	WY	WR	WL	SV	EV	DT	LD	I	SW R	SDT	Constant			Index modifier (Note 1)
												K	H	M	
S	●	●	●	●	●	●	●	●	●	●	●	●	●	●	●

(Note 1) A character constant cannot be specified.

■ Outline of operation

- A communication line for connection specified by **S** is opened.
- When it is already open, no operation is performed.
- If connection use setting is set to "Not use", it is changed to "Use".
- The completion of open operation can be confirmed by the status (ON) of the clear to send flag for master communication or general-purpose communication.
- This instruction can be executed when the IP address established flag (R9342) is ON. As execution conditions for the instruction, insert a program to check the flag (R9342) state. If this instruction is executed when the flag (R9342) is OFF, a special relay R9009 (carry flag CY) is set, and no operation is performed.
- When the instruction is completed successfully, the special relay R9009 (carry flag CY) and the special data register DT90529 (Ethernet communication error code) are cleared.
- When connection processing is in progress, the special relay R9009 (carry flag CY) is set, and no operation is performed.
- To open the connection of a multi-connection server, specify the starting connection. If this instruction is executed for non-starting connection, an operation error occurs.

■ Precautions for programming

- Immediately before this instruction, insert F469 (UNITSEL) instruction, and specify the unit (Ethernet communication) and connection No.

- This instruction is not available in interrupt programs.

■ Operand S setting

Specify either the device address storing a connection number to be opened, or a constant.

Items	Settings		Setting range
S	Connection No.	Specify a connection No.	1 to 9

■ Flag operations

Name	Description
R9007 R9008 (ER)	Set when a value outside the range is specified for the parameter.
	Set when the unit specified with F469 UNITSEL is not Ethernet communication.
	Set when executed in an interrupt program.
R9009 (CY)	Set in the case of execution for connections other than the starting connection in a multi-connection server.
	To be set in the case of execution while IP address is unestablished. The detailed code to be set in DT90529 is "12: IP address unestablished".
	To be set in the case of execution during connection processing. The detailed code to be set in DT90529 is "14: Connection processing".

(Note 1) For error codes stored in the special data register DT90529, refer to .

34.4 F463 CLOSE (Connection Close)

34.4 F463 CLOSE (Connection Close)

■ Instruction format

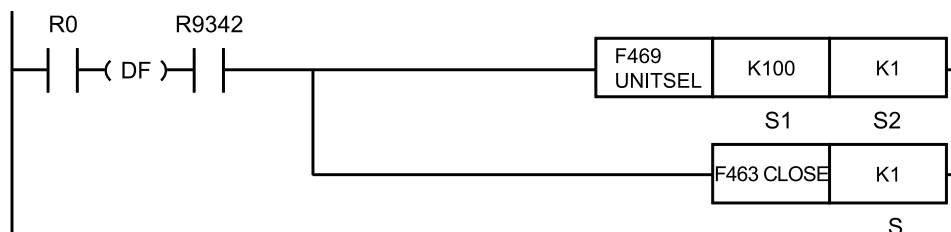

(Note 1) Specify S1=K100 (Ethernet communication) in advance using F469 UNITSEL instruction.

■ Operand

Items	Settings
S	Either the device address storing a connection number to be closed, or a constant.

■ Devices that can be specified (indicated by ●)

Operand	WX	WY	WR	WL	SV	EV	DT	LD	I	SW R	SDT	Constant			Index modifier (Note 1)
												K	H	M	
S	●	●	●	●	●	●	●	●	●	●	●	●	●	●	●

(Note 1) A character constant cannot be specified.

■ Outline of operation

- Close a specified connection.

■ Processing

- A communication line for connection specified by **S** is closed.
- When it is already closed, no operation is performed.
- If connection use setting is set to "Use", it is changed to "Not use".
- The completion of close operation can be confirmed by the status (OFF) of the clear to send flag for master communication or general-purpose communication.
- This instruction can be executed when the IP address established flag (R9342) is ON. As execution conditions for the instruction, insert a program to check the flag (R9342) state. If this instruction is executed when the flag (R9342) is OFF, a special relay R9009 (carry flag CY) is set, and no operation is performed.
- When the instruction is completed successfully, the special relay R9009 (carry flag CY) and the special data register DT90529 (Ethernet communication error code) are cleared.
- To close the connection of a multi-connection server, specify the starting connection. If this instruction is executed for non-starting connection, an operation error occurs.

■ Precautions for programming

- Immediately before this instruction, insert F469 (UNITSEL) instruction, and specify the unit (Ethernet communication) and connection No.
- This instruction is not available in interrupt programs.

■ Operand S setting

Specify either the device address storing a connection number to be closed, or a constant.

Items	Settings	Setting range
S	Connection No.	Specify a connection No. 1 to 9

■ Flag operations

Name	Description
R9007 R9008 (ER)	Set when a value outside the range is specified for the parameter.
	Set when the unit specified with F469 (UNITSEL) is not Ethernet communication.
	Set when executed in an interrupt program.
R9009 (CY)	Set in the case of execution for connections other than the starting connection in a multi-connection server.
	To be set in the case of execution while IP address is unestablished. The detailed code to be set in DT90529 is "12: IP address unestablished".
	To be set in the case of execution while connection is occupied. The detailed code to be set in DT90529 is "15: Connection occupied".

(Note 1) For error codes stored in the special data register DT90529, refer to .

34.5 F464 RDET (Ethernet Status Read)

34.5 F464 RDET (Ethernet Status Read)

■ Instruction format

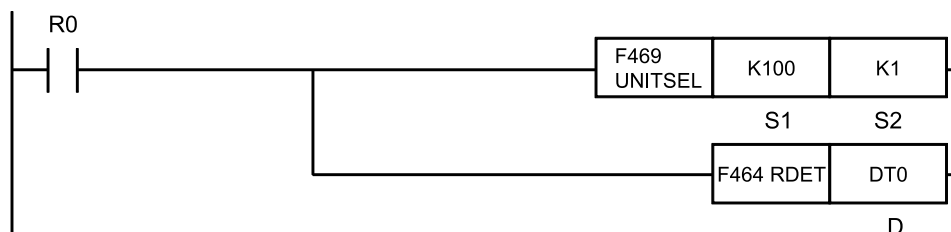

(Note 1) Specify S1=K100 (Ethernet communication) in advance using F469 UNITSEL instruction.

■ Operand

Items	Settings
D	Stored in the starting 7-word area (D to D+6) that stores status information.

■ Devices that can be specified (indicated by ●)

Operand	WX	WY	WR	WL	SV	EV	DT	LD	I	SW R	SDT	Constant			Index modifier (Note 1)
												K	H	M	
D		●	●	●	●	●	●	●	●						●

(Note 1) A character constant cannot be specified.

■ Outline of operation

- Acquire a status summary indicating the states of all Ethernet connections.
- Immediately before F464 (RDET) instruction, write F469 (UNITSEL) instruction to specify the target Ethernet port. Specify a given value as Connection No. in a range from 1 to 9.
- Acquired information is converted into a hexadecimal integer value according to allocation, and stored in a 7-word area starting with D.

■ Precautions for programming

- Based on F469 (UNITSEL) instruction, it is required to specify the slot No. and connection No. of the communication target Ethernet.

■ Ethernet status information

- Connection status of each connection
- OPEN status
- OPEN error status
- Number of connections while the FTP server is connected

■ Ethernet status information

Operands	Data name	Stored data	
D	Connection status summary	Lower word	0: Other than "Connected"
D+1		Higher word	1: Connected
D+2	OPEN status summary	Lower word	0: Close
D+3		Higher word	1: Open
D+4	OPEN error status summary	Lower word	0: Normal
D+5		Higher word	1: Error
D+6	Number of connections while the FTP server is connected	Stores the number of connections while the FTP server is connected.	

(Note 1) Bit correspondence with connections in Connection status summary, OPEN status summary, OPEN error status summary

Lower word															
b15	b14	b13	b12	b11	b10	b9	b8	b7	b6	b5	b4	b3	b2	b1	b0
-	-	-	K9	K8	K7	K6	K5	K4	K3	K2	K1	-	-	-	S1

Higher word															
b15	b14	b13	b12	b11	b10	b9	b8	b7	b6	b5	b4	b3	b2	b1	b0
-	-	-	-	-	-	-	FTP-S	-	-	-	-	-	-	-	-

(Note 1) S1: System connection

Kn: User connection

FTP-S : FTP server

■ Program example

Acquire all connection summaries for Ethernet communication, and store them in a 7-word area starting with [DT10].

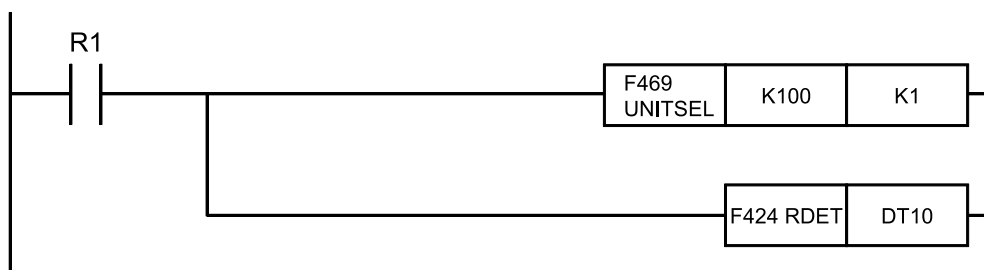

■ Flag operations

Name	Description
R9007	To be set when the range is exceeded during indirect access (index modification).
R9008	To be set when the destination range is outside the accessible range.

34.5 F464 RDET (Ethernet Status Read)

Name	Description
(ER)	When connection specified by F469 (UNITSEL) does not exist, or the value is outside the range
	The device to store parameters specified by D is incorrect.

34.6 F465 ETSTAT (EtherNet Information Acquisition)

■ Instruction format

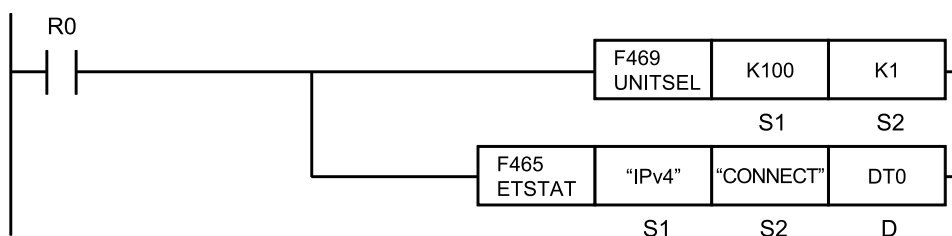

(Note 1) The figure above shows the case of specifying S1=K100 (Ethernet communication) and S2=K1 (connection No. 1) using F469 (UNITSEL) instruction.

(Note 2) By copying & pasting the the following text into the instruction list box of FPWIN GR7, the operand section of the program example above can be entered.

ETSTAT "IPv4" "CONNECT" DT0

■ Operands

Items	Settings
S1	Either the starting address of a device that stores string data representing the read type, or a character constant
S2	Either the starting address of a device that stores string data representing the read target, or a character constant
D	Starting address of read destination device

■ Devices that can be specified (indicated by ●)

Operands	WX	WY	WR	WL	SV	EV	DT	LD	I	SW R	SDT	Constant			Index modifier (Note 1)
												K	H	M	
S1	●	●	●	●	●	●	●	●	●					●	●
S2	●	●	●	●	●	●	●	●	●					●	●
D			●	●	●	●	●	●	●						●

(Note 1) A character constant cannot be specified.

■ Outline of operation

- Reads information of the Ethernet unit.

■ Processing

- Read the parameter information or status information specified by **S1** and **S2**, and store it in the area starting with **D**.
- The number of words in the storage area varies according to the type of read data and the target.

34.6 F465 ETSTAT (EtherNet Information Acquisition)

■ Precautions for programming

- Immediately before this instruction, insert F469 (UNITSEL) instruction, and specify the unit (Ethernet communication) and connection No.
- In **S1** and **S2**, specify either the starting address of a device that stores string data representing information to be read, or a character constant. When specifying a device for an operand, set string data using F253 (SSET) instruction in advance. Both upper case and lower case can be used. "Abcd", "ABCD" and "abcd" are all synonymous.
- When specifying string data, the number of characters should not exceed 256.
- This instruction is not available in an interrupt program.

■ Operands **S1/S2** setting

Items	Settings		
S1	Read type	When specifying reading IPv4 address	Specify "IPv4"
S2	Read target	When specifying reading MAC address	Specify "MAC"
		When specifying reading destination IP address	Specify "CONNECT"
		When specifying reading destination IP address and port number	Specify "CONNECT1"
		When specifying reading IP address and port number of the destination unit currently connected	Specify "CONNECT2"
D	Read destination	Specify the destination device address into which the status should be read.	

■ Restrictions on the combination of operands **S1** and **S2**

When **S1** is IPv4, **S2** can be specified as one of the following. An operation error occurs when other combinations are specified.

- MAC
- CONNECT
- CONNECT1
- CONNECT2

■ Data and number of words to be read

Data and number of words to be read vary depending on the combination of **S1** and **S2**.

S1S2	Storage destination	Name	Number of words	Format	Description
S1 : "IPv4" S2 : "MAC"	D to D+3	Master unit IP address (IPv4)	4	Decimal	Master unit IPv4 address
	D+4 to D+7	Subnet mask (IPv4)	4	Decimal	Subnet mask
	D+8 to D+11	Default gateway (IPv4)	4	Decimal	Default gateway
	D+12 to D+14	Master unit MAC address	3	Hexadecimal	Master unit MAC address
	Total number of words			15	

34.6 F465 ETSTAT (EtherNet Information Acquisition)

S1S2	Storage destination	Name	Number of words	Format	Description
S1: "IPv4" S2: "CONNECT"	DtoD+3	Master unit IP address (IPv4)	4	Decimal	Master unit IPv4 address
	D+4toD+7	Subnet mask (IPv4)	4	Decimal	Subnet mask
	D+8toD+11	Default gateway (IPv4)	4	Decimal	Default gateway
	D+12	Destination IP address type	1	Decimal	0: IPv4
	D+13toD+16	Destination IP address	4	Decimal	Destination IP address (in the case of IPv4)
	Subtotal number of words			17	

(Note 1) In the case of IPv4, a decimal value is stored in each storage area.

Example) When the master unit IP address is 192.168.1.5, the value is stored as follows.

D = K192, D+1 = K168, D+2 = K1, D+3 = K5

■ Example of execution

Example1) When specifying IPv4 address and MAC address

Stored in a 15-word area starting with D

S1... "IPv4" S2... "MAC" D...DT0

	Value	Description
DT0	H00C0 (K192)	The master unit IPv4 address is stored. Example) In the case of 192.168.5.30:
DT1	H00A8 (K168)	
DT2	H0005 (K5)	
DT3	H001E (K30)	
DT4	H00FF (K255)	The subnet mask is stored. Example) In the case of 255.255.255.0:
DT5	H00FF (K255)	
DT6	H00FF (K255)	
DT7	H0000 (K0)	
DT8	H00C0 (K192)	Default gateway Example) In the case of 192.168.5.1:
DT9	H00A8 (K168)	
DT10	H0005 (K5)	
DT11	H0001 (K1)	
DT12	H0918	The master unit MAC address is stored. Example) In the case of 00-C0-8F-64-09-18:
DT13	H8F64	
DT14	H00C0	

Example 2) When specifying IPv4 address and the destination IP address of a specified connection

Stored in a 17-word area starting with D

S1... "IPv4" S2... "CONNECT" D...DT0

34.6 F465 ETSTAT (EtherNet Information Acquisition)

	Value	Description
DT0	H00C0 (K192)	The master unit IPv4 address is stored. Example) In the case of 192.168.5.30:
DT1	H00A8 (K168)	
DT2	H0005 (K5)	
DT3	H001E (K30)	
DT4	H00FF (K255)	The subnet mask is stored. Example) In the case of 255.255.255.0:
DT5	H00FF (K255)	
DT6	H00FF (K255)	
DT7	H0000 (K0)	
DT8	H00C0 (K192)	Default gateway Example) In the case of 192.168.5.1:
DT9	H00A8 (K168)	
DT10	H0005 (K5)	
DT11	H0001 (K1)	
DT12	H0000	Indicates an IP address type. The value becomes "0" in the case of IPv4.
DT13	H00C0 (K192)	The destination IPv4 address is stored. Example) In the case of 192.168.5.1:
DT14	H00A8 (K168)	
DT15	H0005 (K5)	
DT16	H000B (K11)	

■ Flag operations

Name	Description
R9007 R9008 (ER)	Set when the read area is outside the range.
	Set when other than "IPv4" is specified for the read type (S1).
	Set when other than "MAC" or "CONNECT", "CONNECT1", "CONNECT2" is specified for the read target (S2).
	Set when the unit specified with F469 (UNITSEL) is not Ethernet communication.
	Set when executed in an interrupt program.

34.7 P466 NTPcREQ (Time Adjustment Request)

The P466 NTPcREQ instruction can be used with the unit firmware Ver. 1.80 or later.

■ Instruction format

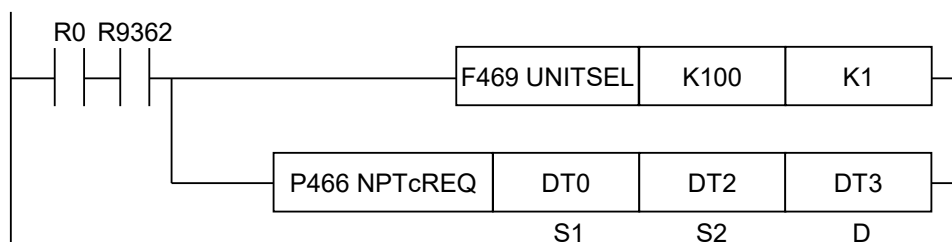

(Note 1) The figure above shows the case of specifying K1=U100 (Ethernet communication) and S2=K1 (connection No. 1) using the UNITSEL instruction.

■ Operand

Items	Settings
S1	Specify the number of times of request processing. (Settable range: 0 to 20 times)
S2	Specify the interval of request processing. (Settable range: 16 to 600 seconds)
D	Specify the starting address storing the execution result of time adjustment. HFFF: In progress, H0: Normal termination, H1: Request error, H2: Communication error, H3: Response error

■ Devices that can be specified (indicated by ●)

Operand	WX	WY	WR	WL	SV	EV	DT	LD	I	SW R	SDT	Constant			Index modifier (Note 1)
												K	H	M	
S1	●	●	●	●	●	●	●	●	●			●	●		●
S2	●	●	●	●	●	●	●	●	●			●	●		●
D	●	●	●	●	●	●	●	●	●						●

(Note 1) A character constant cannot be specified.

■ Outline of operation

- Requests a time adjustment.

■ Processing

- Set the number of processing times for time adjustment in **S1**.
If the time adjustment timeout is predicted, add the number of times of retransmission.
- Cannot be used while obtaining the NTP time.
- For canceling the time adjustment retransmission, set the number of processing times to 0.
If the retransmission is canceled while no time adjustment is made, the result is not stored in the execution result **D**.
- Set the time adjustment processing interval for time adjustment in **S2**.

34.7 P466 NTPcREQ (Time Adjustment Request)

- Store the execution result of the time adjustment in the area starting with **D**.
- Set the time adjustment timeout using **F467 NTPcSV instruction or Ethernet setting>SNTP>Timeout period**.

If the number of processing times is set to more than one, the next request is started after an elapse of the timeout period + processing interval **S2** seconds.

- The total time adjustment timeout period is $S1 * \text{timeout} + (S2 * (S1 - 1))$ seconds. (Note that **S1** must be larger than 0.)

■ Program example

- In this example, a request for time adjustment is made to user connection No. 1.
- The most significant bit of the execution result code can be used as an active flag

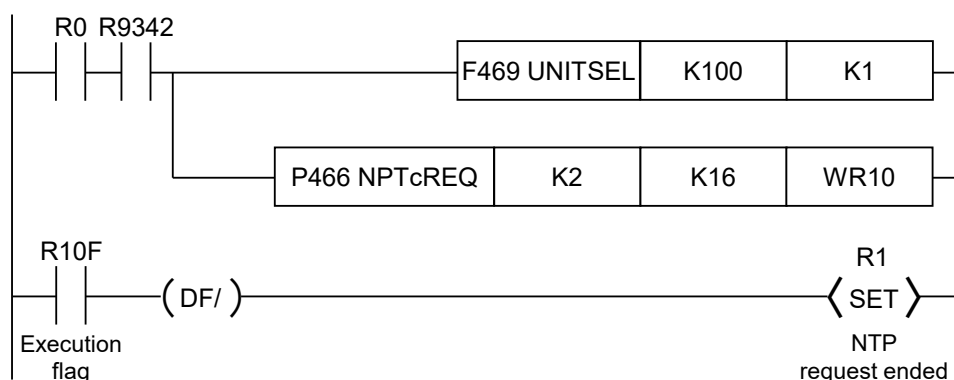

■ Precautions for programming

- Use the F469 (UNITSEL) instruction to specify the unit.
- Before executing this instruction, it is necessary to set "SNTP server address" by selecting **Ethernet setting>SNTP**. Note that the instruction is not influenced by the following setting items.
 - Automatic retrieval from the SNTP server
 - No. of retries
 - Retry interval
- If an Ethernet task is initialized (R9341 ON) while a time adjustment request is made, 0s are entered in the result storage destination **D**.
- If a time adjustment is made continuously, further access may be prohibited by the server. So, be careful not to make the adjustment continuously.
- If this instruction is executed while the SNTP request is executed according to the settings made by **Ethernet setting>SNTP>Time acquisition timing**, a new request is started from the time when the instruction is executed.
- If the elapsed time has reached the time set by **Ethernet setting>SNTP>Time acquisition timing** while this instruction is executed, execution of this instruction has higher priority.
- The SNTP request made by **Ethernet setting>SNTP>Automatic retrieval from the SNTP server** can be aborted by canceling the time adjustment retransmission of this instruction.
- Even when the number of processing times = 0, assess if the processing interval set value is in a normal range. Set a value within a normal range.
- The NTP time adjustment process performed by executing this instruction continues even after the PLC mode changes from RUN to PROG.

■ Execution result codeD

- In the case of a request error (10 to 15), the time adjustment request set when the instruction is executed is aborted.
- The communication error (20) occurs when no response is returned from the server after time adjustment is requested.
(“No response” here means that no response is returned even when the request is repeated for the specified number of processing times.)
- The response error (30) occurs when no response is returned from the Ethernet task (from the communication CPU side).

Code	Execution result	
H0	Normal end	
H10	Double startup error	The time adjustment request instruction is already in progress. ^(Note 1)
H11	SNTP server address setting error	Ethernet setting SNTP server address setting = "0.0.0.0"
H12	Disconnection error	Ethernet is in a disconnected state. (R9340 ON)
H13	Ethernet initialization in progress error	Ethernet initialization is in progress. (R9341 ON)
H14	Number of processing times setting error	The specified number of processing times is out of the range.
H15	Processing interval setting error	The specified processing interval is out of the range.
H20	Response timeout error	The time adjustment response exceeds the specified time. ^(Note 2)
H30	Ethernet task response timeout	This error occurs when no response is returned from the Ethernet task (from the communication CPU side).

(Note 1) The instruction with the number of processing times set to 0 to cancel the time adjustment request instruction does not cause a double startup error.

Note, however, that the instruction will cause a double startup error if the execution result storage destination does not match.

(Note 2) This error also occurs if the NTP IP address is unresolved.

■ Example of processing

Example 1) Time adjustment request → Time is being adjusted. → Time adjustment retrieval is normally ended.

[S1]...K1 [S2]...K16 [D]...DT10

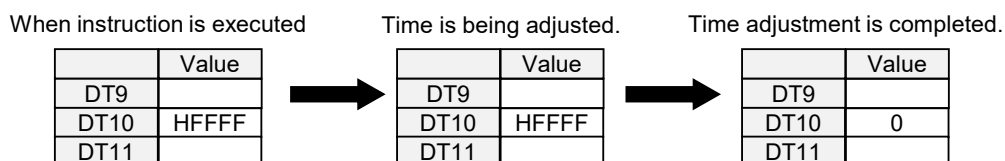

Example 2) When a response timeout has occurred in the time adjustment

[S1]...K3 [S2]...K16 [D]...DT10 timeout period...3 seconds

34.7 P466 NTPcREQ (Time Adjustment Request)

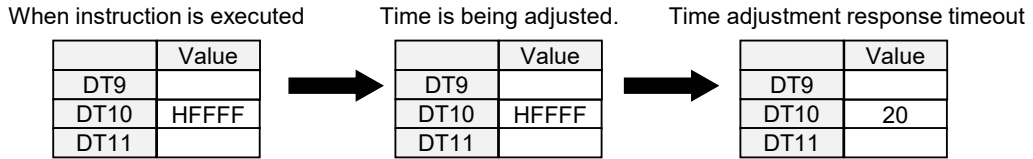

Timeout in $41 \text{ seconds} \times S1 + (S2 \times (S1 - 1))$ seconds

- Total timeout period = 3 seconds × 3
- Processing interval = 16 seconds × (3-1)

Example 3) When the time adjustment request ends abnormally (Ethernet initialization in progress error)

[S1]...K2 [S2]...K16 [D]...DT10

When instruction is executed

	Value
DT9	
DT10	13
DT11	

Example 4) When the time adjustment request ends abnormally (Number of processing times setting error)

[S1]...K21 [S2]...K16 [D]...DT10

When instruction is executed

	Value
DT9	
DT10	14
DT11	

■ Cancellation of the time adjustment request

- When the number of processing times is set to zero and the time adjustment request instruction is executed, the request during the execution of the time adjustment request is canceled.
- The request is immediately canceled even while data is being acquired from the NTP.
- This process cancellation applies only to canceling the request process. This process cancellation does not cancel the response waiting (timeout period) state to the NTP request.
- The following section explains an example where the time adjustment request instruction is executed with the number of processing times (**S1**) set to 2.

1) Normal execution

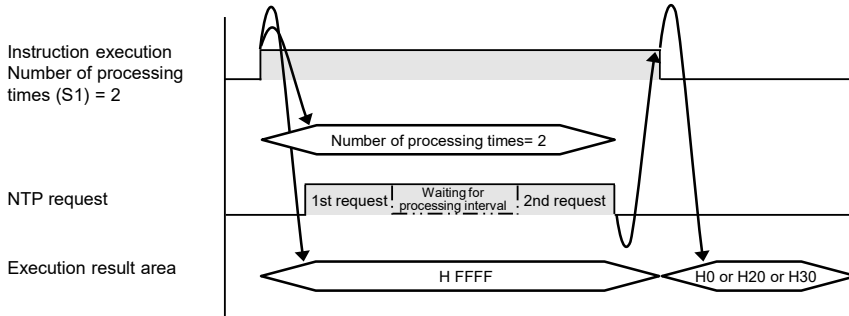

2) Process cancellation while the NTP request is being made

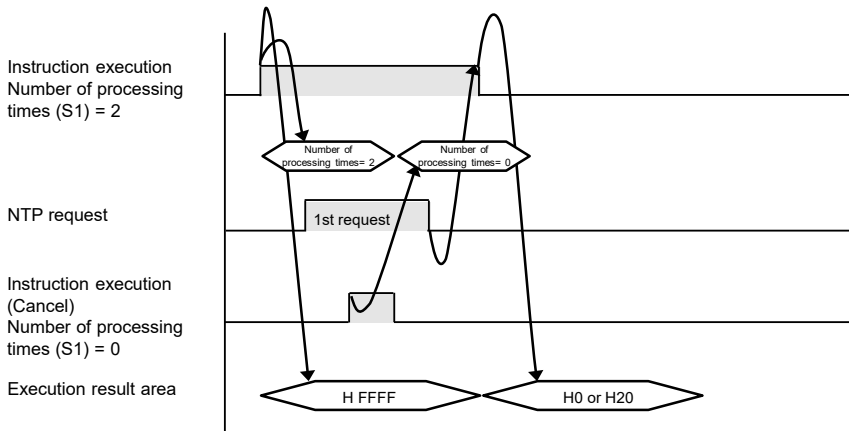

3) Process cancellation while waiting for the processing interval within the NTP request

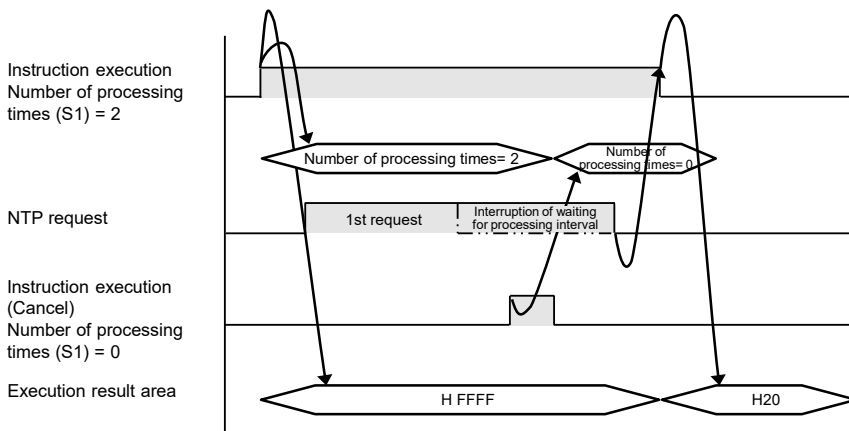

34.7 P466 NTPcREQ (Time Adjustment Request)

■ Flag operations

Name	Description
R9007	Turns ON when the area is exceeded in index modification.
R9008	Set when the unit specified by F469 UNITSEL is not the built-in Ethernet unit.
(ER)	Set when executed in an interrupt program.

34.8 F467 NTPcSV (NTP Destination Server Setting)

The F467 NTPcSV instruction can be used with the unit firmware Ver. 1.80 or later.

■ Instruction format

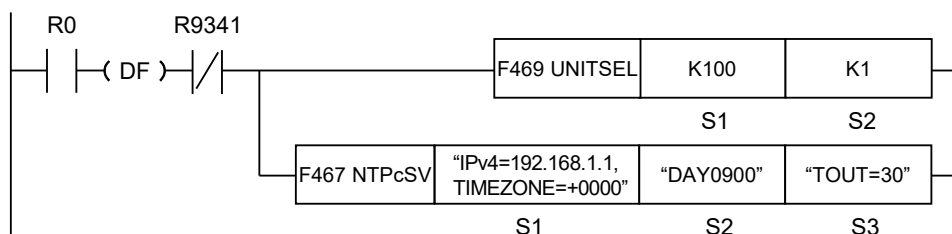

(Note 1) The figure above shows the case of specifying S1=K100 (Ethernet communication) and S2=K1 (connection No. 1) using the UNITSEL instruction.

■ Operand

Items	Settings
S1	Specify the starting address of the device storing the server specification parameter or a character constant.
S2	Specify the starting address storing the time acquisition timing setting parameter or a character constant.
S3	Specify the starting address of the device storing the detailed setting parameter or a character constant.

■ Devices that can be specified (indicated by ●)

Operand	WX	WY	WR	WL	SV	EV	DT	LD	I	SW R	SDT	Constant			Index modifier (Note 1)
												K	H	M	
S1	●	●	●	●	●	●	●	●	●					●	●
S2	●	●	●	●	●	●	●	●	●					●	●
S3	●	●	●	●	●	●	●	●	●					●	●

(Note 1) A character constant cannot be specified.

■ Processing

- Sets the destination NTP server and time zone to send the time adjustment request.
- Sets the NTP server address and the time zone according to **S1**.
 - * The Ethernet configuration data will never be rewritten.
- It is executable when the Ethernet initialization in progress (R9341) is OFF. If it is ON when executing the instruction, an error is set to CY flag and no operation is performed.
- Sets the time acquisition request timing according to **S2**.
- Sets the detailed settings according to **S3**.

34.8 F467 NTPcSV (NTP Destination Server Setting)

- If the settings have already been made by the Ethernet configuration data, the data becomes invalid. The NTP time acquisition request is executed at the timing specified by this instruction.
- The settings remain valid until the power is turned OFF.
Even when the settings are changed by the following operation, they remain valid until the mode is changed from the PROG mode to the RUN mode.
 - Downloading project
 - Writing Ethernet configuration data
 - Releasing the upload-protection by compulsion
 - Executing "Forcibly disable security"
- The settings will not be lost even when the IPv4SET instruction is executed.

■ Setting of operandS1

Specify the starting address of the device storing the server specification parameter or a character constant.

- A part of parameters can be omitted. The settings are not changed when parameters are omitted partially.
- When omitting the part before a specified keyword, omit only "keyword" without omitting commas (",").
- When omitting the part after a specified keyword, omit both commas (",") and "keyword".
- It is prohibited to specify the same keyword redundantly. An error is caused in the case of redundant specification.

Setting item	Description
IP address or host name of NTP server (Can be omitted)	Specify IP address or host name. For the IP address, specify the keyword "IPv4=" at the beginning. For the host name, specify "HOST=". * Be careful that the number of characters including the keyword ("IPv4=" or "HOST=") does not exceed 68. <ul style="list-style-type: none"> • For IPv4: IPv4 = 111.122.133.144 • For the host name: "HOST=ntp.pidsx.com"
Time zone setting (Can be omitted)	Specify the time zone in the following format: "dHHMM" (d: "+" or "-", HH: hours "00 to 24", MM: minutes "00 to 59") Specify the keyword "TIMEZONE=" at the beginning. <ul style="list-style-type: none"> • For GMT+09:00 (Osaka, Sapporo, Tokyo): "TIMEZONE=+0900" • For GMT-10:00 (Hawaii): "TIMEZONE=-1000" • For GMT 00:00 (Greenwich Mean Time): "TIMEZONE=+0000"

(Note 1) Separate "NTP server IP address or host name" and "time zone setting" with "" (commas) to input them.

(Note 2) Specify the parameters for specifying servers in the order of the above table. Both upper and lower cases can be used for specifying keywords.

Setting example

Example 1	S1	"IPv4=111.122.133.144,TIMEZONE=+0900"
	Settings	NTP server (Ipv4): 111.122.133.144, Time zone: GMT+09:00
Example 2	S1	"HOST=ntp.pidsx.com"
	Settings	NTP server (host name): ntp.pidsx.com, Time zone: Not change
Example 3	S1	",TIMEZONE=+0900"
	Settings	NTP server (Ipv4): Not change, Time zone: GMT+09:00

Example 4	S1	""
	Settings	NTP server (Ipv4): Not change, Time zone: Not change

■ Setting of operandS2

Specify the starting address storing the time acquisition timing setting parameter or a character constant.

- A part of parameters can be omitted. The settings are not changed when parameters are omitted partially.
- When omitting the part before a specified keyword, omit only "keyword" without omitting commas (",").
- When omitting the part after a specified keyword, omit both commas (",") and "keyword".
- It is prohibited to specify the same keyword redundantly. An error is caused in the case of redundant specification.

Setting item	Settings
Specified time once a day (Can be omitted)	Time data acquisition timing: Once a day at a specified time. DAY=DISABLE: Not set DAY=HHMM: Set HH: hours "00 to 23", MM: minutes "00 to 59"
Specified day of the week once a week (Can be omitted)	Time data acquisition timing: Once a week at a specified day of the week and time. WEEK=DISABLE: Not set WEEK=HHMM: Set W: 0 (Sunday) to 6 (Saturday), HH: hours "00 to 23", MM: minutes "00 to 59"
Specified date and time once a month (Can be omitted)	Time data acquisition timing: Once a month at a specified date and time. MONTH=DISABLE: Not set MONTH=DDHHMM: Set DD: "01 to 28", HH: hours "00 to 23", MM: minutes "00 to 59"

(Note 1) Separate "Specified time once a day", "Specified day of the week once a week", "Specified date and time once a month" with "," (commas) to input them.

(Note 2) The time data acquisition timing cannot be set when power is turned ON.

(Note 3) Specify the parameters in the order of the above table. Both upper and lower cases can be used for specifying keywords.

(Note 4) After this instruction is executed:

If one of the settings "Specified time once a day", "Specified day of the week once a week", and "Specified date and time once a month" is set to "Set", set to "Use automatic retrieval from the SNTP server as a method to acquire time data".

If one of the settings "Specified time once a day", "Specified day of the week once a week", and "Specified date and time once a month" is set to "Set", set to "Do not use automatic retrieval from the SNTP server as a method to acquire time data".

Setting example

Example 1	S2	"DAY=1234,WEEK=62345,MONTH=010010"
	Settings	Specified time once a day: Once a day at 12:34 once , Specified day of the week once a week: Once a week on Saturday at 23:45, Specified date and time once a month: Once a month on the first day at 0:10
Example 2	S2	"DAY=1234"
	Settings	Specified time once a day: Once a day at 12:34 once , Specified day of the week once a week: Not changed, Specified date and time once a month: Not changed

34.8 F467 NTPcSV (NTP Destination Server Setting)

Example 3	S2	"WEEK=01234"
	Settings	Specified time once a day: Not change, Specified day of the week once a week: Once a week on Sunday at 12:34, Specified date and time once a month: Not change
Example 4	S2	“,MONTH=112233"
	Settings	Specified time once a day: Not change, Specified day of the week once a week: Not change, Specified date and time once a month: Once a month on the 11th day at 22:33
Example 5	S2	"DAY=DISABLE,WEEK=DISABLE,MONTH=282356"
	Settings	Specified time once a day: Not changed (Setting disabled) , Specified day of the week once a week: Not changed (Setting disabled), Specified date and time once a month: Once a month on the 28th day at 23:56
Example 6	S2	""
	Settings	Specified time once a day: Not changed , Specified day of the week once a week: Not changed, Specified date and time once a month: Not changed

■ Setting of operandS3

Specify the starting address storing the detailed setting parameter or a character constant.

- A part of parameters can be omitted. The settings are not changed when parameters are omitted partially. When omitting all the parameters after the specified parameter, omit both "," and "keyword".
- When omitting the part before a specified keyword, omit only "keyword" without omitting commas (",").
- When omitting the part after a specified keyword, omit both commas (",") and "keyword".
- When specifying "INITIAL" or "KEEP" without specifying parameters, the unit operates according to the table of special keywords.
- It is prohibited to specify the same keyword redundantly. An error is caused in the case of redundant specification.

Setting item	Description	Default
Timeout period (Can be omitted)	Specify a timeout period. (30 to 300) × 100 ms TOUT=: Time setting	60 (6 seconds)
No. of retries (Can be omitted)	Specify the number of retries. (0 to 3) RTRY=: No. of retries	3 (times)
Retry interval (Can be omitted)	Specify the retry interval. (1 to 8640) × 10 seconds RTTM=: Retry interval	60 (600 seconds)

(Note 1) Separate "timeout period", "number of retries", and "retry interval" with "," (commas) to input them.

(Note 2) Specify the detailed setting parameters in the order of the above table. Both upper and lower cases can be used for specifying keywords.

Setting example

Example 1	S3	"TOUT=30,RTRY=2,RTTM=50"
	Settings	Timeout period: 3 seconds, No. of retries: 2, Retry interval: 500 seconds
Example 2	S3	"TOUT=270,RTRY=0,RTTM=490"
	Settings	Timeout period: 27 seconds, No. of retries: 0 (Not retry), Retry interval: 4900 seconds

34.8 F467 NTPcSV (NTP Destination Server Setting)

Example 3	S3	"TOUT=12,RTRY=3"
	Settings	Timeout period: 1.2 seconds, No. of retries: 3, Retry interval: Not change
Example 4	S3	",RTRY=3,RTTM=300"
	Settings	Timeout period: Not change, No. of retries: 3, Retry interval: 3000 seconds

■ Special keywords for operandS3

Special keyword	Description
"INITIAL"	Set an initial value.
"KEEP"	The current setting is not changed.

Setting example

Example 1	S3	"INITIAL"
	Settings	Timeout period: 6 seconds, No. of retries: 3, Retry interval: 600 seconds
Example 2	S3	"KEEP"
	Settings	Timeout period: Not change, No. of retries: Not change, Retry interval: Not change

■ Precautions for programming

- This instruction is not available in interrupt programs.
- Cannot be used while obtaining the NTP time.
- When specifying a device for an operand which can specify character constants, set string data using F253 (SSET) instruction in advance.
- Upper and lower case characters can be used for operands where character constant can be specified.
- A target unit for the instruction is specified with F469 (UNITSEL) beforehand.

■ Flag operations

Name	Description
R9007 R9008 (ER)	Set when a value outside the range is specified for the parameter.
	Set when the unit specified by F469 (UNITSEL) is not the built-in Ethernet unit.
	Set when executed in an interrupt program.
	To be set while acquiring the time of NTP.
R9009 (CY)	Set when the instruction is the initialization of Ethernet. The detailed code to be set in DT90529 is"11: Ethernet initialization in progress".

34.9 P468 PINGREQ (PING Send Request)

34.9 P468 PINGREQ (PING Send Request)

The P468 PINGREQ instruction can be used with the unit firmware Ver. 1.80 or later.

■ Instruction format

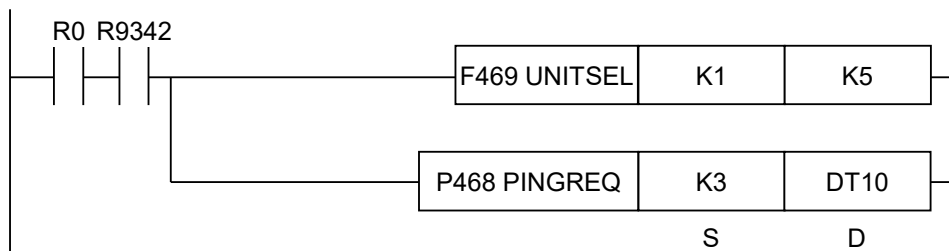

(Note 1) The figure above shows the case of specifying K1=U100 (Ethernet communication) and S2=K5 (connection No. 5) using the UNITSEL instruction.

■ Operand

Items	Settings
S	Specify the number of PING send requests. (Settable range: 1 to 10 times)
D	Specify the starting address of the storage device address for PING request results.

■ Devices that can be specified (indicated by ●)

Operand	WX	WY	WR	WL	SV	EV	DT	LD	I	SW R	SDT	Constant			Index modifier (Note 1)
												K	H	M	
S	●	●	●	●	●	●	●	●	●			●	●		●
D	●	●	●	●	●	●	●	●	●						●

(Note 1) A character constant cannot be specified.

■ Outline of operation

- Requests to send PING for the number of times specified by **S** to the destination unit IP address of the specified connection.

■ Processing

- Stores the request result of the PING in the area starting with **D**.
- The timeout period of the PING response per time is one second (fixed).
- The transmission data size is fixed to 56 bytes.
- If an Ethernet task is initialized (R9341 ON) while a PING request is made, 0s are entered in the result storage destination **D**.

■ Program example

- In the following example, a PING request is made three times to user connection No. 5.
- The most significant bit of the execution result code can be used as an active flag

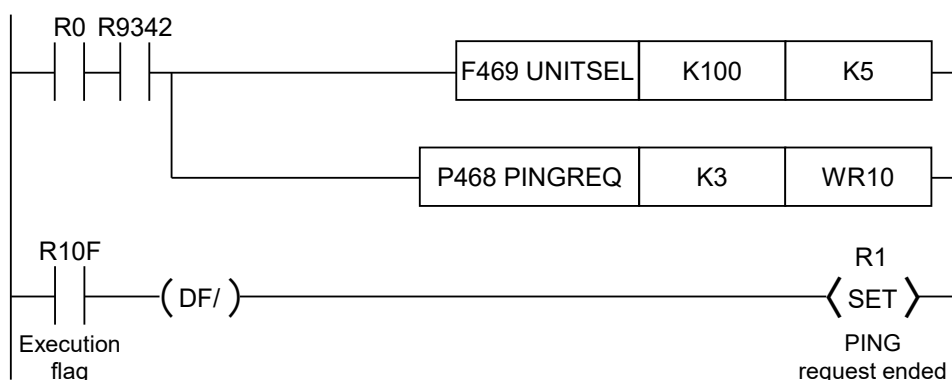

■ Precautions for programming

- Use the F469 (UNITSEL) instruction to specify the connection.
- If the destination unit IP address is not set, an error occurs.
- Use the F465 (ETSTAT) instruction to check the IP address of the PING request destination.
- The PING send process performed by executing this instruction continues even after the PLC mode changes from RUN to PROG.

■ Execution result storage area [D] to [D+5]

Request result storage area	Execution result	Description
D	Execution result code	0xffff: In progress, 0: Normal termination, 1x: Request error, 2x: Response error
D+1	No. of transmissions	
D+2	No. of responses	
D+3	Response time (ms) max.	0 to 1000 (ms)
D+4	Response time (ms) min.	The "Response time (ms) max." and "Response time (ms) min." are in 10 ms units and 0 is displayed for values smaller than 10 ms.
D+5	Response time (ms) average	

■ Execution result code D

- In the case of a request error (10 to 15), the PING request set when the instruction is executed is aborted.
- The response error (20) occurs when no response is returned from the Ethernet unit.

Code	Execution result	
H0	Normal end	
H10	Double startup error	PING request instruction is being executed.
H11	Number of requests to send error	The number of requests to send is not within the settable range (1 to 10).
H12	Ethernet unit unselected error	The unit selected by F469 UNITSEL is not the built-in Ethernet .

34.9 P468 PINGREQ (PING Send Request)

Code	Execution result	
H14	Disconnection error	Ethernet is in a disconnected state. (R9340 ON)
H15	Ethernet initialization in progress error	Ethernet initialization is in progress. (R9341 ON)
H20	Ethernet task response timeout	This error occurs when no response is returned from the Ethernet task (from the communication CPU side).

■ Example of processing

Example 1) For when the number of requests to send was 1, a PING request was made. → Sent. → Response ended normally (with the response time of 10 ms).

[S]...K1 [D]...DT10

When instruction is executed PING is being transmitted. PING response is completed.

	Value			Value		Value
DT9		→	DT9		→	DT9
DT10	0xffff		DT10	0xffff		DT10
DT11	0		DT11	0		DT11
DT12	0		DT12	0		DT12
DT13	0		DT13	0		DT13
DT14	0		DT14	0		DT14
DT15	0		DT15	0		DT15
DT16			DT16			DT16

Example 2) For when the number of requests to send was 3, PING requests were made. → Sent. → Response ended normally (with the response time of 0, 10 and 20 ms for the respective request).

[S]...K3 [D]...DT10

When instruction is executed PING is being transmitted. PING response is completed.

	Value			Value		Value
DT9		→	DT9		→	DT9
DT10	0xffff		DT10	0xffff		DT10
DT11	0		DT11	0		DT11
DT12	0		DT12	0		DT12
DT13	0		DT13	0		DT13
DT14	0		DT14	0		DT14
DT15	0		DT15	0		DT15
DT16			DT16			DT16

Example 3) For when the number of requests to send was 3, PING requests were made and one timeout occurred (with the response time of 10 and 20 ms for the respective request).

[S]...K3 [D]...DT10

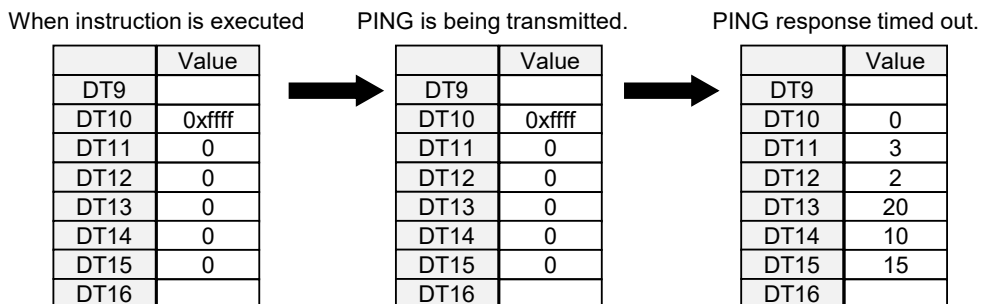

Example 4) For the number of requests to send of 1, the PING request ended abnormally (when disconnection was detected).

[S]...K1 [D]...DT10

When instruction is executed

	Value
DT9	
DT10	13
DT11	0
DT12	0
DT13	0
DT14	0
DT15	0
DT16	

■ Flag operations

Name	Description
R9007	Set when the range (D to D+5) is outside the accessible range.
R9008	Turns ON when the area is exceeded in index modification.
(ER)	Set when executed in an interrupt program.

34.10 F469 UNITSEL (Specify Communication Unit Slot Port)

34.10 F469 UNITSEL (Specify Communication Unit Slot Port)

■ Instruction format

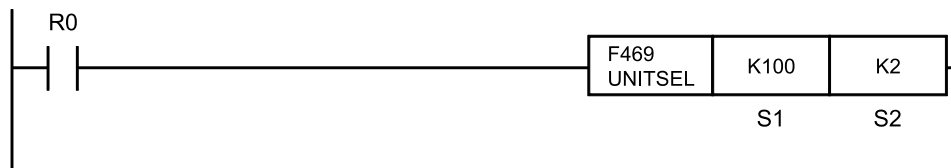

■ Operands

Items	Settings
S1	Unit slot No.
S2	COM port No. or user connection No.

■ Devices that can be specified (indicated by ●)

Operands	WX	WY	WR	WL	SV	EV	DT	LD	I	SW R	SDT	Constant			Index modifier (Note 1)
												K	H	M	
S1	●	●	●	●	●	●	●	●	●	●	●	●	●		●
S2	●	●	●	●	●	●	●	●	●	●	●	●	●		●

(Note 1) A character constant cannot be specified.

■ Outline of operation

- Write and specify the target of each instruction immediately before the following Ethernet communication instructions.

F145 SEND, F146 RECV, F159 MTRN, F460 IPv4SET, F461 CONSET, F462 OPEN, F463 CLOSE, F464 RDET, F465 ESTART, F470 FTPcSV, F471 FTPcSET, F472 FTPcLOG, F473 FTPcREQ, F474 FTPcCTL

- In the case of Ethernet communication, specify a slot No. (K100: LAN port) in **S1** and a connection No. in **S2**.
- Acquire the slot model specified in **S1**, and check that the communication port No. specified in **S2** falls within the settable range. When it does not, an error will result.

■ Specify S1 and S2

- Specify the unit slot No. for **S1**. The setting value of **S1** is stored in the special data register DT90890.
- Specify the communication port for **S2**. (In the case of Ethernet communication: Connection No.) The setting value of **S2** is stored in the special data register DT90891.

Unit type	S1 Slot No.	S2 COM port No. User connection No.
Serial communication	K0	K0 to K2 (Note 1)
Ethernet communication	K100	K1 to K9

34.10 F469 UNITSEL (Specify Communication Unit Slot Port)

(Note 1) For serial communication, specify the COM port (COM0 to COM2).

■ Program example

Example) User connection 2 is specified in Ethernet communication

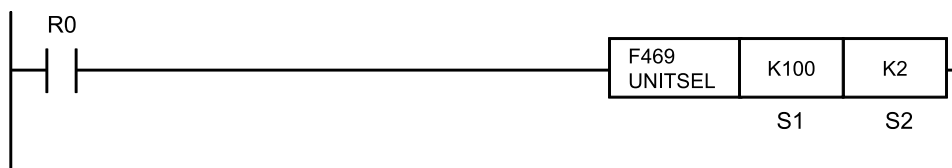

■ Flag operations

Name	Description
R9007	To be set when the range is exceeded during indirect access (index modification).
R9008	When the slot specified by S1 does not exist (slot No. is outside the range)
(ER)	When the connection specified by S2 does not exist (connection No. is outside the range)

(MEMO)

35 EtherNet/IP Instructions

35.1 F465 ETSTAT (EtherNet/IP Information Acquisition)	35-2
35.2 F490 EIPNDST (EtherNet/IP node status acquisition instruction)	35-9
35.3 F495 EIPMSATT (EIP message destination settings)	35-13
35.4 F496 EIPMBODY (EIP message body setting).....	35-16
35.5 F497 EIPMSEND (EIP message sending).....	35-19
35.6 F498 CIPMSET [CIP message data generation (combination)]	35-23
35.7 F499 CIPMGET (data acquisition from CIP message)	35-28
35.8 CIP Status Codes	35-34

35.1 F465 ETSTAT (EtherNet/IP Information Acquisition)

35.1 F465 ETSTAT (EtherNet/IP Information Acquisition)

■ Instruction format

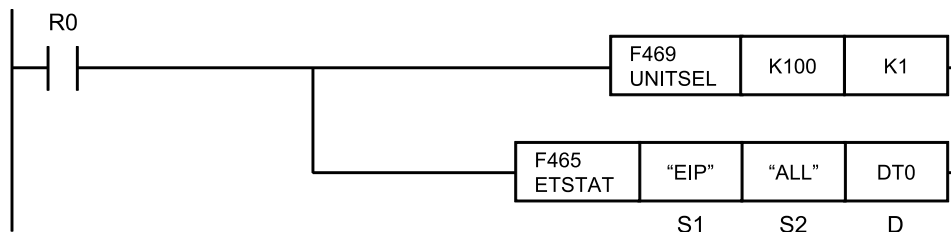

(Note 1) The figure above shows the case of specifying a communication unit slot number (Ethernet communication = K100) using F469 UNITSEL instruction.

(Note 2) By copying and pasting the following text in the instruction list box of FPWIN GR7, the operation part of the above program can be input.

ETSTAT "EIP" "ALL" DT0

■ List of operands

Operand	Description
S1	Specify the type to be read with the starting address or a character constant.
S2	Specify the target to be read with the starting address or a character constant.
D	Specify the starting address of destination.

■ Available devices (●: Available)

Operand	Memory device											Constant			Index modifier
	WX	WY	WR	WL	SV	EV	DT	LD	I	SWR	SDT	K	H	M	
S1	●	●	●	●	●	●	●	●	●					●	●
S2	●	●	●	●	●	●	●	●	●					●	●
D		●	●	●	●	●	●	●	●						●

■ Processing

- Reads the parameter information or status information specified by **S1** and **S2**, and stores it in the area starting with **D**.
- The number of words in the storage area starting with **D** varies according to the type of read data and the target.

■ Precautions during programming

- When specifying a device for an operand which can specify character constants, set string data using F253 SSET instruction in advance.
- When specifying string data, the number of characters should not exceed 256.
- Upper and lower case characters can be used for operands which character constant can be specified.
("Abcd", "ABCD" and "abcd" are synonymous, however, the file names are differentiated.)

35.1 F465 ETSTAT (EtherNet/IP Information Acquisition)

- Insert the F469 UNITSEL instruction immediately before this instruction and specify the unit (Ethernet communication) and the connection number.
- In **S1** and **S2**, specify the starting address of the device storing the string data which indicates the set parameters or a character constant. When specifying a device for an operand, set string data using F253 SSET instruction in advance.
- Both upper and lower case characters can be used. "Abcd", "ABCD" and "abcd" are all synonymous.
- This instruction is not available in interrupt programs.

■ Specification of S1 and S2

Item	Description		
S1	Read type	For specifying the read of the EtherNet/IP communication state	Specify "EIP".
S2	Read target	For specifying the communication state of EtherNet/IP	Specify "ALL" or "ALL + Number".
		For specifying the cyclic communication registration node table	Specify "NODE".
		For specifying the cyclic communication normal node table	Specify "NORMAL".
		For specifying the cyclic communication stop node table	Specify "STOP".
		For specifying the cyclic communication abnormal node table	Specify "ERR".
		For specifying the RUN/IDLE bit monitor (PLC standby flag)	Specify "PLC".

■ Specification of S2 and objects to be read

- The read contents vary according to the character string set in **S2**.
- The number of read words varies according to the maximum registered node number.

Name	No. of words (Note 1)	Character string set in S2 and read object (●: Read, Blank: Not read)						
		ALL	ALL + Number (0 to 1) (Note 2)	NODE	NORMAL	STOP	ERR	PLC
Registered max. node number	1	●	●	●	●	●	●	●
Cyclic communication Registered node table (Note 3)	0 to 1	●	●	●				
Cyclic communication Normal node table (Note 3)	0 to 1	●	●		●			
Cyclic communication Stop node table	0 to 1	●	●			●		

35.1 F465 ETSTAT (EtherNet/IP Information Acquisition)

Name	No. of words (Note 1)	Character string set in S2 and read object (●: Read, Blank: Not read)						
		ALL	ALL + Number (0 to 1) (Note 2)	NODE	NORMAL	STOP	ERR	PLC
(Note 3)								
Cyclic communication Abnormal node table (Note 3)	0 to 1	●	●				●	
RUN/IDLE bit monitor (PLC standby flag) (Note 3)	0 to 1	●	●					●
No. of read words (Note 1)		1 to 6	1 to 6	1 to 2	1 to 2	1 to 2	1 to 2	1 to 2

(Note 1) The number of read words varies according to the registered maximum node number.

Max. node no.	No. of valid words
0	0
1 to 9	1

(Note 2) When specifying "ALL + Number (0 to 1)" for **S2**, the information for the number of effective words specified by the number is read.

(Note 3) The bits in the following table are allocated to the node table numbers and RUN/IDLE bit monitor.

	Bit No.															
	15	14	13	12	11	10	9	8	7	6	5	4	3	2	1	0
Node no.	—	—	—	—	—	—	—	9	8	7	6	5	4	3	2	1

■ Restrictions on combinations of operands S1 and S2

When **S1** is EIP, **S2** can be specified as one of the following. An operation error occurs when other combinations are specified.

ALL, NODE, NORMAL, STOP, ERR, PLC

■ Read content

(When **S1** is "EIP" and **S2** is "ALL" or "ALL + Number": 1 to 6 words)

Name	No. of words	Description
Max. registration node number	1	Registered maximum node number
Cyclic communication registration node table	0 to 1 (Note 1)(Note 2)	Node that connection is registered
Cyclic communication normal node table	0 to 1 (Note 1)(Note 2)	Node that the cyclic communication is performed normally
Cyclic communication stop node table	0 to 1	Node that the cyclic communication stops

35.1 F465 ETSTAT (EtherNet/IP Information Acquisition)

Name	No. of words	Description
	(Note 1)(Note 2)	
Cyclic communication abnormal node table	0 to 1 (Note 1)(Note 2)	Node that the cyclic communication error occurs
RUN/IDLE bit monitor (PLC standby flag)	0 to 1 (Note 1)(Note 2)	RUN/IDLE bit monitor of 32-bit header

When S1 is "EIP" and S2 is "NODE": 1 to 2 words

Name	No. of words	Description
Max. registration node number	1	Registered maximum node number
Cyclic communication registration node table	0 to 1(Note 1)	Node that connection is registered

When S1 is "EIP" and S2 is "NORMAL": 1 to 2 words

Name	No. of words	Description
Max. registration node number	1	Registered maximum node number
Cyclic communication normal node table	0 to 1(Note 1)	Node that the cyclic communication is performed normally

When S1 is "EIP" and S2 is "STOP": 1 to 2 words

Name	No. of words	Description
Max. registration node number	1	Registered maximum node number
Cyclic communication stop node table	0 to 1(Note 1)	Node that the cyclic communication stops

When S1 is "EIP" and S2 is "ERR": 1 to 2 words

Name	No. of words	Description
Max. registration node number	1	Registered maximum node number
Cyclic communication abnormal node table	0 to 1(Note 1)	Node that the cyclic communication error occurs

When S1 is "EIP" and S2 is "PLC": 1 to 2 words

Name	No. of words	Description
Max. registration node number	1	Registered maximum node number
RUN/IDLE bit monitor of 32-bit header	0 to 1(Note 1)	RUN/IDLE bit monitor of 32-bit header

(Note 1) The number of words varies according to the registered maximum node number.

Max. node no.	No. of valid words
0	0
1 to 9	1

(Note 2) (Note 2): When specifying "ALL + Number" for S2, the number of valid words is the specified number. The numbers are 0 to 1.

(Note 3) Allocation of bit numbers and node numbers of each table and monitor

35.1 F465 ETSTAT (EtherNet/IP Information Acquisition)

Correspondence table of node numbers																
Bit No.	15	14	13	12	11	10	9	8	7	6	5	4	3	2	1	0
Node no.	—	—	—	—	—	—	—	9	8	7	6	5	4	3	2	1

■ Setting example

Example 1) When specifying the reading of EtherNet/IP communication state

S1... "EIP" **S2...** "ALL" **D...**DT20

	Value	Description
DT20	9	Max. registration node number
DT21	0000 0001 1111 1111	Cyclic communication registration node table (Node nos. 1 to 9)
DT22	0000 0000 1011 1111	Cyclic communication normal node table (Node nos. 1 to 9)
DT23	0000 0001 0100 0000	Cyclic communication stop node table (Node nos. 1 to 9)
DT24	0000 0000 0100 0000	Cyclic communication abnormal node table (Node nos. 1 to 9)
DT25	0000 0000 0000 1111	RUN/IDLE bit monitor (PLC standby flag) (Node nos. 1 to 9)

Example 2) When specifying the reading of EtherNet/IP communication state

When the maximum registered node number is "0", only the value of **D** is updated and the values after **D+1** are not updated.

S1... "EIP" **S2...** "ALL" **D...**DT20

	Value	Description
DT20	0	Max. registration node number

Example 3) When specifying the reading of EtherNet/IP communication state (fixing the number of valid words)

The communication states of node numbers 1 to 9 are displayed regardless of the maximum registered node number.

S1... "EIP" **S2...** "ALL+1" **D...**DT20

	Value	Description
DT20	9	Max. registration node number
DT21	1st word	Cyclic communication registration node table (Node nos. 1 to 9)
DT22	1st word	Cyclic communication normal node table (Node nos. 1 to 9)
DT23	1st word	Cyclic communication stop node table (Node nos. 1 to 9)
DT24	1st word	Cyclic communication abnormal node table (Node nos. 1 to 9)
DT25	1st word	RUN/IDLE bit monitor (PLC standby flag) (Node nos. 1 to 9)

Example 4) When specifying the reading of cyclic communication registration node table

S1... "EIP" **S2...** "NODE" **D...**WR100

	Value	Description
WR100	9	Max. registration node number
WR101	0000 0001 1111 1111	Cyclic communication registration node table (Node nos. 1 to 9)

Example 5) When specifying the reading of cyclic communication registration node table

35.1 F465 ETSTAT (EtherNet/IP Information Acquisition)

When the maximum registered node number is "0", only the value of **D** is updated and the values after **D+1** are not updated.

S1... "EIP" **S2...** "NODE" **D...**WR100

	Value	Description
WR100	0	Max. registration node number

Example 6) When specifying the reading of cyclic communication normal node table

S1... "EIP" **S2...** "NORMAL" **D...**WY100

	Value	Description
WY100	7	Max. registration node number
WY101	0000 0000 0111 1111	Cyclic communication normal node table (Node nos. 1 to 9)

Example 7) When specifying the reading of cyclic communication normal node table

When the maximum registered node number is "0", only the value of **D** is updated and the values after **D+1** are not updated.

S1... "EIP" **S2...** "NORMAL" **D...**WY100

	Value	Description
WY100	0	Max. registration node number

Example 8) When specifying the reading of cyclic communication stop node table

S1... "EIP" **S2...** "STOP" **D...**WR10

	Value	Description
WR10	8	Max. registration node number
WR11	0000 0000 1111 1111	Cyclic communication stop node table (Node nos. 1 to 9)

Example 9) When specifying the reading of cyclic communication stop node table

When the maximum registered node number is "0", only the value of **D** is updated and the values after **D+1** are not updated.

S1... "EIP" **S2...** "STOP" **D...**WR10

	Value	Description
WR10	0	Max. registration node number

Example 10) When specifying the reading of cyclic communication abnormal node table

S1... "EIP" **S2...** "ERR" **D...**WR100

	Value	Description
WR100	5	Max. registration node number
WR101	0000 0000 0000 1000	Cyclic communication abnormal node table (Node nos. 1 to 9)

Example 11) When specifying the reading of cyclic communication abnormal node table

When the maximum registered node number is "0", only the value of **D** is updated and the values after **D+1** are not updated.

S1... "EIP" **S2...** "ERR" **D...**WR100

	Value	Description
WR100	0	Max. registration node number

35.1 F465 ETSTAT (EtherNet/IP Information Acquisition)

Example 12) When specifying the reading of RUN/IDLE bit monitor (PLC standby flag)

S1... "EIP" **S2...** "PLC" **D...**WR200

	Value	Description
WR200	9	Max. registration node number
WR201	0000 0001 1111 1111	RUN/IDLE bit monitor (Node nos. 1 to 9)

Example 13) When specifying the reading of RUN/IDLE bit monitor (PLC standby flag)

When the maximum registered node number is "0", only the value of **D** is updated and the values after **D+1** are not updated.

S1... "EIP" **S2...** "PLC" **D...**WR200

	Value	Description
WR200	0	Max. registration node number

■ Flag operation

Name	Description
Hold error (R9007) Latest error (R9008)	Set when the read area is out of the range.
	Set when the read type (S1) is set to an item other than "IPv4" or "EIP".
	Set when the target to be read (S2) is set to an item other than "MAC", "CONNECT", "ALL", "NODE", "NORMAL", "STOP", "ERR" or "PLC".
	Set when a combination other than the combinations listed in the restrictions on combination is specified for the type (S1) and target (S2) to be read.
	Set when the unit specified by F469 UNITSEL is not the Ethernet communication.
	Set when executed in an interrupt program.

35.2 F490 EIPNDST (EtherNet/IP node status acquisition instruction)

The F490 EIPNDST instruction can be used with the unit firmware Ver. 1.80 or later.

■ Ladder diagram

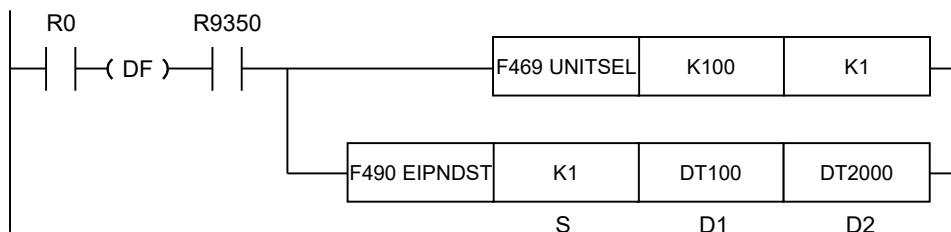

(Note 1) The figure above shows the case of specifying S1=K100 (Ethernet communication) and S2=K1 (connection No. 1) using F469 UNITSEL instruction.

■ List of operands

Operand	Description
S	Specify the device storing the node number (1 to 256) of an EtherNet/IP device from which the status is to be acquired or a constant.
D1	Specify the device address storing the acquired status.
D2	Specify the device address storing a result of the executed instruction.

■ Devices that can be specified (indicated by ●)

Operand	WX											Constant			Index modifier ^(Note 1)
	WY	WR	WL	SV	EV	DT	LD	FL	I	SW R	SD T	K	H	M	
S	●	●	●	●	●	●	●	●	●	●	●	●	●	●	●
D1	●	●	●	●	●	●	●	●	●	●	●	●	●	●	●
D2	●	●	●	●	●	●	●	●	●	●	●	●	●	●	●

(Note 1) A character constant cannot be specified.

■ Processing

- Stores the status of the node number specified by [S] in the device specified by [D1] and stores the execution result in [D2].
- Acquires a node status when an execution condition changes to ON (rise).

■ Precautions during programming

- Execute this instruction after R9350 (EtherNet/IP preparation done flag) turns ON. When the instruction is executed before the flag turns on, an error of incomplete EtherNet/IP communication preparation is returned to execution result [D2].
- F490 EIPNDST instructions cannot be executed simultaneously. A multiple execution error occurs. Be sure to check the completion of the executed instruction before executing a next instruction.

35.2 F490 EIPNDST (EtherNet/IP node status acquisition instruction)

■ Description of operand [S]

Specify node numbers in the range of 1 to 256.

■ Description of operand [D1]

A result of the read node status is stored as shown below.

Bit	Name	Definition
0	Owned	Turns ON when this product is target and connects from the originator.
1	Reserved	It is always 0.
2	Configured	Turns ON when settings of EtherNet/IP device are different from factory-configured default settings. Shows the detailed status of EtherNet/IP device. A vendor-specific status or a status according to CIP.
3	Reserved	It is always 0.
4 to 7	Extended Device Status	Shows the detailed status of EtherNet/IP device. It is a vendor-specific status or a status according to CIP. ^(Note 1)
8	Minor Recoverable Fault	Stores the error information of EtherNet/IP devices. Error contents vary depending on vendors. Recoverable Fault: Recoverable Unrecoverable Fault: Unrecoverable
9	Minor Unrecoverable Fault	
10	Major Recoverable Fault	
11	Major Unrecoverable Fault	
12 to 15	Reserved	It is always 0.

(Note 1) In bits 4 to 7, "field definitions of the Extended Device Status" shown below are stored. Codes indicated with "Target" in the table below are returned.

Bits 4 to 7	Name	Target
0000	Self-Testing (in progress), or unknown	-
0001	Firmware updating	-
0010	More than one I/O connection in a fault state	-
0011	No I/O connection established	Target
0100	Improper settings for nonvolatile memory	-
0101	Major Fault. Bit 10 or 11 turned ON	-
0110	More than one I/O connection is established and more than one connection receiving the RUN mode is present.	Target
0111	More than one I/O connection is established and all received connections are in the Idle mode.	Target
1000 to 1001	Reserved	-
1010 to 1111	Specific to vendor, or specific to product	-

■ Description of operand [D2]

This specifies the area storing the execution result. An execution result code shown below is stored.

35.2 F490 EIPNDST (EtherNet/IP node status acquisition instruction)

Operand	Value	Name	Description
[D2]	0	Normal completion	The acquisition of a specified node status is complete.
	1	In progress	The acquisition of a specified node is in progress.
	2	Timeout	Communication timeout (10 seconds)
	3	Multiple executions	Multiple F490 EIPNDST instructions starting
	4	Communication error	In the case of communication errors
	5	CIP error	In the case of CIP errors
	6	Incomplete EtherNet/IP communication preparation	When the preparation of EtherNet/IP communication is incomplete.
[D2+1]	1 to 255	CIP general status	When the value in [D] is "5", a CIP general status and a CIP extended status are stored. When the value in [D] is other than "5", "0" is stored in [D2+1] and [D2+2].
[D2+2]	0 to 65535	CIP extended status	

■ Example of processing) When acquiring the node status of node number 1

Preparation

- The EtherNet/IP device from which the node status is to be acquired needs to be registered in the scan list in the "EtherNet/IP settings".

Node	IP address	Valid/Invalid flag
1	192.168.1.6	Invalid
2	192.168.1.7	Valid

(Note 1) There is no problem even if the valid/invalid flag is invalid when acquiring the node status. Select valid or invalid to determine whether to perform the cyclic communication or not.

Sample program

- Specify a connection number for the Ethernet communication using F469 UNITSEL instruction.
- The acquisition result of the node status is stored in DT100 and the execution result is in DT2000. When the operation is complete successfully, 0 is stored in DT2000, and the node status is stored in DT100 and subsequent DTs.
- Results produced from the execution of F490 EIPNDST instruction need to be preset to default values.

35.2 F490 EIPNDST (EtherNet/IP node status acquisition instruction)

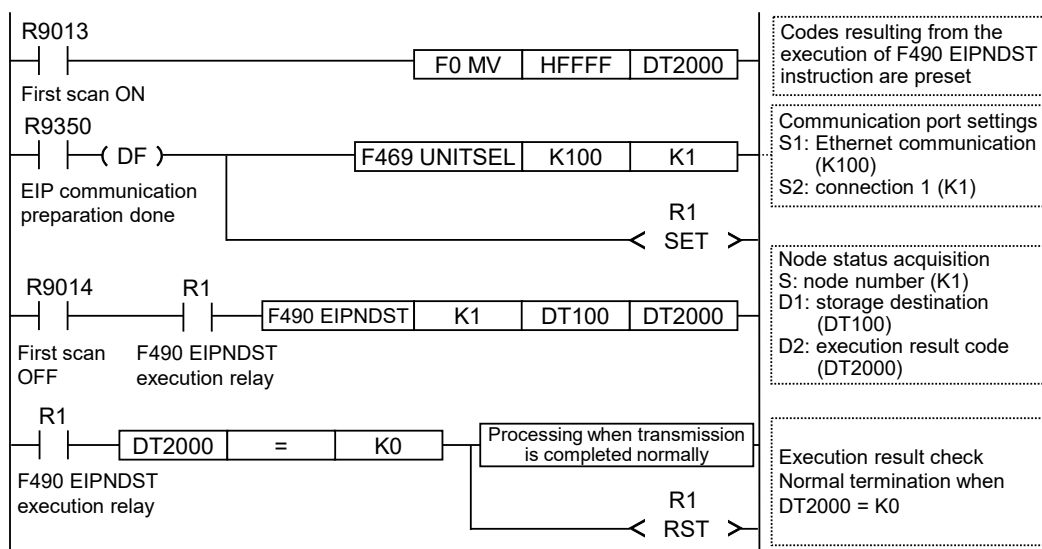

■ Flag operation

Name	Description
Hold error (R9007) Latest error (R9008)	Set when the unit specified by F469 UNITSEL is not the Ethernet communication.
	Set when EtherNet/IP Function is set to Not Use in the "Ethernet settings".
	Set in case of out-of-range in indirect access (index modification).
	Set when executed in an interrupt program.
	Set when the node specified by [S] is not present.
	Set when a device for 3 words cannot be secured from the [D2] device.

35.3 F495 EIPMSATT (EIP message destination settings)

The F495 EIPMSATT instruction can be used with the unit firmware Ver. 1.80 or later.

■ Ladder diagram

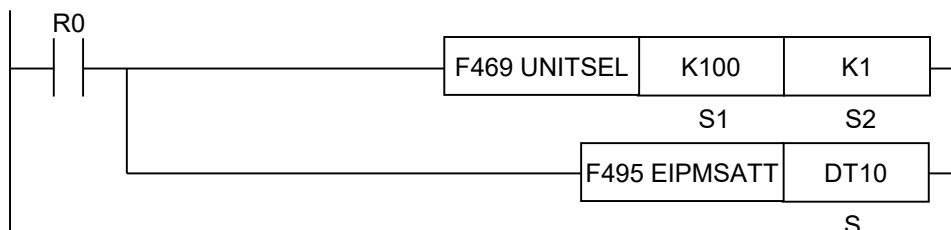

(Note 1) The figure above shows the case of specifying S1=K100 (Ethernet communication) and S2=K1 (connection No. 1) using F469 UNITSEL instruction.

■ Operation units that can be specified

No operation unit

■ List of operands

Operand	Description
S	Specify the starting number of the device storing the message communication target.

■ Devices that can be specified (indicated by ●)

Operand	WX	WY	WR	WL	SV	EV	DT	LD	FL	I	SW R	SD T	Constant			Index modifier(Not e 1)
													K	H	M	
S	●	●	●	●	●	●	●	●		●						●

(Note 1) A character constant cannot be specified.

■ Outline of operation

- With F495 EIPMSATT, F496 EIPMBODY, and F497 EIPMSEND instructions combined, UCMM message can be sent.
- F495 EIPMSATT instruction sets the destination specified by F497 EIPMSEND instruction in the send buffer.
- If this instruction is executed during processing of UCMM message communication, no operation is performed.
- Before the execution of F495 EIPMSATT instruction, F469 UNITSEL instruction specifies a target Ethernet communication connection.

■ Processing

- Sets the destination data specified by [S] in the send buffer.

35.3 F495 EIPMSATT (EIP message destination settings)

Destination data

Operand	Description
S	1st byte of IP address
S+1	2nd byte of IP address
S+2	3rd byte of IP address
S+3	4th byte of IP address
S+4	Service code
S+5	Class ID ^(Note 1)
S+6	Instance ID ^(Note 1)
S+7	Attribute ID ^(Note 1)

(Note 1) The setting range is 0000 to HFFFE. It is omitted when HFFFF is set.

(Note 2) For supported service code, class ID, instance ID, and attribute ID, refer to the manual for each EtherNet/IP device.

■ Example of processing

Example 1) When executing the Get_Attribute_Single service for an EtherNet/IP device (IP address: 192.168.1.10) to read a product code of Identity object

[S]... DT100

Device	Value
DT100	K192
DT101	K168
DT102	K1
DT103	K10
DT104	H000E
DT105	H0001
DT106	H0001
DT107	H0003

Destination

Item	Set value
Destination IP address	192.168.1.10
Service code	H000E
Class ID	H0001
Instance ID	H0001
Attribute ID	H0003

Example 2) When executing the successive data reading service for an EtherNet/IP device (IP address: 192.168.2.1) to successively read device data on PLC object

[S]... DT100

Device	Value
DT100	K192
DT101	K168
DT102	K2
DT103	K1
DT104	H004B
DT105	H0065
DT106	H0001
DT107	HFFFF ^(Note 1)

(Note 1) To omit the device, specify HFFFF.

Destination

Item	Set value
Destination IP address	192.168.2.1
Service code	H004B
Class ID	H0065
Instance ID	H0001
Attribute ID	(Omitted)

■ Flag operation

Name	Description
Hold error (R9007) Latest error (R9008)	Set when the unit specified by F469 UNITSEL is not the built-in Ethernet unit.
	Set when EtherNet/IP Function is set to Not Use in the "Ethernet settings".
	Set in case of out-of-range in indirect access (index modification).
	Set when executed in an interrupt program.
	Set when the device address of [S+7] exceeds the device upper limit.

35.4 F496 EIPMBODY (EIP message body setting)

35.4 F496 EIPMBODY (EIP message body setting)

The F496 EIPMBODY instruction can be used with the unit firmware Ver. 1.80 or later.

■ Ladder diagram

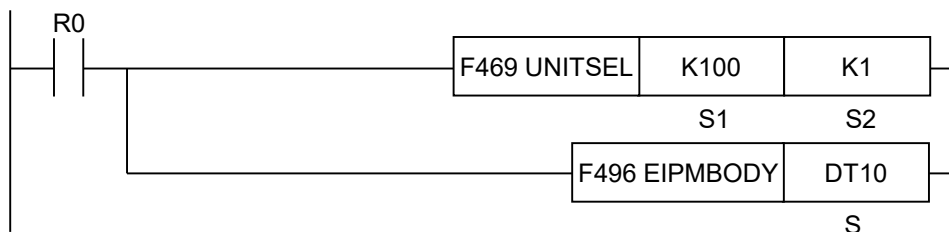

(Note 1) The figure above shows the case of specifying S1=K100 (Ethernet communication) and S2=K1 (connection No. 1) using F469 UNITSEL instruction.

■ Operation units that can be specified

No operation unit

■ List of operands

Operand	Description
S	Specify the starting number of the device storing message body data.

■ Devices that can be specified (indicated by ●)

Operand	WX	WY	WR	WL	SV	EV	DT	LD	FL	I	SW R	SD T	Constant			Index modifier ^(Not e 1)
													K	H	M	
S	●	●	●	●	●	●	●	●		●						●

(Note 1) A character constant cannot be specified.

■ Outline of operation

- With F495 EIPMSATT, F496 EIPMBODY, and F497 EIPMSEND instructions combined, UCMM message can be sent.
- F496 EIPMBODY instruction sets contents (message body data) sent by F497 EIPMSEND instruction in the send buffer.
- The contents of the message body data can include data generated by F498 CIPMSET instruction.
- If this instruction is executed during processing of UCMM message communication, no operation is performed.
- Before the execution of F496 EIPMBODY instruction, F469 UNITSEL instruction specifies a target Ethernet communication connection.

■ Processing

- Sets the message body data specified by [S] in the send buffer. The contents of the message body data can include data generated by F498 CIPMSET instruction.

35.4 F496 EIPMBODY (EIP message body setting)

Message body data

Operand	Description
S	Message body size (0 to 502 bytes)
S+1 and beyond	Message body data

(Note 1) For details of commands and responses, refer to the manual for each EtherNet/IP device.

■ Examples of maximum service data sizes

—: Omitted

	Service code	Size	Segment	Class ID	Segment	Instance ID	Segment	Attribute ID	Service data
1	1byte	0x00	-	-	-	-	-	-	Max. 502 (bytes)
2	1byte	0x01	0x20	1byte	-	-	-	-	Max. 500 (bytes)
3	1byte	0x02	0x0021	2byte	-	-	-	-	Max. 498 (bytes)
4	1byte	0x02	0x20	1byte	0x24	1byte	-	-	Max. 498 (bytes)
5	1byte	0x03	0x20	1byte	0x0025	2byte	-	-	Max. 496 (bytes)
6	1byte	0x03	0x0021	2byte	0x24	1byte	-	-	Max. 496 (bytes)
7	1byte	0x04	0x0021	2byte	0x0025	2byte	-	-	Max. 494 (bytes)
8	1byte	0x03	0x20	1byte	0x24	1byte	0x30	1byte	Max. 496 (bytes)
9	1byte	0x04	0x20	1byte	0x24	1byte	0x0031	2byte	Max. 494 (bytes)
10	1byte	0x04	0x20	1byte	0x0025	2byte	0x30	1byte	Max. 494 (bytes)
11	1byte	0x05	0x20	1byte	0x0025	2byte	0x0031	2byte	Max. 492 (bytes)
12	1byte	0x04	0x0021	2byte	0x24	1byte	0x30	1byte	Max. 494 (bytes)
13	1byte	0x05	0x0021	2byte	0x24	1byte	0x0031	2byte	Max. 492 (bytes)
14	1byte	0x05	0x0021	2byte	0x0025	2byte	0x30	1byte	Max. 492 (bytes)
15	1byte	0x06	0x0021	2byte	0x0025	2byte	0x0031	2byte	Max. 490 (bytes)

(Note 1) The maximum data size per each connection is 504 bytes.

■ Flag operation

Name	Description
Hold error (R9007)	Set when the unit specified by F469 UNITSEL is not the built-in Ethernet unit.

35.4 F496 EIPMBODY (EIP message body setting)

Name	Description
Latest error (R9008)	Set when EtherNet/IP Function is set to Not Use in the "Ethernet settings".
	Set in case of out-of-range in indirect access (index modification).
	Set when a value outside the range is specified for the parameter.
	Set when a terminal of the message body data specified by [S] exceeds the device upper limit.

35.5 F497 EIPMSEND (EIP message sending)

The F497 EIPMSEND instruction can be used with the unit firmware Ver. 1.80 or later.

■ Ladder diagram

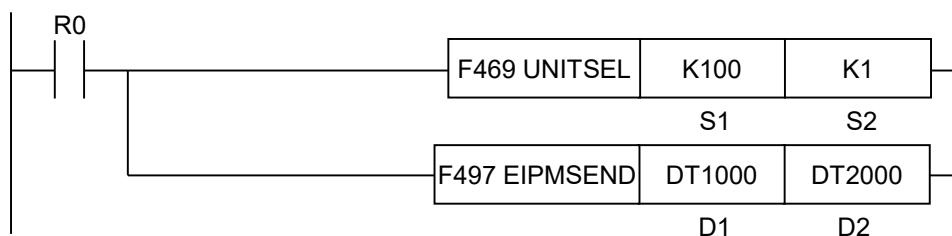

(Note 1) The figure above shows the case of specifying S1=K100 (Ethernet communication) and S2=K1 (connection No. 1) using F469 UNITSEL instruction.

■ Operation units that can be specified

No operation unit

■ List of operands

Operand	Description
D1	Specify the device address storing received data.
D2	Specify the device address for setting results of executed instructions.

■ Devices that can be specified (indicated by ●)

Operand	WX	WY	WR	WL	SV	EV	DT	LD	FL	I	SW R	SD T	Constant			Index modifier ^(Not e 1)
													K	H	M	
D1		●	●	●	●	●	●	●		●						●
D2		●	●	●	●	●	●	●		●						●

(Note 1) A character constant cannot be specified.

■ Outline of operation

- With F495 EIPMSATT, F496 EIPMBODY, and F497 EIPMSEND instructions combined, UCMM message can be sent.
- The execution of F497 EIPMSEND instruction when the execution condition changes to ON (rise) causes UCMM message set by F495 EIPMSATT and F496 EIPMBODY instructions to be sent.
- Execute this instruction after R9350 (EIP preparation done flag) turns on. When the instruction is executed before the flag turns on, an error of incomplete EIP communication preparation occurs.
- This instruction cannot be executed in interrupt programs.

35.5 F497 EIPMSEND (EIP message sending)

- F497 EIPMSEND instructions cannot be executed simultaneously. A multiple execution error occurs. Be sure to check the completion of the executed instruction before executing a next instruction.
- Before the execution of F497 EIPMSEND instruction, F469 UNITSEL instruction specifies a target Ethernet communication connection.

■ Processing

- Sends UCMM message and stores received data in [D1] and execution results in [D2]. A destination and sent contents are set by F495 EIPMSATT and F496 EIPMBODY instructions.

■ Description of operand [D1]

Received data is stored in D1, D1+1, and beyond. Received data is stored as shown below.

Operand	Description
D1	Received data size (1 to 504 bytes)
D1+1 and beyond	Received data

(Note 1) When any of timeout, multiple execution, or communication errors occurs, no values are stored for received data size and received data.

■ Description of operand [D2]

Execution results are stored in D2. Execution results are stored as shown below.

Value	Name	Description
0	Normal end	Message communication is complete.
1	In progress	Message communication is being performed.
2	Timeout	Communication timeout (10 seconds)
3	Multiple executions	Multiple F497 EIPMSEND instructions starting
4	Communication error	In the case of communication errors
5	CIP error	In the case of CIP errors ^(Note 1)
6	Incomplete EIP communication preparation	When the preparation of EIP communication is incomplete.
7	Abnormal sent message size	The sent message size exceeds 504 bytes.

(Note 1) When the execution result is "5", a CIP general status and a CIP extended status are stored in D2+1 and D2+2, respectively.

Operand	Value	Description
D2+1	1 to 255	CIP general status
D2+2	0 to 65535	CIP extended status

When the execution result is other than "5", "0" is stored in D2+1 and D2+2.

■ Example of processing

Message communication is performed using built-in Ethernet connection 1.

Preparation

Add a destination node (node 2) to the scan list in the "EtherNet/IP settings".

Sample Program

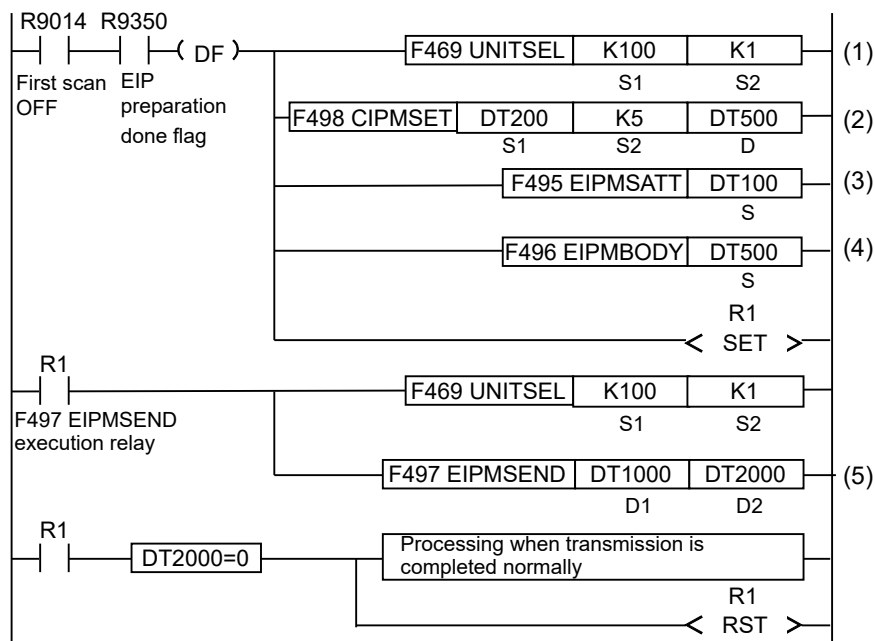

(1)	Specify Ethernet communication (S1 = K100) and user connection 2 (S2 = K1) using F469 UNITSEL instruction.
(2)	Set destination data by F495 EIPMSATT instruction.
(3)	Generate values set for message body data by F498 CIPMSET instruction.
(4)	Set message body data by F496 EIPMBODY instruction.
(5)	Perform message communication by F497 EIPMSEND instruction. Received data is stored in D1 and execution results are stored in D2.

Results produced when message communication is completed normally

Device	Value		Description
DT1000	K6 (No. of bytes)		Received data size
DT1001	H00	H8E	Received data
DT1002	H00	H00	
DT1003	H00	HE	

Device	Value	Description
DT2000	K0	Execution result (normal)

■ Flag operation

Name	Description
Hold error (R9007)	Set when the unit specified by F469 UNITSEL is not the built-in Ethernet unit.
Latest error (R9008)	Set when EtherNet/IP Function is set to Not Use in the "Ethernet settings".

35.5 F497 EIPMSEND (EIP message sending)

Name	Description
	Set in case of out-of-range in indirect access (index modification).
	Set when executed in an interrupt program.
	Set when a device for 253 words cannot be secured from the device address specified by [D1].
	Set when a device for 3 words cannot be secured from the [D2] device.

35.6 F498 CIPMSET [CIP message data generation (combination)]

The F498 CIPMSET instruction can be used with the unit firmware Ver. 1.80 or later.

■ Ladder diagram

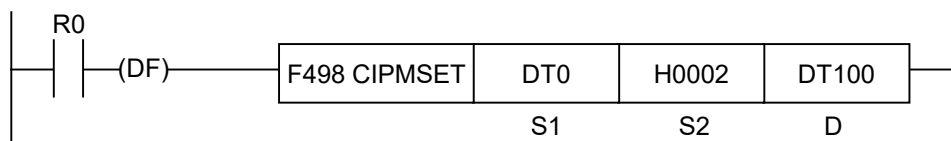

■ Operation units that can be specified

No operation unit

■ List of operands

Operand	Description
S1	Specify a starting device of data that is added to a CIP message.
S2	Specify the data format and size of the data added to the CIP message or a device storing the data.
D	Specify a starting device of a storage destination for the generated CIP message.

■ Devices that can be specified (indicated by ●)

Operand	WX	WY	WR	WL	SV	EV	DT	LD	FL	I	SW R	SD T	Constant			Index modifier(Not e 1)
													K	H	M	
S1	●	●	●	●	●	●	●	●		●						●
S2	●	●	●	●	●	●	●	●		●			●	●		●
D		●	●	●	●	●	●	●		●						●

(Note 1) A character constant cannot be specified.

■ Outline of operation

- Generate CIP message data to be sent by UCMM communication.
- If CIP message data is present in the storage destination, the data is added to a location after the CIP message data.
- The generated data can be used by F496 EIPMBODY instruction.

■ Processing

- Add (combine) additional data specified by [S1] to the CIP message specified by [D] in the format specified by [S2].

■ Description of operand [S1]

Specify a starting device of additional data.

To write string data, generate data using F253 SSET instruction.

35.6 F498 CIPMSET [CIP message data generation (combination)]

Specify string data that contains a string length.

■ Description of operand [S2]

Specify the data format and size of the additional data.

Specified range: 0 to 502 (H000 to H1F6)

Set value	Description	
0	Character string	Specify when added data is character strings. Data of "a value of the starting device specified by S1 + 2 bytes" is added.
1 to 502	Other than character string	Specify when added data is other than character strings. Data of "a value set by S2" is added.

■ Description of operand [D]

- Specify the starting address of an area containing the storage destination for the generated CIP message.
- CIP messages are stored as shown below.

CIP message send data format

Operand	Description
D	CIP data length (the number of stored data bytes)
D+1 and beyond	CIP data (short, double, complex data in string data type)

- The starting device (CIP data length) is set to the number of bytes of stored data that is present before execution of the instruction. When the starting device is not 0, the program recognizes the presence of message data and adds data to a location that is shifted by the bytes from the start of the stored data.

Specify the starting device as shown below.

When generating new message data

Set the starting device to 0 and then execute this instruction.

Example) [D]... DT100 (**: a location where the writing of data starts)

Device	Value	
DT100	H0000	
DT101	H41 (A)	H42 (B) **
DT102	H43 (C)	H44 (D)

When adding data to an existing message

Set the starting device to the number of bytes of stored data present before execution of the instruction.

Example) [D]... DT100 (**: a location where the writing of data starts)

Device	Value	
DT100	H0002	
DT101	H41 (A)	H42 (B)
DT102	H43 (C)	H44 (D) **

35.6 F498 CIPMSET [CIP message data generation (combination)]

- When writing is completed, the length of the added data is added to the starting device (CIP data length).

■ Precautions during programming



- Even if [S1] and [D] ranges overlap, no error occurs. Addition of data is executed.

■ Example of processing

Example 1) A new CIP message is generated. (Writing of data of 2 bytes other than string data)

- Operand specifications

[S1]... DT10 (additional data)

Store data of 2 bytes specified by [S2].

Device	Value	
DT0	H00	H05

[S2]... H0002 (data format)

Specify data of 2 bytes other than string data.

[D]...DT100 (storage destination for CIP message)

Device	Value	Description
DT100	H0000	Specify "0" to generate a new message.

- Execution result

[D]...DT100 (storage destination for CIP message)

Device	Value	Description	
DT100	H0002	Data length after writing: 2 bytes	
DT101	H00	H05	Stored data

Example 2) A new CIP message is generated. (Writing of string data)

- Operand specifications

[S1]... DT0 (additional data)

Store string data (5+2 bytes)

S1: Additional data

Device	Value	
DT0	H0005	
DT1	H42 (B)	H41 (A)
DT2	H44 (D)	H43 (C)
DT3	-	H45 (E)

[S2]... H0000 (data format)

Specify string data

35.6 F498 CIPMSET [CIP message data generation (combination)]

[D]...DT100 (storage destination for CIP message)

Device	Value	Description
DT100	H0000	Specify "0" to generate a new message.

- Execution result

[D]...DT100 (storage destination for CIP message)

Device	Value	Description
DT100	H0007	Data length after writing: 7 bytes
DT101	H0005	String length
DT102	'B'	String data
DT103	'D'	
DT104	-	
	'E'	

Example 3) Data is added to an existing CIP message. (Writing of data of 4 bytes other than string data)

- Operand specifications

[S1]... DT1 (additional data)

Store data of 4 bytes specified by [S2].

Device	Value
DT1	H00 H03
DT2	H32 H31

[S2]... H0004 (data format)

Specify data of 4 bytes other than string data.

[D]...DT100 (storage destination for CIP message)

Device	Value	Description
DT100	H0003	Data length of existing data
DT101	H0001	Existing data
DT102	- 'A'	

- Execution result

[D]...DT100 (storage destination for CIP message)

Device	Value	Description
DT100	H0007	Data length
DT101	H0001	Existing data
DT102	H03 'A'	
DT103	H31 H00	Additional data
DT104	- H32	

Example 4) Data is added to an existing CIP message. (Writing of string data)

- Operand specifications

[S1]... DT1 (additional data)

Store string data (3+2 bytes)

Device	Value	
DT1	H0003	
DT2	H32 (2)	H31 (1)
DT3	-	H33 (3)

[S2]... H0000 (data format)

Specify string data

[D]...DT100 (storage destination for CIP message)

Device	Value	Description
DT100	H0003	Length of existing data
DT101	H0001	Existing data
DT102	- 'A'	

- Execution result

[D]...DT100 (storage destination for CIP message)

Device	Value	Description
DT100	H0008	Data length
DT101	H0001	Existing data
DT102	H03 'A'	
DT103	'1' H00	Additional data
DT104	'3' '2'	

■ Flag operation

Name	Description
Hold error (R9007) Latest error (R9008)	Set when EtherNet/IP Function is set to Not Use in the "Ethernet settings".
	Set in case of out-of-range in indirect access (index modification).
	Set when a value outside the range is specified for the parameter.
	When the data size exceeds 502 bytes after addition.

35.7 F499 CIPMGET (data acquisition from CIP message)

35.7 F499 CIPMGET (data acquisition from CIP message)

The F499 CIPMGET instruction can be used with the unit firmware Ver. 1.80 or later.

■ Ladder diagram

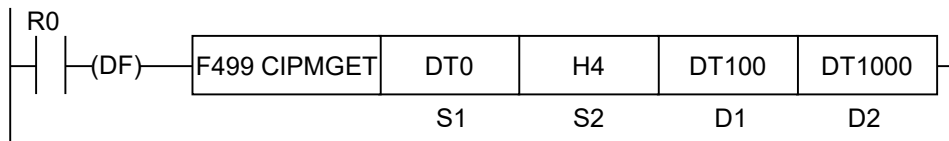

■ Operation units that can be specified

No operation unit

■ List of operands

Operand	Description
S1	Specify a starting device of an area storing data received through CIP message communication.
S2	Specify the data format of data acquired from received CIP message data or a device storing it.
D1	Specify a position where acquisition of the data starts within the received CIP message data or a device storing it. The starting position is specified by a location that is offset by bytes from the starting part of the received data.
D2	Specify the starting device of the device storing acquired data.

■ Devices that can be specified (indicated by ●)

Operand	WX	WY	WR	WL	SV	EV	DT	LD	FL	I	SW R	SD T	Constant			Index modifier ^(Not e 1)
													K	H	M	
S1	●	●	●	●	●	●	●	●		●						●
S2	●	●	●	●	●	●	●	●		●			●	●		●
D1	●	●	●	●	●	●	●	●		●						●
D2		●	●	●	●	●	●	●		●						●

(Note 1) A character constant cannot be specified.

■ Outline of operation

- Acquire string data and numerical data from CIP message data received through UCMM communication.
- Data other than string data is read from lower bytes.

■ Processing

- Divide and transfer data from the location offset by bytes specified by [D1] within the received CIP message data specified by [S1] to memory specified by [D2] in accordance with the data volume specified by [S2].

■ Description of operand [S1]

Specify the starting device of the received CIP message data. Specify [S1] such that the data format is in a state shown below.

Format of received CIP message data

Operand	Value	Description
S1	CIP data length	-
S1+1	Service code	CIP receive header
S1+2	General Status	
S1+3 and beyond	CIP data	Short, double, complex data in string data type

Device specification example ([S1]...DT0)

Device	Value	Description
DT0	H0011	Data length
DT1	CIP receive header	-
DT2		
DT3	H0001	1st data: '1' (Note 1)
DT4	H02 H31 (1)	
DT5	H41 (A) H00	2nd data: 'AB' (Note 1)
DT6	H34 H42 (B)	
DT7	HFF H12	3rd data: H1234

(Note 1) In string data, the starting one word represents a string length.

■ Description of operand [S2]

Specify the data format and data size of acquired data.
Specified range: 0 to 504 (H000 to H1F8)

Set value	Description	
0	Character string	Specify when acquired data is character strings. Data of "a value of the starting device specified by S1 + 2" is acquired.
1 to 504	Other than character string	Specify when acquired data is other than character strings. Data of "a set value" is acquired.

■ Description of operand [D1]

Specify a device storing a position where acquisition of the data starts.

- The data-acquisition starting position is specified by a location that is offset by bytes from the starting part of the received data.
- The size of the data length (2 bytes) of the starting part of the received data is not included in the offset count.
- After completion of F499 CIPMGET instruction, the value in [D1] is updated by the amount of data acquired by the instruction.

35.7 F499 CIPMGET (data acquisition from CIP message)

The method of counting the offset location

The offset location is counted as shown below.

Device	Offset count		Description
DT0	-		The data length is not included in the offset location.
DT1	1	0	The CIP header is also subject to extraction.
DT2	3	2	
DT3	5	4	1st data
DT4	7 **	6	
DT5	9	8	2nd data
DT6	B	A	
DT7	D	C	3rd data

When acquiring second data

[D1]...Specification of DT10

Device	Value
DT10	H0007

■ Description of operand [D2]

Specify a destination device where acquired data is stored.

■ Precautions during programming



- CIP message data separation cannot be checked with this instruction. Even if an improper offset location is specified, no error occurs. Grasp contents of the received CIP message and set the offset location and data size.
- Even if acquisition source (S1) and acquisition destination (D2) ranges overlap, no error occurs and data acquisition is performed.

■ Example of processing

Pieces of data are successively acquired from the starting part of a CIP message.

- (1) Acquire information on CIP receive header from the starting message part
- (2) Acquire 1st data (string data)
- (3) Acquire 2nd data (string data)
- (4) Acquire 3rd data (data other than character strings)

Received CIP message data subject to data acquisition

Device	Value		Description
DT0	H000D		Full data length
DT1	H00CB		(1) CIP receive header
DT2	H0000		
DT3	H0001		(1) 1st data
DT4	H02	H31 (1)	

Device	Value		Description
DT5	H41 (A)	H00	(3) 2nd data
DT6	H34	H42 (B)	
DT7	HFF	H12	(4) 3rd data

■ **(1) Acquire information on CIP receive header from the starting message part**

- Operand specifications

[S1]... DT0 (data format)

Specify the starting device of the received CIP data

[S2]... H4 (data format)

Specify 4-byte data other than character strings

[D1]... DT100 (offset location)

Device	Value
DT100	H0000

[D2]... DT1000 (storage destination for acquired data)

Store acquired data in DT1000 and beyond

- Execution result

[D1]... DT100 (offset location)

Device	Value
DT100	H0000⇒H0004

[D2]... DT1000 (storage destination for acquired data)

Device	Value
DT1000	H00CB
DT1001	H0000

■ **(2) Acquire string data of 1st data from the offset location**

- Operand specifications

[S1]... DT0 (data format)

Specify the starting device of the received CIP data

[S2]... H0 (data format)

Specify string data

[D1]... DT100 (offset location)

Device	Value
DT100	H0004 ^(Note 1)

(Note 1) The D1 offset location is updated to the starting position of the 1st data when F499 CIPMGET instruction is executed in (1).

[D2]... DT2000 (storage destination for acquired data)

Store acquired data in DT2000 and beyond

35.7 F499 CIPMGET (data acquisition from CIP message)

- Execution result

[D1]... DT100 (offset location)

Device	Value
DT100	H0004⇒H0007

[D2]... DT2000 (storage destination for acquired data)

Device	Value	
DT2000	H0001	
DT2001	HFF	'1'

■ (3) Acquire string data of 2nd data from the offset location

- Operand specifications

[S1]... DT0 (data format)

Specify the starting device of the received CIP data

[S2]... H0 (data format)

Specify string data

[D1]... DT100 (offset location)

Device	Value
DT100	H0007 ^(Note 1)

(Note 1) The D1 offset location is updated to the starting position of the 2nd data when F499 CIPMGET instruction is executed in (2).

[D2]... DT3000 (storage destination for acquired data)

Store acquired data in DT3000 and beyond

- Execution result

[D1]... DT100 (offset location)

Device	Value
DT100	H0007⇒H000B

[D2]... DT3000 (storage destination for acquired data)

Device	Value	
DT3000	H0002	
DT3001	'B'	'A'

■ (4) Acquire data other than character strings of 3rd data from the offset location

- Operand specifications

[S1]... DT0 (data format)

Specify the starting device of the received CIP data

[S2]... H0 (data format)

Specify 2-byte data other than character strings

[D1]... DT100 (offset location)

Device	Value
DT100	H000B ^(Note 1)

[D2]... DT4000 (storage destination for acquired data)

Store acquired data in DT4000 and beyond

- Execution result

[D1]... DT100 (offset location)

Device	Value
DT100	H000B⇒H000D

[D2]... DT4000 (storage destination for acquired data)

Device	Value
DT4000	H1234
DT4001	H0000

■ Flag operation

Name	Description
Hold error (R9007) Latest error (R9008)	Set when EtherNet/IP Function is set to Not Use in the "Ethernet settings".
	Set in case of out-of-range in indirect access (index modification).
	Set when a value outside the range is specified for the parameter.
	When [D1] (offset location) exceeds the value of the first word (entire data volume) in [S1] (CIP message) before processing.
	When [D1] (offset location) exceeds the value of the first word (entire data volume) in [S1] (CIP message) after processing.

35.8 CIP Status Codes

35.8 CIP Status Codes

Status code	Status name	Description
0x00	Success	The service was executed successfully by the specified object.
0x01	Communications Related Problem	Connection related service failed in connection path.
0x02	Resource unavailable	There were no resources necessary for the object to execute the requested service.
0x03	Invalid parameter value	Concerning what value to use for this state, refer to status code 20 (hexadecimal number).
0x04	Path segment error	The processing node was unable to recognize the path segment identifier or segment syntax. When a path segment error occurs, the path processing stops.
0x05	Path destination unknown	The path is referring to an object class, instance, or structure element that is unknown or not included in the processing node. When a path destination unknown error occurs, the path processing stops.
0x06	Partial transfer	Only part of the expected data was transmitted.
0x07	Connection lost	The messaging sending connection was lost.
0x08	Service not supported	The requested service is not implemented. In other words, the service is not defined for this object class or instance.
0x09	Invalid attribute value	Invalid attribute data was detected.
0x0A	Attribute list error	The status of the attribute in Get_Attribute_List or Set_Attribute_List response is other than zero.
0x0B	Already in requested mode/state	The object is already in the mode or state requested by the service.
0x0C	Object state conflict	The object cannot execute the requested service in the current state.
0x0D	Object already exists	An object instance that was requested to be created already exists.
0x0E	Attribute not settable	A request to change an unchangeable attribute was received.
0x0F	Privilege violation	Failed to pass verification in permission and privilege.
0x10	Device state conflict	The device cannot execute the requested service in the current mode or state.
0x11	Reply data too large	The size of data sent to a response buffer is larger than the allocated size of the response buffer.
0x12	Fragmentation of a primitive value	The service specified fragmentation of a primitive data value (e.g.: REAL data type division).
0x13	Not enough data	The service was unable to provide enough data to execute the specified process.
0x14	Attribute not supported	The attribute specified by the request is not supported.
0x15	Too much data	The service provided more data than expected.
0x16	Object instance does not exist	The specified object does not exist in the device.
0x17	Service fragmentation out of sequence	The fragmentation sequence of this service is currently inactive for this data.
0x18	No stored attribute data	The attribute data of this object has not been saved before the requested service is executed.

Status code	Status name	Description
0x19	Store operation failure	The attribute data of this object has not been saved due to the occurrence of a problem during the saving process.
0x1A	Routing failure, request packet too large	The service request packet was too large to send through the network in the path to the receiver. The routing device inevitably interrupted the service.
0x1B	Routing failure, response packet too large	The service response packet was too large to send through the network in the path from the receiver. The routing device inevitably interrupted the service.
0x1C	Missing attribute list entry data	The service was unable to supply attributes in the list of attributes that it requires to execute the requested behavior.
0x1D	Invalid attribute value list	The service returns status information concerning the invalid attribute together with the list of attributes.
0x1E	Embedded service error	An error in the embedded service.
0x1F	Vendor specific error	A vendor-specific error occurred. The Additional Code field for error response is used to define a specific error that occurred. Use of this error code field is permitted only if the error in question does not exactly apply to any of the error codes shown in this table or those shown in the object class definition.
0x20	Invalid parameter	The parameter associated with the request is invalid. This code is used when the parameter does not meet the requirements of this specification or the requirements defined in the Application object specification.
0x21	Write-once value or medium already written	An attempt has been made to write data to write-once media (a WORM drive, PROM, etc.) to which data had already been written once. If not, an attempt has been made to change a value that cannot be changed once established.
0x22	Invalid Reply Received	An invalid reply was received (for example, the reply service code does not match the request service code or the reply message is shorter than the minimum reply size). This status code can be used for invalid replies caused by other reasons.
0x23	Buffer Overflow	The size of the received message is larger than the processing capacity of the receive buffer. The message was entirely discarded.
0x24	Message Format Error	The format of the received message is not supported by the server.
0x25	Key Failure in path	The key segment included as the first segment of the path does not match the destination module. The object-specific status indicates which part of the key check has failed.
0x26	Path Size Invalid	The size of the path sent by the service request is not large enough to route the request to the object or routing data included in the path is too much.
0x27	Unexpected attribute in list	This is an attribute that is not settable at the present.
0x28	Invalid Member ID	The member ID specified in the request does not exist in the specified class, instance, or attribute.
0x29	Member not settable	A request to change an unchangeable member was received.
0x2A	Group 2 only server general failure	This error code is reported only in DeviceNet Group 2. This is used only in place of error codes with a code space of 4K and smaller for services not supported, attributes not supported, and attributes not settable.
0x2B	Unknown Modbus Error	The translator from CIP to Modbus received an unknown Modbus exception code.

35.8 CIP Status Codes

Status code	Status name	Description
0x2C	Attribute not gettable	A request to read an unreadable attribute was received.
0x2D	Instance Not Deletable	The requested object instance cannot be deleted.
0x2E	Service Not Supported for Specified Path 1	The object supports the service but does not support the specified application path (such as attributes). (Note 1)
0x2F to 0xCF		CIP reserves these codes for future extension.
0xD0 0xFF	Reserved for Object Class specific errors	This error code range is used to show object class-specific errors. This range is used only if the error that has occurred does not exactly apply to any of the error codes shown in this table.

(Note 1) This code cannot be used when general and more specific status codes are applied.

Example: 0x0E (Attribute not settable) or 0x29 (Member not settable)

36 FTP Instructions

36.1 F465 ETSTAT (Acquire Ethernet Unit Information: FTP)	36-2
36.2 F470 FTPcSV (FTP Client Connected Server Setting).....	36-8
36.3 F471 FTPcSET (FTP Client Transfer Setting)	36-14
36.4 F472 FTPcLOG (Logging / Trace Transfer Setting).....	36-22
36.5 F473 FTPcREQ (FTP Client Transfer Request)	36-25
36.6 F474 FTPcCTL (FTP Client Transfer Control)	36-29

36.1 F465 ETSTAT (Acquire Ethernet Unit Information: FTP)

36.1 F465 ETSTAT (Acquire Ethernet Unit Information: FTP)

■ Instruction format

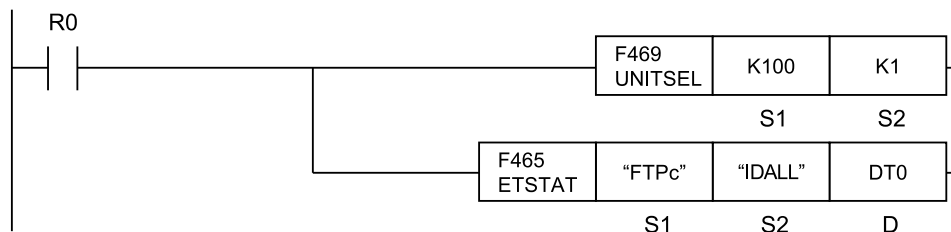

(Note 1) Specify S1=K100 (Ethernet communication) in advance using F469 UNITSEL instruction.

(Note 2) By copying & pasting the following text into the instruction list box of FPWIN GR7, the operand section of the program example above can be entered.

ETSTAT "FTPc" "IDALL" DT0

■ Operands

Items	Settings
S1	Either the starting address of a device that stores string data representing the read type, or a character constant
S2	Either the starting address of a device that stores string data representing the read target, or a character constant
D	Starting address of read destination device

■ Devices that can be specified (indicated by ●)

Operands	WX	WY	WR	WL	SV	EV	DT	LD	I	SW R	SDT	Constant			Index modifier (Note 1)
												K	H	M	
S1	●	●	●	●	●	●	●	●	●					●	●
S2	●	●	●	●	●	●	●	●	●					●	●
D			●	●	●	●	●	●	●						●

(Note 1) A character constant cannot be specified.

■ Outline of operation

- Reads information of the Ethernet unit.

■ Processing

- Read the parameter information or status information specified by **S1** and **S2**, and store it in the area starting with **D**.
- The number of words in the storage area varies according to the type of read data and the target.

■ Precautions for programming

- Immediately before this instruction, insert F469 (UNITSEL) instruction, and specify the unit (Ethernet communication) and connection No.
- In **S1** and **S2**, specify either the starting address of a device that stores string data representing information to be read, or a character constant. When specifying a device for an operand, set string data using F253 (SSET) instruction in advance. Both upper case and lower case can be used. "Abcd", "ABCD" and "abcd" are all synonymous.
- When specifying string data, the number of characters should not exceed 256.
- This instruction is not available in an interrupt program.

■ Operands S1 / S2 setting

Items	Settings		
S1	Read type	When specifying FTP client	Specify "FTPc".
S2	Read target	When specifying transfer numbers individually	Specify 0 to 3 for x with "IDx".
		When specifying logging individually	Specify 0 to 3 for x with "LOGx".
		When specifying all transfer numbers	Specify "IDALL".
		When specifying all loggings	Specify "LOGALL".
D	Read destination	Specify the destination device address into which the status should be read.	

■ Restrictions on the combination of operands S1 and S2

When **S1** is FTPc, **S2** can be specified as one of the following. If any other combination is specified, an operation error will occur.

- IDx
- LOGx
- IDALL
- LOGALL

■ Data and number of words to be read

Data and number of words to be read vary depending on the combination of **S1** and **S2**.

S1S2	Storage destination	Name	Number of words	Format
S1 : "FTPc" S2 : "IDALL" "LOGALL" (Note 1)(Note 2)	D	Transferring ID No.	1	0 to 3 Transfer setting ID or log setting ID (for FTP)
	D+1	Transferring data type	1	0: FTP file transfer 1: Logging / Trace transfer
	D+2	Transfer status	1	Higher byte: H0: Other than rewriting, H1: Rewriting Lower byte: H00: No request, H01: Waiting for transfer, H02: Being logged in, H03: Send transferring, H04: Receive transferring, H05: Transfer completed
	D+3	Transfer result	1	0: Transfer succeeded, 1: Login error, 2: Transfer error, 3: Transfer canceled

36.1 F465 ETSTAT (Acquire Ethernet Unit Information: FTP)

S1S2	Storage destination	Name	Number of words	Format
	D+4 to D+9	Latest transfer success time	6	Year, month, day, hour, minute and second when the last transfer succeeded
	D+10 to D+15	Latest transfer failure time	6	Year, month, day, hour, minute and second when the last transfer failed
	D+16 to D+17	No. of transfer successes (Whole)	2	Number of times that transfer succeeded
	D+18 to D+19	No. of transfer failures (Whole)	2	Number of times that transfer failed
	Total number of words		20	—
S1 : "FTPc" S2 : "IDx"	D	Control relay (Note 3)	1	FTPc control relay
	D+1	Execution done code (Note 4)	1	0: Successful, If unsuccessful, the error code is stored here.
	D+2	Transfer done code	1	FTP response code (Note 5)
	D+3 to D+4	No. of successful executions (individual)	2	Number of times that transfer succeeded
	D+5 to D+6	No. of failed executions (individual)	2	Number of times that transfer failed
	Subtotal number of words		7	—
S1 : "FTPc" S2 : "LOGx"	D	Control relay (Note 3)	1	FTPc logging control relay
	D+1	Execution done code (Note 4)	1	0: Successful, If unsuccessful, the error code is stored here.
	D+2	Transfer done code	1	FTP response code (Note 5)
	D+3 to D+4	No. of successful executions (individual)	2	Number of times that transfer succeeded
	D+5 to D+6	No. of failed executions (individual)	2	Number of times that transfer failed
	Total number of words		7	—

(Note 1) When "IDALL" is specified, overall status (20 words) and individual status (7 words) of the registered ID multiplied by the number of registered items are read.

(Note 2) When "LOGAL" is specified, overall status (20 words) and individual status (7 words) of the registered LOG multiplied by the number of registered items are read.

(Note 3) For the control relay, the relay status is read every time ID or LOG is set. Refer to "Control relay".

(Note 4) For the execution done code for unsuccessful termination, refer to "List of execution done codes".

(Note 5) For the FTP response code, refer to "List of FTP error codes".

■ Example of execution

Example 1) When specifying a transfer number

The status that corresponds to the transfer number specified by S2 is read in 7 words.

S1... "FTPc" S2... "ID3" D...DT0

36.1 F465 ETSTAT (Acquire Ethernet Unit Information: FTP)

DT0	Control relay
DT1	Execution done code
DT2	Transfer done code
DT3 to DT4	No. of successful transmissions (individual)
DT5 to DT6	No. of failed transmissions (individual)

Example 2) When specifying "IDALL" (all ID numbers)

The status of all transfer IDs and the status of an individual set ID are read.

S1... "FTPc" **S2...** "IDALL" **D...**DT0

DT0	Transferring ID No.	
DT1	Transferring data type	
DT2	Transfer status	
DT3	Transfer result	
DT4 to DT9	Latest transfer success time	
DT10 to DT15	Latest transfer failure time	
DT16-DT17	No. of transfer successes (Whole)	
DT18 to DT19	No. of transfer failures (Whole)	
DT20	ID transfer setting	Only the bit that corresponds to the set ID number is turned ON.
DT21 to DT27	Status of ID0	The status data (7 words) that corresponds to each ID is read for the maximum of 4 IDs.
DT28 to DT34	Status of ID1	
DT35 to DT41	Status of ID2	
DT42 to DT48	Status of ID3	

Example 3) When specifying "LOGALL" (all LOG numbers)

The status of the whole logging trace and the status of an individual ID set to logging trace are read.

S1... "FTPc" **S2...** "LOGALL" **D...**DT0

DT0	Transferring ID No.	
DT1	Transferring data type	
DT2	Transfer status	
DT3	Transfer result	
DT4 to DT9	Latest transfer success time	
DT10 to DT15	Latest transfer failure time	

36.1 F465 ETSTAT (Acquire Ethernet Unit Information: FTP)

DT16 to DT17	No. of transfer successes (Whole)	
DT18 to DT19	No. of transfer failures (Whole)	
DT20	LOG transfer setting	Only the bit that corresponds to the set ID number is turned ON.
DT21 to DT27	Status of LOG0	The status data (7 words) that corresponds to each ID is read for the maximum of 4 IDs.
DT28 to DT34	Status of LOG1	
DT35 to DT41	Status of LOG2	
DT42 to DT48	Status of LOG3	

■ Control relay

Each bit is allocated to the control relay (1 word).

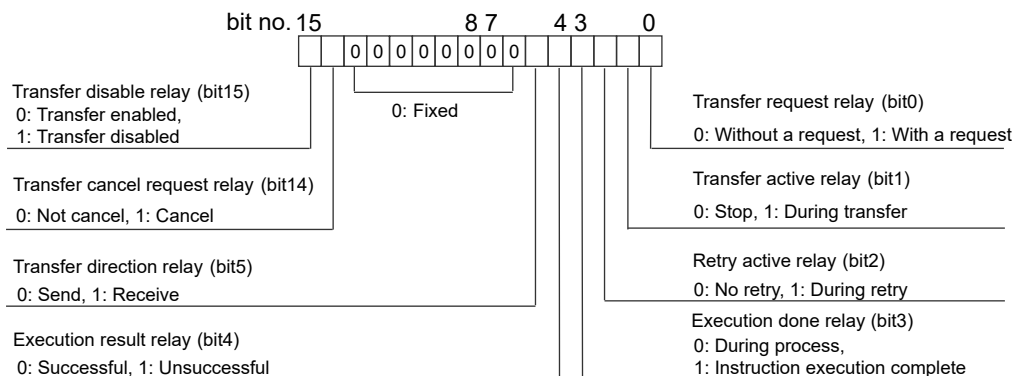

(Note 1) The transfer direction relay (bit 5) becomes 0 for logging.

■ List of execution done codes

Code	Name	Description
0	Normal end	Set when processing of the transfer request instruction has completed successfully.
1	Transfer server unset error	Set when setting of the server that is accessed when transfer request instruction is executed has not been completed.
2	Transfer setting unset error	Set when transfer setting for the transfer number specified when transfer request instruction is executed has not been completed.
4	Client registration error	Set when registration of process request to the client has failed.
5	Transfer disabled error	Set when the transfer disable relay for the transfer number specified when transfer request instruction is executed has been set to "1: transfer disabled".
6	Transfer canceled error	Set when the transfer cancel request relay has been set to "0>1=Cancel request" (at the rising edge from OFF to ON)
7	Transfer failed error	Set when the transfer done relay is set to "1=Transfer done" and the transfer failed relay is set to "1=Transfer failed".

36.1 F465 ETSTAT (Acquire Ethernet Unit Information: FTP)

Code	Name	Description
8	Data decompression error (Write)	Set when an error occurs while decompressing data to register to the client.
9	Data decompression error (Read)	Set when an error occurs while acquiring data from the client.

■ List of FTP error codes

The following error codes can be confirmed with F465 (ETSTAT) instruction.

Error code	Description
250	Normal end
421	It is not possible to provide services. Ends control connection. At the time of the shutdown of server.
425	It is not possible to open data connection.
426	Connection was closed and data transfer was canceled for some reason.
450	It is not possible to execute the request for any reason of access authority or file system.
451	Processing was canceled due to a local error.
452	It is not possible to execute due to any problem in disk capacity.
500	Syntax error of commands
501	Syntax error of arguments or parameters
502	Command is not implemented.
503	The order of using commands is wrong.
504	Arguments or parameters are not implemented.
530	User could not log in.
532	Charging information must be confirmed with ACCT command for file transmission.
550	It is not possible to execute the request for any reason of access authority or file system.
551	It is not possible to execute because of a problem in the type of page structure.
552	It is not possible to execute due to any problem in disk capacity.
553	It is not possible to execute due to an incorrect file name.
1XXX	File delete error

■ Flag operations

Name	Description
R9007 R9008 (ER)	Set when the read area is outside the range.
	Set when other than "FTPc" is specified for the read type (S1).
	Set when any items other than "IDx" or "LOGx" or "IDALL" or "LOGALL" are specified for the read target (S2). (Possible to set 0 to 3 for "x".)
	Set when an unset transfer setting is specified.
	Set when the unit specified with F469 UNITSEL is not Ethernet communication.
	Set when executed in an interrupt program.

36.2 F470 FTPcSV (FTP Client Connected Server Setting)

36.2 F470 FTPcSV (FTP Client Connected Server Setting)

■ Instruction format

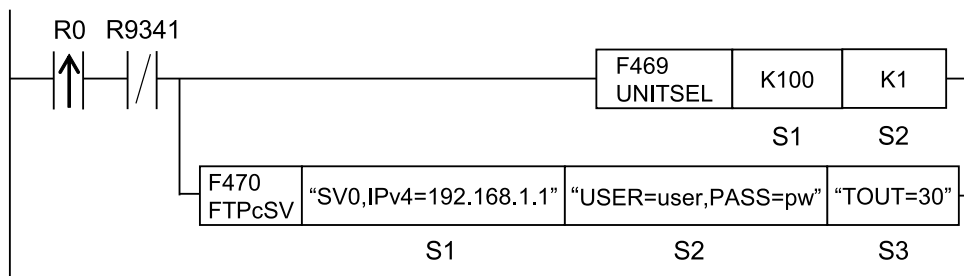

(Note 1) Specify S1=K100 (Ethernet communication) in advance using F469 UNITSEL instruction.

■ Operands

Items	Settings
S1	Specify the starting address storing the server specification parameter or a character constant.
S2	Specify the starting address storing the login setting parameter or a character constant.
S3	Specify the starting address storing the detailed setting parameter or a character constant.

■ Devices that can be specified (indicated by ●)

Operands	WX	WY	WR	WL	SV	EV	DT	LD	I	SW R	SDT	Constant			Index modifier (Note 1)
												K	H	M	
S1	●	●	●	●	●	●	●	●	●					●	●
S2	●	●	●	●	●	●	●	●	●					●	●
S3	●	●	●	●	●	●	●	●	●					●	●

(Note 1) A character constant cannot be specified.

■ Outline of operation

- Sets the server to which the FTP client is connected.
- When this instruction is executed, the special relay R9009 (carry flag CY) and the special data register DT90529 (Ethernet communication error code) are cleared to 0. (They are set when an incorrect IP address is specified or Ethernet is initialized.)
- Confirm that "R9341: Ethernet initialization in progress" is OFF before executing the instruction.

■ Processing

- The setting for the server connected to the FTP client is specified in the built-in Ethernet according to specified parameters.
- It is executable when all the send request relays of the FTPc control relay and FTPc logging / trace control relay are 0: No request. (In the case other than the above, an operation error is occurred.)

36.2 F470 FTPcSV (FTP Client Connected Server Setting)

- When this instruction is executed, the special relay R9009 (carry flag CY) and the special data register DT90529 (Ethernet communication error code) are cleared to 0. (Set when a specified IP address is out of range.)
- The initial value is set with the instruction when the server setting is not specified.
- The unit configuration data of Ethernet will never be rewritten. When the configuration data has been already set, it is overwritten and the data becomes invalid.
- When an incorrect IP address is specified, an error is set to CY flag and no operation is performed.
- It is executable when the "Ethernet initialization in progress (R9341)" is OFF. If it is ON when executing the instruction, an error is set to CY flag and no operation is performed.

■ Precautions on programming

- When specifying a device for an operand specifying a character constant, set string data using F253 (SSET) instruction in advance.
- When specifying string data, the number of characters should not exceed 256.
- Upper and lower case characters can be used for an operand specifying a character constant.
("Abcd", "ABCD" and "abcd" are synonymous, however, the file names are differentiated.)
- A target unit for the instruction is specified with F469 (UNITSEL) beforehand.
- This instruction is not available in an interrupt program.

■ Operand S1 setting

- The starting address storing the server specification parameter or a character constant is specified.
- A part of parameters can be omitted. The settings are not changed when parameters are omitted partially.
- When omitting the part before a specified keyword, omit only "keyword" without omitting <,>.
- When omitting the part after a specified keyword, omit both <,> and "keyword".
- Specify the FTP server setting from SV0 in order. When the right order is skipped, an error occurs. It is possible to specify when the setting has been already registered.
- Only one server can be specified at the same time.
- Specify an FTP server number, IP address or host name of FTP server, port number, and open method within 256 characters in total.
- It is prohibited to specify the same keyword redundantly. An error is caused in the case of redundant specification.

Setting item	Settings	
S1	FTP server number (Essential)	Specify FTP servers. Specify the following keywords. SV0: Server 0, SV1: Server 1, SV2: Server 2,
	IP address or host name of FTP server (Essential)	Specify IP address or host name. For the IP address, specify the keyword "IPv4=" at the beginning. For the host name, specify "HOST=". <ul style="list-style-type: none"> • For IPv4: IPv4 = 111.122.133.144 For details on the addressable range of IPv4 address, refer to " 38.8.1 IP Address Setting Specification ". <ul style="list-style-type: none"> • For the host name HOST = ftp.pidsx.com
	Port number	Specify the port number. Port number range: 1 to 65535 PORT =: Port number (Default = 21)

36.2 F470 FTPcSV (FTP Client Connected Server Setting)

Setting item	Settings	
	(Can be omitted)	
	Open method (Can be omitted)	Specify the open method. Active = act / Passive = pasv OPEN =: Open method (Default = act)
	SSL/TLS authentication (Can be omitted)	Specify whether or not to use SSL/TSL authentication. SSL0: Use SSL/TLS. NON: Not use

(Note 1) Input the FTP server number, IP address or host name of FTP server, port number, open method, and SSL/TLS authentication separated by ","(commas).

(Note 2) Both upper and lower cases can be used for specifying keywords.

(Note 3) Specify the parameters for specifying servers in the order of the above table.

(Note 4) The SSL/TLS communication cannot be used by both the FTP server and FTP client at the same time. Therefore, this instruction will not be able to set SSL/TLS communication valid when it is enabled in FTP sever.

Setting example

Example 1	S1	"SV0,IPv4=192.255.2.10,PORT=21,OPEN=act,SSL0"
Settings		FTP server No.: 0, IP address: 192.255.2.10, Port No.: 21, Open method: Active, SSL/TLS authentication: Use (No client certificate alert)
Example 2	S1	"SV2,HOST=ftp.pidsx.com,PORT=28,OPEN =pasv,NON"
Settings		FTP server No.: 2, Host name: FTP.pidsx.com, Port No.: 28, Open method: Passive, SSL/TLS authentication: Not use

■ Operand S2 setting

- Specify the starting address storing the login setting parameter or a character constant.
- A part of parameters can be omitted. The settings are not changed when parameters are omitted partially.
- When omitting the part before a specified keyword, omit only "keyword" without omitting <,>.
- When omitting the part after a specified keyword, omit both <,> and "keyword".
- When specifying "INITIAL" or "KEEP" without specifying parameters, the unit operates according to the table of special keywords.
- It is prohibited to specify the same keyword redundantly. An error is caused in the case of redundant specification.

Setting item	Settings		Setting range
S2	User name (Can be omitted)	Specify a user name. Specify the keyword "USER=" at the beginning. USER=XXX (Default: root)	Max. 32 characters
	Password (Can be omitted)	Specify a password. Specify the keyword "PASS=" at the beginning. PASS=XXX (Default: Pana3755)	Max. 32 characters

(Note 1) Input a user name and password separated by a comma ",".

(Note 2) Both upper and lower cases can be used for specifying keywords.

36.2 F470 FTPcSV (FTP Client Connected Server Setting)

(Note 3) Specify the login setting parameters in the order of the above table.

Setting example

Example 1	S2	"USER=root,PASS=pidsx"
Settings		User name: root, Password: pidsx
Example 2	S2	"USER=PANASONIC,PASS=SUNX"
Settings		User name: PANASONIC, Password: SUNX

■ Settings for user name and password for operand S2

Patterns	How to specify
Specify user name: Delete password	"USER=xxx,PASS="
Delete user name: Specify password	"USER=,PASS=xxx"
Delete user name: Delete password	"USER=,PASS="
Specify user name: Not change password	"USER=xxx"
Not change user name: Specify password	",PASS=xxx"

Setting example

Example 1	S2	"USER=root,PASS="
Settings		User name: root, Password: Delete
Example 2	S2	"USER=,PASS=SUNX"
Settings		User name: Delete, Password: SUNX
Example 3	S2	"USER=,PASS="
Settings		User name: Delete, Password: Delete
Example 4	S2	"USER=root"
Settings		User name: root, Password: Not change
Example 5	S2	",PASS=SUNX"
Settings		User name: Not change, Password: SUNX

■ Special keywords for operand S2

Special keyword	Description
"INITIAL"	Set an initial value.
"KEEP"	The current setting is not changed.

Setting example

Example 1	S2	"INITIAL"
-----------	----	-----------

36.2 F470 FTPcSV (FTP Client Connected Server Setting)

Settings	User name: root, Password: Pana3755	
Example 2	S2	"KEEP"
Settings	User name: Not change, Password: Not change	

■ Operand S3 setting

- Specify the starting address storing the detailed setting parameter or a character constant.
- A part of parameters can be omitted. The settings are not changed when parameters are omitted partially.
- When omitting the part before a specified keyword, omit only "keyword" without omitting <,>.
- When omitting the part after a specified keyword, omit both <,> and "keyword".
- When specifying "INITIAL" or "KEEP" without specifying parameters, the unit operates according to the table of special keywords.
- It is prohibited to specify the same keyword redundantly. An error is caused in the case of redundant specification.

Setting item	Settings	Setting range	
S3	Timeout period (Can be omitted)	Specify a timeout period. TOUT=: Time setting (Default: 60 seconds)	30 to 300 seconds
	No. of retries (Can be omitted)	Specify the number of retries. RTRY=: No. of retries (Default: 3 times)	0 to 3
	Retry interval (Can be omitted)	Specify the retry interval. RTTM=: Retry interval (Default: 600 seconds) *4	10 to 86400 seconds

(Note 1) Input a timeout period, number of retries and retry interval separated by a comma “,”.

(Note 2) Both upper and lower cases can be used for specifying keywords.

(Note 3) Specify the detailed setting parameters in the order of the above table.

(Note 4) The retry interval can be specified by 10 seconds. It is rounded down to the nearest 10. (Example: When specifying 38 seconds, it becomes 30 seconds.)

Setting example

Example 1	S3	"TOUT=30,RTRY=2,RTTM=500"
Settings	Timeout period: 30 seconds, No. of retries: 2, Retry interval: 500 seconds	
Example 2	S3	"TOUT=270,RTRY=0,RTTM=4900"
Settings	Timeout period: 270 seconds, No. of retries: 0 (Not retry), Retry interval: 4900 seconds	
Example 3	S3	"TOUT=30,RTRY=25"
Settings	Timeout period: 30 seconds, No. of retries: 25, Retry interval: Not change	
Example 4	S3	“,RTRY=25,RTTM=3000"
Settings	Timeout period: Not change, No. of retries: 25, Retry interval: 3000 seconds	

■ Special keywords for operand S3

Special keyword	Description
"INITIAL"	Set an initial value.
"KEEP"	The current setting is not changed.

Setting example

Example 1	S3	"INITIAL"
Settings		Timeout period: 60 seconds, No. of retries: 3, Retry interval: 600 seconds
Example 2	S3	"KEEP"
Settings		Timeout period: Not change, No. of retries: Not change, Retry interval: Not change

■ Flag operations

Name	Description
R9007 R9008 (ER)	Set when a value outside the range is specified for the parameter.
	Set when the same keyword is specified redundantly.
	Set when even one request active relay of FTPc control relay or FTPc logging / trace control relay is 1: Requesting.
	Set when server numbers are not specified in the right order.
	Set when the slot number specified by F469 (UNITSEL) is not S1 =100 (Ethernet communication).
	Set when executed in an interrupt program.
R9009 (CY)	Set in the case of execution while IP address is incorrect. The detailed code to be set in DT90529 is "1: Incorrect IP address specification".
	Set when executed during the initialization of Ethernet. The detailed code to be set in DT90529 is "11: Ethernet initialization in progress".

(Note 1) For error codes stored in the system data DT90529, refer to .

36.3 F471 FTPcSET (FTP Client Transfer Setting)

36.3 F471 FTPcSET (FTP Client Transfer Setting)

■ Instruction format

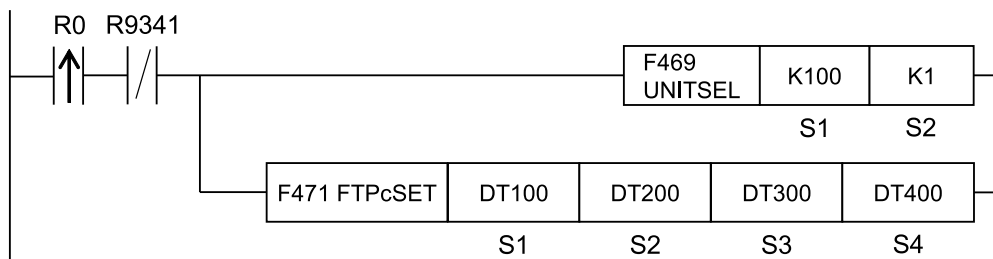

(Note 1) Specify S1=K100 (Ethernet communication) in advance using F469 UNITSEL instruction.

■ Operands

Item	Settings
S1	Specify the starting address storing the transfer setting number (string) or a character constant.
S2	Specify the starting address storing the operation setting parameter or a character constant.
S3	Specify the starting address storing the source file name or a character constant.
S4	Specify the starting address storing the destination folder name or a character constant.

■ Devices that can be specified (indicated by ●)

Operands	WX	WY	WR	WL	SV	EV	DT	LD	I	SW R	SDT	Constant			Index modifier (Note 1)
												K	H	M	
S1	●	●	●	●	●	●	●	●	●					●	●
S2	●	●	●	●	●	●	●	●	●					●	●
S3	●	●	●	●	●	●	●	●	●					●	●
S4	●	●	●	●	●	●	●	●	●					●	●

(Note 1) A character constant cannot be specified.

■ Outline of operation

- Makes the FTP client transfer setting (0 to 3).
- When this instruction is executed, the special relay R9009 (carry flag CY) and the special data register DT90529 (Ethernet communication error code) are cleared to 0. (This is set when Ethernet is initialized.)
- Confirm that "R9341: Ethernet initialization in progress" is OFF before executing the instruction.
- It is necessary to specify the settings for destination servers before executing instructions using "36.2 F470 FTPcSV (FTP Client Connected Server Setting)" or "38.9.1 Basic Setup" with the tool software.

■ Processing

- Stores the FTP client transfer settings of S2 to S4 in the transfer setting area specified by S1.
- Executable when the transfer request relay for the specified transfer setting is 0: No Request.
- The Ethernet configuration data will never be rewritten. When the configuration data has been already set, it is overwritten and the data becomes invalid.
- Data is actually sent to files or obtained from files when the FTP transfer request (F473 FTPcREQ) instruction is executed after the completion of the FTP client transfer settings.
- It is executable when the "Ethernet initialization in progress (R9341)" is OFF. If it is ON when executing the instruction, an error is set to CY flag and no operation is performed.

■ Precautions on programming

- When specifying a device for an operand specifying a character constant, set string data using F253 (SSET) instruction in advance.
- When specifying string data, the number of characters should not exceed 256.
- Upper and lower case characters can be used for an operand specifying a character constant.
("Abcd", "ABCD" and "abcd" are synonymous, however, the file names are differentiated.)
- A target unit for the instruction is specified with F469 (UNITSEL) beforehand.
- This instruction is not available in an interrupt program.

■ Operand S1 setting

- Specify the starting address storing the transfer setting number or a character constant.

Setting item	Settings		Setting range
S1	Transfer setting No.	Specify a transfer setting number. ID=: Transfer setting number	0 to 3

(Note 1) Transfer setting numbers should be specified from number 0 in ascending order. An error occurs when transfer setting numbers are not specified in ascending order. If transfer settings have been already registered, this rule is not applied.

Setting example

Example 1	S1	"ID=1"
Settings	Transfer setting number: 1	
Example 2	S1	"ID=3"
Settings	Transfer setting number: 3	

■ Operand S2 setting

- Specify the starting address storing the operation setting parameter or a character constant.

Setting item	Settings	
S2	Specification of FTP server	Specify FTP servers. (Fixed to 3 digits) SV0: Server 0, SV1: Server 1, SV2: Server 2,

36.3 F471 FTPcSET (FTP Client Transfer Setting)

Setting item	Settings		
Target and operation of transfer	Set the target for the transfer and operation.		
	Parameter string	Target	Transfer operation
	PUTFILE	File	Send to servers (Overwrite method)
	PUTFILE-OVW	File	Send to servers (Overwrite method)
	PUTFILE-REN	File	Send to servers (Rename method)
	GETFILE	File	Obtain from servers
	PUTDATA	Device	Send to servers (Overwrite method)
	PUTDATA-OVW	Device	Send to servers (Overwrite method)
	PUTDATA-REN	Device	Send to servers (Rename method)
	GETDATA	Device	Obtain from servers
File after transfer	Setting for deleting source files after transfer. (Fixed to 3 digits) DEL: Delete, NON: Not delete		

(Note 1) Operation setting parameter should be entered with each setting parameter separated by a comma “,”.

(Note 2) Operation setting parameters cannot be omitted, and should be specified in order indicated in the table above.

(Note 3) For details of the transfer operations (overwrite method and rename method), refer to ["38.9.2 Overwrite Method and Rename Method"](#).

Setting example

Example 1	S2	“SV2,PUTFILE,NON”
Settings	FTP server: 2, Target: File, Operation: Send (PUT) Overwrite method, File after transfer: Not delete	
Example 21	S2	“SV1,PUTFILE-OVW,DEL”
Settings	FTP server: 1, Target: File, Operation: Send (PUT) Overwrite method, File after transfer: Delete	
Example 3	S2	“SV0,PUTFILE-REN,DEL”
Settings	FTP server: 0, Target: File, Operation: Send (PUT) Rename method, File after transfer: Delete	
Example 4	S2	“SV2,GETFILE,DEL”
Settings	FTP server: 2, Target: File, Operation: Get (GET), File after transfer: Delete	
Example 5	S2	“SV1,GETFILE,NON”
Settings	FTP server: 1, Target: File, Operation: Get (GET), File after transfer: Not delete	

■ Operand S3 setting (when transferring files)

Specify the starting address storing the source file name or a character constant.

36.3 F471 FTPcSET (FTP Client Transfer Setting)

Setting item	Settings	
S3	Source File Name	For PUT Specify a file name in an SD card with an absolute path.
		For GET Specify a file name from the home directory of a user which logs in FTP servers with a relative path.

(Note 1) Wild cards "*" and "?" are usable for file names.

(Note 2) An error occurs when the number of files that match the wild card during GET operation is 101 or more.

■ Operand S3 setting (when putting device)

Specify the starting address storing the source device setting or a character constant.

Setting item	Settings	Setting range																	
S3	<ul style="list-style-type: none"> Device Specify device code + device number. <p>Devices that can be specified</p> <table border="1"> <thead> <tr> <th>Device</th> </tr> </thead> <tbody> <tr><td>WX</td></tr> <tr><td>WY</td></tr> <tr><td>WR (Note 5)</td></tr> <tr><td>WL</td></tr> <tr><td>DT (Note 6)</td></tr> <tr><td>LD</td></tr> <tr><td>I</td></tr> <tr><td>SV</td></tr> <tr><td>EV</td></tr> </tbody> </table>	Device	WX	WY	WR (Note 5)	WL	DT (Note 6)	LD	I	SV	EV								
	Device																		
	WX																		
WY																			
WR (Note 5)																			
WL																			
DT (Note 6)																			
LD																			
I																			
SV																			
EV																			
No. of transferred data (No. of data)	Specify the number of transferred data (number of data). * The number of data that can be transferred simultaneously is 1MB for all 4 IDs. However, they are calculated with data after conversion.	1 to 65533 (64k points)																	
Conversion method	Specify a conversion method. <table border="1"> <thead> <tr> <th colspan="2">Parameter</th> <th>Extension (Saving format)</th> </tr> </thead> <tbody> <tr> <td>BIN1w</td> <td>Unconverted 16-bit binary</td> <td>.BIN (binary data)</td> </tr> <tr> <td>US</td> <td>16-bit unsigned decimal</td> <td rowspan="5">.CSV (comma-separated text)</td> </tr> <tr> <td>SS</td> <td>16-bit signed decimal</td> </tr> <tr> <td>UL</td> <td>32-bit unsigned decimal</td> </tr> <tr> <td>SL</td> <td>32-bit signed decimal</td> </tr> <tr> <td>SF</td> <td>32-bit single-precision floating point</td> </tr> </tbody> </table>	Parameter		Extension (Saving format)	BIN1w	Unconverted 16-bit binary	.BIN (binary data)	US	16-bit unsigned decimal	.CSV (comma-separated text)	SS	16-bit signed decimal	UL	32-bit unsigned decimal	SL	32-bit signed decimal	SF	32-bit single-precision floating point	
Parameter		Extension (Saving format)																	
BIN1w	Unconverted 16-bit binary	.BIN (binary data)																	
US	16-bit unsigned decimal	.CSV (comma-separated text)																	
SS	16-bit signed decimal																		
UL	32-bit unsigned decimal																		
SL	32-bit signed decimal																		
SF	32-bit single-precision floating point																		

36.3 F471 FTPcSET (FTP Client Transfer Setting)

Setting item	Settings			Setting range										
		<table border="1"> <thead> <tr> <th colspan="2">Parameter</th> <th>Extension (Saving format)</th> </tr> </thead> <tbody> <tr> <td>HEX1w</td> <td>16bitHEX</td> <td rowspan="3"></td> </tr> <tr> <td>HEX2w</td> <td>32bitHEX</td> </tr> <tr> <td>ASCII</td> <td>ASCII character (Output enclosed with "")</td> </tr> </tbody> </table>		Parameter		Extension (Saving format)	HEX1w	16bitHEX		HEX2w	32bitHEX	ASCII	ASCII character (Output enclosed with "")	
Parameter		Extension (Saving format)												
HEX1w	16bitHEX													
HEX2w	32bitHEX													
ASCII	ASCII character (Output enclosed with "")													
	Line feed position	Specify line feed position. 0: Output the end of file only n: Output by n data		0 to 255										

(Note 1) Source device setting should be entered with each setting parameter separated by a comma “,”.

(Note 2) Specify the operation setting parameters in the order of the above table.

(Note 3) When omitting "conversion method" and subsequent items, the conversion method is set to 16-bit binary and the line feed position is set to 0 (Output the end of file only).

(Note 4) When omitting "Line feed position", it is set to 0: Output the end of file only.

(Note 5) Possible to specify the special relay (starting from WR900).

(Note 6) Possible to specify the special data register (starting from DT90000).

Setting example

Example 1	S3	“WX16,32,BIN1w,0”
Settings		Device setting, Device code: WX, Device No.: 16, No. of transferred data: 32 points (32 words), Conversion method: Unconverted 16-bit binary, Line feed position: Output the end of file only
Example 2	S3	“DT12345,250,SS,10”
Settings		Device setting, Device code: DT, Device No.: 12345, No. of transferred data: 250 points (250 words), Conversion method: 16-bit signed decimal, Line feed position: Output by 10 data
Example 3	S3	“WR0,16,SF”
Settings		Device setting, Device code: WR, Device No.: 0, No. of transferred data: 16 points (32 words), Conversion method: 32-bit single-precision floating point, Line feed position: Output the end of file only
Example 4	S3	“WL10,64”
Settings		Device setting, Device code: WL, Device No.: 10, No. of transferred data: 64 points (64 words), Conversion method: Unconverted 16-bit binary, Line feed position: Output the end of file only

■ Operand S3 setting (when getting device)

Specify the starting address storing the destination device setting or a character constant.

Setting item	Settings		Setting range
S3	Destination device	• Device	

36.3 F471 FTPcSET (FTP Client Transfer Setting)

Setting item	Settings	Setting range																							
	<p style="text-align: center;">Specify device code + device number.</p> <p>Devices that can be specified</p> <table border="1" style="width: 100%; border-collapse: collapse;"> <thead> <tr style="background-color: #d9e1f2;"> <th style="text-align: left;">Global device</th> </tr> </thead> <tbody> <tr><td>WX</td></tr> <tr><td>WY</td></tr> <tr><td>WR^(Note 5)</td></tr> <tr><td>WL</td></tr> <tr><td>DT^(Note 6)</td></tr> <tr><td>LD</td></tr> <tr><td>I</td></tr> <tr><td>SV</td></tr> <tr><td>EV</td></tr> </tbody> </table>	Global device	WX	WY	WR ^(Note 5)	WL	DT ^(Note 6)	LD	I	SV	EV														
Global device																									
WX																									
WY																									
WR ^(Note 5)																									
WL																									
DT ^(Note 6)																									
LD																									
I																									
SV																									
EV																									
No. of transferred data (No. of data)	<p>Specify the number of transferred data (number of data). * The number of data that can be transferred simultaneously is 1MB for all 4 IDs. They are calculated with file size.</p>	1 to 65533 (64k points)																							
Conversion method	<p>Specify a conversion method.</p> <table border="1" style="width: 100%; border-collapse: collapse;"> <thead> <tr style="background-color: #d9e1f2;"> <th colspan="2" style="text-align: left;">Parameter</th> <th style="text-align: left;">Extension (Saving format)</th> </tr> </thead> <tbody> <tr> <td style="width: 15%;">BIN1w</td> <td style="width: 55%;">Unconverted 16-bit binary</td> <td style="width: 30%;">.BIN (binary data)</td> </tr> <tr> <td>US</td> <td>16-bit unsigned decimal</td> <td rowspan="8">.CSV (comma-separated text)</td> </tr> <tr> <td>SS</td> <td>16-bit signed decimal</td> </tr> <tr> <td>UL</td> <td>32-bit unsigned decimal</td> </tr> <tr> <td>SL</td> <td>32-bit signed decimal</td> </tr> <tr> <td>SF</td> <td>32-bit single-precision floating point</td> </tr> <tr> <td>HEX1w</td> <td>16bitHEX</td> </tr> <tr> <td>HEX2w</td> <td>32bitHEX</td> </tr> <tr> <td>ASCII</td> <td>ASCII character (Output enclosed with "")</td> </tr> </tbody> </table>	Parameter		Extension (Saving format)	BIN1w	Unconverted 16-bit binary	.BIN (binary data)	US	16-bit unsigned decimal	.CSV (comma-separated text)	SS	16-bit signed decimal	UL	32-bit unsigned decimal	SL	32-bit signed decimal	SF	32-bit single-precision floating point	HEX1w	16bitHEX	HEX2w	32bitHEX	ASCII	ASCII character (Output enclosed with "")	
Parameter		Extension (Saving format)																							
BIN1w	Unconverted 16-bit binary	.BIN (binary data)																							
US	16-bit unsigned decimal	.CSV (comma-separated text)																							
SS	16-bit signed decimal																								
UL	32-bit unsigned decimal																								
SL	32-bit signed decimal																								
SF	32-bit single-precision floating point																								
HEX1w	16bitHEX																								
HEX2w	32bitHEX																								
ASCII	ASCII character (Output enclosed with "")																								

(Note 1) Source device setting should be entered with each setting parameter separated by a comma “,”.

(Note 2) Specify the operation setting parameters in the order of the above table.

(Note 3) When omitting "Conversion method", it is set to unconverted 16-bit binary.

(Note 4) The number of data that can be transferred simultaneously is 1MB for all 4 IDs. They are calculated with file size.

(Note 5) Not possible to specify the special relay (starting from WR900).

(Note 6) Not possible to specify the special data register (starting from DT90000).

36.3 F471 FTPcSET (FTP Client Transfer Setting)

Setting example

Example 1	S3	"WX16,32,BIN1w"
Settings		Device setting, Device code: WX, Device No.: 16, No. of transferred data: 32 points (32 words), Conversion method: Unconverted 16-bit binary
Example 2	S3	"DT12345,250,SS"
Settings		Device setting, Device code: DT, Device No.: 12345, No. of transferred data: 250 points (250 words), Conversion method: 16-bit signed decimal
Example 3	S3	"WR0,16,SF"
Settings		Device setting, Device code: WR, Device No.: 0, No. of transferred data: 16 points (32 words), Conversion method: 32-bit single-precision floating point
Example 4	S3	"WL10,64"
Settings		Device setting, Device division: Global, Device code: WL, Device No.: 10, No. of transferred data: 64 points (64 words), Conversion method: Unconverted 16-bit binary

■ Operand S4 setting (when transferring files)

Specify the starting address storing the destination folder name or a character constant.

Setting item	Settings	
S4	Destination file name	<p>For PUT Specify a folder name from the home directory of a user which logs in FTP servers with a relative path. For specifying the home directory, <><> specify </> or <\> only.</p> <p>For GET Specify a storage folder name in an SD card with an absolute path.</p>

(Note 1) When no destination folders exist, they are automatically created up to eight hierarchies.

■ Operand S4 setting (when putting device)

Specify the starting address storing the destination file setting or a character constant.

Setting item	Settings	
S4	Destination file name	<p>Specify a destination file name. Specify a folder name and file name from the home directory of a user which logs in FTP servers with a relative path. * The string after the last "." (period) is applied as an extension of file name.</p>
	File name automatic addition position	<p>Specify the position of the automatic additional data added to a file name. TOP: Automatic additional data is added before a file name. END: Automatic additional data is added after a file name. * Automatic additional data is given in year, month, day, hour, minute and second "(yymmdd_hhmmss)".</p>

(Note 1) Specify a destination file name within 240 characters.

(Note 2) When no destination folders exist, they are automatically created up to eight hierarchies.

36.3 F471 FTPcSET (FTP Client Transfer Setting)

(Note 3) Specify the operation setting parameters in the order of the above table.

(Note 4) When omitting "File name automatic addition position", automatic additional data is not added to a file name.

Setting example

Example 1	S4	"\ftp\PutData1.bin, TOP"
Settings		Destination file name: \ftp\PutDdata1.bin, Time data addition setting: Add year-month-day data, Automatic addition position: Add automatic additional data before file name
Example 2	S4	"\ftp\PutData2.bin, END"
Settings		Destination file name: \ftp\PutDdata2.bin, Time data addition setting: Add time data, Automatic addition position: Add automatic additional data after file name
Example 3	S4	"\ftp\PutData3.bin"
Settings		Destination file name: \ftp\PutDdata3.bin, Time data addition setting: Add year-month-day data and time data, Automatic addition position: Not add automatic additional data to file name

■ Operand S4 setting (when getting device)

Specify the starting address storing the source file name or a character constant.

Setting item	Settings	
S4	Source File Name	Specify the starting address storing the source file name or a character constant.

(Note 1) Specify a folder name and file name from the home directory of a user which logs in FTP servers with a relative path.

■ Flag operations

Name	Description
R9007 R9008 (ER)	Set when a value outside the range is specified for the parameter.
	Set when the slot number specified by F469 (UNITSEL) is not S1=100 (Ethernet communication).
	Set when transfer setting numbers are not specified in ascending order.
	Set when executed in an interrupt program.
	Set when the number of characters for an operand specifying a character constant exceeds 256.
	Set when an FTP server that has not been specified with the destination server setting instruction or the tool software is specified.
R9009 (CY)	To be set in the case of execution during Ethernet initialization. The detailed code to be set in DT90529 is "11: Ethernet initialization in progress".

(Note 1) For error codes stored in the system data DT90529, refer to .

36.4 F472 FTPcLOG (Logging / Trace Transfer Setting)

■ Instruction format

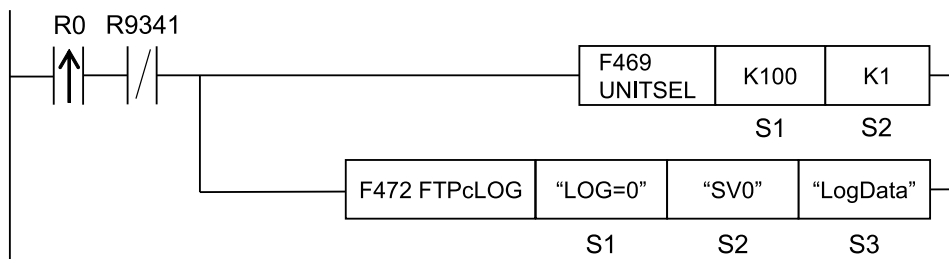

(Note 1) Specify S1=K100 (Ethernet communication) in advance using F469 UNITSEL instruction.

■ Operands

Item	Settings
S1	Specify the starting address storing the logging / trace number (string) or a character constant.
S2	Specify the starting address storing the operation setting parameter or a character constant.
S3	Specify the starting address storing the destination folder name or a character constant.

■ Devices that can be specified (indicated by ●)

Operands	WX	WY	WR	WL	SV	EV	DT	LD	I	SW R	SDT	Constant			Index modifier (Note 1)
												K	H	M	
S1	●	●	●	●	●	●	●	●	●					●	●
S2	●	●	●	●	●	●	●	●	●					●	●
S3	●	●	●	●	●	●	●	●	●					●	●

(Note 1) A character constant cannot be specified.

■ Outline of operation

- Makes the logging / trace transfer setting.
- When this instruction is executed, the special relay R9009 (carry flag CY) and the special data register DT90529 (Ethernet communication error code) are cleared to 0. (This is set when Ethernet is initialized.)
- Confirm that "R9341: Ethernet initialization in progress" is OFF before executing the instruction.

■ Processing

- Stores the logging / trace transfer settings of S2 to S3 in the logging / trace transfer setting area specified by S1.
- It is executable when the transfer request relay of the FTPc logging / trace control relay for a specified logging/trace is 0: No request. (When requested, an operation error occurs.)
- It is executable when the "Ethernet initialization in progress (R9341)" is OFF. If it is ON when executing the instruction, an error is set to CY flag and no operation is performed.

■ Precautions on programming

- When specifying a device for an operand specifying a character constant, set string data using F253 (SSET) instruction in advance.
- When specifying string data, the number of characters should not exceed 256.
- Upper and lower case characters can be used for an operand specifying a character constant.
("Abcd", "ABCD" and "abcd" are synonymous, however, the file names are differentiated.)
- A target unit for the instruction is specified with F469 (UNITSEL) beforehand.
- This instruction is not available in an interrupt program.

■ Operand S1 setting

- Specify the starting address storing the logging / trace number (string) or a character constant.

Setting item	Settings		Setting range
S1	LOG No.	Specify LOG number. LOG=: LOG number	0 to 3

■ Operand S2 setting

- Specify the starting address storing the operation setting parameter or a character constant.
- Only one server can be specified at the same time. Specify a FTP server number with one-byte three characters.

Setting item	Settings		Setting range
S2	Specification of FTP server (Essential)	Specify FTP servers. Specify the following keywords. SV0: Server 0 SV1: Server 1 SV2: Server 2	0 to 2
	Specification of transfer operation (Can be omitted)	Select the operation for transferring logging / trace files. Specify the operation after the keyword "MODE=". MODE=xxxx	

(Note 1) Operation setting parameter should be entered with each setting parameter separated by a comma ",".

(Note 2) Specify the operation setting parameters in the order of the above table. The order of keywords cannot be changed.

(Note 3) Upper and lower case characters can be used for specifying keywords.

■ Operand S2 transfer operation setting

Settings	Set value	Operation
Overwrite method (Default)	OVW	Performs transfer files with files names specified by the logging / trace setting. When the transfer is interrupted due to any trouble with network or servers, the files transferred partway remain in servers. Confirm if the transfer has succeeded with an instruction such as F465 (ETSTAT) instruction.

36.4 F472 FTPcLOG (Logging / Trace Transfer Setting)

Settings	Set value	Operation
Rename method	REN	Performs transfer files with temporary file names, and renames them to specified file names after the success of the transfer. The successful completion of file transfer can be confirmed by checking the file names specified by the logging / trace setting. The processing time is longer than that of the overwrite method.

(Note 1) When either method is not specified, "Overwrite method" is applied.

Setting example

Example 1	S2	"SV0,MODE=OVW"
Settings	FTP server: 0, Transfer operation: Overwrite method	
Example 2	S2	"SV3,MODE=REN"
Settings	FTP server: 2, Transfer operation: Rename method	
Example 3	S2	"SV1"
Settings	FTP server: 1, Transfer operation: (Omitted)	

■ Operand S3 setting

- Specify the starting address storing the destination folder name or a character constant.
- Specify a destination folder name within 256 characters.

Setting item	Settings	Setting range
S3	Destination folder name	Specify the starting address storing the destination folder name or a character constant. Max. 256 characters

(Note 1) When no destination folders exist, they are automatically created up to eight hierarchies.

(Note 2) Specify a folder name from the home directory of a user which logs in FTP servers with a relative path.

■ Flag operations

Name	Description
R9007 R9008 (ER)	Set when the slot number specified by F469 (UNITSEL) is not S1 =100 (Ethernet communication).
	Set when the request active relay of the FTPc logging / trace control relay for a specified number is 1: Requesting.
	Set when the logging / trace condition of a specified LOGn number is not registered.
	Set when a value outside the range is specified for the parameter.
	Set when executed in an interrupt program.
	Set when the number of characters for an operand specifying a character constant exceeds 256.
R9009 (CY)	Set when an unset FTP server is specified.
R9009 (CY)	Set when executed during the initialization of Ethernet. The detailed code to be set in DT90529 is "11: Ethernet initialization in progress".

36.5 F473 FTPcREQ (FTP Client Transfer Request)

■ Instruction format

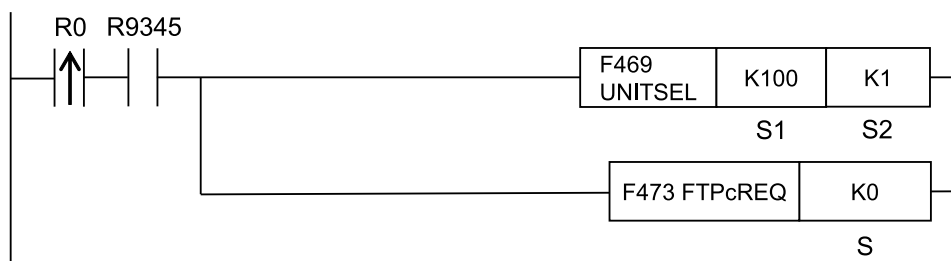

(Note 1) Specify S1=K100 (Ethernet communication) in advance using F469 UNITSEL instruction.

■ Operand

Item	Settings
S	Specify the device address storing the transfer number (0 to 3) or a constant.

■ Devices that can be specified (indicated by ●)

Operand	WX	WY	WR	WL	SV	EV	DT	LD	I	SW R	SDT	Constant			Index modifier (Note 1)
												K	H	M	
S	●	●	●	●	●	●	●	●	●			●	●		●

(Note 1) A character constant cannot be specified.

■ Outline of operation

- Requests the transfer of FTP client.
- When this instruction is executed, the special relay R9009 (carry flag CY) and the special data register DT90529 (Ethernet communication error code) are cleared to 0. (Set when an Ethernet cable is disconnected or Ethernet is initialized.)
- Check if "R9345: FTP client preparation done" is ON before executing the instruction.
- It is necessary to specify the transfer settings before executing the instruction using "36.3 F471 FTPcSET (FTP Client Transfer Setting)" or "38.9.3 FTP File Transfer Settings (Sending Files)" to "38.9.6 FTP File Transfer Settings (Getting Device)" with the tool software.

■ Processing

- Turns ON the transfer request relay of the transfer number specified by [S].
- It can be executed when the "FTP client preparation done (R9345)" is ON. If it is OFF when executing the instruction, an operation error occurs.
- It is executable when the "Cable disconnection (R9340)" is OFF. If it is ON when executing the instruction, an error is set to CY flag and no operation is performed.
- It is executable when the "Ethernet initialization in progress (R9341)" is OFF. If it is ON when executing the instruction, an error is set to CY flag and no operation is performed.

36.5 F473 FTPcREQ (FTP Client Transfer Request)

- When it is executed under the following condition, an error code is set to the execution done code as a transfer error.

Status	Code	Status	Code
Destination server is not set.	1	Transfer canceled setting	6
Transfer setting is not set.	2	Transfer failed	7
Registering a process request failed.	4	Data decompression failed. (When accessing data with PUT)	8
Transfer prohibition setting	5	Data decompression failed. (When accessing data with GET)	9

■ Precautions on programming

- This instruction is not available in an interrupt program.

■ Operand S setting

Setting item	Settings	Setting range
S	Transfer No. Specify the device address storing a transfer number or a constant.	0 to 3

■ Timing chart

- It shows the process that a transfer request was executed and data was obtained successfully from a server to FP0H.
- The control relays (bit0 to bit15) can be monitored by reading arbitrary operation devices with F465 (ETSTAT) instruction.

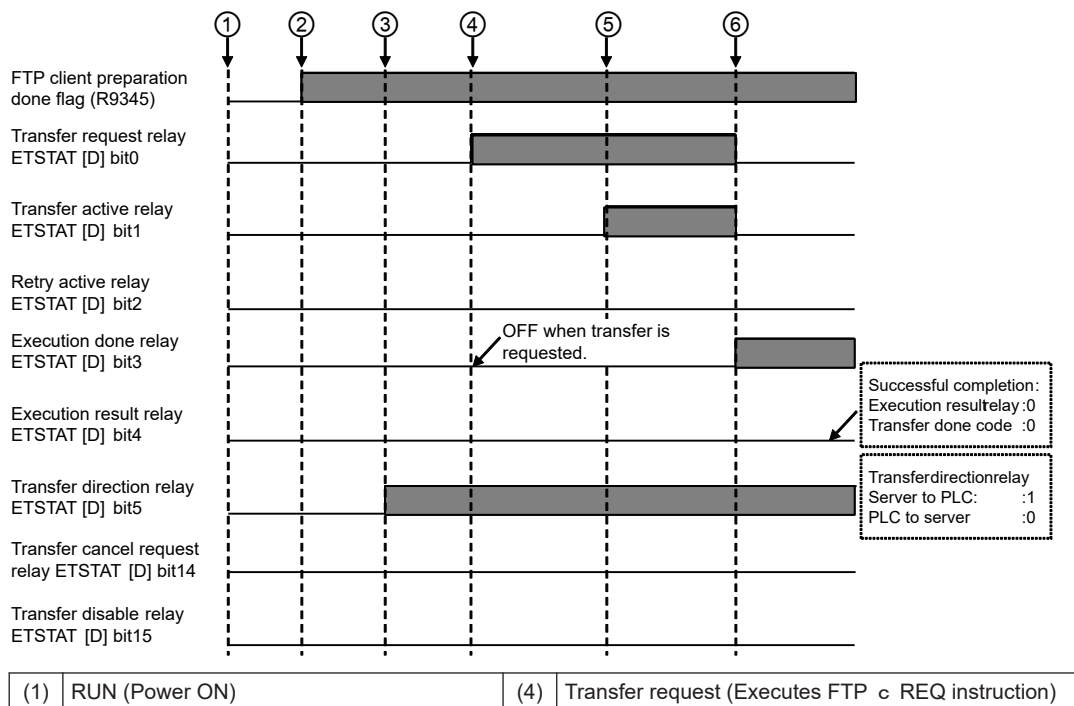

36.5 F473 FTPcREQ (FTP Client Transfer Request)

(2)	FTP client preparation done	(5)	FTP client login succeeded (Starts transfer)
(3)	Transfer setting (Executes FTPcSET instruction)	(6)	Transfer process done (Completes the execution of F473 (FTPcREQ) instruction)

■ Control relay

Name	Bit No.	Description
Transfer request relay	0	0: No request, 1: Request
Transfer active relay	1	0: Stop, 1: During transfer
Retry active relay	2	0: No retry, 1: During retry
Execution done relay	3	0: During process, 1: Instruction execution complete
Execution result relay	4	0: Normal 1: Failed
Transfer direction relay	5	0: Send, 1: Receive
Reserved for system	6 to 13	—
Transfer cancel request relay	14	0: Not cancel, 1: Cancel
Transfer disable relay	15	0: Transfer enabled, 1: Transfer disabled

(Note 1) The state of control relays can be read with F465 (ETSTAT) instruction.

■ Done codes

Name	Number of words	Description
Execution done code	1	Execution done code
Transfer done code	1	Response code of FTP client

(Note 1) The state of done codes can be read with F465 (ETSTAT) instruction.

■ Special relays

Name	Description
FTP client preparation done (R9345)	0: FTP client preparation incomplete, 1: FTP client preparation complete

■ Flag operations

Name	Description
R9007 R9008 (ER)	Set when the slot number specified by F469 (UNITSEL) is not S1 =100 (Ethernet communication).
	Set when the range is exceeded during indirect access (index modification).
	Set when the FTP client preparation done (R9345) is OFF at the time of the execution of instruction.
	Set when a value outside the range is specified for the parameter.
	Set when the transfer request relay of a specified ID is "Request".
	Set when executed in an interrupt program.
	Set when a file transfer that has not been specified with the transfer setting instruction or the tool software is specified.

36.5 F473 FTPcREQ (FTP Client Transfer Request)

Name	Description
R9009 (CY)	Set when executed while the Ethernet cable is disconnected. The detail code set in DT90529 is "10: Ethernet cable disconnected". To be set in the case of execution during Ethernet initialization. The detailed code to be set in DT90529 is "11: Ethernet initialization in progress".

(Note 1) For error codes stored in the system data DT90529, refer to .

36.6 F474 FTPcCTL (FTP Client Transfer Control)

■ Instruction format

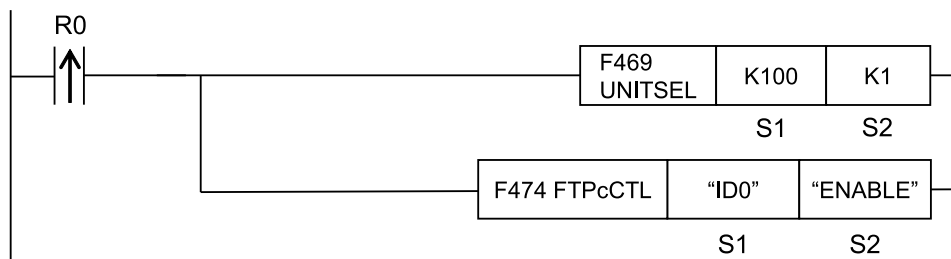

(Note 1) Specify S1=K100 (Ethernet communication) in advance using F469 UNITSEL instruction.

■ Operands

Item	Settings
S1	Specify the target to be controlled with the starting address or a character constant.
S2	Specify the controlled contents (transfer enabled / disabled / canceled) with the starting address or a character constant.

■ Devices that can be specified (indicated by ●)

Operands	WX	WY	WR	WL	SV	EV	DT	LD	I	SW R	SDT	Constant			Index modifier (Note 1)
												K	H	M	
S1	●	●	●	●	●	●	●	●	●					●	●
S2	●	●	●	●	●	●	●	●	●					●	●

(Note 1) A character constant cannot be specified.

■ Outline of operation

- Sets to enable, disable or cancel the transfer of FTP client.
- When this instruction is executed, the special relay R9009 (carry flag CY) and the special data register DT90529 (Ethernet communication error code) are cleared to 0.
(This is set when Ethernet is initialized.)
- It is necessary to specify the transfer settings before executing the instruction using "36.3 F471 FTPcSET (FTP Client Transfer Setting)" or "38.9.3 FTP File Transfer Settings (Sending Files)" to "38.9.6 FTP File Transfer Settings (Getting Device)" with the tool software. (when control targets are specified with send numbers)
- It is necessary to specify the transfer settings before executing the instruction using "36.4 F472 FTPcLOG (Logging / Trace Transfer Setting)" or "38.10.2 Logging / Trace Transfer Settings" with the tool software. (when control targets are specified with LOG numbers)
- It takes some time to accept the processing of the transfer cancel request. Check the transfer status and check if the transfer stops after executing the instruction. For the method of transfer status checking, refer to "36.1 F465 ETSTAT (Acquire Ethernet Unit Information: FTP)".

36.6 F474 FTPcCTL (FTP Client Transfer Control)

■ Processing

- Controls to enable, disable or cancel the transfer for the target **S1** according to the specification of the control content **S2**.
- It is executable when the "Ethernet initialization in progress (R9341)" is OFF. If it is ON when executing the instruction, an error is set to CY flag and no operation is performed.

■ Details of setting parameters

Setting item	Settings		
S1	Control target	1) When specifying transfer numbers individually	Specify 0 to 3 for x with "IDx".
		2) When specifying LOG numbers individually	Specify 0 to 3 for x with "LOGx".
		3) When specifying all transfer numbers and LOG numbers	Specify "ALL".
S2	Control content	1) When enabling transfer	Specify "ENABLE".
		2) When disabling transfer	Specify "DISABLE".
		3) When canceling transfer	Specify "CANCEL".

■ Precautions on programming

- When specifying a device for an operand specifying a character constant, set string data using F253 (SSET) instruction in advance.
- When specifying string data, the number of characters should not exceed 256.
- Upper and lower case characters can be used for an operand specifying a character constant.
("Abcd", "ABCD" and "abcd" are synonymous, however, the file names are differentiated.)
- A target unit for the instruction is specified with F469 (UNITSEL) beforehand.
- This instruction is not available in an interrupt program.

■ Operation of FTPc control relay

Name	Transfer enabled	Transfer disabled	Transfer canceled
Transfer cancel relay	Not change	Not change	ON
Transfer disable relay	OFF	ON	Not change
Transfer request	Not change	Not change	Not change
Transfer active	Not change	Not change	Not change
Transfer retry active	Not change	Not change	Not change
Transfer done	Not change	Not change	Not change
Transfer failed	Not change	Not change	Not change
Transfer direction	Not change	Not change	Not change

(Note 1) The state of control relays can be read with F465 (ETSTAT) instruction.

Setting example

36.6 F474 FTPcCTL (FTP Client Transfer Control)

	Settings	S1	S2										
Example 1	When enabling the sending of send No. 1	"ID1"	"ENABLE"										
Example 2	When disabling all sending items	"ALL"	"DISABLE"										
Example 3	When canceling the sending of LOG3	"LOG3"	"CANCEL"										
Example 4	When enabling the sending of send No. 3 (Note)	DT0	DT10										
		<table border="1"> <thead> <tr> <th></th> <th>Value</th> </tr> </thead> <tbody> <tr> <td>DT0</td> <td>3 (No. of characters)</td> </tr> <tr> <td>DT1</td> <td>H44(D) H49(I)</td> </tr> <tr> <td>DT2</td> <td> H33(3)</td> </tr> <tr> <td>DT3</td> <td> </td> </tr> </tbody> </table>			Value	DT0	3 (No. of characters)	DT1	H44(D) H49(I)	DT2	H33(3)	DT3	
			Value										
		DT0	3 (No. of characters)										
		DT1	H44(D) H49(I)										
		DT2	H33(3)										
DT3													
<table border="1"> <thead> <tr> <th></th> <th>Value</th> </tr> </thead> <tbody> <tr> <td>DT10</td> <td>6 (No. of characters)</td> </tr> <tr> <td>DT11</td> <td>H4E(N) H45(E)</td> </tr> <tr> <td>DT12</td> <td>H42(B) H41(A)</td> </tr> <tr> <td>DT13</td> <td>H45(E) H4C(L)</td> </tr> <tr> <td>DT14</td> <td> </td> </tr> </tbody> </table>			Value	DT10	6 (No. of characters)	DT11	H4E(N) H45(E)	DT12	H42(B) H41(A)	DT13	H45(E) H4C(L)	DT14	
	Value												
DT10	6 (No. of characters)												
DT11	H4E(N) H45(E)												
DT12	H42(B) H41(A)												
DT13	H45(E) H4C(L)												
DT14													

(Note 1) For specifying a device for an operand specifying a character constant, store string data with F253 (SSET) instruction excluding a double quotation mark.

■ Flag operations

Name	Description
R9007 R9008 (ER)	Set when any items other than "IDx" or "LOGx" or "ALL" are specified for the control target (S1). (x: 0 to 3)
	Set when an unset transfer setting is specified.
	Set when an unset logging / trace transfer setting is specified.
	Set when any items other than "ENABLE", "DISABLE" or "CANCEL" are specified for the control content (S2).
	Set when the slot number specified by F469 (UNITSEL) is not S1=100 (Ethernet communication).
	Set when executed in an interrupt program.
	Set when the number of characters for an operand specifying a character constant exceeds 256.
	Set when a file transfer that has not been specified with the transfer setting instruction or the tool software is specified.
Set when a logging / trace transfer setting that has not been specified with the logging / trace transfer setting instruction or the tool software is specified.	
R9009 (CY)	Set when executed during the initialization of Ethernet. The detailed code to be set in DT90529 is "11: Ethernet initialization in progress".

(Note 1) For error codes stored in the system data DT90529, refer to .

(MEMO)

37 Precautions for Programming

37.1	Changing the Set Value of Timer/Counter During RUN	37-2
37.1.1	How to Rewrite Constants in the Program	37-2
37.1.2	Methods Used to Rewrite a Value in the Set Value Area	37-2
37.2	Use of Duplicate Output.....	37-5
37.2.1	Duplicate Output	37-5
37.2.2	Processing When Output Is Duplicated with OT, KP, SET, and RST Instructions	37-5
37.3	Rise Detection Method.....	37-7
37.3.1	Rise Detection Instructions	37-7
37.3.2	Operation and Precautions at Run Start Time	37-8
37.3.3	Precautions When Using Control Instructions	37-10
37.4	Operation Errors	37-13
37.4.1	What is an operation error?	37-13
37.4.2	Operation Mode when an Operation Error Occurs	37-13
37.4.3	Handling the Occurrence of Operation Errors.....	37-14
37.4.4	Points to Review in Program.....	37-14
37.5	How to Use the Index Register	37-16
37.5.1	Index Registers	37-16
37.5.2	Index Modification Applicable Areas	37-16
37.5.3	Example of Using an Index Register.....	37-17
37.6	Handling BCD Data.....	37-19
37.7	Precautions for Programming	37-21
37.8	Rewrite Function During RUN.....	37-23
37.8.1	Operation of Rewrite During RUN.....	37-23
37.8.2	When Rewriting During RUN is not Possible	37-23
37.8.3	Method and Operation of Rewriting during RUN	37-25
37.9	Processing During Forced Input/Output	37-26

37.1 Changing the Set Value of Timer/Counter During RUN

37.1 Changing the Set Value of Timer/Counter During RUN

37.1.1 How to Rewrite Constants in the Program

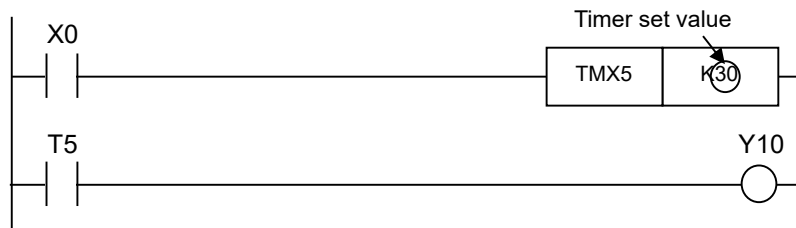

Method using programming tool software

Here is an example of changing the set value of timer 5 from K30 to K50.

1 2 Procedure

1. Place the cursor on the timer 5 set value K30.
2. Enter the new constant K50, and press the Enter key.
3. Finalize the program by using [PB conversion] or [project conversion], and write it to the main unit.

Operation and cautions after the change

- When the program is changed using programming tool software, the timers and counters in operation will continue to operate unchanged. The program will start operating with the changed settings after the next execution condition changes from OFF to ON.
- When the constants in the program are rewritten, the program itself is rewritten, so when the mode is switched and RUN again, or when the power is turned off and on, the program is preset with the changed settings.

37.1.2 Methods Used to Rewrite a Value in the Set Value Area

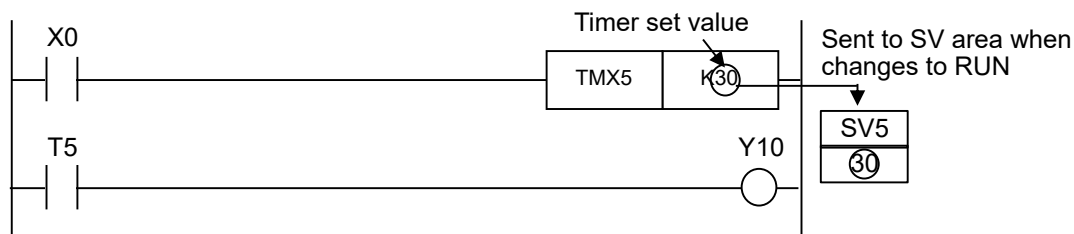

Changing a value in set value area SV

A value in set value area SV can be rewritten under the following conditions.

- Rewriting methods:
 1. Method using programming tool software
 2. Method using a program (high-level instruction)

Operation and cautions after the change

37.1 Changing the Set Value of Timer/Counter During RUN

- After the change, the active timer/counter will continue to run. The program will start operating with the changed settings after the next execution condition changes from OFF to ON.
- With these methods, the value in set value area SV will change; however, the program itself is not rewritten. Therefore, when the mode is changed and then set back to RUN, or when the power is turned back on, the operation will be as follows.
 1. When the set value is specified by a K constant
The K constant is preset in set value area SV. After the change, the value will no longer be valid.
 2. When the set value is specified by a set value area number
In the case of a non-hold-type timer/counter, 0 is preset in set value area SV. In the case of a hold-type timer/counter, the value changed by the method on the previous page is preset in set value area SV.

Method 1: Using programming tool software

From the menu bar, select: **Online>Device Monitor**.

The screenshot shows the 'Device monitor1' window with a table of monitored devices. The table has five columns: No., Device, Current value, Data type, and Comments. The rows are numbered 1 through 12. The 'Current value' column shows values for R10 (1), R11 (0), X0 (1), X1 (0), DT0 (15), DT1 (32000), DT100 (-30), and WR20 (03A0). The 'Data type' column shows 'Signed 16-bit integer' for DT0, DT1, DT100, and WR20. The 'Comments' column is empty for all rows.

(1) No.	(2) Device	(3) Current value	(4) Data type	(5) Comments
1	R10	1	---	
2	R11	0	---	
3				
4	X0	1	---	
5	X1	0	---	
6				
7	DT0	15	Signed 16-bit integer	
8	DT1	32000	Signed 16-bit integer	
9	DT100	-30	Signed 16-bit integer	
10	WR20	03A0	Signed 16-bit integer	
11				
12				

		Description
(1)	No.	Displays the line number.
(2)	Device	Pressing the<Enter>key or double-clicking in this field displays the device code and device number.
(3)	Current value	Displays the monitored data value. During online monitoring, data can be changed by pressing the<Enter>key or double-clicking in this field.
(4)	Data type	Pressing the<Enter>key or double-clicking in this field displays the number base (decimal, hexadecimal, binary, ASCII) and number of words to be monitored.
(5)	Comments	Displays the I/O comments for each register. I/O comments can be added for each register by pressing the<Enter>key or double-clicking in this field.

(Note 1) For details, see the FPCWIN GR7 help menu.

Method 2: Using a program (high-level instruction)

To change the set value of a timer/counter based on an input condition, etc., use a high-level instruction as shown below to rewrite the value in set value area SV of the relevant timer or counter.

37.1 Changing the Set Value of Timer/Counter During RUN

Example: Changing the set value to K20 when input X0 turns ON

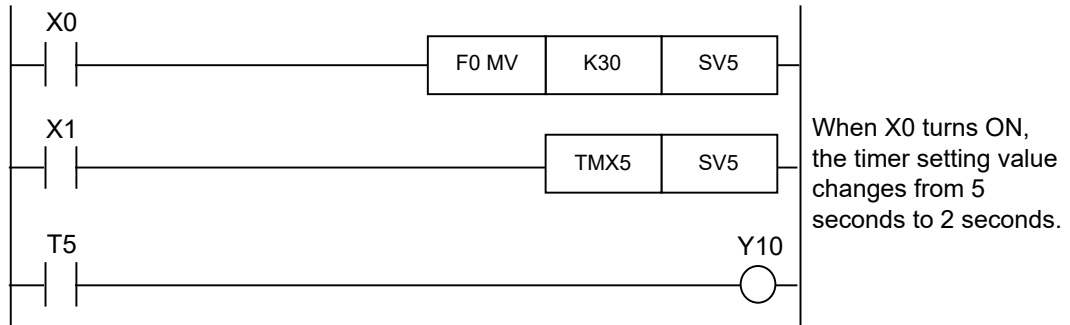

The SV area can also be specified directly in the set value area. The set value can be changed by changing the value to be transmitted, using the F0 instruction, etc.

37.2 Use of Duplicate Output

37.2.1 Duplicate Output

- Duplicate output refers to repeatedly specifying the same output in a single sequence program.
- If the same output is specified for the **OT** and **KP** instructions, it is considered duplicate output.
- Even if the same output is used for **SET** instructions, **RST** instructions or high-level instructions (such as data transfer), it is not considered duplicate output.
- If you enter "RUN mode" while the duplicate output condition exists, under normal circumstances an error will result. (ERR/ALM LED blinks and the self-diagnostic flag R9000 turns ON.)

■ How to check for duplicate output

You can check for duplicate output in the program using a programming tool and the following method.

Execute the project's Total Check function from the menu.

If there is duplicate output, an error message [duplicate use (definition) error] and the address are displayed.

■ Enabling duplicate output

- If you need to use output repeatedly due to the content of the program, duplicate output can be enabled.
- To do this, change the content of system register No. 20 to "enable".
- In this case, an error will not result even if the program is executed.

37.2.2 Processing When Output Is Duplicated with OT, KP, SET, and RST Instructions

■ Status of internal and output relays during operation

If instructions that output to internal and output relays, such as the OT instruction, KP instruction, SET instruction, RST instruction, and transfer instructions, are executed in duplicate, the contents are rewritten at each step during operation.

37.2 Use of Duplicate Output

<Example> Processing when the SET instruction, RST instruction, and OT instruction are used (X0 to X2 are all ON)

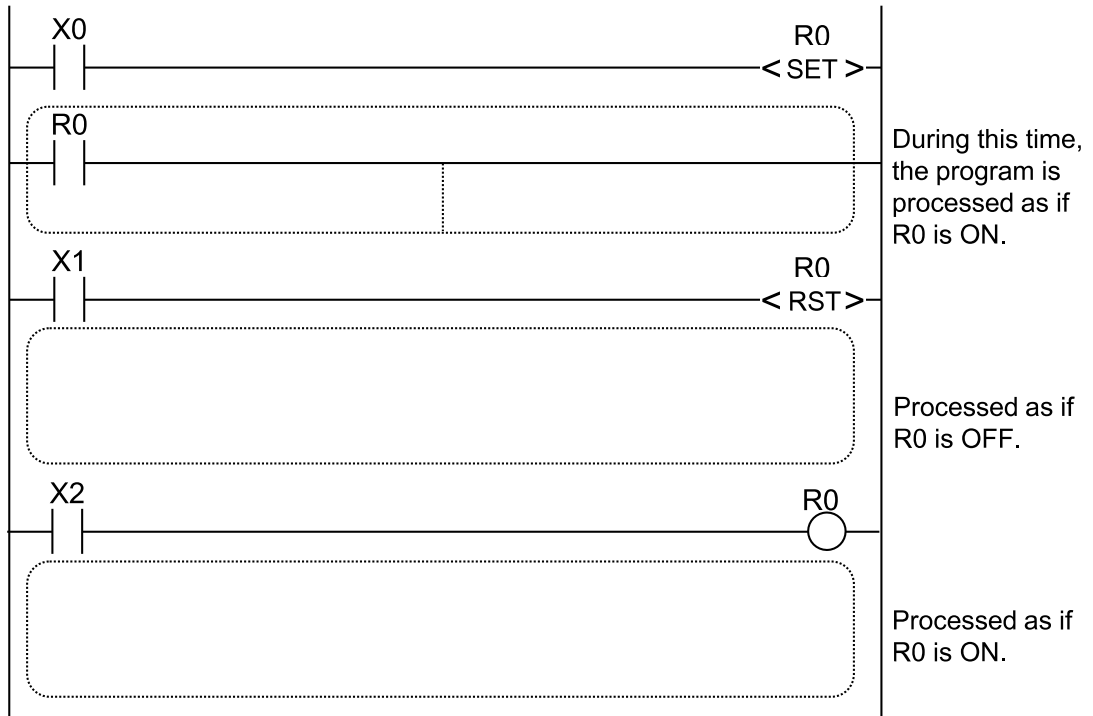

■ Determination of operation result

If the same output is used in duplicate by several instructions such as the OT instruction, KP instruction, SET instruction, RST instruction, or a transfer instruction, the output obtained when I/O refresh is performed is determined by the final operation results.

<Example> Output to the same output relay Y10 by the OT instruction, SET instruction, and RST instruction



When X0 to X2 are all ON, output occurs with Y10 OFF when I/O refresh is performed.

37.3 Rise Detection Method

37.3.1 Rise Detection Instructions

■ Instructions for which rise detection is performed

1. DF (rise differential)
2. CT (counter) count input
3. F118 UDC (up-down counter) count input
4. SR (shift register) shift input
5. F119 LRSR (left and right shift register) shift input
6. NSTP (next step)
7. Differential execution type high-level instruction (instruction specified by P and a number)

■ What is rise detection?

Instructions for which rise detection is performed are only executed in the scan when the execution condition changes from OFF to ON.

1. Normal input detection

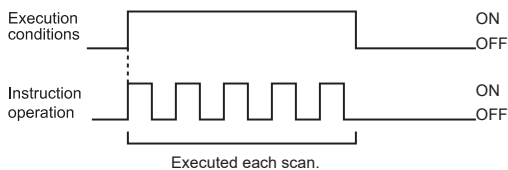

2. Rise detection

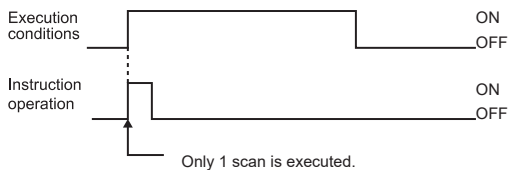

■ Rise detection method

The previous execution condition is compared with the current execution condition, and the instruction is executed only when the previous condition was OFF and the current condition is ON.

The instruction will not be executed otherwise.

■ Precautions for instructions for which rise detection is performed

- When RUN is started, such as when the power is turned on, instructions are not executed because the change of the execution condition from OFF to ON is not detected. See below.
- Be aware that, if used with instructions that change the order of execution, such as the instructions in 1 to 6 below, the operation of instructions may change depending on the input timing.

<Instructions that require caution when using instructions for which rise detection is performed>

1. MC to MCE instructions
2. JP to LBL instructions

37.3 Rise Detection Method

3. LOOP to LBL instructions
4. CNDE instruction
5. Step ladder instructions
6. Subroutine instructions

37.3.2 Operation and Precautions at Run Start Time

■ **Operation of first scan after RUN begins**

- The leading edge detection instruction is not executed when the mode has been switched to the "RUN mode", or when the power supply is booted in the "RUN mode", if the execution condition is already ON.

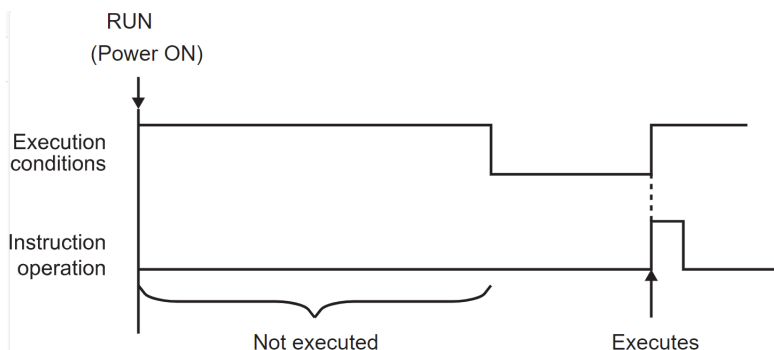

- If you need to execute an instruction when the execution condition is ON prior to switching to "RUN mode", use the special internal relay R9014 in your program as follows. (R9014 is a special internal relay which is OFF during the first scan and turns ON from the second scan onwards.)

Example 1: DF (leading edge differential) instruction

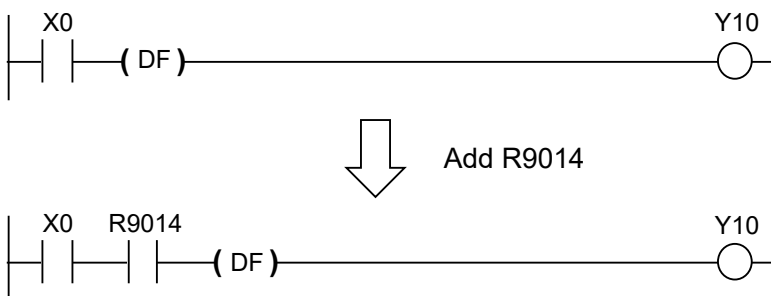

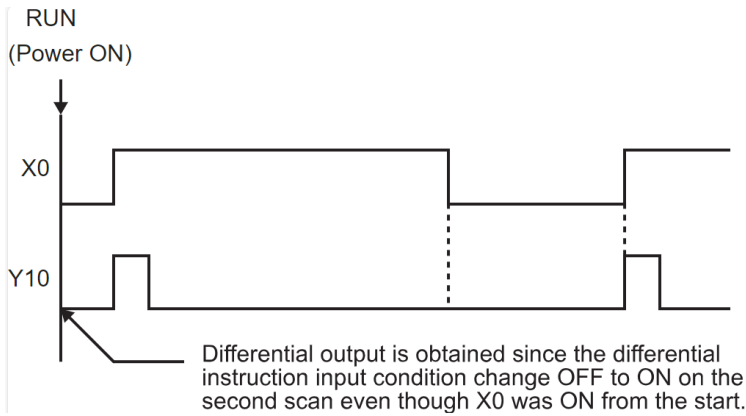

Example 2: CT (counter) instruction

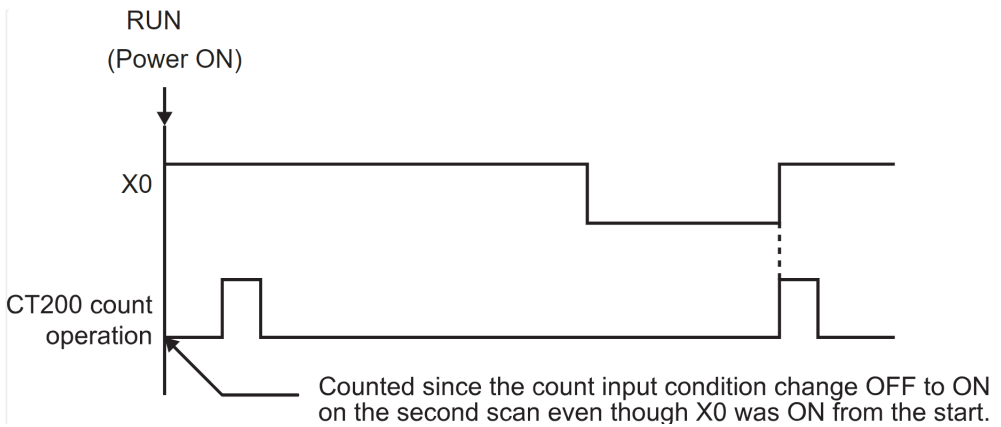
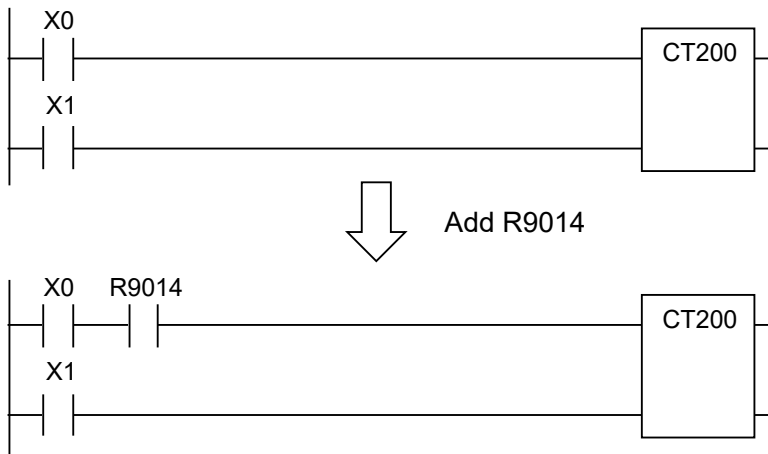

37.3 Rise Detection Method

37.3.3 Precautions When Using Control Instructions

- Instructions that perform rise detection compare the execution condition from the last time that instruction was performed with current execution condition, and are only executed when the condition changes from OFF to ON. They are not executed in any other circumstance.
- When a rise detection instruction is used with an instruction that changes the order in which instructions are executed, such as MC and MCE, or JP and LBL, the operation of the instruction may change as follows depending on input timing.

Example 1: When using the differential instruction DF between MC and MCE

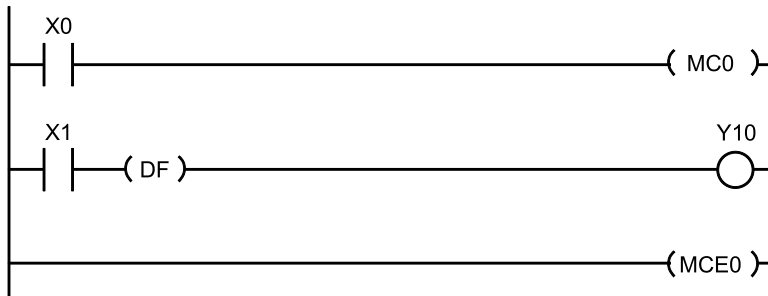

[Timing chart 1]

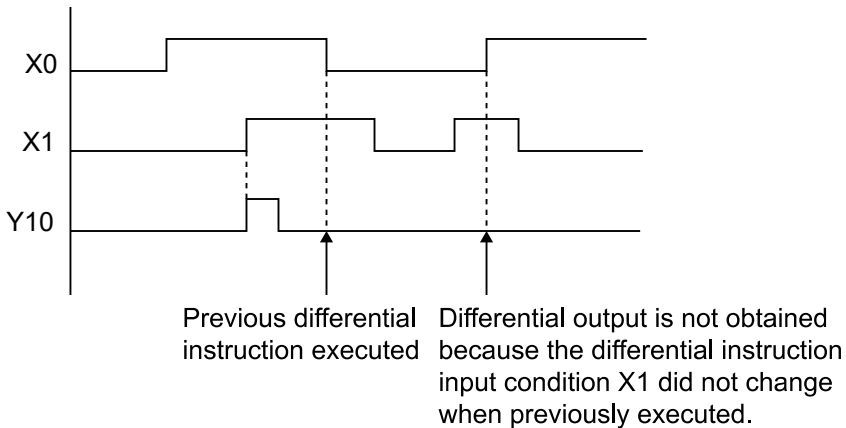

[Timing chart 2]

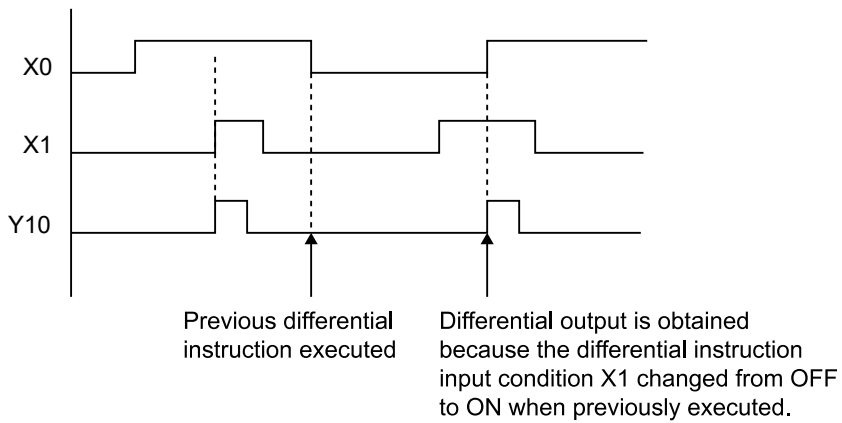

Example 2: When using the counter instruction between JP and LBL

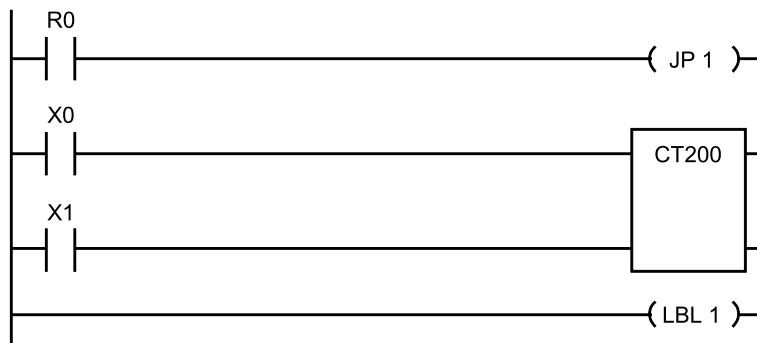

[Timing chart 1]

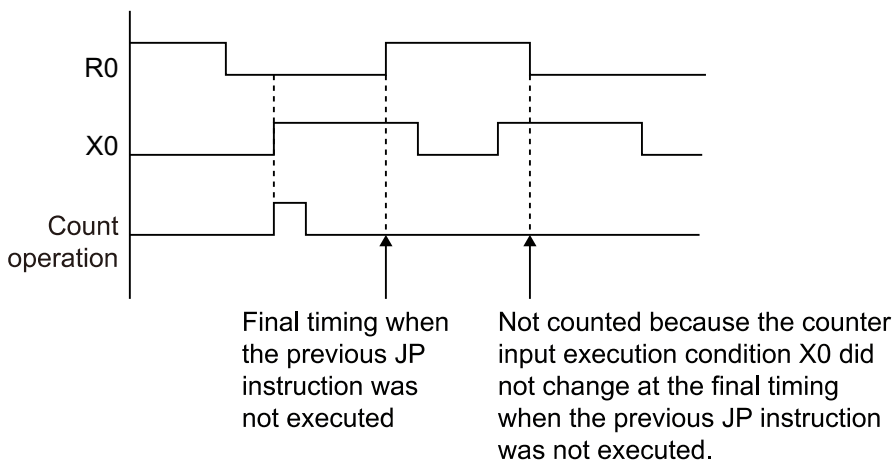

37.3 Rise Detection Method

[Timing chart 2]

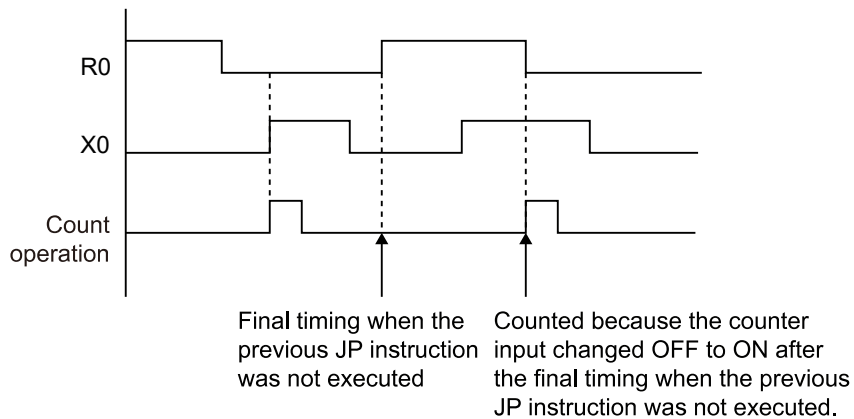

37.4 Operation Errors

37.4.1 What is an operation error?

■ What is an operation error?

- It refers to invalid operation when executing operations using high-level instructions.
- When an operation error occurs, the ERR/ALM LED on the main unit flashes, and the operation error flags (R9007 and R9008) turn ON.
- The operation error code K45 is stored in the special data register DT90000.
- The address where the error was generated is stored in special data registers DT90017 to DT90018.

■ Operation error types

(1)	Address error	If, after using index modification, the memory address (number) specification exceeds the usable area
(2)	BCD error	If an attempt is made to calculate data other than BCD using an instruction that handles BCD data If the data for which BCD conversion is attempted exceeds the convertible range
(3)	Parameter error	If the data specified by an instruction for which specification of control data is required is out of range
(4)	Area exceeded error	If the target of a block instruction exceeds the memory range

37.4.2 Operation Mode when an Operation Error Occurs

Normally, the operation stops when an operation error occurs.

To have the operation continue even if an operation error occurs, change system register No.26 to "Continuation".

Implement this change as follows.

1 2 Procedure

1. Set the control unit to "PROG. mode".
2. Select "System register settings".
3. From the "System register settings" menu, select the "Action on error" screen.
4. Clear the system register No.26 check box and change to "RUN".
5. Press [OK] to write the setting to the PLC.

37.4 Operation Errors

37.4.3 Handling the Occurrence of Operation Errors

■ Procedure

1. Check the location where the error occurred

Refer to the error address stored in DT90017 and DT90018, then check the high-level instruction for that address.

2. Clear the error status

Clear the error by using the programming tool. (If the mode selection switch is set to RUN, the system will enter a RUN state when the error is cleared.)

Execute "Clear error" on the "Status display" menu of the programming tool software.

- The error can also be cleared by turning the power on and off in "PROG. mode". Note, however, that the content of the operation memory other than hold type data will be cleared.
- The error can also be cleared by using the self-diagnostic error set instruction (F148).

37.4.4 Points to Review in Program

Be sure to review your program by following the points below.

1. Check if an extraordinarily large value or negative value is stored in the index registers.

Example: When a data register is modified using an index register

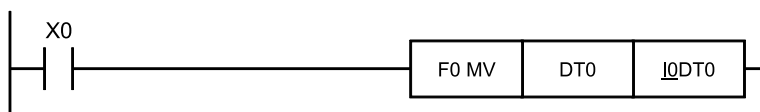

In this case, the index register modifies the address of data register DT0. If the value of I0 is too large, it will exceed the specifiable range of the data register. If the data in I0 is larger than the final address of the data register, an operation error will occur. The same is true when the data in I0 is a negative value.

2. Check if there is any data that cannot be converted by BCD-BIN data conversion.

Example: When BCD-to-BIN conversion is attempted

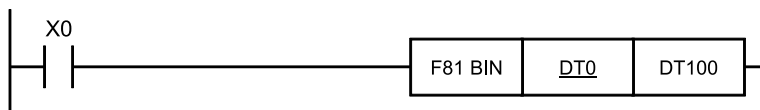

In this case, if DT0 contains a hexadecimal number that includes one of the digits A through F such as "12A4", the data conversion will be impossible and an operation error will result.

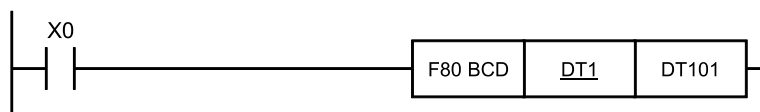
Example: When BIN-to-BCD conversion is attempted

In this case, if DT1 contains a negative value or a value greater than K9999, an operation error will occur.

3. Check if the divisor of a division instruction is "0".

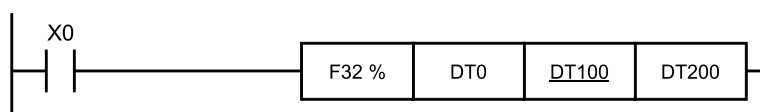
<Example>

In this case, if the content of DT100 is "0", an operation error will occur.

37.5 How to Use the Index Register

37.5 How to Use the Index Register

37.5.1 Index Registers

- Index registers are used for indirect specification of values to numbers and operands in relays and memory areas. (This is called "index modification".)
- The range that can be specified is 14 points, and the numbers that can be specified are I0 to ID.
- Add the index register to the relay, memory area, or constant you want to modify, and then write the modifying value (16-bit data) to the index register.

<Example> Transferring the contents of data register DT100 to the number specified by the contents of an index register

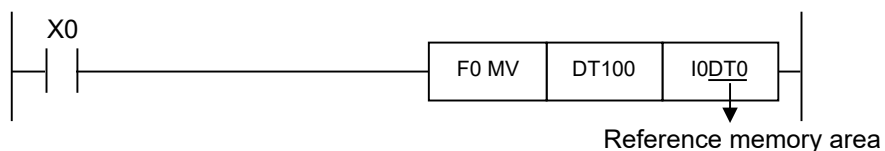

In this example, the number of the destination data register varies depending on the contents of I0 with DT0 acting as a base. For example, when I0 is K10, the destination will be DT10, and when the I0 is K20, the destination will be DT20.

- In this way, index registers allow the specification of multiple memory areas with a single instruction, and thus index registers are very convenient when handling large amounts of data.

37.5.2 Index Modification Applicable Areas

- Index registers can be used to modify other types of memory areas in addition to data register DT.
<Example> I0WX10, I2WY1, I3WR0, IASV0, IBEV2
- Constants can also be modified.
<Example> I0K10, I0H1001
- When a 32-bit constant is modified, the index registers of the specified number and the following number are used in combination to handle the data as 32-bit data. The result of the modification is 32-bit data.

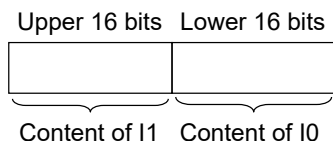

(Note 1) When modifying a 32-bit constant, do not specify the ID. Be aware that a syntax error will not occur even if this is specified.

37.5.3 Example of Using an Index Register

■ When external data is read successively

<Example> Writing the contents of input WX3 sequentially from data register DT0

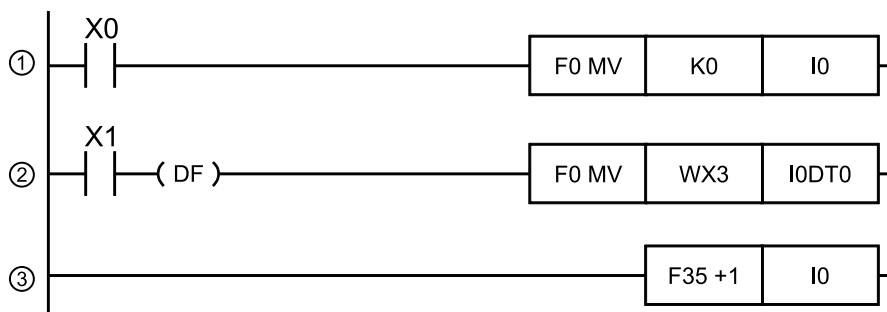

(1)	When X0 is ON, index register I0 is set to 0.		
(2)	When X1 turns ON, the content of input WX3 is transferred to the data register specified by I0DT0.		
(3)	Adds 1 to I0. In this case, the content of I0 changes in sequential order, so the write destination of the data register becomes as shown below.		
	Input of X1	Content of I0	Data writing destination
	1st time	0	DT0
	2nd time	1	DT1
	3rd time	2	DT2

■ Inputting and outputting data according to the number specified by input

<Example 1> Setting a timer with a number specified by a digital switch

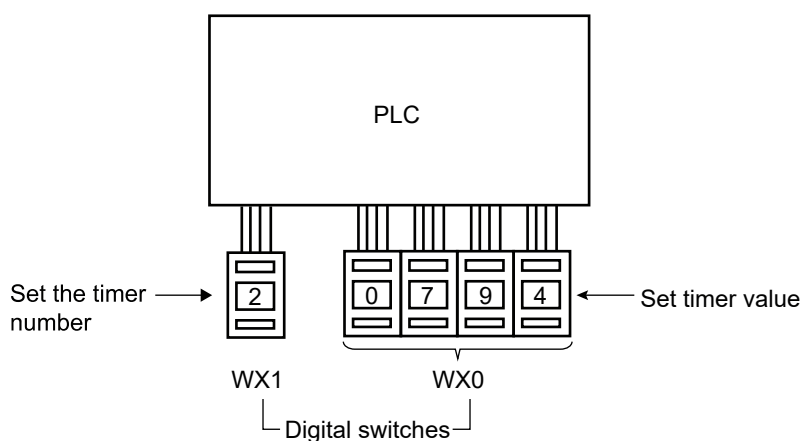

37.5 How to Use the Index Register

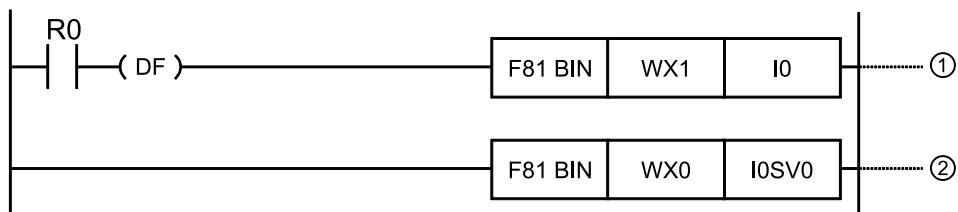

(1)	Timer number data WX1 is converted from BCD data to BIN data, and is set to index register I0.
(2)	Timer setting value data WX0 is converted from BCD data to BIN data, and is stored in the timer setting value area SV specified by the content of I0.

<Example 2> External output of the timer process value with the number specified by the digital switch

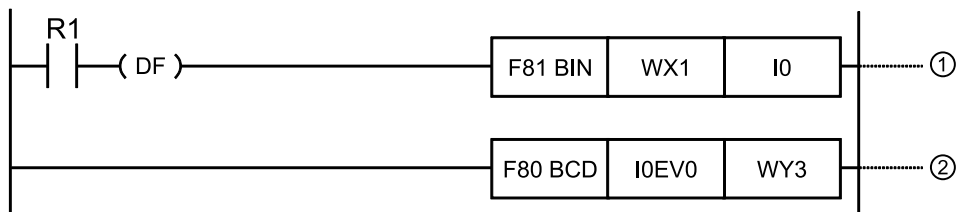
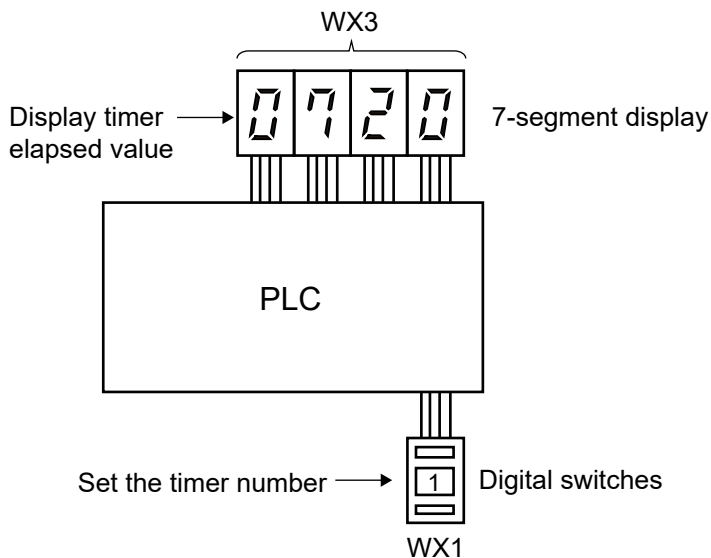

(1)	Timer number data WX1 is converted from BCD data to BIN data, and is set to index register I0.
(2)	The content of timer process value data EV specified by the content of I0 is converted to BCD data, and output to output WY3.

37.6 Handling BCD Data

(1) What is BCD?

BCD or binary coded decimal refers to a decimal number that is divided into single digits and expressed by binary numbers.

<Example> Decimal number expressed in BCD

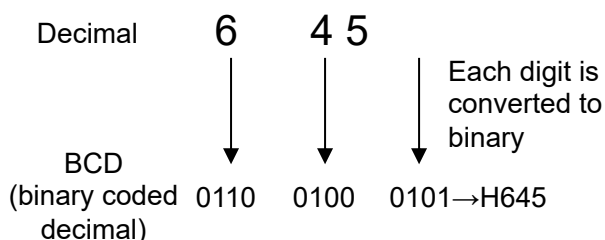

(2) Handling of BCD data in the PLC

- When inputting data from a digital switch to the PLC or outputting data to a 7-segment display (with decoder), the input or output must be BCD data. In this case, use a data conversion instruction as shown in the examples below.
- BCD arithmetic instructions (F40 through F58) also exist that can operate directly on BCD data. However, since operations in the PLC are usually processed in BIN, it is more convenient to use BIN operation instructions (F20 through F38).

■ Inputting from a digital switch

Use the F81 BIN instruction as the BCD to BIN conversion instruction.

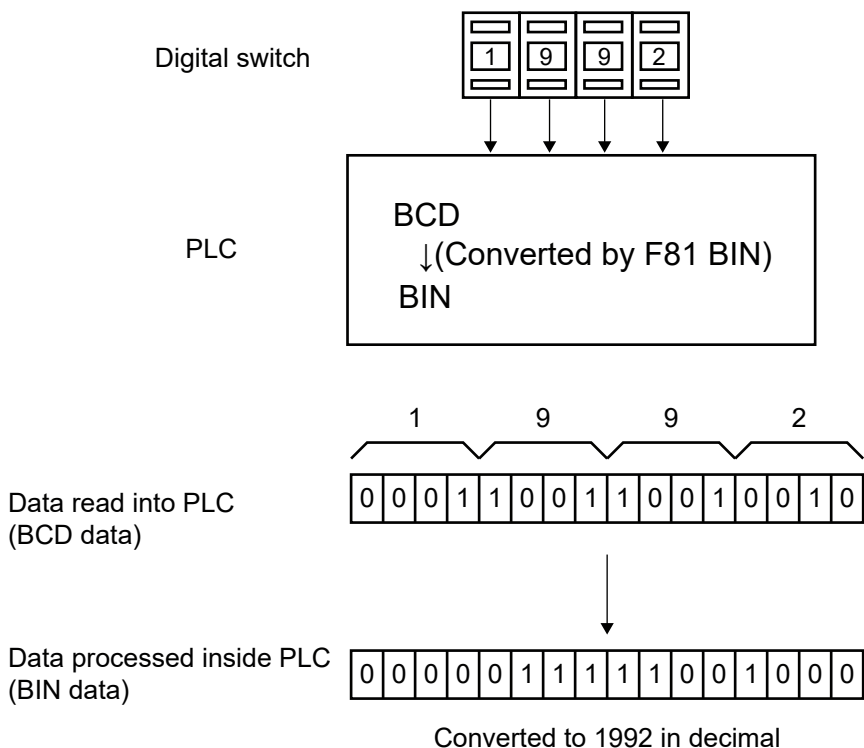

37.6 Handling BCD Data

■ Outputting to a 7-segment display (with decoder)

Use the F80 BCD instruction as the BIN to BCD conversion instruction.

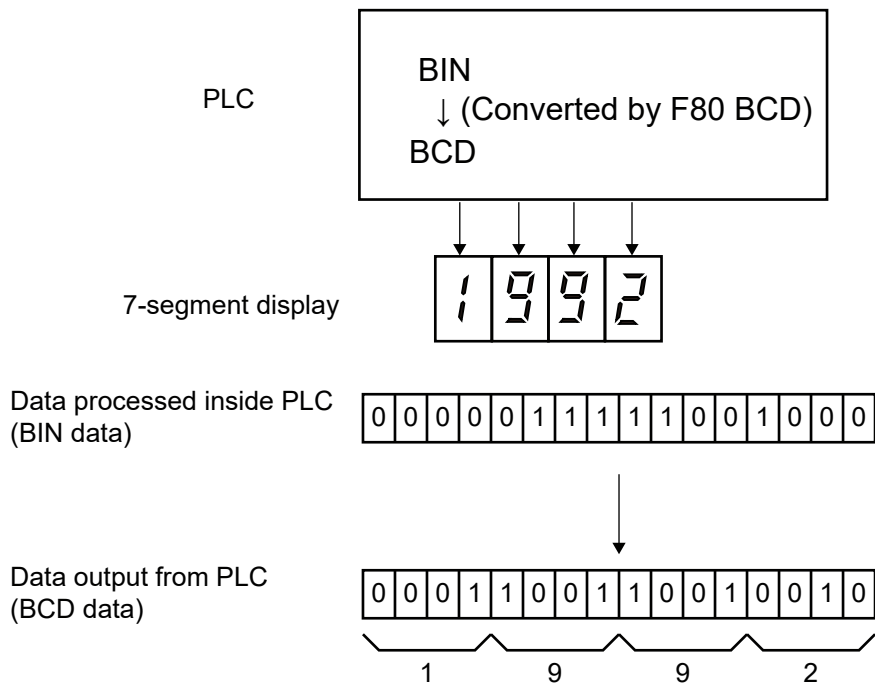

37.7 Precautions for Programming

<Example 1>

Programs that do not execute correctly

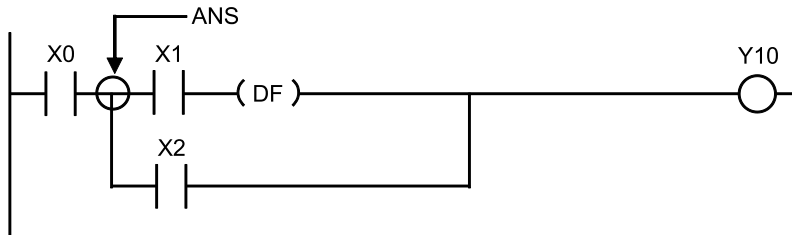

- If X1 turns ON first, Y10 does not turn ON even if X0 is ON.

Rewritten Program

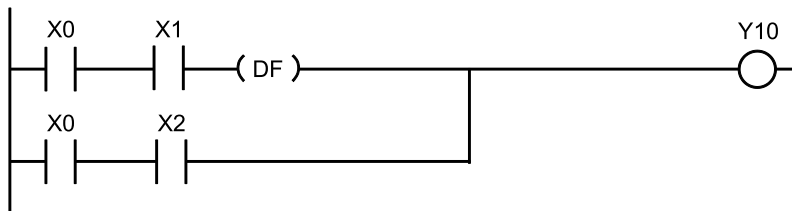

<Example 2>

Programs that do not execute correctly

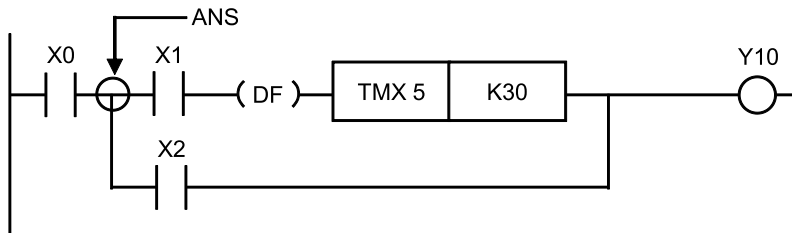

- Regardless of whether X0 is ON or OFF, if X1 is ON, TMX5 becomes active.

Rewritten program

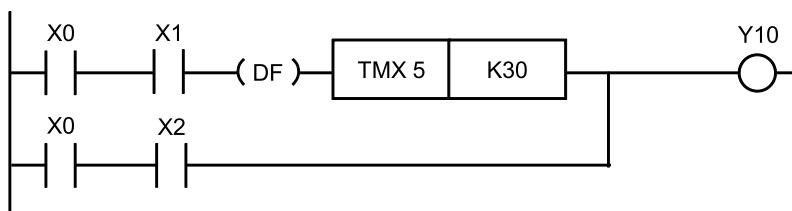

<Example 3>

37.7 Precautions for Programming

Programs that do not execute correctly

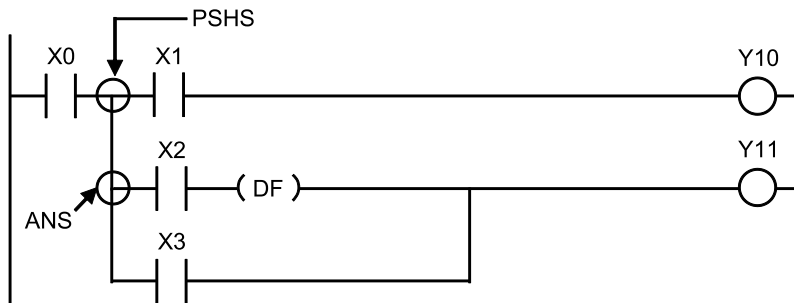

- If X2 is ON first, even if X0 is ON, Y11 does not turn ON.

Rewritten program

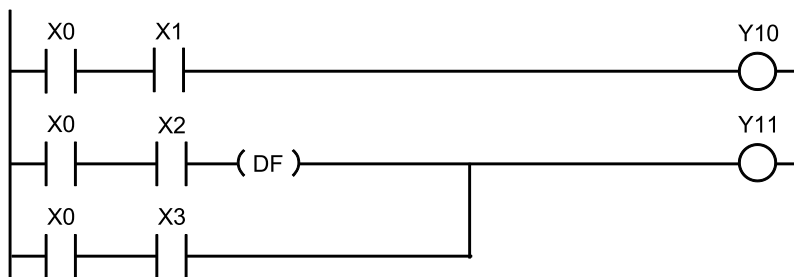

- When a combination of contacts are set as the execution condition of a differential instruction (DF) or timer instruction, do not use an AND stack, push stack, read stack, or pop stack instruction.

37.8 Rewrite Function During RUN

37.8.1 Operation of Rewrite During RUN

■ How Rewrite During RUN Works

A program can be rewritten even during "RUN mode".

When attempting to rewrite a program during RUN, the tool service time is temporarily extended, the program rewritten, and operation is resumed without changing the mode.

For this reason, the scan time of one scan when rewriting during RUN is extended by several ms to several hundred ms.

■ Controller Operation During Rewrite

(1)	External output (Y) is held.
(2)	External input (X) is ignored.
(3)	Timer (T) stops the clock.
(4)	Rise and fall changes in the inputs of the differential instructions (DF), counter instructions (C), and right/left shift registers are ignored.
(5)	Interrupt functions are stopped.
(6)	Internal clock relays (special internal relays) are also stopped.
(7)	Pulse output is stopped for the duration.

■ Setting Values for Timer/Counter Instructions

All set values specified with K constants for timer and counter instructions are preset to the set value SV area with corresponding numbers. (Values in elapsed value area EV do not change.)

■ Operation of the Rewrite During RUN Completion Flag

The rewrite during RUN completion flag (R9034) is a special internal relay that turns ON only for the first scan after rewrite during RUN is complete. It can be used instead of the initial pass relay following a change in a program.

37.8.2 When Rewriting During RUN is not Possible

■ When the timeout message is displayed

Even if the timeout message is displayed, it is likely that the PLC has been rewritten.

The ladder edit remains, so take the system offline, complete the program changes in the tool software, then change to online mode to check.

■ When timeout occurs using the GT series display unit through mode

Use GTWIN to extend the timeout period of the display unit. (The default value is 5 seconds.)

Select "Transfer" from File in the menu bar to open the data transfer screen.

Select "Communication Conditions" from the data transfer screen to open the communication settings screen. The "Timeout" item displays the number of seconds, so change this value. Click the [OK] button to complete the setting change.

37.8 Rewrite Function During RUN

- When Rewriting During RUN is not Possible

- When the result of rewriting is a syntax error, rewriting is not possible.

[Specific example]

When the rewriting would not form a pair of the following instructions

- Step ladder instructions (SSTP/STPE)
- Subroutine instructions (SUB/RET)
- Interrupt instructions (INT/IRET)
- JP/LBL
- LOOP/LBL
- MC/MCE

Rewriting is not possible in the case of other syntax errors.

- Rewriting during RUN is not possible during forced input/output operation.

- Interrupt processing restrictions

Do not perform a rewrite during RUN when using interrupt, high-speed counter, pulse output, or PWM output functions.

Note that when executing a rewrite during RUN, the following operations will occur.

- Interrupt programs will be disabled. Re-enable with an ICTL instruction.

e.g. When using R9034 (Completion flag for rewrite during RUN)

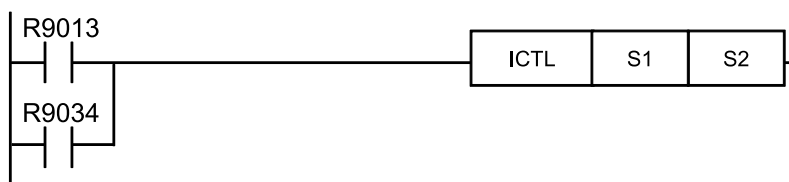

- The high-speed counter will continue counting.

Target value match ON/OFF instructions (F166 HC1S/F167 HC1R) will continue.

Matching interrupt programs will be disabled during execution of the F166 HC1S/F167 HC1R instruction.

- The pulse output and PWM output will be stopped.

Status	Instruction number	Name
Continue	F171 SPDH	Pulse output (with channel specification) (Home return)
Stop	F172 PLSH	Pulse output (with channel specification) (JOG operation)
Stop	F173 PLSH	PWM Output (with channel specification)
Continue	F174 SPOH	Pulse output (with channel specification) (Optional data table control operation)
Continue	F175 SPSH	Pulse output (linear interpolation)
Stop	F380 POSST	Positioning table start instruction
Stop	F381 JOGST	JOG operation start instruction
Stop	F383 MPOST	Positioning table simultaneous start instruction

- Fixed time sampling trace will not be stopped.

37.8.3 Method and Operation of Rewriting during RUN

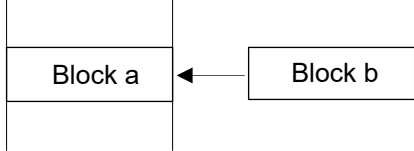
Items		FPWIN GR7 input
Rewrite method		<p>Up to 512 steps. Changes are made in block units. The program is rewritten online, when PB conversion is executed.</p> 
Unique operation of each instruction	OT/KP	If instructions that were written in block a are deleted in block b, the status prior to the rewriting is held.
	TM/CT	<ul style="list-style-type: none"> If instructions that were written in block a are deleted in block b, the status prior to the rewriting is held. The set values specified by K constants in TM/CT instructions are preset to the SVs of all the corresponding numbers in the program. (Elapsed value EV does not change)
	Fun high-level instructions	If instructions that were written in block a are deleted in block b, the status prior to the rewriting is held.
	MC/MCE	Always write MC/MCE instructions as a pair.
	CALL/ SUB/ RET	A subroutine is a program that appears between SUBn and RET instructions. Always write a subroutine to an address that comes after the ED instruction.
	INT/IRET	An interrupt program is a program that appears between INTn and IRET instructions. Always write a subroutine to an address that comes after the ED instruction.
	SSTP/ STPE	Processes that have the same number cannot be defined in duplicate. SSTP instructions cannot be written inside subprograms.
	JP/ LOOP/ LBL	Always write the instruction for setting the number of loops before the LBL-LOOP instructions.

37.9 Processing During Forced Input/Output

■ Processing when forced input/output is initiated during RUN

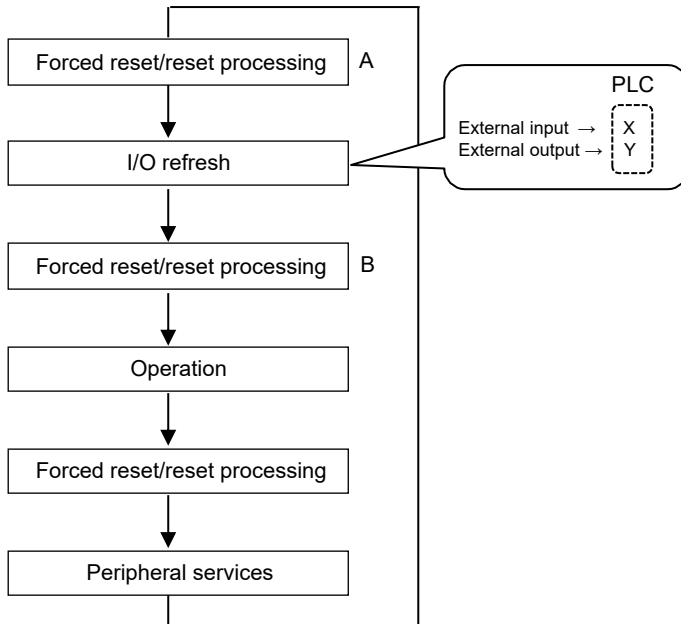

1. Processing of external input (X)

- For a contact for which forced input/output is specified, the forced ON/OFF operation takes precedence regardless of the state of the input from the input device in procedure B in the above flowchart. The input LED will not blink at this time; however, the area of input X in the operation memory will be overwritten.
- For contacts for which forced input/output is not specified, the ON/OFF state is read according to the input state from the input device.

2. Processing of external output (Y)

- For a contact for which forced input/output is specified, the forced ON/OFF operation takes precedence regardless of the operation result in procedure A in the above flowchart. The area of output Y in the operation memory will be forcibly overwritten at this time. External output will occur at the input/output refresh timing in the above figure.
- For contacts for which forced input/output is not specified, the ON/OFF state is determined by the operation result.

3. Processing of timer (T)/counter (C)

- For a contact for which forced input/output is specified, the forced ON/OFF operation takes precedence regardless of the input condition of the timer/counter. The contact of the timer (T)/counter (C) in the operation memory is overwritten at this time. Timing and counting will not be performed during control.
- For contacts for which forced input/output is not specified, the ON/OFF state is determined by the contents of the operation result.

Operation during operation

Forcibly controlled internal relay R and output Y are overwritten according to the operation result.

38 Reference Material

38.1	Operation Memory Area.....	38-3
38.2	List of System Registers	38-5
38.3	List of Special Relays.....	38-13
38.4	List of Special Data Registers.....	38-34
38.5	Allocation of Memory Areas.....	38-54
38.5.1	When Using Pulse Output Table Setting Mode.....	38-54
38.5.2	When Using Pulse Output Function (FPsigma Compatible Instruction Mode).....	38-55
38.5.3	When Using PWM Output Function	38-56
38.5.4	When Using High-speed Counter Function	38-57
38.6	FPsigma Mode.....	38-59
38.6.1	Overview of FPsigma Mode.....	38-59
38.6.2	Converting Projects for FPsigma to Projects for FP0H (FPsigma Mode).....	38-60
38.6.3	Converting Projects for FP0H (FPsigma Mode) to Projects for FP0H (FP0H Mode).....	38-61
38.6.4	Differences in Positioning Instructions with FPsigma.....	38-62
38.7	Positioning Memory	38-68
38.7.1	Configuration of Memory Map.....	38-68
38.7.2	Common area (Memory Area No. 0).....	38-69
38.7.3	Axis Information Area (Memory Area No. 1).....	38-70
38.7.4	Axis Setting Area (Memory Area No. 2).....	38-71
38.7.5	Positioning Table Area (Memory Area No. 3).....	38-73
38.8	Configuration Concerning Open Processing	38-75
38.8.1	IP Address Setting Specification	38-75
38.9	FTP File Transfer Settings	38-77
38.9.1	Basic Setup.....	38-77
38.9.2	Overwrite Method and Rename Method	38-79
38.9.3	FTP File Transfer Settings (Sending Files).....	38-79
38.9.4	FTP File Transfer Settings (Getting Files).....	38-81
38.9.5	FTP File Transfer Settings (Sending Files).....	38-83
38.9.6	FTP File Transfer Settings (Getting Device).....	38-85
38.10	How to Set Logging / Trace Transfer	38-88
38.10.1	Basic Setup.....	38-88
38.10.2	Logging / Trace Transfer Settings.....	38-88
38.11	Communication Commands.....	38-90
38.11.1	List of MEWTOCOL Supported Commands.....	38-90

38 Reference Material

38.11.2 List of MODBUS Supported Commands	38-91
38.11.3 MC Protocol Communication Commands	38-94
38.12 Error code	38-96
38.12.1 List of Syntax Check Errors	38-96
38.12.2 Self-diagnostic Errors.....	38-97
38.12.3 List of MEWTOCOL-COM/DAT Communication Error Codes	38-99
38.12.4 List of MODBUS Communication Error Codes	38-100
38.12.5 List of MC Protocol Communication Error Codes	38-100
38.12.6 List of Ethernet Communication Error Codes	38-101
38.13 BIN/HEX/BCD Code Correspondence Table	38-103
38.14 ASCII Code Table, JIS8 Code Table	38-104

38.1 Operation Memory Area

Item		Specifications	
		Type without Ethernet function	Type with Ethernet function
		C32T/C32P	C32ET/C32EP
Relay	External input (X) ^(Note 1) ^(Note 3)	1760 points (X0 to X109F)	
	External output (Y) ^(Note 1) ^(Note 3)	1760 points (Y0 to Y109F)	
	Internal relay (R) ^(Note 3)	4096 points (R0 to R255F) or 8192 points (R0 to R511F) ^(Note 4)	8192 points (Fixed) (R0 to R511F)
	Timer/Counter (T/C) ^(Note 2)	1024 points (1008 points for Timer: T0 to T1007, 16 points for Counter: C1008 to C1023) Timer: Can be measured up to (in 1 msec / 10 msec / 100 msec / 1 sec unit) x 32767. Counter: Can be measured up to 1 to 32767.	
	Link relay (L)	2048 points (L0 to L127F)	
	Special internal relay (R)	800 points (R9000 to R951F)	
Memory area	External input (WX) ^(Note 1)	110 words (WX0 to WX109)	
	External output (WY) ^(Note 1)	110 words (WY0 to WY109)	
	Internal relay (WR)	256 words (WR0 to WR255) or 512 words (WR0 to WR511) ^(Note 3)	512 words (WR0 to WR511)
	Link relay (WL)	128 words (WL0 to WL127)	
	Data register (DT) ^(Note 5)	32765 words (DT0 to DT32764) 65533 words (DT0 to DT65532)	12285 words (DT0 to DT12284) 24573 words (DT0 to DT24572) 32765 words (DT0 to DT32764) 65533 words (DT0 to DT65532)
	Special data register (DT) ^(Note 3)	1000 words (DT90000 to DT90999)	
	Link data register (LD)	256 words (LD0 to LD255)	
	Timer/Counter set value area	1024 words (SV0 to SV1023)	
	Timer/counter elapsed value area (EV)	1024 words (EV0 to EV1023)	
	Index register (I)	14 words (I0 to ID)	

(Note 1) The number of points actually available for use is determined by the hardware configuration.

(Note 2) The points of the timer/counter can be set by the system register no. 5. The numbers in the above table are the case of the default settings. Also, the number of points can be increased by using the auxiliary timer (F137).

(Note 3) Compatible specifications with FPsigma is available.

(Note 4) "0:4096 points or 1:8192 points" can be selected by the setting of the system register no. 1 (internal relay capacity).

(Note 5) The capacity of data registers (DT) <Table below> can be selected by the setting of the system register no. 0 (program capacity).

For the FPsigma mode, only the program capacity of 24 or 32 can be selected regardless of models.

38.1 Operation Memory Area

Type	System register no. 0 Program capacity	Data register capacity
C32T/C32P	24	65533 words
	32	32765 words
C32ET/C32EP	24	65533 words
	32	32765 words
	40	24573 words
	64	12285 words

38.2 List of System Registers

■ Memory allocation

No.	Name	Default	Setting range and description
0	Sequence program area size ^(Note 1) ^(Note 2)	32	[FP0H mode] C32: 24K, 32K words C32E: 24K, 32K, 40K, 64K words [FPsigma mode] 24K, 32K words
1	Internal relay area size ^(Note 1)	8192	C32: 4096, 8192 C32E: 8192 (Fixed)

(Note 1) The system register no. 0 (Sequence program area size) and no. 1 (Internal relay area size) can be set only in off-line editing. To make the setting effective, you need to download it to the control unit.

(Note 2) System register no.0: if you change the sequence program area capacity, the capacity of the data register DT will be changed.

For the FPsigma mode, only 24K or 32K words can be selected.

■ Hold / Non-hold 1

No.	Name	Default	Setting range and description
5	Counter starting address	1008	0 to 1024
6	Hold type area starting address for timer/counter	1008	0 to 1024
7	Starting word No. of internal relay hold area ^(Note 1)	[FP0H mode]	
		248	0 to 256
		504	0 to 512
		[FPsigma mode]	
		248 (Fixed)	0 to 256, 0 to 512
8	Hold type area starting address for data registers ^(Note 2)	[FP0H mode] C32:	
		32450	0 to 32765
		65218	0 to 65533
		[FP0H mode] C32E:	
		11970	0 to 12285
		24258	0 to 24573
		32450	0 to 32765
65218	0 to 65533		
		[FPsigma mode]	
		32710 (Fixed)	0 to 32765 0 to 65533
14	Holding the step ladder	Non-hold	Hold/Non-hold
4	Leading edge detection of the differential instruction during MC holds the previous value	Hold	Hold/Non-hold

38.2 List of System Registers

(Note 1) The default and setting range of System register No. 7 differ depending on the value of System register No.1.

System register No.1	System register No.7		
	Default		Setting range
	FP0H mode	FPsigma mode	
4096 points	248	248 (Fixed)	0 to 256
8192 points	504		0 to 512

(Note 2) The default and setting range of System register No. 8 differ depending on the value of System register No.0.

System register No.0		System register No.8		
		Default		Setting range
		FP0H mode	FPsigma mode	
24Kstep		65218	32710 (Fixed)	0 to 65533
32Kstep		32450		0 to 32765
40Kstep	C32ET only	24258	No setting	0 to 24573
64Kstep		11970		0 to 12285

■ Hold / Non-hold 2

No.	Name	Default	Setting range and description
10	Hold type area starting word address setting for link relays for PLC link W0-0	64	0 to 64
11	Hold type area starting word address setting for link relays for PLC link W0-1	128	64 to 128
12	Hold type area starting word address setting for link data registers for PLC link W0-0	128	0 to 128
13	Hold type area starting word address setting for link data registers for PLC link W0-1	256	128 to 256

■ Action on Error

No.	Name	Default	Setting range and description
20	Disable settings for duplicated output	Disable	Disable/Enable
23	Stop operation when an I/O verification error occurs	Stop	Stop/Run
24	Stop operation when configuration data error/initialization request error occurs (C32ET/C32EP only)	Stop	Stop/Run
25	Stop operation when positioning operation error occurs	Run	Stop/Run

No.	Name	Default	Setting range and description
26	Stop operation when calculating error occurs	Stop	Stop/Run
27	Stop operation when network error occurs (C32ET/C32EP only)	Stop	Stop/Run
4	Alarm the battery abnormality	No	No: The self-diagnostic error is not notified in case of battery error, and the "ERR/ALM" LED does not flash. Yes: The self-diagnostic error is notified in case of battery error, and the "ERR/ALM" LED flashes.

■ Time setting

No.	Name	Default	Setting range and description
31	Waiting time for managing multiple frame	6500 ms	10 to 81900 ms (In 2.5 ms unit)
32	SEND / RECV / RMRD / RMWT instruction waiting time	10000 ms	10 to 81900 ms (In 2.5 ms unit)
34	Constant scan time	Normal scan	0: Normal scan (in 0.5 ms unit) 0 to 600 ms: Scan at a specified time interval
37	Task time priority setting (Note 1)	Standard	Normal/Operation

(Note 1) It is available only in RUN mode. The setting is always "Normal" in PROG. mode.

By selecting "Operation", the time taken for the communication processing is reduced for one port per scan. The operation processing takes priority.

■ PLC link W0-0 setting

No.	Name	Default	Setting range and description
40	Size of link relays	0	0 to 64 words
41	Size of link data registers	0	0 to 128 words
42	Send area starting word address of link relay	0	0 to 63
43	Size of link relays used for send area	0	0 to 64 words
44	Send area starting address of link data register	0	0 to 127
45	Size of link data registers used for send area	0	0 to 127 words
46	PLC link switch flag	Normal	Normal/Reverse
47	MEWNET-W0 PLC link max. station no.	16	1 to 16
48	PLC link baud rate (Note 1)	115200bps	115200 bps/230400 bps

(Note 1) The system register no. 48 (PLC link baud rate) is set in the same dialog box for the COM0 port, COM1 port and COM2 port settings.

38.2 List of System Registers

■ PLC link W0-1 setting

No.	Name	Default	Setting range and description
50	Size of link relays	0	0 to 64 words
51	Size of link data registers	0	0 to 128 words
52	Send area starting word address of link relay	64	64 to 127
53	Size of link relays used for send area	0	0 to 64 words
54	Send area starting address of link data register	128	128 to 255
55	Size of link data registers used for send area	0	0 to 127 words
57	MEWNET-W0 PLC link max. station no.	16	1 to 16

■ Controller input settings (HSC/PLS)

No.	Name	Default	Setting range and description
400	HSC operation mode settings (X0 to X2)	CH0: Not Set X0 as High Speed Counter	Not Set X0 as High Speed Counter 2 phase input (X0, X1) 2 phase input (X0, X1) Reset input (X2) Addition input (X0) Addition input (X0) Reset input (X2) Subtraction input (X0) Subtraction input (X0) Reset input (X2) One input (X0, X1) One input (X0, X1) Reset input (X2) Direction distinction (X0, X1) Direction distinction (X0, X1) Reset input (X2) J-point positioning start input of pulse output CH0 (X0)
		CH1: Not Set X1 as High Speed Counter	Not Set X1 as High Speed Counter Addition input (X1) Addition input (X1) Reset input (X2) Subtraction input (X1) Subtraction input (X1) Reset input (X2) J-point positioning start input of pulse output CH1 (X1)
401	HSC operation mode settings (X3 to X5)	CH2: Not Set X3 as High Speed Counter	Not Set X3 as High Speed Counter 2 phase input (X3, X4) 2 phase input (X3, X4) Reset input (X5) Addition input (X3) Addition input (X3) Reset input (X5) Subtraction input (X3) Subtraction input (X3) Reset input (X5) One input (X3, X4) One input (X3, X4) Reset input (X5) Direction distinction (X3, X4)

No.	Name	Default	Setting range and description
			Direction distinction (X3, X4) Reset input (X5) J-point positioning start input of pulse output CH2 (X3)
		CH3: Not Set X4 as High Speed Counter	Not Set X4 as High Speed Counter Addition input (X4) Addition input (X4) Reset input (X5) Subtraction input (X4) Subtraction input (X4) Reset input (X5) J-point positioning start input of pulse output CH3 (X4)

(Note 1) "J-point positioning start input" for each channel can be selected only when "Table setting mode" is set in the system register no. 407.

■ Controller output settings (PLS/PWM) for FP0H mode

No.	Name	Default	Setting range and description
407	Positioning control mode setting	Table setting mode	Table setting mode, FPsigma compatible instruction mode
402 (Note 1) (Note 2)	Pulse/PWM output setting (Y0 to YC) When selecting "Table setting mode" in no. 407	CH0:	Normal output (Y0, Y1) WM output (Y0), Normal output (Y1) Pulse output [Table operation] (Y0, Y1)
		CH1:	Normal output (Y3, Y4) Pulse output (Y3, Y4) Pulse output [Table operation] (Y3, Y4)
		CH2:	Normal output (Y8, Y9) Pulse output (Y8, Y9) Pulse output [Table operation] (Y8, Y9)
		CH3:	Normal output (YB, YC) Pulse output (YB, YC) Pulse output [Table operation] (YB, YC)
	Pulse/PWM output setting (Y0 to YC) When selecting "FPsigma compatible instruction mode" in no. 407	CH0:	Normal output (Y0, Y1) Pulse output (Y0, Y1) Pulse output (Y0), Normal output (Y1)
		CH1:	Normal output (Y3, Y4) Pulse output (Y3, Y4) Pulse output (Y3), Normal output (Y4)
		CH2:	Normal output (Y8, Y9) Pulse output (Y8, Y9) Pulse output (Y8), Normal output (Y9)
		CH3:	Normal output (YB, YC) Pulse output (YB, YC) Pulse output (YB), Normal output (YC)

38.2 List of System Registers

■ Controller output settings (PLS/PWM) for FPsigma mode

No.	Name	Default	Setting range and description
407 (Note 1)	Positioning control mode setting	FPsigma compatible instruction mode	FPsigma compatible instruction mode (Fixed)
402	Pulse/PWM output settings (Y0 to YC) (Note 2)	-	Not selectable

(Note 1) If the no. 407 (Positioning control start setting) is changed, the selection of the no. 402 (Pulse/PWM output setting) will be switched.

(Note 2) For using the pulse output [Table setting mode] function, pulse output function and PWM output function, the controller output setting must be set. The output specified for the pulse output and PWM output cannot be used as normal output.

■ Interrupt / pulse catch settings

No.	Name	Default	Setting range and description																
403 (Note 1)	Pulse catch input setting	Not set	<table border="1" style="margin-left: 20px;"> <tr> <td>X0</td><td>X1</td><td>X2</td><td>X3</td><td>X4</td><td>X5</td><td>X6</td><td>X7</td> </tr> <tr> <td><input type="checkbox"/></td><td><input type="checkbox"/></td><td><input type="checkbox"/></td><td><input type="checkbox"/></td><td><input type="checkbox"/></td><td><input type="checkbox"/></td><td><input type="checkbox"/></td><td><input type="checkbox"/></td> </tr> </table> Controller input The pressed contact is set as pulse catch input.	X0	X1	X2	X3	X4	X5	X6	X7	<input type="checkbox"/>	<input type="checkbox"/>	<input type="checkbox"/>	<input type="checkbox"/>	<input type="checkbox"/>	<input type="checkbox"/>	<input type="checkbox"/>	<input type="checkbox"/>
X0	X1	X2	X3	X4	X5	X6	X7												
<input type="checkbox"/>	<input type="checkbox"/>	<input type="checkbox"/>	<input type="checkbox"/>	<input type="checkbox"/>	<input type="checkbox"/>	<input type="checkbox"/>	<input type="checkbox"/>												
404 (Note 1)	Interrupt input settings	Not set	<table border="1" style="margin-left: 20px;"> <tr> <td>X0</td><td>X1</td><td>X2</td><td>X3</td><td>X4</td><td>X5</td><td>X6</td><td>X7</td> </tr> <tr> <td><input type="checkbox"/></td><td><input type="checkbox"/></td><td><input type="checkbox"/></td><td><input type="checkbox"/></td><td><input type="checkbox"/></td><td><input type="checkbox"/></td><td><input type="checkbox"/></td><td><input type="checkbox"/></td> </tr> </table> Controller input The pressed contact is set as interrupt input.	X0	X1	X2	X3	X4	X5	X6	X7	<input type="checkbox"/>	<input type="checkbox"/>	<input type="checkbox"/>	<input type="checkbox"/>	<input type="checkbox"/>	<input type="checkbox"/>	<input type="checkbox"/>	<input type="checkbox"/>
X0	X1	X2	X3	X4	X5	X6	X7												
<input type="checkbox"/>	<input type="checkbox"/>	<input type="checkbox"/>	<input type="checkbox"/>	<input type="checkbox"/>	<input type="checkbox"/>	<input type="checkbox"/>	<input type="checkbox"/>												

(Note 1) If the same input is set to the high-speed counter, pulse catch, and interrupt input, the priority order is as follows; 1. High-speed counter, 2. Pulse catch, 3. Interrupt input.

■ Interrupt edge setting

No.	Name	Default	Setting range and description																																
405 (Note 1)	Effective interrupt edge setting for controller input	Leading edge	<table border="1" style="margin-left: 20px;"> <tr> <td>X0</td><td>X1</td><td>X2</td><td>X3</td><td>X4</td><td>X5</td><td>X6</td><td>X7</td> </tr> <tr> <td><input type="checkbox"/></td><td><input type="checkbox"/></td><td><input type="checkbox"/></td><td><input type="checkbox"/></td><td><input type="checkbox"/></td><td><input type="checkbox"/></td><td><input type="checkbox"/></td><td><input type="checkbox"/></td> </tr> </table> Leading edge <table border="1" style="margin-left: 20px;"> <tr> <td>X0</td><td>X1</td><td>X2</td><td>X3</td><td>X4</td><td>X5</td><td>X6</td><td>X7</td> </tr> <tr> <td><input type="checkbox"/></td><td><input type="checkbox"/></td><td><input type="checkbox"/></td><td><input type="checkbox"/></td><td><input type="checkbox"/></td><td><input type="checkbox"/></td><td><input type="checkbox"/></td><td><input type="checkbox"/></td> </tr> </table> Trailing edge The pressed contacts are set as leading and trailing edges.	X0	X1	X2	X3	X4	X5	X6	X7	<input type="checkbox"/>	<input type="checkbox"/>	<input type="checkbox"/>	<input type="checkbox"/>	<input type="checkbox"/>	<input type="checkbox"/>	<input type="checkbox"/>	<input type="checkbox"/>	X0	X1	X2	X3	X4	X5	X6	X7	<input type="checkbox"/>	<input type="checkbox"/>	<input type="checkbox"/>	<input type="checkbox"/>	<input type="checkbox"/>	<input type="checkbox"/>	<input type="checkbox"/>	<input type="checkbox"/>
X0	X1	X2	X3	X4	X5	X6	X7																												
<input type="checkbox"/>	<input type="checkbox"/>	<input type="checkbox"/>	<input type="checkbox"/>	<input type="checkbox"/>	<input type="checkbox"/>	<input type="checkbox"/>	<input type="checkbox"/>																												
X0	X1	X2	X3	X4	X5	X6	X7																												
<input type="checkbox"/>	<input type="checkbox"/>	<input type="checkbox"/>	<input type="checkbox"/>	<input type="checkbox"/>	<input type="checkbox"/>	<input type="checkbox"/>	<input type="checkbox"/>																												

(Note 1) If the same input is set to the high-speed counter, pulse catch, and interrupt input, the priority order is as follows; 1. High-speed counter, 2. Pulse catch, 3. Interrupt input.

■ Time constant setting of controller input 1 / 2

No.	Name	Default	Setting range and description
430	Input X0 to X3	[FP0H mode]	None / 0.1 ms / 0.2 ms / 0.5 ms / 1 ms / 2 ms / 4 ms / 8 ms / 16 ms / 32 ms / 64 ms / 128 ms / 256 ms
431	Input X4 to X7	1 ms	
432	Input X8 to XB	[FPsigma mode]	
433	Input XC to XF	None	
438	Update inputs status when the power is turned on (Note 1)	After a time constant	After a time constant Immediately

(Note 1) Available on FP0H Ver.1.9 or later

■ COM0 / COM1 / COM2 port setting

No.	Name	Default	Setting range and description
410 411	Unit No.	1	1 to 99
412	Communication Mode	Computer Link	Computer Link General-purpose communication PLC Link MODBUS RTU
	Modem connection	Not execute	Execute/Not execute
413 414	Communication format	Data length: 8 bits Parity check: Odd Stop bit: 1	Character bit: 7 bits/8 bits Parity: None/Odd/Even Stop bit: 1/2 Terminator selection: Code/Time Terminator: CR/CR+LF/None/ETX Header: STX Not Exist./STX exists
415	Baud rate ^{(Note 2)(Note 3)(Note 4)}	9600 bps	2400 bps, 4800 bps, 9600 bps, 19200 bps, 38400 bps, 57600 bps, 115200 bps, 230400 bps
416	(COM1) Starting address for data received of serial data communication mode	0	0 to 65532 ^(Note 1)
417	(COM1) Buffer capacity setting for data received of serial data communication mode	2048	0 to 2048
418	(COM2) Starting address for data received of serial data communication mode	2048	0 to 65532 ^(Note 1)
419	(COM2) Buffer capacity setting for data received of serial data communication mode	2048	0 to 2048
420	(COM0) Starting address for data received of serial data communication mode	4096	0 to 65532 ^(Note 1)
421	(COM0) Buffer capacity setting for data received of serial data communication mode	2048	0 to 2048
424	(COM0) Terminator judgement time (x 0.01 ms)	0	0 or 1 to 10000 (0.01 ms to 100 ms) When terminator judgement time is 0, transmission time is that for approx. 4 bytes.
425	(COM1) Terminator judgement time (x 0.01 ms)	0	

38.2 List of System Registers

No.	Name	Default	Setting range and description
426	(COM2) Terminator judgement time (x 0.01 ms)	0	

(Note 1) The range of the system register no. 416/418/420 varies according to the value of the system register no. 0.

System registerNo.0 Sequence program area size	System register no. 416/418/420/422 Receive buffer starting address in general-purpose communication
24Kstep	0 to 65532
32Kstep	0 to 32764
40Kstep	0 to 24572
64Kstep	0 to 12284

(Note 2) System register no. 415 cannot be used to set the baud rate to 1200 bps. To set the baud rate to 1200 bps, use the SYS1 instruction.

(Note 3) If the baud rate is changed as below, communications passing through all COM ports will be reset.
Baud rates of all COM ports: 4800 bps or higher ↔ Baud rates of any COM ports: 2400 bps or lower

(Note 4) If the baud rate of any of the COM ports is 2400 bps or lower, F-ROM access will slow down.
Example) F12(ICRD) instruction, P13(ICWT) instruction, etc.

■ SD card setting (Type with Ethernet function)

No.	Name	Default	Setting range and description
440	SD card cover open/close detection	Detect	Detect/Not detect Detect: When the cover of the control unit is open, accessing the SD memory card is not allowed. Or the access is stopped. Not detect: Even when the cover of the control unit is open, accessing the SD memory card is allowed. However, if an SD memory card is removed/ inserted during the SD memory card access, the SD memory card or data may be damaged.
441	Allowed time of SD card task operation	10 ms	0.5 to 100 ms (In 0.5 ms unit)

■ Compatible mode

No.	Name	Default	Setting range and description
3	Compatible mode setting ^(Note 1)	FP0H mode (Note 2)	FP0H mode FPsigma mode

(Note 1) System register no.3 (compatibility mode settings) can be set only in off-line editing. To make the setting effective, you need to download it to the control unit.

(Note 2) If the PLC has been changed from FPsigma to another model, FPsigma mode is used by default.

38.3 List of Special Relays

WR900 (Specified in word unit)

Relay no.	Name	Description
R9000	Self-diagnostic error flag	Turns on when a self-diagnostic error occurs. - The self-diagnostic result is stored in DT90000.
R9001	Reserved for system	-
R9002	I/O unit error flag	Turns on when the I/O unit of FP0H/FPsigma Expansion Unit (left expansion) runs away. - The self-diagnostic error "E40: I/O error" occurs, and the corresponding bit turns on in DT90002.
R9003	Intelligent unit error flag	Turns on when the intelligent unit of FP0H/FPsigma Expansion Unit (left expansion) runs away. - The self-diagnostic error "E41: Special unit runaway" occurs, and the corresponding bit turns on in DT90006.
R9004	I/O verification error flag	Turns on when an I/O verification error is detected.
R9005	Backup battery error flag (current type)	Turns on when a battery error occurs. Even if you choose not to notify battery error in the system register, this is also ON when the battery runs out.
R9006	Backup battery error flag (hold)	Turns on when a battery error occurs. Even if you choose not to notify battery error in the system register, this is also ON when the battery runs out. Once a battery error has been detected, this is held even after recovery has been made. - It goes off if the power supply is turned off.
R9007	Operation error flag (hold) (ER flag)	Turns on when an operation error occurs after the unit has started operating, and remains on while the unit operation continues. - The address where the error occurred is stored in DT90017. (It indicates the first operation error that has occurred.)
R9008	Operation error flag (latest) (ER flag)	Turns on every time an operation error occurs. - The address where the operation error occurred is stored in DT90018. Every time a new error occurs, the data will be updated.
R9009	Carry flag (CY flag)	This flag is set when the operation result overflow or under flow occurs, or when performing a shift system instruction.
R900A	> flag	Executes a comparison instruction, and turns on if the result is larger.
R900B	= flag	Executes a comparison instruction, and turns on if the result is equal. Executes an operation instruction, and turns on if the operation result is '0'.
R900C	< flag	Executes a comparison instruction, and turns on if the result is smaller.
R900D	Auxiliary timer contact	Executes the auxiliary timer instruction (F137/F138), and turns on after the lapsed of a set time. Turns off when the execution condition turns to off.
R900E (R9130)	COM0 port communication error	Turns on if a communication error is detected when using the COM0 port.

38.3 List of Special Relays

Relay no.	Name	Description
R900F	Constant scan error flag	Turns on if the scan time exceeds the set time (system register no. 34) when performing the constant scan. It also turns on when 0 is set in the system register no. 34.

(Note 1) The same function is allocated to the special internal relay in parentheses.

WR901 (Specified in word unit)

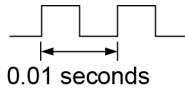
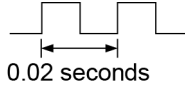
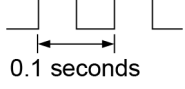
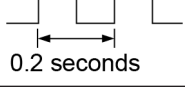
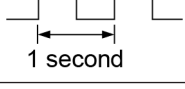
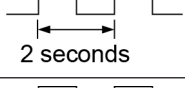
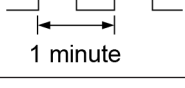
Relay no.	Name	Description
R9010	Always ON relay	Always on.
R9011	Always OFF relay	Always off.
R9012	Scan pulse relay	Turns on and off alternately at each scan.
R9013	Initial pulse relay (ON)	Turns on for only the first scan after operation (RUN) has been started, and turns off for the second and subsequent scans.
R9014	Initial pulse relay (OFF)	Turns off for only the first scan after operation (RUN) has been started, and turns on for the second and subsequent scans.
R9015	Step ladder Initial pulse relay (ON)	Turns on in the first scan only, following startup of any single process, during stepladder control.
R9016 to R9017	Reserved for system	-
R9018	0.01-sec clock pulse relay	Clock pulse with a 0.01-second cycle. 
R9019	0.02-sec clock pulse relay	Clock pulse with a 0.02-second cycle. 
R901A	0.1-sec clock pulse relay	Clock pulse with a 0.1-second cycle. 
R901B	0.2-sec clock pulse relay	Clock pulse with a 0.2-second cycle. 
R901C	1-sec clock pulse relay	Clock pulse with a 1-second cycle. 
R901D	2-sec clock pulse relay	Clock pulse with a 2-second cycle. 
R901E	1-min clock pulse relay	Clock pulse with a 1-minute cycle. 
R901F	Reserved for system	-

WR902 (Specified in word unit)

Relay no.	Name	Description
R9020	RUN mode flag	Turns off while the mode selector is set to PROG. Turns on while the mode selector is set to RUN.
R9021 to R9025	Reserved for system	-
R9026	Message flag	Turns on when the message display instruction (F149) is executed.
R9027 to R9028	Reserved for system	-
R9029	Force flag	Turns on during forced on/off operation for input/output relays or timer/counter contacts.
R902A	Interrupt enable flag	Turns on while the external interrupt trigger is enabled.
R902B	Reserved for system	-
R902C	Sample point flag	Sampling by instruction = 0 Sampling at constant time intervals = 1
R902D	Sampling trace end flag	When the sampling operation stops = 1 When the sampling operation starts = 0
R902E	Sampling stop trigger flag	When the sampling stop trigger occurs = 1 When the sampling stop trigger stops = 0
R902F	Sampling enable flag	When sampling starts = 0 When sampling stops = 1

WR903 (Specified in word unit)

Relay no.	Name	Description
R9030 to R9031	Reserved for system	-
R9032 (R9139)	COM1 port communication mode flag	Turns on when using the general-purpose communication function. Turns off when using a function other than the general-purpose communication.
R9033	Print instruction execution flag	Off: Not executed On: Being executed
R9034	Program edit flag in RUN mode	This is a special internal relay which turns on for only the first scan following the completion of rewriting in RUN mode.
R9035 to R9036	Reserved for system	-
R9037 (R9138)	COM1 port communication error flag	Turns on if a transmission error occurs when performing data communication. Turns off when a transmission request is made by the F159 (MTRN) instruction.
R9038 (R913A)	COM1 port reception done flag during general-purpose communication	Turns on when the end code is received in the general-purpose communication. Turns off when the transmission is requested in the general-purpose communication.

38.3 List of Special Relays

Relay no.	Name	Description
R9039 (R913B)	COM1 port transmission done flag during general-purpose communication	Turns on when the transmission ends in the general-purpose communication. Turns off when the transmission is requested in the general-purpose communication.
R903A	Control flag (CH0)	[FPsigma mode] Turns on when F165 (CAM0), F166 (HC1S) or F167 (HC1R) instruction is being executed, and turns off when it is complete. Turns on when outputting pulses by F171 (SPDH), F172 (PLSH), F173 (PWMH), F174 (SP0H) or F175 (SPSH) instruction.
R903B	Control flag (CH1)	[FPsigma mode] Turns on when F165 (CAM0), F166 (HC1S) or F167 (HC1R) instruction is being executed, and turns off when it is complete.
R903C	Control flag (CH2)	[FPsigma mode] Turns on when F165 (CAM0), F166 (HC1S) or F167 (HC1R) instruction is being executed, and turns off when it is complete. Turns on when outputting pulses by F171 (SPDH), F172 (PLSH), F173 (PWMH), F174 (SP0H) or F175 (SPSH) instruction.
R903D	Control flag (CH3)	[FPsigma mode] Turns on when F165 (CAM0), F166 (HC1S) or F167 (HC1R) instruction is being executed, and turns off when it is complete.
R903E (R9132)	COM0 port transmission done flag during general-purpose communication	Turns on when the end code is received in the general-purpose communication. Turns off when the transmission is requested in the general-purpose communication.
R903F (R9133)	COM0 port transmission done flag during general-purpose communication	Turns on when the transmission ends in the general-purpose communication. Turns off when the transmission is requested in the general-purpose communication.

(Note 1) R9030 to R903F will change even during one scan cycle. In addition, the same functions are allocated to the special internal relays in parentheses.

WR904 (Specified in word unit)

Relay no.	Name	Description
R9040 (R9131)	COM0 port communication mode flag	Turns on when using the general-purpose communication function. Turns off when using a function other than the general-purpose communication function.
R9041 (R913E)	COM1 port PLC link flag	Turns on when using the PLC link function.
R9042 (R9141)	COM2 port communication mode flag	Turns on when using the general-purpose communication function. Turns off when using a function other than the general-purpose communication function.
R9043	Reserved for system	-
R9044	COM1 port	Indicates whether the F145 (SEND) or F146 (RECV) instruction can be executed or not for the COM1 port.

Relay no.	Name	Description
(R913C)	SEND/RCV instruction execution flag	OFF: Not executable (Instruction is being executed) ON: Executable
R9045 (R913D)	COM1 port SEND/RCV instruction execution end flag	Indicates the execution state of the F145 (SEND) or F146 (RCV) instruction for the COM1 port. OFF: Normal end ON: Abnormal end (Communication error occurs) The error code is stored in DT90124.
R9046	Reserved for system	-
R9047 (R9140)	COM2 port communication error flag	Turns on if a transmission error occurs when performing data communication. Turns off when a transmission request is made by the F159 (MTRN) instruction.
R9048 (R9142)	COM2 port reception done flag during general-purpose communication	Turns on when the end code is received in the general-purpose communication. Turns off when the transmission is requested in the general-purpose communication.
R9049 (R9143)	COM2 port transmission done flag during general-purpose communication	Turns on when the transmission ends in the general-purpose communication. Turns on when the transmission is requested in the general-purpose communication.
R904A (R9144)	COM2 port SEND/RCV instruction execution flag	Indicates whether the F145 (SEND) or F146 (RCV) instruction can be executed or not for the COM2 port. OFF: Not executable (Instruction is being executed) ON: Executable
R904B (R9145)	COM2 port SEND/RCV instruction execution end flag	Indicates the execution state of the F145 (SEND) or F146 (RCV) instruction for the COM2 port. OFF: Normal end ON: Abnormal end (Communication error occurs) The error code is stored in DT90125.
R904C to R904F	Reserved for system	-

(Note 1) R9040 to R904F will change even during one scanning cycle. In addition, the same functions are allocated to the special internal relays in parentheses.

WR905 (Specified in word unit)

Relay no.	Name	Description
R9050	MEWNET-W0 PLC link transmission error flag	When using MEWNET-W0 Turns on when a transmission error occurs in the PLC link. Turns on when there is an error in the setting for the PLC link area.
R9051 to R905F	Reserved for system	-

WR906 (Specified in word unit)

Relay no.	Name	Unit no.	Description
R9060	MEWNET-W0	Unit no. 1	Unit no. 1 When normally communicating in the PLC link mode: ON

38.3 List of Special Relays

Relay no.	Name	Description
		When stopping, a error occurs or the PLC link is not performed: OFF
R9061		Unit no. 2 When normally communicating in the PLC link mode: ON When stopping, a error occurs or the PLC link is not performed: OFF
R9062		Unit no. 3 When normally communicating in the PLC link mode: ON When stopping, a error occurs or the PLC link is not performed: OFF
R9063		Unit no. 4 When normally communicating in the PLC link mode: ON When stopping, a error occurs or the PLC link is not performed: OFF
R9064		Unit no. 5 When normally communicating in the PLC link mode: ON When stopping, a error occurs or the PLC link is not performed: OFF
R9065		Unit no. 6 When normally communicating in the PLC link mode: ON When stopping, a error occurs or the PLC link is not performed: OFF
R9066	Transmission assurance relay for PLC link 0	Unit no. 7 When normally communicating in the PLC link mode: ON When stopping, a error occurs or the PLC link is not performed: OFF
R9067		Unit no. 8 When normally communicating in the PLC link mode: ON When stopping, a error occurs or the PLC link is not performed: OFF
R9068		Unit no. 9 When normally communicating in the PLC link mode: ON When stopping, a error occurs or the PLC link is not performed: OFF
R9069		Unit no. 10 When normally communicating in the PLC link mode: ON When stopping, a error occurs or the PLC link is not performed: OFF
R906A		Unit no. 11 When normally communicating in the PLC link mode: ON When stopping, a error occurs or the PLC link is not performed: OFF
R906B		Unit no. 12 When normally communicating in the PLC link mode: ON When stopping, a error occurs or the PLC link is not performed: OFF
R906C		Unit no. 13 When normally communicating in the PLC link mode: ON

Relay no.	Name	Description
		When stopping, a error occurs or the PLC link is not performed: OFF
R906D		Unit no. 14 When normally communicating in the PLC link mode: ON When stopping, a error occurs or the PLC link is not performed: OFF
R906E		Unit no. 15 When normally communicating in the PLC link mode: ON When stopping, a error occurs or the PLC link is not performed: OFF
R906F		Unit no. 16 When normally communicating in the PLC link mode: ON When stopping, a error occurs or the PLC link is not performed: OFF

WR907 (Specified in word unit)

Relay no.	Name	Description
R9070	MEWNET-W0 Operation mode relay for PLC link 0	Unit no. 1 Turns on when the unit no. 1 is in RUN mode. Turns off the unit is in PROG. mode.
R9071		Unit no. 2 Turns on when the unit no. 2 is in RUN mode. Turns off the unit is in PROG. mode.
R9072		Unit no. 3 Turns on when the unit no. 3 is in RUN mode. Turns off the unit is in PROG. mode.
R9073		Unit no. 4 Turns on when the unit no. 4 is in RUN mode. Turns off the unit is in PROG. mode.
R9074		Unit no. 5 Turns on when the unit no. 5 is in RUN mode. Turns off the unit is in PROG. mode.
R9075		Unit no. 6 Turns on when the unit no. 6 is in RUN mode. Turns off the unit is in PROG. mode.
R9076		Unit no. 7 Turns on when the unit no. 7 is in RUN mode. Turns off the unit is in PROG. mode.
R9077		Unit no. 8 Turns on when the unit no. 8 is in RUN mode. Turns off the unit is in PROG. mode.
R9078		Unit no. 9 Turns on when the unit no. 9 is in RUN mode. Turns off the unit is in PROG. mode.
R9079		Unit no. 10 Turns on when the unit no. 10 is in RUN mode. Turns off the unit is in PROG. mode.
R907A		Unit no. 11 Turns on when the unit no. 11 is in RUN mode. Turns off the unit is in PROG. mode.
R907B		Unit no. 12 Turns on when the unit no. 12 is in RUN mode. Turns off the unit is in PROG. mode.
R907C		Unit no. 13 Turns on when the unit no. 13 is in RUN mode. Turns off the unit is in PROG. mode.

38.3 List of Special Relays

Relay no.	Name	Description
R907D		Unit no. 14 Turns on when the unit no. 14 is in RUN mode. Turns off the unit is in PROG. mode.
R907E		Unit no. 15 Turns on when the unit no. 15 is in RUN mode. Turns off the unit is in PROG. mode.
R907F		Unit no. 16 Turns on when the unit no. 16 is in RUN mode. Turns off the unit is in PROG. mode.

WR908 (Specified in word unit)

Relay no.	Name	Description
R9080	MEWNET-W0 Transmission assurance relay for PLC link 1	Unit no. 1 When normally communicating in the PLC link mode: ON When stopping, a error occurs or the PLC link is not performed: OFF
R9081		Unit no. 2 When normally communicating in the PLC link mode: ON When stopping, a error occurs or the PLC link is not performed: OFF
R9082		Unit no. 3 When normally communicating in the PLC link mode: ON When stopping, a error occurs or the PLC link is not performed: OFF
R9083		Unit no. 4 When normally communicating in the PLC link mode: ON When stopping, a error occurs or the PLC link is not performed: OFF
R9084		Unit no. 5 When normally communicating in the PLC link mode: ON When stopping, a error occurs or the PLC link is not performed: OFF
R9085		Unit no. 6 When normally communicating in the PLC link mode: ON When stopping, a error occurs or the PLC link is not performed: OFF
R9086		Unit no. 7 When normally communicating in the PLC link mode: ON When stopping, a error occurs or the PLC link is not performed: OFF
R9087		Unit no. 8 When normally communicating in the PLC link mode: ON When stopping, a error occurs or the PLC link is not performed: OFF
R9088		Unit no. 9 When normally communicating in the PLC link mode: ON When stopping, a error occurs or the PLC link is not performed: OFF

38.3 List of Special Relays

Relay no.	Name	Description
R9089		Unit no. 10 When normally communicating in the PLC link mode: ON When stopping, a error occurs or the PLC link is not performed: OFF
R908A		Unit no. 11 When normally communicating in the PLC link mode: ON When stopping, a error occurs or the PLC link is not performed: OFF
R908B		Unit no. 12 When normally communicating in the PLC link mode: ON When stopping, a error occurs or the PLC link is not performed: OFF
R908C		Unit no. 13 When normally communicating in the PLC link mode: ON When stopping, a error occurs or the PLC link is not performed: OFF
R908D		Unit no. 14 When normally communicating in the PLC link mode: ON When stopping, a error occurs or the PLC link is not performed: OFF
R908E		Unit no. 15 When normally communicating in the PLC link mode: ON When stopping, a error occurs or the PLC link is not performed: OFF
R908F		Unit no. 16 When normally communicating in the PLC link mode: ON When stopping, a error occurs or the PLC link is not performed: OFF

WR909 (Specified in word unit)

Relay no.	Name	Description
R9090	MEWNET-W0 Operation mode relay for PLC link 1	Unit no. 1 Turns on when the unit no. 1 is in RUN mode. Turns off the unit is in PROG. mode.
R9091		Unit no. 2 Turns on when the unit no. 2 is in RUN mode. Turns off the unit is in PROG. mode.
R9092		Unit no. 3 Turns on when the unit no. 3 is in RUN mode. Turns off the unit is in PROG. mode.
R9093		Unit no. 4 Turns on when the unit no. 4 is in RUN mode. Turns off the unit is in PROG. mode.
R9094		Unit no. 5 Turns on when the unit no. 5 is in RUN mode. Turns off the unit is in PROG. mode.
R9095		Unit no. 6 Turns on when the unit no. 6 is in RUN mode. Turns off the unit is in PROG. mode.
R9096		Unit no. 7 Turns on when the unit no. 7 is in RUN mode. Turns off the unit is in PROG. mode.

38.3 List of Special Relays

Relay no.	Name	Description
R9097		Unit no. 8 Turns on when the unit no. 8 is in RUN mode. Turns off the unit is in PROG. mode.
R9098		Unit no. 9 Turns on when the unit no. 9 is in RUN mode. Turns off the unit is in PROG. mode.
R9099		Unit no. 10 Turns on when the unit no. 10 is in RUN mode. Turns off the unit is in PROG. mode.
R909A		Unit no. 11 Turns on when the unit no. 11 is in RUN mode. Turns off the unit is in PROG. mode.
R909B		Unit no. 12 Turns on when the unit no. 12 is in RUN mode. Turns off the unit is in PROG. mode.
R909C		Unit no. 13 Turns on when the unit no. 13 is in RUN mode. Turns off the unit is in PROG. mode.
R909D		Unit no. 14 Turns on when the unit no. 14 is in RUN mode. Turns off the unit is in PROG. mode.
R909E		Unit no. 15 Turns on when the unit no. 15 is in RUN mode. Turns off the unit is in PROG. mode.
R909F		Unit no. 16 Turns on when the unit no. 16 is in RUN mode. Turns off the unit is in PROG. mode.

WR910 to WR912 (Specified in word unit)

Relay no.	Name	Description
R9100 to R9107	Reserved for system	-
R9108	Hold area data error flag	Turns on when a battery runs out and data cannot be held, and turns off when the power supply turns off.
R9109	Memory configuration mismatch detection flag	[C32E only] Turns ON when a memory configuration inconsistency is detected. Turns OFF in normal conditions.
R910A to R910F	Reserved for system	-
R9110	High-speed counter control flag	HSC-CH0
R9111		HSC-CH1
R9112		HSC-CH2
R9113		HSC-CH3
R9114 to R911B	Reserved for system	-
R911C	Pulse output instruction active flag	PLS-CH0
R911D		PLS-CH1
R911E		PLS-CH2
R911F		PLS-CH3
R9120	Reserved for system	-

Relay no.	Name	Description
to R912F		

WR913 (Specified in word unit)

Relay no.	Name	Description
R9130 (R900E)	COM0 port communication error flag	Turns on if a transmission error occurs when performing data communication. Turns off when a transmission request is made by the F159 (MTRN) instruction.
R9131 (R9040)	COM0 port communication mode flag	Turns on when using the general-purpose communication function. Turns off when using a function other than the general-purpose communication function.
R9132 (R903E)	COM0 port transmission done flag during general-purpose communication	Turns on when the end code is received in the general-purpose communication. Turns off when the transmission is requested in the general-purpose communication.
R9133 (R903F)	COM0 port transmission done flag during general-purpose communication	Turns on when the transmission ends in the general-purpose communication. Turns off when the transmission is requested in the general-purpose communication.
R9134	COM0 port SEND/RECV instruction execution flag	Indicates whether the F145 (SEND) or F146 (RECV) instruction can be executed or not for the COM0 port. OFF: Not executable (Instruction is being executed) ON: Executable
R9135	COM0 port SEND/RECV instruction execution end flag	Indicates the execution state of the F145 (SEND) or F146 (RECV) instruction for the COM0 port. OFF: Normal end ON: Abnormal end (Communication error occurs) The error code is stored in DT90123.
R9136	COM0 port PLC link flag	Turns on when using the PLC link function.
R9137	Reserved for system	-
R9138 (R9037)	COM1 port communication error flag	Turns on if a transmission error occurs when performing data communication. Turns off when a transmission request is made by the F159 (MTRN) instruction.
R9139 (R9032)	COM1 port communication mode flag	Turns on when using the general-purpose communication function. Turns off when using a function other than the general-purpose communication function.
R913A (R9038)	COM1 port reception done flag during general-purpose communication	Turns on when the end code is received in the general-purpose communication. Turns off when the transmission is requested in the general-purpose communication.
R913B (R9039)	COM1 port transmission done flag during general-purpose communication	Turns on when the transmission ends in the general-purpose communication. Turns off when the transmission is requested in the general-purpose communication.

38.3 List of Special Relays

Relay no.	Name	Description
R913C (R9044)	COM1 port SEND/RECV instruction execution flag	Indicates whether the F145 (SEND) or F146 (RECV) instruction can be executed or not for the COM1 port. OFF: Not executable (Instruction is being executed) ON: Executable
R913D (R9045)	COM1 port SEND/RECV instruction execution end flag	Indicates the execution state of the F145 (SEND) or F146 (RECV) instruction for the COM1 port. OFF: Normal end ON: Abnormal end (Communication error occurs) The error code is stored in DT90124.
R913E (R9041)	COM1 port PLC link flag	Turns on when using the PLC link function.
R913F	Reserved for system	-

(Note 1) R9130 to R913F will change even during one scanning cycle. In addition, the same functions are allocated to the special internal relays in parentheses to retain compatibility with the conventional model FPsigma Control Unit.

WR914 (Specified in word unit)

Relay no.	Name	Description
R9140 (R9047)	COM2 port communication error flag	Turns on if a transmission error occurs when performing data communication. Turns off when a transmission request is made by the F159 (MTRN) instruction.
R9141 (R9042)	COM2 port communication mode flag	Turns on when using the general-purpose communication function. Turns off when using a function other than the general-purpose communication function.
R9142 (R9048)	COM2 port reception done flag during general-purpose communication	Turns on when the end code is received in the general-purpose communication. Turns off when the transmission is requested in the general-purpose communication.
R9143 (R9049)	COM2 port transmission done flag during general-purpose communication	Turns on when the transmission ends in the general-purpose communication. Turns off when the transmission is requested in the general-purpose communication.
R9144 (R904A)	COM2 port SEND/RECV instruction execution flag	Indicates whether the F145 (SEND) or F146 (RECV) instruction can be executed or not for the COM2 port. OFF: Not executable (Instruction is being executed) ON: Executable
R9145 (R904B)	COM2 port SEND/RECV instruction execution end flag	Indicates the execution state of the F145 (SEND) or F146 (RECV) instruction for the COM2 port. OFF: Normal end ON: Abnormal end (Communication error occurs) The error code is stored in DT90125.
R9146 to R914F	Reserved for system	-

(Note 1) R9140 to R914F will change even during one scanning cycle. In addition, the same functions are allocated to the special internal relays in parentheses to retain compatibility with the conventional model FPsigma Control Unit.

WR915 (Specified in word unit)

Relay no.	Name	Description
R9150 to R915F	Reserved for system	-

WR916 (Specified in word unit)

Relay no.	Name	Description
R9160 to R9161	Reserved for system	-
R9162	RTC error	Turns on if an error is detected in calendar timer data when the unit is powered on. Also, it turns on when inappropriate date and time are written during the operation.
R9163 to R9165	Reserved for system	-
R9166	SNTP time updating failure	Turns on if acquisition of time data has failed during time synch via LAN port. Turns off in normal conditions.
R9167	SNTP time update completed	Turns off when time is being updated with SNTP, and turns on when the update is completed.
R9168 to R916E	Reserved for system	-
R916F	SD card project being copied	Turns ON when project is being copied.

WR917 (Specified in word unit)

Relay no.	Name	Description
R9170	SD slot cover status flag	ON: Cover open OFF: Cover closed
R9171	SD memory card attachment flag	ON: With an SD memory card OFF: Without an SD memory card
R9172	SD memory card recognition completed flag	ON: Completed recognition of an SD memory card OFF: Other than the above
R9173	SD memory card recognition result flag	ON: Error OFF: Normal
R9174	SD memory card write protection flag	ON: Protected OFF: Not protected
R9175	SD memory card type	ON : SD OFF: SDHC
R9176	SD memory card file system	ON: FAT16 OFF: FAT32
R9177	During FTP server log-in	ON: Logged in OFF: Not logged in
R9178	Logging/trace execution (Note 1)	On: Being executed

38.3 List of Special Relays

Relay no.	Name	Description
		OFF: Stops
R9179	Logging/trace buffer storage / File being written (Note 2)	ON: Buffer storage / File being written OFF: Other than the above
R917A	Running SD card access instruction	ON: Instruction execution started OFF: Instruction execution completed
R917B	Completed SD card access instruction execution	ON: Instruction execution completed OFF: Instruction execution started
R917C	Result of SD card access instruction execution	Reports the result when the instruction is completed. ON: Abnormal end OFF: Normal end
R917D to R917E	Reserved for system	-
R917F	Powered off while accessing SD memory card	Turns on if the CPU unit is powered off while accessing an SD memory card.

(Note 1) Turns on when the logging/trace is being executed. Turns off when all stop.

(Note 2) Turns on when buffer storage is performed or file is being written. Turns off when all are other than those operations.

WR918 (Specified in word unit)

Relay no.	Name	Description
R9180	LOG0 Logging/trace execution	Turns on when the logging trace is performed. Other relays in LOGn turn off during the startup operation. Storing data in the buffer memory is executed while this relay turns on.
R9181	LOG0 SD card logging buffer storage/File being written	Turns on when writing files to a SD card becomes enabled after the logging trace execution relay turned on (buffer logging was enabled).
R9182	LOG0 Logging/trace completed	Turns on after the completion of file writing when stopping the logging trace is requested or it is automatically stopped.
R9183	LOG0 Logging over-speed relay	Turns on when the buffer logging speed exceeds the writing speed to a SD memory card in logging operations. Turns on when the number of data previously stored and the number of data stored this time increase. Turns on at the time of buffer storage, and turns off at the time of writing data to an SD memory card or the end of scan.
R9184	LOG0 Buffer overflow	Turns on when the buffer memory has been exhausted. At that time, new data cannot be stored. The value of the buffer overflow counter DT90620 is incremented by one. In that case, writing to SD card does not stop. Turns off at the end of scan when buffer vacancy occurs while writing to an SD memory card is performed. The buffer overflow counter DT90620 is cleared to 0. After buffer vacancy occurred, data logging is executed at the timing of logging to the buffer.
R9185	LOG0 Logging/trace error	Turns on when an error is detected during the logging trace and stops the logging trace.

Relay no.	Name	Description
R9186	LOG0 No SD card free space	Turns on when one of the following conditions is met during the logging/trace operation and stops the logging/trace operation. <ul style="list-style-type: none"> • There is no free capacity in an SD memory card. • An error in accessing an SD memory card occurs.
R9187	LOG0 Device and trigger setting error	Turns on when an error is detected in setting values during the startup operation. The error relay R9185 also turns on. At that time, the execution relay R9180 does not turn on as the logging trace function cannot be started.
R9188	LOG0 Trace stop trigger monitor	Monitors a registered trace stop trigger when executing tracing. Turns on when conditions are met.
R9189	LOG0 Trace data acquisition completed	Turns on after logging data for a specified number of times after detecting the tracing stop trigger during the execution of trace.
R918A to R918F	Reserved for system	-

WR919 (Specified in word unit)

Relay no.	Name	Description
R9190	LOG1 Logging/trace execution	For the details of each control relay, refer to the description for LOG0.
R9191	LOG1 SD card logging buffer storage/File being written	
R9192	LOG1 Logging/trace completed	
R9193	LOG1 Logging over-speed relay	
R9194	LOG1 Buffer overflow	
R9195	LOG1 Logging/trace error	
R9196	LOG1 No SD card free space	
R9197	LOG1 Device and trigger setting error	
R9198	LOG1 Trace stop trigger monitor	
R9199	LOG1 Trace data acquisition completed	
R919A to R919F	Reserved for system	-

WR920 (Specified in word unit)

Relay no.	Name	Description
R9200	LOG2 Logging/trace execution	For the details of each control relay, refer to the description for LOG0.
R9201	LOG2 SD card logging buffer storage/File being written	
R9202	LOG2 Logging/trace completed	
R9203	LOG2 Logging over-speed relay	
R9204	LOG2 Buffer overflow	
R9205	LOG2 Logging/trace error	

38.3 List of Special Relays

Relay no.	Name	Description
R9206	LOG2 No SD card free space	
R9207	LOG2 Device and trigger setting error	
R9208	LOG2 Trace stop trigger monitor	
R9209	LOG2 Trace data acquisition completed	
R920A to R920F	Reserved for system	

WR921 (Specified in word unit)

Relay no.	Name	Description
R9210	LOG3 Logging/trace execution	For the details of each control relay, refer to the description for LOG0.
R9211	LOG2 SD card logging buffer storage/File being written	
R9212	LOG3 Logging/trace completed	
R9213	LOG3 Logging over-speed relay	
R9214	LOG3 Buffer overflow	
R9215	LOG3 Logging/trace error	
R9216	LOG3 No SD card free space	
R9217	LOG3 Device and trigger setting error	
R9218	LOG3 Trace stop trigger monitor	
R9219	LOG3 Trace data acquisition completed	
R921A to R921F	Reserved for system	-

WR922 to WR933 (Specified in word unit)

Relay no.	Name	Description
R9220 to R933F	Reserved for system	-

WR934 (Specified in word unit)

Relay no.	Name	Description
R9340	Ethernet cable disconnection detection	ON: Disconnected OFF: Connected
R9341	Ethernet initialization active	ON: Being initialized OFF: Initialization completed
R9342	IP address determination	ON: Determined OFF: Undetermined
R9343	Reserved for system	-
R9344	FTP server is ready	ON: Preparation completed

Relay no.	Name	Description
		OFF: Unusable
R9345	FTP client is ready	ON: Preparation completed OFF: Unusable
R9346 to R934F	Reserved for system	-

WR935 (Specified in word unit)

Relay no.	Name	Description
R9350	EtherNet/IP preparation done flag	ON: ESDK online OFF: ESDK offline
R9351	EtherNet/IP all nodes normal communication active relay	ON: Normal OFF: Error
R9352	EtherNet/IP all nodes stop relay	ON: Stop OFF: Not stop
R9353	EtherNet/IP abnormal node exists	ON: Exists OFF: Not exist
R9354	EtherNet/IP start/stop control enabled	ON: Controllable OFF: Not controllable
R9355 to R935F	Reserved for system	-

WR936 (Specified in word unit)

Relay no.	Name	Description
R9360	User connection 1	Communication error flag Completion code: DT90840 ON: Transmission error in data communication occurs OFF: F159 (MTRN) instruction is executed
R9361		Reception done flag in general-purpose communication ON: Terminator is received in general-purpose communication OFF: Transmission is requested in general-purpose communication
R9362		Transmission done flag in general-purpose communication ON: On completion of transmission in general-purpose communication OFF: Transmission is requested in general-purpose communication
R9363		SEND/RCV instruction enable flag ON: Enabled OFF: Disabled
R9364		SEND/RCV instruction done flag Completion code: DT90840 ON: Abnormal end (Communication error occurs) OFF: Normal end
R9365		Connection status flag ON: Connected OFF: Not connected
R9366 to R9367	Reserved for system	-

38.3 List of Special Relays

Relay no.	Name	Description
R9368	User connection 2	Communication error flag Completion code: DT90841 ON: Transmission error in data communication occurs OFF: F159 (MTRN) instruction is executed
R9369		Reception done flag in general-purpose communication ON: Terminator is received in general-purpose communication OFF: Transmission is requested in general-purpose communication
R936A		Transmission done flag in general-purpose communication ON: On completion of transmission in general-purpose communication OFF: Transmission is requested in general-purpose communication
R936B		SEND/RECV instruction enable flag ON: Enabled OFF: Disabled
R936C		SEND/RECV instruction done flag Completion code: DT90841 ON: Abnormal end (Communication error occurs) OFF: Normal end
R936D		Connection status flag ON: Connected OFF: Not connected
R936E to R936F	Reserved for system	-

WR937 (Specified in word unit)

Relay no.	Name	Description
R9370	User connection 3	Communication error flag Completion code: DT90842 ON: Transmission error in data communication occurs OFF: F159 (MTRN) instruction is executed
R9371		Reception done flag in general-purpose communication ON: Terminator is received in general-purpose communication OFF: Transmission is requested in general-purpose communication
R9372		Transmission done flag in general-purpose communication ON: On completion of transmission in general-purpose communication OFF: Transmission is requested in general-purpose communication
R9373		SEND/RECV instruction enable flag ON: Enabled OFF: Disabled
R9374		SEND/RECV instruction done flag Completion code: DT90842 ON: Abnormal end (Communication error occurs) OFF: Normal end
R9375		Connection status flag ON: Connected OFF: Not connected
R9376 to R9377	Reserved for system	-

Relay no.	Name	Description
R9378	User connection 4	Communication error flag Completion code: DT90843 ON: Transmission error in data communication occurs OFF: F159 (MTRN) instruction is executed
R9379		Reception done flag in general-purpose communication ON: Terminator is received in general-purpose communication OFF: Transmission is requested in general-purpose communication
R937A		Transmission done flag in general-purpose communication ON: On completion of transmission in general-purpose communication OFF: Transmission is requested in general-purpose communication
R937B		SEND/RECV instruction enable flag ON: Enabled OFF: Disabled
R937C		SEND/RECV instruction done flag Completion code: DT90843 ON: Abnormal end (Communication error occurs) OFF: Normal end
R937D		Connection status flag ON: Connected OFF: Not connected
R937E to R937F	Reserved for system	-

WR938 (Specified in word unit)

Relay no.	Name	Description
R9380	User connection 5	Communication error flag Completion code: DT90844 ON: Transmission error in data communication occurs OFF: F159 (MTRN) instruction is executed
R9381		Reception done flag in general-purpose communication ON: Terminator is received in general-purpose communication OFF: Transmission is requested in general-purpose communication
R9382		Transmission done flag in general-purpose communication ON: On completion of transmission in general-purpose communication OFF: Transmission is requested in general-purpose communication
R9383		SEND/RECV instruction enable flag ON: Enabled OFF: Disabled
R9384		SEND/RECV instruction done flag Completion code: DT90844 ON: Abnormal end (Communication error occurs) OFF: Normal end
R9385		Connection status flag ON: Connected OFF: Not connected
R9386 to R9387	Reserved for system	-

38.3 List of Special Relays

Relay no.	Name	Description
R9388	User connection 6	Communication error flag Completion code: DT90845 ON: Transmission error in data communication occurs OFF: F159 (MTRN) instruction is executed
R9389		Reception done flag in general-purpose communication ON: Terminator is received in general-purpose communication OFF: Transmission is requested in general-purpose communication
R938A		Transmission done flag in general-purpose communication ON: On completion of transmission in general-purpose communication OFF: Transmission is requested in general-purpose communication
R938B		SEND/RECV instruction enable flag ON: Enabled OFF: Disabled
R938C		SEND/RECV instruction done flag Completion code: DT90845 ON: Abnormal end (Communication error occurs) OFF: Normal end
R938D		Connection status flag ON: Connected OFF: Not connected
R938E to R938F	Reserved for system	-

WR939 (Specified in word unit)

Relay no.	Name	Description
R9390	User connection 7	Communication error flag Completion code: DT90846 ON: Transmission error in data communication occurs OFF: F159 (MTRN) instruction is executed
R9391		Reception done flag in general-purpose communication ON: Terminator is received in general-purpose communication OFF: Transmission is requested in general-purpose communication
R9392		Transmission done flag in general-purpose communication ON: On completion of transmission in general-purpose communication OFF: Transmission is requested in general-purpose communication
R9393		SEND/RECV instruction enable flag ON: Enabled OFF: Disabled
R9394		SEND/RECV instruction done flag Completion code: DT90846 ON: Abnormal end (Communication error occurs) OFF: Normal end
R9395		Connection status flag ON: Connected OFF: Not connected
R9396 to R9397	Reserved for system	-

Relay no.	Name	Description
R9398	User connection 8	Communication error flag Completion code: DT90847 ON: Transmission error in data communication occurs OFF: F159 (MTRN) instruction is executed
R9399		Reception done flag in general-purpose communication ON: Terminator is received in general-purpose communication OFF: Transmission is requested in general-purpose communication
R939A		Transmission done flag in general-purpose communication ON: On completion of transmission in general-purpose communication OFF: Transmission is requested in general-purpose communication
R939B		SEND/RECV instruction enable flag ON: Enabled OFF: Disabled
R939C		SEND/RECV instruction done flag Completion code: DT90847 ON: Abnormal end (Communication error occurs) OFF: Normal end
R939D		Connection status flag ON: Connected OFF: Not connected
R939E to R939F	Reserved for system	-

WR940 (Specified in word unit)

Relay no.	Name	Description
R9400	User connection 9	Communication error flag Completion code: DT90848 ON: Transmission error in data communication occurs OFF: F159 (MTRN) instruction is executed
R9401		Reception done flag in general-purpose communication ON: Terminator is received in general-purpose communication OFF: Transmission is requested in general-purpose communication
R9402		Transmission done flag in general-purpose communication ON: On completion of transmission in general-purpose communication OFF: Transmission is requested in general-purpose communication
R9403		SEND/RECV instruction enable flag ON: Enabled OFF: Disabled
R9404		SEND/RECV instruction done flag Completion code: DT90848 ON: Abnormal end (Communication error occurs) OFF: Normal end
R9405		Connection status flag ON: Connected OFF: Not connected
R9406 to R940F	Reserved for system	-

38.4 List of Special Data Registers

38.4 List of Special Data Registers

Register no.	Name	Description	R	W
DT90000	Self-diagnosis error code	When a self-diagnostic error occurs, the error code is stored.	•	
DT90001	Reserved for system	-		
DT90002	FP0H/FPsigma Expansion (Left expansion) Position of abnormal I/O unit	When an error occurs in the I/O unit of FP0H/FPsigma Expansion Unit (left expansion) occurs, the corresponding bit turns on. <div style="display: flex; align-items: center;"> <div style="margin-right: 10px;">15</div> <div style="margin-right: 10px;">11</div> <div style="margin-right: 10px;">7</div> <div style="margin-right: 10px;">3</div> <div style="margin-right: 10px;">2</div> <div style="margin-right: 10px;">1</div> <div style="margin-right: 10px;">0 (Bit no.)</div> </div> <div style="margin-top: 5px; margin-left: 100px;">4 3 2 1 (Unit no.)</div> <p>ON(1): Abnormal OFF(0): Normal</p>	•	
DT90003 to DT90005	Reserved for system	-		
DT90006	FP0H/FPsigma Expansion (Left expansion) Position of abnormal intelligent unit	When an error occurs in the intelligent unit of FP0H/FPsigma Expansion Unit (left expansion) occurs, the corresponding bit turns on. <div style="display: flex; align-items: center;"> <div style="margin-right: 10px;">15</div> <div style="margin-right: 10px;">11</div> <div style="margin-right: 10px;">7</div> <div style="margin-right: 10px;">3</div> <div style="margin-right: 10px;">2</div> <div style="margin-right: 10px;">1</div> <div style="margin-right: 10px;">0 (Bit no.)</div> </div> <div style="margin-top: 5px; margin-left: 100px;">4 3 2 1 (Unit no.)</div> <p>ON(1): Abnormal OFF(0): Normal</p>	•	
DT90007	system register error no.	When there is an inconsistency in the setting of a system register, the corresponding system register no. is stored.	•	
DT90008	Reserved for system	-		
DT90009	Communication error flag	The error content when using the COM2 port is stored. ON (1): Error, OFF (0): Normal <div style="display: flex; align-items: center; margin-bottom: 10px;"> <div style="margin-right: 10px;">bit no. 15</div> <div style="margin-right: 10px;">8</div> <div style="margin-right: 10px;">7</div> <div style="margin-right: 10px;">0</div> </div> <div style="margin-top: 5px; margin-left: 100px;">COM2 Overflow error</div> <div style="margin-top: 5px; margin-left: 100px;">COM2 Parity error</div> <div style="margin-top: 5px; margin-left: 100px;">COM2 Framing error</div> <div style="margin-top: 5px; margin-left: 100px;">COM2 Overrun error</div>	•	
DT90010	FP0/FP0R Expansion (Right expansion) Position of I/O verification mismatched unit	When the installation state of FP0/FP0R Expansion Unit changes from the state when the power turns on, the bit corresponding to the unit number turns on (1). Monitor with BIN display. <div style="display: flex; align-items: center;"> <div style="margin-right: 10px;">15</div> <div style="margin-right: 10px;">11</div> <div style="margin-right: 10px;">2</div> <div style="margin-right: 10px;">1</div> <div style="margin-right: 10px;">0 (Bit no.)</div> </div> <div style="margin-top: 5px; margin-left: 100px;">3 2 1 (Unit no.)</div> <p>ON(1): Abnormal OFF(0): Normal</p>	•	
DT90011	FP0H/FPsigma Expansion (Left expansion) Position of I/O verification mismatched unit	When the installation state of FP0H/FPsigma Expansion Unit (left expansion) changes from the state when the power turns on, the bit corresponding to the unit number turns on (1). Monitor with BIN display.	•	

38.4 List of Special Data Registers

Register no.	Name	Description	R	W
DT90025	Interrupt enable (mask) status (INT0 to 7)	<p>The content set by the ICTL instruction is stored. Monitor with BIN display.</p> <p>15 13 11 7 3 0 (Bit no.)</p> <p>0: Interrupt disabled 1: Interrupt enabled</p> <p>INT0 to INT7: Interrupt input X0 to X7</p>	•	
DT90026	Reserved for system	-		
DT90027	Periodical interrupt interval (INT24)	<p>The content set by the ICTL instruction is stored.</p> <p>K0: Periodical interrupt is not used K1 to K3000: 0.1 ms to 0.35 s or 0.5 ms to 1.5 s or 10 ms to 30 s</p>	•	
DT90028	Interval of sampling trace	<p>K0: Sampling by the SMPL instruction K1 to K3000 (×10ms): 10 ms to 30 s</p>	•	
DT90029	Reserved for system	-		
DT90030	Character storage by F149 MSG instruction	The content (characters) set by the message display instruction (F149) is stored.	•	
DT90031				
DT90032				
DT90033				
DT90034				
DT90035				
DT90036	Position where the status error of left expansion unit occurred	When the status of the left expansion unit is abnormal, the number indicating the position is stored.	•	
DT90037	Operation auxiliary register for SRC instruction	When executing the F96 (SRC) instruction, the number that matches the search data is stored.	•	
DT90038	Operation auxiliary register for SRC instruction	When executing the F96 (SRC) instruction, the relative position that matches is stored.	•	
DT90039	Reserved for system	-		
DT90040	Potentiometer input V0 ^(Note 5)	<p>The value of potentiometer input (K0 to K4000) is stored.</p> <p>It can be applied to the analog timer by reading it to the data register using a user program.</p>	•	
DT90041	Potentiometer input V1 ^(Note 5)	<p>The value of potentiometer input (K0 to K4000) is stored.</p> <p>It can be applied to the analog timer by reading it to the data register using a user program.</p>	•	
DT90042 to DT90043	Reserved for system	-		

(Note 1) Not possible to write to DT90012 using an instruction. Use the tool software to write to DT90012.

(Note 2) It is updated once at the beginning of every scan.

(Note 3) DT90020 is also updated when executing the F0 (MV), DT90020 and D instructions, therefore, it can be used for measuring a block time.

38.4 List of Special Data Registers

(Note 4) The scan time display shows the operation cycle time only in RUN mode. In PROG. mode, the scan time of operation is not displayed. The maximum and minimum values are cleared when switching the mode between RUN and PROG.

(Note 5) It is available only for C32T/C32P. For the FPsigma mode, the value of potentiometer is K0 to 1000.

Register no.	Name		Description	R	W
DT90044	Elapsed value area	Low word	[FPsigma mode] The counting area of the pulse output CH0 (Y0, Y1) or the high-speed counter input CH0 (X0).	•	•
DT90045		High word			
DT90046	Target value area	Low word	[FPsigma mode] The target value is set when executing F166 HC1S, F167 HC1R, or pulse output instruction (F17x).	•	
DT90047		High word			
DT90048	Elapsed value area	Low word	[FPsigma mode] The counting area of the high-speed counter input CH1 (X1).	•	•
DT90049		High word			
DT90050	Target value area	Low word	[FPsigma mode] The target value is set when executing F166 HC1S or F167 HC1R instruction.	•	
DT90051		High word			
DT90052	High-speed counter control flag		<p>When using the high-speed counter function, various controls such as resetting the high-speed counter, disabling the count and clearing the execution of an instruction can be performed by writing values with the MV instruction (F0).</p> <p>Channel specification H0 to H3: CH0 to CH3 H00: Fixed (Note 2) High-speed counter instruction 0: Continue, 1: Clear External reset input 0: Valid, 1: Invalid Count 0: Enable 1: Disable Software reset 0: Disable, 1: Enable</p>	•	•
	Pulse output control flag		<p>When using the pulse output function by the F17x instruction, various controls such as near home input, stopping the pulse output and canceling an instruction can be performed by writing values using the MV instruction (F0).</p> <p>Channel specification H0 to H3: CH0 to CH3 H1: Fixed (Note 2) Near home 0: Invalid 1: Valid Pulse output 0: Continue 1: Stop Count 0: Enable 1: Disable Software reset 0: Disable 1: Enable</p>	•	•

38.4 List of Special Data Registers

(Note 1) When selecting the positioning function in the table setting mode, the control using the pulse output control flag by DT90052 cannot be performed.

(Note 2) In the FPsigma mode, they are empty bits.

Register no.	Name	Description	R	W												
DT90053	Real-time clock monitoring (hour and minute)	<p>The hour and minute data of the real-time clock is stored.</p> <p>You can only read, cannot write.</p> <div style="text-align: center;"> </div>	•													
DT90054	Real-time clock (minute and second)	<p>The year, month, day, hour, minute, second and day-of-the-week data of the real-time clock is stored. The built-in real-time clock is applicable until 2099 and supports leap years.</p> <p>The real-time clock can be set (time synch) by writing desired values using the programming tool or a program based on the transfer instruction (F0).</p> <div style="text-align: center;"> </div> <table border="1" style="margin: 10px auto;"> <tr> <td>DT90054</td> <td>Minute data (H00 to H59)</td> <td>Second data (H00 to H59)</td> </tr> <tr> <td>DT90055</td> <td>Day data (H01 to H31)</td> <td>Hour data (H00 to H23)</td> </tr> <tr> <td>DT90056</td> <td>Year data (H00 to H99)</td> <td>Month data (H01 to H12)</td> </tr> <tr> <td>DT90057</td> <td>—</td> <td>Day of week data (H00 to H06)</td> </tr> </table> <p>The day of the week is not set automatically. Allocate an arbitrary value in the range of H0 to H6 (0: Sunday, 1: Monday, 2: Tuesday, 3: Wednesday, 4: Thursday, 5: Friday, 6: Saturday).</p>	DT90054	Minute data (H00 to H59)	Second data (H00 to H59)	DT90055	Day data (H01 to H31)	Hour data (H00 to H23)	DT90056	Year data (H00 to H99)	Month data (H01 to H12)	DT90057	—	Day of week data (H00 to H06)	•	•
DT90054	Minute data (H00 to H59)		Second data (H00 to H59)													
DT90055	Day data (H01 to H31)		Hour data (H00 to H23)													
DT90056	Year data (H00 to H99)		Month data (H01 to H12)													
DT90057	—	Day of week data (H00 to H06)														
DT90055	Real-time clock (day and hour)															
DT90056	Real-time clock (year and month)															
DT90057	Real-time clock (day of week)															
DT90058	Realtime clock time setting and 30-second compensation register	<p>It is used to adjust the time of the built-in realtime clock.</p> <ul style="list-style-type: none"> Adjust the time by a program <p>By setting the MSB of DT90058 to 1, the time is adjusted to that written to DT90054 to DT90057 by the F0 instruction. After the execution of the time adjustment, DT90058 will be cleared to zero. (It cannot be executed using any other instructions than F0 instruction.)</p> <p><Example> Turn X0 on to set the time to 12:00:00 on the 5th day.</p> <div style="text-align: center;"> </div> Correct a difference within 30 seconds. <p>By setting the LSB to 1, the time is moved up or down to be just 0 second.</p> <p>After the execution of the correction, DT90058 will be cleared to zero.</p> <p><Example> Turn X0 on to correct the time to be 0 second.</p> 	•	•												

38.4 List of Special Data Registers

Register no.	Name	Description	R	W
DT90072	Step ladder process (192 to 207)			
DT90073	Step ladder process (208 to 223)			
DT90074	Step ladder process (224 to 239)			
DT90075	Step ladder process (240 to 255)			
DT90076	Step ladder process (256 to 271)			
DT90077	Step ladder process (272 to 287)			
DT90078	Step ladder process (288 to 303)			
DT90079	Step ladder process (304 to 319)			
DT90080	Step ladder process (320 to 335)			
DT90081	Step ladder process (336 to 351)			
DT90082	Step ladder process (352 to 367)			
DT90083	Step ladder process (368 to 383)			
DT90084	Step ladder process (384 to 399)			
DT90085	Step ladder process (400 to 415)			
DT90086	Step ladder process (416 to 431)	Indicates the starting status of the step ladder process. When the process starts, the bit corresponding to its process number turns on.		
DT90087	Step ladder process (432 to 447)	Monitor with BIN display.		
DT90088	Step ladder process (448 to 463)	<p><Example> 15 11 7 3 0 (Bit no.)</p> <p>DT90100 ┌──────────┐</p> <p> └─ 655 ─┘ └─ 651 ─┘ └─ 647 ─┘ └─ 643 ─┘ └─ 640 (Process no.)</p> <p> 1: Starting 0: During stop</p>		
DT90089	Step ladder process (464 to 479)	The data can be written using the programming tool.		
DT90090	Step ladder process (480 to 495)			
DT90091	Step ladder process (496 to 511)			
DT90092	Step ladder process (512 to 527)			
DT90093	Step ladder process (528 to 543)			
DT90094	Step ladder process (544 to 559)			

38.4 List of Special Data Registers

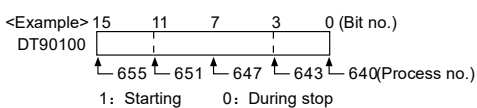
Register no.	Name	Description	R	W			
DT90095	Step ladder process (560 to 575)						
DT90096	Step ladder process (576 to 591)						
DT90097	Step ladder process (592 to 607)						
DT90098	Step ladder process (608 to 623)						
DT90099	Step ladder process (624 to 639)						
DT90100	Step ladder process (640 to 655)						
DT90101	Step ladder process (656 to 671)						
DT90102	Step ladder process (672 to 687)						
DT90103	Step ladder process (688 to 703)				<p>Indicates the starting status of the step ladder process. When the process starts, the bit corresponding to its process number turns on.</p> <p>Monitor with BIN display.</p> <p><Example> </p> <p>The data can be written using the programming tool.</p>		
DT90104	Step ladder process (704 to 719)						
DT90105	Step ladder process (720 to 735)						
DT90106	Step ladder process (736 to 751)						
DT90107	Step ladder process (752 to 767)						
DT90108	Step ladder process (768 to 783)						
DT90109	Step ladder process (784 to 799)						
DT90110	Step ladder process (800 to 815)						
DT90111	Step ladder process (816 to 831)						
DT90112	Step ladder process (832 to 847)						
DT90113	Step ladder process (848 to 863)						
DT90114	Step ladder process (864 to 879)						
DT90115	Step ladder process (880 to 895)						
DT90116	Step ladder process (896 to 911)						
DT90117	Step ladder process (912 to 927)						

38.4 List of Special Data Registers

Register no.	Name	Description	R	W
DT90118	Step ladder process (928 to 943)			
DT90119	Step ladder process (944 to 959)			
DT90120	Step ladder process (960 to 975)			
DT90121	Step ladder process (976 to 991)			
DT90122	Step ladder process (992 to 999) (High byte is not used.)			
DT90123	COM0 SEND/RECV instruction end code	When an error occurs when executing the SEND/RECV instruction, the error code is stored.	•	
DT90124	COM1 SEND/RECV instruction end code		•	
DT90125	COM2 SEND/RECV instruction end code		•	
DT90126	Forced ON/OFF operating station display	Used by the system.	•	
DT90127 to DT90139	Reserved for system	-		

Register no.	Name	Description	R	W
DT90140	MEWNET-W0 PLC link 0 status	PLC link 0 No. of times of reception	•	
DT90141		PLC link 0 Reception interval (current value) (x2.5ms)		
DT90142		PLC link 0 Reception interval (minimum value) (x2.5ms)		
DT90143		PLC link 0 Reception interval (maximum value) (x2.5ms)		
DT90144		PLC link 0 No. of times of transmission		
DT90145		PLC link 0 Transmission interval (current value) (x2.5ms)		
DT90146		PLC link 0 Transmission interval (minimum value) (x2.5ms)		
DT90147		PLC link 0 Transmission interval (maximum value) (x2.5ms)		
DT90148	MEWNET-W0 PLC link 1 status	PLC link 1 No. of times of reception	•	
DT90149		PLC link 1 Reception interval (current value) (x2.5ms)		
DT90150		PLC link 1 Reception interval (minimum value) (x2.5ms)		
DT90151		PLC link 1 Reception interval (maximum value) (x2.5ms)		
DT90152		PLC link 1 No. of times of transmission		

38.4 List of Special Data Registers

Register no.	Name	Description	R	W
DT90153		PLC link 1 Transmission interval (current value) (x2.5ms)		
DT90154		PLC link 1 Transmission interval (minimum value) (x2.5ms)		
DT90155		PLC link 1 Transmission interval (maximum value) (x2.5ms)		
DT90156	MEWNET-W0	PLC link 0 Work for measuring reception interval	•	
DT90157	PLC link 0 status	PLC link 0 Work for measuring transmission interval		
DT90158	MEWNET-W0	PLC link 1 Work for measuring reception interval	•	
DT90159	PLC link 1 status	PLC link 1 Work for measuring transmission interval		
DT90160	MEWNET-W0 PLC link 0 unit no.	The unit number of PLC link 0 is stored.	•	
DT90161	MEWNET-W0 PLC link 0 Error flag	The error content of PLC link 0 is stored.	•	
DT90162 to DT90169	Reserved for system	-		
DT90170	MEWNET-W0 PLC link 0 status	PLC link address duplicate destination	•	
DT90171		No. of missing tokens		
DT90172		No. of duplicate tokens		
DT90173		No. of no signal states		
DT90174		No. of times of receptions of undefined commands		
DT90175		No. of sum check errors for reception		
DT90176		No. of received data format errors		
DT90177		Number of transmission errors		
DT90178		No. of procedure errors		
DT90179		No. of duplicate master units		
DT90180 to DT90189	Reserved for system	-		

Register no.	Name		Description	R	W
DT90190	Control flag monitor	CH0	[FPsigma mode]	•	
DT90191		CH1	When using the high-speed counter function or pulse output function, the contents set into the data register DT90052 by the F0 (MV) instruction are stored for each channel.	•	
DT90192		CH2		•	
DT90193		CH3		•	
DT90194 to DT90199	Reserved for system		-		
DT90200	Elapse d value area	Low word	[FPsigma mode] The counting area of the pulse output CH2 (Y3, Y4) or the high-speed counter input CH2 (X3).	•	•
DT90201		High word			
DT90202	Target value area	Low word	[FPsigma mode] The target value is set when executing F166 HC1S, F167 HC1R, or pulse output instruction (F17x).	•	
DT90203		High word			

38.4 List of Special Data Registers

Register no.	Name		Description	R	W
DT90204	Elapsed value area	Low word	[FPsigma mode] The counting area of the high-speed counter input CH3 (X4).	•	•
DT90205		High word			
DT90206	Target value area	Low word	[FPsigma mode] The target value is set when executing F166 HC1S, F167 HC1R, or pulse output instruction (F17x).	•	
DT90207		High word			
DT90208 to DT90218	Reserved for system		-		

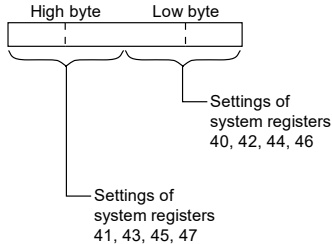
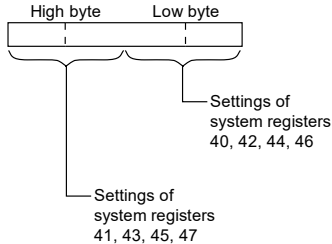
Register no.	Name		Description	R	W
DT90219	Unit number switch of DT90220 to DT90251		0: Unit nos. 1 to 8, 1: Unit nos. 9 to 16	•	
DT90220	PLC link Unit no. 1 or 9	System registers 40 and 41	The settings of the system register related to the PLC link function of each unit number is stored as follows. <Example> When DT90219 is 0; 		
DT90221		System registers 42 and 43			
DT90222		System registers 44 and 45			
DT90223		System registers 46 and 47			
DT90224	PLC link Unit no. 2 or 10	System registers 40 and 41	DT90220 to DT90223 (Unit no. 1) 		
DT90225		System registers 42 and 43			
DT90226		System registers 44 and 45			
DT90227		System registers 46 and 47			
DT90228	PLC link Unit no. 3 or 11	System registers 40 and 41	When the system register no. 46 of the home unit is the standard setting, the values in the home unit will be copied for nos. 46 and 47. When the system register no. 46 of the home unit is the reverse setting, the nos. 40 to 45 and 47 corresponding to those of the home unit will be 50 to 55 and 57, and 46 will be set as it is. Also, nos. 40 to 45 corresponding to other units will be the values after correcting the received values, and nos. 46 and 57 of the home unit will be set for nos. 46 and 47.		
DT90229		System registers 42 and 43			
DT90230		System registers 44 and 45			
DT90231		System registers 46 and 47			

38.4 List of Special Data Registers

Register no.	Name		Description	R	W
DT90232	PLC link Unit no. 4 or 12	System registers 40 and 41			
DT90233		System registers 42 and 43			
DT90234		System registers 44 and 45			
DT90235		System registers 46 and 47			
Register no.	Name		Description	R	W
DT90236	PLC link Unit no. 5 or 13	System registers 40 and 41	<p>The settings of the system register related to the PLC link function of each unit number is stored as follows.</p> <p><Example></p> <p>When DT90219 is 0;</p>		
DT90237		System registers 42 and 43			
DT90238		System registers 44 and 45			
DT90239		System registers 46 and 47			
DT90240	PLC link Unit no. 6 or 14	System registers 40 and 41	<p>DT90220 to DT90223 (Unit no. 1)</p>		
DT90241		System registers 42 and 43			
DT90242		System registers 44 and 45			
DT90243		System registers 46 and 47			
DT90244	PLC link Unit no. 7 or 15	System registers 40 and 41	<p>When the system register no. 46 of the home unit is the standard setting, the values in the home unit will be copied for nos. 46 and 47.</p> <p>When the system register no. 46 of the home unit is the reverse setting, the nos. 40 to 45 and 47 corresponding to those of the home unit will be 50 to 55 and 57, and 46 will be set as it is.</p> <p>Also, nos. 40 to 45 corresponding to other units will be the values after correcting the received values, and nos. 46 and 57 of the home unit will be set for nos. 46 and 47.</p>		
DT90245		System registers 42 and 43			
DT90246		System registers 44 and 45			
DT90247		System registers 46 and 47			

38.4 List of Special Data Registers

Register no.	Name		Description	R	W
DT90248	PLC link Unit no. 8 or 16	System registers 40 and 41			
DT90249		System registers 42 and 43			
DT90250		System registers 44 and 45			
DT90251		System registers 46 and 47			
DT90252 to DT90298	Reserved for system		-		
DT90299	Memory configuration mismatch detail		[C32E only] Turns ON the bit corresponding to the function where a memory configuration inconsistency occurred. Bit 0: Logging trace Bit 1: FTP client Bit 4: EtherNet/IP	•	

All the special data registers described in this page are for the FP0H mode.

Register no.	Name		Description	R	W
DT90300	Elapsed value area	Low word	HSC-CH0	•	•
DT90301		High word			
DT90302	Target value area	Low word	HSC-CH0	•	
DT90303		High word			
DT90304	Elapsed value area	Low word	HSC-CH1	•	•
DT90305		High word			
DT90306	Target value area	Low word	HSC-CH1	•	
DT90307		High word			
DT90308	Elapsed value area	Low word	HSC-CH2	•	•
DT90309		High word			
DT90310	Target value area	Low word	HSC-CH2	•	
DT90311		High word			
DT90312	Elapsed value area	Low word	HSC-CH3	•	•
DT90313		High word			
DT90314	Target value area	Low word	HSC-CH3	•	
DT90315		High word			
DT90316 to DT90347	Reserved for system		-		
DT90348	Elapsed value area	Low word	PLS-CH0	•	•
DT90349		High word			

38.4 List of Special Data Registers

Register no.	Name		Description	R	W
DT90350	Target value area	Low word	When executing the pulse output instruction (F17x), the target value is set.	•	
DT90351		High word		•	
DT90352	Elapsed value area	Low word	The counting area of the pulse output CH1 (Y2, Y3)	•	•
DT90353		High word		•	•
DT90354	Target value area	Low word	When executing the pulse output instruction (F17x), the target value is set.	•	
DT90355		High word		•	
DT90356	Elapsed value area	Low word	The counting area of the pulse output CH2 (Y4, Y5)	•	•
DT90357		High word		•	•
DT90358	Target value area	Low word	When executing the pulse output instruction (F17x), the target value is set.	•	
DT90359		High word		•	
DT90360	Elapsed value area	Low word	The counting area of the pulse output CH3 (Y6, Y7).	•	•
DT90361		High word		•	•
DT90362	Target value area	Low word	When executing the pulse output instruction (F17x), the target value is set.	•	
DT90363		High word		•	
DT90364 to DT90379	Reserved for system		-		

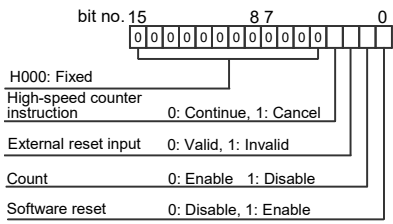
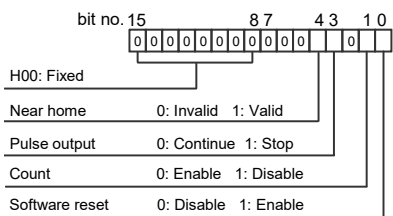
Register no.	Name		Description	R	W
DT90380	High-speed counter function control flag monitor area	HSC-CH0	[FP0H mode]	•	
DT90381		HSC-CH1	When using the high-speed counter function, the contents set into the data register DT90052 by the F0 (MV) instruction are stored for each channel.	•	
DT90382		HSC-CH2		•	
DT90383		HSC-CH3	 <p>bit no. 15 8 7 0</p> <p>0 0 0 0 0 0 0 0 0 0 0 0 0 0 0 0 0 0</p> <p>H00: Fixed</p> <p>High-speed counter instruction 0: Continue, 1: Cancel</p> <p>External reset input 0: Valid, 1: Invalid</p> <p>Count 0: Enable, 1: Disable</p> <p>Software reset 0: Disable, 1: Enable</p>	•	
DT90384 to DT90391	Reserved for system		-		
DT90392	Pulse output function control flag monitor area	PLS-CH0	[FP0H mode]	•	
DT90393		PLS-CH1	When using the pulse output function, the contents set into the data register DT90052 by the F0 (MV) instruction are stored for each channel.	•	
DT90394		PLS-CH2		•	
DT90395		PLS-CH3	 <p>bit no. 15 8 7 4 3 1 0</p> <p>0 0 0 0 0 0 0 0 0 0 0 0 0 0 0 0 0 0</p> <p>H00: Fixed</p> <p>Near home 0: Invalid, 1: Valid</p> <p>Pulse output 0: Continue, 1: Stop</p> <p>Count 0: Enable, 1: Disable</p> <p>Software reset 0: Disable, 1: Enable</p>	•	

38.4 List of Special Data Registers

Register no.	Name	Description	R	W	
DT90396 to DT90399	Reserved for system	-			
DT90400	Correction speed of initial speed	Low word	PLS-CH0	Set when executing the F171 (SPDH) instruction.	•
DT90401		High word			•
DT90402		Low word	PLS-CH1	Set when executing the F171 (SPDH) instruction.	•
DT90403		High word			•
DT90404		Low word	PLS-CH2	Set when executing the F171 (SPDH) instruction.	•
DT90405		High word			•
DT90406		Low word	PLS-CH3	Set when executing the F171 (SPDH) instruction.	•
DT90407		High word			•
DT90408 to DT90499	Reserved for system	-			

Register no.	Name	Description	R	W
DT90500	SD card recognition flag	The content of WR917 is stored.	•	
DT90501	SD card recognition result	ON: Error OFF: Normal	•	
DT90502	Reserved for system	-	•	
DT90503	SD card capacity	Low word	The capacity of the SD memory card is stored. Unit: kB	•
DT90504		High word		•
DT90505	SD card free space	Low word	The free space of the SD memory card is stored. Unit: For SD cards of 2 Gbytes (FAT16), it is always zero.	•
DT90506		High word		•
DT90507 to DT90509	Reserved for system	-		
DT90510	SD card internal information	Time acquisition (Year, month) [BCD]	•	
DT90511		Time acquisition (Day, hour) [BCD]	•	
DT90512		Time acquisition (minute, second) [BCD]	•	
DT90513	Vendor code		•	
DT90514	Internal information 1	VUC version	•	
DT90515		Ratio of max. value of number of times of deletion (%)	•	
DT90516	Internal information 2	Ratio of average value of number of times of deletion (%)	•	
DT90517	Internal information 3	Low words	Max. value of number of times of deletion [32-bit]	•
DT90518		High word		
DT90519	Internal information 4	Low words Low long words	Cumulative number of times of deletion [64-bit]	•
DT90520		High word Low long words		

38.4 List of Special Data Registers

Register no.	Name	Description	R	W	
DT90521		Low words High long words	•		
DT90522		High word High long words			
DT90523	Internal information 5		•		
DT90524	Internal information 6		•		
DT90525	Internal information 7	Low words	•		
DT90526		High word	•		
DT90527	Internal information 8	Low words	•		
DT90528		High word	•		
DT90529	Ethernet communication error code		•		
DT90530	Result of SD card access instruction execution	Saves the error code when the SD card access instruction is executed.			•
		0	Normal end		
		1	No SD memory card	No SD memory card is inserted, or the cover is open.	
		2	SD memory card write protection	The SD memory card is write protected.	
		3	Specified file name error	Code that cannot be specified for a file name is used. There are too many hierarchies for the specified folder.	
		4	No specified file	The specified file does not exist.	
		5	File already exists	The specified file already exists.	
		6	File read error		
		7	File write error	Write protect attributes are set for the specified file.	
		8	File access position error	The reading position or writing position is incorrect.	
		9	SD memory card capacity shortage	Cannot be executed because there is not enough free space on the SD memory card.	
		10	Reading format error	Error in the conversion format when reading a file.	
11	File access competition	A file that is being logged is specified, or a file that			

38.4 List of Special Data Registers

Register no.	Name	Description		R	W																							
			is being accessed via FTP is specified.																									
		-1 to -99	Others																									
DT90531 to DT90589	Reserved for system	-																										
DT90590	Details of network errors	<table border="1"> <thead> <tr> <th>Error code</th> <th>Details</th> </tr> </thead> <tbody> <tr> <td>0x0001</td> <td>Hardware fault</td> </tr> <tr> <td>0x0002</td> <td>Memory usage fault</td> </tr> <tr> <td>0x0003</td> <td>Bus fault</td> </tr> <tr> <td>0x0004</td> <td>Usage fault</td> </tr> <tr> <td>0x1001</td> <td>Startup initialization timeout</td> </tr> <tr> <td>0x2001</td> <td>SSL/TLS initialization failed (API)</td> </tr> <tr> <td>0x2002</td> <td>SSL/TLS initialization failed (FTP server)</td> </tr> <tr> <td>0x2003</td> <td>SSL/TLS session generation failed (FTP server)</td> </tr> <tr> <td>0x2004</td> <td>SSL/TLS certificate reading failed (FTP server)</td> </tr> <tr> <td>0x2006</td> <td>SSL/TLS initialization failed (FTP client)</td> </tr> <tr> <td>0x2007</td> <td>SSL/TLS session generation failed (FTP client)</td> </tr> </tbody> </table>	Error code	Details	0x0001	Hardware fault	0x0002	Memory usage fault	0x0003	Bus fault	0x0004	Usage fault	0x1001	Startup initialization timeout	0x2001	SSL/TLS initialization failed (API)	0x2002	SSL/TLS initialization failed (FTP server)	0x2003	SSL/TLS session generation failed (FTP server)	0x2004	SSL/TLS certificate reading failed (FTP server)	0x2006	SSL/TLS initialization failed (FTP client)	0x2007	SSL/TLS session generation failed (FTP client)	•	
Error code	Details																											
0x0001	Hardware fault																											
0x0002	Memory usage fault																											
0x0003	Bus fault																											
0x0004	Usage fault																											
0x1001	Startup initialization timeout																											
0x2001	SSL/TLS initialization failed (API)																											
0x2002	SSL/TLS initialization failed (FTP server)																											
0x2003	SSL/TLS session generation failed (FTP server)																											
0x2004	SSL/TLS certificate reading failed (FTP server)																											
0x2006	SSL/TLS initialization failed (FTP client)																											
0x2007	SSL/TLS session generation failed (FTP client)																											
DT90591	Server certificate storage status	<p>Check the higher 8 bits of the server certificate storage status (DT90591) to find out whether certificates are written by users or not.</p> <table border="1"> <thead> <tr> <th>DT90591 (Higher 8 bits)</th> <th>Status</th> </tr> </thead> <tbody> <tr> <td>0x00</td> <td>User certificate not written</td> </tr> <tr> <td>0x01</td> <td>User certificate written</td> </tr> </tbody> </table>	DT90591 (Higher 8 bits)	Status	0x00	User certificate not written	0x01	User certificate written	•																			
DT90591 (Higher 8 bits)	Status																											
0x00	User certificate not written																											
0x01	User certificate written																											
DT90592 to DT90599	Reserved for system	-																										
DT90600	LOG0 Buffer free space	Stores free space of buffer memory during logging. Unit: kB	•																									
DT90601	LOG1 Buffer free space		•																									
DT90602	LOG2 Buffer free space		•																									
DT90603	LOG3 Buffer free space		•																									
DT90604 to DT90619	Reserved for system	-																										
DT90620	LOG0 Buffer overflow counter	The number of times buffer overflow flags (e.g. R9184 for LOG0) turn on is stored. For checking the number of times logging data is lost during the buffer overflow, register the buffer overflow counter as logging data.	•																									
DT90621	LOG1 Buffer overflow counter		•																									
DT90622	LOG2 Buffer overflow counter		•																									
DT90623	LOG3 Buffer overflow counter		•																									

38.4 List of Special Data Registers

Register no.	Name	Description	R	W
DT90624 to DT90639	Reserved for system	-		
DT90640	LOG0 No. of written records of current file	Stores the number of written records in a current file as 16-bit data. Increments the number by one every time data is written in the current file. It is reset to zero when a new file is created.	•	
DT90641	LOG1 No. of written records of current file		•	
DT90642	LOG2 No. of written records of current file		•	
DT90643	LOG3 No. of written records of current file		•	
DT90644 to DT90659	Reserved for system	-		
DT90660	LOG0 No. of files (generations) stored in folder	Stores the number of files stored in a folder (number of generations) as 16-bit data.	•	
DT90661	LOG1 No of files (generations) stored in folder		•	
DT90662	LOG2 No of files (generations) stored in folder		•	
DT90663	LOG3 No of files (generations) stored in folder		•	
DT90664 to DT90679	Reserved for system	-		
DT90680 to DT90681	LOG0 Oldest clock data of file stored in folder	Stores the oldest clock data of a file stored in a folder as 32-bit data in seconds. The clock data is the number of seconds accumulated from 00:00:00 on January 1, 2001.	•	
DT90682 to DT90683	LOG1 Oldest clock data of file stored in folder (Low words)		•	
DT90684 to DT90685	LOG2 Oldest clock data of file stored in folder (Low words)		•	
DT90686 to DT90687	LOG3 Oldest clock data of file stored in folder (Low words)		•	
DT90688 to DT90799	Reserved for system	-		

(Note 1) DT90640 to DT90711 are backed up with a battery.

Register no.	Name	Description	R	W
DT90800	User connection 1 Operation mode	The same value as that in the "Operation mode setting" of the user connection setting in the Ethernet configuration is stored. (When the power turns on, the same value as that in the configuration is set.) When changing data by the 461 CONSET instruction, this area will also be updated. 00h: MEWTOCOL-COM 02h: MODBUS-TCP 03h: MEWTOCOL-DAT 08h: General-purpose communication 10h: MC protocol (AnA compatible 3E frame, binary)	•	
DT90801	User connection 2 Operation mode		•	
DT90802	User connection 3 Operation mode		•	
DT90803	User connection 4 Operation mode		•	
DT90804	User connection 5		•	

38.4 List of Special Data Registers

Register no.	Name	Description	R	W
	Operation mode			
DT90805	User connection 6 Operation mode		•	
DT90806	User connection 7 Operation mode		•	
DT90807	User connection 8 Operation mode		•	
DT90808	User connection 9 Operation mode		•	
DT90809 to DT90839	Reserved for system	-	•	
DT90840	User connection 1 SEND/RECV/MTRN done code		•	
DT90841	User connection 2 SEND/RECV/MTRN done code		•	
DT90842	User connection 3 SEND/RECV/MTRN done code		•	
DT90843	User connection 4 SEND/RECV/MTRN done code		•	
DT90844	User connection 5 SEND/RECV/MTRN done code	When specifying the user connection by the F145 (SEND)/F146 (RECV)/F159 (MTRN) instruction, FFFFh is set when the connection is not connected or cut. When completed normally, 0000h is set. For any other values, they vary according to each protocol.	•	
DT90845	User connection 6 SEND/RECV/MTRN done code		•	
DT90846	User connection 7 SEND/RECV/MTRN done code		•	
DT90847	User connection 8 SEND/RECV/MTRN done code		•	
DT90848	User connection 9 SEND/RECV/MTRN done code		•	
DT90849 to DT90889	Reserved for system	-		
DT90890	Slot No.	The slot number specified by the F469 (UNITSEL) instruction is stored. Internal serial: K0, Internal Ethernet: K100 (64h)	•	•
DT90891	Channel No.	The channel number specified by the F469 (UNITSEL) instruction is stored. Internal serial: K0 to K2 (COM0 to COM2)	•	•

38.4 List of Special Data Registers

Register no.	Name	Description	R	W
		Internal Ethernet: K1 to K9 (User connections 1 to 9)		
DT90892 to DT90899	Reserved for system	-		
DT90900	Home MAC address	It is the same as the value read by the F465 (ETSTAT) instruction. (3 words) Example: When the MAC address is "00-C0-8F-64-09-18", "00-C0-8F" is vendor ID. It is stored as follows. DT90900: 0918h DT90901: 8F64h DT90902: 00C0h	•	
DT90901			•	
DT90902			•	
DT90903	Reserved for system	-		
DT90904	Home IPv4 address	It is the same as the value read by the F465 (ETSTAT) instruction. (4 words) Example: When the IPv4 address is "192.168.1.5.", it is stored as follows. DT90904: 192 DT90905: 168 DT90906: 1 DT90907: 5	•	
DT90905			•	
DT90906			•	
DT90907			•	
DT90908 to DT90999	Reserved for system	-		

38.5 Allocation of Memory Areas

38.5.1 When Using Pulse Output Table Setting Mode

■ Control unit

Channel no.		Input/output contact number used							Memory area used		
		CW or Pulse output	CCW or Sign output	Deviation counter clear output	Home input (Note 1)	Near home input (Note 2)	Over limit input (Note 3)	J-point positioning start input	Busy flag	Elapsed value area	
Independent	CH0	Y0	Y1	Y2	X2	(Y850)	(Y860) (Y861)	X0	(X808)	(Note 4)	
	CH1	Y3	Y4	Y5	X5	(Y851)	(Y862) (Y863)	X1	(X809)		
	CH2	Y8	Y9	YA	X6	(Y852)	(Y864) (Y865)	X3	(X80A)		
	CH3	YB	YC	YD	X7	(Y853)	(Y866) (Y867)	X4	(X80B)		
Linear interpolation (Note 1)	CH0	X-axis	Y0	Y1	Y2	X2	(Y850)	(Y860) (Y861)	-	(X808)	(Note 4)
		Y-axis	Y3	Y4	Y5	X5	(Y851)	(Y862) (Y863)		(X809)	
	CH2	X-axis	Y8	Y9	YA	X6	(Y852)	(Y864) (Y865)		(X80A)	
		Y-axis	YB	YC	YD	X7	(Y853)	(Y866) (Y867)		(X80B)	

(Note 1) Even when setting the linear interpolation, the interpolation operation is not performed for the home return. Execute the operation for X axes and Y axes separately.

(Note 2) The near home input will be valid when arbitrary inputs are allocated and the output relays indicated in the above table turn ON.

(Note 3) The over limit input (+) and over limit input (-) will be valid when arbitrary inputs are allocated and the output relays indicated in the above table turn ON. The I/O numbers in the upper rows (Y860 to Y866) in the above table are over limit input (+), the I/O numbers in the lower rows (Y861 to Y867) are over limit input (-).

(Note 4) The elapsed values are stored in the axis information area of the positioning memory. They can be read by user programs using the F384 instruction.

38.5.2 When Using Pulse Output Function (FPsigma Compatible Instruction Mode)

■ Related instructions

F0 (MV), F1 (DMV), F171 (SPDH), F172 (PLSH), F174 (SP0H), F175 (SPSH)

■ Control unit

FP0H mode

Channel no.		Input/output contact number used					Memory area used				Max. output frequency (Note 4)	
		CW or Pulse output	CCW or Sign output	Deviation counter clear output	Home input (Note 1)	Near home input (Note 2)	Control flag	Elapsed value area (Note 3)	Target value area	Correction on speed area of initial speed		
Independent	CH0	Y0	Y1	Y2	X2	DT 90052 bit 4	R911C	DT90348 DT90349	DT90350 DT90351	DT90400 DT90401	100kHz	
	CH1	Y3	Y4	Y5	X5		R911D	DT90352 DT90353	DT90354 DT90355	DT90402 DT90403	100kHz	
	CH2	Y8	Y9	YA	X6		R911E	DT90356 DT90357	DT90358 DT90359	DT90404 DT90405	100kHz	
	CH3	YB	YC	YD	X7		R911F	DT90360 DT90361	DT90362 DT90363	DT90406 DT90407	100kHz	
Linear interpolation	CH0	X-axis	Y0	Y1	Y2	-	R911C	DT90348 DT90349	DT90350 DT90351	DT90400 DT90401	Composite speed 100kHz	
		Y-axis	Y3	Y4	Y5		X5	R911D	DT90352 DT90353	DT90354 DT90355		DT90402 DT90403
	CH2	X-axis	Y8	Y9	YA		X6	R911E	DT90356 DT90357	DT90358 DT90359		DT90404 DT90405
		Y-axis	YB	YC	YD		X7	R911F	DT90360 DT90361	DT90362 DT90363		DT90406 DT90407

38.5 Allocation of Memory Areas

FPsigma mode

Channel no.		Input/output contact number used					Memory area used				Max. output frequency (Note 4)
		CW or Pulse output	CCW or Sign output	Deviation counter clear output	Home input (Note 1)	Near home input (Note 2)	Control flag	Elapsed value area (Note 3)	Target value area	Correction speed area of initial speed	
Independent	CH0	Y0	Y1	Y2	X2	DT90052 bit4	R903 A	DT9004 4 DT9004 5	DT9004 6 DT9004 7	DT9040 0 DT9040 1	100kHz
	CH2	Y3	Y4	Y5	X5		R903 C	DT9020 0 DT9020 1	DT9020 2 DT9020 3	DT9040 4 DT9040 5	
Linear interpolation	CH0	X-axis	Y0	Y1	-	-	R903 A	DT9004 4 DT9004 5	DT9004 6 DT9004 7	DT9040 0 DT9040 1	Composite speed 100kHz
		Y-axis	Y3	Y4	-		R903 C	DT9020 0 DT9020 1	DT9020 2 DT9020 3	DT9040 4 DT9040 5	

(Note 1) Even when setting the linear interpolation, the interpolation operation is not performed for the home return. Execute the operation for X axes and Y axes separately.

(Note 2) The near home input will be valid when an arbitrary input is allocated and the bit 4 of the special data register DT90052 turns on.

(Note 3) Only F1 (DMV) instruction can perform the reading and writing of elapsed value area.

(Note 4) These values are available only when the conditions of each item (such as output method or No. of channels) are executed.

These values are not available if executing the HSC match ON/OFF instruction, other pulse I/O process simultaneously or executing the interrupt program.

38.5.3 When Using PWM Output Function

■ Related instructions

F171 (PWMH)

■ Control unit

FP0H mode

Channel no.	Output no.	Control flag	Output frequency (Duty)
CH0	Y0	R911C	1.0 Hz to 70 kHz: Resolution of 1000 (0.0% to 100.0%) 70001 Hz to 100 kHz: Resolution of 100 (0% to 100%)
CH1	Y3	R911D	
CH2	Y8	R911E	

Channel no.	Output no.	Control flag	Output frequency (Duty)
CH3	YB	R911F	

FPsigma mode

Channel no.	Output no.	Control flag	Output frequency (Duty)
CH0	Y0	R903A	1.0 Hz to 70 kHz: Resolution of 1000 (0.0% to 100.0%)
CH2	Y3	R903C	70001 Hz to 100 kHz: Resolution of 100 (0% to 100%)

- **Maximum output frequency of pulse output/PWM output**

These values are available only when the conditions of each item (such as output method or channels) are executed. These values are available when the operations such as the high-speed counter, pulse output function or other interrupt controls are not performed.

38.5.4 When Using High-speed Counter Function

- **Related instructions**

F0 (MV), F1 (DMV), F165 (CAM0), F166 (HC1S), F167 (HC1R)

- **Memory allocation**

FP0H mode

Channel no.	Count input	Hardware reset input	Memory area used			Performance Specifications		
			Control flag	Elapsed value area	Target value area	Min. input pulse width	Max. counting speed	
[Single-phase] Addition input Subtraction input	CH0	X0	X2	R9110	DT90300 DT90301	DT90302 DT90303	High-speed input 5 μs	100kHz
	CH1	X1	X2	R9111	DT90304 DT90305	DT90306 DT90307		
	CH2	X3	X5	R9112	DT90308 DT90309	DT90310 DT90311		
	CH3	X4	X5	R9113	DT90312 DT90313	DT90314 DT90315		
[2-phase input] Phase difference input Individual input Direction distinction	CH0	X0 X1	X2	R9110	DT90300 DT90301	DT90302 DT90303	High-speed input 10 μs	50 kHz
	CH2	X3 X4	X5	R9112	DT90308 DT90309	DT90310 DT90311		

38.5 Allocation of Memory Areas

FPsigma mode

Channel no.		Count input	Hardware reset input	Memory area used			Performance Specifications	
				Control flag	Elapsed value area	Target value area	Min. input pulse width	Max. counting speed
[Single-phase] Addition input Subtraction input	CH0	X0	X2	R903A	DT90044 DT90045	DT90046 DT90047	High-speed input 5 μ s	100kHz
	CH1	X1	X2	R903B	DT90048 DT90049	DT90050 DT90051		
	CH2	X3	X5	R903C	DT90200 DT90201	DT90202 DT90203		
	CH3	X4	X5	R903D	DT90204 DT90205	DT90206 DT90207		
[2-phase input] Phase difference input Individual input Direction distinction	CH0	X0 X1	X2	R903A	DT90044 DT90045	DT90046 DT90047	High-speed input 10 μ s	50 kHz
	CH2	X3 X4	X5	R903C	DT90200 DT90201	DT90202 DT90203		

(Note 1) When the reset input settings of reset input for the single-phase input overlap at CH0 and CH1 or CH2 and CH3, the setting of CH0 or CH2 has priority.

(Note 2) Only F1 (DMV) instruction can perform the reading and writing of elapsed value area.

■ Maximum counting speed

These values are available only when the conditions of each item (such as counting method or channels) are executed. These values are available when the high-speed counter match ON (F166) instruction, high-speed counter match OFF (F167) instruction, pulse output function or other interrupt controls are not performed.

38.6 FPsigma Mode

38.6.1 Overview of FPsigma Mode

FPsigma mode is a mode for using projects for the existing model FPsigma series in FP0H. Although some functions of FP0H are limited, compatibility with FPsigma is maintained.

■ Comparison of specifications

Item		Specifications		
		Conventional model FPsigma series	FP0H series	
			FPsigma mode	FP0H mode Values in [] are for C32E only.
Program capacity ^(Note 1)		32K steps	24K / 32K steps	24K / 32K / [40K / 64K] steps
Data register capacity ^(Note 1)		32765 words	65533 / 32765 words	65533 / 32765 / [24573 / 12285] words
Automatic backup in case of power outage ^(Note 2)	Internal relay	R2480 to R255F (Fixed)	R2480 to R255F (Fixed)	R5040 to R511F [R2480 to R255F]
	Data register	DT32710 to DT32764 (Fixed)	DT32710 to DT32764 (Fixed)	[DT11970 to DT12284 DT24258 to DT24572] DT32450 to DT32764 DT65218 to DT65532
Pulse/PWM output setting (System register no. 402)		No setting	Cannot be set.	Can be set.
Positioning control mode (System register no. 407)		Cannot be set.	FPsigma compatible instruction mode (Fixed)	Select from table setting mode or FPsigma compatible instruction mode.
Value when system registers are initialized	No.7	248 (Fixed)	248 (Fixed)	[C32] Initialize according to system register no. 1. [C32E] 504 (Fixed)
	No.8	32710 (Fixed)	32710 (Fixed)	Initialize according to system register no. 0.
	No.407	Cannot be set.	FPsigma compatible instruction mode	Table setting mode
	No.430 to No.433	Cannot be set.	No setting	1 ms

(Note 1) The program capacity and data register capacity can be changed according to the setting of system register no. 0.

(Note 2) In the FP0H mode, the automatic backup areas for internal relays and data registers vary according to the settings of system register nos. 0 and 1.

38.6 FPsigma Mode

Item	Specifications		
	Conventional model FPsigma series	FP0H series	
		FPsigma mode	FP0H mode Values in [] are for C32E only.
Potentiometer input (DT90040/90041)	K0 to K1000	K0 to K1000 (C32 only)	K0 to K4000 (C32 only)
High-speed counter/Pulse output ^(Note 1)	4 ch / 2 ch High-speed counter and pulse output share the same memory area	4 ch / 2 ch High-speed counter and pulse output share the same memory area	4 ch / 4 ch High-speed counter and pulse output use independent memory areas

(Note 1) for the details of the high-speed counter/pulse output functions, refer to *FP0H User's Manual (Positioning/PWM Output/High-speed Counter)*.

38.6.2 Converting Projects for FPsigma to Projects for FP0H (FPsigma Mode)

Projects for the conventional model FPsigma can be converted to projects for FP0H (FPsigma mode) by the "Convert PLC Type" function. The following procedure is explained on the condition that a project for FPsigma has been already started on FPWIN GR7.

1 2 Procedure

1. Select **Tools>Convert PLC Type** in the menu bar.
2. Select "FP0H" from the list on the left.

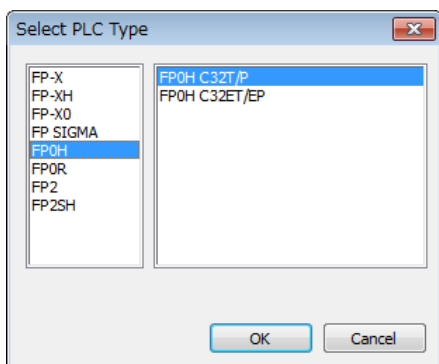

3. Select "FP0H C32T/P" or "FP0H C32ET/EP" and press the [OK] button.
4. The "Convert PLC Type" function will be executed and the project for FPsigma will be converted to the project for FP0H.

i Info.

- Whether the project file is in FP0H mode or FPsigma mode can be confirmed by using system register no. 3 "Compatible mode setting".

- For details of how to confirm this, refer to "38.6.3 Converting Projects for FP0H (FPsigma Mode) to Projects for FP0H (FP0H Mode)".

38.6.3 Converting Projects for FP0H (FPsigma Mode) to Projects for FP0H (FP0H Mode)

Projects for FP0H (FPsigma mode) can be converted to projects for FP0H (FP0H mode) by setting the system register number 3. The following procedure is explained on the condition that a project for FP0H (FPsigma mode) has been already started on FPWIN GR7.

i Info.

- Please change the system registers number 3 offline.

1 2 Procedure

1. Select **Options>System register settings** from the menu bar.
2. Select "Compatible mode" from the list on the left.

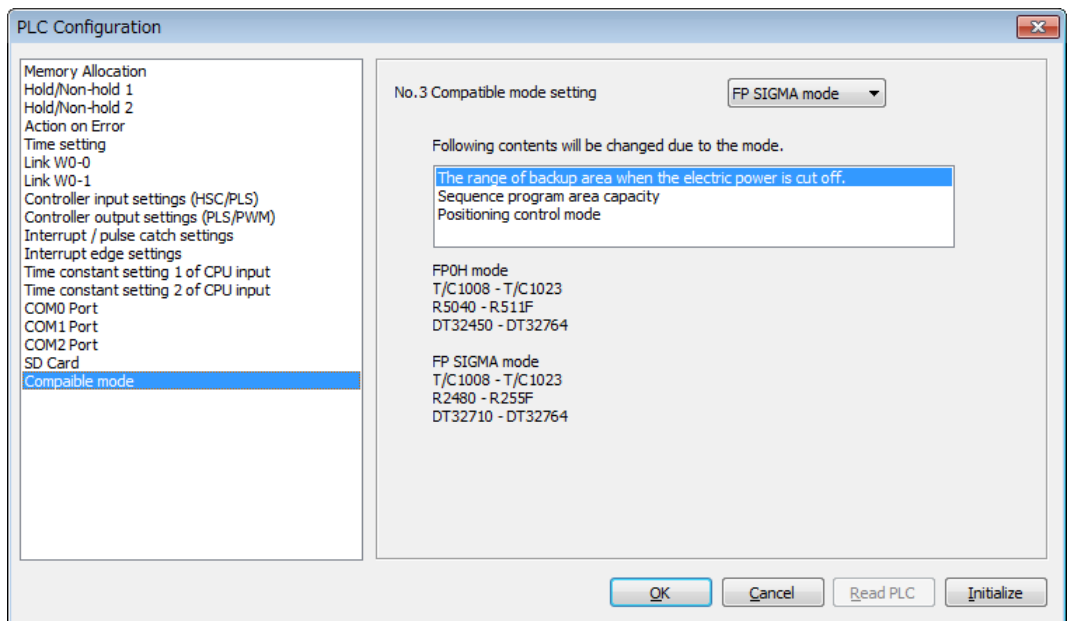

3. Change "No.3 Compatible mode setting" to "FP0H mode" and press the [OK] button.
4. Select **Online>Download to PLC (Entire Project)** from the menu bar.

38.6 FPsigma Mode

38.6.4 Differences in Positioning Instructions with FPsigma

High-speed Counter/Pulse Output Control Instruction F0(MV)

For the FPsigma mode, the following contents are common to FPsigma.

- Control code monitor area
- Allocation of control codes

■ Control code monitor area

Channel no.	Conventional model FPsigma series	FP0H series	
		FPsigma mode	FP0H mode
CH0	DT90190	DT90190	DT90380
CH1	DT90191	DT90191	DT90381
CH2	DT90192	DT90192	DT90382
CH3	DT90193	DT90193	DT90383

■ Allocation of control codes

Conventional model FPsigma and FP0H series (FPsigma mode)

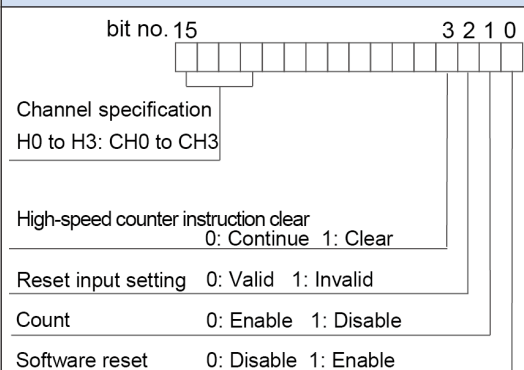
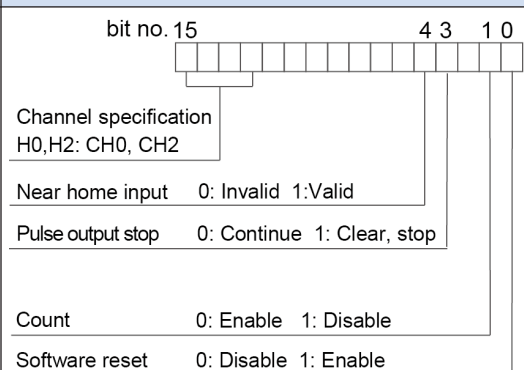
High-speed counter control	Pulse output control
<div style="text-align: center;"> bit no. 15 3 2 1 0  </div>	<div style="text-align: center;"> bit no. 15 4 3 1 0  </div>
Channel specification H0 to H3: CH0 to CH3	Channel specification H0, H2: CH0, CH2
High-speed counter instruction clear 0: Continue 1: Clear	Near home input 0: Invalid 1: Valid
Reset input setting 0: Valid 1: Invalid	Pulse output stop 0: Continue 1: Clear, stop
Count 0: Enable 1: Disable	Count 0: Enable 1: Disable
Software reset 0: Disable 1: Enable	Software reset 0: Disable 1: Enable

FP0H series (FP0H mode)

High-speed counter control		Pulse output control	
bit no. 15 8 3 2 1 0		bit no. 15 8 4 3 1 0	
Channel specification H0 to H3: CH0 to CH3 H0: Fixed High-speed counter instruction clear 0: Continue 1: Clear Reset input setting 0: Valid 1: Invalid Count 0: Enable 1: Disable Software reset 0: Disable 1: Enable		Channel specification H0 to H3: CH0 to CH3 H1: Fixed Near home input 0: Invalid 1: Valid Pulse output stop 0: Continue 1: Stop Count 0: Enable 1: Disable Software reset 0: Disable 1: Enable	

High-speed Counter Instructions F165 (CAM0), F166 (HC1S), F167 (HC1R)

For the FPsigma mode, the following contents are common to FPsigma.

- Operations when instructions are executed
- Allocation of memory areas

■ **Operations when instructions are executed**

In the FP0H mode, operations vary according to the system register no. 402 "Pulse/PWM output settings".

Instruction	Conventional model FPsigma series	FP0H series	
		FPsigma mode	FP0H mode
F165(CAM0)	No instruction	No system register setting	When the destination Y* when the target value matches is other than the normal output setting, an operation error occurs.
F166(HC1S) F167(HC1R)	No system register setting	No system register setting	When the destination Y* when the target value matches is other than the normal output setting, an operation error occurs.

■ **Allocation of memory areas**

Conventional model FPsigma series and FP0H series (FPsigma mode)

Channel no.	Input	Reset input	Elapsed value	Target value	Control flag
CH0	X0	X2	DT90044 DT90045	DT90046 DT90047	R903A
CH1	X1	X2	DT90048 DT90049	DT90050 DT90051	R903B
CH2	X3	X5	DT90200 DT90201	DT90202 DT90203	R903C
CH3	X4	X5	DT90204 DT90205	DT90206 DT90207	R903D

38.6 FPsigma Mode

FP0H series (FP0H mode)

Channel no.	Input	Reset input	Elapsed value	Target value	Control flag
CH0	X0	X2	DT90300 DT90301	DT90302 DT90303	R9110
CH1	X1	X2	DT90304 DT90305	DT90306 DT90307	R9111
CH2	X3	X5	DT90308 DT90309	DT90310 DT90311	R9112
CH3	X4	X5	DT90312 DT90313	DT90314 DT90315	R9113

Pulse/PWM Output Control Instructions

For the FPsigma mode, the following contents are common to FPsigma. However, the designation of PWM control codes is different.

- Operations when instructions are executed
- Allocation of memory areas

■ Operations when instructions are executed

Item	Conventional model	FP0H series		Instruction
	FPsigma series	FPsigma Mode	FP0H mode	
Channel specification	CH0/CH2	CH0/CH2	CH0 to CH3	F171(SPDH) F172(PLSH) F174(SPOH) F173(PWMH)
	CH0	CH0	CH0/CH2	F175(SPSH)
System register no. 402 "Pulse/PWM output settings"	No setting	No setting	When the specified channel is other than "Pulse output (Y*, Y*)", an operation error occurs.	F171(SPDH) F172(PLSH) F174(SPOH) F175(SPSH)
	No setting	No setting	When the specified channel is "Normal output (Y*)", an operation error occurs.	F173(PWMH)
PLC system register nos. 400 and 401 "HSC operation mode settings"	When the specified channel is other than "Not Set X* as High Speed Counter", pulse output is not performed.	When the specified channel is other than "Not Set X* as High Speed Counter", pulse output is not performed.	Not check	F171(SPDH) F172(PLSH) F174(SPOH) F175(SPSH)
Specification of acceleration/ deceleration time by initial speed correction	No setting	The initial speed is set in the initial speed area (special DT).	The initial speed is set in the initial speed area (special DT).	F171(SPDH)
Specification of calculation only	Not available	Available by the specification of control code	Available by the specification of control code	F171(SPDH)

Item	Conventional model FPsigma series	FP0H series		Instruction
		FPsigma Mode	FP0H mode	
(internal table creation only)				
Quick start	Not available Calculation (internal table creation) is performed every time.	Available When the setting is the same as the previous setting, calculation (internal table creation) is not performed.	Available When the setting is the same as the previous setting, calculation (internal table creation) is not performed.	F171(SPDH)

■ Allocation of memory areas

Conventional model FPsigma series and FP0H series (FPsigma mode)

Channel no.	CW or pulse output	CCW or sign output	Deviation counter clear output	Home input	Elapsed value area	Target value area	Control flag	Correction speed area of initial speed
CH0	Y0	Y1	Y2	X2	DT90044 DT90045	DT90046 DT90047	R903A	DT90400 DT90401
CH2	Y3	Y4	Y5	X5	DT90200 DT90201	DT90202 DT90203	R903C	DT90404 DT90405

FP0H series (FP0H mode)

Channel no.	CW or pulse output	CCW or sign output	Deviation counter clear output	Home input	Elapsed value area	Target value area	Control flag	Correction speed area of initial speed
CH0	Y0	Y1	Y2	X2	DT90348 DT90349	DT90350 DT90351	R911C	DT90400 DT90401
CH1	Y3	Y4	Y5	X5	DT90352 DT90353	DT90354 DT90355	R911D	DT90402 DT90403
CH2	Y8	Y9	YA	X6	DT90356 DT90357	DT90358 DT90359	R911E	DT90404 DT90405
CH3	YB	YC	YD	X7	DT90360 DT90361	DT90362 DT90363	R911F	DT90406 DT90407

■ Operation of PWM output instruction (F173 PWMH)

Item	Conventional mode FPsigma series	FP0H series (FP0H mode/FPsigma mode)
Frequency	1.5 Hz to 41.7 kHz	1 Hz to 100 kHz
Duty ratio	0 to 99.9%	0 to 100%
Frequency setting	Specify by integers.	

38.6 FPsigma Mode

Item	Conventional mode FPsigma series	FP0H series (FP0H mode/FPsigma mode)				
	Not available	Specify the output frequency in 2-word 32-bit data. Setting range: K1 to K100000 (1 Hz to 100 kHz: in 1 Hz increments)				
	Specify by control codes.					
	It can be set to any of 25 levels in the table below by control codes.		It can be set to any of 31 levels in the table below by control codes.			
	Setting	Frequency (Hz)	Resolution	Setting	Frequency (Hz)	Resolution
	K0	1.5	1000	K0	1.5	1000
	K1	2.0	1000	K1	2.0	1000
	K2	4.1	1000	K2	4.0	1000
	K3	6.1	1000	K3	6.0	1000
	K4	8.1	1000	K4	8.0	1000
	K5	9.8	1000	K5	10.0	1000
	K6	19.5	1000	K6	20.0	1000
	K7	48.8	1000	K7	50.0	1000
	K8	97.7	1000	K8	100.0	1000
	K9	201.6	1000	K9	200.0	1000
	K10	403.2	1000	K10	400.0	1000
	K11	500.0	1000	K11	500.0	1000
	K12	694.4	1000	K12	700.0	1000
	K13	1.0k	1000	K13	1.0k	1000
	K14	1.3k	1000	K14	1.3k	1000
	K15	1.6k	1000	K15	1.6k	1000
	K16	2.1k	1000	K16	2.0k	1000
	K17	3.1k	1000	K17	3.0k	1000
	K18	6.3k	1000	K18	6.0k	1000
	K19	12.5k	1000	K19	12.5k	1000
	K20	15.6k	100	K20	15.0k	1000
	K21	20.8k	100	K21	20.0k	1000
	K22	25.0k	100	K22	25.0k	1000
	K23	31.3k	100	K23	30.0k	1000
	K24	41.7k	100	K24	40.0k	1000
	-			K25	50.0k	1000
	-			K26	60.0k	1000
	-			K27	70.0k	1000
	-			K28	80.0k	100

Item	Conventional mode FPsigma series	FP0H series (FP0H mode/FPsigma mode)		
	-	K29	90.0k	100
	-	K30	100.0k	100

(Note 1) For details of the operation of PWM output instructions, refer to "24.5 [F173 PWMH] PWM Output Instruction (Frequency Specification)" and "24.6 [F173 PWMH] PWM Output Instruction (Control Code Specification)".

38.7 Positioning Memory

38.7 Positioning Memory

38.7.1 Configuration of Memory Map

The positioning memory consists of four areas.

■ Whole memory map

Area		Absolute (Decimal)	No. of words and configuration		
No.	Name				
0	Common area	0000-0029	30 words		
1	Axis information area	0030-0039	For CH0	10 words for each channel	
		0040-0049	For CH1		
		0050-0059	For CH2		
		0060-0069	For CH3		
		0070-0099	Reserved for system		
2	Axis setting area	0100-0129	For CH0	30 words for each channel	
		0130-0159	For CH1		
		0160-0189	For CH2		
		0190-0219	For CH3		
		0220-0299	Reserved for system		
3	Positioning Table area	0300-0549	For CH0	250 words for each channel	
			0300-0309	Table 1	10 words for each table
			0490-0499	Table 20	
		0500-0549	Reserved area for the system		
		0550-0799	For CH1	250 words for each channel	
		0800-1049	For CH2		
		1050-1299	For CH3		
1300-1799	Reserved for system				

(Note 1) The addresses in the table are the addresses which indicate the configurations in the positioning memory. For reading/writing data using user programs, use an area number and offset address in combination for specification.

■ Reading from positioning memory

- It is possible to read the areas which are shown with "Available" in the "R" column in the following table using the F384 (PTBLR) instruction in user programs during RUN. The operand of the instruction is specified using the combination of an area number and offset address.

■ Writing to positioning memory

- When the mode changes from PROG. to RUN, the contents set by the tool software Configurator PMX will be stored.
- It is possible to rewrite the areas which are shown with "Available" in the "W" column in the following table using the F385 (PTBLW) instruction in user programs during RUN. The operand of the instruction is specified using the combination of an area number and offset address.
- Be sure not to execute writing in the reserved areas for the system.

38.7.2 Common area (Memory Area No. 0)

- : Available, -: Not available

Address	Name	Default	Description	R	W																								
0000	Axis setting	H0	Stores used channels (axes) and usage methods. Monitor using binary display.	•	•																								
			<table border="1"> <thead> <tr> <th>bit no.</th> <th>Settings</th> </tr> </thead> <tbody> <tr> <td>0</td> <td>Not use CH0 (0) / Use CH0 (1)</td> </tr> <tr> <td>1</td> <td>Not use CH1 (0) / Use CH1 (1)</td> </tr> <tr> <td>2</td> <td>Not use CH2 (0) / Use CH2 (1)</td> </tr> <tr> <td>3</td> <td>Not use CH3 (0) / Use CH3 (1)</td> </tr> <tr> <td>4-7</td> <td>Disable the setting</td> </tr> <tr> <td>8</td> <td>As interpolation axis, Not use CH0/CH1 (0) / Use CH0/CH1 (1)</td> </tr> <tr> <td>9</td> <td>As interpolation axis, Not use CH2/CH3 (0) / Use CH2/CH3</td> </tr> <tr> <td>10-11</td> <td>Disable the setting</td> </tr> <tr> <td>12(Note 1)</td> <td>Use the interpolation control of CH0 and CH1 based on the axis setting of CH0: Use (0) / Not use (1)</td> </tr> <tr> <td>13(Note 1)</td> <td>Use the interpolation control of CH2 and CH3 based on the axis setting of CH2: Use (0) / Not use (1)</td> </tr> <tr> <td>14-15</td> <td>Disable the setting</td> </tr> </tbody> </table>			bit no.	Settings	0	Not use CH0 (0) / Use CH0 (1)	1	Not use CH1 (0) / Use CH1 (1)	2	Not use CH2 (0) / Use CH2 (1)	3	Not use CH3 (0) / Use CH3 (1)	4-7	Disable the setting	8	As interpolation axis, Not use CH0/CH1 (0) / Use CH0/CH1 (1)	9	As interpolation axis, Not use CH2/CH3 (0) / Use CH2/CH3	10-11	Disable the setting	12(Note 1)	Use the interpolation control of CH0 and CH1 based on the axis setting of CH0: Use (0) / Not use (1)	13(Note 1)	Use the interpolation control of CH2 and CH3 based on the axis setting of CH2: Use (0) / Not use (1)	14-15	Disable the setting
			bit no.			Settings																							
			0			Not use CH0 (0) / Use CH0 (1)																							
			1			Not use CH1 (0) / Use CH1 (1)																							
			2			Not use CH2 (0) / Use CH2 (1)																							
			3			Not use CH3 (0) / Use CH3 (1)																							
			4-7			Disable the setting																							
			8			As interpolation axis, Not use CH0/CH1 (0) / Use CH0/CH1 (1)																							
			9			As interpolation axis, Not use CH2/CH3 (0) / Use CH2/CH3																							
10-11	Disable the setting																												
12(Note 1)	Use the interpolation control of CH0 and CH1 based on the axis setting of CH0: Use (0) / Not use (1)																												
13(Note 1)	Use the interpolation control of CH2 and CH3 based on the axis setting of CH2: Use (0) / Not use (1)																												
14-15	Disable the setting																												
0001	Positioning repeat count (CH0)	K0	Stores the repeat count in decimal when using the repeat control in the position control.	•	•																								
0002	Positioning repeat count (CH1)	K0	<table border="1"> <thead> <tr> <th>Set value</th> <th>Operation</th> </tr> </thead> <tbody> <tr> <td>0 or 1</td> <td>Not repeat an operation.</td> </tr> <tr> <td>2-254</td> <td>Repeat an operation for a specified number of times.</td> </tr> </tbody> </table>	Set value	Operation	0 or 1	Not repeat an operation.	2-254	Repeat an operation for a specified number of times.	•	•																		
			Set value	Operation																									
0 or 1	Not repeat an operation.																												
2-254	Repeat an operation for a specified number of times.																												

38.7 Positioning Memory

Address	Name	Default	Description	R	W				
0003	Positioning repeat count (CH2)	K0	<table border="1"> <thead> <tr> <th>Set value</th> <th>Operation</th> </tr> </thead> <tbody> <tr> <td>255 or more</td> <td>Repeat an operation infinitely.</td> </tr> </tbody> </table>	Set value	Operation	255 or more	Repeat an operation infinitely.	•	•
Set value	Operation								
255 or more	Repeat an operation infinitely.								
0004	Positioning repeat count (CH3)	K0		•	•				
0005 -0006	Reserved for system	-	-	-	-				
0007	Error code	H0	Stores a generated positioning error code in Hex format (hexadecimal) when using the pulse output function (table setting mode). The higher 8 bits indicate channel number. The lower 8 bits indicate error code.	•	-				
0008 -0029	Reserved for system	-	-	-	-				

(Note 1) The bit nos. 12 and 13 can be with the unit firmware Ver. 1.7 or later.

If "Use (0)" is selected, the Y axis (CH1 / CH3) uses the axis settings set for the X axis (CH0 / CH2). The target axis settings are the following parameters under Axis Setting Area (Memory Area No. 2).

Pulse output method, Pulse output rotation direction, Limit (+) switch logic, Limit (-) switch logic, Startup speed, Emergency stop deceleration time, and Limit stop deceleration time

38.7.3 Axis Information Area (Memory Area No. 1)

•: Available, -: Not available

Offset address	Name	Default	Description	R	W
0000	Active or execution done table	K0	Stores the monitor values of the positioning table numbers during the execution or on the completion of each channel. Stored value: 0-20	•	-
0001	Repeat count current value	K0	Stores the repeat count during the operation of each channel. The execution start time is counted as "1". When the repeat count exceeds the upper limit, it returns to "0". When the repeat operation is not enabled, "0" is stored at the positioning control start time. Stored value: 0-65535	•	-
0002 -0003	Elapsed value (Current value coordinate)	K0	Stores the elapsed values (current value coordinate) of each channel. Range: -1,073,741,824 to 1,073,741,823 For the interpolation control, the setting range is as follows. -8,388,608 to +8,388,607	•	•
0004 -0009	Reserved for system	-	-	-	-

38.7.4 Axis Setting Area (Memory Area No. 2)

●: Available, -: Not available

Offset address	Name	Default	Description	R	W																					
0000	Pulse output control code	H0	Stores the settings of pulse output, home position, near home position, and limit signal of each channel. Monitor in binary format.	●	●																					
			<table border="1"> <thead> <tr> <th>bitno.</th> <th>Item</th> <th>Settings</th> </tr> </thead> <tbody> <tr> <td>0</td> <td>Pulse output method</td> <td>0 : Pulse/Sign 1 : CW/CCW</td> </tr> <tr> <td>1</td> <td>Pulse output rotation direction</td> <td>0: Elapsed value + Direction is CW (Forward OFF/Reverse ON) 1: Elapsed value + Direction is CCW (Forward ON/Reverse OFF)</td> </tr> <tr> <td>2</td> <td>Home position logic</td> <td rowspan="4">0: Normal Open (A contact) 1: Normal Close (B contact)</td> </tr> <tr> <td>3</td> <td>Home position proximity logic</td> </tr> <tr> <td>4</td> <td>Limit (+) switch logic</td> </tr> <tr> <td>5</td> <td>Limit (-) switch logic</td> </tr> <tr> <td>6-15</td> <td>Disable the setting</td> <td></td> </tr> </tbody> </table>			bitno.	Item	Settings	0	Pulse output method	0 : Pulse/Sign 1 : CW/CCW	1	Pulse output rotation direction	0: Elapsed value + Direction is CW (Forward OFF/Reverse ON) 1: Elapsed value + Direction is CCW (Forward ON/Reverse OFF)	2	Home position logic	0: Normal Open (A contact) 1: Normal Close (B contact)	3	Home position proximity logic	4	Limit (+) switch logic	5	Limit (-) switch logic	6-15	Disable the setting	
			bitno.			Item	Settings																			
			0			Pulse output method	0 : Pulse/Sign 1 : CW/CCW																			
			1			Pulse output rotation direction	0: Elapsed value + Direction is CW (Forward OFF/Reverse ON) 1: Elapsed value + Direction is CCW (Forward ON/Reverse OFF)																			
			2			Home position logic	0: Normal Open (A contact) 1: Normal Close (B contact)																			
			3			Home position proximity logic																				
4	Limit (+) switch logic																									
5	Limit (-) switch logic																									
6-15	Disable the setting																									
0001 -0002	Startup speed	K100	Stores the settings of the startup speed for each operation of each channel in decimal. Setting range: 1 to 100,000	●	●																					
0003	Home return method	HFF	Stores the settings of home return patterns of each channel. H0: DOG method 1 H1: DOG method 2 H2: DOG method 3 H3: Setting error H4: Setting error H5: Home position method (Z phase method) H6: Data set method HFF: Not use	●	●																					
0004	Home return direction	K0	Stores the settings of home return operation direction in decimal. 0: Elapsed value decreasing direction (Limit - direction) 1: Elapsed value increasing direction (Limit + direction)	●	●																					
0005	Home return acceleration time	K100	Stores the settings of the acceleration time for the home return of each channel in decimal. It indicates the time from the startup speed to the home return target speed. Setting range: 1-10,000 (ms)	●	●																					

38.7 Positioning Memory

Offset address	Name	Default	Description	R	W
0006	Home return deceleration time	K100	Stores the settings of the deceleration time for the home return of each channel in decimal. It indicates the time from the home return target speed to the startup speed. Setting range: 1-10,000 (ms)	•	•
0007 -0008	Home return target speed	K1000	Stores the settings of the target speed for the home return of each channel in decimal. Setting range: 1 to 100,000	•	•
0009 -0010	Home return creep speed	K100	Stores the settings of the creep speed for the home return of each channel in decimal. Setting range: 1 to 100,000	•	•
0011	Deviation counter clear time	K1	Stores the settings of the deviation counter clear signal ON time after the completion of home return of each channel in decimal. Setting range: 1 to 100 (ms) In the case of 0, no deviation counter clear signal is output. In the case of 100 or more, the ON time is set to 100 ms.	•	•
0012 -0013	Coordinate origin	K0	Stores the elapsed values (current value) after the home return. Range: -1,073,741,824 to 1,073,741,823 For the interpolation control, the setting range is as follows. -8,388,608 to +8,388,607	•	•
0014	JOG acceleration time	K0	Stores the settings of the acceleration time for the JOG operation of each channel in decimal. It indicates the acceleration time from startup speed to JOG operation target speed. Setting range: 0 to 10,000 (ms)	•	•
0015	JOG deceleration time	K0	Stores the settings of the deceleration time for the JOG operation of each channel in decimal. It indicates the deceleration time from JOG operation target speed to startup speed. Setting range: 0 to 10,000 (ms)	•	•
0016 -0017	JOG target speed	K1000	Stores the settings of the target speed for the JOG operation of each channel in decimal. Setting range: 1 to 100,000	•	•
0018 -0019	J point change target speed	K1000	Stores the settings of the target speed for changing the J-point control speed for each channel in decimal. Setting range: 1 to 100,000	•	•
0020	Emergency stop deceleration time	K100	Stores the settings of the deceleration time for the emergency stop operation of each channel in decimal. It indicates the deceleration time from 100 kHz to 0 Hz. Setting range: 0 to 10,000 (ms)	•	•
0021	Limit stop deceleration time	K100	Stores the settings of the deceleration time for the limit stop operation of each channel in decimal. It indicates the deceleration time from 100 kHz to 0 Hz. Setting range: 0 to 10,000 (ms)	•	•
0022 -0029	Reserved for system	-	-	-	-

38.7 Positioning Memory

Offset address	Name	Default	Description	R	W
			-8,388,608 to +8,388,607		
0008	Dwell time	K0	Stores the setting of dwell time. Setting range: 0 to 32,767ms	•	•
0009	Reserved for system	-	-	-	-

(Note 1) The offset addresses in the above table are for the table no. 0. They vary according to the table numbers as described on the next page.

■ Offset addresses

Table no.	Control code	Control pattern	Positioning acceleration time	Positioning deceleration time	Positioning target speed	Positioning movement amount	Dwell time
1	0	1	2	3	4-5	6-7	8
2	10	11	12	13	14-15	16-17	18
3	20	21	22	23	24-25	26-27	28
4	30	31	32	33	34-35	36-37	38
5	40	41	42	43	44-45	46-47	48
6	50	51	52	53	54-55	56-57	58
7	60	61	62	63	64-65	66-67	68
8	70	71	72	73	74-75	76-77	78
9	80	81	82	83	84-85	86-87	88
10	90	91	92	93	94-95	96-97	98
11	100	101	102	103	104-105	106-107	108
12	110	111	112	113	114-115	116-117	118
13	120	121	122	123	124-125	126-127	128
14	130	131	132	133	134-135	136-137	138
15	140	141	142	143	144-145	146-147	148
16	150	151	152	153	154-155	156-157	158
17	160	161	162	163	164-165	166-167	168
18	170	171	172	173	174-175	176-177	178
19	180	181	182	183	184-185	186-187	188
20	190	191	192	193	194-195	196-197	198

(Note 1) For the positioning target speed and positioning movement amount, specify the lower address number of 2-word area.

38.8 Configuration Concerning Open Processing

38.8.1 IP Address Setting Specification

■ List of usable IP addresses

Address range	Remarks
000.000.000.001 to 000.255.255.255	Although this range can be set, try not to use it wherever possible.
001.000.000.000 to 126.255.255.255	
128.000.000.000 to 223.255.255.255	

■ List of conditional IP addresses

○: Available; ×: Not available; △: Self IP address is not available, default gateway is available

Address range	Setting using instructions		Setting using tool software		
	E1	E2	T1	T2	T3
000.000.000.000	△	×	△	○	×
127.000.000.000 to 127.255.255.255	×	○	×	○	○
224.000.000.000 to 224.255.255.255	×	○	×	○	○
:	×	○	×	○	○
239.000.000.001 to 239.255.255.255	×	○	×	○	○
240.000.000.001 to 240.255.255.255	×	○	×	○	○
:	×	○	×	○	○
247.000.000.001 to 240.255.255.255	×	○	×	○	○
248.000.000.001 to 248.255.255.255	×	○	×	○	○
:	×	○	×	○	○
255.000.000.001 to 255.255.255.254	×	○	×	○	○
255.255.255.255	×	○	×	×	×

(Note 1) The symbols E1 to E3 and T1 to T3 in the list above refer to combinations in the following table.

Code	Description
E1	Self address setting using F460 (IPv4SET) instruction
E2	Destination address setting using F461 (CONSET) instruction
T1	Master unit IP address (IPv4) setting using tool software
T2	SNTP IP address (name), priority DNS server, alternative DNS server and router IP address settings using tool software
T3	System connection IP address and user connection IP addresses 1 to 9 using tool software

(Note 2) When an invalid IP address is specified using an instruction, an operation error does not result. Instead, error codes CY (R9009) and DT90529 will be set.

38.8 Configuration Concerning Open Processing

■ Net mask setting

Masked bits should be left-justified for net mask setting. The following specifications are invalid.

Input notation	Binary notation
255.255.253.0	11111111. 11111111. 11111101. 00000000

■ Default gateway setting

- Setting may not be possible depending on the combination of IP address and default gateway.
- Specify "000.000.000.000" when default gateway is not to be used.
- Setting is not possible in the following case.
(IP address AND net mask) ≠ (Default gateway address AND net mask)

■ Judgment based on the combination of IP address and net mask

- The following combination is not possible.
IP address AND (Inverse all bits of net mask: 1's complement) = 0
IP address OR (net mask) = 255.255.255.255

* The combination above may occur when masks are set to omission using F460(IPv4SET) instruction.

Example: When net mask = 255.255.0.0, set IP address = 0.0.255.255 using IPv4SET.

The set values for IP address, net mask and default gateway are initialized when communication process is performed using the combination above. Default values are as follows.

IP address = 192.168.1.5; Net mask = 255.255.255.0; Default gateway = 192.168.1.1

38.9 FTP File Transfer Settings

38.9.1 Basic Setup

Configure the settings for a FTP server to be connected.

1 2 Procedure

1. Select **Options>FTP client setting** from the menu bar.
The "FTP client setting" screen is displayed.

The screenshot shows the "FTP client setting" dialog box. On the left, there is a navigation pane with four options: "Basic Setup (Essential)", "FTP file Transfer Settings (* Option)", "Logging/Trace Transfer Settings (* Option)", and "Complete". The "Basic Setup (Essential)" option is selected and highlighted in blue. Below the navigation pane, there is a note: "*either option Set".

The main area of the dialog box contains the following settings:

- Use FTP client function
- FTP server settings for file transfer or logging/trace transfer.
- Select FTP server setting ID. [Dropdown menu] [Add] [Delete]
- FTP Server Setting**
 - IP address or Host name [Text field]
 - Port No. [21] [Dropdown arrow]
- Account setting**
 - User name [Text field]
 - Password [Text field]
- Communication setting**
 - Use SSL/TLS communication (Explicit mode)
 - SSL/TLS Version [TLS1.1 or later] [Dropdown arrow]
 - Open method [Active] [Dropdown arrow]
 - Timeout period [60] [Dropdown arrow] Second (Default: 60)
 - No. of retries [3] [Dropdown arrow]
 - Retry interval [600] [Dropdown arrow] [seconds] [Dropdown arrow]

At the bottom of the dialog box, there are four buttons: "< Back", "Next >", "OK", and "Cancel". Below the dialog box, there is a note: "Make the basic setup of FTP client setting. If not set, registration is not made."

2. Check the box of [Use FTP client function] in Basic Setup (Essential).
The setting field of FTP server setting ID is enabled.

This close-up screenshot shows the "Use FTP client function" checkbox checked. Below it, the text "FTP server settings for file transfer or logging/trace transfer." is visible. The "Select FTP server setting ID." dropdown menu is now enabled and shows a downward arrow. The "Add" and "Delete" buttons are also visible.

38.9 FTP File Transfer Settings

- Click the [Add] button to add the FTP server setting.

The following settings become available by adding the FTP server setting.

The screenshot shows a configuration window for FTP server settings. It is divided into three sections:

- FTP Server Setting:** IP address or Host name (text input), Port No. (spin box with value 21).
- Account setting:** User name (text input), Password (text input).
- Communication setting:**
 - Use SSL/TLS communication (Explicit mode)
 - SSL/TLS Version: TLS1.1 or later (dropdown)
 - Open method: Active (dropdown)
 - Timeout period: 60 (spin box) Second (Default: 60)
 - No. of retries: 3 (spin box)
 - Retry interval: 600 (spin box) seconds (dropdown)

- Set each item.

Item	Default	Description
FTP server settings	IP address or host name	- Set the IP address or host name of the FTP server Input range: 0.0.0.1 to 255.255.255.254
	Port No.	21 Set the port number for the FTP server. Setting range (1 to 65535)
Account settings	User name	- Set the user name for the FTP server. Max. 32 characters
	Password	- Set the password for the FTP server. Max. 32 characters
Communication settings	Use SSL/TLS communication (Explicit mode)	Invalid Set whether to use SSL/TLS communication (Explicit mode) under encrypted connection in the FTP server communication. For the unit firmware Ver. 1.8 or later, the SSL/TLS version can be selected from "TLS1.1 or later" or "TLS1.2 or later".(Note 1) (Note 2)
	Open method	Active Set the open method. (Active or Passive)
	Timeout period	60 seconds Set the timeout period for the FTP server. Setting range (30 to 300 seconds)
	No. of retries	3 Set the number of retries for the FTP server. Setting range (0 to 3 times)
	Retry interval	600 seconds Set the retry interval for the FTP server (10 to 86400 seconds / 1 to 1440 minutes / 1 to 24 hours)

(Note 1) The SSL/TLS communication cannot be used by both the FTP server function and FTP client function at the same time. When setting, "clear" the checkbox "Use SSL/TLS communication (Explicit mode)" of the FTP server function.

(Note 2) Since SSL3.0 is not supported, no alert is returned for a request to authenticate the client.

5. Click the [Next] button to go to the FTP file transfer settings.

i Info.

- When changing the basic setup, select "FTP server setting ID:X".

38.9.2 Overwrite Method and Rename Method

The overwrite method (default) or rename method can be selected for file transfer (PUTFILE or PUTDATA).

■ Operation of overwrite method

- Files are written with specified file names.
- When writing is interrupted for some reasons (such as troubles in network or servers), the partially written file remains.
- It is not possible to judge on the server side whether files have been transferred successfully or not without checking the file size or the contents.

■ Operation of rename method

- Specified data or files are transferred with tentative file names, and they are renamed to specified file names after the successful completion of transfer.
- The successful completion of file transfer can be confirmed by checking the specified file names on the server side.
- The processing time is longer than that of the overwrite method.

■ Tentative file name

- FP0H_MAC address (Hexadecimal 12 characters).tmp (Extension tmp)
- If a file already exists when renaming files, that file is deleted before renaming.
- When retrying the transfer of multiple files, this situation may occur.

i Info.

- For transferring files to FTP servers, the overwrite method or rename method is selectable. As tentative file names are renamed after the completion of the transfer in the rename method, it is possible to confirm that the files have reached to FTP servers successfully.

38.9.3 FTP File Transfer Settings (Sending Files)

Configure the file transfer settings. The following description is made with an assumption that "38.9.1 Basic Setup" has been completed.

This setting is not required when only performing the logging / trace transfer. Click the [Next] button to go to "Logging / Trace Transfer Settings".

38.9 FTP File Transfer Settings

1 2 Procedure

1. Complete the basic setup and click the [Next] button.
The "FTP File Transfer Settings" screen is displayed.

2. Click the [Add] button to add the transfer setting.
The following items become available by adding the transfer setting.

3. Set each item.

Item	Description
FTP server	Select a destination FTP server from the list. The servers registered in Basic Setup are listed.
Target	Select target "file" to be transferred.

Item	Description
Transfer operation	Select "Send (PUT) Overwrite" / "Send (PUT) Rename". To delete files after transfer, check [Delete file after transfer].
From	Specify an SD card file (folder name and file name). Max. 256 characters
To	Specify a (FTP server) login relative folder. Max. 256 characters For specifying the home directory, "" specify </> or </> only.

- Press the [OK] button.
The settings are registered in the project.

Setting example

Item	Example 1 (Transfer to overwrite the file)	Example 2 (Transfer to rename the file)
Transfer operation	Send (PUT) Overwrite	Send (PUT) Rename
From	/File.txt	/SubDir/RFile.txt
To	/PutDir/	/

Example 1

FTP Server Connected FTP server FTP server setting ID:0192.168.1.1 ▾

Target File Device

Transfer operation Send (PUT) Overwrite ▾ Delete file after transfer.

From From: SD card folder + File

/File.txt

To To: (FTP server) Login relative folder

/PutDir/

Info.

- When changing the basic setup after the setting has been completed, select "Transfer setting ID:X".
- For the details of the overwrite method and rename method, refer to "[38.9.2 Overwrite Method and Rename Method](#)".

38.9.4 FTP File Transfer Settings (Getting Files)

Configure the setting for getting files. The following description is made with an assumption that "[38.9.1 Basic Setup](#)" has been completed.

This setting is not required when only performing the logging / trace transfer. Click the [Next] button to go to "Logging / Trace Transfer Settings".

38.9 FTP File Transfer Settings

1 2 Procedure

1. Complete the basic setup and click the [Next] button.
The "FTP File Transfer Settings" screen is displayed.

FTP client setting

Use FTP client function

When requesting the FTP file transfer, files/devices are sent (PUT)/received (GET) to/from the specified FTP server.

Select transfer setting ID.

FTP Server Connected FTP server

Target File Device

Transfer operation Delete file after transfer.

From From: SD card folder + File

To To: (FTP server) Login relative folder

2. Click the [Add] button to add the transfer setting.
The following items become available by adding the transfer setting.

Use FTP client function

When requesting the FTP file transfer, files/devices are sent (PUT)/received (GET) to/from the specified FTP server.

Select transfer setting ID.

FTP Server Connected FTP server

Target File Device

Transfer operation Delete file after transfer.

From From: SD card folder + File

To To: (FTP server) Login relative folder

3. Set each item.

Item	Description
FTP server	Select a destination FTP server from the list. The servers registered in Basic Setup are listed.
Target	Select target "file" to be transferred.

Item	Description
Transfer operation	Select "Get (GET)". To delete files after transfer, check [Delete file after transfer].
From	Specify a destination (FTP server) login relative folder + file. Max. 256 characters For specifying the home directory, "" specify </> or <\> only.
To	Specify an SD card folder (folder name). Max. 256 characters

4. Press the [OK] button.
The settings are registered in the project.

Setting example

Item	Example
Transfer operation	Get (GET)
From	/GetDir/File.txt
To	/

FTP Server Connected FTP server

Target File Device

Transfer operation Delete file after transfer.

From From: (FTP server) Login relative folder + File

To To: SD card folder

Info.

- When changing the file transfer settings after the settings have been completed, select "Transfer setting ID:X".

38.9.5 FTP File Transfer Settings (Sending Files)

Configure the file transfer settings. The following description is made with an assumption that "38.9.1 Basic Setup" has been completed.

This setting is not required when only performing the logging / trace transfer. Click the [Next] button to go to "Logging / Trace Transfer Settings".

1 2 Procedure

1. Complete the basic setup and click the [Next] button.
The "FTP File Transfer Settings" screen is displayed.

38.9 FTP File Transfer Settings

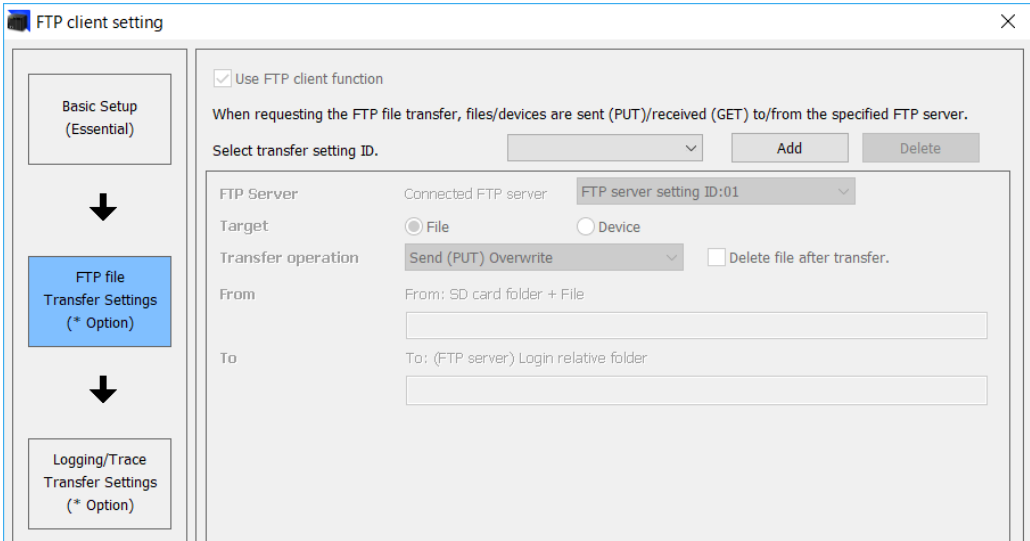

- Click the [Add] button to add the transfer setting.
The following items become available by adding the transfer setting.

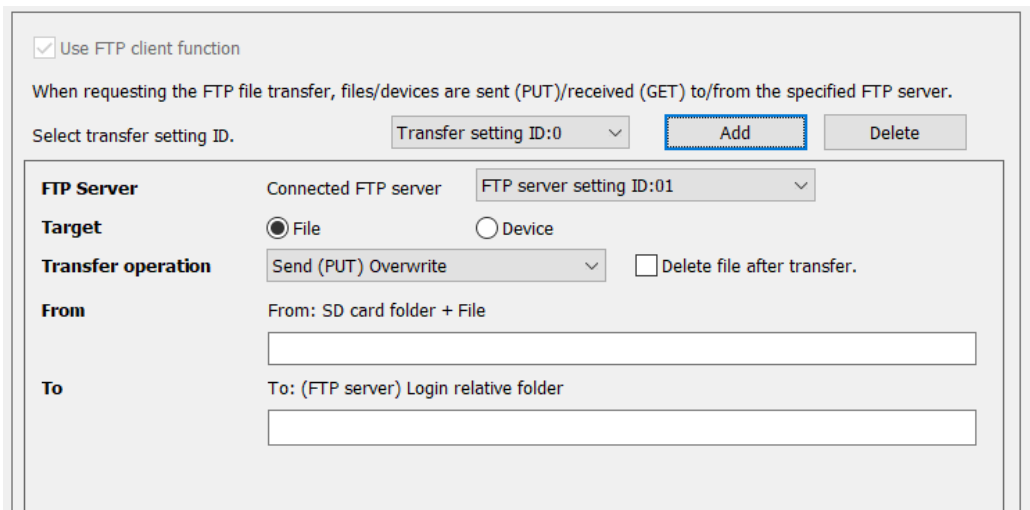

- Set each item.

Item	Description
FTP server	Select a destination FTP server from the list. The servers registered in Basic Setup are listed.
Target	Select target "file" to be transferred.
Transfer operation	Select "Send (PUT) Overwrite" / "Send (PUT) Rename". To delete files after transfer, check [Delete file after transfer].
From	Specify an SD card file (folder name and file name). Max. 256 characters
To	Specify a (FTP server) login relative folder. Max. 256 characters For specifying the home directory, "" specify </> or < > only.

- Press the [OK] button.
The settings are registered in the project.

Setting example

Item	Example 1 (Transfer to overwrite the file)	Example 2 (Transfer to rename the file)
Transfer operation	Send (PUT) Overwrite	Send (PUT) Rename
From	/File.txt	/SubDir/RFile.txt
To	/PutDir/	/

Example 1

FTP Server	Connected FTP server	FTP server setting ID:0192.168.1.1
Target	<input checked="" type="radio"/> File <input type="radio"/> Device	
Transfer operation	Send (PUT) Overwrite	<input type="checkbox"/> Delete file after transfer.
From	From: SD card folder + File	
		/File.txt
To	To: (FTP server) Login relative folder	
		/PutDir/

Info.

- When changing the basic setup after the setting has been completed, select "Transfer setting ID:X".
- For the details of the overwrite method and rename method, refer to "[38.9.2 Overwrite Method and Rename Method](#)".

38.9.6 FTP File Transfer Settings (Getting Device)

Configure the setting for getting devices. The following description is made with an assumption that "[38.9.1 Basic Setup](#)" has been completed.

This setting is not required when only performing the logging/trace transfer. Click the [Next] button to go to "Logging / Trace Transfer Settings".

1 2 Procedure

- Complete the basic setup and click the [Next] button.
The "FTP File Transfer Settings" screen is displayed.

38.9 FTP File Transfer Settings

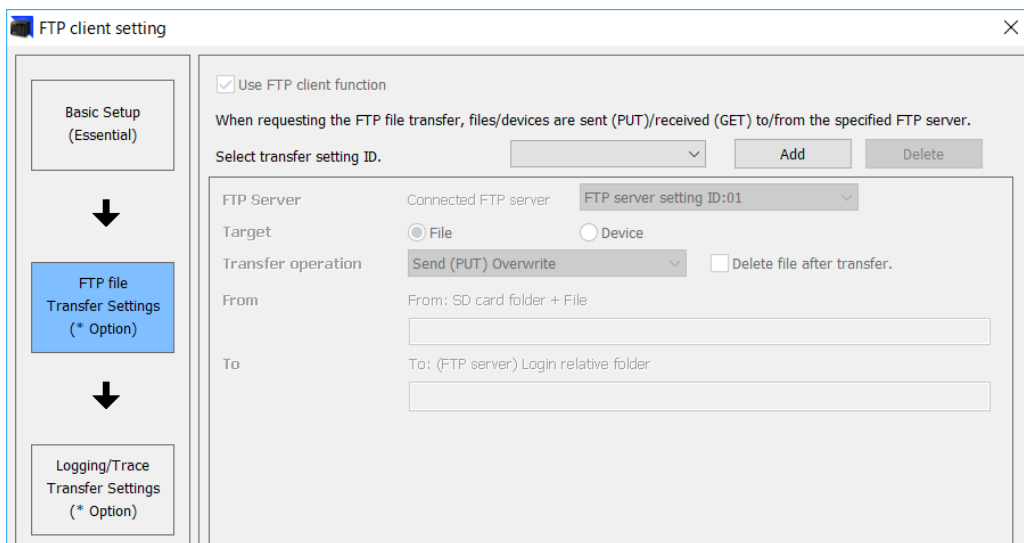

- Click the [Add] button to add the transfer setting.
The following items become available by adding the transfer setting.

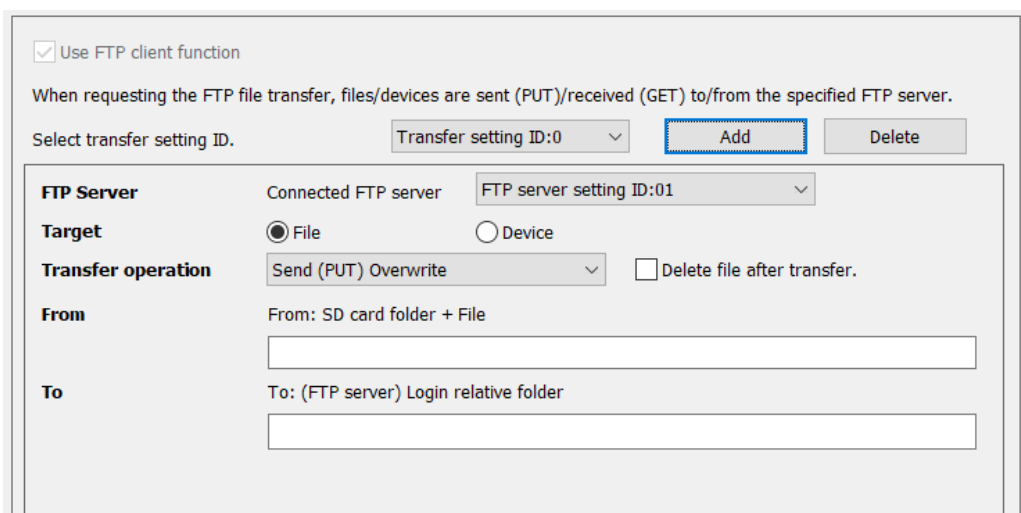

- Set each item.

Item	Description
FTP server	Select a destination FTP server from the list. The servers registered in Basic Setup are listed.
Target	Select a transfer target "device".
Transfer operation	Select "Get (GET)". To delete files after transfer, check [Delete file after transfer].
From	Specify a source file name with (FTP server) login relative folder + file name. For specifying the home directory, "" specify </> or <\> only. Max. 256 characters

Item	Description
To Device setting	Select a device code from the following: (WX, WY, WR, WL, DT, LD, I, SV, EV) Select the device number, number of transferred data, and conversion method.

4. Press the [OK] button.
The settings are registered in the project.

Setting example

Item	Example
Transfer operation	Get (GET)
From	/GetData/DFile.txt
To	Transfer 10 words in US format to the DT200.
Device code	DT (Data register)
Device No.	200
No. of transferred data	10
Conversion method	US: Unsigned 16-bit integer type

i Info.

- When changing the file transfer settings after the settings have been completed, select "Transfer setting ID:X".

38.10 How to Set Logging / Trace Transfer

38.10 How to Set Logging / Trace Transfer

Use the programming tool software "FPWIN GR7" to make the transfer settings.

38.10.1 Basic Setup

For details of Basic Setup, Refer to "[38.9.1 Basic Setup](#)".

38.10.2 Logging / Trace Transfer Settings

Specifies the logging / trace transfer settings. The following description is made with an assumption that "[38.10.1 Basic Setup](#)" has been completed.

1 2 Procedure

1. Complete the basic setup and click the [Next] button.
The "FTP File Transfer Settings" screen is displayed. For using the logging / trace transfer settings, the FTP file transfer settings are not required.
2. Press the [Next] button.
The "Logging / Trace Transfer Settings" screen is displayed.

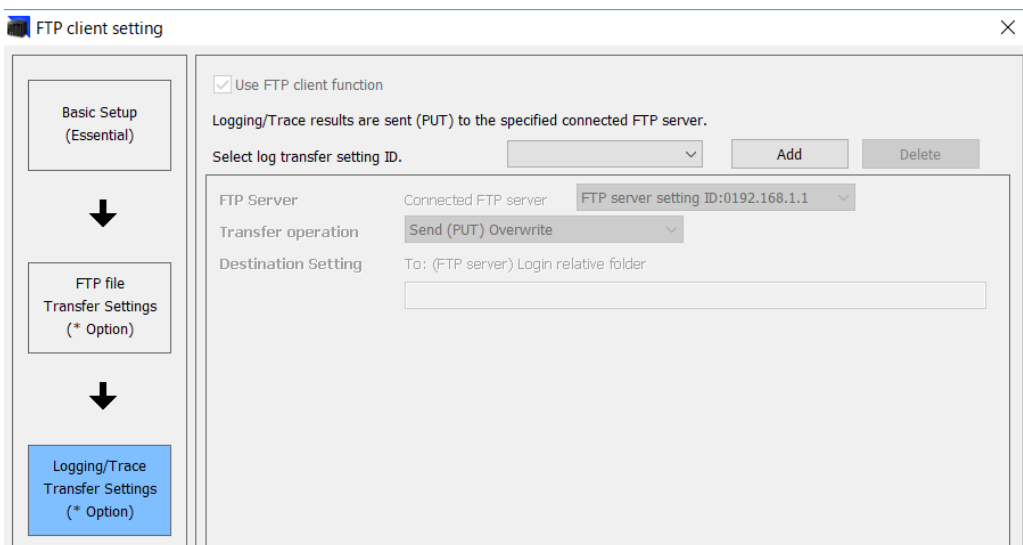

3. Click the [Add] button to add the log transfer setting.
The following items become available by adding the log transfer setting.

Use FTP client function

Logging/Trace results are sent (PUT) to the specified connected FTP server.

Select log transfer setting ID.

FTP Server Connected FTP server

Transfer operation

Destination Setting To: (FTP server) Login relative folder

4. Set each item.

Item	Default	Description
FTP server	-	Select a destination FTP server from the list. The servers registered in Basic Setup are listed.
Transfer operation	Send (PUT) Overwrite	Select "Send (PUT) Overwrite" / "Send (PUT) Rename".
Destination setting	-	Destination: Specify a (FTP server) login relative folder. Max. 256 characters

5. Press the [OK] button.

The settings are registered in the project.

i Info.

- When changing the file transfer settings after the settings have been completed, select "Log transfer setting ID:X".
- For the details of the overwrite method and rename method, refer to "[38.9.2 Overwrite Method and Rename Method](#)".

38.11 Communication Commands

38.11 Communication Commands

38.11.1 List of MEWTOCOL Supported Commands

The MEWTOCOL-DAT commands and MEWTOCOL-COM commands that are supported by this product are as follows.

List of MEWTOCOL-DAT Commands

Type of instruction	Code	Description
Write data area	50H	Writes data to a data area.
Read data area	51H	Reads the contents of a data area.
Write contact information	52H	Turns ON or OFF a contact in the specified area.
Read contact information	53H	Reads the ON / OFF state of a contact in the specified area.

MEWTOCOL-COM

Type of instruction	Code	Description
Read contact area	RC (RCS) (RCP) (RCC)	Reads the ON / OFF status of contacts. <ul style="list-style-type: none">• Specifies only one point.• Specifies multiple contacts.• Specifies a range in word units.
Write contact area	WC (WCS) (WCP) (WCC)	Turns ON or OFF a contact. <ul style="list-style-type: none">• Specifies only one point.• Specifies multiple contacts.• Specifies a range in word units.
Read data area	RD	Reads the contents of a data area.
Write data area	WD	Writes data to a data area.
Register or reset contacts monitored	MC	Registers the contact to be monitored.
Register or reset data monitored	MD	Registers the data to be monitored.
Monitoring start	MG	Monitors a registered contact or data using MD and MC.
Preset contact area (fill command)	SC	Fills the area of a specified range with a 16-point ON / OFF pattern.
Preset data area (fill command)	SD	Writes the same contents to the data area of a specified range.
Read the status of PLC	RT	Reads PLC specification, an error code when an error occurs, etc.
Abort	AB	Aborts communication.

(Note 1) Some devices cannot be accessed due to format limitations of MEWTOCOL-COM communication commands.

38.11.2 List of MODBUS Supported Commands

List of MODBUS Function Codes

■ Supported commands (●: Available, Blank: Not available)

Code	Name (MODBUS)	Name	Remarks (Reference No.)	Corresponding functions	
				Slave	Master
01	Read Coil Status	Read Y / R coils	0X	●	●
02	Read Input Status	Read X contact	1X	●	●
03	Read Hold Register	Read DT	4X	●	●
04	Read Input Registers	Read WL / LD	3X	●	●
05	Force Single Coil	Write single Y / R	0X	●	●
06	Preset Single Register	Write DT1 word	4X	●	●
08	Diagnostics	Loopback test	-	●	
15	Force Multiple Coils	Write multiple Y / R	0X	●	●
16	Preset Multiple Registers	Write DT multiple words	4X	●	●
22	Mask Write 4X Register	Write DT mask	4X	●	
23	Read / Write 4X Registers	Read / write DT	4X	●	

(Note 1) During master communication, MODBUS function codes 01, 02, 03 and 04 use F146 (RECV) instruction, while MODBUS function codes 05, 06, 15 and 16 use F145 (SEND) instruction.

Device No. Correspondence Table

■ Correspondence table between MODBUS command reference Nos. and device Nos.

	MODBUS reference Nos.	Data on BUS (hexadecimal)	PLC device No.
Coil	000001-001760	0000-06DF	Y0-Y109F
	002049-010240	0800-27FF	R0-R511F
Input	100001-101760	0000-06DF	X0-X109F
Holding register	400001-465533	0000-FFFC	DT0-DT65532
Input register	300001-301028	0000-007F	WL0-WL127
	302001-302256	07D0-08CF	LD0-LD255

(Note 1) The table above indicates correspondence between MODBUS reference Nos. for accessing PLC through MODBUS protocol from a higher device and operation device Nos. of PLC.

Response Format of MODBUS-RTU

■ Response in normal status

- For single write commands, the same data as the sent data is returned.

(Example) When function code is "(05) Force Single Coil"

■ Response data in normal status

Address	Field name	Value	Description
0	Slave address	01H	Unit No. is entered. (00H~FFH)
1	Function code	05H	The same function code that was sent is entered.
2	Output address (higher)	00H	The same data that was sent is entered.
3	Output address (lower)	00H	
4	Change data (higher)	FFH	
5	Change data (lower)	00H	
6	CRC16 (L)	3AH	The CRC calculation result of the response data is entered.
7	CRC16 (H)	8CH	

■ Response data in abnormal status

Address	Field name	Value	Description
0	Slave address	01H	Unit No. is entered. (00H~FFH)
1	Function code	85H	The function code that was sent +80H is entered.
2	Error code	01H to 03H	01H: Abnormal function code 02H: Abnormal device number (out of range) 03H: Abnormal device quantity (out of range)
3	CRC16 (L)	**H	The CRC calculation result of the response data is entered.
4	CRC16 (H)	**H	

Response Format of MODBUS TCP

■ Response in normal status

- For single write commands and loopback tests, the same data as the sent data is returned.

(Example) When function code is "(05) Force Single Coil"

■ Response data in normal status

Address	Field name	Value	Description
0	Transaction identifier	00H	00H is entered.
1	Protocol identifier	00H	00H is entered.
2	Message length	06H	Length of the following send/receive message is entered
3	Unit identifier	01H	Unit No. is entered.(00H~FFH) ^(Note 1)

Address	Field name	Value	Description
4	Function code	05H	The same function code that was sent is entered.
5	Output address (higher)	00H	The same data that was sent is entered.
6	Output address (lower)	00H	
7	Change data (higher)	FFH	
8	Change data (lower)	00H	

(Note 1) If the firmware version of the main unit is earlier than Ver. 1.50, the unit No. range is from 01H to F7H.

■ Response data in abnormal status

Address	Field name	Value	Description
0	Transaction identifier	00H	00H is entered.
1	Protocol identifier	00H	00H is entered.
2	Message length	03H	Length of the following send/receive message is entered
3	Unit identifier	01H	Unit No. is entered.(00H~FFH) ^(Note 1)
4	Function code	85H	The function code that was sent +80H is entered.
5	Error code	01H to 03H	01H: Abnormal function code 02H: Abnormal device number (out of range) 03H: Abnormal device quantity (out of range)

(Note 1) If the firmware version of the main unit is earlier than Ver. 1.50, the unit No. range is from 01H to F7H.

Data structure of MODBUS TCP

■ Data structure of MODBUS TCP format

- In MODBUS TCP, an MBAP header is added to function codes and data used in MODBUS-RTU.

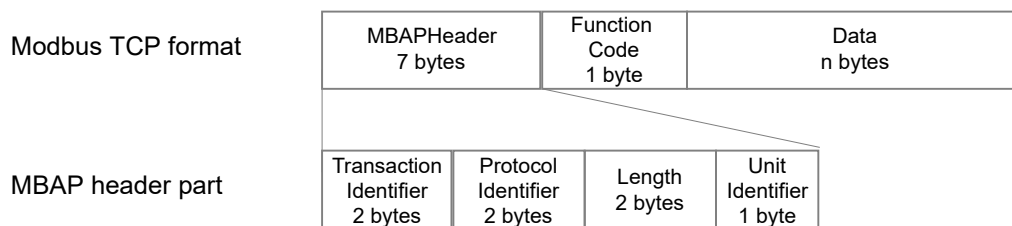

■ Data content

Fields	Field name	Description
MBAP Header	Transaction Identifier	Transaction identifier 00H is entered
	Protocol Identifier	Protocol identifier 00H is entered
	Length	Message length Length of the following send/receive message is entered
	Unit Identifier	Unit identifier Unit No. is entered.(00H~FFH) ^(Note 1)

38.11 Communication Commands

Fields	Field name	Description
Function Code	Function code	The same function name as in MODBUS-RTU is entered
Data	Data	Data corresponding to the function code is entered

(Note 1) If the firmware version of the main unit is earlier than Ver. 1.50, the unit No. range is from 01H to F7H.

i Info.

- Function codes and data sections of MODBUS TCP are the same as those of MODBUS-RTU, except that CRC check code included in the MODBUS-RTU format is excluded.
- For details of MODBUS specifications, refer to the website at <https://www.modbus.org/>.

38.11.3 MC Protocol Communication Commands

■ Supported commands

(●: Available, Empty: Not available)

Command Code	Subcommand	Command name	Data unit	Command description	Support	
					Slave	Master
0401	0001	Bulk read	Bits	Reads bit devices in 1-point units.	●	●
0401	0000		Word	Reads bit devices in 16-point units. Reads word devices in 1-point units.	●	●
1401	0001	Bulk write	Bits	Writes bit devices in 1-point units.	●	●
1401	0000		Word	Writes bit devices in 16-point units. Writes word devices in 1-point units.	●	●

■ Device number correspondence table

Correspondence table of usable devices for the MC protocol slave communication functions

(●: Available, Empty: Not available)

MC protocol			Internal device No.	Transfer units	RD	WT
Device name	Device Code BIN	Device No.				
Input (Note 1)	9C	X0000 to X06DF	X0000 to X109F	Bits Word	●	●
Output (Note 1)	9D	Y0000 to Y06DF	Y0000 to Y109F	Bits Word	●	●
Link relay (Note 1)	A0	B0000 to B07FF	L0000 to L0127F	Bits	●	●

MC protocol			Internal device No.	Transfer units	RD	WT
Device name	Device Code BIN	Device No.				
				Word		
Internal relay	90	M0000 to M8191	R0000 to R511F	Bits Word	•	•
Latch relay (Note 2)	92	L0000 to L8191	R0000 to R511F	Bits Word	•	•
Data register	A8	D00000 to D65532	DT0000 to DT65532	Word	•	•
File register	AF	-	-	Word		
	B0	-	-	Word		
Link register (Note 1)	B4	W0000 to W00FF	LD0000 to LD0255	Word	•	•
Timer (current value) (Note 3)	C2	TN0000 to TN1023	EV0000 to EV1023	Word	•	•
Timer (contact) (Note 3)	C1	TS0000 to TS1023	T0000 to T1023	Bits Word	•	
Counter (current value) (Note 3)	C5	CN0000 to CN1023	EV0000 to EV1023	Bits Word	•	•
Counter (contact) (Note 3)	C4	CS0000 to CS1023	C0000 to C1023	Word	•	
Special relays	91	SM0000 to SM0831	R9000 to R951F		•	
Special data register	A9	SD0000 to SD0999	DT90000 to DT90999		•	

(Note 1) The device No. of the MC protocol of inputs, outputs, link relays and link registers are expressed in hexadecimal. The device No. of other devices are expressed in decimal.

(Note 2) Latch relays are allocated to internal relays. Set them in the hold area if necessary.

(Note 3) The timer / counter area is determined by the "starting No. of the system register No.5 counter".

When a corresponding device No. is contained in the counter area for timer, "4031: Address too long" results. The same applies to counter.

38.12 Error code

38.12 Error code

38.12.1 List of Syntax Check Errors

Error codes 1 to 8

Code	Name	Operation	Error contents and steps to take
E1	Syntax error	Stop	A program with a syntax error has been written. Change to PROG. mode and correct the error.
E2	Duplicated output error	Stop	The relay is used in the 'Out' instruction or 'Keep' instruction more than once. It also occurs when using the same timer/counter number. Change to PROG. mode and correct the program so that one relay is not used for two or more instructions. Or, set the duplicated output to "enable" in the system register no. 20. A timer/counter instruction double definition error will be detected even if double output permission has been selected.
E3	Not paired error	Stop	For instructions which must be used in a pair (such as JP and LBL), one instruction is either missing or in an incorrect position. Change to PROG. mode and enter the two instructions which must be used in a pair in the correct positions.
E4	Parameter mismatch error	Stop	An instruction has been written which does not agree with system register settings. The number setting in a program does not agree with the timer/counter range setting. Change to PROG. mode, check the system register settings, and change so that the settings and the instruction agree.
E5	Program area error ^(Note 1)	Stop	An instruction which must be written in a specific area (main program area or subprogram area) has been written to a different area (for example, a subroutine SUB to RET is placed before an ED instruction). Change to PROG. mode and enter the instruction into the correct area.
E6	Compile memory full	Stop	The program is too large to compile in the program memory. Change to PROG. mode and reduce the total number of steps for the program.
E7	High-level instruction type error	Stop	In the program, high-level instructions, which execute in every scan and at the leading edge of the trigger, are programmed to be triggered by one contact. Correct the program so that the high-level instructions executed in every scan and only at the leading edge are triggered separately.
E8	High-level instruction operand combination error	Stop	There is an incorrect operand in an instruction which requires a specific combination of operands (for example, the operands must all be of a certain type). Enter the correct combination of operands.

(Note 1) The error codes E2 and E5 are detected even when rewriting data with grammatical errors in RUN mode. In this case, nothing will be written into the control unit. The operation continues.

38.12.2 Self-diagnostic Errors

Code	Name	Operation	Error contents and steps to take
E20	Watchdog timeout	Stop	The watchdog timer is activated and the operation stops. A hardware error or operation congestion occurs. Check if an endless loop occurs by a control instruction which changes the flow of the process of a program (such as JP and LOOP). If there is no problem in the program, there may be an error in the hardware.
E21	MAC address error C32ET/C32EP only	Stop	There may be an error in the hardware. Please contact your dealer.
E22	SD host controller error	Stop	It cannot access the SD card.
E26	User ROM error	Stop	There may be an error in the hardware. Please contact your dealer.
E27	Restrictions on the number of units installed	Stop	The number of the installed units exceeds the limitation. Turn off the power and re-configure units referring to the hardware manual.
E34	I/O status error	Stop	An abnormal unit is installed. Check the slot number with DT90036, and replace the abnormal unit with a normal unit.
E40	I/O error	Select	There may be an error in the function cassette. Check the position where the error occurs with the special data register DT90002 and fix the error.
E41	Extra unit out of control	Select	There may be an error in an intelligent unit. Check the position where the error occurs with the special data register DT90006 and fix the error.
E42	I/O verification error	Select	The I/O unit (expansion unit) wiring condition has changed compared to that at time of power-up. Check the I/O unit whose wiring condition has changed with the special data registers DT90010 and DT90011. Or check the fitting state of the expansion connector.
E43	Configuration data error/ Initialization request error	Select	Configuration data is abnormal. An error occurs in the initialization operation of network. Check the Ethernet setting and EtherNet/IP setting.
E44	Positioning operation error occurred	Select	The error when using the table operation function occurs. The set parameter may be incorrect or the limit error may occur. Check if the parameter is in the settable range. The channel and content where the positioning operation error occurs can be confirmed by pressing the [Positioning error] button in the status display dialog box.
E45	Operation error occurred	Select	In executable operation error occurs. The address of the operation error can be confirmed by either special data registers DT90017 or DT90018. In the tool software, it can also be checked with the [Operation errors] button in the status display dialog box.
E46	Network error occurred	Select	An error occurs in the network operation. Check the Ethernet setting and EtherNet/IP setting. For details of network errors, check the special data register No. DT90590.

38.12 Error code

Code	Name	Operation	Error contents and steps to take
E48	System register setting error	Operation stops	The setting value of a system register is abnormal. Check the setting again. Example) The error occurs when the range of the data registers or internal relays set in the system register no. 0 or no. 1 are inconsistent with the settings of hold/non-hold area in the system register no. 7 or no.8, or the buffer area setting for the general-purpose communication in the system register nos. 416 to 423. The system register number can be confirmed by the special register DT90007.
E50	Battery error (A battery comes off or the voltage drops.)	Operation continues	The voltage of the backup battery lowered or the backup battery is not installed in the control unit. Check the backup battery, and replace or connect it if necessary. This self-diagnostic error can be set to be notified or not by the system register no. 4.
E51	RTC error	Operation continues	An error in the clock data of the clock/calendar was detected.
E59	Memory configuration inconsistency	Operation continues	An inconsistency was detected in the memory configuration for logging trace, FTP client, or EtherNet/IP.
E60	Logging setting mismatch (when loading logging settings from an SD card)	Operation continues	An error has been detected in logging data settings.
E61	Logging data error	Operation continues	An error was detected in checking the logging setting when the power turned on.
E62	SNTP time acquisition failure	Operation continues	The acquisition of time data has failed during time synch via LAN port.
E63	Logging/trace registration error	Stop	An error occurs in the logging/trace register/delete command for the MEWTOCOL communication. Check the command format and the registered/deleted content.
E64	Incorrect project data	Stop	An error was detected in checking the project data when the power turned on. All programs and security information will be deleted and the PLC will be initialized.
E65	Auto-run definition file error	Stop	There is an error in the auto-run definition file error. Or, there is no transfer file described in the auto-run definition file.
E70	SD card copy failed: Cover opened	Stop	The copy cannot be executed because the card cover is open. Close the cover.
E71	SD card copy failed: No SD card	Stop	The copy cannot be executed because there is no SD memory card. Insert an SD memory card.
E72	SD card copy failed: SD card operation disabled: SD card	Stop	The copy cannot be executed because the SD memory card is broken. Insert a normal SD memory card.

Code	Name	Operation	Error contents and steps to take
	reading error (FAT/File error)		
E73	SD card copy failed: No file	Stop	The copy cannot be executed because there is no file in the SD memory card. Check if any project file is stored.
E74	SD card copy failed: Password unmatched (Limited distribution function)	Stop	The copy cannot be executed because the password for the project file stored in the SD memory card does not coincide with the password for the execution project stored in the internal ROM. Check the password setting.
E75	SD card copy failed: Incorrect project data	Stop	The copy cannot be executed because the project data stored in the SD memory card is abnormal. Check the contents of the project data.
E100 to E199	Self-diagnostic error set by F148	Stop	An error that has been arbitrarily set by the high-level instruction F148 occurs. Take countermeasures according to the specified detection condition.
E200 to E299		Operation continues	

(Note 1) The error codes 43 to 299 can be cleared by pressing the [Clear errors] button in the status display dialog box of the programming tool or by the F148 (ERR) instruction (clearing a self-diagnostic error by specifying K0).

38.12.3 List of MEWTOCOL-COM/DAT Communication Error Codes

Code	Name	Description of error
I26	Abnormal unit number setting	A command was received that cannot be used globally (station number FF).
I40	BCC error	A transmission error has occurred in the received data.
I41	Format error	A command was received that does not match the format.
I42	No support error	An unsupported command was received.
I43	Multiple frames procedure error	Another command was received while multiple frame processing was in progress.
I60	Parameter error	The specified parameter content does not exist or cannot be used.
I61	Data error	There are errors in contact, data area, specification of data No., size specification, range, or format specification.
I62	Registration over error	The number of registrations has been exceeded or the unit has been operated in an unregistered state.
I63	PC mode error	A command that cannot be processed was executed in "RUN mode" or while SD memory card copy was in progress.
I64	Defective external memory error	The hardware is defective. It is likely an abnormality in the built-in ROM (F-ROM). The specified content exceeded the capacity during ROM transfer. A reading/writing error has occurred.
I65	Protect error	A program or system register write operation was executed while the device was in the protected state (password set).

38.12 Error code

Code	Name	Description of error
!66	Address error	There is an error in the address data code format, or if the address data was excessive or insufficient, there was an error in the range setting.
!67	No program error and No data error	Message read and sampling trace start/read was executed on unregistered data.
!68	Cannot write during RUN error	While RUN was in progress, an attempt was made to edit an instruction that cannot be rewritten (ED, SUB, RET, INT, IRET, SSTP, STPE). Nothing can be written to the control unit.
!71	Exclusive access control error	A command was executed that cannot be processed at the same time as the command in progress.
!78	No SD card error	No SD card is installed.
!80	Abnormal guarantee data error	The guarantee data (CRC code) is abnormal.
!81	No valid data error	No valid data exists.
!90	Error during logging trace	A command was executed that cannot be processed during logging trace.
!92	Unsupported SD card error	The SD card is not an industrial SD card made by Panasonic.
!93	Invalid server error	A command was executed when the target server was invalid.
!94	Certificate write error	Certificate write was executed using an incorrect procedure.
!97	Server connected error	A command was executed when the target server was connected.

38.12.4 List of MODBUS Communication Error Codes

■ Error code details

1. Function code error
2. Device number error (out of range)
3. Device quantity error (out of range)

38.12.5 List of MC Protocol Communication Error Codes

When a wrong command is sent or an error occurs in the control unit, a different exit code is returned. The description, causes, and processing of exit codes returned in an error state are as follows.

Code	Timing of occurrence
4031	Address is too long (Starting device + Number of written points)
C051	The number of devices is outside the specified range.
C056	The starting device is outside the specified range.
C059	Command search There is no command that matches the receive data command in the MC protocol command table.

Code	Timing of occurrence
C059	The subcommand is outside the specified range.
C05B	The device code is outside the specified range.
C05C	Subcommand is in bit unit (0001) and device code indicates a word device.
C05F	Receive header content check "Network No." check
C05F	Receive header content check "PC No." check
C05F	Receive header content check "Destination unit I/O No." check
C05F	Error in the number of received and written data
C060	Error in written contact data (except 0 / 1)
C061	Receive header content check The number of receive data is smaller than the minimum received bytes that support header content check
C061	The number of receive data is smaller than the minimum number of receive bytes.

38.12.6 List of Ethernet Communication Error Codes

■ Ethernet communication errors

If the CY flag (R9009) turns ON (1: Error), check the error content in the Ethernet communication error code (DT90529).

R9009	DT90529
0: Normal	0: Normal
1: Error	1: Incorrect IP address specification
	2: Incorrect subnet mask specification
	3: Incorrect default gateway specification
	4: Incorrect IP address combination
	10: Ethernet cable disconnected
	11: Ethernet initialization in progress
	12: IP address unestablished
	13: Client not started
	14: Connection processing in progress
15: Connection occupied	

■ Network errors

If a network error (E46) occurs, check the details of network errors (DT90590) to find the error contents.

38.12 Error code

Error code	Cause
0x0001	Hardware fault
0x0002	Memory usage fault
0x0003	Bus fault
0x0004	Usage fault
0x1001	Startup initialization timeout

38.13 BIN/HEX/BCD Code Correspondence Table

38.13 BIN/HEX/BCD Code Correspondence Table

Decimal (Decimal)	Hexadecimal (Hexadecimal)	BIN Binary (Binary)		BCD Binary Coded Decimal (4-Digit) (Binary Coded Decimal)			
0	0000	00000000	00000000	0000	0000	0000	0000
1	0001	00000000	00000001	0000	0000	0000	0001
2	0002	00000000	00000010	0000	0000	0000	0010
3	0003	00000000	00000011	0000	0000	0000	0011
4	0004	00000000	00000100	0000	0000	0000	0100
5	0005	00000000	00000101	0000	0000	0000	0101
6	0006	00000000	00000110	0000	0000	0000	0110
7	0007	00000000	00000111	0000	0000	0000	0111
8	0008	00000000	00001000	0000	0000	0000	1000
9	0009	00000000	00001001	0000	0000	0000	1001
10	000A	00000000	00001010	0000	0000	0001	0000
11	000B	00000000	00001011	0000	0000	0001	0001
12	000C	00000000	00001100	0000	0000	0001	0010
13	000D	00000000	00001101	0000	0000	0001	0011
14	000E	00000000	00001110	0000	0000	0001	0100
15	000F	00000000	00001111	0000	0000	0001	0101
16	0010	00000000	00010000	0000	0000	0001	0110
17	0011	00000000	00010001	0000	0000	0001	0111
18	0012	00000000	00010010	0000	0000	0001	1000
19	0013	00000000	00010011	0000	0000	0001	1001
20	0014	00000000	00010100	0000	0000	0010	0000
21	0015	00000000	00010101	0000	0000	0010	0001
22	0016	00000000	00010110	0000	0000	0010	0010
23	0017	00000000	00010111	0000	0000	0010	0011
24	0018	00000000	00011000	0000	0000	0010	0100
25	0019	00000000	00011001	0000	0000	0010	0101
26	001A	00000000	00011010	0000	0000	0010	0110
27	001B	00000000	00011011	0000	0000	0010	0111
28	001C	00000000	00011100	0000	0000	0010	1000
29	001D	00000000	00011101	0000	0000	0010	1001
30	001E	00000000	00011110	0000	0000	0011	0000
31	001F	00000000	00011111	0000	0000	0011	0001
63	003F	00000000	00111111	0000	0000	0110	0011
255	00FF	00000000	11111111	0000	0010	0101	0101
9999	270F	00100111	00001111	1001	1001	1001	1001

38.14 ASCII Code Table, JIS8 Code Table

■ Reference ASCII code table

				b7												
				b6												
				b5												
				b4												
b7	b6	b5	b4	b3	b2	b1	b0	R	C							
0	0	0	0	0	0	0	0	0	1	2	3	4	5	6	7	
0	0	0	0	0	0	0	0	NUL	DEL	SPACE	0	@	P	`	p	
0	0	0	1	0	0	0	1	1	SOH	DC1	!	1	A	Q	a	q
0	0	1	0	0	0	1	0	2	STX	DC2	"	2	B	R	b	r
0	0	1	1	0	0	1	1	3	ETX	DC3	#	3	C	S	c	s
0	1	0	0	0	1	0	0	4	EOT	DC4	\$	4	D	T	d	t
0	1	0	1	0	1	0	1	5	ENQ	NAK	%	5	E	U	e	u
0	1	1	0	0	1	1	0	6	ACK	SYN	&	6	F	V	f	v
0	1	1	1	0	1	1	1	7	BEL	ETB	'	7	G	W	g	w
1	0	0	0	1	0	0	0	8	BS	CAN	(8	H	X	h	x
1	0	0	1	1	0	0	1	9	HT	EM)	9	I	Y	i	y
1	0	1	0	1	0	1	0	A	LF	SUB	*	:	J	Z	j	z
1	0	1	1	1	0	1	1	B	VT	ESC	+	;	K	[k	{
1	1	0	0	1	1	0	0	C	FF	FS	,	<	L	¥	l	
1	1	0	1	1	1	0	1	D	CR	GS	-	=	M]	m	}
1	1	1	0	1	1	1	0	E	SO	RS	.	>	N	^	n	~
1	1	1	1	1	1	1	1	F	SI	US	/	?	O	_	o	DEL

■ Reference JIS8 code table

								0	1	2	3	4	5	6	7	8	9	A	B	C	D	E	F	
b7	b6	b5	b4	b3	b2	b1	b0	0	1	2	3	4	5	6	7	8	9	A	B	C	D	E	F	
0	0	0	0	0	0	0	0	NUL	TC ₇ (DEL)	(SP)	0	@	P	·	p	↑	↑	Undefined	一	タ	ミ	↑	↑	
0	0	0	1	1				TC ₁ (SOH)	DC ₁	!	1	A	Q	a	q			。	ア	チ	ム			
0	0	1	0	2				TC ₂ (STX)	DC ₂	"	2	B	R	b	r				「	イ	ツ	メ		
0	0	1	1	3				TC ₃ (ETX)	DC ₃	#	3	C	S	c	s				」	ウ	テ	モ		
0	1	0	0	4				TC ₄ (EOT)	DC ₄	\$	4	D	T	d	t				、	エ	ト	ヤ		
0	1	0	1	5				TC ₅ (ENQ)	TC ₈ (NAK)	%	5	E	U	e	u				・	オ	ナ	ユ		
0	1	1	0	6				TC ₆ (ACK)	TC ₉ (SYN)	&	6	F	V	f	v			↑	ヲ	カ	ニ	ヨ		
0	1	1	1	7				BEL	ETB	'	7	G	W	g	w	Undefined	Undefined		ア	キ	ヌ	ラ	Undefined	Undefined
1	0	0	0	8				EE ₀ (BS)	CAN	(8	H	X	h	x	Undefined	Undefined		イ	ク	ネ	リ	Undefined	Undefined
1	0	0	1	9				EE ₁ (HT)	EM)	9	I	Y	i	y	Undefined	Undefined		ウ	ケ	ノ	ル	Undefined	Undefined
1	0	1	0	A				EE ₂ (LF)	SUB	*	:	J	Z	j	z				エ	コ	ハ	レ		
1	0	1	1	B				EE ₃ (VT)	ESC	+	;	K	[k					オ	サ	ヒ	ロ		
1	1	0	0	C				EE ₄ (FF)	IS ₄ (FS)	,	<	L	¥	l					ヤ	シ	フ	ワ		
1	1	0	1	D				EE ₅ (CR)	IS ₃ (GS)	-	=	M]	m					ユ	ス	ヘ	ン		
1	1	1	0	E				SO	IS ₂ (RS)	.	>	N	^	n	-				ヨ	セ	ホ	"		
1	1	1	1	F				SI	IS ₁ (US)	/	?	O	_	o	DEL	↓	↓		ッ	ソ	マ	'	↓	↓

Do not use the undefined parts of the JIS8 code table.

(MEMO)

Record of changes

The manual No. is written at the bottom of the cover page.

Date	Manual No.	Record of Changes
-	-	-
May. 2019	WUME-FP0HPGR-01	1st Edition
Aug.2020	WUME-FP0HPGR-02	2nd Edition Version upgrade of the unit firmware (Ver. 1.5) <ul style="list-style-type: none"> • Changed the MODBUS-TCP station number.
Dec.2020	WUME-FP0HPGR-03	3rd Edition Fixed errors.
Feb. 2021	WUME-FP0HPGR-05	5th Edition Version upgrade of the unit firmware (Ver. 1.7) <ul style="list-style-type: none"> • Added the F254 PRINT instruction. • Added optional settings to the positioning memory (Memory Area No. 0"Axis setting").
Jun. 2021	WUME-FP0HPGR-06	6th Edition Version upgrade of the unit firmware (Ver. 1.8) <ul style="list-style-type: none"> • Addition of specifying a partner unit for MEWTOCOL master communication • Addition of P466/F467/P468/F490/F495/F496/F497/F498/F499 instructions Changed the configuration of manual chapters
Feb. 2023	WUME-FP0HPGR-07	7th Edition Added a list of error codes set in SEND/RECV/MTRN done codes (DT90123 to DT90125, DT90840 to DT90848). Errors corrected
Mar. 2023	WUME-FP0HPGR-08	8th Edition "31 Positioning Control Instructions" <ul style="list-style-type: none"> • Changed the description on the frequency.
Apr. 2024	WUME-FP0HPGR-09	9th Edition Changed the corporate name.

(MEMO)

(MEMO)

Panasonic Industry Co., Ltd.

1006, Oaza Kadoma, Kadoma-shi, Osaka 571-8506, Japan
<https://industry.panasonic.com/>

Please visit our website for inquiries and about our sales network.

© Panasonic Industry Co., Ltd. 2019-2024
2024 年 7 月

WUMJ-FP0HPGR-091