

Static Remover Fan-type Ionizer  
**ER-F12A / ER-F12SA**

MJE-ERF12AF12SA No.0099-86V

Thank you very much for using Panasonic products. Please read this Instruction Manual carefully and thoroughly for the correct and optimum use of this product. Kindly keep this manual in a convenient place for quick reference.

**WARNING**

- Never use this product with a device for personnel protection. In case of using devices for personnel protection, use products which meet laws or standards, such as OSHA, ANSI or IEC etc., for personnel protection applicable in each region or country.
- Do not use this product in places where there may be a danger of flammable or combustible items being present.
- Clean the discharge needle regularly (about once every two weeks), otherwise optimum charge removal performance may not be obtained and fire or operating problems may occur.
- If this product is used in an airtight room, ozone emitted from this product may be detrimental. Therefore, in order for this product to be used in an airtight room, be sure to keep the room ventilated.
- Do not direct ionized air toward the face. Ozone may cause irritation to places such as the nose and throat.
- Since the tip of the discharge needle is sharp, take sufficient care in handling the discharge needle, or injuries may result.
- Be sure to ground the frame ground (F.G.) terminal, otherwise electric charge removal may not be reliable.

**1 OUTLINE**

- This product is a fan-type charge removal device which uses ion generation from corona discharges.
- The device is suitable for a variety of charge removal applications. It is equipped with a straight louver which is ideal for long-distance charge removal, and an angle louver which is ideal for wide-range charge removal.
- The fan speed can be adjusted to one of four settings.

**2 PART DESCRIPTION**

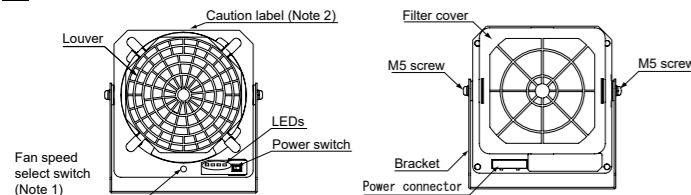

- Description of each LED
  - POWER .....Lights when the power is on. (Power indicator)
  - DSC .....Lights when discharge is occurring normally. (Discharge indicator)
  - DSC ERROR ...Lights when an abnormal discharge is detected. (Discharge error indicator)
  - FAN ERROR...Lights when a problem with fan operation is detected. (Fan error indicator)
- Notes: 1) Fan speed select switch  
At the time of shipment from the factory, the device is set to fan speed 4 (MAX). Use a flat-tipped screwdriver to adjust the fan speed.
- 2) Caution label  
Attach whichever accessory caution label is written in the appropriate language for the region of use.

**3 I/O CIRCUIT DIAGRAM**

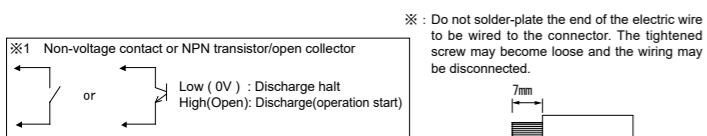
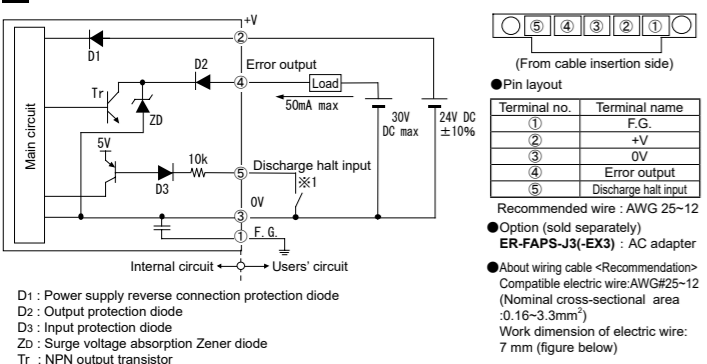

**4 MOUNTING**

- Be sure to turn off the power before carrying out angle adjustment for this product, otherwise accidents or problems with operation may occur.
- Remove the bracket from the main unit, and then secure it to the installation location.
- Use the holes in the base of the bracket to secure it with screws.
- The vertical angle of the product can be freely changed by loosening the two M5 screws. After adjusting the angle, retighten the screws to secure the device so that the angle will not change. The tightening torque for the M5 screws at this time should be 1.2 N·m or less.
- Attach the accessory rubber cushion to bracket as shown in the below diagram to suit the usage.

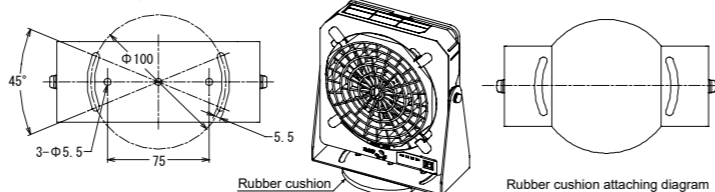

**5 OPERATION MATRIX**

	Indicators (○: Lights up, ●: Off)				Error output (normal close)	Discharge operation	Fan operation
	POWER	DSC	DSC ERROR	FAN ERROR			
Normal	○	○	●	●	ON	ON	ON
Discharge error	○	●	○	●	OFF	OFF	OFF
Fan error	○	●	●	○	OFF	OFF	OFF
Discharge halt input	○	●	●	●	ON	OFF	ON
Insufficient discharge	○	Blink	●	●	OFF	ON	ON

※ : Once an error is detected, the error status will be maintained until the power is turned off and back on again. Remove the cause of the error and then turn the power back on. If the cause of the error is not removed, the error status will continue.  
※ : Discharge halt input is disabled when an error status is active.  
※ : Please clean the discharge needles or replace the discharge needle unit when DSC indicator shining.

**6 LOUVER SELECTION**

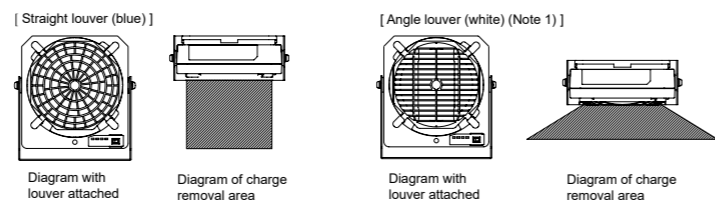

This product includes two types of louver as accessories. Select the type of louver to use based on the charge removal area.

- Straight louver**  
This louver provides excellent direction stability for the air. It is ideal for cases where rapid charge removal for objects is required, or when the object is some distance away.
  - Angle louver**  
This louver is excellent at dispersing the air. It is ideal for charge removal over a wide area.
- Notes: 1) The discharge needle unit is loaded on the straight louver before shipment. To replace it with the angle louver, refer to the discharge needle unit installation procedure in "7 CARE AND MAINTENANCE" in this manual.  
2) If no louver is attached, the device will not turn on even when the power is supplied.

**7 CARE AND MAINTENANCE**

- Be sure to turn off the power before carrying out cleaning and maintenance.
- The discharge needle has a sharp point, so be very careful when cleaning the needle.
- If the device is used for a long period, dust and other foreign particles may accumulate on the discharge needles or on the fan filter, and so the needles and filter should be cleaned before use.
- If the device is not cleaned regularly, the charge removal performance will drop and operating problems or accidents may occur. Clean the device regularly, using the following as a guide.  
Discharge needle unit: Every 2 weeks  
Fan intake filter: Every 2 weeks
- The discharge needle is a consumable part. If the discharging performance is not restored after the discharge needles have been cleaned, it is recommended that you replace the discharge needle unit. It is recommended that you replace the discharge needle unit after about 10,000 hours of operation.

**Cleaning the discharge needle unit**

- Check that the power is turned off and that the fan has completely stopped.
- Following the removal procedure of the louver, remove the louver from the main unit.
- Clean with the discharge needle loaded. Use a cotton swab or similar tools moistened with alcohol to clean the discharge needles and the areas around them. If the needles are particularly dirty, use a brush (such as a toothbrush) moistened with alcohol to rub them clean, and then use a cotton swab to wipe them.  
<When using a commercially-available ultrasonic cleaner for cleaning>  
Following the removal procedure of the discharge needle unit, remove the discharge needle unit from the louver, and immerse the discharge needle unit into the cleaning tank to clean them. After that, dry the discharge needle unit well. Following the installation procedure, install the discharge needle unit to the louver.
- Following the installation procedure, install the louver to the main unit.

[Louver removal/installation procedure]

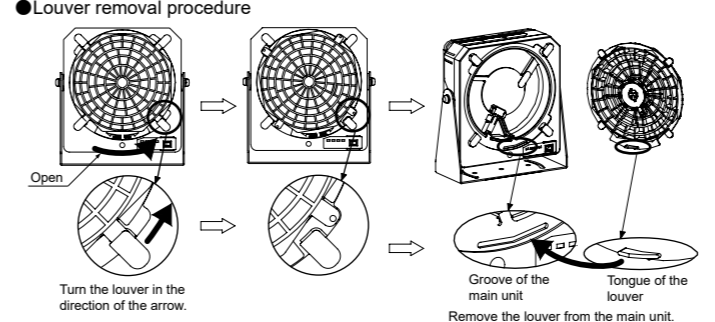

- Louver removal procedure**
  - Louver installation procedure**  
When installing the louver to the main unit, align and insert the tongue of the louver into the groove of the main unit. After inserting the tongue into the groove, turn the louver clockwise to install.
- ※ : Do not touch inside the device when removing and installing the louver, otherwise accidents or problems with operation may occur.

[Discharge needle unit removal/installation procedure]

When using an ultrasonic cleaner for cleaning, remove the discharge needle unit.

- Discharge needle unit removal procedure**  
Hold the louver and turn the discharge needle unit counterclockwise. (Note: 2)
- Discharge needle unit installation procedure**  
As shown in the figure above, install the louver and the discharge needle unit so that the claw of the louver is inserted into the hole of the discharge needle unit. (Note: 3) Turn the discharge needle unit clockwise until it stops to install.

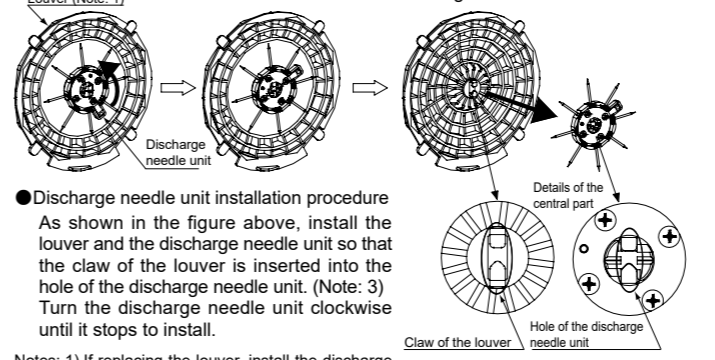

- Notes: 1) If replacing the louver, install the discharge needle unit to the replacement louver.  
2) When turning the discharge needle unit, do not apply any more force than is necessary, otherwise the louver or the discharge needle unit may become damaged.  
3) Confirm the side of the discharge needle unit to install. If installed on the wrong side, the discharge needle unit or the louver may become damaged.

- Option (sold separately)  
**ER-F12ANT** : Discharge needle unit x 1

**Cleaning and replacement procedure for fan filter**

- Install a filter in accordance with the operating environment.
- Remove the filter cover. Disengage the clasps in the places indicated by ☆ in the illustration below, and then pull the filter cover in the direction of the arrow to remove it. (Refer to the illustration below.)
  - Clean away any dust and dirt adhering to the filter. If the filter is particularly dirty, wash it in water. If washing the filter in water, let it dry thoroughly before reusing it.
  - Install the filter. Install the filter cover.
- ※ : If the device is used while the filter is still wet, accidents or problems with operation may occur.  
※ : If the filter will not come clean, it should be replaced.  
※ : Be careful not to let anything get inside the device while the filter is removed.

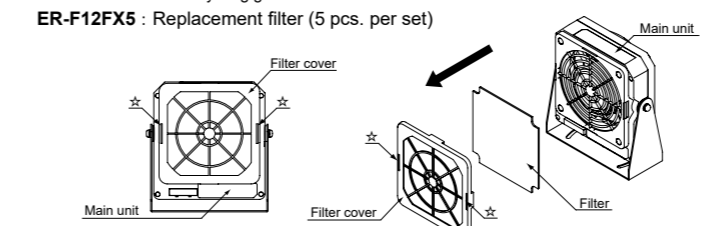

**8 TROUBLESHOOTING**

- Be sure to turn off the power before checking the discharge unit or the fan unit.

Problem	Main cause	Remedy
Discharge error indicator (DSC ERROR) lights up.	Condensation Foreign objects F.G. not connected	• An abnormal discharge is probably occurring. Turn off the power and check that the tip of the discharge needle is intact and free from foreign objects, and also check that the discharge needle unit is correctly installed to the louver. • If the error indicator remains lit even after the discharge needle has been cleaned, check if the area around the needle is dirty. • Check that the F.G. terminal is securely grounded.
Fan error indicator (FAN ERROR) lights up.	Fan is covered Fan is blocked Foreign objects	• Turn off the power and check that the filter is not dirty or blocked. • Check that there are no foreign objects inside the product.
DSC indicator Blinks	Discharge needles are dirty Lack of discharge needle unit	• Clean the discharge needles. • Replace the discharge needle unit.

**9 SPECIFICATIONS**

Item	Type	Standard fan type	Low-volume fan type
Charge removal time	Model No.	<b>ER-F12A</b>	<b>ER-F12SA</b>
Ion balance		±10 V or less (Note 2)	±10 V or less (Note 2)
Power supply voltage		24 V DC ±10%	24 V DC ±10%
Power consumption		700 mA or less	400 mA or less
Discharge method		High-frequency AC method	High-frequency AC method
Discharge output voltage		±2 kV approx.	±2 kV approx.
Max. fan speed		5.3 m/s (Note 2)	4.0 m/s (Note 2)
Max. fan volume		3.68 m <sup>3</sup> /min	2.50 m <sup>3</sup> /min
Error output		NPN transistor/open collector • Max. sink current: 50 mA • Applied voltage: 30 V DC or less (between output terminal and 0 V) • Residual voltage: 1 V or less (at input current of 50 mA)	
Output operation		OFF when discharge error or fan error or insufficient discharge detected ON when normal or discharge halt input	
Short-circuit protection		Incorporated	
Discharge halt output		Discharge halt: Short-circuited to 0 V Discharge (operation start): Open	
Indicators	POWER	Green LED (Lights up when power on)	
	DSC	Green LED (Lights up during normal discharge. Lights Blink during insufficient discharge.)	
	DSC ERROR	Red LED (Lights up when discharge error detected)	
	FAN ERROR	Red LED (Lights up when fan error detected)	
Ozone generation amount		0.04 ppm or less (Note 1)	
Pollution level		2	
Ambient temperature		0°C to +50°C (No dew condensation) / Storage : -10°C to +65°C	
Ambient humidity		35% to 65% RH (No dew condensation) / Storage : 35% to 65% RH	
Operating altitude		2,000m or less (Note 4)	
Vibration resistance		10Hz to 55Hz frequency, 0.75 mm amplitude in X, Y and Z directions for two hours each	
Over-voltage category		I	
Material		Enclosure: ABS Louver: ABS Discharge needle: Tungsten Discharge needle unit: PBT Bracket: SPHC	
Grounding method		C (capacitor) grounding	
Weight		790g approx. (main unit only)	
Accessories		•Louvers Straight louver: 1 (Note 3 ) Angle louver: 1 •Caution label: 1 set •Rubber cushion: 1	

Notes: 1) Typical value at 200 mm from directly in front of discharge outlet, fan speed MAX, straight louver, with no filter installed.  
2) Typical value at 300 mm from directly in front of discharge outlet, fan speed MAX, straight louver, with no filter installed.  
3) The discharge needle unit is loaded on the straight louver before shipment.  
4) Do not use or store the device in an environment where the air pressure is higher than the atmospheric pressure at an altitude of 0 meters.

**10 CAUTIONS**

- This product has been developed / produced for industrial use only.
- Do not use this product for any purpose other than charge removal and dust removal.
- Do not use this product in environments which are outside the specification range, otherwise operating problems or damage may occur. In addition, the operating life of the product may become significantly reduced.
- Never disassemble, repair or modify this product, otherwise operating problems or accidents may occur.
- Do not dispose of this product by burning it, otherwise it may explode or toxic fumes may be generated.
- This product generates ozone, so be sure to provide adequate ventilation if using it in a confined space.
- Do not run the wires together with high-voltage lines or power lines or put them in the same raceway. This can cause malfunction due to induction.
- Be sure to turn off the air and the power supply before carrying out any cable connection or inspection work. If this is not done, operating problems, damage or electric shocks may occur.
- After connecting the cables, check that the connections are correct before turning on the power. If the cables are connected incorrectly, operating problems or accidents may occur.
- Verify that the supply voltage variation is within the rating.
- It takes approximately 5 seconds after the power is turned on before the fan operation stabilizes. To ensure proper charge removal performance, do not use the product until sufficient time has elapsed.
- Do not turn the power back on immediately after it has been turned off, otherwise operating problems or accidents may occur. In addition, the operating life of the product may become significantly reduced. Wait at least 2 seconds before turning the power back on again.
- Do not use any cables which have any damage (such as splitting or cracking), otherwise operating problems or accidents may occur.
- Avoid using the product in places where there are high levels of steam or dust in the air or where it might be directly exposed to water, oil or welding spatter.
- Avoid storing the product in a place with high temperature and high humidity or in a corrosive gas environment. Do not store the product in unused condition for more than 6 months.
- Avoid use at an elevation higher than 2000m, and outdoor use.
- Do not touch the discharge needle with hard objects such as tools. If the discharge needle becomes broken, it will not provide sufficient charge removal performance, and moreover operating problems or accidents may occur.
- Do not use this product while the filter is blocked, otherwise accidents or problems with operation may occur.
- Clean or replace the filter at regular intervals.
- Be sure to turn off the power before replacing the filter.
- Install the product so that it is at least 100 mm away from the objects being charged.
- When installing this product, be sure to securely install the main unit and the bracket. If they are not securely installed or if constant vibration or shocks are applied, accidents or problems with operation may occur.
- Do not place any objects which may obstruct air flow within 20 mm from the front of the fan air intake, otherwise accidents or problems with operation may occur.
- Use cables that are 0.15 mm<sup>2</sup> or more and 30 m or less in length for wiring.
- Also, keep the wiring as short as possible in order to prevent noise.
- If this product ceases functioning or is no longer required, dispose of it according to appropriate local waste disposal regulations.

