

Thank you very much for purchasing Panasonic products. Read this Instruction Manual carefully and thoroughly for the correct and optimum use of this product. Kindly keep this manual in a convenient place for quick reference.

WARNING

- Never use this product as a sensing device for personnel protection.
- In case of using sensing devices for personnel protection, use products which meet laws and standards, such as OSHA, ANSI or IEC etc., for personnel protection applicable in each region or country.
- This product is used for noncorrosive gas. The product shall not be used for liquid or corrosive gas. Never use fluids having inflammability, toxicity, etc., that affect the human body, either.
- This product is a product intended for use in Japan conforming to the Japanese Measurement Act.

1 PART DESCRIPTION

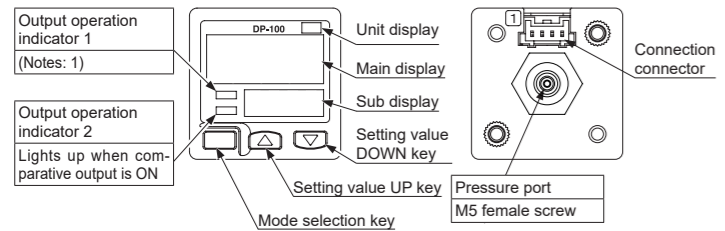

Notes: 1)

Function	During IO-Link non communication	During IO-Link communication
Output operation indicator 1	Lights up when comparative output is ON (Notes 2)	Flashes

Notes: 2) Synchronized with output operation indicator 2

2 PIPING

- To connect a commercial coupler to the pressure port, manually hold the main unit of the product and install the coupler by tightening it to a tightening torque of 1N·m or less. The commercial coupler or pressure port section will be damaged if the tightening torque is excessive. Wrap sealing tape around the coupler when connecting to prevent leaks.

3 MOUNTING

- The sensor mounting bracket **MS-DP1-1** is available as an option. When mounting the sensor onto the sensor mounting bracket, etc., the tightening torque should be 0.5 N·m or less.

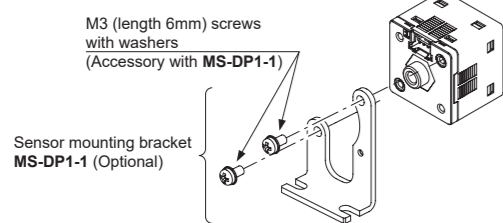

- The panel mounting bracket **MS-DP1-2** (optional) and **MS-DP1-4** (optional), as well as the front cover **MS-DP1-3** (optional) and **DPX-04** (optional) are also available.
- The type of the front cover is different depending on the applied mounting bracket. Use **MS-DP1-3** for **MS-DP1-2**, and **DPX-04** for **MS-DP1-4**.
- For mounting of the panel mounting bracket, refer to the Instruction Manual enclosed with **MS-DP1-2** or **MS-DP1-4**.

4 WIRING

Connection method

- Insert the cable with connector (included in this product) into the connection connector section of this product as shown in the figure to the right.

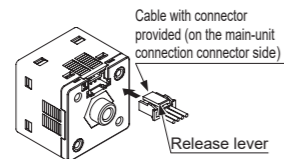

Disconnection method

- Pressing the release lever of the cable with connector, pull out the connector.

Note: Do not pull by holding the cable without pressing the release lever, as this can cause cable break or connector break.

<Connection connector pin arrangement>

Connector pin No.	Wiring color/ M12 connector Terminal No.	Terminal name
1	Brown / 1	+V
2	Black / 4	IO-Link communication (C/Q)
3	White / 2	Control output (DO)
4	Blue / 3	0 V

5 CONNECTION

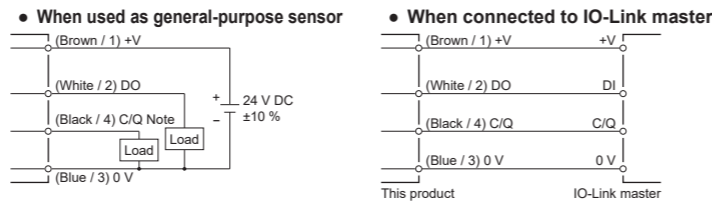

<Terminal arrangement of M12 connector type>

Terminal No.	Terminal name
1	+V
2	Control output (DO)
3	0 V
4	IO-Link communication (C/Q) Note

Note: When the product is used as a general-purpose sensor, the IO-Link communication (C/Q) is generated in the same way as control output (DO)

How to mount M12 connector

If the fixed ring loosens, the connector will come off, causing this product to generate a communication error. Before use, be sure to check that the fixed ring is not loose.

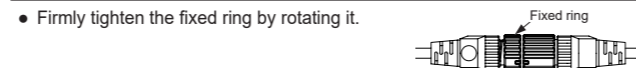

6 LIST OF FUNCTIONS

Function	Setting on main unit	IO-Link communication setting (Note)
Comparative output mode setting	Select from EASY mode / Hysteresis mode / Window comparator mode	Index61_2
Threshold value setting	EASY mode: Threshold value Hysteresis mode / Window comparator mode: Lo side	Index60_1
Zero-adjust setting	Hysteresis mode / Window comparator mode: Hi side	Index60_2
Key lock	Execute / Cancel	Index2
Peak / bottom hold function	Set / release	Index12
Comparative output mode setting	Setting	Index82_4
Response time setting	N.O. / N.C.	Index61_1
Displayed color of the main display selection	Select from 10 steps	Index66
Pressure unit selection	Select from 4 modes	Index82_1
Display setting of Sub-display selection	Select from 2 modes DP-101□ is fixed	Index83
Display speed selection	Select from 5 modes	Index82_2
Hysteresis fixed value selection	No. display setting (Set within a range of 01 to 99.)	Index84_1
Eco mode setting	Custom display setting	Index84_2
Setting check code	Select from 3 steps	Index82_3
Reset setting	Select from 8 steps	Index61_3
Remote zero-adjust setting	Execute	Index80
Zero-adjust execution notification	8 digit indication	-
Auto-reference setting	Execute	Index2
Operating time	-	Index2 (Notes: 2)
Number of data save operations	-	Index85
Notification Flag Setting	-	Index2 (Notes: 2)
Notification Event Code	-	Index163
	-	Index164
	-	Index168
	-	Index169

Notes: 1) For the IO-Link communication setting, refer to the attached sheet, "Index List." (IMJE-DPLINDEX)
 2) Do not configure the remote zero-adjustment setting and auto-reference setting simultaneously.
 3) Do not configure the main unit settings and IO-Link communication setting simultaneously.

7 OUTPUT MODE AND OUTPUT OPERATION

- The EASY mode, hysteresis mode or window comparator mode can be selected as the output mode for comparative output. Refer to "9 MENU SETTING MODE" for details.

EASY mode

- ON / OFF of the comparative output is controlled in this mode.

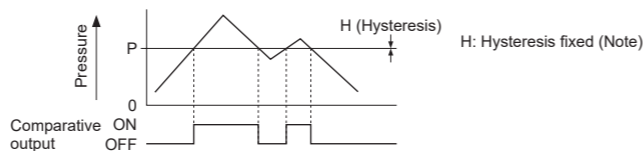

Notes: Hysteresis can be fixed in 8 steps. Refer to "<Hysteresis fixed value selection>" in "9 PRO MODE" for setting.

Hysteresis mode

- This mode controls ON / OFF by arbitrarily setting the hysteresis of the comparative output.

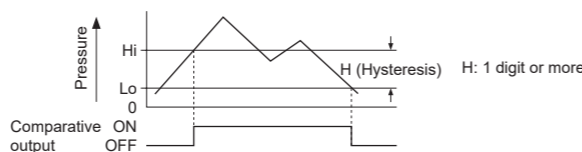

Note: "Hi - l" or "Lo - l" is displayed on the sub-display.

Window comparator mode

- In this mode, the ON or OFF state of the comparative output is controlled with a pressure in the set range.

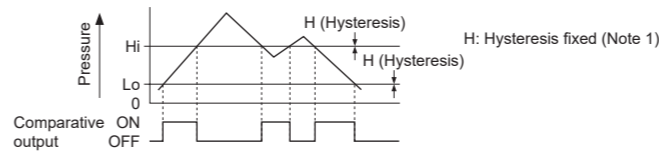

Notes: 1) Hysteresis can be fixed in 8 steps. Refer to "<Hysteresis fixed value selection>" in "9 PRO MODE" for setting.
 2) "Hi - l" or "Lo - l" is displayed on the sub-display.
 3) Set the interval between the Lo side and Hi side to hysteresis fixed value or more.

8 RUN MODE

Setting the threshold value

- Refer to "<Comparative output mode setting>" in "9 MENU SETTING MODE" for setting conditions.
- The Sub display conducts the threshold value. Main display does not changed.

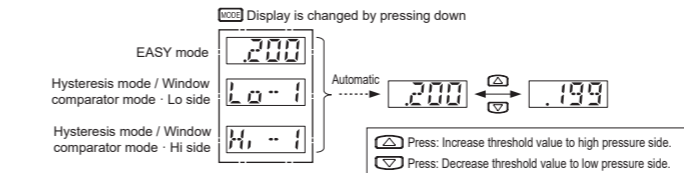

Note 1) If the set pressure range is exceeded, "UP" (exceeds the upper limit) or "DOWN" (exceeds the lower limit) will appear on the sub display. "UP/DOWN" will also appear if the Hi side threshold value exceeds the Lo side threshold value when setting the "hysteresis mode / window comparator mode" threshold value.

Zero-adjustment function

- The zero-adjustment function forcibly sets the pressure value to "zero" when the pressure port is opened.



Key lock function

- The key lock function prevents key operations so that the conditions set in each setting mode are not inadvertently changed.

<Key lock set>

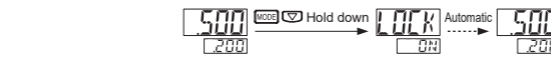

<Key lock released>

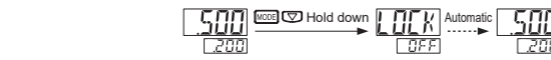

Peak / bottom hold function

- The peak / bottom hold function display the peak value and bottom value of the fluctuating pressure.
- The peak value is displayed on the main display and the bottom value is displayed on the sub-display.
- The higher pressure side indicates the peak value, while the lower pressure side indicates the bottom value.

<Peak / bottom hold set>



<Peak / bottom hold released>



9 MENU SETTING MODE

- The mode will change to RUN mode when the mode selection key is held down during this setting process. In doing so, changed items before holding down the mode selection key have been set.

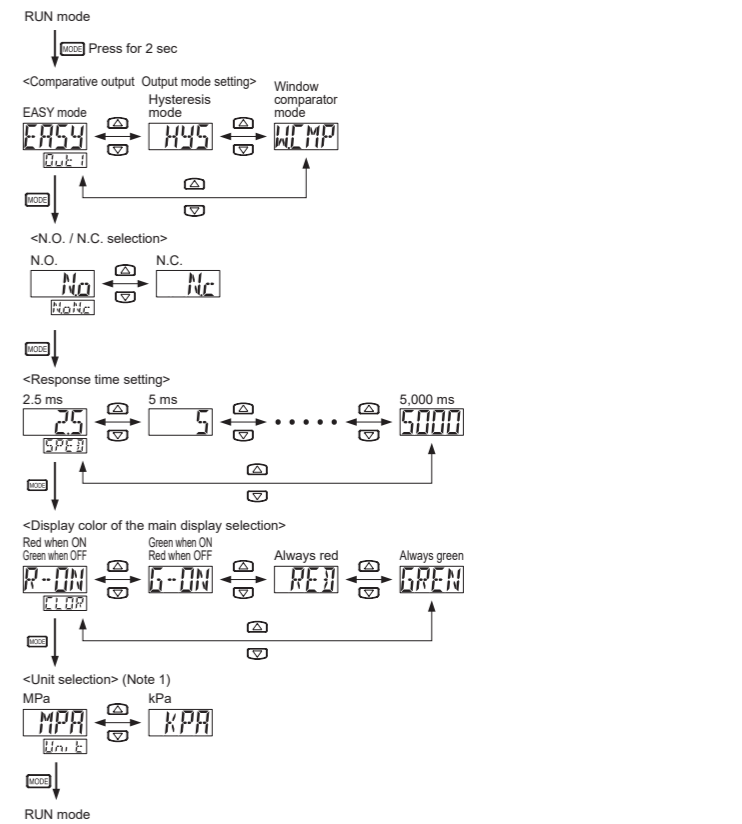

Setting item (Note 2) (Note 3)	Factory setting	Description
Comparative output Output mode setting	EASY	Sets the output operation of comparative output
N.O. / N.C. selection	Low pressure type: NC High pressure type: NO	Normal open (N.O.) or normal close (N.C.) can be selected.
Response time setting	25	Sets the response time. The response time can be selected from 2.5 ms, 5 ms, 10 ms, 25 ms, 50 ms, 100 ms, 250 ms, 500 ms, 1,000 ms or 5,000 ms
Displayed color of the main display selection	R-ON	Displayed color of the main indicator can be changed.
Pressure unit selection (Note 1)	Low pressure type: kPa High pressure type: MPa	Pressure unit can be changed. (High pressure type only)

Notes: 1) For the low pressure type, the setting item is not displayed.
 2) Settings can be configured via IO-Link communication.
 3) If settings are configured simultaneously with this operating procedure and via IO-Link communication, the settings that are applied last will be enabled.

10 PRO MODE

- The mode will change to RUN mode when the mode selection key is held down during this setting process. However, changed its ms before holding down the mode selection key have been set.

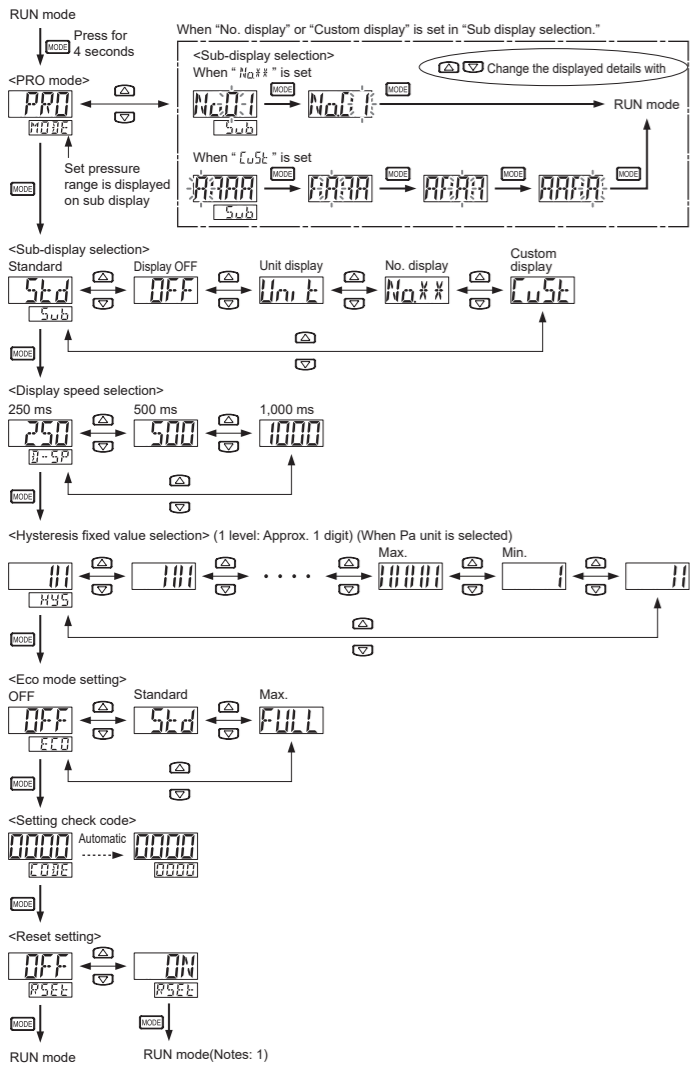

Setting item (Notes: 2) (Notes: 3)	Factory setting	Description
Sub-display selection		Changes the indication of the sub-display. "Std" : Displays threshold. "OFF" : Displays nothing. "Unit" : Presently selected pressure unit is displayed. "No. X X" : Desired No. can be shown. "Cust" : Desired numbers, alphabets (some of them cannot be displayed) and signs can be shown.
Display speed selection		Changes the speed of the displayed pressure value on the main display.
Hysteresis fixed value selection		Sets hysteresis of the EASY mode and the window comparator mode. (8 steps)
Eco mode setting		Current consumption can be lowered. "OFF" : Normal operation (ECO mode is off.) "Std" : If any key operation is not carried out for approx. 5 sec. in RUN mode, the display becomes dark. "FULL" : If any key operation is not carried out for approx. 5 sec. in RUN mode, the display is turned off. Press any key to temporarily show the normal indication.
Setting check code	Low pressure type High pressure type 	Current setting contents can be checked. For codes. Refer to "Code table".
Reset setting		Returns to default settings (factory settings). By pressing down mode key when "ON" mode, becomes default settings (factory settings).

- Notes: 1) The mode is reset to RUN mode with all settings restored to default settings (factory settings).
 2) Settings can be configured via IO-Link communication.
 3) If settings are configured simultaneously with this operating procedure and via IO-Link communication, the settings that are applied last will be enabled.

Code table

• Main display (1st digit from left)

Code	1st digit	2nd digit	3rd digit	4th digit
	Comparative output output mode	N.O. / N.C. selection	Threshold display	Displayed color of the main display
0	EASY	N.O.	EASY mode : Threshold value, Hysteresis mode / Window comparator mode : Lo side	Red when ON and Green when OFF
1	Hysteresis	N.C.	Hysteresis mode / Window comparator mode : Hi side	Green when ON and Red when OFF
2	Window comparator	—	—	Always red
3	—	—	—	Always green
4	—	—	—	—
5	—	—	—	—
6	—	—	—	—
7	—	—	—	—

• Sub-display (5th digit from left)

Code	5th digit	6th digit	7th digit	8th digit
	Response time	Unit selection	Display speed	Eco mode
0	2.5 ms	MPa	250 ms	OFF
1	5 ms	kPa	500 ms	Std
2	10 ms	—	1,000 ms	Full
3	25 ms	—	—	—
4	50 ms	—	—	—
5	100 ms	—	—	—
6	250 ms	—	—	—
7	500 ms	—	—	—
8	1,000 ms	—	—	—
9	5,000 ms	—	—	—

11 ERROR INDICATION

Error message	Cause	Corrective action
	The load is short-circuited causing an over current to flow.	Turn the power OFF and check the load.
	When the zero-adjustment function is implemented, pressure is applied.	Reset the voltage applied to the pressure port to the atmospheric pressure and implement the zero-adjustment function again.
	External input is carried out outside the rated pressure range.	Applied pressure range should be brought within the rated pressure range.
	The applied pressure exceeds the upper limit of the display pressure range.	Applied pressure range should be brought within the rated pressure range.
	The applied pressure exceeds the lower limit of the display pressure range.	

When other error message is displayed, contact us.

12 SPECIFICATIONS

• Model

DP-10 [1][2][3]-[4]-[5]-[6]

[1] : 1: Low-pressure type, 2: High-pressure type

[2] : Z: For inside of Japan

[3] : L3: IO-Link communication type (Baud rate: COM3)

[4] : M: M5 female screw

[5] : P: PNP output type

[6] : None: Discrete wire type, C: M12 connector type

Item	Type	Discrete wire type		M12 connector type	
		Low-pressure type	High-pressure type	Low-pressure type	High-pressure type
Pressure type		Gauge pressure			
Rated pressure range		-100 kPa to +100 kPa	-0.1 MPa to +1.0 MPa	-100 kPa to +100 kPa	-0.1 MPa to +1.0 MPa
Set pressure range		-101.0 kPa to +101.0 kPa	-0.101 MPa to +1.010 MPa	-101.0 kPa to +101.0 kPa	-0.101 MPa to +1.010 MPa
Withstand pressure		500 kPa	1.5 MPa	500 kPa	1.5 MPa
Applicable fluid		Non-corrosive gas			
Supply voltage		12 V DC to 24 V DC $\pm 10\%$			
Power consumption		Normal operation: 720 mW or less (current consumption 30 mA or less at 24 V supply voltage) ECO mode (STD): 480 mW or less (current consumption 20 mA or less at 24 V supply voltage) ECO mode (FULL): 360 mW or less (current consumption 15 mA or less at 24 V supply voltage)			
IO-Link communication (C/Q) (Notes: 1)		IO-Link specification: Ver1.1			
Baud rate		COM3 (230.4 kbps)			
Process data length		PD : 4 byte			
Control output (DO) (Notes: 2)		PNP open-collector transistor • Maximum source current: 50 mA • Applied voltage: 30 V DC or less (between comparative output and +V) • Residual voltage: 2 V or less (at 50 mA source current.) (Notes: 3)			
Output operation		Selectable either N.O. or N.C., with key operation			
Short-circuit protection		Incorporated			
Hysteresis fixed values		Selectable from 8 different levels (Approx. 1 to 8 digit) (Notes: 4)			
Repeatability		$\pm 0.1\%$ F.S. \pm within 2 digits	$\pm 0.2\%$ F.S. \pm within 2 digits	$\pm 0.1\%$ F.S. \pm within 2 digits	$\pm 0.2\%$ F.S. \pm within 2 digits
Response time		2.5 ms, 5 ms, 10 ms, 25 ms, 50 ms, 100 ms, 250 ms, 500 ms, 1,000 ms or 5,000 ms selectable with key operations			
Over voltage category		1			
Pollution degree		2			
Operating altitude		2,000 m or less (Notes: 5)			
Ambient temperature		-10 °C to +50 °C (No dew condensation or icing allowed), Storage: -10 °C to +60 °C			
Ambient humidity		35 to 85 % RH, Storage: 35 to 85 % RH			
Temperature characteristics		Within $\pm 0.5\%$ F.S. (at +20 °C reference)	Within $\pm 1\%$ F.S. (at +20 °C reference)	Within $\pm 0.5\%$ F.S. (at +20 °C reference)	Within $\pm 1\%$ F.S. (at +20 °C reference)
Material		Enclosure: PBT (with glass fiber), LCD display: Acrylic, Pressure port: Stainless steel (SUS 303) Mounting screw section: Brass (nickel-plated), O-ring: H-NBR, Key part: Silicon rubber			
Weight		Approx. 30 g (Main body only)			
Accessories		Cable with a connector, 2 m long (Discrete wire type): 1 pc. (Notes: 6)		Cable with a connector, 0.3 m long (M12 connector type): 1 pc. (Notes: 6)	

- Notes: 1) For the IO-Link communication setting, refer to the attached sheet, "Index List." (IMJE-DPLINDEX)
 2) When the product is used as a general-purpose sensor, the IO-Link communication (C/Q) is generated in the same way as control output (DO).
 3) This value is applicable when the cable length is 2m.
 4) It becomes a fixed value (Approx 1 digit) when using Hysteresis mode.
 5) Do not use or store in an environment pressurized to atmospheric pressure or higher at an altitude of 0m.
 6) One end of the cable with connector is provided with a connector for connection to the main unit.

13 CAUTIONS

- This product has been developed / produced for industrial use only.
- This product is suitable for indoor use only.
- Use within the rated pressure range.
- Do not apply pressure exceeding the pressure withstand ability value. The diaphragm will get damaged and correct operation shall not be maintained.
- Make sure that the power supply is off while wiring.
- Take care that wrong wiring will damage the sensor.
- Verify that the supply voltage variation is within the rating.
- If power is supplied from a commercial switching regulator, ensure that the frame ground (F.G.) terminal of the power supply is connected to an actual ground.
- In case noise generating equipment (switching regulator, inverter motor, etc.) is used in the vicinity of this sensor, connect the frame ground (F.G.) terminal of the equipment to an actual ground.
- Do not use during the initial transient time after the power supply is switched on.
- Extension up to total 20 m or less, is possible with more than 0.3 mm² of electric conductor cross-sectional area cable.
- Do not run the wires together with high-voltage lines or power lines or put them in the same raceway. This can cause malfunction due to induction.
- The specification may not be satisfied in a strong magnetic field.
- Avoid dust, dirt, and steam.
- Take care that the sensor does not come in direct contact with water, oil, grease, or organic solvents, such as, thinner, etc.
- Do not insert wires, etc, into the pressure port. The diaphragm will get damaged and correct operation shall not be maintained.
- Do not operate the keys with pointed or sharp objects.
- Make sure that stress by forcible bend or pulling is not applied directly to the sensor cable joint.
- Do not drop the product or otherwise subject to strong shock. Otherwise, the product may be damaged.
- Do not apply an excessive load to the front surface or corners of the product. Otherwise, the product may be damaged.

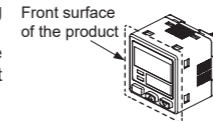

Panasonic Industry Co., Ltd.

1006, Oaza Kadoma, Kadoma-shi, Osaka 571-8506, Japan
<https://industry.panasonic.com/>

Please visit our website for inquiries and about our sales network.

Panasonic Industry Co., Ltd. 2024

April, 2024

PRINTED IN JAPAN