

# Panasonic

NEW

One-Touch Connection System Compatible with 4CH / 1CH Flange  
Vacuum-resistant Fibers

Breakthrough in vacuum-resistant fibers

# One-Touch Connection Just in **1** Second\*

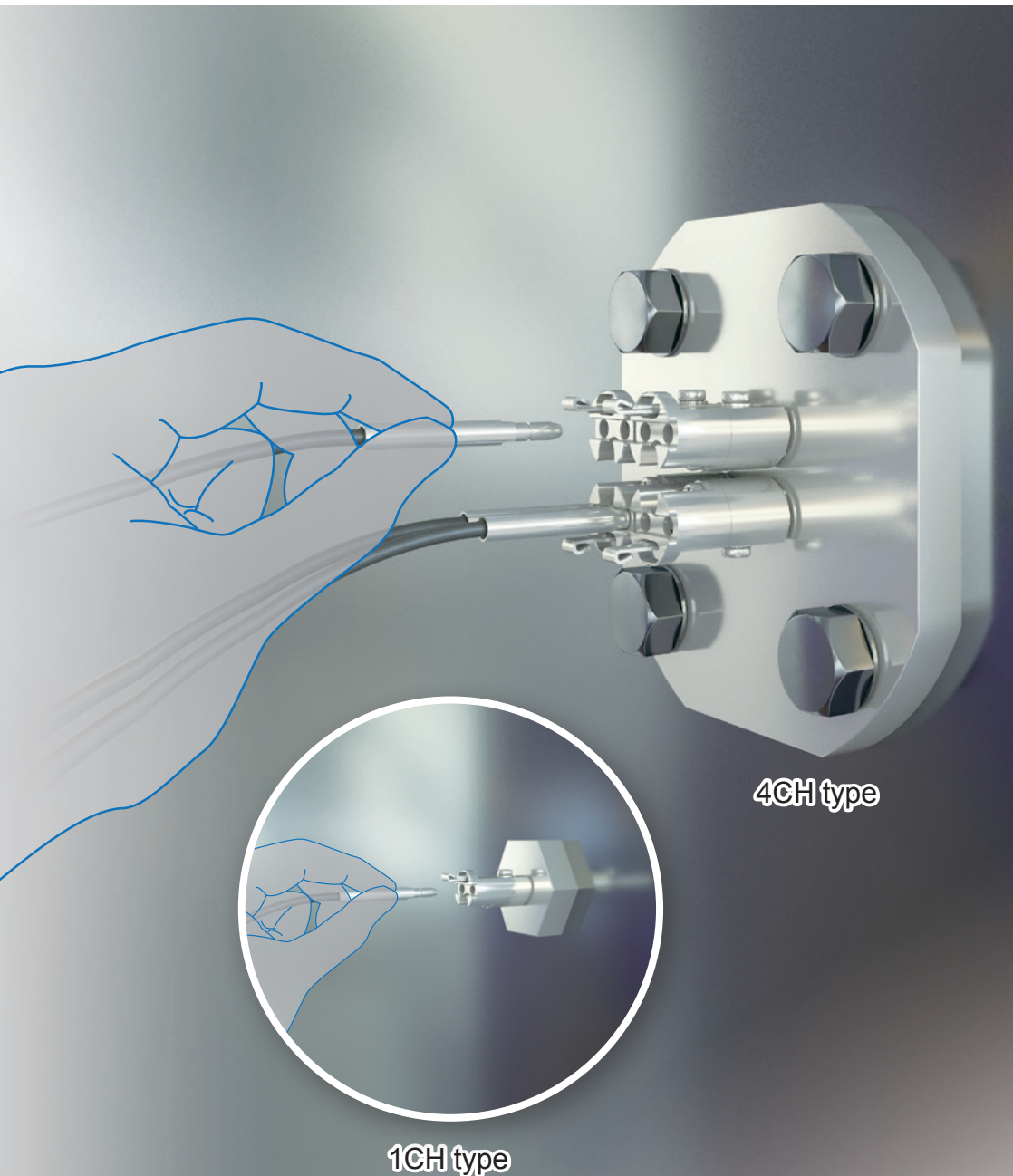

\* Time required to connect one fiber to the flange.

Easier and simpler

# Amazingly easy to connect!

Vacuum-resistant fiber flange designed to enable easy connection (one-touch connection) and disconnection of fibers one by one or at the same time.

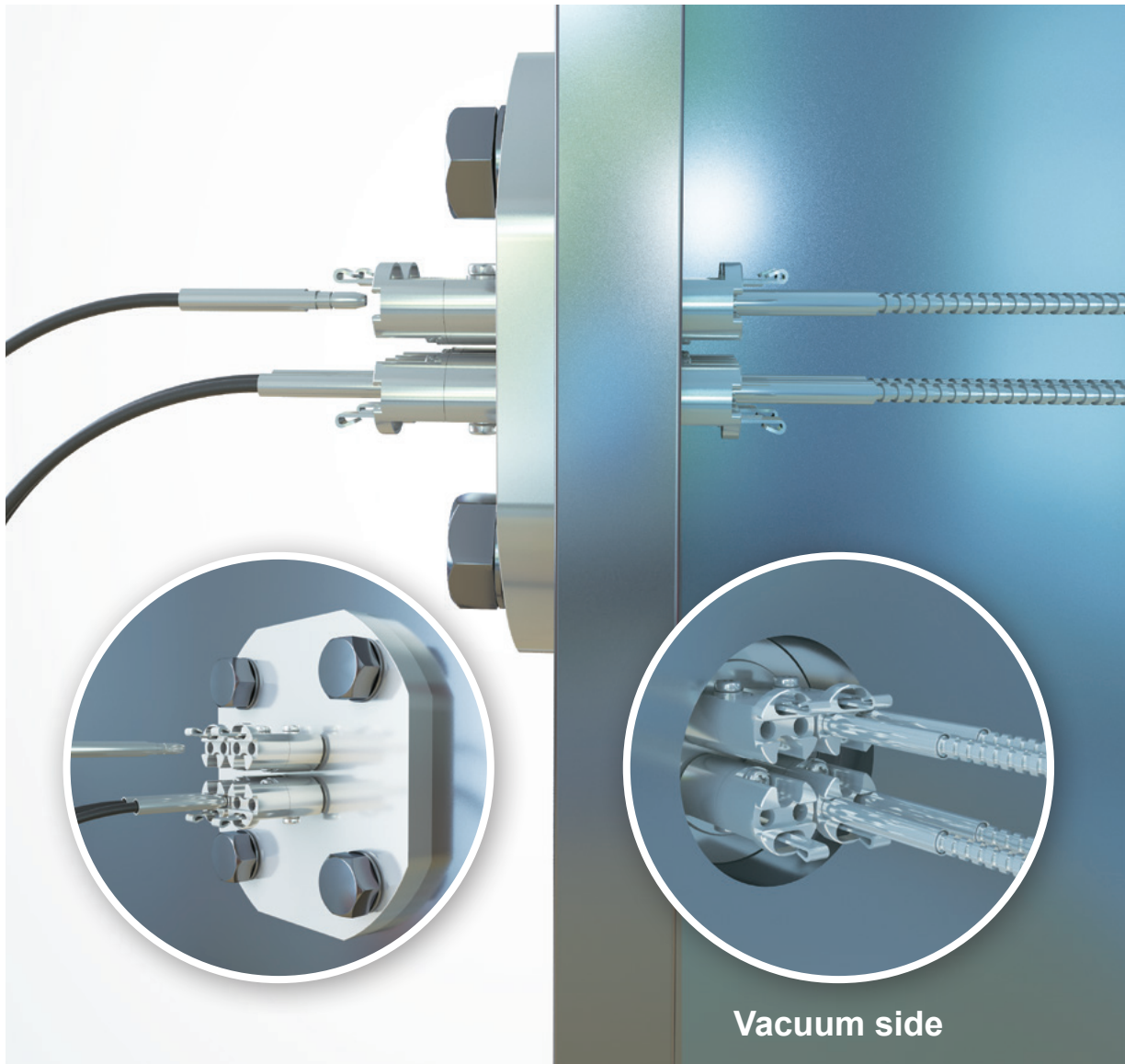

## Leakage seal construction

The leakage seal construction has built-in glass wires inside the flange and allows transmission of only light to the vacuum side. Leakage remains unchanged even when fiber is not connected.

\* Leakage from 4CH / 1CH flange:  $1.0 \times 10^{-10}$  Pa·m<sup>3</sup>/s [He] or less

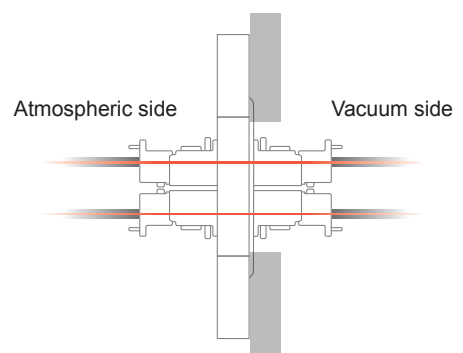

# One-touch connection just in 1 second

## Simply insert the fiber into the flange

The newly developed one-touch connection system allows easy connection of a fiber by simply positioning the fiber in the specified direction and inserting. The fiber can be disconnected by pulling the holding bracket up. The one-touch connection system helps reduce working hours dramatically.

**Before**

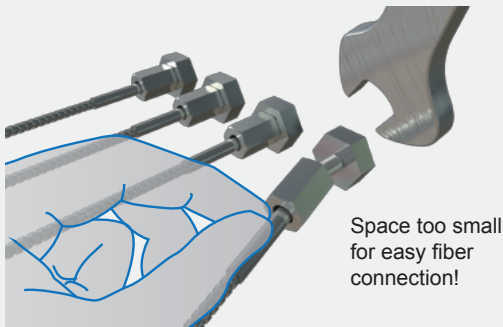

Space too small for easy fiber connection!

**Thread fastening type**

- It is difficult to tighten with a glove-covered hand.
- Small parts can be easily lost.
- Excessive tightening can break or bend the wire.

**After**

No tool required!

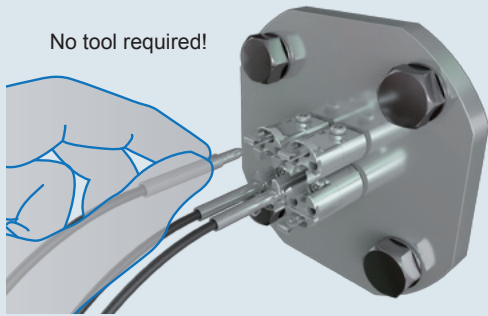

**One-touch type**

- One-touch connection system reduces working hours and workload dramatically.
- Connection is as easy as inserting the fiber into the flange.
- Easy connection without a tool or torque management.

\* The disconnection prevention structure uses a holding bracket that engages securely with the joint bracket.

# Vacuum-resistant 4CH / 1CH flange

## Requires drilling of only one hole

The flange connection system requires less space for the fiber lead-in section and fewer holes to drill. Previously, one installation hole had to be drilled for each fiber. The vacuum-resistant flange requires only one hole even for multiple fibers, thus reducing the hole drilling cost and the possibility of leakage.

**Before**



A hole must be drilled for each fiber.

**Conventional fiber lead-in section**

- A hole must be drilled for each fiber at the lead-in section.
- An ample space is needed for inserting a hand and using a tool.

**After**



Only one hole is required for 8 fibers.

**Fiber lead-in section of the vacuum-resistant flange**

- Only one hole needs to be drilled even for the connection of eight fibers. This reduces the processing cost and the worries for leakage to 1/8.
- Saves space at the lead-in section because fibers can be grouped and connected.

# Fiber Lineup

## Vacuum side fiber

\* Sensing ranges are for FX-500 series amplifiers.

### Vacuum-resistant thru-beam type fiber FT-40V

Sensing range: STD mode 270 mm **10.630 in**  
 HYPER mode 1,000 mm **39.370 in**  
 Ambient temperature: -30 to +300 °C **-22 to +572 °F**

### FT-40V + FV-LE1 (Expansion lens)

Sensing range: STD mode 1,500 mm **59.055 in**  
 HYPER mode 1,800 mm **70.866 in**  
 Ambient temperature: -30 to +300 °C **-22 to +572 °F**

### FT-40V + FV-SV1 (Vacuum-resistant compact side-view lens)

Sensing range:  
 STD mode 450 mm **17.717 in**  
 HYPER mode 1,800 mm **70.866 in**  
 Ambient temperature:  
 -30 to +300 °C **-22 to +572 °F**

### FT-40V + FV-SV2 (Vacuum-resistant side-view lens)

Sensing range:  
 STD mode 1,500 mm **59.055 in**  
 HYPER mode 1,800 mm **70.866 in**  
 Ambient temperature:  
 -30 to +300 °C **-22 to +572 °F**

### Vacuum-resistant convergent reflective type fiber FD-L10V

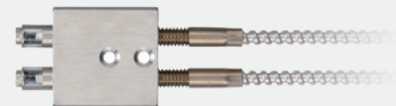

Sensing range:  
 STD mode 0 to 8 mm **0 to 0.315 in**  
 HYPER mode 0 to 18 mm **0 to 0.709 in**  
 Ambient temperature:  
 -30 to +300 °C **-22 to +572 °F**

### Vacuum-resistant long range reflective type fiber FD-KZ50V

Sensing range:  
 STD mode 20 to 200 mm **0.787 to 7.874 in**  
 HYPER mode 5 to 500 mm **0.197 to 19.685 in**  
 Ambient temperature:  
 -30 to +300 °C **-22 to +572 °F**

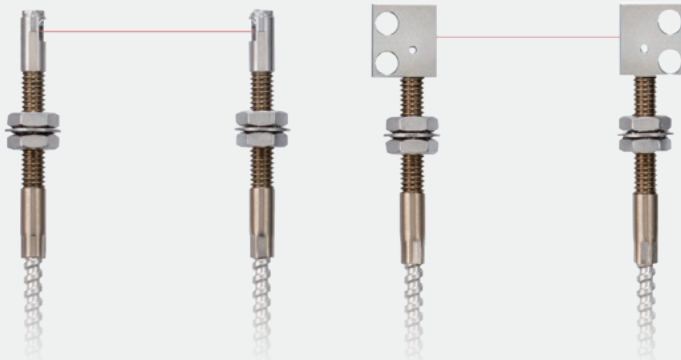

## Atmospheric side fiber

### FT-J9

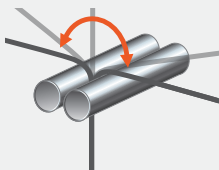

**Bending durability**  
**10 million times or more**  
 (Typical)

Bending conditions  
 Bending radius: R10 mm **R0.394 in**,  
 Reciprocating bending: 180°

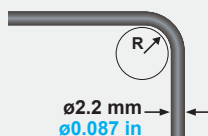

**More flexible**  
**R4 mm R0.157 in**

## Vacuum-resistant flange

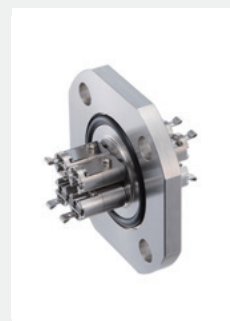

**Vacuum-resistant flange 4CH**  
**FV-FR4**



**Vacuum-resistant flange 1CH**  
**FV-FR1**



# Applications

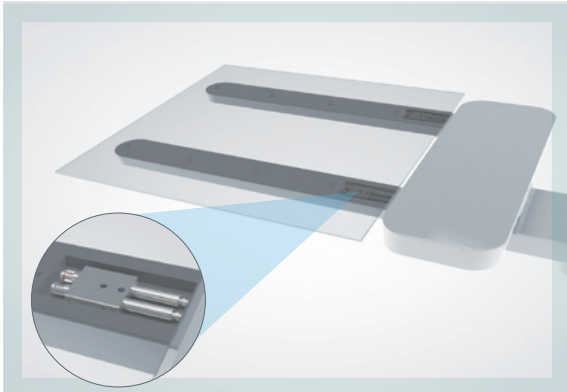

Detection of glass seating on robot hand

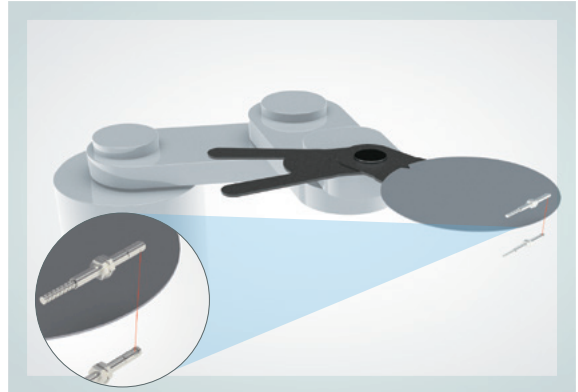

Detection of semiconductor wafer

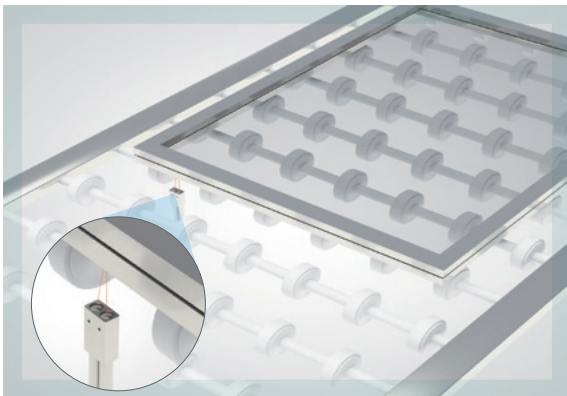

Detection of passing glass

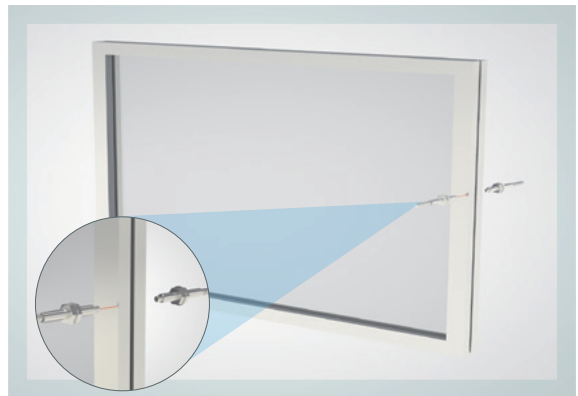

Detection of presence / absence of glass

## Contributes to your product quality improvement and workload reduction

Using the integrated manufacturing system established in our factory, we conduct all processes ranging from product development to production, quality control, packaging and shipping.



Baking



Sealing and packing

### Vacuum baking for the reduction of outgas

The vacuum side fiber and flange are cleaned and baked, and then seal-packed and double-packed for shipping.

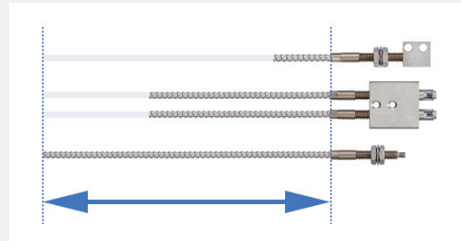

### Customizable fiber length

We offer semi-custom products in which the fiber length can be specified in 100 mm [3.937 in](#) increments. Different fiber lengths can be specified for the emitting side and receiving side. Contact our sales office for semi-custom products.

## VACUUM-RESISTANT FIBER SET CONTENTS

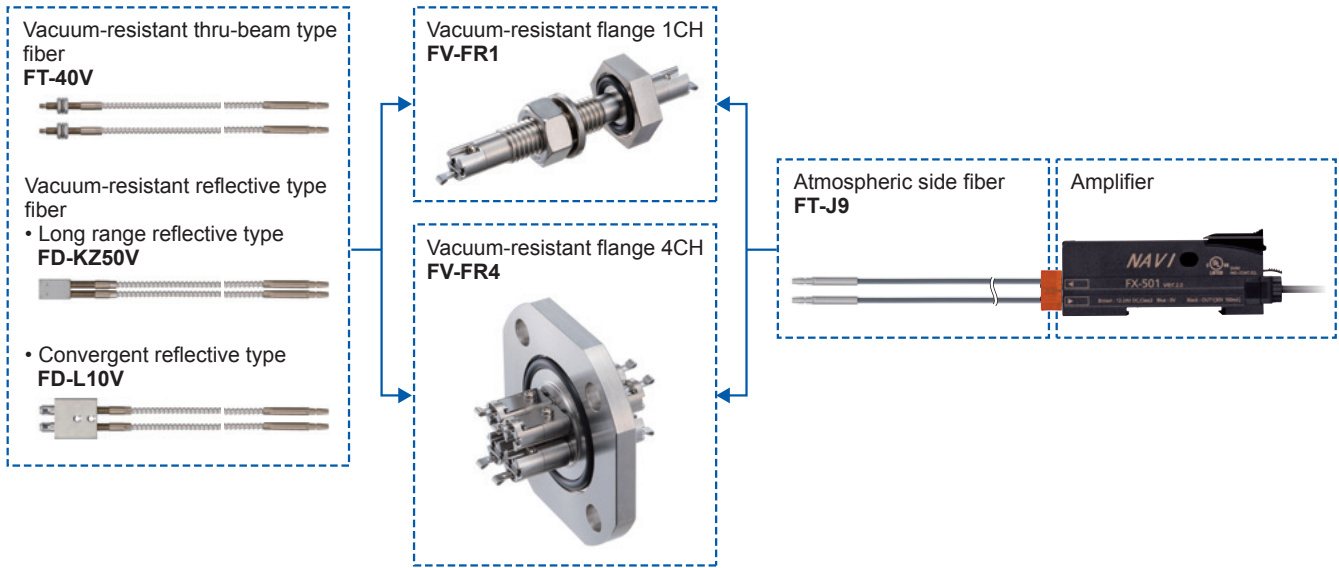

## LIST OF FIBERS

### Vacuum-resistant thru-beam type (one pair set) Atmospheric side fiber is optional and sold separately.

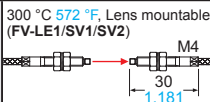
Type	Shape of fiber head (mm in)	Model No.	Bending radius (mm in)	Fiber cable length	Sensing range (mm in) (Note 2)						Beam axis dia. (mm in)	Ambient temp.
					FX-500 series	Other modes	U-LG LONG FAST H-SP	FX-550 / FX-550L series	Other modes	U-LG LONG FAST		
Vacuum-resistant Thru-beam	 300 °C 572 °F, Lens mountable (FV-LE1/SV1/SV2)	FT-40V	R25 R0.984	1 m 3.281 ft (Note 1)	STD 270 10.630 HYPR 1,000 39.370	590 23.228 470 18.504 160 6.299 55 2.165	STD 400 15.748 HYPR 1,400 55.118	950 37.402 620 24.409 250 9.843	110 4.331 280 11.024	ø1.3 ø0.051	-30 to +300 °C -22 to +572 °F	

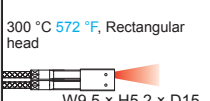
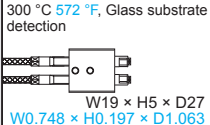

Notes: 1) This is not a "free-cut" type. We offer only semi-custom products in which the fiber length can be specified in 100 mm 3.937 in increments. For details, please contact our sales office.  
 2) FX-550L series does not have FAST mode.

### Vacuum-resistant reflective type Atmospheric side fiber is optional and sold separately.

Type	Shape of fiber head (mm in)	Model No.	Bending radius (mm in)	Fiber cable length	Sensing range (mm in) (Note 2, 3)						Ambient temp.
					FX-500 series	Other modes	U-LG LONG FAST H-SP	FX-550 / FX-550L series	Other modes	U-LG LONG FAST	
Vacuum-resistant Long range reflective	 300 °C 572 °F, Rectangular head W9.5 × H5.2 × D15 W0.374 × H0.205 × D0.591	FD-KZ50V	R25 R0.984	1 m 3.281 ft (Note 1)	STD 20 to 200 0.787 to 7.874 HYPR 5 to 500 0.197 to 19.685	10 to 340 0.394 to 13.386 15 to 270 0.591 to 10.630 20 to 120 0.787 to 4.724 20 to 45 0.787 to 1.772	STD 20 to 450 0.787 to 17.717 HYPR 5 to 1,500 0.197 to 59.055	10 to 1,000 0.394 to 39.370 15 to 650 0.591 to 25.591 20 to 300 0.787 to 11.811	25 to 80 0.984 to 3.150 10 to 220 0.394 to 8.661	-30 to +300 °C -22 to +572 °F	
	 300 °C 572 °F, Glass substrate detection W19 × H5 × D27 W0.748 × H0.197 × D1.063	FD-L10V		3 m 9.843 ft (Note 1)	STD 0 to 8 0 to 0.315 HYPR 0 to 18 0 to 0.709	0 to 12 0 to 0.472 0 to 10 0 to 0.394 0 to 5.5 0 to 0.217 1.5 to 3 0.059 to 0.118	STD 0 to 11 0 to 0.433 HYPR 0 to 27 0 to 1.063	0 to 19 0 to 0.748 0 to 13 0 to 0.512 0 to 7.5 0 to 0.295	2.5 to 6.5 0.098 to 0.256 0 to 11 0 to 0.433		

Notes: 1) This is not a "free-cut" type. We offer only semi-custom products in which the fiber length can be specified in 100 mm 3.937 in increments. For details, please contact our sales office.  
 2) The sensing range is the value for transparent glass 100 × 100 × 10.7 mm 3.937 × 3.937 × 10.028 in.  
 3) FX-550L series does not have FAST mode.

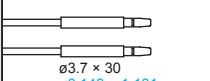
### Atmospheric side (one pair set)

Type	Shape of fiber head (mm in)	Model No.	Bending radius (mm in)	Fiber cable length	Ambient temp.
Atmospheric side	 ø3.7 × 30 ø0.146 × 1.181	<b>Tough</b> (Bending durability) FT-J9	R4 R0.157	 2 m 6.562 ft (Note 1, 2)	-30 to +80 °C -22 to +176 °F



Notes: 1) We offer only semi-custom products in which the fiber length can be specified in 100 mm 3.937 in increments. For details, please contact our sales office.  
 2) Note that the sensing range of the free-cut type fiber may be reduced by 20 % max. depending upon how the fiber is cut.

**Tough**: Refers to a fiber which possesses both unbreakable (bending radius: R10 mm R0.394 in, reciprocating bending: 180°) and more flexible (bending radius: R4 mm R0.157 in or less) features.

: Refers to a fiber which possesses unbreakable bending resistant feature (bending radius: R10 mm R0.394 in, reciprocating bending: 180°).

## FIBER OPTIONS



**Vacuum-resistant flange** Applicable fibers are **FT-40V, FD-KZ50V, FD-L10V** and **FT-J9**.

Designation	Model No.	Description																															
Vacuum-resistant flange 1CH	<b>FV-FR1</b>		Atmospheric side and vacuum side are isolated.																														
			Main specifications																														
Vacuum-resistant flange 4CH	<b>FV-FR4</b>		<table border="1"> <thead> <tr> <th>Model No.</th> <th>FV-FR1</th> <th>FV-FR4</th> </tr> </thead> <tbody> <tr> <td>Applicable fibers</td> <td colspan="2">FT-40V, FD-KZ50V, FD-L10V, FT-J9</td> </tr> <tr> <td>Leakage</td> <td colspan="2">1.0 × 10<sup>-10</sup> Pa·m<sup>3</sup>/s [He] or less (* Measured with a He detector)</td> </tr> <tr> <td>Ambient temperature</td> <td colspan="2">-30 to +120°C -22 to +248°F (Same for storage. Up to +40 °C +104°F when humidity is high. However, no dew condensation or icing allowed.)</td> </tr> <tr> <td>Ambient humidity</td> <td colspan="2">35 to 85% RH (Same for storage)</td> </tr> <tr> <td>Tightening torque</td> <td>Nut: 14.7 N·m or less (M14 nut)</td> <td>9.8 N·m or less (M8 screw)</td> </tr> <tr> <td>Tensile strength</td> <td colspan="2">20 N or less (Atmospheric / vacuum side fiber joint)</td> </tr> <tr> <td>O-ring size</td> <td>V15</td> <td>V40</td> </tr> <tr> <td>Weight</td> <td>100 g approx.</td> <td>410 g approx.</td> </tr> <tr> <td>Material</td> <td colspan="2">Main unit: Stainless steel (SUS303), Holding bracket: Stainless steel (SUS301), Fiber: Quartz glass, O-ring: Fluororubber</td> </tr> </tbody> </table>	Model No.	FV-FR1	FV-FR4	Applicable fibers	FT-40V, FD-KZ50V, FD-L10V, FT-J9		Leakage	1.0 × 10 <sup>-10</sup> Pa·m <sup>3</sup> /s [He] or less (* Measured with a He detector)		Ambient temperature	-30 to +120°C -22 to +248°F (Same for storage. Up to +40 °C +104°F when humidity is high. However, no dew condensation or icing allowed.)		Ambient humidity	35 to 85% RH (Same for storage)		Tightening torque	Nut: 14.7 N·m or less (M14 nut)	9.8 N·m or less (M8 screw)	Tensile strength	20 N or less (Atmospheric / vacuum side fiber joint)		O-ring size	V15	V40	Weight	100 g approx.	410 g approx.	Material	Main unit: Stainless steel (SUS303), Holding bracket: Stainless steel (SUS301), Fiber: Quartz glass, O-ring: Fluororubber	
			Model No.	FV-FR1	FV-FR4																												
			Applicable fibers	FT-40V, FD-KZ50V, FD-L10V, FT-J9																													
			Leakage	1.0 × 10 <sup>-10</sup> Pa·m <sup>3</sup> /s [He] or less (* Measured with a He detector)																													
			Ambient temperature	-30 to +120°C -22 to +248°F (Same for storage. Up to +40 °C +104°F when humidity is high. However, no dew condensation or icing allowed.)																													
			Ambient humidity	35 to 85% RH (Same for storage)																													
			Tightening torque	Nut: 14.7 N·m or less (M14 nut)	9.8 N·m or less (M8 screw)																												
			Tensile strength	20 N or less (Atmospheric / vacuum side fiber joint)																													
			O-ring size	V15	V40																												
			Weight	100 g approx.	410 g approx.																												
Material	Main unit: Stainless steel (SUS303), Holding bracket: Stainless steel (SUS301), Fiber: Quartz glass, O-ring: Fluororubber																																
			Recommended thickness of vacuum chamber wall																														
			• For <b>FV-FR1</b> : 3.0 to 40.0 mm <b>0.118 to 1.575 in</b> (Note 1)																														
			• For <b>FV-FR4</b> : 3.0 mm <b>0.118 in</b> or more (Note 2)																														

Notes: 1) Confirm the wall thickness in advance since the **FV-FR1** cannot be installed to a vacuum chamber with a wall thickness outside the recommended thickness range.

2) If the vacuum chamber wall is too thick, the **FV-FR4** may not be able to connect to the vacuum side fiber. In that case, connect the **FV-FR4** to the vacuum side fiber before the installation.

### Vacuum-resistant lens (For thru-beam type fiber)

Designation	Model No.	Description																																																																	
Vacuum-resistant expansion lens (Note 1)	<b>FV-LE1</b>		Increases the sensing range 4 times or more.																																																																
			<ul style="list-style-type: none"> <li>Ambient temperature: -60 to +350 °C <b>-76 to +662 °F</b> (Note 2)</li> <li>Beam axis dia: ø3.6 mm <b>ø0.142 in</b></li> </ul>																																																																
For thru-beam type fiber	Vacuum-resistant compact side-view lens (Note 1)		Beam axis is bent by 90°.																																																																
			<ul style="list-style-type: none"> <li>Ambient temperature: -30 to +300 °C <b>-22 to +572 °F</b> (Note 2)</li> <li>Beam axis dia: ø3 mm <b>ø0.118 in</b></li> </ul>																																																																
			Sensing range (mm in) [Lens on both sides] (Note 3)																																																																
			<table border="1"> <thead> <tr> <th rowspan="2">Fiber</th> <th rowspan="2">Mode</th> <th colspan="6">FX-500 series (Upper value)</th> <th colspan="2">FX-100 series</th> </tr> <tr> <th colspan="6">FX-550 / FX-550L series (Lower value)</th> <th>FX-101</th> <th>FX-102</th> </tr> </thead> <tbody> <tr> <td rowspan="4">FT-40V</td> <td></td> <td>HYPR</td> <td>U-LG</td> <td>LONG</td> <td>STD</td> <td>FAST</td> <td>H-SP</td> <td></td> <td></td> </tr> <tr> <td></td> <td>1,800 (Note 4)</td> <td>1,800 (Note 4)</td> <td>1,800 (Note 4)</td> <td>1,500</td> <td>900</td> <td>370</td> <td>FX-101</td> <td>FX-102</td> </tr> <tr> <td></td> <td><b>70.866</b></td> <td><b>70.866</b></td> <td><b>70.866</b></td> <td><b>59.055</b></td> <td><b>35.433</b></td> <td><b>14.567</b></td> <td>450</td> <td>1,600</td> </tr> <tr> <td></td> <td>1,800 (Note 4)</td> <td>1,800 (Note 4)</td> <td>1,800 (Note 4)</td> <td>1,800 (Note 4)</td> <td>1,650</td> <td>—</td> <td><b>17.717</b></td> <td><b>62.992</b></td> </tr> <tr> <td></td> <td><b>70.866</b></td> <td><b>70.866</b></td> <td><b>70.866</b></td> <td><b>70.866</b></td> <td><b>64.961</b></td> <td>—</td> <td></td> <td></td> </tr> </tbody> </table>	Fiber	Mode	FX-500 series (Upper value)						FX-100 series		FX-550 / FX-550L series (Lower value)						FX-101	FX-102	FT-40V		HYPR	U-LG	LONG	STD	FAST	H-SP				1,800 (Note 4)	1,800 (Note 4)	1,800 (Note 4)	1,500	900	370	FX-101	FX-102		<b>70.866</b>	<b>70.866</b>	<b>70.866</b>	<b>59.055</b>	<b>35.433</b>	<b>14.567</b>	450	1,600		1,800 (Note 4)	1,800 (Note 4)	1,800 (Note 4)	1,800 (Note 4)	1,650	—	<b>17.717</b>	<b>62.992</b>		<b>70.866</b>	<b>70.866</b>	<b>70.866</b>	<b>70.866</b>	<b>64.961</b>	—		
			Fiber			Mode	FX-500 series (Upper value)						FX-100 series																																																						
				FX-550 / FX-550L series (Lower value)						FX-101	FX-102																																																								
			FT-40V		HYPR	U-LG	LONG	STD	FAST	H-SP																																																									
					1,800 (Note 4)	1,800 (Note 4)	1,800 (Note 4)	1,500	900	370	FX-101	FX-102																																																							
					<b>70.866</b>	<b>70.866</b>	<b>70.866</b>	<b>59.055</b>	<b>35.433</b>	<b>14.567</b>	450	1,600																																																							
					1,800 (Note 4)	1,800 (Note 4)	1,800 (Note 4)	1,800 (Note 4)	1,650	—	<b>17.717</b>	<b>62.992</b>																																																							
	<b>70.866</b>	<b>70.866</b>	<b>70.866</b>	<b>70.866</b>	<b>64.961</b>	—																																																													
Beam axis is bent by 90°.																																																																			
<ul style="list-style-type: none"> <li>Ambient temperature: -60 to +300 °C <b>-76 to +572 °F</b> (Note 2)</li> <li>Beam axis dia: ø3.7 mm <b>ø0.146 in</b></li> </ul>																																																																			
Sensing range (mm in) [Lens on both sides] (Note 3)																																																																			
<table border="1"> <thead> <tr> <th rowspan="2">Fiber</th> <th rowspan="2">Mode</th> <th colspan="6">FX-500 series (Upper value)</th> <th colspan="2">FX-100 series</th> </tr> <tr> <th colspan="6">FX-550 / FX-550L series (Lower value)</th> <th>FX-101</th> <th>FX-102</th> </tr> </thead> <tbody> <tr> <td rowspan="4">FT-40V</td> <td></td> <td>HYPR</td> <td>U-LG</td> <td>LONG</td> <td>STD</td> <td>FAST</td> <td>H-SP</td> <td></td> <td></td> </tr> <tr> <td></td> <td>1,800 (Note 4)</td> <td>900</td> <td>700</td> <td>450</td> <td>290</td> <td>90</td> <td>FX-101</td> <td>FX-102</td> </tr> <tr> <td></td> <td><b>70.866</b></td> <td><b>35.433</b></td> <td><b>27.559</b></td> <td><b>17.717</b></td> <td><b>11.417</b></td> <td><b>3.543</b></td> <td>150</td> <td>460</td> </tr> <tr> <td></td> <td>1,800 (Note 4)</td> <td>1,800 (Note 4)</td> <td>1,050</td> <td>720</td> <td>430</td> <td>—</td> <td><b>5.906</b></td> <td><b>18.110</b></td> </tr> <tr> <td></td> <td><b>70.866</b></td> <td><b>70.866</b></td> <td><b>41.339</b></td> <td><b>28.346</b></td> <td><b>16.929</b></td> <td>—</td> <td></td> <td></td> </tr> </tbody> </table>	Fiber	Mode	FX-500 series (Upper value)						FX-100 series		FX-550 / FX-550L series (Lower value)						FX-101	FX-102	FT-40V		HYPR	U-LG	LONG	STD	FAST	H-SP				1,800 (Note 4)	900	700	450	290	90	FX-101	FX-102		<b>70.866</b>	<b>35.433</b>	<b>27.559</b>	<b>17.717</b>	<b>11.417</b>	<b>3.543</b>	150	460		1,800 (Note 4)	1,800 (Note 4)	1,050	720	430	—	<b>5.906</b>	<b>18.110</b>		<b>70.866</b>	<b>70.866</b>	<b>41.339</b>	<b>28.346</b>	<b>16.929</b>	—					
Fiber			Mode	FX-500 series (Upper value)						FX-100 series																																																									
	FX-550 / FX-550L series (Lower value)						FX-101	FX-102																																																											
FT-40V		HYPR	U-LG	LONG	STD	FAST	H-SP																																																												
		1,800 (Note 4)	900	700	450	290	90	FX-101	FX-102																																																										
		<b>70.866</b>	<b>35.433</b>	<b>27.559</b>	<b>17.717</b>	<b>11.417</b>	<b>3.543</b>	150	460																																																										
		1,800 (Note 4)	1,800 (Note 4)	1,050	720	430	—	<b>5.906</b>	<b>18.110</b>																																																										
	<b>70.866</b>	<b>70.866</b>	<b>41.339</b>	<b>28.346</b>	<b>16.929</b>	—																																																													
Beam axis is bent by 90°.																																																																			
<ul style="list-style-type: none"> <li>Ambient temperature: -60 to +300 °C <b>-76 to +572 °F</b> (Note 2)</li> <li>Beam axis dia: ø3.7 mm <b>ø0.146 in</b></li> </ul>																																																																			
Sensing range (mm in) [Lens on both sides] (Note 3)																																																																			
<table border="1"> <thead> <tr> <th rowspan="2">Fiber</th> <th rowspan="2">Mode</th> <th colspan="6">FX-500 series (Upper value)</th> <th colspan="2">FX-100 series</th> </tr> <tr> <th colspan="6">FX-550 / FX-550L series (Lower value)</th> <th>FX-101</th> <th>FX-102</th> </tr> </thead> <tbody> <tr> <td rowspan="4">FT-40V</td> <td></td> <td>HYPR</td> <td>U-LG</td> <td>LONG</td> <td>STD</td> <td>FAST</td> <td>H-SP</td> <td></td> <td></td> </tr> <tr> <td></td> <td>1,800 (Note 4)</td> <td>1,800 (Note 4)</td> <td>1,800 (Note 4)</td> <td>1,500</td> <td>900</td> <td>370</td> <td>FX-101</td> <td>FX-102</td> </tr> <tr> <td></td> <td><b>70.866</b></td> <td><b>70.866</b></td> <td><b>70.866</b></td> <td><b>59.055</b></td> <td><b>35.433</b></td> <td><b>14.567</b></td> <td>450</td> <td>1,600</td> </tr> <tr> <td></td> <td>1,800 (Note 4)</td> <td>1,800 (Note 4)</td> <td>1,800 (Note 4)</td> <td>1,800 (Note 4)</td> <td>1,100</td> <td>—</td> <td><b>17.717</b></td> <td><b>62.992</b></td> </tr> <tr> <td></td> <td><b>70.866</b></td> <td><b>70.866</b></td> <td><b>70.866</b></td> <td><b>70.866</b></td> <td><b>43.307</b></td> <td>—</td> <td></td> <td></td> </tr> </tbody> </table>	Fiber	Mode	FX-500 series (Upper value)						FX-100 series		FX-550 / FX-550L series (Lower value)						FX-101	FX-102	FT-40V		HYPR	U-LG	LONG	STD	FAST	H-SP				1,800 (Note 4)	1,800 (Note 4)	1,800 (Note 4)	1,500	900	370	FX-101	FX-102		<b>70.866</b>	<b>70.866</b>	<b>70.866</b>	<b>59.055</b>	<b>35.433</b>	<b>14.567</b>	450	1,600		1,800 (Note 4)	1,800 (Note 4)	1,800 (Note 4)	1,800 (Note 4)	1,100	—	<b>17.717</b>	<b>62.992</b>		<b>70.866</b>	<b>70.866</b>	<b>70.866</b>	<b>70.866</b>	<b>43.307</b>	—					
Fiber			Mode	FX-500 series (Upper value)						FX-100 series																																																									
	FX-550 / FX-550L series (Lower value)						FX-101	FX-102																																																											
FT-40V		HYPR	U-LG	LONG	STD	FAST	H-SP																																																												
		1,800 (Note 4)	1,800 (Note 4)	1,800 (Note 4)	1,500	900	370	FX-101	FX-102																																																										
		<b>70.866</b>	<b>70.866</b>	<b>70.866</b>	<b>59.055</b>	<b>35.433</b>	<b>14.567</b>	450	1,600																																																										
		1,800 (Note 4)	1,800 (Note 4)	1,800 (Note 4)	1,800 (Note 4)	1,100	—	<b>17.717</b>	<b>62.992</b>																																																										
	<b>70.866</b>	<b>70.866</b>	<b>70.866</b>	<b>70.866</b>	<b>43.307</b>	—																																																													

Notes: 1) Be careful when installing the thru-beam type fiber equipped with the lens, as the beam envelope becomes narrow and alignment is difficult.

2) Refer to previous page for the ambient temperature of fibers to be used in combination.

3) The fiber cable length for the **FT-40V** is 1 m **3.281 ft**. The sensing ranges take into account the length of the **FT-J9** atmospheric side fiber.



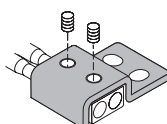

4) The fiber cable length practically limits the sensing range.

### Accessory

- Mounting bracket for **FD-KZ50V**  
**MS-FD-2**



**Amplifiers**

Type		Appearance	Model No.	Emitting element	Output	
FX-500 series	Standard type		FX-501 (Note 1)	Red LED	NPN open-collector transistor	
			FX-501P (Note 1)		PNP open-collector transistor	
	2-output type		FX-502 (Note 1)		NPN open-collector transistor 2 outputs	
			FX-502P (Note 1)		PNP open-collector transistor 2 outputs	
	Cable type		FX-505-C2		NPN open-collector transistor 2 outputs, analog output	
			FX-505P-C2		PNP open-collector transistor 2 outputs, analog output	
FX-550 series	Connector type		FX-551 (Note 1)		NPN open-collector transistor	
			FX-551P (Note 1)		PNP open-collector transistor	
	Cable type		FX-551-C2		NPN open-collector transistor	
			FX-551P-C2		PNP open-collector transistor	
FX-550L series	Discrete wire type		FX-551L3-P-C2		Red LED	PNP open-collector transistor
	M12 connector type		FX-551L3-P-J			
FX-100 series	Standard type		FX-101-CC2	NPN open-collector transistor		
			FX-101P-CC2	PNP open-collector transistor		
			FX-101 (Note 1)	NPN open-collector transistor		
			FX-101P (Note 1)	PNP open-collector transistor		
	Long sensing range type		Cable set	FX-102-CC2		NPN open-collector transistor
				FX-102P-CC2		PNP open-collector transistor
				FX-102 (Note 1)	NPN open-collector transistor	
				FX-102P (Note 1)	PNP open-collector transistor	

Notes: 1) The amplifier is not provided with a quick-connection cable / connector attached cable. Be sure to purchase an optional quick-connection cable / connector attached cable.  
 2) Refer to the catalog of applicable amplifier or visit our website for the details of the amplifier.

**DIMENSIONS (Unit: mm in)**

Refer to the catalog of the applicable product series or visit our website for dimensions of the amplifier.  
 The CAD data can be downloaded from our website.

**FT-40V Vacuum-resistant thru-beam type fiber**

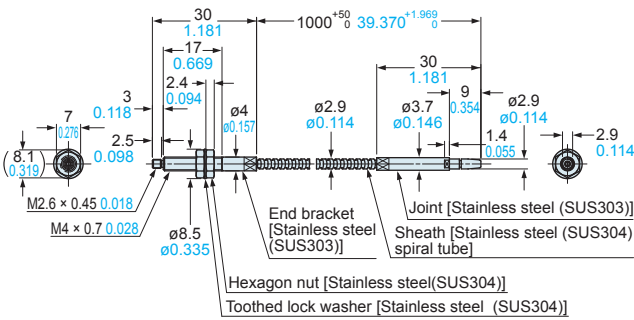

**FD-KZ50V Vacuum-resistant long range reflective type fiber**

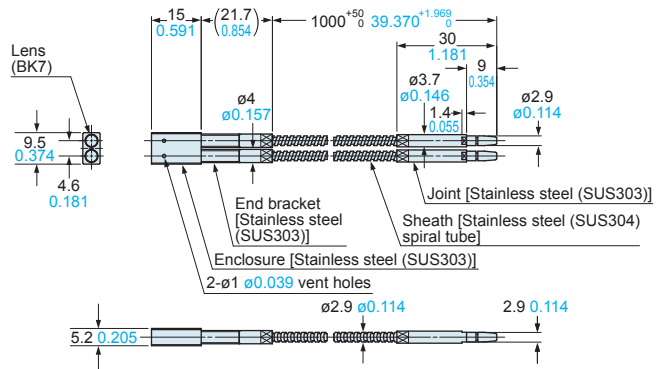

**FD-L10V Vacuum-resistant convergent reflective type fiber**

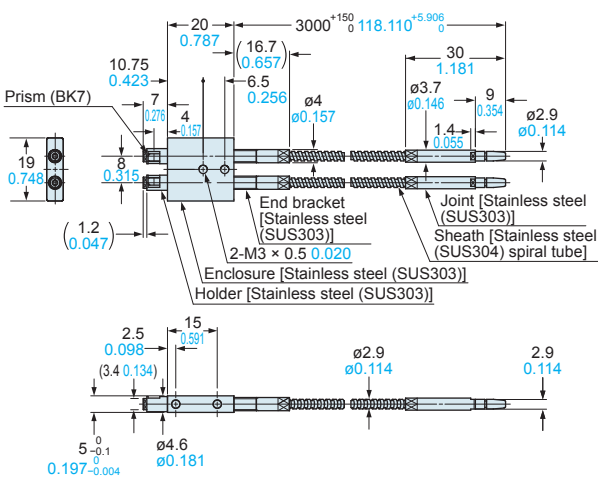

**Assembly dimensions with MS-FD-2 (attached mounting bracket)**

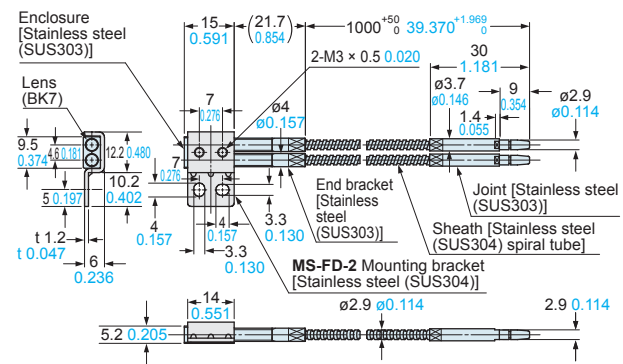



# DIMENSIONS (Unit: mm in)

Refer to the catalog of the applicable product series or visit our website for dimensions of the amplifier.  
The CAD data can be downloaded from our website.

**FT-J9** Atmospheric side fiber (Optional)

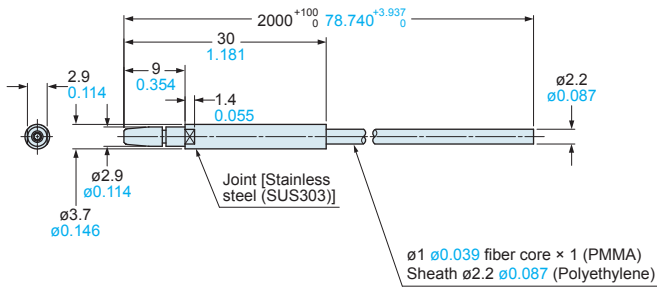

**FV-FR1** Vacuum-resistant flange 1CH (Optional)

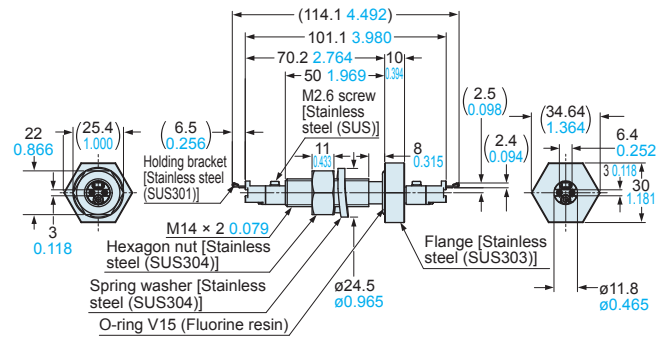

**FV-FR4** Vacuum-resistant flange 4CH (Optional)

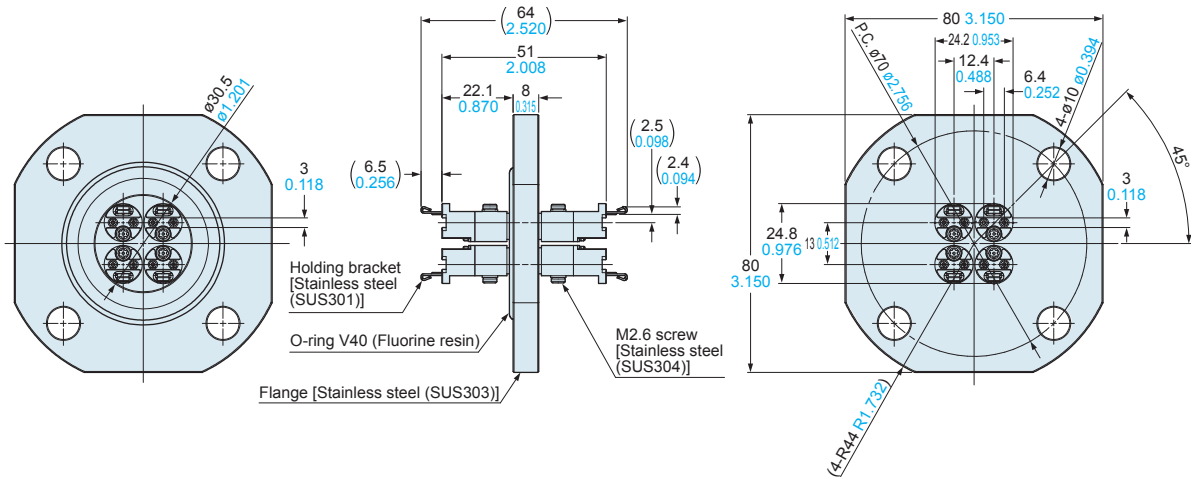

**FV-LE1** Vacuum-resistant expansion lens (Optional)

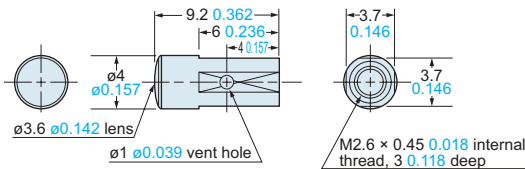

Material: Enclosure.....Aluminum alloy (A6061-T6)  
Lens.....BK-7

**FV-SV1** Vacuum-resistant compact side-view lens (Optional)

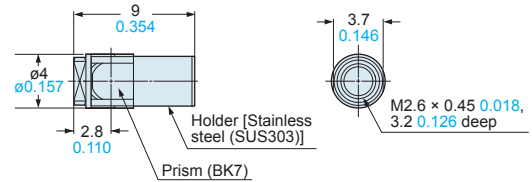

**FV-SV2** Vacuum-resistant side-view lens (Optional)

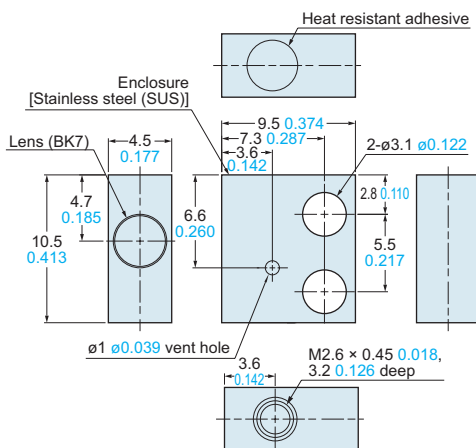

# Fiber Sensor and Communication Unit

## Digital Fiber Sensor

### FX-500 SERIES Ver.2



## Built-in logic functions

No PLC necessary, saving material and programming costs

### Logical calculation functions

3 logical calculations (AND, OR, XOR) are available with fiber sensor only. 3 logical operations can be selected against Output 1. Additional controller is not required so both wire-saving and cost reduction can be achieved.

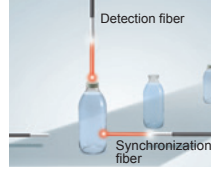

#### Calculation of two neighboring amplifiers

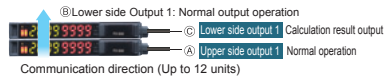

#### Calculation of two outputs in one amplifier

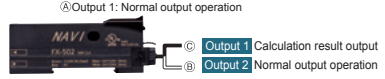

#### Calculation of one amplifier and external input

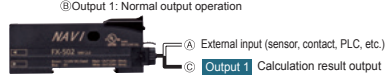

#### Truth table

A	B	Logical calculation output (C)		
		AND	OR	XOR
ON	ON	ON	ON	OFF
OFF	ON	OFF	ON	ON
ON	OFF	OFF	ON	ON
OFF	OFF	OFF	OFF	OFF

## Reduces individual fiber sensor differences and improves stability noticeably!

When the FX-500 series is used together with our super quality fiber, the incident light intensity variation among units is decreased to only 1/4 of that of conventional models.

By being close to absolute values instead of modified digital values, changes in detection that could not be found in the past can now be monitored.

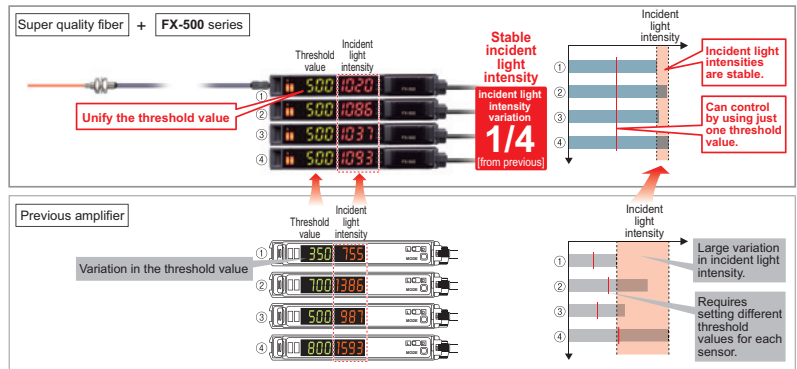

## Communication Unit for Open Network

### SC-GU3 SERIES



## Direct connection of digital sensors to open network!

- High reliability: Remote monitoring capability
- High operating rate: Improved maintainability
- Reduced installation time: Wire-saving and space-saving

The SC-GU3 connects to the host system and enables the following:

- Saves traceability data
- Enables the change of threshold data all at once
- Acquires current values for use in predictive maintenance
- Remote control of equipment

Contributes to the acquisition of digital data of equipment status and application of IoT technology.

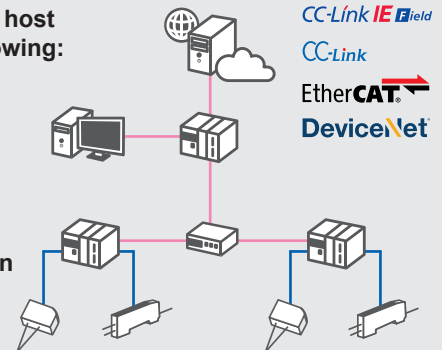

## Disclaimer

The applications described in the catalog are all intended for examples only. The purchase of our products described in the catalog shall not be regarded as granting of a license to use our products in the described applications. We do NOT warrant that we have obtained some intellectual properties, such as patent rights, with respect to such applications, or that the described applications may not infringe any intellectual property rights, such as patent rights, of a third party.

Please contact .....

## Panasonic Corporation

Industrial Device Business Division  
 ■ 1006, Oaza Kadoma, Kadoma-shi, Osaka 571-8506, Japan  
[industrial.panasonic.com/ac/e/](http://industrial.panasonic.com/ac/e/)



©Panasonic Corporation 2019