

HL-C1 SERIES

New

Ultra High-speed Laser Displacement Sensor

CCD Style

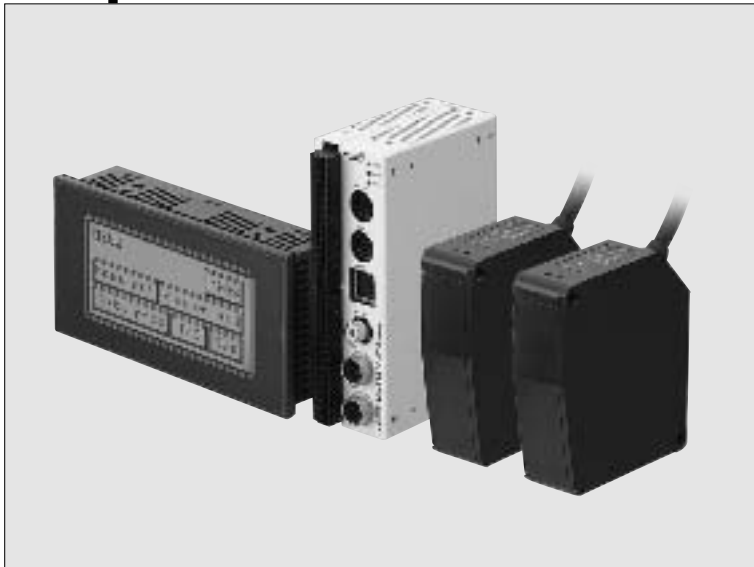

100 μ s, the fastest sampling speed in the industry.
Ultra high-speed & stable measurement for a variety of measurement objects



100 μ s, the fastest sampling rate for this product class, is now available

The most amazing, ultra high-speed sampling in the industry has now been achieved for displacement sensors utilizing linear image sensors, thus enabling ultra high-speed measurement of rotating, vibrating and moving objects.

Resolution of 1 μ m 0.039 mil, linearity of $\pm 0.1\%$ F.S.

Now available with ultra-precise 1 μ m 0.039 mil resolution measurement capability (**HL-C105B-BK, HL-C105F-BK, HL-C105B, HL-C105F**) and a linearity of $\pm 0.1\%$ F.S. (for all models).

FDA standards conforming types are available

FDA standards conforming types (Class II), most suitable for equipment used in the USA, are now available.

Special version for measurement of raw and completed rubber tire

HL-C105C-BK5
HL-C108C-BK5

HL-C1 series has added a new line up of tire measuring specialized version for tire making processes.

High-powered 5 mW type enabled high accuracy and stable measurement of raw tire and completed tire which were previously considered as difficult to measure.

※FDA standards conforming types are available. Please contact our office for details.

High accuracy measurement is now possible, unaffected by the surface condition of the detected object.

All deficiencies inherent in the conventional PSD sensing method have now been completely solved. Whereas the PSD method measures position information from the center of gravity of the total light quantity distribution of the light spots connected along each light element, the linear image sensing method measures the peak position values for the light spots themselves. This advance now makes high-precision measurement possible, regardless of the surface condition of the object whether for metal hairline surface cracks or for non-reflective surfaces, e.g. black rubber.

Change in measurement data due to color difference (White ceramic / Black rubber)



• HL-C108B-BK (linear image sensor method)



• PSD method

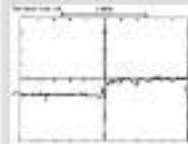

Principle For detection of a V-shaped groove

<Linear image sensor method>

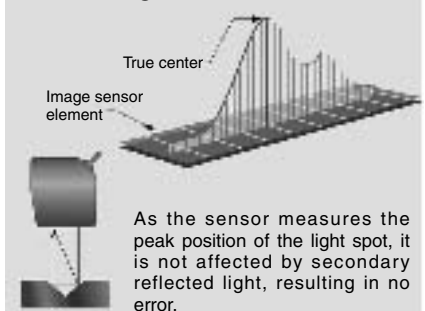

<PSD method>

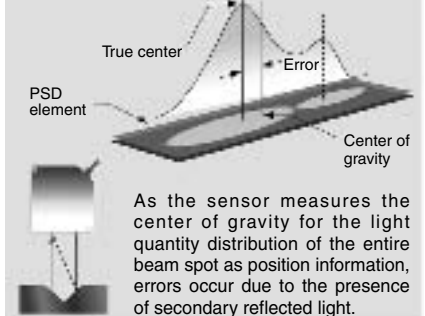

4 types are now available to suit a variety of different measurement objects

The diffuse reflective type **HL-C108B-BK**, **HL-C108F-BK** (measurement center distance: 85 mm 3.346 in) and **HL-C105B-BK**, **HL-C105F-BK** (measurement center distance: 50 mm 1.969 in), the specular reflective type **HL-C108B**, **HL-C108F** (measurement center distance: 81.4 mm 3.205 in) and **HL-C105B**, **HL-C105F** (measurement center distance: 46 mm 1.811 in). In addition, a wider measuring range is also possible, thus facilitating various types of diverse measurement objects and installation conditions.

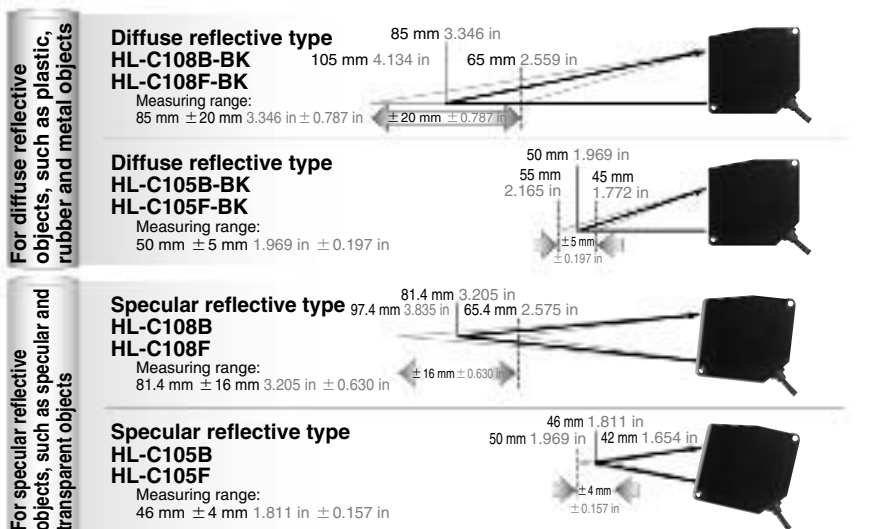

Waterproof sensor head construction, compliant with IP67 rated protection

The **HL-C1** series can withstand water splashes.



Note: Accurate measurement cannot be performed if water is present on the sensing window of the sensor head itself.

Touch panel operation, easy and compact

A variety of setting and measurement data can be displayed easily. (Option)



Equipped with serial input / output

An RS-232C interface for serial input and output is provided so that settings can be retrieved and saved. Measurement values can also be retrieved.

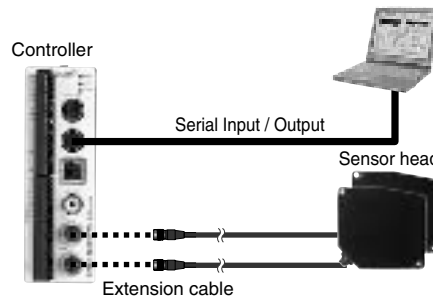

Easy maintenance with sensor head compatibility

Maintainability has been significantly improved. Compatibility has been achieved through the incorporation of correction data into the sensor heads themselves. This new sensor series no longer needs the amount of maintenance usually required for conventional displacement sensors of this class. The same controller can be utilized, even if the sensor head must be replaced with a different model. Also, dedicated connection ports are not required when connecting 2 sensor heads.

A convenient, intelligent monitor (HL-C1AiM) is available (optional)

An intelligent monitor is provided capable of the waveform display of each measurement condition setting and of measurement values as well as monitoring of measurement data and received light intensity data. It can perform waveform monitoring that was only possible until now with a conventional oscilloscope and can easily set each measurement condition and function with the aid of a PC.

Intelligent monitor outline specifications

Condition setting function Measurement data waveform display function

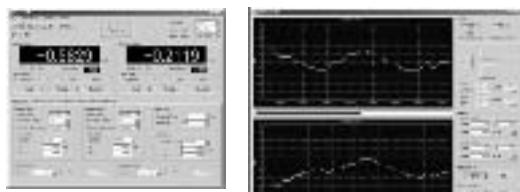

Digital numerical monitoring

- Measurement value and received light intensity data monitoring

Waveform monitoring

- Measurement value and received light intensity data waveform monitoring (Waveform data collection, storage, and reading)

Configurator function

- Setting, storage, and reading of each condition
- Setting, storage, and reading of each function

Data buffering function

- Accumulation of measurement data
- Correspond to Microsoft Excel

2 sensor heads can be connected! Reduces costs and saves space

The controller, to which 2 sensor heads can be connected, incorporates 2 separate input / output channels. This feature saves the expense and space usually required by a second controller, whenever 2 sensor heads are used.

HL-C1

Calculations can be performed when 2 sensor heads are used

The built-in calculation function allows for the measurement of gaps and thicknesses without requiring a digital panel controller, thus saving further on costs and space.

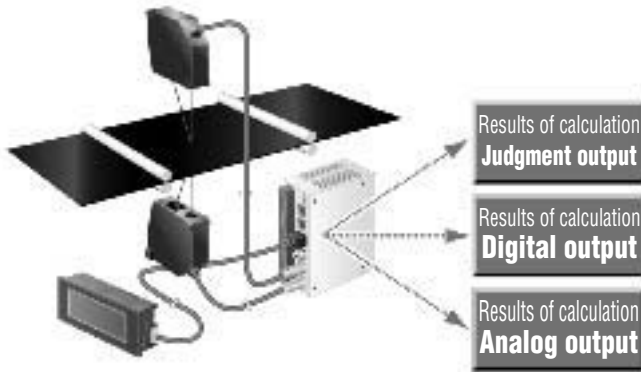

Controller compact and front connection reduces setup space

The ultra-compact controller with dimensions of W40 × H120 × D74 mm W1.575 × H4.724 × D2.913 in requires extremely little space for installation. Adhesive installation is also possible. Furthermore, the cables can be connected directly or to a removable terminal board, so that all connections come from the same direction in order to further save space.

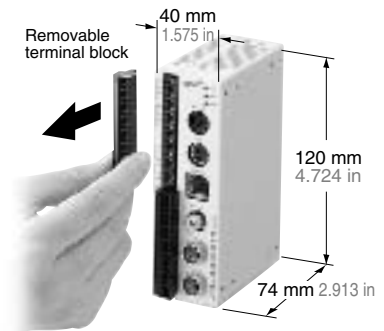

Enhanced functionality

The HL-C1 series incorporates myriad useful functions, including hold functions, calculation functions, filter functions and a hysteresis-setting function, that facilitate convenient usage in a variety of diverse applications.

Low-pass / High-pass filter functions

<Low-pass filter function>

For example, if the surface conditions of a metal object cause noise that interferes with accurate measurement, the use of the low-pass filter function will reduce the effects of noise and allow for the stable measurement of displacement.

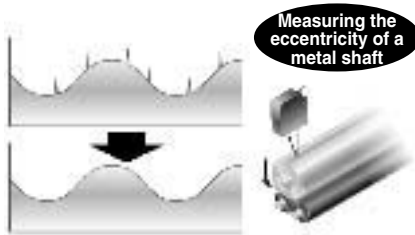

<High-pass filter function>

When measuring seams and gaps in objects that undergo large displacement changes due to vibration or tilting, such as measuring the eccentricity of a rotating object, this function will minimize the effects of these undulations and enable the accurate measurement of seams and gaps.

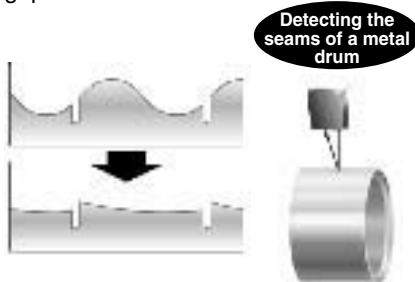

Analog output switching function during alarm output

During measurement, if the unit becomes incapable of performing measurements due to excessive or insufficient incident light intensity (during alarm output), this function allows the analog output to be switched to either hold the data sensed just previously, or to output a fixed value. If the fixed value is selected, one of two options can be chosen for the analog output during alarm output: the output of the maximum value (voltage output: +10.9 V, current output: 29.5 mA) or the output of the minimum value (voltage output: -10.9 V, current output: 0 mA).

Maximum analog output value

The analog output can be used to confirm whether or not the unit is capable of performing measurements.

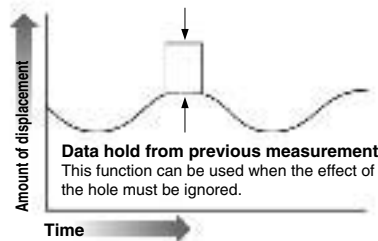

Performing measurements on an object that contains a hole



Hold functions

The HL-C1 series incorporates 4 hold modes.

NORM (no hold)	This mode outputs the amount of displacement from the measurement center distance, in real time. This mode is utilized for general-purpose operation.
P-P	This mode holds the output at the difference between the maximum and minimum measured values. This mode is utilized for vibration or eccentricity measurements.
PEAK	This mode holds the output at the maximum measured value.
VALLEY	This mode holds the output at the minimum measured value.

Data buffering function

It is possible to accumulate data up to 48,000 data into a controller temporarily in order to capture measurement data into a PC. All the accumulated data can be captured into the PC with HL-C1AiM. Used for reading and storing all data including the verification of measurement data when introduced as well as all post-measurement data.

APPLICATIONS

Measuring glass substrate thickness



Positioning wafer



Measuring disk brake thickness



Checking IC pins

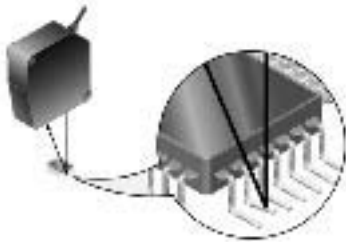

Measuring the eccentricity of a metal shaft



Detecting the presence of a resin coating

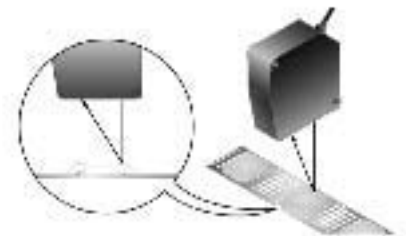

Detecting the grooves in aluminum wheel hubs



Detecting the seams of a metal drum



Measuring the thickness of rubber sheet



Sensing the condition of black rubber



Measuring gap spacing in rubber belt material











Inspecting tire form



HL-C1

ORDER GUIDE

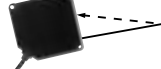
Sensor heads

Type	Appearance	Measurement center distance	Resolution (Note 1, 2)	Beam diameter (Note 3)	Model No.	Conforming standards
Diffuse reflective type		 85 mm 3.346 in (Measuring range ± 20 mm 0.787 in)	3 μ m 0.118 mil	100 \times 140 μ m 3.937 \times 5.512 mil approx.	HL-C108B-BK	IEC / JIS
					HL-C108F-BK	FDA
Diffuse reflective type		 50 mm 1.969 in (Measuring range ± 5 mm 0.197 in)	1 μ m 0.039 mil	70 \times 120 μ m 2.756 \times 4.724 mil approx.	HL-C105B-BK	IEC / JIS
					HL-C105F-BK	FDA
Specular reflective type		 81.4 mm 3.205 in (Measuring range ± 16 mm 0.630 in)	3 μ m 0.118 mil	100 \times 140 μ m 3.937 \times 5.512 mil approx.	HL-C108B	IEC / JIS
					HL-C108F	FDA
Specular reflective type		 46 mm 1.811 in (Measuring range ± 4 mm 0.157 in)	1 μ m 0.039 mil	70 \times 120 μ m 2.756 \times 4.724 mil approx.	HL-C105B	IEC / JIS
					HL-C105F	FDA

Notes: 1) These values were obtained by converting P-P values into a distance. The P-P values indicate the distribution of measured values throughout the measurement center distance.

2) These values were obtained with an average number of samples: 256, when using an object made of our company's standard white ceramic for measurement (an aluminum vapor deposition surface reflection mirror was used with specular reflective types).

3) These values were defined by using $1/e^2$ (13.5 %) of the center light intensity. If there is a slight leakage of light outside the normal spot diameter and if the periphery surrounding the sensing point has a higher reflectivity than the sensing point itself, then the results may be affected.

Controller

Appearance	Model No.	Judgment outputs
	HL-C1C-M	PhotoMOS relay

Compact console

Appearance	Model No.
	HL-C1DP-E

Sensor head extension cable

Appearance	Model No.	Description
	HL-C1CCJ2	Length: 2 m 6.562 ft Weight: 160 g approx.
	HL-C1CCJ5	Length: 5 m 16.404 ft Weight: 350 g approx.
	HL-C1CCJ10	Length: 10 m 32.808 ft Weight: 700 g approx.
	HL-C1CCJ20	Length: 20 m 65.617 ft Weight: 1,400 g approx.
	HL-C1CCJ30	Length: 30 m 98.425 ft Weight: 2,000 g approx.
		Cable type cable with connector on both ends Cable outer diameter: $\phi 6.2$ mm $\phi 0.244$ in Connector outer diameter $\phi 14.7$ mm $\phi 0.579$ in max.

Intelligent monitor

Appearance	Model No.	Description
	HL-C1AiM	Enables the waveform display of each measurement condition setting and of measurement values as well as monitoring of measurement data and received light intensity data.

SPECIFICATIONS

Sensor heads

Type		Diffuse reflective type		Specular reflective type	
		General purpose	High precision	General purpose	High precision
Model No.	IEC / JIS standards conforming type	HL-C108B-BK	HL-C105B-BK	HL-C108B	HL-C105B
	FDA standards conforming type	HL-C108F-BK	HL-C105F-BK	HL-C108F	HL-C105F
Item					
Measurement center distance		85 mm 3.346 in	50 mm 1.969 in	81.4 mm 3.205 in	46 mm 1.811 in
Measuring range		± 20 mm ± 0.787 in	± 5 mm ± 0.197 in	± 16 mm ± 0.630 in	± 4 mm ± 0.157 in
Resolution (Note 2, 3)		3 μm 0.118 mil	1 μm 0.039 mil	3 μm 0.118 mil	1 μm 0.039 mil
Linearity (Note 4)		± 0.1 % F.S.			
Temperature characteristics		± 0.01 % F.S./°C			
Laser emission indicator		Green LED (lights up during laser emission or immediately before laser emission)			
Measuring range indicator		Yellow LED (blinks within the measuring range and lights up when near the measurement center distance (measurement center distance ± 0.5 mm ± 0.020 in))			
Environmental resistance	Pollution degree	3 (Industrial environment)			
	Protection	IP67 (IEC)(excluding the connector)			
	Ambient temperature	0 to + 45 °C + 32 to + 113 °F (No dew condensation), Storage: - 20 to + 70 °C - 4 to + 158 °F			
	Ambient humidity	35 to 85 % RH, Storage: 35 to 85 % RH			
	Ambient illuminance	Incandescent light: 3,000 lx at the light-receiving face			
	Voltage withstandability	500 V AC for one min. between the exclusive controller power input part and the sensor head enclosure			
	Insulation resistance	20 MΩ, or more, with 500 V DC megger between the exclusive controller power input part and the sensor head enclosure			
	Vibration resistance	10 to 55 Hz (period: one minute) frequency, 1.5 mm 0.059 in amplitude in X,Y and Z directions for two hours each			
Shock resistance		196 m/s ² acceleration (20 G approx.) in X,Y and Z directions for three times each			
Emitting element		Red semiconductor laser, Class 2 (Class II for FDA standards conforming type)(IEC / JIS standards conforming type: IEC / JIS, FDA standards conforming type: JIS / IEC / FDA)(max. output: 1 mW, peak emission wavelength: 685 nm 0.027 mil)			
Beam diameter (Note 5)		100 X 140 μm 3.937 X 5.512 mil approx.	70 X 120 μm 2.756 X 4.724 mil approx.	100 X 140 μm 3.937 X 5.512 mil approx.	70 X 120 μm 2.756 X 4.724 mil approx.
Receiving element		Linear image sensor			
Enclosure earthing		Floating			
Material		Enclosure: Die-cast aluminum, Case cover: Die-cast aluminum, Front cover: Glass			
Cable		Cabtyre cable, 0.5 m 1.640 ft long with connector			
Cable extension		Extension up to total 30 m 98.425 ft is possible, with optional cable.			
Weight		500 g approx.			
Accessory		English warning label			

- Notes: 1) Where measurement conditions have not been specified precisely, the conditions used were as follows: supply voltage 24 V DC, ambient temperature + 20 °C + 68 °F, sampling rate 100 μs, average number of samples: 256, measurement center distance, object measured is made of white ceramic (an aluminum vapor deposition surface reflection mirror was used with specular reflective type). Linearity also depends upon the characteristics of the object being measured.
- 2) These values were obtained by converting P-P values into a distance. The P-P values indicate the distribution of measured values throughout the measurement center distance.
- 3) These values were obtained with an average number of samples: 256, when using an object made of our company's standard white ceramic for measurement (an aluminum vapor deposition surface reflection mirror was used with specular reflective types).
- 4) This value indicates the range of errors for an ideal linear displacement output, when using an object made of our company's standard white ceramic for measurement (an aluminum vapor deposition surface reflection mirror was used with specular reflective types). This value may fluctuate depending on the characteristics of the object measured.
- 5) These values were defined by using 1/e² (13.5 %) of the center light intensity. If there is a slight leakage of light outside the normal spot diameter and if the periphery surrounding the sensing point has a higher reflectivity than the sensing point itself, then the results may be affected.

Compact console

Model No.		HL-C1DP-E
Item		
Supply voltage		24 V DC ± 10 % including ripple 0.5 V (P-P)
Current consumption		200 mA or less
Display	Display element	STN monochrome LCD
	Back light	Green LED
	Lifetime of LCD	Average 50,000 hours (Note 1)
	Display range	- 99.9999 to 99.9999
Touch panel	Operation force	0.98 N or less
	Lifetime	1,000,000 times or more
Environmental resistance	Protection	IP65 (IEC)(in initial state)(Note 2) Dust proof and drip proof only at front face of panel. (Waterproof packing is used for surfaces in contact with panel.)
	Ambient temperature	0 to + 40 °C + 32 to + 104 °F (No dew condensation), Storage: - 20 to + 60 °C - 4 to + 140 °F
	Ambient humidity	20 to 85 % RH, Storage: 10 to 85 % RH
	Superimposed noise resistance	1,000 V (P-P) or more, pulse width 50 ns and 1 μs between power terminals
	Electrostatic noise resistance	5,000 V or more (surface of panel)
	Vibration resistance	10 to 55 Hz frequency, 0.75 mm 0.030 in amplitude in X, Y and Z directions for 10 min. each
Shock resistance	98 m/s ² acceleration (10 G approx.) in X, Y and Z directions for four times each	
Weight		260 g approx.
Accessory		Connecting cable for connecting the controller to the console: 1 pc.

- Notes: 1) This value indicates the average lifetime of the unit when used under a normal temperature of + 25 °C + 77 °F.
- 2) When reinstalling the console, replace the waterproof packing.

HL-C1

SPECIFICATIONS

Controller

Model No.		HL-C1C-M
Item		
Connection sensor heads	Maximum 2 sensor heads	
Supply voltage	24 V DC \pm 10 % including ripple 0.5 V (P-P)	
Current consumption	When 1 sensor is connected: 430 mA approx., When 2 sensors are connected: 550 mA approx.	
Sampling rate	Selectable from 100 μ s / 144 μ s / 200 μ s / 255 μ s / 332 μ s / 498 μ s / 1,000 μ s	
Temperature characteristics	\pm 0.01 % F.S./ $^{\circ}$ C	
Analog output	Voltage	Output voltage: \pm 5 V/F.S. [default setting when diffuse reflective mode is selected (Note 2)] Output range: - 10.9 to + 10.9 V Output current: Max. 2 mA, Output impedance: 50 $\%$
	Current (Note 3)	Output current: 4 to 20 mA/F.S. [default setting when diffuse reflective mode is selected (Note 4)] Output range: 0 to 29.5 mA (maximum of 25 mA at max. load impedance.) Load impedance: 250 $\%$ or less
Alarm output		Photo-MOS relay <ul style="list-style-type: none"> • Maximum load current: 50 mA • Applied voltage: 30 V DC or less (between alarm output and COM) • ON impedance: 35 $\%$ or less • Operation time: Max. 2 ms
	Output operation	Opened when the amount of light is excessive or insufficient.
	Short-circuit protection	Incorporated
Judgment outputs (O1, O2)		Photo-MOS relay <ul style="list-style-type: none"> • Maximum load current: 50 mA • Applied voltage: 30 V DC or less (between judgment output and COM) • ON impedance: 35 $\%$ or less • Operation time: Max. 2 ms
	Utilization category	DC-12 or DC-13
	Output operation	Opened or closed when the threshold value is reached. Determined based on judgment output mode selection. (The threshold value varies with the hysteresis setting.)
	Short-circuit protection	Incorporated
Serial input / output	RS-232C	
Timing input (Laser emission)	Laser emission stops or continues when voltage (working input voltage: 12 to 24 V DC, maximum input voltage: 30 V DC) is input or there is an open circuit: determined based on input mode selection.	
Zero set ON input	Zero set: ON when voltage (using input voltage: 12 to 24 V DC, maximum input voltage: 30 V DC) is input	
Zero set OFF input	Zero set: OFF when voltage (using input voltage: 12 to 24 V DC, maximum input voltage: 30 V DC) is input	
Indicators	Laser emission	Green LED (lights up during laser emission from sensor head 1 or sensor head 2, or immediately before laser emission)
	BRIGHT	Red LED (lights up upon disabled measurement due to excessive light at sensor head 1 or 2)
	DARK	Red LED (lights up upon disabled measurement due to insufficient light at sensor head 1 or 2)
Setting / Data display	Compact console: HL-C1DP-E (optional)	
Calibration (Note 5)	Shift	\pm 20.0000 mm \pm 0.787 in
	Span	0.9000 to 1.1000
Average number of samples (Note 5)	OFF, 2 to 32,768 times (16 steps)	
Digital filters (Note 5)	High pass: OFF, 10 to 2,000 Hz (9 steps), Low pass: OFF, 10 to 2,000 Hz (9 steps)	
Calculation functions (Note 5)	L \pm KA, L \pm KB, L \pm K (A \pm B) A, B: Sensor head 1, Sensor head 2 measurement values, L = \pm 999.9999, K = 0.0001 to 99.9999	
Hold functions (Note 5)	Selectable from NORMAL / P-P / PEAK / VALLEY	
Environmental resistance	Pollution degree	3 (Industrial environment)
	Ambient temperature	0 to + 50 $^{\circ}$ C + 32 to + 122 $^{\circ}$ F (No dew condensation), Storage: - 20 to + 70 $^{\circ}$ C - 4 to + 158 $^{\circ}$ F
	Ambient humidity	35 to 85 % RH, Storage: 35 to 85 % RH
	Voltage withstandability	500 V AC for one min. between power input part and enclosure
	Insulation resistance	20 M $\%$, or more, with 500 V DC megger between power input part and enclosure
	Vibration resistance	10 to 55 Hz frequency (period: 1 min.) 0.75 mm 0.030 in amplitude in X, Y and Z directions for 30 min. each
	Shock resistance	196 m/s ² (20 G approx.) in X, Y and Z directions for 3 times each
Total cable lengths	Power line: Less than 10 m 32.808 ft, Signal line: Less than 30 m 98.425 ft	
Weight	300 g approx.	

Notes: 1) Where measurement conditions have not been specified precisely, the conditions used were as follows: supply voltage 24 V DC, ambient temperature + 20 $^{\circ}$ C + 68 $^{\circ}$ F, sampling rate 100 μ s, average number of samples: 256, and measurement center distance.

2) If specular reflective mode is selected, then the default setting is \pm 4 V/F.S.

3) The maximum analog output current will vary with load impedance.

4) If specular reflective mode is selected, then the default setting is 5.6 to 18.4 mA/F.S.

5) These values can be set using the command input from external equipment via the compact console and RS-232C interface.

I/O CIRCUIT AND WIRING DIAGRAMS

HL-C1C-M Controller

Input circuit

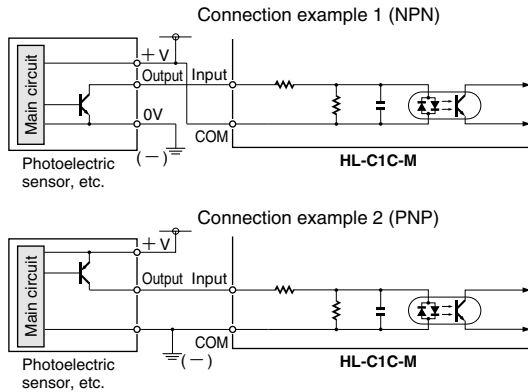

Output circuit

Alarm output, Judgment output

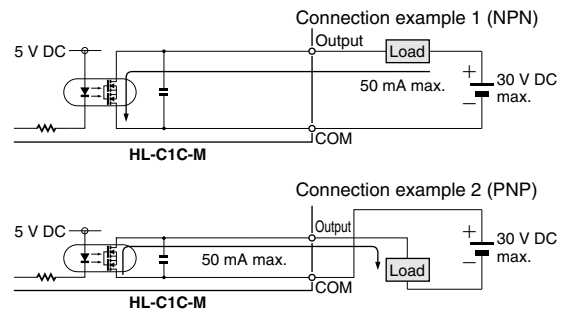

Analog output

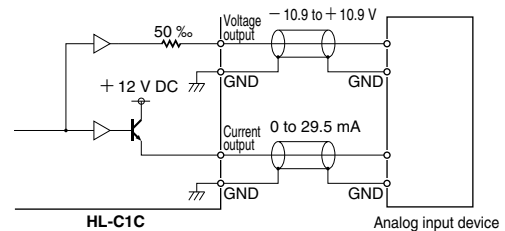

Notes: 1) Do not short-circuit analog output terminals or apply voltage to them.
2) Use shielded wires for analog outputs.

Terminal arrangement

Input terminals

Symbol	Description
TM1	Timing input (sensor head 1)
I11	Zero set ON input (sensor head 1)
I12	Zero set OFF input (sensor head 1)
COM	Input common
TM2	Timing input (sensor head 2)
I21	Zero set ON input (sensor head 2)
I22	Zero set OFF input (sensor head 2)
COM	Input common
•	Not used
•	Not used
•	Not used
•	Not used
•	Not used
•	Not used
+	24 V DC input for power supply
-	Power supply ground
⏏	Function ground

Note: Terminals marked with • are not used. Some are connected to internal circuitry and cannot be used as relay terminals in wiring, etc.

Output terminals

Symbol	Description
AL1	Alarm output (sensor head 1)
O11	Judgment output 1 (sensor head 1)
O12	Judgment output 2 (sensor head 1)
COM	Output common
AL2	Alarm output (sensor head 2)
O21	Judgment output 1 (sensor head 2)
O22	Judgment output 2 (sensor head 2)
COM	Output common
•	Not used
•	Not used
V1	Analog voltage output (sensor head 1)
I1	Analog current output (sensor head 1)
GND	Analog output ground
V2	Analog voltage output (sensor head 2)
I2	Analog current output (sensor head 2)
GND	Analog output ground

Note: Terminals marked with • are not used. Some are connected to internal circuitry and cannot be used as relay terminals in wiring, etc.

HL-C1

SENSING CHARACTERISTICS (TYPICAL)

HL-C108B-BK HL-C108F-BK

Correlation between measuring distance and error characteristics

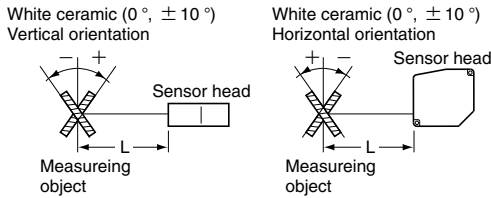

• Vertical positioning

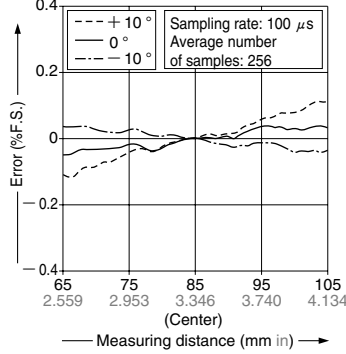

• Horizontal positioning

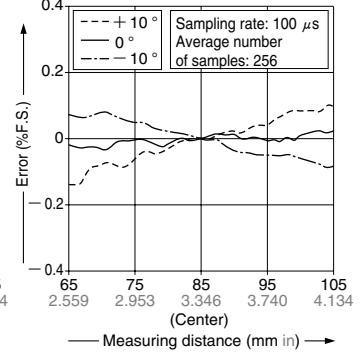

HL-C105B-BK HL-C105F-BK

Correlation between measuring distance and error characteristics

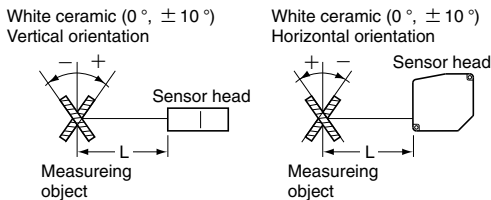

• Vertical positioning

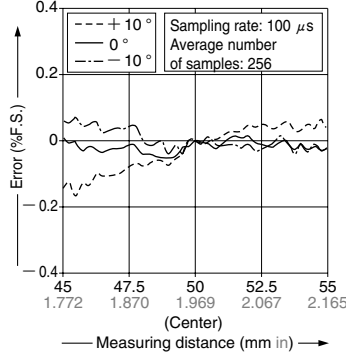

• Horizontal positioning

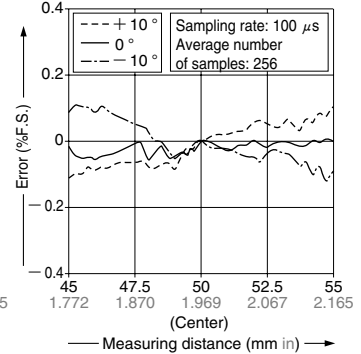

HL-C108B HL-C108F

Correlation between measuring distance and error characteristics

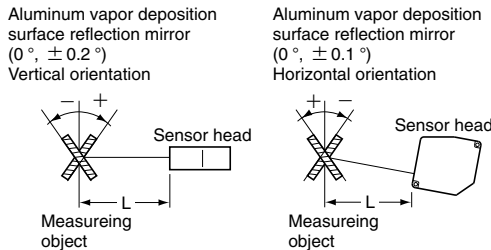

• Vertical positioning

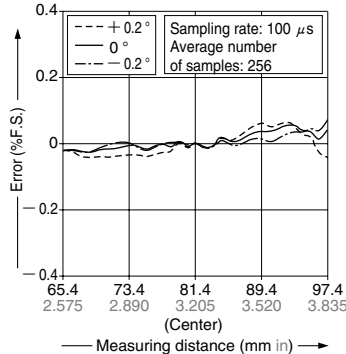

• Horizontal positioning

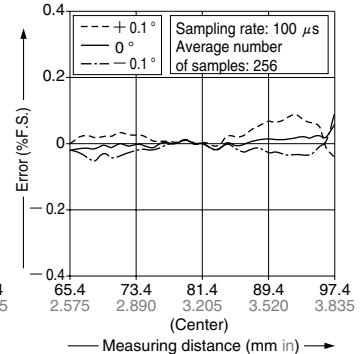

HL-C105B HL-C105F

Correlation between measuring distance and error characteristics

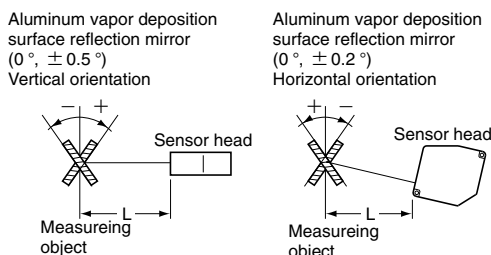

• Vertical positioning

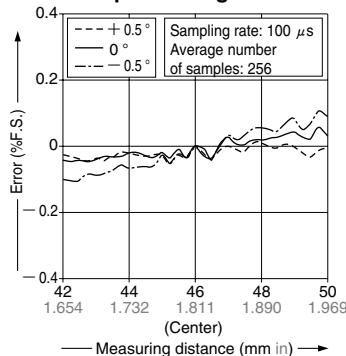

• Horizontal positioning

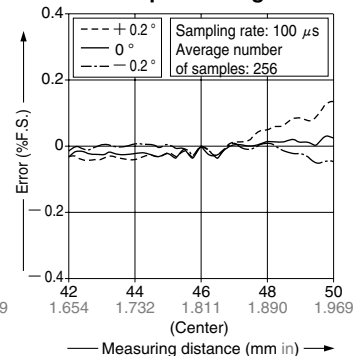

PRECAUTIONS FOR PROPER USE



This product is not a safety sensor. Its use is not intended or designed to protect life and prevent body injury or property damage from dangerous parts of machinery. It is a normal object detection sensor.

Laser radiation

- The laser used in this product corresponds to Class 2 (II) laser IEC / FDA / JIS standards. Do not allow the laser to enter your eye directly or after being reflected. Handle the product by following the instructions given on the warning labels. The right label is pasted on the head.



The English warning label is packed with the sensor.

(The English warning label based on FDA standards is pasted on the FDA standards conforming type.)

Sensor head mounting direction

- To obtain the greatest precision, the sensor head should be oriented facing the direction of movement of the object's surface, as shown in the figure below.

Rotating object

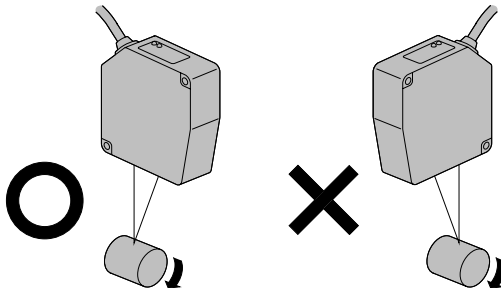

Object that has large differences in gaps, grooves and colors

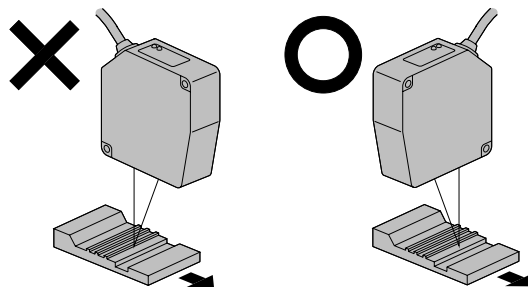

Mutual interference

- When installing 2 or more sensor heads side by side, mutual interference will not occur if the laser spots from other sensor heads do not fall within the shaded areas of the sensor head in the figure below. Multiple sensor heads must be installed in a manner such that laser spots from other sensor heads will be prevented from falling within these shaded areas.

HL-C108B-BK, HL-C108F-BK HL-C108B, HL-C108F

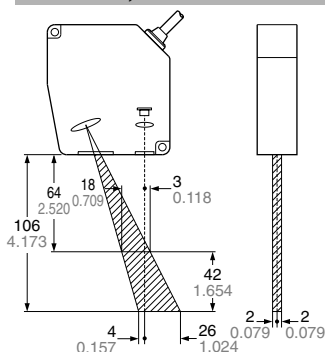

HL-C105B-BK, HL-C105F-BK HL-C105B, HL-C105F

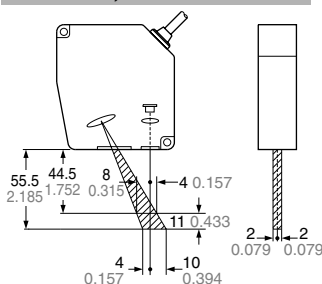

Functional description

Sensor head

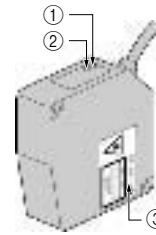

	Description	Function
①	Laser emission indicator (Green LED)	Lights up during laser emission or immediately before laser emission.
②	Measuring range indicator (Yellow LED)	Blinks within the measuring range and lights up when near the measurement center distance.
③	Warning label	Shows the laser emission position.

Controller

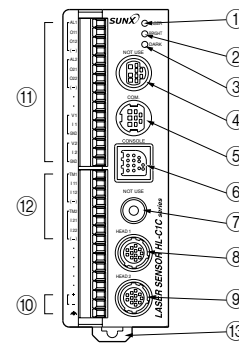

	Description	Function
①	Laser emission indicator (Green LED)	Lights up during laser emission from sensor head 1 or sensor head 2, or immediately before laser emission.
②	BRIGHT indicator (Red LED)	Lights up upon disabled measurement due to excessive light at sensor head 1 or 2.
③	DARK indicator (Red LED)	Lights up upon disabled measurement due to insufficient light at sensor head 1 or 2.
④	_____	Cannot be used. This port is for adjustment at the factory before shipping.
⑤	COM. port	Used for RS-232C communications with a personal computer.
⑥	Connector for compact console	This enables measurement values to be displayed using the compact console and connection of the compact console exclusive connection cable when setting each setting.
⑦	_____	Cannot be used. This port is for adjustment at the factory before shipping.
⑧	Sensor head 1 connector	The controller operates the sensor head connected to this connector as sensor head 1.
⑨	Sensor head 2 connector	The controller operates the sensor head connected to this connector as sensor head 2.
⑩	Power supply terminal	Supplies 24 V DC. There are power supply terminals on input terminal block.
⑪	External output terminal	_____
⑫	External input terminal	_____
⑬	DIN rail mounting hook	Can be mounted on a 35 mm 1.378 in width DIN rail quickly.

HL-C1

PRECAUTIONS FOR PROPER USE

Functions

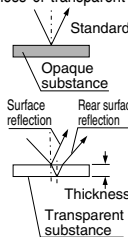
Function	Details
Data buffering function	<ul style="list-style-type: none"> It is possible to accumulate data up to 48,000 data into a controller temporarily in order to capture measurement data into a PC. All the accumulated data can be captured into the PC with HL-C1aIM. Used for reading and storing all data including the verification of measurement data when introduced as well as all post-measurement data.
Hold function	<ul style="list-style-type: none"> NORM. (no hold): Outputs the amount of displacement from the measurement center distance in real time. Ordinarily, this mode is used. P-P: This mode holds and outputs the difference between the maximum value and the minimum value. It is used for vibration measurements or eccentricity. PEAK: Holds and outputs the maximum measurement value. VALLEY: Holds and outputs the minimum measurement value.
Zero set function	<ul style="list-style-type: none"> The measurement value and analog output at the timing of zero setting are forcibly reset to zero. Use this function to reset the measurement value of the reference object to zero and measure the displacement amount or make a judgment of the upper or lower limit.
Timing function	<ul style="list-style-type: none"> The judgment outputs (O1 and O2) immediately before the mode selection, measurement value and analog output are held in the timing input mode. Laser emission can be halted or continued according to a setting. Add the input in other than the measurement or judgment state to eliminate unnecessary output changes or laser radiation.
Display hold function	<ul style="list-style-type: none"> Only the measurement value displayed on the compact console is held. Use this function to read a momentary measurement value.
Switching functions for sampling rate	<ul style="list-style-type: none"> In cases where objects with a low reflected light amount, such as black rubber, are measured, stable measurements can be taken by extending the sampling rate and enabling a sufficient amount of light to be picked up by the sensor. If the sampling rate is short and not enough light can be picked up, the sensor enters the alarm state, so switch the sampling rate to a longer duration setting. The sampling rate can be switched among 7 different rates. (100 μs / 144 μs / 200 μs / 255 μs / 332 μs / 498 μs / 1,000 μs)
Calculation function	<ul style="list-style-type: none"> This function enables the unit to perform the following calculations: <ul style="list-style-type: none"> <Calculation formulas when performing independent measurements> L1 + K1A: normal output state L2 + K2B: normal output state L1 - K1A: reverses the polarity of the measured value L2 - K2B: reverses the polarity of the measured value <Calculation formulas when performing calculation measurements> L + K (A + B): addition L - K (A + B): used when measuring thickness L + K (A - B): subtraction, used when measuring level differences L - K (A - B): used when reversing the polarity of a subtraction output A: the value measured by sensor head 1 B: the value measured by sensor head 2 L: the amount of offset for the measured value K: the coefficient used to adjust the ratio of displacement changes
Switching functions for measurement mode	<ul style="list-style-type: none"> The measurement mode (diffuse reflective / specular reflective) can be switched between these two modes, in accordance with the sensor head selected, based on the measurement object. <ul style="list-style-type: none"> Diffuse reflective mode: used when measuring without a mirror surface or not transparent. Specular reflective mode: used when measuring a substance with a mirror surface or that is transparent. When in specular reflective mode, the measurement object can be selected from the following options: <ul style="list-style-type: none"> Standard: used when measuring the mirror surfaces of opaque substance such as metal, etc. Front: used when measuring the surface of transparent substance such as glass, etc. Rear: used when measuring the rear surface of transparent substance such as glass, etc. Thickness: used when measuring the thickness of transparent substance, such as glass. <div style="display: flex; align-items: flex-start;"> <div style="border-left: 1px solid black; border-right: 1px solid black; padding: 5px; margin-right: 10px;"> <p>The refraction angle is compensated to 1.55. There is a limitation in measurable thickness. Thickness measurement guidelines for common glass sheets: General-purpose model — thicknesses 1.2 mm 0.047 in or more High precision model — thicknesses 0.5 mm 0.020 in or more</p> </div>  </div>
Switching function for average number of samples	<ul style="list-style-type: none"> If the measured values are subject to rapid fluctuation, then increasing the average number of samples will allow the unit to compensate for these fluctuations, enabling stable measurements to be obtained. The average number of samples can be selected from among 16 steps, ranging from OFF to 32,768 times.

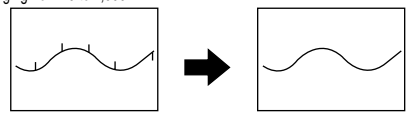
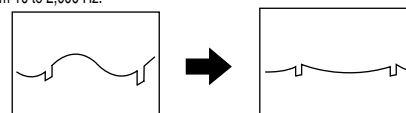
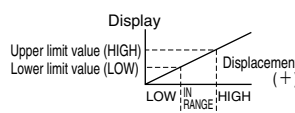
Function	Details																																																								
Low-pass filter function	<ul style="list-style-type: none"> For example, if the surface conditions of a metal object cause noise that interferes with accurate measurement, the use of the low-pass filter function will reduce the effects of noise and allow for the stable measurement of displacement. 9 independent cutoff frequencies can be selected, OFF or ranging from 10 to 2,000 Hz. 																																																								
High-pass filter function	<ul style="list-style-type: none"> If joints or grooves are being measured in the midst of great changes such as runout or inclination in an eccentric rotating object etc., this setting minimizes the effects of gradual changes and makes it possible to detect joints or grooves. 9 independent cutoff frequencies can be selected, OFF or ranging from 10 to 2,000 Hz. 																																																								
Judgment output selection function	<ul style="list-style-type: none"> The judgment output O1, O2 (NC) can be selected from the four types listed in the table below. <div style="display: flex; align-items: center;"> <div style="margin-right: 20px;"> <p>Display</p>  <p>Upper limit value (HIGH) Lower limit value (LOW)</p> </div> <table border="1" style="border-collapse: collapse;"> <thead> <tr> <th colspan="2">Logical output and judgment</th> </tr> <tr> <th>Output</th> <th>Judgment</th> </tr> <tr> <th></th> <th>LOW IN RANGE HIGH</th> </tr> </thead> <tbody> <tr> <td>O1</td> <td>1 0 1</td> </tr> <tr> <td>O2</td> <td>0 1 1</td> </tr> </tbody> </table> <div style="margin-left: 20px;"> <p>1: Output state</p> <table border="1" style="border-collapse: collapse;"> <tbody> <tr> <td>O1</td> <td>LOW</td> <td>Open</td> <td>Close</td> <td>Close</td> <td>Select to distinguish the side of the measurement value around the lower limit value setting. The upper limit setting is ignored.</td> </tr> <tr> <td>O2</td> <td>LOW</td> <td>Open</td> <td>Close</td> <td>Open</td> <td></td> </tr> <tr> <td>O1</td> <td>LOW</td> <td>Open</td> <td>Close</td> <td>Open</td> <td>Select to distinguish between the upper limit and lower limit when the measurement value exceeds either limit.</td> </tr> <tr> <td>O2</td> <td>HIGH</td> <td>Open</td> <td>Close</td> <td>Close</td> <td></td> </tr> <tr> <td>O1</td> <td>LOW or HIGH</td> <td>Open</td> <td>Close</td> <td>Open</td> <td>Select to distinguish between deviation from the upper or lower limit value and containment in the range. Use this for OK / NG judgment.</td> </tr> <tr> <td>O2</td> <td>IN RANGE</td> <td>Open</td> <td>Close</td> <td>Close</td> <td></td> </tr> <tr> <td>O1</td> <td rowspan="2">LOGIC</td> <td>Open</td> <td>Close</td> <td>Open</td> <td rowspan="2">Select to distinguish whether the measurement value is below the lower limit value, above the upper limit value or within the range. Build an external logical circuit to judge two outputs and separate them into three states.</td> </tr> <tr> <td>O2</td> <td>Open</td> <td>Close</td> <td>Close</td> </tr> </tbody> </table> </div> </div> <p>■ : Output state (excluding hysteresis area) ※The output state is the state in which the terminal is open. (NC)</p>	Logical output and judgment		Output	Judgment		LOW IN RANGE HIGH	O1	1 0 1	O2	0 1 1	O1	LOW	Open	Close	Close	Select to distinguish the side of the measurement value around the lower limit value setting. The upper limit setting is ignored.	O2	LOW	Open	Close	Open		O1	LOW	Open	Close	Open	Select to distinguish between the upper limit and lower limit when the measurement value exceeds either limit.	O2	HIGH	Open	Close	Close		O1	LOW or HIGH	Open	Close	Open	Select to distinguish between deviation from the upper or lower limit value and containment in the range. Use this for OK / NG judgment.	O2	IN RANGE	Open	Close	Close		O1	LOGIC	Open	Close	Open	Select to distinguish whether the measurement value is below the lower limit value, above the upper limit value or within the range. Build an external logical circuit to judge two outputs and separate them into three states.	O2	Open	Close	Close
Logical output and judgment																																																									
Output	Judgment																																																								
	LOW IN RANGE HIGH																																																								
O1	1 0 1																																																								
O2	0 1 1																																																								
O1	LOW	Open	Close	Close	Select to distinguish the side of the measurement value around the lower limit value setting. The upper limit setting is ignored.																																																				
O2	LOW	Open	Close	Open																																																					
O1	LOW	Open	Close	Open	Select to distinguish between the upper limit and lower limit when the measurement value exceeds either limit.																																																				
O2	HIGH	Open	Close	Close																																																					
O1	LOW or HIGH	Open	Close	Open	Select to distinguish between deviation from the upper or lower limit value and containment in the range. Use this for OK / NG judgment.																																																				
O2	IN RANGE	Open	Close	Close																																																					
O1	LOGIC	Open	Close	Open	Select to distinguish whether the measurement value is below the lower limit value, above the upper limit value or within the range. Build an external logical circuit to judge two outputs and separate them into three states.																																																				
O2		Open	Close	Close																																																					
Hysteresis setting function	<ul style="list-style-type: none"> Optional hysteresis settings can be selected for both the upper and lower limits. 																																																								
Analog output setting function	<ul style="list-style-type: none"> This function causes the output to correspond to the measurement value wanted at an analog output of +5 V (20 mA) and at -5 V (4 mA). It can be used for scaling of the analog output or for making the output greater or smaller, etc. When this function is used, the analog output corresponding to measurement values ranging between, for example, 70 to 90 mm 2.756 to 3.543 in, can be assigned to outputs ranging from -5 V (for 70 mm 2.756 in) to +5 V (for 90 mm 3.543 in). 																																																								
Analog Output switching function during alarm	<ul style="list-style-type: none"> You can switch between the data having been output immediately before and a fixed value as an analog output issued when measurement is disabled (with an alarm output) due to an excessive or insufficient amount of light or deviation from the range. When the fixed value setting is selected, either the maximum value (voltage output: +10.9 V, current output: 29.5 mA) or minimum value (voltage output: -10.9 V, current output: 0mA) of the analog output is issued during an alarm. 																																																								
Input selection function	<ul style="list-style-type: none"> The timing signal at the input terminal functions as an input upon a short circuit by default setting. Use this function to activate the input upon an open circuit. 																																																								
Calibration function	<ul style="list-style-type: none"> Measurement errors may occur due to the color, material or surface condition of the object being measured. These differences can be compensated for through calibration. The calibration function allows the span and shift to be set for each sensor head. There are two ways to set these values. One is to conduct auto setting by moving a piece of the object past sensors and the other is to input previously measured values directly. 																																																								
Display Light Received Function	<ul style="list-style-type: none"> This function displays the peak level of light received at the measuring point. The usage of this function when installing sensor heads allows the optimum marginal increment to be used as the level of light received for measurement. 																																																								
Save function	<ul style="list-style-type: none"> This function saves all setting data except for the timing input state and display hold state. 																																																								

DIMENSIONS (Unit: mm in)

HL-C108B-BK HL-C108F-BK Sensor head

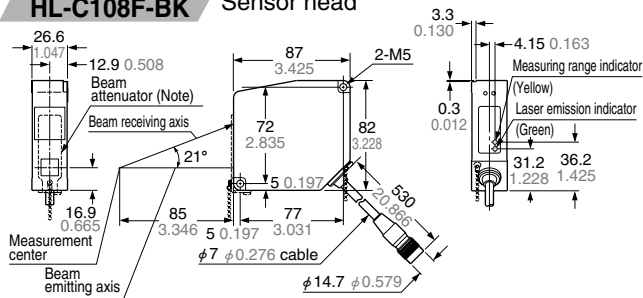

Note: There is not beam attenuator on IEC / JIS standards conforming type.

HL-C108B HL-C108F Sensor head

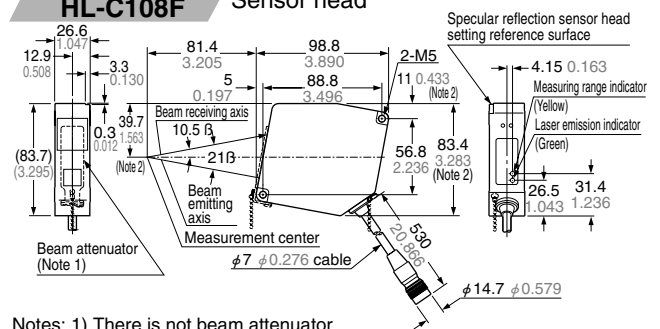

Notes: 1) There is not beam attenuator on IEC / JIS standards conforming type.
2) Figure shows standard installation level dimensions.

HL-C105B-BK HL-C105F-BK Sensor head

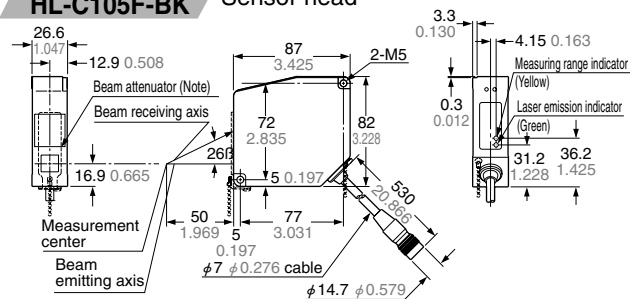

Note: There is not beam attenuator on IEC / JIS standards conforming type.

HL-C105B HL-C105F Sensor head

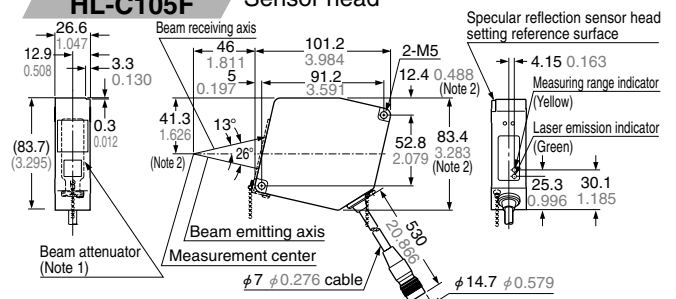

Notes: 1) There is not beam attenuator on IEC / JIS standards conforming type.
2) Figure shows standard installation level dimensions.

HL-C1C-M Controller

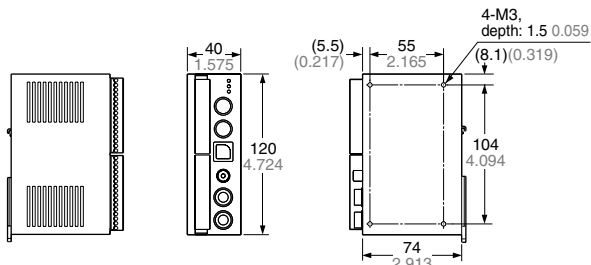

HL-C1DP-E Compact console

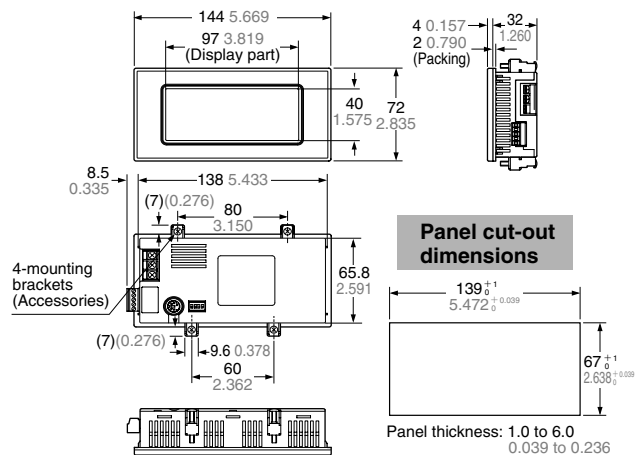

HL-C1CCJ Extension cable

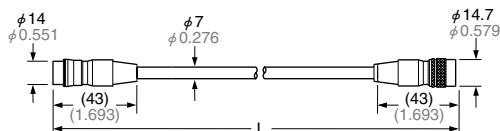

• Length: L

Model No.	L (mm in)
HL-C1CCJ2	2,000 78.740
HL-C1CCJ5	5,000 196.850
HL-C1CCJ10	10,000 393.700
HL-C1CCJ20	20,000 787.400
HL-C1CCJ30	30,000 1181.100