

# GX-U SERIES GX-FU SERIES GX-N SERIES

Related Information	■ General terms and conditions..... F-7	■ Sensor selection guide..... P.803~
	■ Glossary of terms..... P.1482~	■ General precautions ..... P.1485~

- FIBER SENSORS
- LASER SENSORS
- PHOTOELECTRIC SENSORS
- MICRO PHOTOELECTRIC SENSORS
- AREA SENSORS
- LIGHT CURTAINS / SAFETY COMPONENTS
- PRESSURE / FLOW SENSORS
- INDUCTIVE PROXIMITY SENSORS**
- PARTICULAR USE SENSORS
- SENSOR OPTIONS
- SIMPLE WIRE-SAVING UNITS
- WIRE-SAVING SYSTEMS
- MEASUREMENT SENSORS
- STATIC ELECTRICITY PREVENTION DEVICES
- LASER MARKERS
- PLC
- HUMAN MACHINE INTERFACES
- ENERGY CONSUMPTION VISUALIZATION COMPONENTS
- FA COMPONENTS
- MACHINE VISION SYSTEMS
- UV CURING SYSTEMS

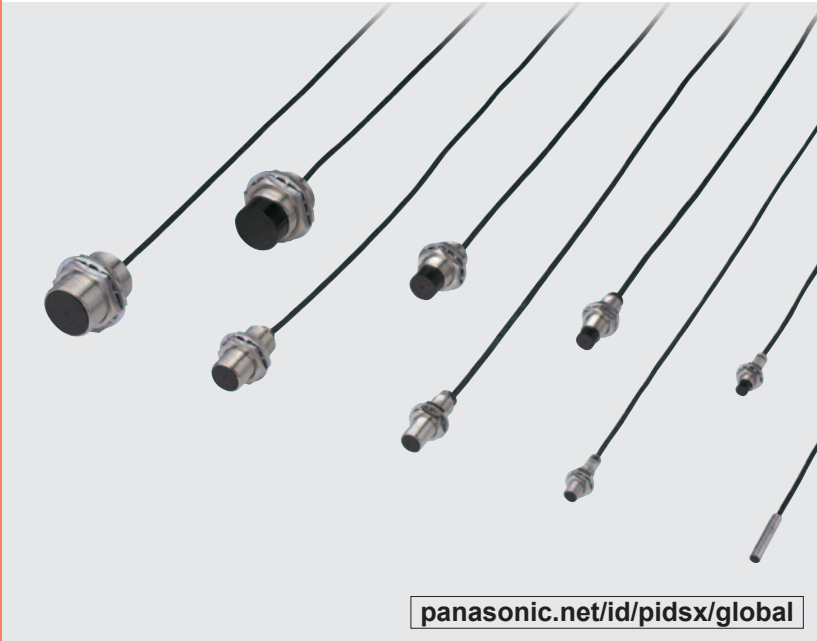

[panasonic.net/id/pidsx/global](http://panasonic.net/id/pidsx/global)



## Improved performance, environmental resistance, and operability

### BASIC PERFORMANCE

#### About four times more robust in tightening

As the sensor can be securely tightened, it does not get loose due to vibration or shock.



#### Long sensing range

**GX-12MLU(B)/N12ML(B)** feature 1.6 times longer sensing range than previous model [**GX-12ML(B)**]. It can be mounted at a sufficient distance from the object.

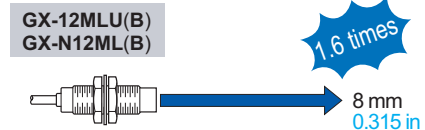

### ENVIRONMENTAL RESISTANCE

#### Spatter-resistant type available DC 2-wire type

As the enclosure is entirely coated by fluorine resin, the sensor can be safely used at a place where welding spatters fly around. Both the pigtail cable and the mating cable are also spatter-resistant.



### FUNCTIONS

#### Visible 2-color indicator

The normally open type [**GX-(F)□U(-J)**] is equipped with a 2-color indicator. (The normally closed type and **GX-N□** have the operation indicator instead.) The operation is easily observable from any direction because the entire sensor tail (transparent, **GX-5SU(B)**: enclosure) lights up.



### VARIETIES

#### Compact size: ø5.4 mm ø0.213 in

**GX-5SU(B)** is just 5.4 mm 0.213 in in diameter, the smallest in existing DC two-wire sensors. It saves space.

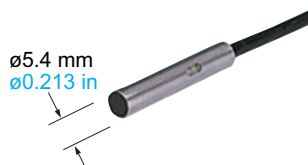

#### Simple wiring

**DC 2-wire type**

The wiring cost of the DC 2-wire type is 2/3 that of a conventional model. Further, each of **GX-12M(L)U(B)**, **GX-18M(L)U(B)**, **GX-30M(L)U(B)** is available as a pigtailed model that makes replacement easy and quick.

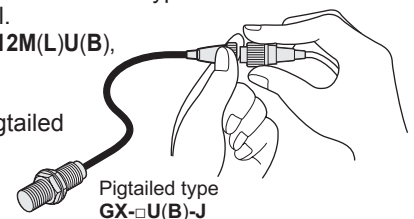

- Selection Guide
- Amplifier Built-in
- Amplifier-separated
- GX-F/H
- GXL
- GL
- G-M
- GX-U/GX-FU/GX-N**
- GX

**APPLICATIONS**

**Detecting traveling aluminum pallets**

It can reliably detect even aluminum pallets because of its long sensing range.

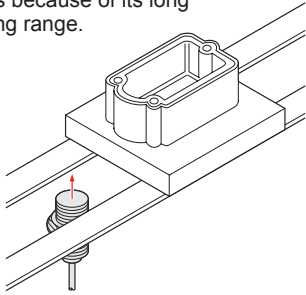

**Controlling depth of drilling**

By detecting the dog, the sensor decides the depth of the drilled hole.

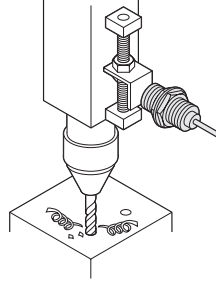

**Positioning object at welding station (GX-F□U-J only)**

It can be safely used even where welding sparks (spatter) fly around.

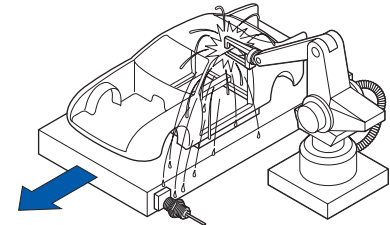

**ORDER GUIDE**

**DC 2-wire type**

Type	Appearance (mm in)	Sensing range (Note)	Model No.	Output	Output operation	
DC 2-wire	Non-threaded type	<p>1.5 mm 0.059 in ← Maximum operation distance (0 to 1.2 mm 0 to 0.047 in) ← Stable sensing range</p>	<b>GX-5SU</b>	Non-contact DC 2-wire type	Normally open	
			<b>GX-5SUB</b>		Normally closed	
	Shielded type	Threaded type	<p>2 mm 0.079 in (0 to 1.6 mm 0 to 0.063 in)</p>		<b>GX-8MU</b>	Normally open
					<b>GX-8MUB</b>	Normally closed
		Threaded type	<p>3 mm 0.118 in (0 to 2.4 mm 0 to 0.094 in)</p>		<b>GX-12MU</b>	Normally open
					<b>GX-12MUB</b>	Normally closed
			<p>7 mm 0.276 in (0 to 5.6 mm 0 to 0.220 in)</p>		<b>GX-18MU</b>	Normally open
					<b>GX-18MUB</b>	Normally closed
	Non-shielded type	Threaded type	<p>10 mm 0.394 in (0 to 8 mm 0 to 0.315 in)</p>		<b>GX-30MU</b>	Normally open
					<b>GX-30MUB</b>	Normally closed
		Threaded type	<p>4 mm 0.157 in (0 to 3.2 mm 0 to 0.126 in)</p>		<b>GX-8MLU</b>	Normally open
					<b>GX-8MLUB</b>	Normally closed
<p>8 mm 0.315 in (0 to 6.4 mm 0 to 0.252 in)</p>			<b>GX-12MLU</b>	Normally open		
			<b>GX-12MLUB</b>	Normally closed		
<p>15 mm 0.591 in (0 to 12 mm 0 to 0.472 in)</p>			<b>GX-18MLU</b>	Normally open		
			<b>GX-18MLUB</b>	Normally closed		
<p>22 mm 0.866 in (0 to 17.6 mm 0 to 0.693 in)</p>	<b>GX-30MLU</b>	Normally open				
	<b>GX-30MLUB</b>	Normally closed				

Note: The maximum operation distance stands for the maximum distance for which the sensor can detect the standard sensing object. The stable sensing range stands for the sensing range for which the sensor can stably detect the standard sensing object even if there is an ambient temperature drift and/or supply voltage fluctuation.

- FIBER SENSORS
- LASER SENSORS
- PHOTO-ELECTRIC SENSORS
- MICRO PHOTO-ELECTRIC SENSORS
- AREA SENSORS
- LIGHT CURTAINS / SAFETY COMPONENTS
- PRESSURE / FLOW SENSORS
- INDUCTIVE PROXIMITY SENSORS
- PARTICULAR USE SENSORS
- SENSOR OPTIONS
- SIMPLE WIRE-SAVING UNITS
- WIRE-SAVING SYSTEMS
- MEASUREMENT SENSORS
- STATIC ELECTRICITY PREVENTION DEVICES
- LASER MARKERS
- PLC
- HUMAN MACHINE INTERFACES
- ENERGY CONSUMPTION VISUALIZATION COMPONENTS
- FA COMPONENTS
- MACHINE VISION SYSTEMS
- UV CURING SYSTEMS
- Selection Guide
- Amplifier Built-in
- Amplifier-separated
- GX-F/H**
- GXL**
- GL**
- GX-M**
- GX-U/GX-FU/GX-N**
- GX**

**ORDER GUIDE**

**Spatter-resistant of DC 2-wire type (Pigtailed type)**

Type	Appearance (mm in)	Sensing range (Note)	Model No.	Output	Output operation
DC 2-wire Shielded type Threaded type		3 mm 0.118 in ← Maximum operation distance (0 to 2.4 mm 0 to 0.094 in) ← Stable sensing range	<b>GX-F12MU-J</b>	Non-contact DC 2-wire type	Normally open
		7 mm 0.276 in (0 to 5.6 mm 0 to 0.220 in)	<b>GX-F18MU-J</b>		
		10 mm 0.394 in (0 to 8 mm 0 to 0.315 in)	<b>GX-F30MU-J</b>		

Note: The maximum operation distance stands for the maximum distance for which the sensor can detect the standard sensing object.  
The stable sensing range stands for the sensing range for which the sensor can stably detect the standard sensing object even if there is an ambient temperature drift and/or supply voltage fluctuation.

• Mating cable

Model No.	Description
<b>CN-22G-C2</b>	Length: 2 m 6.562 ft 0.3 mm <sup>2</sup> 2-core flame-resistant, spatter-resistant cable with connector at one end
<b>CN-22G-C5</b>	Length: 5 m 16.404 ft Cable outer diameter: ø3.6 mm ø0.142 in

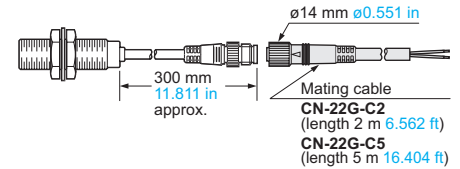

**DC 3-wire type**

Type	Appearance (mm in)	Sensing range (Note)	Model No.	Output	Output operation
DC 3-wire Shielded type Threaded type		3 mm 0.118 in ← Maximum operation distance (0 to 2.4 mm 0 to 0.094 in) ← Stable sensing range	<b>GX-N12M</b>	NPN open-collector transistor	Normally open
			<b>GX-N12MB</b>		Normally closed
		7 mm 0.276 in (0 to 5.6 mm 0 to 0.220 in)	<b>GX-N18M</b>		Normally open
			<b>GX-N18MB</b>		Normally closed
		10 mm 0.394 in (0 to 8 mm 0 to 0.315 in)	<b>GX-N30M</b>		Normally open
			<b>GX-N30MB</b>		Normally closed
DC 3-wire Non-shielded type Threaded type		8 mm 0.315 in (0 to 6.4 mm 0 to 0.252 in)	<b>GX-N12ML</b>	Normally open	
			<b>GX-N12MLB</b>	Normally closed	
		15 mm 0.591 in (0 to 12 mm 0 to 0.472 in)	<b>GX-N18ML</b>	Normally open	
			<b>GX-N18MLB</b>	Normally closed	
		22 mm 0.866 in (0 to 17.6 mm 0 to 0.693 in)	<b>GX-N30ML</b>	Normally open	
			<b>GX-N30MLB</b>	Normally closed	

Note: The maximum operation distance stands for the maximum distance for which the sensor can detect the standard sensing object.  
The stable sensing range stands for the sensing range for which the sensor can stably detect the standard sensing object even if there is an ambient temperature drift and/or supply voltage fluctuation.

FIBER SENSORS  
LASER SENSORS  
PHOTO-ELECTRIC SENSORS  
MICRO PHOTO-ELECTRIC SENSORS  
AREA SENSORS  
LIGHT CURTAINS / SAFETY COMPONENTS  
PRESSURE / FLOW SENSORS  
INDUCTIVE PROXIMITY SENSORS  
PARTICULAR USE SENSORS  
SENSOR OPTIONS  
SIMPLE WIRE-SAVING UNITS  
WIRE-SAVING SYSTEMS  
MEASURE-MENT SENSORS  
STATIC ELECTRICITY PREVENTION DEVICES  
LASER MARKERS  
PLC  
HUMAN MACHINE INTERFACES  
ENERGY CONSUMPTION VISUALIZATION COMPONENTS  
FA COMPONENTS  
MACHINE VISION SYSTEMS  
UV CURING SYSTEMS  
Selection Guide  
Amplifier Built-in  
Amplifier-separated  
GX-F/H  
GXL  
GL  
GX-M  
GX-U/GX-FU/GX-N  
GX

## ORDER GUIDE

### 5 m 16.404 ft cable length type

5 m 16.404 ft cable length type (standard: 2 m 6.562 ft) is also available for cable type. When ordering this type, suffix “-C5” to the model No. (e.g.) 5 m 16.404 ft cable length type of GX-5SU is “GX-5SU-C5”.

### Pigtailed type

Pigtailed type (standard: cable type) is also available for DC 2-wire type.

#### • Table of Model Nos.

Type		Standard	Pigtailed type (Note)	
DC 2-wire	Shielded type	Non-threaded type	GX-5SU	_____
			GX-5SUB	_____
		Threaded type	GX-8MU	_____
			GX-8MUB	_____
			GX-12MU	GX-12MU-J
			GX-12MUB	GX-12MUB-J
			GX-18MU	GX-18MU-J
			GX-18MUB	GX-18MUB-J
			GX-30MU	GX-30MU-J
	GX-30MUB	GX-30MUB-J		
	Non-shielded type	Threaded type	GX-8MLU	_____
			GX-8MLUB	_____
			GX-12MLU	GX-12MLU-J
			GX-12MLUB	GX-12MLUB-J
			GX-18MLU	GX-18MLU-J
			GX-18MLUB	GX-18MLUB-J
			GX-30MLU	GX-30MLU-J
			GX-30MLUB	GX-30MLUB-J

Note: Please order the suitable mating cable separately for pigtailed type.

#### • Mating cable

Model No.	Description	
<b>CN-22G-C2</b>	Length: 2 m 6.562 ft	0.3 mm <sup>2</sup> 2-core flame-resistant, spatter-resistant cable with connector at one end Cable outer diameter: $\varnothing$ 3.6 mm $\varnothing$ 0.142 in
<b>CN-22G-C5</b>	Length: 5 m 16.404 ft	
<b>CN-24-C2</b>	Length: 2 m 6.562 ft	0.34 mm <sup>2</sup> 4-core cabtyre cable with connector at one end Cable outer diameter: $\varnothing$ 5.0 mm $\varnothing$ 0.197 in
<b>CN-24-C5</b>	Length: 5 m 16.404 ft	

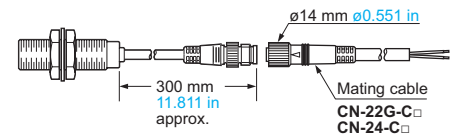

- FIBER SENSORS
- LASER SENSORS
- PHOTO-ELECTRIC SENSORS
- MICRO PHOTO-ELECTRIC SENSORS
- AREA SENSORS
- LIGHT CURTAINS / SAFETY COMPONENTS
- PRESSURE / FLOW SENSORS
- INDUCTIVE PROXIMITY SENSORS
- PARTICULAR USE SENSORS
- SENSOR OPTIONS
- SMILE WIRE-SAVING UNITS
- WIRE-SAVING SYSTEMS
- MEASURE-MENT SENSORS
- STATIC ELECTRICITY PREVENTION DEVICES
- LASER MARKERS
- PLC
- HUMAN MACHINE INTERFACES
- ENERGY CONSUMPTION VISUALIZATION COMPONENTS
- FA COMPONENTS
- MACHINE VISION SYSTEMS
- UV CURING SYSTEMS

- Selection Guide
- Amplifier Built-in
- Amplifier-separated

- GX-F/H
- GXL
- GL
- GX-M
- GX-U/GX-FU/GX-N
- GX

**OPTIONS**

Designation	Model No.	Description	
Sensor mounting bracket	<b>MS-SS5</b>	For <b>GX-5SU(B)</b>	The sensor is easily mounted with this bracket.
Protection cover	<b>MS-H12</b>	For <b>GX-12MU(B)</b> For <b>GX-N12M(B)</b>	It protects the sensing surface from welding sparks (spatter), etc.
	<b>MS-H18</b>	For <b>GX-18MU(B)</b> For <b>GX-N18M(B)</b>	
	<b>MS-H30</b>	For <b>GX-30MU(B)</b> For <b>GX-N30M(B)</b>	

**Sensor mounting bracket**

- **MS-SS5**

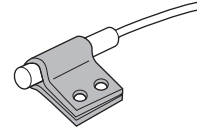

**Protection cover**

- **MS-H12**
- **MS-H18**
- **MS-H30**

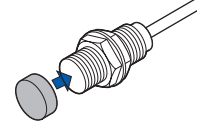

**SPECIFICATIONS**

**DC 2-wire type**

Item	Type	Shielded type					Non-shielded type				
		Model No.	Non-threaded type		Threaded type			Threaded type			
			Normally open	<b>GX-5SU</b>	<b>GX-8MU</b>	<b>GX-12MU</b>	<b>GX-18MU</b>	<b>GX-30MU</b>	<b>GX-8MLU</b>	<b>GX-12MLU</b>	<b>GX-18MLU</b>
	Normally closed	<b>GX-5SUB</b>	<b>GX-8MUB</b>	<b>GX-12MUB</b>	<b>GX-18MUB</b>	<b>GX-30MUB</b>	<b>GX-8MLUB</b>	<b>GX-12MLUB</b>	<b>GX-18MLUB</b>	<b>GX-30MLUB</b>	
Max. operation distance (Note 2)		1.5 mm <b>0.059 in</b> ±10 %	2 mm <b>0.079 in</b> ±10 %	3 mm <b>0.118 in</b> ±10 %	7 mm <b>0.276 in</b> ±10 %	10 mm <b>0.394 in</b> ±10 %	4 mm <b>0.157 in</b> ±10 %	8 mm <b>0.315 in</b> ±10 %	15 mm <b>0.591 in</b> ±10 %	22 mm <b>0.866 in</b> ±10 %	
Stable sensing range (Note 2)		0 to 1.2 mm <b>0 to 0.047 in</b>	0 to 1.6 mm <b>0 to 0.063 in</b>	0 to 2.4 mm <b>0 to 0.094 in</b>	0 to 5.6 mm <b>0 to 0.220 in</b>	0 to 8 mm <b>0 to 0.315 in</b>	0 to 3.2 mm <b>0 to 0.126 in</b>	0 to 6.4 mm <b>0 to 0.252 in</b>	0 to 12 mm <b>0 to 0.472 in</b>	0 to 17.6 mm <b>0 to 0.693 in</b>	
Standard sensing object		Iron sheet 6 × 6 × t 1 mm <b>0.236 × 0.236 × t 0.039 in</b>	Iron sheet 8 × 8 × t 1 mm <b>0.315 × 0.315 × t 0.039 in</b>	Iron sheet 12 × 12 × t 1 mm <b>0.472 × 0.472 × t 0.039 in</b>	Iron sheet 18 × 18 × t 1 mm <b>0.709 × 0.709 × t 0.039 in</b>	Iron sheet 30 × 30 × t 1 mm <b>1.181 × 1.181 × t 0.039 in</b>	Iron sheet 20 × 20 × t 1 mm <b>0.787 × 0.787 × t 0.039 in</b>	Iron sheet 30 × 30 × t 1 mm <b>1.181 × 1.181 × t 0.039 in</b>	Iron sheet 50 × 50 × t 1 mm <b>1.969 × 1.969 × t 0.039 in</b>	Iron sheet 70 × 70 × t 1 mm <b>2.756 × 2.756 × t 0.039 in</b>	
Hysteresis		20 % or less of operation distance (with standard sensing object)									
Supply voltage		12 to 24 V DC <sup>+10</sup> / <sub>-15</sub> % Ripple P-P 10 % or less									
Current consumption (Note 3)		0.8 mA or less									
Output		Non-contact DC 2-wire type • Load current: 3 to 70 mA (Note 4) • Residual voltage: 3 V or less (Note 5)									
Short-circuit protection		Incorporated									
Max. response frequency		1.7 kHz	1.2 kHz	1.2 kHz	500 Hz	350 Hz	1 kHz	650 Hz	350 Hz	220 Hz	
Operation indicator		Normally closed type: Orange LED (lights up when the output is ON)									
2-color indicator		Normally open type: Lights up in green under stable sensing condition, lights up in orange under unstable sensing condition									
Environmental resistance	Protection	IP67 (IEC), IP67G (Note 6)									
	Ambient temperature	-25 to +70 °C <b>-13 to +158 °F</b> , Storage: -30 to +80 °C <b>-22 to +176 °F</b>									
	Ambient humidity	45 to 85 % RH, Storage: 35 to 95 % RH									
	Voltage withstandability	1,000 V AC for one min. between all supply terminals connected together and enclosure									
	Insulation resistance	50 MΩ, or more, with 250 V DC megger between all supply terminals connected together and enclosure									
	Vibration resistance	10 to 55 Hz frequency, 1.5 mm <b>0.059 in</b> amplitude in X, Y and Z directions for two hours each									
Shock resistance	1,000 m/s <sup>2</sup> acceleration (100 G approx.) in X, Y and Z directions for three times each										
Sensing range variation	Temperature characteristics	Over ambient temperature range -25 to +70 °C <b>-13 to +158 °F</b> : within ±10 % of sensing range at +20 °C <b>+68 °F</b>									
	Voltage characteristics	Within ±2 % for ±10 % fluctuation of the supply voltage									
Material		Enclosure: Brass (Nickel plated) [Stainless steel (SUS303) for <b>GX-5SU(B)</b> , <b>GX-8MU(B)</b> and <b>GX-8MLU(B)</b> ] Sensing part: Nylon [Polyallylate for <b>GX-5SU(B)</b> ], Indicator part: Nylon [excluding <b>GX-5SU(B)</b> ]									
Cable		0.3 mm <sup>2</sup> [0.15 mm <sup>2</sup> for <b>GX-5SU(B)</b> , <b>GX-8MU(B)</b> and <b>GX-8MLU(B)</b> ] 2-core oil, heat and cold resistant cabtyre cable, 2 m <b>6.562 ft</b> long									
Cable extension		Extension up to total 50 m <b>164.042 ft</b> is possible with 0.3 mm <sup>2</sup> , or more, cable.									
Weight (Note 7)		Net weight: 20 g approx.	Net weight: 30 g approx.	Net weight: 55 g approx.	Net weight: 95 g approx.	Net weight: 220 g approx.	Net weight: 30 g approx.	Net weight: 55 g approx.	Net weight: 95 g approx.	Net weight: 220 g approx.	
Accessories		Nut: 2 pcs., Toothed lock washer: 1 pc.									

- Notes: 1) Where measurement conditions have not been specified precisely, the conditions used were an ambient temperature of +23 °C **+73.4 °F**.  
 2) The maximum operation distance stands for the maximum distance for which the sensor can detect the standard sensing object.  
 The stable sensing range stands for the sensing range for which the sensor can stably detect the standard sensing object even if there is an ambient temperature drift and/or supply voltage fluctuation.  
 3) It is the leakage current when the output is in the OFF state.  
 4) The maximum load current varies depending on the ambient temperature. Refer to "I/O CIRCUIT AND WIRING DIAGRAMS (p.856)" for more details.  
 5) When the cable is extended, the residual voltage becomes larger.  
 6) If using the sensor in an environment where cutting oil droplets splatter, the sensor may be deteriorated due to added substances in the oil.  
 Please check the resistivity of the sensor against the cutting oil you are using beforehand.  
 7) The weight of the threaded type includes the weight of two nuts and one toothed lock washer.

## SPECIFICATIONS

### Spatter-resistant of DC 2-wire type (Pigtailed type)

Item	Model No.	Type		
		Shielded type		Threaded type
		<b>GX-F12MU-J</b>	<b>GX-F18MU-J</b>	<b>GX-F30MU-J</b>
Max. operation distance (Note 2)		3 mm <b>0.118 in</b> ±10 %	7 mm <b>0.276 in</b> ±10 %	10 mm <b>0.394 in</b> ±10 %
Stable sensing range (Note 2)		0 to 2.4 mm <b>0 to 0.094 in</b>	0 to 5.6 mm <b>0 to 0.220 in</b>	0 to 8 mm <b>0 to 0.315 in</b>
Standard sensing object		Iron sheet 12 × 12 × t 1 mm <b>0.472 × 0.472 × t 0.039 in</b>	Iron sheet 18 × 18 × t 1 mm <b>0.709 × 0.709 × t 0.039 in</b>	Iron sheet 30 × 30 × t 1 mm <b>1.181 × 1.181 × t 0.039 in</b>
Hysteresis		20 % or less of operation distance (with standard sensing object)		
Supply voltage		12 to 24 V DC $\begin{smallmatrix} +10 \\ -15 \end{smallmatrix}$ % Ripple P-P 10 % or less		
Current consumption (Note 3)		0.8 mA or less		
Output		Non-contact DC 2-wire type • Load current: 3 to 70 mA (Note 4) • Residual voltage: 3 V or less (Note 5)		
	Output operation	Normally open		
	Short-circuit protection	Incorporated		
Max. response frequency		1.2 kHz	500 Hz	350 Hz
2-color indicator		Lights up in green under stable sensing condition, lights up in orange under unstable sensing condition		
Environmental resistance	Protection	IP67 (IEC), IP67G (Note 6)		
	Ambient temperature	-25 to +70 °C <b>-13 to +158 °F</b> , Storage: -30 to +80 °C <b>-22 to +176 °F</b>		
	Ambient humidity	45 to 85 % RH, Storage: 35 to 95 % RH		
	Voltage withstandability	1,000 V AC for one min. between all supply terminals connected together and enclosure		
	Insulation resistance	50 MΩ, or more, with 250 V DC megger between all supply terminals connected together and enclosure		
	Vibration resistance	10 to 55 Hz frequency, 1.5 mm <b>0.059 in</b> amplitude in X, Y and Z directions for two hours each		
	Shock resistance	1,000 m/s <sup>2</sup> acceleration (100 G approx.) in X, Y and Z directions for three times each		
Sensing range variation	Temperature characteristics	Over ambient temperature range -25 to +70 °C <b>-13 to +158 °F</b> : within ±10 % of sensing range at +20 °C <b>+68 °F</b>		
	Voltage characteristics	Within ±2 % for ±10 % fluctuation of the supply voltage		
Material		Enclosure: Brass (Fluorine resin coated), Sensing part: Polyallylate (Fluorine resin coated), Indicator part: Polyallylate		
Cable		0.3 mm <sup>2</sup> 2-core spatter-resistant cable, 0.3 m <b>0.984 ft</b> long with round type connector		
Cable extension		Extension up to total 50 m <b>164.042 ft</b> is possible with 0.3 mm <sup>2</sup> , or more, cable.		
Weight (Note 7)		Net weight: 35 g approx.	Net weight: 75 g approx.	Net weight: 200 g approx.
Accessories		Nut: 2 pcs. (Fluorine resin coated), Toothed lock washer: 1 pc. (Fluorine resin coated)		

Notes: 1) Where measurement conditions have not been specified precisely, the conditions used were an ambient temperature of +23 °C **+73.4 °F**.

2) The maximum operation distance stands for the maximum distance for which the sensor can detect the standard sensing object.

The stable sensing range stands for the sensing range for which the sensor can stably detect the standard sensing object even if there is an ambient temperature drift and/or supply voltage fluctuation.

3) It is the leakage current when the output is in the OFF state.

4) The maximum load current varies depending on the ambient temperature. Refer to "**I/O CIRCUIT AND WIRING DIAGRAMS** (p.856)" for more details.

5) When the cable is extended, the residual voltage becomes larger.

6) If using the sensor in an environment where cutting oil droplets splatter, the sensor may be deteriorated due to added substances in the oil.

Please check the resistivity of the sensor against the cutting oil you are using beforehand.

7) The given weight includes the weight of two nuts and one toothed lock washer.

FIBER

SENSORS

LASER

SENSORS

PHOTO-

ELECTRIC

SENSORS

MICRO

PHOTO-

ELECTRIC

SENSORS

AREA

SENSORS

LIGHT

CURTAINS /

SAFETY

COMPONENTS

PRESSURE /

FLOW

SENSORS

INDUCTIVE

PROXIMITY

SENSORS

PARTICULAR

USE

SENSORS

SENSOR

OPTIONS

SIMPLE

WIRE-SAVING

UNITS

WIRE-SAVING

SYSTEMS

MEASURE-

MENT

SENSORS

STATIC

ELECTRICITY

PREVENTION

DEVICES

LASER

MARKERS

PLC

HUMAN

MACHINE

INTERFACES

ENERGY

CONSUMPTION

VISUALIZATION

COMPONENTS

FA

COMPONENTS

MACHINE

VISION

SYSTEMS

UV

CURING

SYSTEMS

Selection

Guide

Amplifier

Built-in

Amplifier-

separated

GX-F/H

GXL

GL

GX-M

GX-U/GX-FU/

GX-N

GX

**SPECIFICATIONS**

**DC 3-wire type**

Item	Model No.	Shielded type						Non-shielded type					
		Threaded type						Threaded type					
		GX-N12M	GX-N12MB	GX-N18M	GX-N18MB	GX-N30M	GX-N30MB	GX-N12ML	GX-N12MLB	GX-N18ML	GX-N18MLB	GX-N30ML	GX-N30MLB
Max. operation distance (Note 2)		3 mm <b>0.118 in</b> ±10 %		7 mm <b>0.276 in</b> ±10 %		10 mm <b>0.394 in</b> ±10 %		8 mm <b>0.315 in</b> ±10 %		15 mm <b>0.591 in</b> ±10 %		22 mm <b>0.866 in</b> ±10 %	
Stable sensing range (Note 2)		0 to 2.4 mm <b>0 to 0.094 in</b>		0 to 5.6 mm <b>0 to 0.220 in</b>		0 to 8 mm <b>0 to 0.315 in</b>		0 to 6.4 mm <b>0 to 0.252 in</b>		0 to 12 mm <b>0 to 0.472 in</b>		0 to 17.6 mm <b>0 to 0.693 in</b>	
Standard sensing object		Iron sheet 12 × 12 × t 1 mm <b>0.472 × 0.472 × t 0.039 in</b>		Iron sheet 18 × 18 × t 1 mm <b>0.709 × 0.709 × t 0.039 in</b>		Iron sheet 30 × 30 × t 1 mm <b>1.181 × 1.181 × t 0.039 in</b>		Iron sheet 30 × 30 × t 1 mm <b>1.181 × 1.181 × t 0.039 in</b>		Iron sheet 50 × 50 × t 1 mm <b>1.969 × 1.969 × t 0.039 in</b>		Iron sheet 70 × 70 × t 1 mm <b>2.756 × 2.756 × t 0.039 in</b>	
Hysteresis		20 % or less of operation distance (with standard sensing object)											
Supply voltage		12 to 24 V DC <sup>+10</sup> / <sub>-15</sub> % Ripple P-P 10 % or less											
Current consumption		10 mA or less											
Output		NPN open-collector transistor <ul style="list-style-type: none"> <li>• Maximum sink current: 100 mA</li> <li>• Applied voltage: 30 V DC or less (between output and 0 V)</li> <li>• Residual voltage: 1.5 V or less (at 100 mA sink current) 0.4 V or less (at 16 mA sink current)</li> </ul>											
Output operation		Normally open	Normally closed	Normally open	Normally closed	Normally open	Normally closed	Normally open	Normally closed	Normally open	Normally closed	Normally open	Normally closed
Short-circuit protection		Incorporated											
Max. response frequency		450 Hz		300 Hz		300 Hz		350 Hz		100 Hz		100 Hz	
Operation indicator		Orange LED (lights up when the output is ON)											
Environmental resistance	Protection	IP67 (IEC), IP67G (Note 3)											
	Ambient temperature	-25 to +70 °C <b>-13 to +158 °F</b> , Storage: -30 to +80 °C <b>-22 to +176 °F</b>											
	Ambient humidity	45 to 85 % RH, Storage: 35 to 95 % RH											
	Voltage withstandability	1,000 V AC for one min. between all supply terminals connected together and enclosure											
	Insulation resistance	50 MΩ, or more, with 250 V DC megger between all supply terminals connected together and enclosure											
	Vibration resistance	10 to 55 Hz frequency, 1.5 mm <b>0.059 in</b> amplitude in X, Y and Z directions for two hours each											
Shock resistance	1,000 m/s <sup>2</sup> acceleration (100 G approx.) in X, Y and Z directions for three times each												
Sensing range variation	Temperature characteristics	Over ambient temperature range -25 to +70 °C <b>-13 to +158 °F</b> : within ±10 % of sensing range at +20 °C <b>+68 °F</b>											
	Voltage characteristics	Within ±2 % for ±10 % fluctuation of the supply voltage											
Material		Enclosure: Brass (Nickel plated), Sensing part: Nylon, Indicator part: Nylon											
Cable		0.3 mm <sup>2</sup> 3-core oil, heat and cold resistant cabtyre cable, 2 m <b>6.562 ft</b> long											
Cable extension		Extension up to total 100 m <b>328.084 ft</b> is possible with 0.3 mm <sup>2</sup> , or more, cable.											
Weight (Note 4)		Net weight: 65 g approx.		Net weight: 110 g approx.		Net weight: 240 g approx.		Net weight: 65 g approx.		Net weight: 110 g approx.		Net weight: 240 g approx.	
Accessories		Nut: 2 pcs., Toothed lock washer: 1 pc.											

- Notes: 1) Where measurement conditions have not been specified precisely, the conditions used were an ambient temperature of +23 °C **+73.4 °F**.  
 2) The maximum operation distance stands for the maximum distance for which the sensor can detect the standard sensing object. The stable sensing range stands for the sensing range for which the sensor can stably detect the standard sensing object even if there is an ambient temperature drift and/or supply voltage fluctuation.  
 3) If using the sensor in an environment where cutting oil droplets splatter, the sensor may be deteriorated due to added substances in the oil. Please check the resistivity of the sensor against the cutting oil you are using beforehand.  
 4) The given weight includes the weight of two nuts and one toothed lock washer.

FIBER SENSORS

LASER SENSORS

PHOTO-ELECTRIC SENSORS  
MICRO PHOTO-ELECTRIC SENSORS

AREA SENSORS

LIGHT CURTAINS/SAFETY COMPONENTS

PRESSURE / FLOW SENSORS

INDUCTIVE PROXIMITY SENSORS

PARTICULAR USE SENSORS

SENSOR OPTIONS

SIMPLE WIRE-SAVING UNITS

WIRE-SAVING SYSTEMS

MEASUREMENT SENSORS

STATIC ELECTRICITY PREVENTION DEVICES

LASER MARKERS

PLC

HUMAN MACHINE INTERFACES

ENERGY CONSUMPTION VISUALIZATION COMPONENTS

FA COMPONENTS

MACHINE VISION SYSTEMS

UV CURING SYSTEMS

Selection Guide

Amplifier Built-in

Amplifier-separated

GX-F/H

GXL

GL

GX-M

GX-U/GX-FU/GX-N

GX

**I/O CIRCUIT AND WIRING DIAGRAMS**

**GX-U(B)**

DC 2-wire type

**I/O circuit diagram**

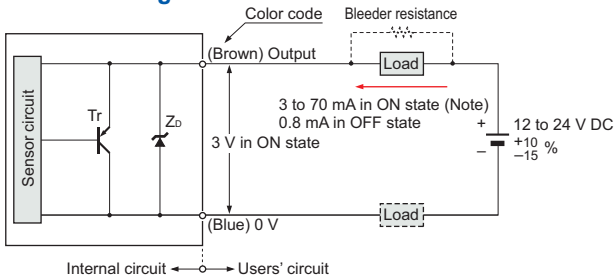

Note: The maximum load current varies depending on the ambient temperature.

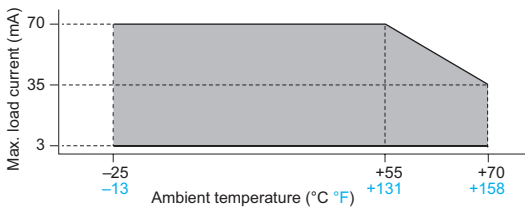

Symbols ... ZD: Surge absorption zener diode  
Tr: PNP output transistor

**Wiring diagram**

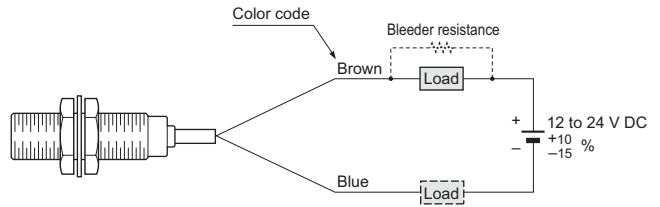

**Conditions for the load**

- 1) The load should not be actuated by the leakage current (0.8 mA) in the OFF state.
- 2) The load should be actuated by (supply voltage - 3 V) in the ON state.
- 3) The current in the ON state should be between 3 to 70 mA DC.

[ In case the current is less than 3 mA, connect a bleeder resistance in parallel to the load so that a current of 3 mA, or more, flows. ]

**GX-U(B)-J GX-FU-U-J**

Spatter-resistant of DC 2-wire type

**I/O circuit diagram**

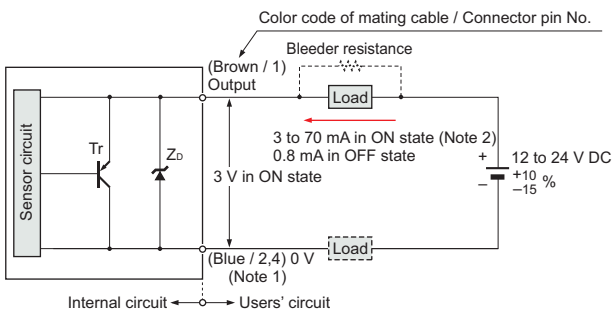

- Notes: 1) This is when the mating cable **CN-22G-C** is connected. The connector pins No.2 and No.4 are short-circuited inside the mating cable connector. However, when the mating cable **CN-24-C** is connected; **GX-U-U-J** (normally open): (Black / 4) 0 V  
**GX-U-UB-J** (normally closed): (White / 2) 0 V
- 2) The maximum load current varies depending on the ambient temperature.

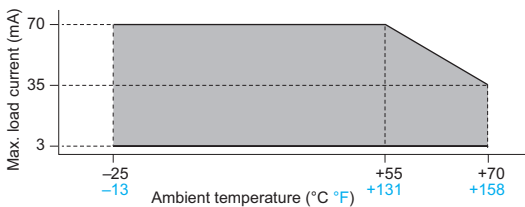

**Conditions for the load**

- 1) The load should not be actuated by the leakage current (0.8 mA) in the OFF state.
- 2) The load should be actuated by (supply voltage - 3 V) in the ON state.
- 3) The current in the ON state should be between 3 to 70 mA DC.

[ In case the current is less than 3 mA, connect a bleeder resistance in parallel to the load so that a current of 3 mA, or more, flows. ]

Symbols ... ZD: Surge absorption zener diode  
Tr: PNP output transistor

**Wiring diagram**

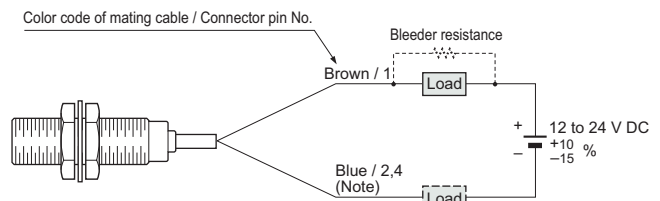

Note: This is when the mating cable **CN-22G-C** is connected. The connector pins No.2 and No.4 are short-circuited inside the mating cable connector. However, when the mating cable **CN-24-C** is connected; **GX-U-U-J** (normally open): Black / 4  
**GX-U-UB-J** (normally closed): White / 2

**Connector pin position**

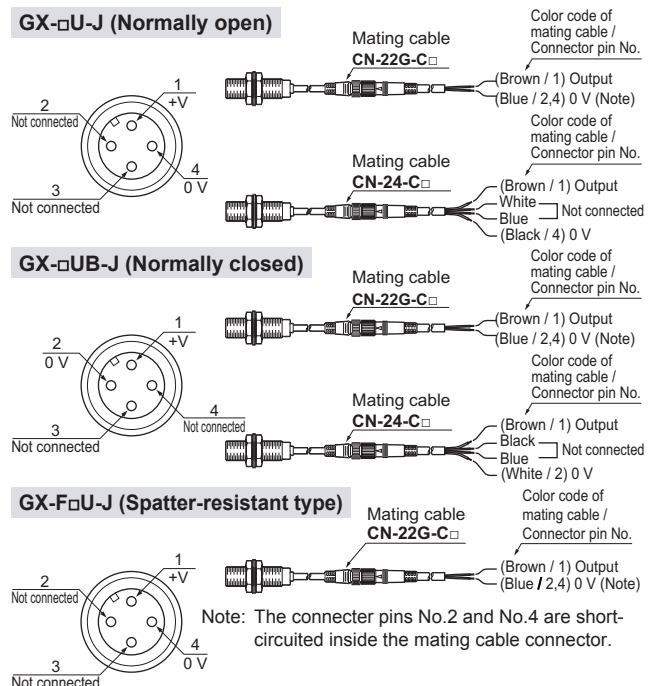

Note: The connector pins No.2 and No.4 are short-circuited inside the mating cable connector.

FIBER SENSORS

LASER SENSORS

PHOTO-ELECTRIC SENSORS

MICRO PHOTO-ELECTRIC SENSORS

AREA SENSORS

LIGHT CURTAINS / SAFETY COMPONENTS

PRESSURE / FLOW SENSORS

INDUCTIVE PROXIMITY SENSORS

PARTICULAR USE SENSORS

SENSOR OPTIONS

SIMPLE WIRE-SAVING UNITS

WIRE-SAVING SYSTEMS

MEASUREMENT SENSORS

STATIC ELECTRICITY PREVENTION DEVICES

LASER MARKERS

PLC

HUMAN MACHINE INTERFACES

ENERGY CONSUMPTION VISUALIZATION COMPONENTS

FA COMPONENTS

MACHINE VISION SYSTEMS

UV CURING SYSTEMS

Selection Guide

Amplifier Built-in

Amplifier-separated

**GX-F/H**

**GXL**

**GL**

**GX-M**

**GX-U/GX-FU/GX-N**

**GX**



FIBER SENSORS  
LASER SENSORS  
PHOTO-ELECTRIC SENSORS  
MICRO PHOTO-ELECTRIC SENSORS  
AREA SENSORS  
LIGHT CURTAINS/ SAFETY COMPONENTS  
PRESSURE / FLOW SENSORS  
INDUCTIVE PROXIMITY SENSORS  
PARTICULAR USE SENSORS  
SENSOR OPTIONS  
SIMPLE WIRE-SAVING UNITS  
WIRE-SAVING SYSTEMS  
MEASUREMENT SENSORS  
STATIC ELECTRICITY PREVENTION DEVICES  
LASER MARKERS  
PLC  
HUMAN MACHINE INTERFACES  
ENERGY CONSUMPTION VISUALIZATION COMPONENTS  
FA COMPONENTS  
MACHINE VISION SYSTEMS  
UV CURING SYSTEMS  
Selection Guide  
Amplifier Built-in  
Amplifier-separated  
GX-F/H  
GXL  
GL  
GX-M  
GX-U/GX-FU/GX-N  
GX

## I/O CIRCUIT AND WIRING DIAGRAMS

### GX-N□

DC 3-wire type (NPN output)

#### I/O circuit diagram

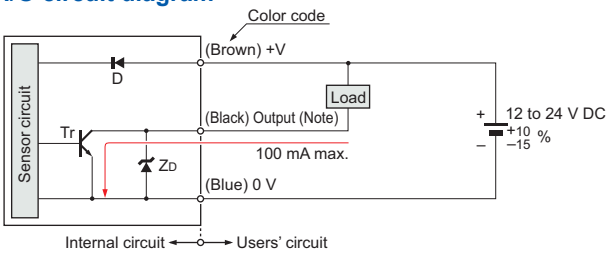

#### Wiring diagram

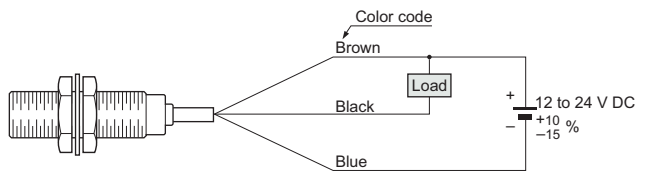

Note: If a capacitive load is directly connected to the output, malfunction may occur.

Symbols ... D : Reverse supply polarity protection diode  
ZD: Surge absorption zener diode  
Tr : NPN output transistor

## SENSING CHARACTERISTICS (TYPICAL)

### GX-5SU GX-5SUB

#### Sensing field

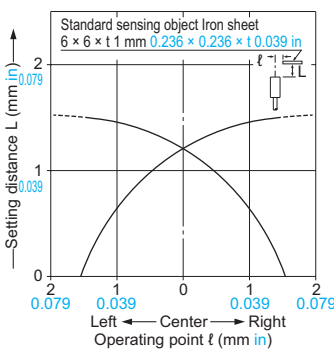

#### Correlation between sensing object size and sensing range

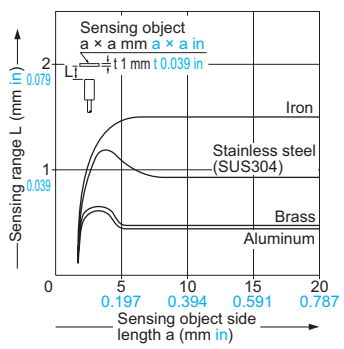

As the sensing object size becomes smaller than the standard size (iron sheet 6 × 6 × t 1 mm 0.236 × 0.236 × t 0.039 in), the sensing range shortens as shown in the left figure.

### GX-8MU GX-8MUB

#### Sensing field

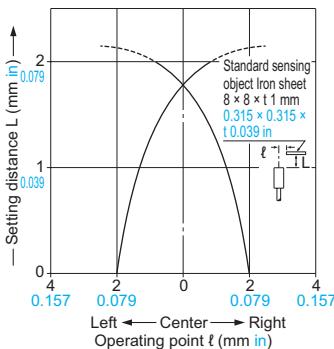

#### Correlation between sensing object size and sensing range

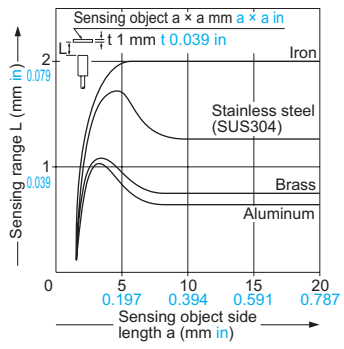

As the sensing object size becomes smaller than the standard size (iron sheet 8 × 8 × t 1 mm 0.315 × 0.315 × t 0.039 in), the sensing range shortens as shown in the left figure.

### GX-12MU(B) GX-F12MU-J

#### Sensing field

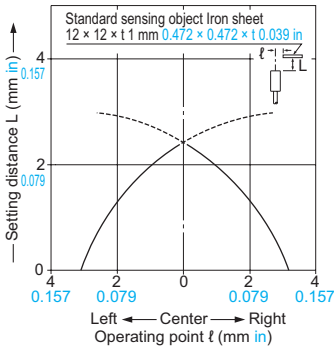

#### Correlation between sensing object size and sensing range

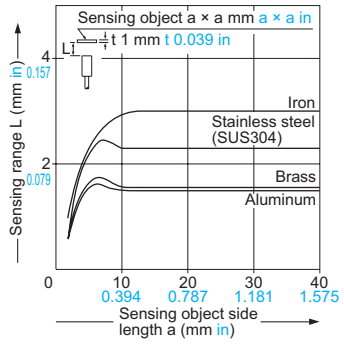

As the sensing object size becomes smaller than the standard size (iron sheet 12 × 12 × t 1 mm 0.472 × 0.472 × t 0.039 in), the sensing range shortens as shown in the left figure.

**SENSING CHARACTERISTICS (TYPICAL)**

**GX-18MU(B) GX-F18MU-J**

**Sensing field**

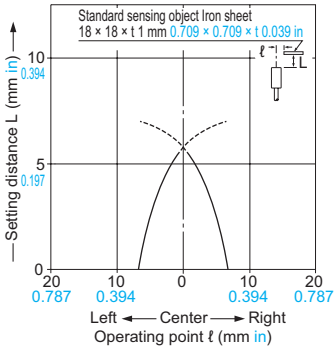

**Correlation between sensing object size and sensing range**

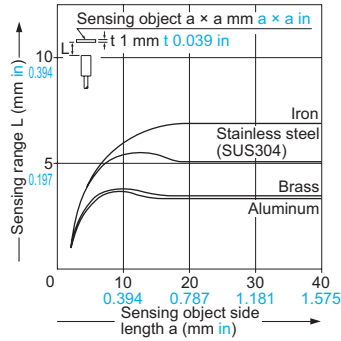

As the sensing object size becomes smaller than the standard size (iron sheet 18 × 18 × t 1 mm 0.709 × 0.709 × t 0.039 in), the sensing range shortens as shown in the left figure.

**GX-30MU(B) GX-F30MU-J**

**Sensing field**

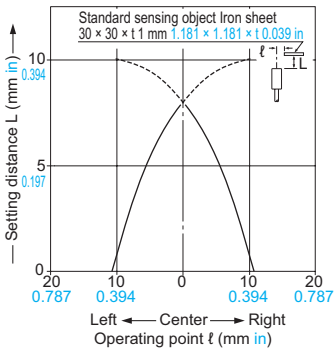

**Correlation between sensing object size and sensing range**

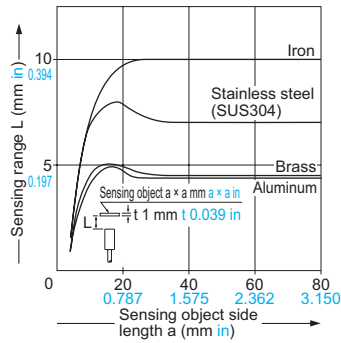

As the sensing object size becomes smaller than the standard size (iron sheet 30 × 30 × t 1 mm 1.181 × 1.181 × t 0.039 in), the sensing range shortens as shown in the left figure.

**GX-8MLU GX-8MLUB**

**Sensing field**

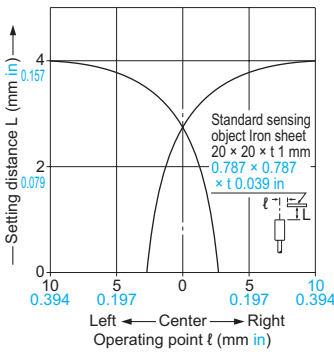

**Correlation between sensing object size and sensing range**

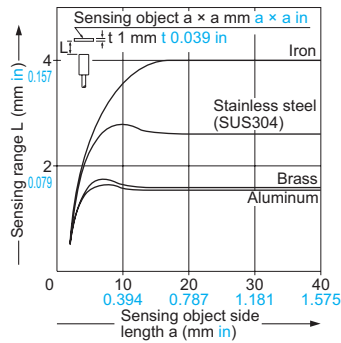

As the sensing object size becomes smaller than the standard size (iron sheet 20 × 20 × t 1 mm 0.787 × 0.787 × t 0.039 in), the sensing range shortens as shown in the left figure.

**GX-12MLU GX-12MLUB**

**Sensing field**

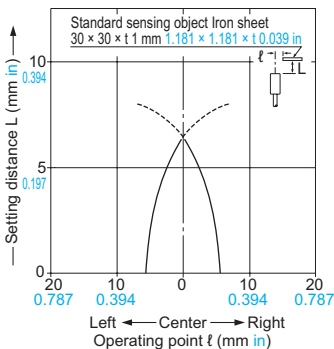

**Correlation between sensing object size and sensing range**

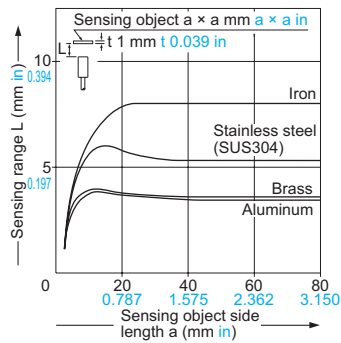

As the sensing object size becomes smaller than the standard size (iron sheet 30 × 30 × t 1 mm 1.181 × 1.181 × t 0.039 in), the sensing range shortens as shown in the left figure.

- FIBER SENSORS
- LASER SENSORS
- PHOTO-ELECTRIC SENSORS
- MICRO PHOTO-ELECTRIC SENSORS
- AREA SENSORS
- LIGHT CURTAINS / SAFETY COMPONENTS
- PRESSURE / FLOW SENSORS
- INDUCTIVE PROXIMITY SENSORS
- PARTICULAR USE SENSORS
- SENSOR OPTIONS
- SMALL WIRE-SAVING UNITS
- WIRE-SAVING SYSTEMS
- MEASUREMENT SENSORS
- STATIC ELECTRICITY PREVENTION DEVICES
- LASER MARKERS
- PLC
- HUMAN MACHINE INTERFACES
- ENERGY CONSUMPTION VISUALIZATION COMPONENTS
- FA COMPONENTS
- MACHINE VISION SYSTEMS
- UV CURING SYSTEMS
- Selection Guide
- Amplifier Built-in
- Amplifier-separated
- GX-F/H
- GXL
- GL
- GX-M
- GX-U/GX-FU/GX-N
- GX

**SENSING CHARACTERISTICS (TYPICAL)**

**GX-18MLU GX-18MLUB**

**Sensing field**

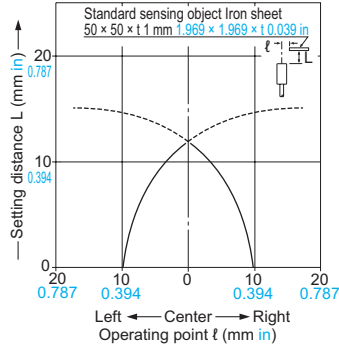

**Correlation between sensing object size and sensing range**

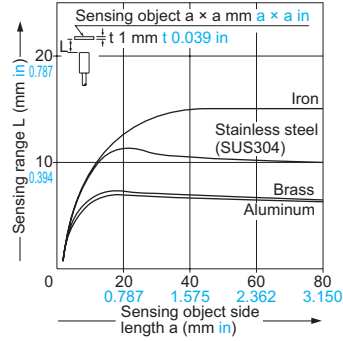

As the sensing object size becomes smaller than the standard size (iron sheet 50 × 50 × t 1 mm 1.969 × 1.969 × t 0.039 in), the sensing range shortens as shown in the left figure.

**GX-30MLU GX-30MLUB**

**Sensing field**

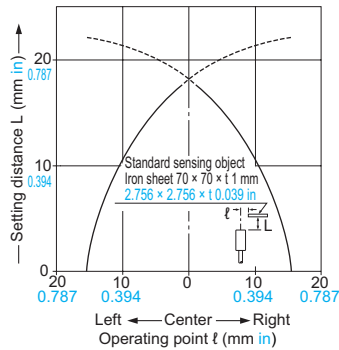

**Correlation between sensing object size and sensing range**

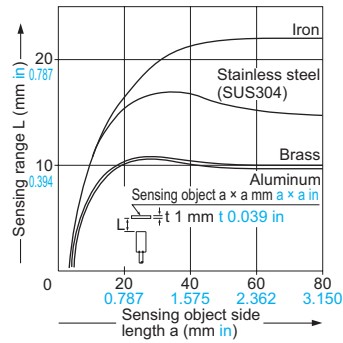

As the sensing object size becomes smaller than the standard size (iron sheet 70 × 70 × t 1 mm 2.756 × 2.756 × t 0.039 in), the sensing range shortens as shown in the left figure.

**GX-N12M GX-N12MB**

**Sensing field**

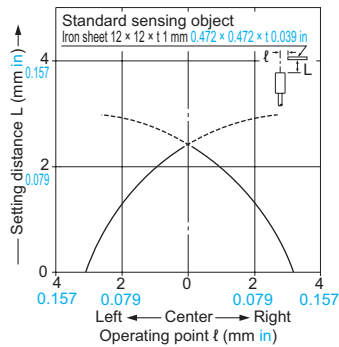

**Correlation between sensing object size and sensing range**

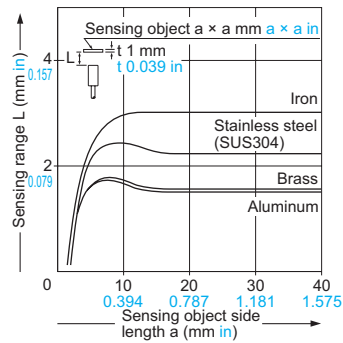

As the sensing object size becomes smaller than the standard size (iron sheet 12 × 12 × t 1 mm 0.472 × 0.472 × t 0.039 in), the sensing range shortens as shown in the left figure.

**GX-N18M GX-N18MB**

**Sensing field**

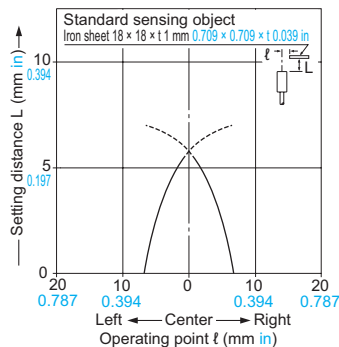

**Correlation between sensing object size and sensing range**

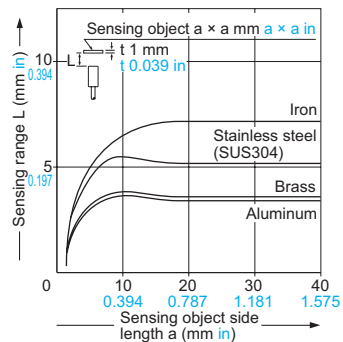

As the sensing object size becomes smaller than the standard size (iron sheet 18 × 18 × t 1 mm 0.709 × 0.709 × t 0.039 in), the sensing range shortens as shown in the left figure.

- FIBER SENSORS
- LASER SENSORS
- PHOTO-ELECTRIC SENSORS
- MICRO PHOTO-ELECTRIC SENSORS
- AREA SENSORS
- LIGHT CURTAINS/SAFETY COMPONENTS
- PRESSURE / FLOW SENSORS
- INDUCTIVE PROXIMITY SENSORS
- PARTICULAR USE SENSORS
- SENSOR OPTIONS
- SIMPLE WIRE-SAVING UNITS
- WIRE-SAVING SYSTEMS
- MEASUREMENT SENSORS
- STATIC ELECTRICITY PREVENTION DEVICES
- LASER MARKERS
- PLC
- HUMAN MACHINE INTERFACES
- ENERGY CONSUMPTION VISUALIZATION COMPONENTS
- FA COMPONENTS
- MACHINE VISION SYSTEMS
- UV CURING SYSTEMS
- Selection Guide
- Amplifier Built-in
- Amplifier-separated
- GX-F/H
- GXL
- GL
- GX-M
- GX-U/GX-FU/GX-N
- GX

**SENSING CHARACTERISTICS (TYPICAL)**

**GX-N30M GX-N30MB**

**Sensing field**

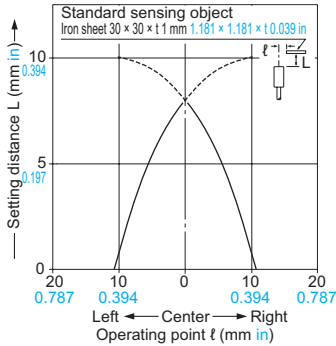

**Correlation between sensing object size and sensing range**

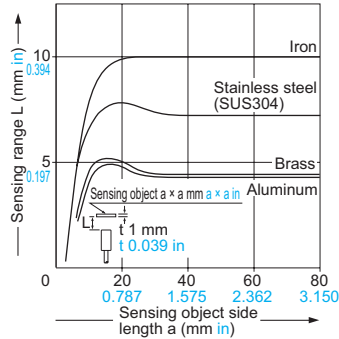

As the sensing object size becomes smaller than the standard size (iron sheet 30 × 30 × t 1 mm 1.181 × 1.181 × t 0.039 in), the sensing range shortens as shown in the left figure.

**GX-N12ML GX-N12MLB**

**Sensing field**

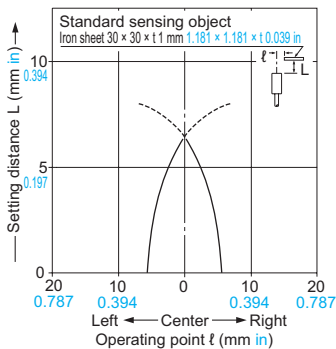

**Correlation between sensing object size and sensing range**

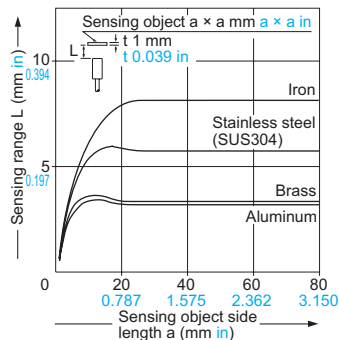

As the sensing object size becomes smaller than the standard size (iron sheet 30 × 30 × t 1 mm 1.181 × 1.181 × t 0.039 in), the sensing range shortens as shown in the left figure.

**GX-N18ML GX-N18MLB**

**Sensing field**

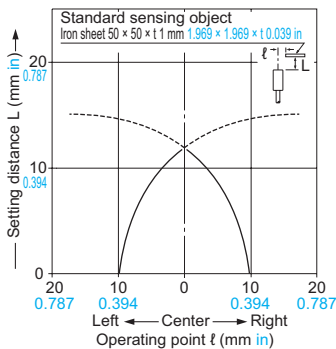

**Correlation between sensing object size and sensing range**

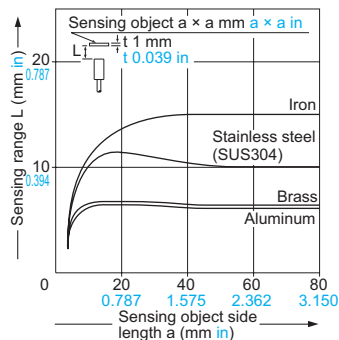

As the sensing object size becomes smaller than the standard size (iron sheet 50 × 50 × t 1 mm 1.969 × 1.969 × t 0.039 in), the sensing range shortens as shown in the left figure.

**GX-N30ML GX-N30MLB**

**Sensing field**

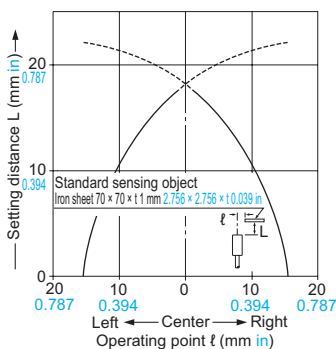

**Correlation between sensing object size and sensing range**

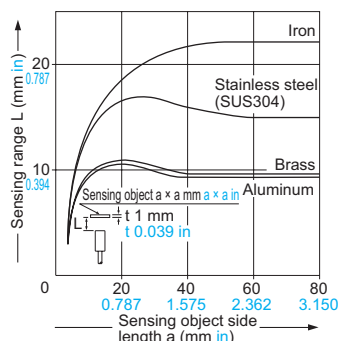

As the sensing object size becomes smaller than the standard size (iron sheet 70 × 70 × t 1 mm 2.756 × 2.756 × t 0.039 in), the sensing range shortens as shown in the left figure.

- FIBER SENSORS
- LASER SENSORS
- PHOTO-ELECTRIC SENSORS
- MICRO PHOTO-ELECTRIC SENSORS
- AREA SENSORS
- LIGHT CURTAINS / SAFETY COMPONENTS
- PRESSURE / FLOW SENSORS
- INDUCTIVE PROXIMITY SENSORS
- PARTICULAR USE SENSORS
- SENSOR OPTIONS
- SIMPLE WIRE-SAVING UNITS
- WIRE-SAVING SYSTEMS
- MEASUREMENT SENSORS
- STATIC ELECTRICITY PREVENTION DEVICES
- LASER MARKERS
- PLC
- HUMAN MACHINE INTERFACES
- ENERGY CONSUMPTION VISUALIZATION COMPONENTS
- FA COMPONENTS
- MACHINE VISION SYSTEMS
- UV CURING SYSTEMS
- Selection Guide
- Amplifier Built-in
- Amplifier-separated
- GX-F/H
- GXL
- GL
- GX-M
- GX-U/GX-FU/GX-N
- GX

**PRECAUTIONS FOR PROPER USE**

Refer to p.1485~ for general precautions.

**All models**



- Never use this product as a sensing device for personnel protection.
- In case of using sensing devices for personnel protection, use products which meet laws and standards, such as OSHA, ANSI or IEC etc., for personnel protection applicable in each region or country.

**Mounting**

- The tightening torque should be under the value given below.

**Mounting with a set screw**

- Tighten with the cup-point of a set screw (M4).

**<Non-threaded type>**

**Mounting hole process dimension**

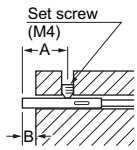

Model No.	A (mm in)	B (mm in)	C (mm in)	Tightening torque
<b>GX-5SU(B)</b>	5 to 30 0.197 to 1.181	3 0.118	$\phi 5.5^{+0.2}_0$ $\phi 0.217^{+0.008}_0$	0.78 N·m

- Do not fix on the operation indicator or opposite to it.

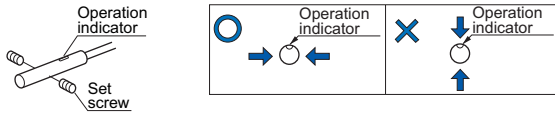

**Mounting with nut**

**<Shielded of threaded type>**

**<Non-shielded of threaded type>**

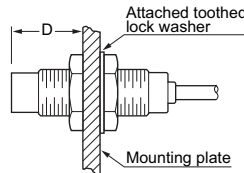
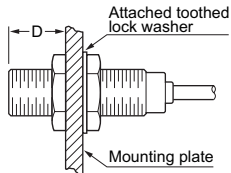

Model No.	Dimension D (mm in)	Tightening torque
<b>GX-8MU(B)</b>	3 to 10.3 0.118 to 0.406	5.9 N·m
	10.3 0.406 or more	11.8 N·m
<b>GX-12MU(B)</b> <b>GX-F12MU-J</b> <b>GX-N12M(B)</b>	3.5 to 13.5 0.138 to 0.531	10 N·m
	13.5 0.531 or more	20 N·m
<b>GX-18MU(B)</b> <b>GX-F18MU-J</b> <b>GX-N18M(B)</b>	4 to 18 0.157 to 0.709	45 N·m
	18 0.709 or more	80 N·m
<b>GX-30MU(B)</b> <b>GX-F30MU-J</b> <b>GX-N30M(B)</b>	5 to 21 0.197 to 0.827	80 N·m
	21 0.827 or more	180 N·m
<b>GX-8MLU(B)</b>	12 0.472 or more	11.8 N·m
	15 0.591 or more	20 N·m
<b>GX-18MLU(B)</b> <b>GX-N18ML(B)</b>	25 0.984 or more	80 N·m
	30 1.181 or more	180 N·m

Note: Mount such that the nuts do not protrude from the threaded portion.

- The root truncation of the threads is shallow owing to strengthening of the sensors against tightening. When tapping holes on equipment to fix the sensors, the prepared holes must be value in the table below.

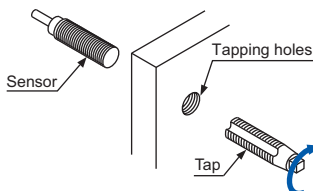

Model No.	Prepared hole
<b>GX-8MU(B)</b> <b>GX-8MLU(B)</b>	$\phi 7.2$ mm $\phi 0.283$ in
<b>GX-12MU(B)</b> <b>GX-12MLU(B)</b> <b>GX-F12MU-J</b> <b>GX-N12M(B)</b> <b>GX-N12ML(B)</b>	$\phi 11.2$ mm $\phi 0.441$ in

**Distance from surrounding metal**

- As metal around the sensor may affect the sensing performance, pay attention to the following points.

**Influence of surrounding metal**

- The surrounding metal will affect the sensing performance. Keep the minimum distance specified in the table below.

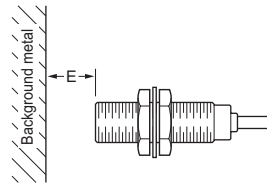

Model No.	E (mm in)
<b>GX-5SU(B)</b>	4.5 0.177
<b>GX-8MU(B)</b>	4.5 0.177
<b>GX-12MU(B)</b> <b>GX-F12MU-J</b> <b>GX-N12M(B)</b>	8 0.315
<b>GX-18MU(B)</b> <b>GX-F18MU-J</b> <b>GX-N18M(B)</b>	20 0.787
<b>GX-30MU(B)</b> <b>GX-F30MU-J</b> <b>GX-N30M(B)</b>	40 1.575
<b>GX-8MLU(B)</b>	8 0.315
<b>GX-12MLU(B)</b> <b>GX-N12ML(B)</b>	22 0.866
<b>GX-18MLU(B)</b> <b>GX-N18ML(B)</b>	45 1.772
<b>GX-30MLU(B)</b> <b>GX-N30ML(B)</b>	75 2.953

**Embedding of the sensor in metal**

- Sensing range may decrease if the sensor is completely embedded in metal. Especially for the non-threaded type and the non-shielded type, keep the minimum distance specified in the table below.

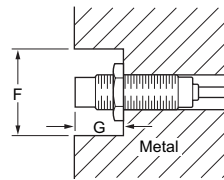

Note: With the non-shielded type, the sensing range may vary depending on the position of the nuts.

Model No.	F (mm in)	G (mm in)
<b>GX-5SU(B)</b>	$\phi 12$ $\phi 0.472$	3 0.118
<b>GX-8MLU(B)</b>	$\phi 24$ $\phi 0.945$	12 0.472
<b>GX-12MLU(B)</b> <b>GX-N12ML(B)</b>	$\phi 50$ $\phi 1.969$	15 0.591
<b>GX-18MLU(B)</b> <b>GX-N18ML(B)</b>	$\phi 75$ $\phi 2.953$	25 0.984
<b>GX-30MLU(B)</b> <b>GX-N30ML(B)</b>	$\phi 105$ $\phi 4.134$	30 1.181

**Mutual interference**

- When two or more sensors are installed in parallel or face to face, keep the minimum separation distance specified below to avoid mutual interference.

**Face to face mounting**

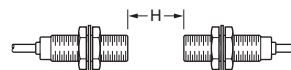

**Parallel mounting**

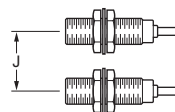

Model No.	H (mm in)	J (mm in)
<b>GX-5SU(B)</b>	19 0.748	14 0.551
<b>GX-8MU(B)</b>	20 0.787	15 0.591
<b>GX-12MU(B)</b> <b>GX-F12MU-J</b>	35 1.378	20 0.787
<b>GX-18MU(B)</b> <b>GX-F18MU-J</b>	70 2.756	45 1.772
<b>GX-30MU(B)</b> <b>GX-F30MU-J</b>	115 4.528	70 2.756
<b>GX-8MLU(B)</b>	60 2.362	45 1.772
<b>GX-12MLU(B)</b>	145 5.709	95 3.740
<b>GX-18MLU(B)</b>	250 9.843	165 6.496
<b>GX-30MLU(B)</b>	350 13.780	250 9.843
<b>GX-N12M(B)</b>	25 0.984	15 0.591
<b>GX-N18M(B)</b>	50 1.969	35 1.378
<b>GX-N30M(B)</b>	90 3.543	55 2.165
<b>GX-N12ML(B)</b>	120 4.724	70 2.756
<b>GX-N18ML(B)</b>	180 7.087	125 4.921
<b>GX-N30ML(B)</b>	290 11.417	190 7.480

**PRECAUTIONS FOR PROPER USE**

Refer to p.1485~ for general precautions.

**All models**

**Sensing range**

- The sensing range is specified for the standard sensing object. With a non-ferrous metal, the sensing range is obtained by multiplying with the correction coefficient specified below. Further, the sensing range also changes if the sensing object is smaller than the standard sensing object or if the sensing object is plated.

**Correction coefficient**

Model No. \ Metal	Iron	Stainless steel (SUS304)	Brass	Aluminum
<b>GX-5SU(B)</b>	1	0.63 approx.	0.32 approx.	0.30 approx.
<b>GX-8MU(B)</b>	1	0.59 approx.	0.32 approx.	0.29 approx.
<b>GX-12MU(B)</b> <b>GX-F12MU-J</b>	1	0.75 approx.	0.51 approx.	0.49 approx.
<b>GX-18MU(B)</b> <b>GX-F18MU-J</b>	1	0.75 approx.	0.50 approx.	0.48 approx.
<b>GX-30MU(B)</b> <b>GX-F30MU-J</b>	1	0.69 approx.	0.44 approx.	0.42 approx.
<b>GX-8MLU(B)</b>	1	0.64 approx.	0.38 approx.	0.38 approx.
<b>GX-12MLU(B)</b>	1	0.67 approx.	0.44 approx.	0.43 approx.
<b>GX-18MLU(B)</b>	1	0.68 approx.	0.45 approx.	0.43 approx.
<b>GX-30MLU(B)</b>	1	0.67 approx.	0.44 approx.	0.43 approx.
<b>GX-N12M(B)</b>	1	0.77 approx.	0.52 approx.	0.51 approx.
<b>GX-N18M(B)</b>	1	0.73 approx.	0.50 approx.	0.48 approx.
<b>GX-N30M(B)</b>	1	0.70 approx.	0.45 approx.	0.44 approx.
<b>GX-N12ML(B)</b>	1	0.66 approx.	0.44 approx.	0.43 approx.
<b>GX-N18ML(B)</b>	1	0.68 approx.	0.46 approx.	0.44 approx.
<b>GX-N30ML(B)</b>	1	0.65 approx.	0.44 approx.	0.43 approx.

**Protection cover (Optional)**

- It protects the sensing surface from welding sparks (spatter), etc.

**Mounting method**

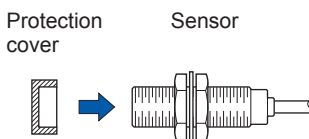

Material: Fluorine resin

Model No.	Applicable model No.
<b>MS-H12</b>	<b>GX-12MU(B)</b> <b>GX-N12M(B)</b>
<b>MS-H18</b>	<b>GX-18MU(B)</b> <b>GX-N18M(B)</b>
<b>MS-H30</b>	<b>GX-30MU(B)</b> <b>GX-N30M(B)</b>

Note: Mount the protection cover so that there is no gap between it and the sensing surface.

**Others**

- Do not use during the initial transient time (50 ms) after the power supply is switched on.
- Make sure that stress by forcible bend or pulling is not applied directly to the sensor cable joint.

**DC 2-wire type**

**Wiring**

- The sensor must be connected to a power supply via a load. If the sensor is connected to a power supply without a load, the short-circuit protection makes the sensor inoperable. (The output stays in the OFF state and the indicator does not light up.) In this case, rectify by connecting the power supply via a load. Now, the sensor becomes operable. Further, take care that if the power supply is connected with reverse polarity without a load, the sensor will get damaged.

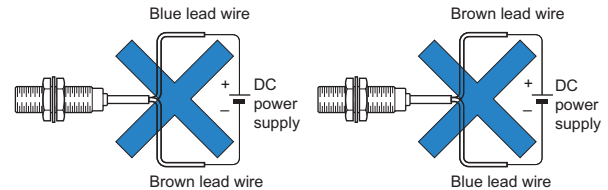

- For series connection (AND circuit) or parallel connection (OR circuit) of sensors, take care of the following.

**Series connection (AND circuit)**

When all sensors are in the ON state, the load voltage  $V_{RL}$  is given by:

$$V_{RL} = V_{CC} - n \times 3 \text{ (V)}$$

( $V_{CC}$ : supply voltage (24 V DC max.)  
 $n$ : number of sensors)

Make sure that the load can work properly at this voltage.

Note: The output is generated normally even if the indicator does not light up properly.

**Parallel connection (OR circuit)**

When all sensors are in the OFF state, the load leakage current  $I_{CC}$  is given by:

$$I_{CC} = n \times 0.8 \text{ (mA)} \text{ (n: number of sensors)}$$

Make sure that the load can work properly.

Note: The load current in the ON state is given by:

$$I_L = \frac{V_{CC} - 3V}{\text{Load resistance}} \text{ (mA)}$$

The load current must be  $3 \text{ mA} \times n \leq I_L \leq 70 \text{ mA}$  (n: number of sensors turned ON)

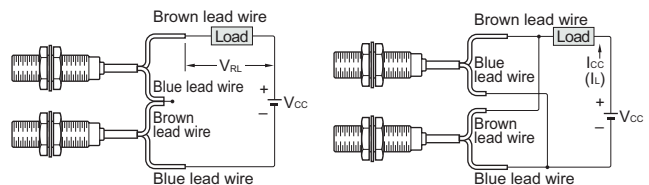

- The residual voltage of the sensor is 3 V. Before connecting a relay as the load, take care of its actuation voltage. (Some 12 V relays may not be usable.)

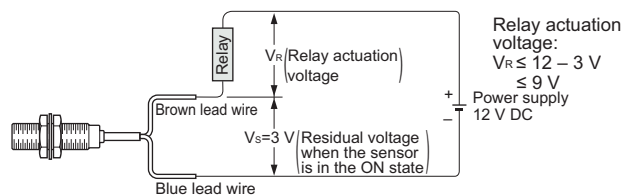

**2-color indicator [GX-(F)□U-(J) only]**

- When the sensing object is in the stable sensing range, the LED lights up in green, and when the sensing object is in the unstable sensing range, the LED lights up in orange. While the LED lights up in green, the sensing is performed stably without being affected by temperature drifts or voltage fluctuations.

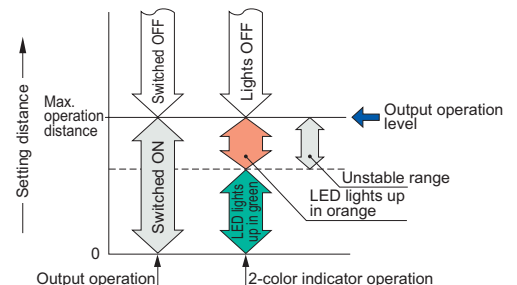

FIBER SENSORS  
LASER SENSORS  
PHOTO-ELECTRIC SENSORS  
MICRO PHOTO-ELECTRIC SENSORS  
AREA SENSORS  
LIGHT CURTAINS / SAFETY COMPONENTS  
PRESSURE / FLOW SENSORS  
INDUCTIVE PROXIMITY SENSORS  
PARTICULAR USE SENSORS  
SENSOR OPTIONS  
SIMPLE WIRE-SAVING UNITS  
WIRE-SAVING SYSTEMS  
MEASUREMENT SENSORS  
STATIC ELECTRICITY PREVENTION DEVICES  
LASER MARKERS  
PLC  
HUMAN MACHINE INTERFACES  
ENERGY CONSUMPTION VISUALIZATION COMPONENTS  
FA COMPONENTS  
MACHINE VISION SYSTEMS  
UV CURING SYSTEMS

Selection Guide  
Amplifier Built-in  
Amplifier-separated  
**GX-F/H**  
**GXL**  
**GL**  
**GX-M**  
**GX-U/GX-FU**  
**GX-N**  
**GX**

**DIMENSIONS (Unit: mm in)**

The CAD data in the dimensions can be downloaded from our website.

**GX-5SU GX-5SUB** Sensor

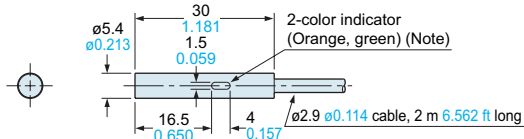

Note: **GX-5SUB** has an operation indicator (orange) instead of the 2-color indicator.

**GX-8MU GX-8MUB** Sensor

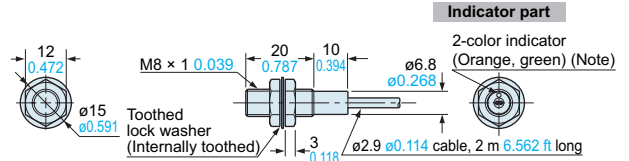

Note: **GX-8MUB** has an operation indicator (orange) instead of the 2-color indicator.

**GX-12MU(B) GX-N12M(B)** Sensor

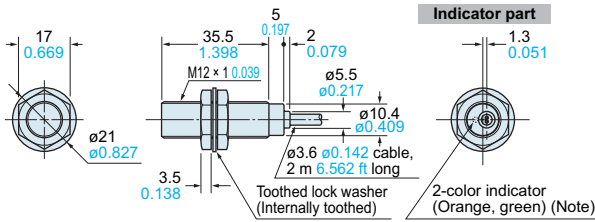

Note: **GX-12MUB** and **GX-N12M(B)** have an operation indicator (orange) instead of the 2-color indicator.

**GX-18MU(B) GX-N18M(B)** Sensor

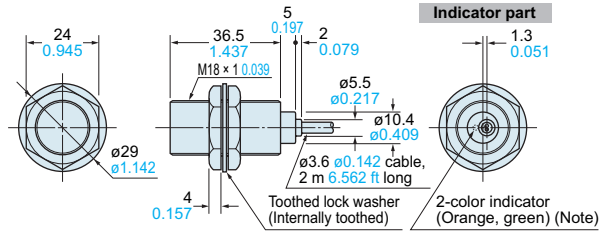

Note: **GX-18MUB** and **GX-N18M(B)** have an operation indicator (orange) instead of the 2-color indicator.

**GX-30MU(B) GX-N30M(B)** Sensor

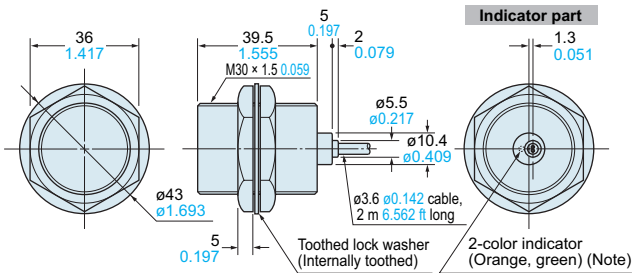

Note: **GX-30MUB** and **GX-N30M(B)** have an operation indicator (orange) instead of the 2-color indicator.

**GX-8MLU GX-8MLUB** Sensor

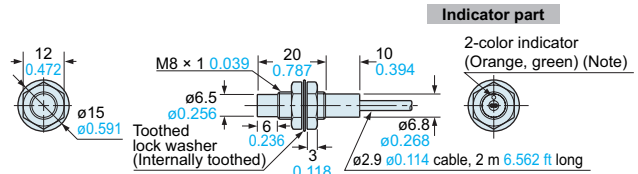

Note: **GX-8MLUB** has an operation indicator (orange) instead of the 2-color indicator.

**GX-12MLU(B) GX-N12ML(B)** Sensor

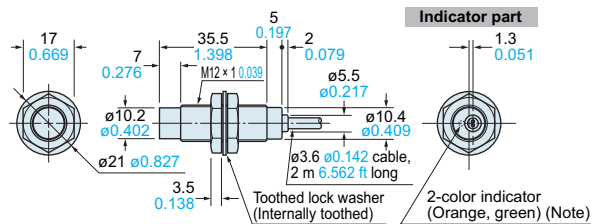

Note: **GX-12MLUB** and **GX-N12ML(B)** have an operation indicator (orange) instead of the 2-color indicator.

**GX-18MLU(B) GX-N18ML(B)** Sensor

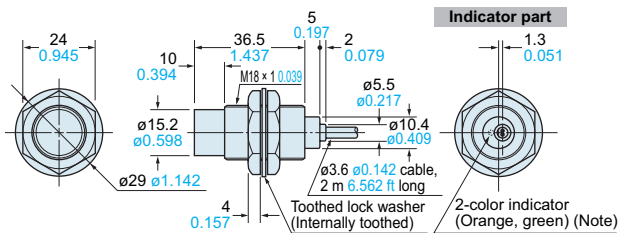

Note: **GX-18MLUB** and **GX-N18ML(B)** have an operation indicator (orange) instead of the 2-color indicator.

**GX-30MLU(B) GX-N30ML(B)** Sensor

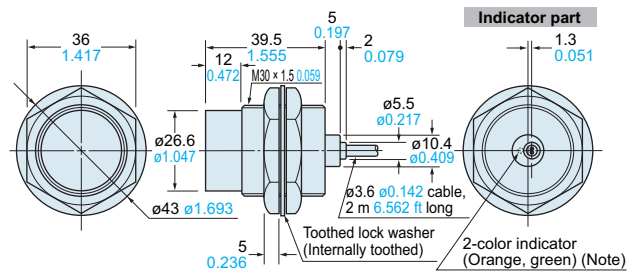

Note: **GX-30MLUB** and **GX-N30ML(B)** have an operation indicator (orange) instead of the 2-color indicator.

**GX-12MU(B)-J GX-F12MU-J** Sensor

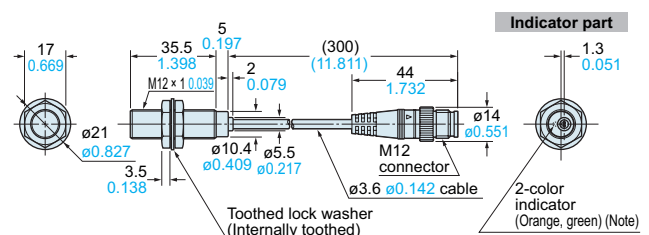

Note: **GX-12MUB-J** has an operation indicator (orange) instead of the 2-color indicator.

**DIMENSIONS (Unit: mm in)**

The CAD data in the dimensions can be downloaded from our website.

**GX-18MU(B)-J GX-F18MU-J** Sensor

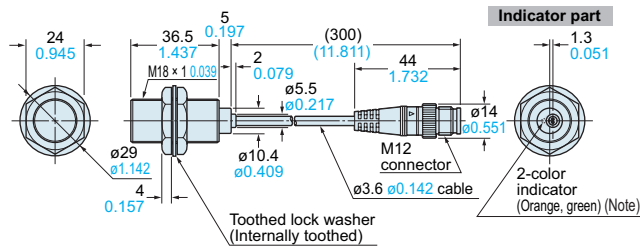

Note: **GX-18MUB-J** has an operation indicator (orange) instead of the 2-color indicator.

**GX-30MU(B)-J GX-F30MU-J** Sensor

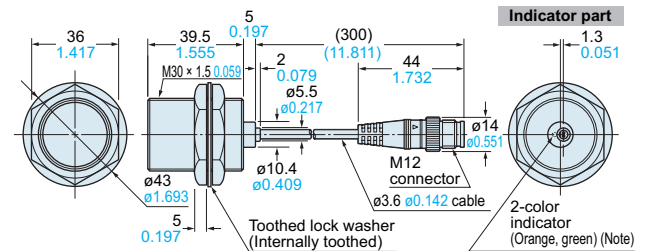

Note: **GX-30MUB-J** has an operation indicator (orange) instead of the 2-color indicator.

**GX-12MLU-J GX-12MLUB-J** Sensor

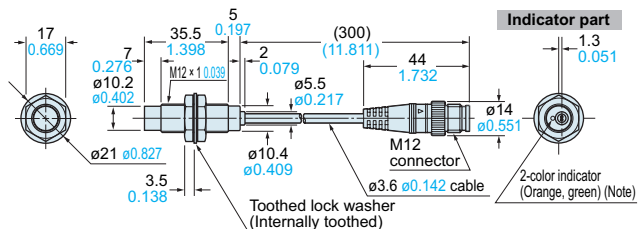

Note: **GX-12MLUB-J** has an operation indicator (orange) instead of the 2-color indicator.

**GX-18MLU-J GX-18MLUB-J** Sensor

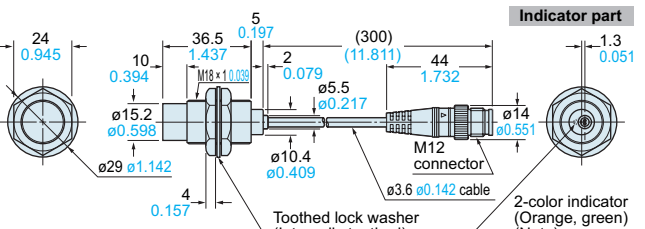

Note: **GX-18MLUB-J** has an operation indicator (orange) instead of the 2-color indicator.

**GX-30MLU-J GX-30MLUB-J** Sensor

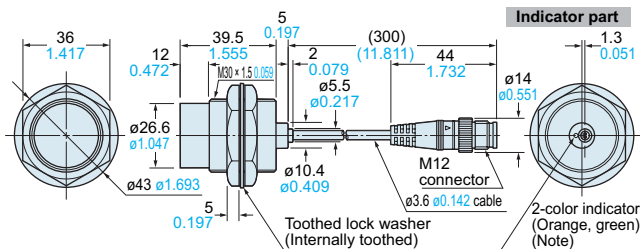

Note: **GX-30MLUB-J** has an operation indicator (orange) instead of the 2-color indicator.

**MS-SS5** Sensor mounting bracket for **GX-5SU(B)** (Optional)

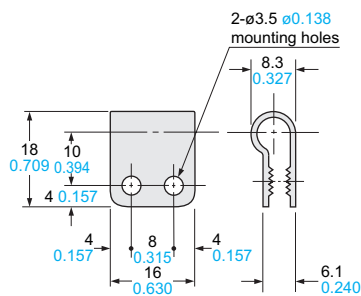

Material: Nylon 66

**MS-H12 MS-H18 MS-H30** Protection cover (Optional)

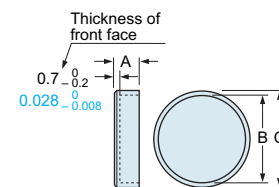

Material: Fluorine resin

Symbol Model No.	A	B	C	Applicable model No.
<b>MS-H12</b>	5	ø11.5 ø0.453	ø14 ø0.551	<b>GX-12MU(B)</b> <b>GX-N12M(B)</b>
<b>MS-H18</b>	6	ø17.5 ø0.689	ø20 ø0.787	<b>GX-18MU(B)</b> <b>GX-N18M(B)</b>
<b>MS-H30</b>	8	ø29.4 ø1.157	ø33 ø1.299	<b>GX-30MU(B)</b> <b>GX-N30M(B)</b>

- FIBER SENSORS
- LASER SENSORS
- PHOTO-ELECTRIC SENSORS
- MICRO PHOTO-ELECTRIC SENSORS
- AREA SENSORS
- LIGHT CURTAINS / SAFETY COMPONENTS
- PRESSURE / FLOW SENSORS
- INDUCTIVE PROXIMITY SENSORS
- PARTICULAR USE SENSORS
- SENSOR OPTIONS
- WIRE-SAVING UNITS
- WIRE-SAVING SYSTEMS
- MEASUREMENT SENSORS
- STATIC ELECTRICITY PREVENTION DEVICES
- LASER MARKERS
- PLC
- HUMAN MACHINE INTERFACES
- ENERGY CONSUMPTION VISUALIZATION COMPONENTS
- FA COMPONENTS
- MACHINE VISION SYSTEMS
- UV CURING SYSTEMS

- Selection Guide
- Amplifier Built-in
- Amplifier-separated
- GX-F/H**
- GXL**
- GL**
- GX-M**
- GX-U/GX-FU/GX-N**
- GX**