

Motion Controller

GM1 Controller

User's Manual

Operation Edition

(MEMO)

Introduction

Thank you for purchasing a Panasonic product. Before you use the product, please carefully read through the installation instructions and the manuals, and understand them in detail to use the product properly.

Types of Manuals

- There are different types of manuals for the GM1 series, as listed below. Please refer to a relevant manual for the unit and purpose of your use.

These manuals can be downloaded from our website: <https://industry.panasonic.com/global/en/products/fasys/plc/mc/gm1>

Manuals for GM1 series

Manual name	Manual code	Manual description
GM1 Series Reference Manual (Hardware Edition)	WUME-GM1H	Explains the functions and performance of each GM1 unit.
GM1 Series Reference Manual (Instructions Edition)	WUME-GM1PGR	Explains the specifications of each instruction that can be used with the GM1 Series.
GM1 Series Reference Manual (Analog I/O Unit Edition)	WUME-GM1AIO	Explains the functions and performance of the GM1 Analog Expansion Unit.
GM1 Series Reference Manual (Pulse Output Unit Edition)	WUME-GM1PG	Explains the functions and performance of the GM1 Pulse Output Unit.
GM1 Series Reference Manual (Serial Communication Unit Edition)	WUME-GM1SC	Explains the functions and performance of the GM1 Serial Communication Unit.
GM1 Series User's Manual (Operation Edition)	WUME-GM1OP	Explains how to use GM Programmer and PANATERM Lite for GM, set up each function, create projects, and perform other operations.

Copyright / Trademarks

- The copyright of this manual belongs to **Panasonic Industry Co., Ltd.**
- Unauthorized reproduction of this manual is strictly prohibited.
- Windows is a registered trademark of Microsoft Corporation in the U.S. and other countries.
- Ethernet is a registered trademark of FUJIFILM Business Innovation Corp. and Xerox Corporation.
- EtherCAT is a registered trademark of and patented technology licensed by Beckhoff Automation GmbH, Germany.
- EtherNet/IP is a registered trademark of ODVA (Open DeviceNet Vendor Association).
- SDHC and SD logos are trademarks of LLC.
- Other company and product names are trademarks or registered trademarks of their respective companies.

Compliance with IEC 61131

International standard IEC 61131 is the international common standards in which the International Electrotechnical Commission (IEC) defines programming languages for PLC. IEC defines the following five programming languages:

- Ladder Diagram (LD)
- Structured Text (ST)
- Sequential Function chart (SFC)

- Function Block Diagram (FBD)
- Instruction List (IL)

Glossary

■ RTEX

Stands for Realtime Express, which is the name of the motion-specific network connecting the GM1 Controller RTEX and servo amplifier.

* Realtime Express is the name of the network servo system manufactured by Panasonic Corporation.

■ GM Programmer

A configuration tool for the GM1 Controller RTEX. Using GM Programmer makes it possible to set positioning data and various positioning parameters, and perform various monitoring. As this tool is equipped with tool operation mode that starts a motor independently without using user programs, it is convenient especially to verify operations at the time of initial startup.

■ PANATERM Lite for GM

A setup support tool for the MINAS series servo amplifiers manufactured by Panasonic Corporation. When GM Programmer is installed, "PANATERM Lite for GM" is also installed at the same time. By using this tool, parameter setup within servo amplifiers, control status monitoring, setup support, machine analysis, and other operations can be executed on the PC screen.

■ P-point control

Refers to control passing through a "Pass Point". In this manual, this control is referred to as "P-point control" for the sake of convenience.

This method is used when target multi-stage velocities are specified in a sequence of motions.

■ C-point control

Refers to control passing through a "Continuance Point". In this manual, this control is referred to as "C-point control" for the sake of convenience. This method is used to execute consecutive E-point controls by one-time startup.

■ E-point control

Refers to movement up to an "End Point". In this manual, this control is referred to as "E-point control" for the sake of convenience. This method is used for single-speed acceleration / deceleration control. It is also called "trapezoidal control".

■ Automatic operation

An operation that is automatically performed. It means position control.

■ Manual Operation

An operation that is performed at initial startup or during adjustment. Home return, JOG operation, and pulser operation are manual operations.

■ Position control

A generic term for E-point control, P-point control, and C-point control. For each control, control for single axes and interpolation control for multiple axes can be performed. Interpolation control can be selected from 2-axis linear interpolation, 2-axis circular interpolation, and 3-axis linear interpolation.

■ Home return

The reference position for positioning is called a home position and an operation to travel to a home position is called home return. Each axis is moved to the preset home position and the coordinates of the home position are defined as absolute position zero. The motor rotation is reversed automatically when the limit input (+) or the limit input (-) is input and the home position or near home position is searched to return to the home position automatically.

■ JOG operation

Refers to an operation in which the motor is rotated only while operation commands are being input. This is used to forcibly rotate the motor using inputs from external switches during startup or adjustment, for example. This can also be applied to unlimited feed.

■ Limit input (+), limit input (-)

A limit switch input that is used to limit the motor movement. Limit input (+) is the limit point on the side where the elapsed value increases and limit input (-) is the limit point on the side where the elapsed value decreases.

■ Dwell time

For E-point control, the time from the completion of a position command until the operation done contact turns ON can be specified as a dwell time. For C-point control, similarly, the time from deceleration stop until execution of the next positioning table can be specified as a dwell time.

■ Software limit

Limits in software can be set for the absolute coordinates managed by the GM1 Controller. The motor decelerates and stops according to the deceleration of the dynamic limit so as not to exceed the soft limit range. Deceleration time can be set individually.

■ Torque control

The output torque of the servo amplifier can be limited arbitrarily.

■ Servo ON / Servo OFF

The operation that changes the servo free state to a servo lock state is called "servo ON", and the operation that changes the servo lock state to a servo free state is called "servo OFF".

■ Linear interpolation

Interpolation control that controls straight lines as loci for the operations of 2-axis motors with grouped X-axis and Y-axis or 3-axis motors with grouped X-axis, Y-axis, and Z-axis. There are two setting methods, which are a composite speed specification and long axis speed specification.

■ Circular interpolation

Interpolation control that controls arcs as loci for the operation of 2-axis motors with grouped X-axis and Y-axis. There are two setting methods, which are a center point specification and pass point specification.

■ Edge Detection

One of the methods for detecting the request signals allocated to this unit. It executes each requested process by detecting a trigger that is the rising edge when the request signal turns ON.

Therefore, the next request cannot be accepted until the current request signal turns OFF.

(MEMO)

Table of Contents

1 Before Using This Product.....	1-1
1.1 Safety Precautions.....	1-2
1.2 Security precautions	1-3
1.3 Handling Precautions.....	1-4
1.4 Software License Agreement.....	1-5
2 GM1 function overview.....	2-1
2.1 System Configuration Diagram.....	2-2
2.2 Product Lineup.....	2-4
2.2.1 GM1 controller	2-4
2.2.2 Expansion Unit.....	2-4
2.3 Functional limitations	2-6
2.3.1 Restrictions on the Number of Expansion Units	2-6
2.3.2 Version limitations	2-6
2.3.3 Restrictions on Functions.....	2-7
3 Overview of the GM Programmer.....	3-1
3.1 System Requirements.....	3-2
3.1.1 Usage Environment of the GM Programmer.....	3-2
3.2 Version System	3-3
3.2.1 Version Relationship	3-3
3.3 Installation and Uninstallation	3-6
3.3.1 Installing GM Programmer	3-6
3.3.2 Uninstalling GM Programmer.....	3-11
3.4 Basic Operations.....	3-12
3.4.1 How to start.....	3-12
3.4.2 How to quit.....	3-13
3.5 Component Names	3-14
3.5.1 Menu Bar	3-14
3.5.2 Toolbar	3-24
3.5.3 Navigator Pane	3-28
3.5.4 Main Pane.....	3-30
3.5.5 Status Bar	3-31
3.6 Window Operations.....	3-32
3.6.1 Moving the Pane Location	3-32
3.6.2 Showing / Hiding Panes.....	3-34
3.6.3 Switching the Tab of the Main Pane.....	3-35
3.6.4 Operating the Object Window	3-36
3.6.5 Full-screen Display	3-37
3.7 Other Functions	3-39
3.7.1 Option Setting Function	3-39
3.7.2 Display Language Setting Function	3-41
3.7.3 Version Display Function	3-43
3.7.4 Customize function	3-45

4 Project Operations	4-1
4.1 Project Creation Flow.....	4-2
4.2 Project operations	4-3
4.2.1 Creating a New Project	4-3
4.2.2 Device Tree Configuration	4-6
4.2.3 Project Configuration	4-8
4.2.4 Saving a Project.....	4-9
4.2.5 Closing a Project.....	4-10
4.2.6 Opening a Project	4-11
4.3 Setting up the GM1 Controller	4-12
4.4 Adding Objects.....	4-13
4.4.1 List of objects	4-16
4.5 Other project settings.....	4-17
4.5.1 Setting up a Project.....	4-17
4.5.2 Setting up a project save	4-19
4.5.3 Printing a Project and Object	4-23
4.5.4 Comparing Projects	4-26
4.5.5 Exporting and Importing Objects.....	4-31
4.5.6 Project File Conversion.....	4-35
4.5.7 Saving and unzipping the project archive	4-39
5 Program Creation.....	5-1
5.1 Flow of Program Creation.....	5-3
5.2 Program Creation Window.....	5-4
5.2.1 Main Pane.....	5-4
5.2.2 Declaration Editor	5-5
5.2.3 Auto Declaration	5-8
5.2.4 Toolbox.....	5-10
5.2.5 Setting up the Program Input Window	5-10
5.2.6 Window Operations for the Program Input Window.....	5-15
5.3 Creating a Program Object (POU Object).....	5-16
5.4 Types of Programming Language.....	5-17
5.5 Function and Function Block.....	5-20
5.5.1 Function	5-20
5.5.2 Function Block	5-24
5.6 User Library Function.....	5-27
5.6.1 Creating a Library and Adding to the Library Repository	5-28
5.6.2 Using Created Libraries	5-34
5.7 POU for implicit checks.....	5-36
5.7.1 Setting up POU for implicit checks.....	5-36
5.8 Tasks.....	5-38
5.8.1 Adding Programs	5-39
5.8.2 Adding a UserTask	5-43
5.8.3 Task Configuration Window	5-45
5.9 Build.....	5-47
5.9.1 Build	5-47
5.9.2 Rebuild.....	5-47
5.9.3 Code Generation.....	5-48

5.9.4 Clean.....	5-49
5.9.5 Clean All.....	5-50
5.10 Program Creation Support Functions	5-51
5.10.1 Bookmark.....	5-51
5.10.2 Call Tree View.....	5-52
5.10.3 Cross reference List View	5-53
5.10.4 Function Block Guidance	5-54
5.10.5 Short Form Function	5-58
5.10.6 Input Assistant Function.....	5-59
5.10.7 Argument / Variable Input Support (Component List)	5-60
5.10.8 Global Renaming (Refactoring)	5-61
5.10.9 Code Analysis (Static Analysis Light)	5-64
5.10.10 Displaying Programs in Multiple Languages (Project Localization).....	5-67
5.10.11 Start Instruction Help Function	5-71

6 Entering programs in each Programming language and Variable ...6-1

6.1 Programming in Ladder Diagram (LD).....	6-2
6.1.1 Inserting Contacts, Coils, and Function Blocks.....	6-2
6.1.2 Inserting Contacts in Parallel	6-7
6.1.3 Inserting a Network (Circuit)	6-9
6.1.4 Inserting a Branch.....	6-10
6.1.5 Input of Title and Comment (LD).....	6-11
6.1.6 Commenting out a Network (Circuit).....	6-13
6.2 Programming in Structured Text (ST)	6-14
6.2.1 ST Program Syntax.....	6-14
6.2.2 Commenting out Code in ST Program.....	6-16
6.3 Programming in Sequential Function Chart (SFC)	6-18
6.3.1 Inserting Elements from Menu	6-18
6.3.2 Inserting Elements from Toolbox.....	6-20
6.3.3 Inserting Elements from Toolbar	6-22
6.3.4 Setting up the SFC Editor	6-23
6.3.5 Setting SFC Program Execution Conditions	6-25
6.4 Programming in Function Block Diagram (FBD).....	6-27
6.4.1 Entering Function Blocks	6-27
6.4.2 Inserting and Commenting out a Network (Circuit)	6-32
6.4.3 Input of Title and Comment (FBD)	6-32
6.4.4 Settings in FBD Program	6-33
6.5 Programming in Instruction List (IL).....	6-34
6.5.1 Entering Instructions and Operands	6-34
6.5.2 Settings in IL Program	6-37
6.6 Programming in Continuous Function Chart (CFC).....	6-38
6.6.1 Inserting and Connecting Elements	6-39
6.6.2 Connection Mark.....	6-43
6.7 Variables	6-44
6.7.1 Standard Data Types	6-44
6.7.2 STRING type.....	6-45
6.7.3 WSTRING type	6-45
6.7.4 Array	6-46
6.7.5 Subrange Types.....	6-47

6.7.6 Structure, Enumeration, Alias, and Union Data Types.....	6-48
6.7.7 Constants.....	6-52
6.7.8 Object for Global Variable Declaration.....	6-53
6.7.9 Global Variables.....	6-54
6.7.10 Persistent Variables.....	6-56

7 Connecting the GM1 Controller and PC7-1

7.1 Flow of Operation Check.....	7-2
7.2 Connecting the GM1 Controller and PC.....	7-3
7.2.1 Selecting a Connection Port for GM Programmer.....	7-3
7.2.2 Connecting the GM1 Controller and PC with a Cable.....	7-3
7.3 Communication Setting.....	7-4
7.3.1 Setting the LAN Port.....	7-4
7.3.2 Adding USB Ports.....	7-5
7.4 Time Function.....	7-7
7.4.1 Settings Based on GM Programmer.....	7-7
7.4.2 Settings Based on Function Blocks.....	7-7
7.5 Connecting to the GM1 Controller.....	7-8
7.6 Login / Logout.....	7-10
7.6.1 Login.....	7-11
7.6.2 Logout.....	7-12
7.6.3 Download.....	7-12
7.6.4 Online Change.....	7-14
7.7 Source Upload.....	7-15
7.8 Other Settings.....	7-17
7.8.1 Changing the Device Name.....	7-17
7.8.2 Sending Echo services.....	7-18
7.8.3 Device preference management.....	7-20
7.8.4 Confirmed online mode.....	7-22

8 Debug8-1

8.1 Running and Stopping the GM1 Controller.....	8-3
8.1.1 Running and Stopping the GM1 Controller.....	8-3
8.1.2 Single Cycle.....	8-4
8.2 Breakpoint.....	8-6
8.2.1 Setting a Breakpoint.....	8-6
8.2.2 Setting an Execution Point.....	8-8
8.2.3 Call Stack View.....	8-10
8.3 Debug Operations.....	8-11
8.3.1 Writing Values and Forcibly Changing Values.....	8-11
8.3.2 Watch.....	8-13
8.3.3 Flow Control.....	8-14
8.4 Monitoring Function.....	8-16
8.5 Simulation Function.....	8-19
8.6 Trace Function.....	8-20
8.6.1 Setting up Trace.....	8-20
8.6.2 Trace Menu.....	8-29
8.6.3 Executing Trace.....	8-33

8.6.4 Saving Trace	8-34
8.7 Visualization Function	8-39
8.7.1 Setting of Visualization	8-40
8.7.2 Setting of TextList	8-56
8.7.3 List of Available Tool Elements	8-64
8.7.4 List of Properties of Tool Elements	8-65
8.7.5 Visualization examples	8-86
8.8 Reset of Controller	8-97
8.8.1 Reset Warm, Reset Cold, and Reset Origin	8-98
8.8.2 Executing Device Reset from GM Programmer	8-99
8.8.3 Executing Device Reset from GM1 Controller	8-100
8.9 Checking the Status of GM1 Controller	8-101
8.9.1 Checking Logs	8-101
8.9.2 Checking the Status	8-103
8.9.3 Checking the System Data History	8-104
8.9.4 Task Monitoring	8-104
8.9.5 Device Trace Function	8-105
8.10 Checking the Performance of GM1 Controller	8-112
8.10.1 Checking Missing RTEX Command or EtherCAT Packets	8-112
8.10.2 Performance Check Based on Device Trace	8-114
8.11 Error Notification Function	8-116
8.11.1 Overview of Errors	8-116
8.11.2 Checking and Clearing Errors Using GM Programmer	8-117
8.11.3 Obtaining Error Information Using User Programs	8-118
8.11.4 Error Recovery Processing	8-121
8.11.5 Error Code List	8-123
9 Motion Control	9-1
9.1 Basic Setting	9-2
9.1.1 Setting the Master axis	9-2
9.1.2 Basic Settings of the Axis	9-2
9.1.3 Axis Extended Setting	9-7
9.1.4 Adding and Setting up Free Encoder and Virtual Drive	9-15
9.2 Initial Setup for Servo Amplifiers	9-19
9.2.1 RTEX parameter settings for servo amplifier	9-21
9.2.2 EtherCAT parameter settings for servo amplifier	9-22
9.3 Preparation for Operation	9-23
9.3.1 Checking Wiring	9-23
9.3.2 Checking Safety Circuit Design	9-24
9.3.3 Operation Mode Switching	9-28
9.3.4 Operation Check	9-29
9.4 Operation up to running	9-32
9.4.1 Servo ON or OFF	9-32
9.4.2 Commissioning	9-33
9.5 Single-axis Operation	9-35
9.5.1 Overview of Single-axis Operation	9-35
9.5.2 Switching the Control Mode	9-35
9.6 Synchronous Control	9-37
9.6.1 Overview of Synchronous Control	9-37

9.7	Cam synchronous Control	9-38
9.7.1	Overview of Cam Control and How to Use It	9-38
9.7.2	Creating Cam Data	9-41
9.7.3	Types and Setting of Cam Curves	9-61
9.7.4	Cam Control (POU Programming)	9-74
9.8	CNC Control.....	9-75
9.8.1	Overview of CNC Control and How to Use It	9-75
9.8.2	Creating a CNC Program	9-77
9.8.3	Import DXF File Function	9-85
9.8.4	Dynamical Analysis for CNC Program	9-89
9.9	Motion Function Errors.....	9-91
9.9.1	Overview of Motion Function Errors.....	9-91
9.9.2	Error Check Method	9-92
9.9.3	Clearing Errors.....	9-93
10	EtherCAT Function.....	10-1
10.1	EtherCAT Axis Settings.....	10-2
10.1.1	Setting up the EtherCAT master	10-2
10.1.2	EtherCAT Slave Settings.....	10-7
10.1.3	Adding and Setting up Servo Amplifiers	10-14
10.1.4	Setting an Address for Each Servo Amplifier.....	10-19
10.2	Conducting Commissioning for Servo Amplifiers.....	10-20
10.3	Home Return.....	10-22
10.4	Functional limitations	10-23
10.4.1	Restrictions on the Combination of the GM1 Controller and Servo Amplifiers	10-23
10.4.2	Restrictions on Servo Amplifier Parameters	10-23
11	RTEX Function	11-1
11.1	Setting up the RTEX axis	11-2
11.1.1	Setting up the RTEX master.....	11-2
11.1.2	Adding and Setting up Servo Amplifiers.....	11-3
11.1.3	Setting an Address for Each Servo Amplifier	11-6
11.2	Conducting Commissioning for Servo Amplifiers.....	11-7
11.3	Home Return.....	11-11
11.3.1	Types of home return	11-11
11.3.2	DOG method 1 [Edge detection of near home switch + Home position (Z phase) based on front edge]	11-13
11.3.3	DOG method 2 (Edge detection of near home switch).....	11-14
11.3.4	DOG method 3 [Edge detection of near home switch + Home position (Z phase) based on rear edge].....	11-15
11.3.5	Limit method 1 [Edge detection of limit switch + Home position (Z phase) based on front edge].....	11-16
11.3.6	Limit method 2 (Edge detection of limit switch).....	11-17
11.3.7	Home position method [Edge detection of home position (Z phase)].....	11-17
11.3.8	Stop-on-contact method 1	11-18
11.3.9	Stop-on-contact method 2 [Stop-on-contact detection + Home position (Z phase) based on front edge]	11-18
11.3.10	Data set method	11-19

11.3.11 High-speed home return	11-19
11.3.12 Settings and operations of home return	11-19
11.4 Functional limitations.....	11-21
11.4.1 Restrictions on the Combination of the GM1 Controller and Servo Amplifiers	11-21
11.4.2 Restrictions on Servo Amplifier Parameters.....	11-21
12 Unit Function	12-1
12.1 Overview of Unit Control	12-2
12.2 Setting up the GM1 units	12-3
12.2.1 IO Parameters for Unit Control	12-5
12.2.2 I/O Mapping for Unit Control	12-6
12.2.3 General-purpose I/O	12-7
12.2.4 PWM Output	12-12
12.2.5 High-speed Counter Function	12-23
12.3 Expansion unit settings.....	12-73
12.3.1 Adding Expansion Units	12-73
12.3.2 Settings of I/O Unit.....	12-76
12.3.3 Analog I/O Unit.....	12-79
12.3.4 Pulse Output Unit.....	12-79
12.3.5 Serial Communication Unit	12-79
13 Communication Function.....	13-1
13.1 Overview of Communication Function	13-3
13.1.1 Adding a Protocol to Be Used for the LAN Port	13-3
13.1.2 Adding Serial Communication Devices	13-8
13.1.3 List of Devices.....	13-10
13.2 General-purpose Communication	13-11
13.2.1 General-purpose Communication (Ethernet)	13-11
13.2.2 General-purpose Communication (Serial)	13-12
13.3 MODBUS	13-13
13.3.1 What is Modbus TCP?	13-13
13.3.2 Modbus-TCP Master Communication	13-13
13.3.3 Modbus-TCP Slave Communication	13-18
13.3.4 Modbus-RTU Master Communication.....	13-21
13.3.5 Modbus-RTU Slave Communication.....	13-29
13.4 EtherNet/IP	13-33
13.4.1 What is EtherNet/IP?	13-33
13.4.2 Cyclic Communication Function.....	13-33
13.4.3 EtherNet/IP Scanner Function	13-33
13.4.4 Setting up the EtherNet/IP Scanner Function	13-34
13.4.5 EtherNet/IP Scanner Operation	13-41
13.4.6 EtherNet/IP Adapter Function	13-44
13.4.7 Setting up the EtherNet/IP Adapter Function.....	13-44
13.4.8 EtherNet/IP Adapter Operation	13-50
13.5 Communicating with Display Units.....	13-51
13.5.1 Symbol Configuration.....	13-51
13.6 OPC UA Server.....	13-55
13.6.1 What is OPC UA?	13-55

13.6.2	OPC UA Server Settings.....	13-55
13.6.3	OPC UA Server Specifications	13-56
13.6.4	Security Settings	13-57
13.7	FTP Server Function.....	13-58
13.7.1	Overview of FTP Server Function.....	13-58
13.7.2	Setup Procedure	13-58
13.7.3	List of Setting Items	13-59
13.7.4	FTP Server Standards	13-60
13.7.5	SSL/TLS Certificate Settings	13-61
13.8	MQTT Client.....	13-63
13.8.1	What is MQTT?.....	13-63
13.8.2	MQTT Client Specifications	13-64
13.9	DNS client.....	13-67
13.9.1	What is DNS?	13-67
13.10	NTP client	13-68
13.10.1	What is NTP?.....	13-68
14	Management Function.....	14-1
14.1	Security Function	14-2
14.1.1	User Management	14-3
14.1.2	Encryption	14-16
14.1.3	Write-protection.....	14-24
14.2	Interface Function	14-26
14.2.1	Setting up an Interface Object	14-26
14.2.2	Implementing in New Function Block.....	14-29
14.2.3	Implementing in Existing Function Block	14-31
14.2.4	Extending the Interface	14-35
14.3	SD Card Access Function.....	14-37
14.3.1	Overview of SD Card Access Function.....	14-37
14.3.2	File Manipulations Using the CAA File Library.....	14-38
14.4	External File Functions	14-39
14.4.1	Setting up an External File Object	14-39
14.5	Recipe Manager Functions.....	14-41
14.5.1	Setting the Recipe Manager	14-41
14.5.2	Setting the Recipe Definition.....	14-44
14.5.3	Recipe Operation Using the GM Programmer	14-46
14.5.4	Recipe operation using instructions in the POU	14-49
14.5.5	Saving and restoring persistent variables	14-53
14.6	Project Management Function	14-56
14.6.1	What is Project Management Function?	14-56
14.6.2	Backup (Operation by the controller)	14-58
14.6.3	Restore (Operation by the controller).....	14-59
14.6.4	Backup and Restoration (Function Blocks).....	14-60
14.7	Firmware Version Upgrade Function	14-61
14.7.1	Checking Unit Configuration	14-61
14.7.2	Unit Version Upgrade.....	14-62
14.8	Servo Amplifier / Motor Operation Function (PANATERM Lite for GM).....	14-64
14.8.1	Starting PANATERM Lite for GM	14-64

15 Overview of PANATERM Lite for GM.....	15-1
15.1 System Requirements.....	15-3
15.1.1 Operating Environment of PANATERM Lite for GM.....	15-3
15.2 Installation and Uninstallation	15-4
15.2.1 Installing PANATERM Lite for GM.....	15-4
15.2.2 Uninstalling PANATERM Lite for GM	15-4
15.3 Connecting with servo amplifier	15-5
15.3.1 Connecting the Servo Amplifier and PC	15-5
15.3.2 Disconnecting the Servo Amplifier from the PC.....	15-5
15.4 Basic Operations.....	15-6
15.4.1 How to Start	15-6
15.4.2 How to Exit.....	15-10
15.5 Component Names	15-11
15.5.1 Menu Bar	15-12
15.5.2 Toolbar	15-13
15.5.3 Navigation Pane.....	15-13
15.5.4 Main Pane.....	15-14
15.5.5 Status Field	15-14
15.6 Window Operations.....	15-15
15.6.1 Moving the Pane Location	15-15
15.6.2 Switching the Tab of the Main Pane.....	15-16
15.7 Connection settings Servo Amplifier to the GM1 Controller	15-18
15.7.1 Selecting the Device to Connect.....	15-18
15.8 Parameter Window	15-26
15.8.1 Configuration of Parameters Window	15-26
15.8.2 Setting Parameters	15-28
15.8.3 Writing Parameters to Servo Amplifier	15-29
15.8.4 Copying Parameters	15-31
15.8.5 Switching the Input Format of Parameter Values.....	15-32
15.8.6 Setting I/O Pin Assignment.....	15-34
15.9 Object Window	15-36
15.9.1 Configuration of Object Window	15-36
15.9.2 Setting Objects.....	15-39
15.9.3 Writing Objects to Servo Amplifier	15-40
15.10 Monitor Window	15-42
15.10.1 Configuration of Monitor Window	15-42
15.10.2 Checking the Monitor Window	15-44
15.11 Alarm Window	15-45
15.11.1 Configuration of Alarm Window.....	15-45
15.11.2 Checking Alarms	15-48
15.12 Other Functions	15-50
15.12.1 Language Setting Function	15-50
15.12.2 Version Display Function	15-51
15.13 Troubleshooting	15-52
15.13.1 Troubleshooting for Servo Amplifiers and Motors	15-52
Appendix Warranty / Cautions for Proper Use.....	App-1
Warranty	App-2

Warranty Period App-2
Warranty Scope App-2
Cautions for Proper UseApp-3

1 Before Using This Product



1.1 Safety Precautions.....	1-2
1.2 Security precautions	1-3
1.3 Handling Precautions.....	1-4
1.4 Software License Agreement.....	1-5



1.1 Safety Precautions





1.1 Safety Precautions









This section explains important rules that must be observed to prevent personal injury and property damage.

- Injuries and damages that may occur as a result of incorrect use are classified into the following levels and safety precautions are explained according to the level.

 WARNING	Indicates that there is a risk of death or serious injury
 CAUTION	Indicates that there is a risk of minor injury or property damage

	Indicates an action that is prohibited
	Indicates an action that must be taken

 WARNING	
	• Take safety measures outside this product to ensure the safety of the entire system even if this product fails or an error occurs due to external factors.
	• Do not use this product in atmospheres that contain flammable gases. Doing so may result in explosion.
	• Do not throw this product into the fire. Doing so may cause the batteries or other electronic parts to explode.

 CAUTION	
	• To prevent abnormal heat generation or smoke generation, use this product with some leeway from the guaranteed characteristics and performance values of the product.
	• Do not disassemble or modify this product. Doing so may result in abnormal heat generation or smoke generation.
	• Do not touch any terminals while the power is on. Doing so may result in electrical shock.
	• Configure emergency stop and interlock circuits outside this product.
	• Connect wires and connectors properly. Failure to do so may result in abnormal heat generation or smoke generation.
	• Do not perform work (such as connection or removal) with the power turned on. Doing so may result in electrical shock.
	• If this product is used in any way that is not specified by Panasonic, its protection function may be impaired.
	• This product has been developed and manufactured for industrial use only.

1.2 Security precautions

When using this product, the following damages may occur.

- (1) Information leakage or outflow through this product
- (2) Fraudulent operation of this product by a malicious third party
- (3) Obstructing or stopping this product by a malicious third party

Sufficient network security measures, including the following measures, should be taken at your own risk to prevent such damages.

- Use this product on a network where safety is secured by using a firewall.
- When using this product on a system where a PC is connected, make sure that checking and cleaning of infection by computer virus or malicious program is performed periodically.
- In order to prevent malicious attacks, set user name and password to limit users who can log in.
- To prevent leakage of authentication information (user name, password), FTP server information, etc. on the network, take measures such as restricting access by user authentication.
- Be sure to close all browsers immediately after accessing this product as an administrator.
- Periodically change the administrator's password.
- Do not install this product in a location where the product or cables can be easily damaged.
- Furthermore, it is recommended that the product be used in an environment that has VPN (Virtual Private Network) or leased line network.





In addition, if this product is discarded, transferred, repaired, etc., important information recorded on this product or the SD memory card used may remain. At your own risk, please be careful when handling it, such as erasing it.

If you use this product, important information such as confidential information may remain on the terminal. When this product is no longer needed, take measures such as uninstalling this product from the terminal and deleting related files under the customer's responsibility.

1.3 Handling Precautions

1.3 Handling Precautions

- In this manual, the following symbols are used to indicate safety information that must be observed.

	Indicates an action that is prohibited or a matter that requires caution.
	Indicates an action that must be taken.
 Info.	Indicates supplemental information.
 Note	Indicates details about the subject in question or information useful to remember.
 Procedure	Indicates operation procedures.

1.4 Software License Agreement

Panasonic Industry Co., Ltd. ("PANASONIC") grants to you a license to use this Software on condition that you accept this Agreement. You must read this Software License Agreement (this "Agreement") carefully before using this Software. Only in case that you accept this Agreement, you may start your use of this Software.

Your unsealing the package of this Software, or your downloading, installing or launching this Software or the like shall be deemed as your acceptance of this Agreement.

The Software includes not only proprietary computer programs owned by or licensed by PANASONIC but also open source software programs. As for the open source software programs, refer to the detailed terms and conditions thereof shown in the installation package of the Software. Should a discrepancy arise between any of the terms of this Agreement and any open source software program license statement, the open source software program license statement shall take precedence over this Agreement.

Article 1 Grant of License

PANASONIC hereby grants to you a non-exclusive license to use this Software only in combination with PANASONIC product(s) specified in the manual of this Software (the "Product") in accordance with the terms of this Agreement. You may not use this Software in connection with products of any third party other than PANASONIC.

Article 2 Restrictions

You may NOT:

1. Modify, reverse engineer, decompile, or disassemble this Software, except where the terms and conditions of open source software program license statement (including, but not limited to, GPL and LGPL) apply.
Should a defect of the Software arise owing to your modification, reverse engineering, decompiling, or disassembling, to the extent permitted under the law, PANASONIC shall not assume any responsibility for such defect,
2. Use this Software by methods or for purposes other than those specified in the manual of this Software provided by PANASONIC, nor
3. Distribute, rent, lease or otherwise transfer this Software to any third party; provided, however, that you may assign the rights to use this Software under this Agreement along with the Product on the condition that the assignee agrees to be bound by all the terms of this Agreement. In the case of such assignment, you must deliver any and all the copies of this Software and all the accompanying materials to the assignee and you may not retain any copies of this Software including backups.

Article 3 Disclaimer

1. PANASONIC HEREBY DISCLAIMS ALL OTHER WARRANTIES ON THIS SOFTWARE, EITHER EXPRESS OR IMPLIED, INCLUDING BUT NOT LIMITED TO THE IMPLIED WARRANTIES OF MERCHANTABILITY, FITNESS FOR PARTICULAR PURPOSE, AND NON-INFRINGEMENT OF THIRD PARTY RIGHTS.
2. UNDER NO CIRCUMSTANCES SHALL PANASONIC BE LIABLE FOR ANY DAMAGES (INCLUDING DIRECT, INDIRECT, INCIDENTAL, CONSEQUENTIAL OR SPECIAL OR WHATSOEVER) ARISING OUT OF THE USE OF THIS SOFTWARE, INABILITY TO USE THIS SOFTWARE, DEFECTS IN THIS SOFTWARE (e.g., BUGS, SECURITY HOLES, AND MALFUNCTION), OR OTHERWISE IN CONNECTION WITH THIS SOFTWARE.

Article 4 Term

1. This Agreement shall come into effect upon your unsealing the package of this Software, or your downloading, installing or launching this Software or the like.

1.4 Software License Agreement

2. PANASONIC may terminate this Agreement immediately, if you breach any of the provisions of this Agreement.
3. You shall, at your own costs, return, delete or destroy this Software and any of its copies within four (4) weeks after termination of this Agreement.

Article 5 Export Control

You shall comply with all laws and regulations regarding export control under any competent jurisdiction, including but not limited to the Japanese Foreign Exchange & Foreign Trade Control Law, the export control regulations based on resolutions of the United Nations Security Council, etc. If any license or appropriate approval from a governmental authority is required under the applicable laws, you may not export this Software without such approval to any countries either directly or indirectly. Furthermore, you shall neither use nor sell this Software for military purposes either directly or indirectly.

Article 6 Intellectual Property Rights

Except the open source software program (including, but not limited to, GPL and LGPL), all intellectual property rights in this Software, including the copyright, belong to PANASONIC and/or the licensors of PANASONIC.

Article 7 Upgrade of this Software

1. Release of future upgrades or updates of this Software is not guaranteed and left to the sole discretion of PANASONIC. Furthermore, PANASONIC may charge fees for upgrading or updating of this Software.
2. If any upgrades or updates are provided to you either for fees or for free, such upgrades or updates shall be deemed as a part of this Software and shall be governed by this Agreement, unless PANASONIC designates otherwise at the time of provision of such upgrades or updates.

Article 8 Limitation on Liability

AGGREGATE LIABILITIES OF PANASONIC IN CONNECTION WITH THIS AGREEMENT OR THIS SOFTWARE SHALL IN NO EVENT EXCEED TEN THOUSAND (10,000) YEN.

Article 9 Governing Law and Jurisdiction

1. This Agreement shall be governed by the laws of Japan.
2. Should any dispute arise from or in connection with this Agreement, Osaka District Court, Japan shall exclusively have the jurisdiction over such dispute.

This Software consists of the following types of software.

1. Software developed independently by PANASONIC
2. Software owned by and licensed by the third party
3. Software licensed under GNU General Public License Version 2.0 (GPL V2.0)
4. Software licensed under GNU Lesser General Public License Version 2.0 (LGPL V2.0) or Version 2.1 (LGPL V2.1)
5. Open source software licensed on conditions other than those of GPL V2.0, LGPL V2.0, or LGPL V2.1

Software in categories 3. - 5. above is distributed with the expectation of effectiveness as a single piece of software, but there is no guarantee provided, including implied guarantees regarding viability as a product and/or suitability for specific purposes. For details, Please refer to the detailed terms and conditions thereof shown in the installation package of the Software.

For at least three years following the release of the Product, PID will provide, at customer's expense, complete machine-readable source code for software licensed under GPL V2.0, LGPL V2.0, LGPL V2.1, or a license based on other conditions that meet source code disclosure requirements, along with information on the respective copyright holders, to customers who contact us at the following e-mail address.

【Contact e-mail address: oss-cd-request@gg.jp.panasonic.com】

2 GM1 function overview

2.1 System Configuration Diagram	2-2
2.2 Product Lineup	2-4
2.2.1 GM1 controller	2-4
2.2.2 Expansion Unit	2-4
2.3 Functional limitations	2-6
2.3.1 Restrictions on the Number of Expansion Units	2-6
2.3.2 Version limitations	2-6
2.3.3 Restrictions on Functions	2-7

2.1 System Configuration Diagram

2.1 System Configuration Diagram

GM1 is a motion controller that integrates the PLC and motions.

It communicates with a host device and other various devices to provide a wide variety of motion control.

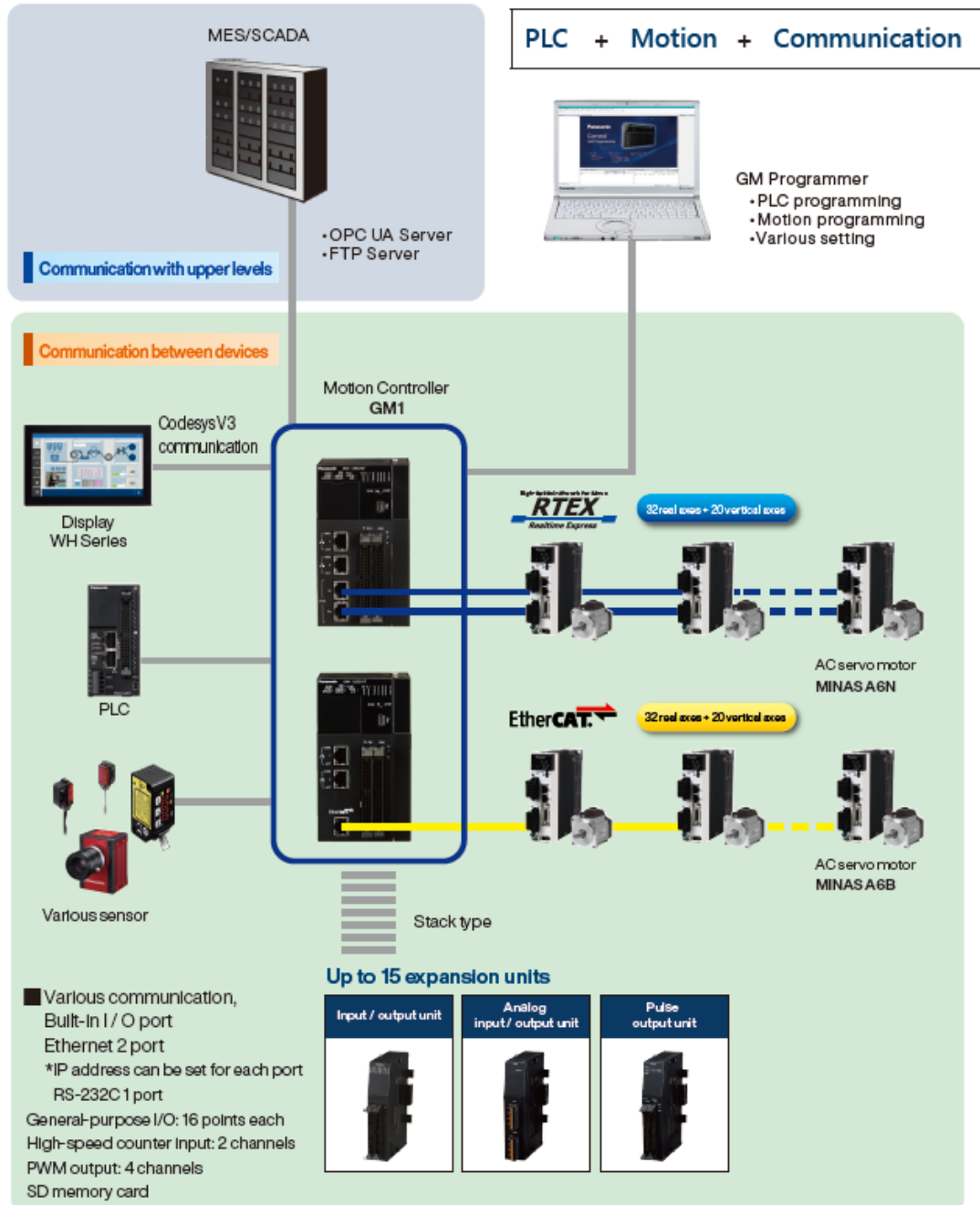

■ Overview of functions

Function name		Overview of the function
Program		Structure
		Union
		Enumeration
		IEC61131-3 (LD,ST,IL,FBD,SFC)
		G code(CNC)
		Synchronous cam control
Debug function		Online change
		Breakpoint
		Watch
		Monitoring function
		Simulation function
		Trace function
		Visualization function
Host communication function		FTP server
		SNTP
		OPC UA
		MQTT
Device-to-device communication function	Serial protocol	General-purpose communication
		MODBUS RTU master
		MODBUS RTU slave
	LAN protocol	TCP/IP
		UDP
		MODBUS TCP master
		MODBUS TCP slave
		Ethernet/IP
Management function	Security function	User management
		Encryption
		Write-protection
	Project management function	SD backup and SD restore using unit operations
		SD backup and SD restore using FBs
	Firmware version upgrade function	Firmware update using GM Programmer
	-	Interface function
	-	SD card access function
	-	External file functions
	-	Recipe Manager functions

2.2 Product Lineup

2.2 Product Lineup

2.2.1 GM1 controller

Name	Specifications						Product No.
	Communication	High-speed counter	PWM output	Input	Output	Number of axes controlled	
GM1controller	Ethernet : 2 ports RS-232C : 1 port	2 ch	4 ch	16 points	16 points Transistor output Sink Type (NPN)	RTEX Max. 32 axis	AGM1CSRX16T
					Transistor output Sink Type(NPN)	EtherCAT Max. 32 axis	AGM1CSEC16T
					Transistor output Source Type(PNP)		AGM1CSEC16P

2.2.2 Expansion Unit

Digital I/O Unit

Name	Specifications		Product No.
	Input	Output	
GM1 Digital Input Unit	64 points	—	AGM1X64D2
GM1 Digital Output Unit	—	64 points Transistor output Sink Type (NPN)	AGM1Y64T
		64 points Transistor output Source Type (PNP)	AGM1Y64P
GM1 Digital I/O Unit	32 points	32 points Transistor output Sink Type(NPN)	AGM1XY64D2T
		32 points Transistor output Source Type (PNP)	AGM1XY64D2P

Analog I/O Unit

Name	Specifications	Product No.
GM1 Analog Input Unit	8 ch voltage input / current input	AGM1AD8
GM1 Analog Output Unit	4 ch voltage output / current output	AGM1DA4

Pulse Output Unit

Name	Specifications	Product No.
GM1 Pulse Output Unit	4 axis Transistor output	AGM1PG04T
	4 axis Line driver output	AGM1PG04L

Serial Communication Unit

Name	Specifications	Product No.
GM1 Serial Communication Unit	RS-232C × 2ch	AGM1NSCS2
	RS-422A/485 × 2ch	AGM1NSCM2
	RS-232C × 1ch RS-422A/485 × 1ch	AGM1NSCS1M1

2.3 Functional limitations

2.3 Functional limitations

2.3.1 Restrictions on the Number of Expansion Units

Up to 15 expansion units can be mounted on the right side of the GM1 Controller.

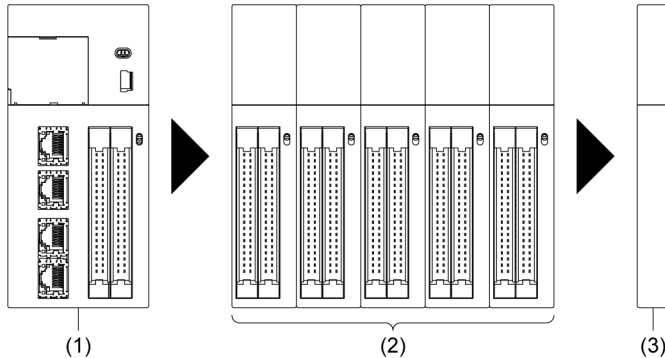

(1)	Controller	(2)	Expansion units	(3)	End unit
-----	------------	-----	-----------------	-----	----------



- Make sure to connect an end unit to the end of the system.

2.3.2 Version limitations

For the RTEX-compatible GM1 Controller and expansion units to be used, compatible GM Programmer versions are as follows.

Type	Model number	Version of GM Programmer
RTEX-compatible GM1 Controller (sink type)	AGM1CSRX16T	Ver.1.0 or later
Digital input (64 points)	AGM1X64D2	Ver.1.0 or later
Digital output (64 points) (sink type)	AGM1Y64T	Ver.1.0 or later
Digital output (64 points) (source type)	AGM1Y64P	Ver.1.2 or later
Digital I/O (64 points) (sink type)	AGM1XY64D2T	Ver.1.0 or later
Digital I/O (64 points) (source type)	AGM1XY64D2P	Ver.1.2 or later
Analog input (8 points)	AGM1AD8	Ver.1.2 or later
Analog output (4 points)	AGM1DA4	Ver.1.2 or later
Pulse output (transistor output type)	AGM1PG04T	Ver.1.2 or later
Pulse output (line driver output type)	AGM1PG04L	Ver.1.2 or later
Serial input/output (RS-232C × 2ch)	AGM1NSCS2	Ver.1.5 or later
Serial input/output (RS-422A/485 × 2ch)	AGM1NSCM2	Ver.1.5 or later
Serial input/output (RS-232C × 1ch, RS-422A/485 × 1ch)	AGM1NSCS1M1	Ver.1.5 or later

2.3.3 Restrictions on Functions

Function name	GM Programmer version
Firmware update function	Ver.1.2 or later
Recipe function (SD card)	Ver.1.2 or later
OPC UA function	Ver.1.3 or later
FTP server function	Ver.1.3 or later
Project management function (SD backup and SD restore by unit operation)	Ver.1.3 or later
Project archive function	Ver.1.3 or later
Tool customization function	Ver.1.3 or later
Recipe function (Backup and restore of persistent variables)	Ver.1.3 or later
Enable/Disable EtherCAT devices	Ver.1.4 or later
MQTT client function	Ver.1.4 or later
DNS client function	Ver.1.4 or later
SNTP client function	Ver.1.4 or later
Project management function (SD backup and SD restore by FB)	Ver.1.4 or later
Visualization function	Ver.1.4 or later
Expansion cam editor function	Ver.1.4 or later
Start instruction help function	Ver.1.4 or later
Source download timing configuration	Ver.1.5 or later
Symbol set function	Ver.1.5 or later

(MEMO)

3 Overview of the GM Programmer

3.1 System Requirements.....	3-2
3.1.1 Usage Environment of the GM Programmer.....	3-2
3.2 Version System.....	3-3
3.2.1 Version Relationship.....	3-3
3.3 Installation and Uninstallation.....	3-6
3.3.1 Installing GM Programmer.....	3-6
3.3.2 Uninstalling GM Programmer.....	3-11
3.4 Basic Operations.....	3-12
3.4.1 How to start.....	3-12
3.4.2 How to quit.....	3-13
3.5 Component Names.....	3-14
3.5.1 Menu Bar.....	3-14
3.5.2 Toolbar.....	3-24
3.5.3 Navigator Pane.....	3-28
3.5.4 Main Pane.....	3-30
3.5.5 Status Bar.....	3-31
3.6 Window Operations.....	3-32
3.6.1 Moving the Pane Location.....	3-32
3.6.2 Showing / Hiding Panes.....	3-34
3.6.3 Switching the Tab of the Main Pane.....	3-35
3.6.4 Operating the Object Window.....	3-36
3.6.5 Full-screen Display.....	3-37
3.7 Other Functions.....	3-39
3.7.1 Option Setting Function.....	3-39
3.7.2 Display Language Setting Function.....	3-41
3.7.3 Version Display Function.....	3-43
3.7.4 Customize function.....	3-45

3.1 System Requirements

3.1 System Requirements

3.1.1 Usage Environment of the GM Programmer

Programming software

Product name	Applicable language
GM Programmer	Japanese / English / Chinese

(Note 1) When GM Programmer is installed, MINAS setup support software "PANATERM Lite for GM" is installed at the same time.

Software operating environment

Item	Description
OS	Microsoft(R) Windows(R) 10 : 32bit/64bit Microsoft(R) Windows(R) 11 : 64bit
PC	PC with the following installed: <ul style="list-style-type: none">● Microsoft.NET Framework 4.6.1 or higher● Microsoft Visual C++ 2010 SP1 Redistributable Package (x86)● Microsoft Visual C++ 2010 SP1 Redistributable Package (x64)● Microsoft Visual C++ 2013 Redistributable Package (x86)● Microsoft Visual C++ 2013 Redistributable Package (x64)● Microsoft Visual C++ 2015 Update 3 Redistributable Package (x86)● Microsoft Visual C++ 2015 Update 3 Redistributable Package (x64)
HDD	At least 4 GB of free space
Memory	At least 8 GB
Communication port	LAN port (for Ethernet connection) USB 2.0 port (for USB connection)

3.2 Version System

This chapter explains versions used for GM Programmer and the GM1 controller.

3.2.1 Version Relationship

This chapter explains how GM Programmer versions, project versions, and firmware versions are related with one another.

■ Objects subject to version management

GM Programmer, project files, and firmware for the GM1 controller are each managed with four-digit version numbers.

Each version number is made up of four digits (A . B . C . D).

Version type	Description and way of checking version
GM Programmer version	The version of the GM Programmer installer can be checked by following " 3.7.3 Version Display Function ".
Project version	The version of project files created by GM Programmer. You can check it on the "Information" tab of the Device object. (described later)
Firmware version of GM1 controller	Please refer to " 14.7.1 Checking Unit Configuration " for the firmware version installed on the GM1 controller.

■ Relationship between GM Programmer versions and project versions

The version of GM Programmer indicates versions of projects that can be created. (The GM Programmer version provides only backward compatibility)

For example, with GM Programmer version 1.4.1.0, project version 1.4.1.0 and earlier of project files can be created.

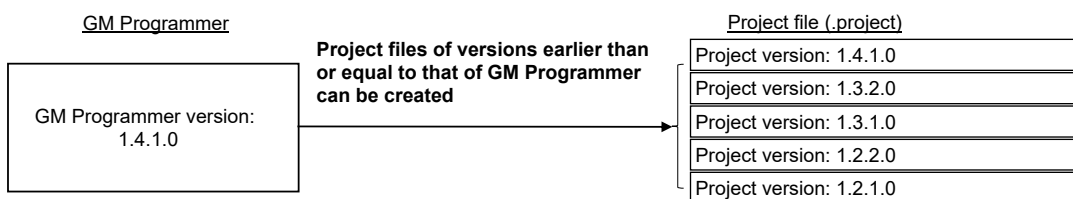

3.2 Version System

■ Relationship between project versions and GM1 controller firmware versions

When connecting to the GM1 controller, the first two digits (A . B) of the project version and the firmware version are required to match.

Combinations whereby connection is allowed are shown below.

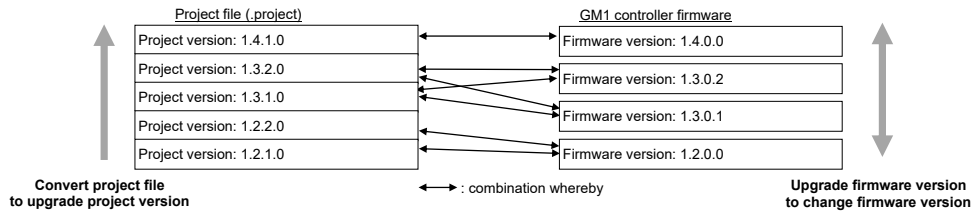

For example, if your PC with a project of project version 1.3.2.0 is connecting to the GM1 controller whose firmware version is 1.4.0.0, a message indicating connection failure appears because the first two digits of the versions do not match $1.3 \neq 1.4$.

To upgrade the project version and thereby make them match, perform "[Converting Project File \(.project\) Version](#)".

To downgrade the firmware version and thereby make them match, perform "[14.7.2 Unit Version Upgrade](#)" so that the firmware version is downgraded.

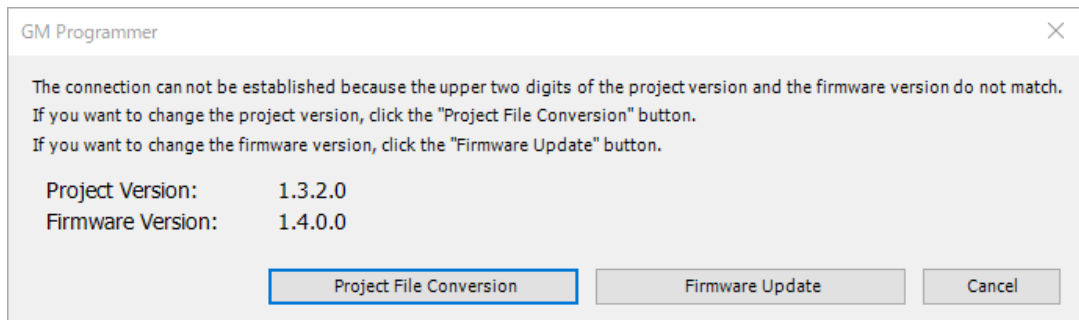

Note

- To create a library for users, select a template whose version is the same as the project version.

Example: When a library is used for projects of project version 1.4.1.0, select template version 1.4.1.0.

- The project version of a project you are editing can be confirmed at “Version” on the “Information” tab of the Device object.

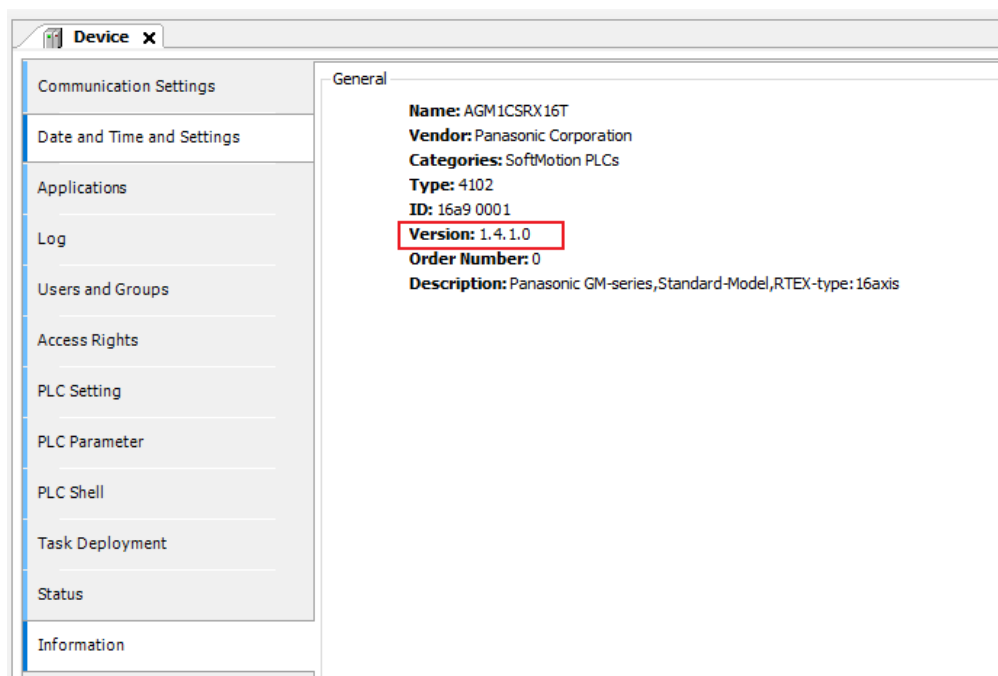

3.3 Installation and Uninstallation

3.3 Installation and Uninstallation

3.3.1 Installing GM Programmer

Before installing the GM Programmer on a PC, log on to the PC as an account with Administrator privileges.

If other applications are running, be sure to close all the applications before installing GM Programmer.

1 2 Procedure

1. Double-click "setup.exe".

The following window will be displayed. Click [OK].

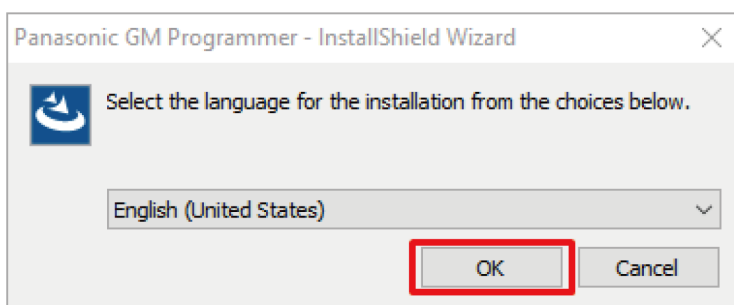

2. The following window will be displayed. Click [Install].

The display content differs according to the PC environment that you use. (This window may not be displayed at all, depending on the situation.)

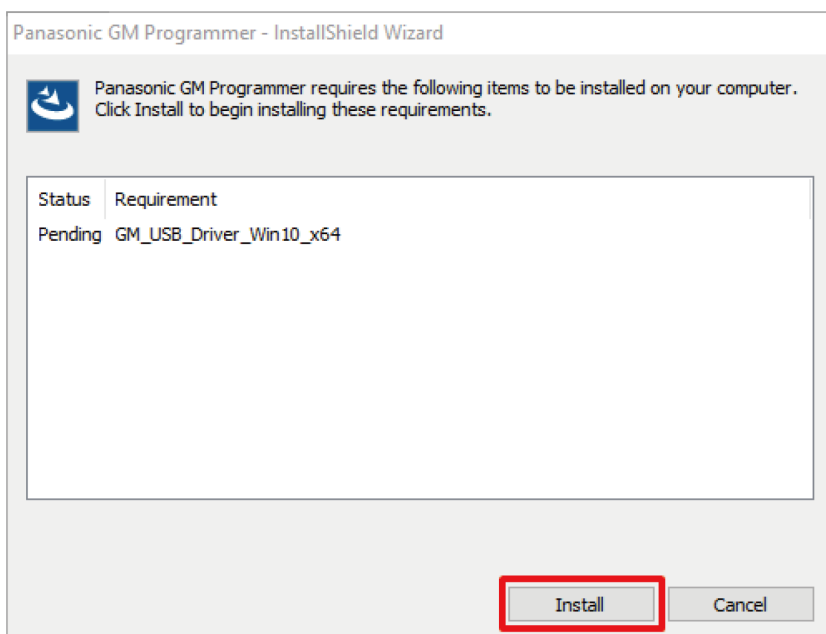

3. The following window will be displayed. Click [Next].

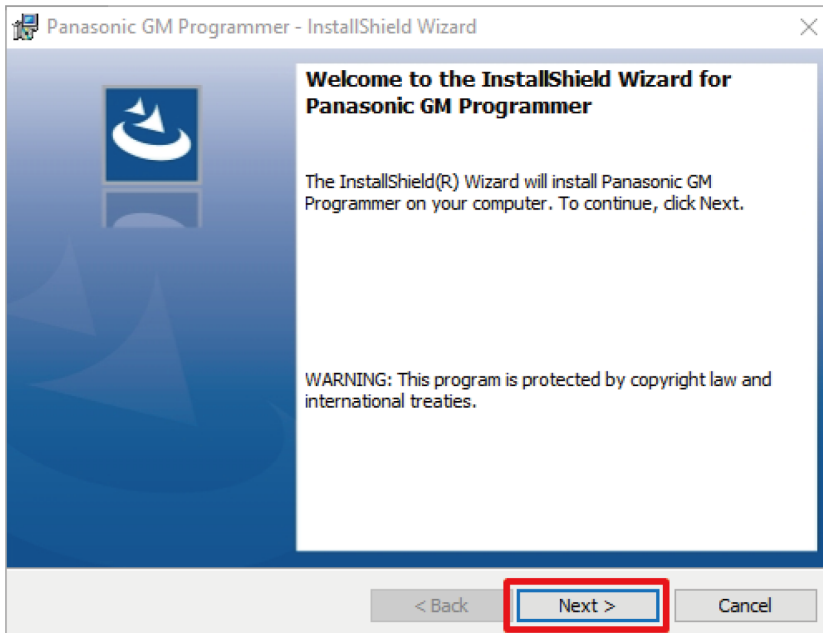

4. The following window will be displayed. Select [I accept the terms in the license agreement] and click [Next].

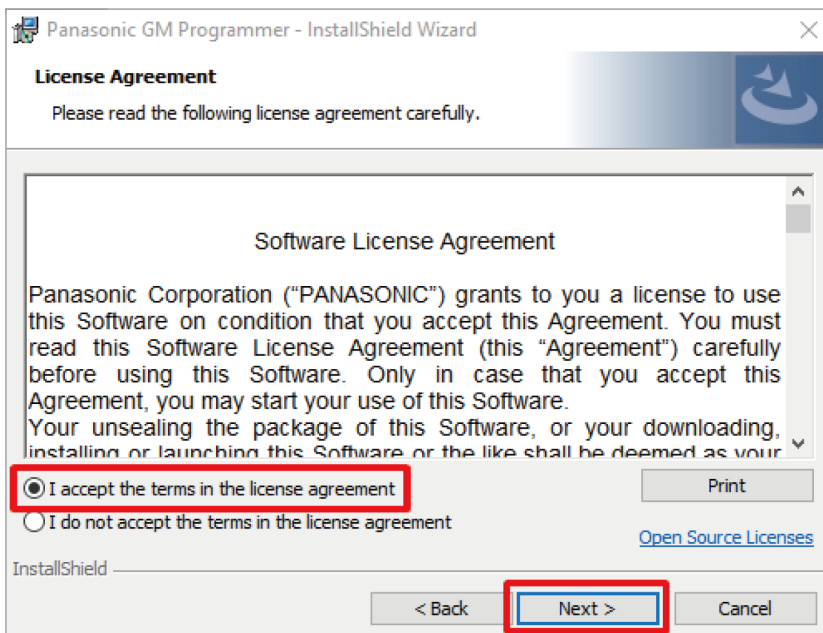

5. The following window will be displayed. If you change the installation destination folder, click [Change] and specify a desired installation destination. If you do not change the installation destination folder, click [Next].

3.3 Installation and Uninstallation

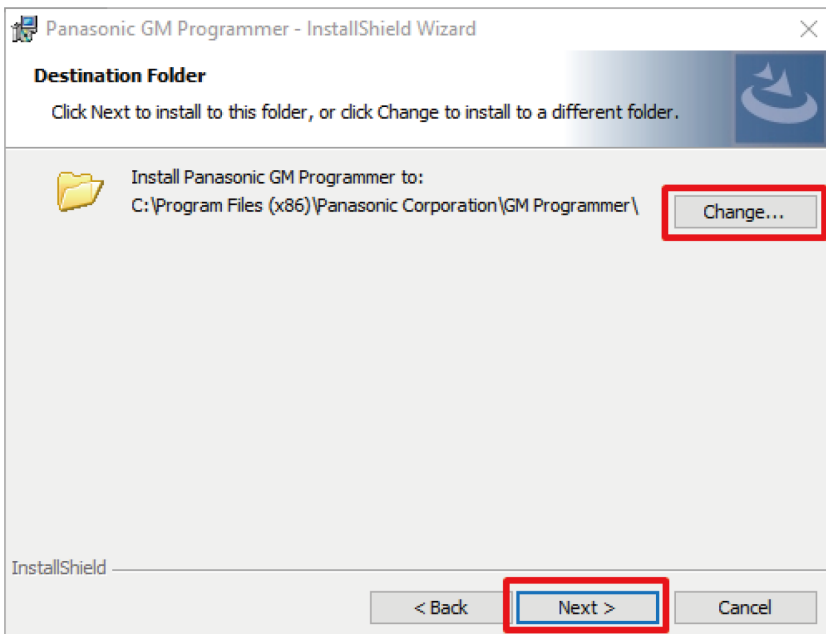

6. The window below will be displayed. Click [Install] to start the installation.

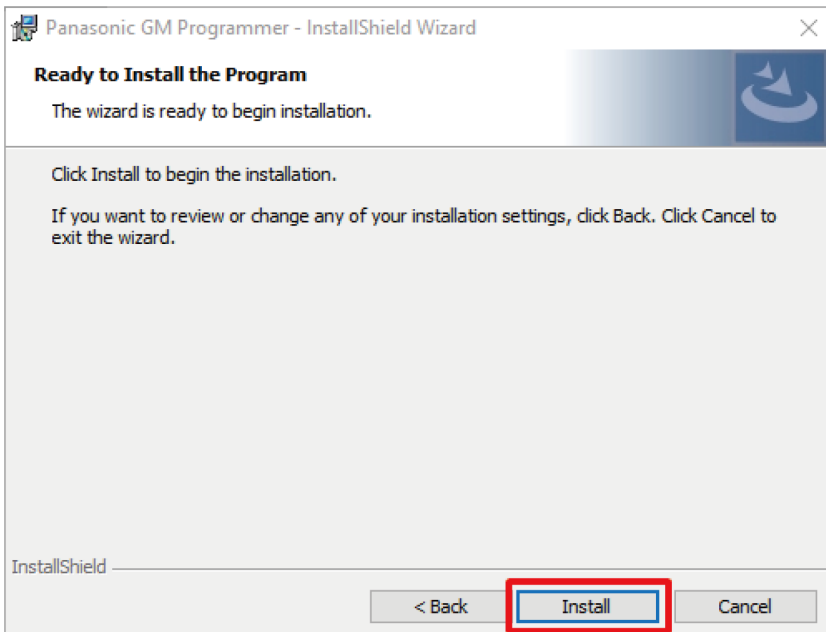

7. The following window will be displayed while the installation is in progress.

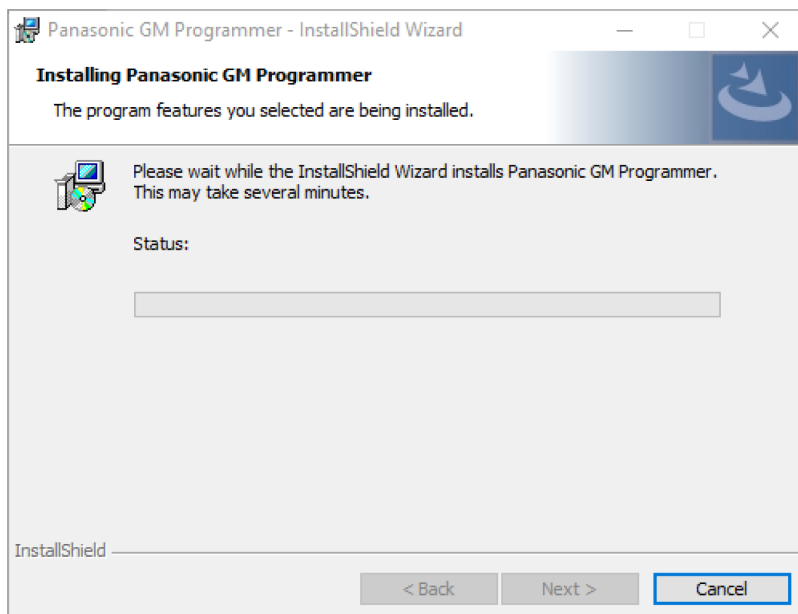

Following this installation, the three packages below will be installed. (The segments indicated by * differ according to the version of the software.)

- CODESYS SoftMotion*.*.*_P
- GMPLibrary (*.*.*)
- PANATERM-Lite for GM V*.*

These packages take a long time to install. Take care not to click [Cancel] while the installation is in progress.

8. When the installation of all the packages is completed, the following window will be displayed. Click [Finish].

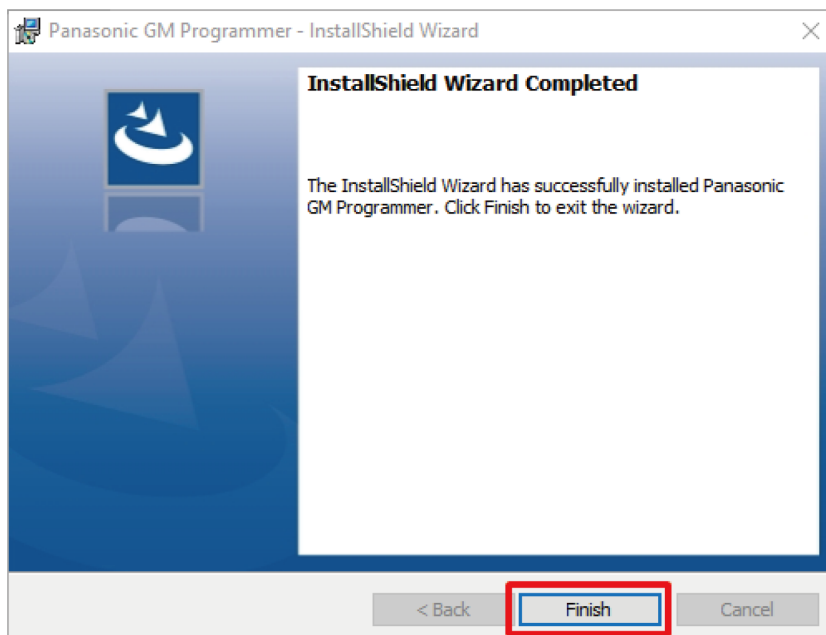

3.3 Installation and Uninstallation

This completes the installation procedure.

Info.

- When the GM Programmer is installed, PANATERM Lite for GM, Gateway (CODESYS Gateway), and CodeMeter applications are installed at the same time.

3.3.2 Uninstalling GM Programmer

1 2 Procedure

1. From the Start menu, select **Windows System>Control Panel**, and then click "Uninstall a program".
A list of installed programs will be displayed.
2. Double-click "Panasonic GM Programmer".
The following window will be displayed. [Yes]

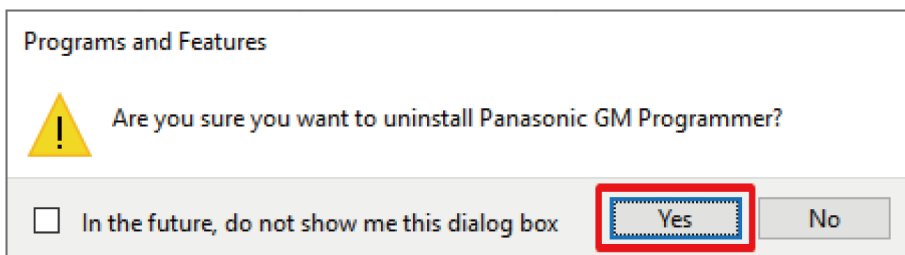

3. Click the [Yes] button.
The GM Programmer will be uninstalled.

i Info.

- When the GM Programmer is uninstalled, PANATERM Lite for GM and Gateway are also uninstalled at the same time.
- CodeMeter will not be uninstalled at this time. Uninstall it separately.

3.4 Basic Operations

3.4 Basic Operations

This section explains how to start and quit GM Programmer.

3.4.1 How to start

1 2 Procedure

1. Click the [Start] button and select **Panasonic Corporation>GM Programmer**. The "User Account Control" dialog box will be displayed. Click [Yes].

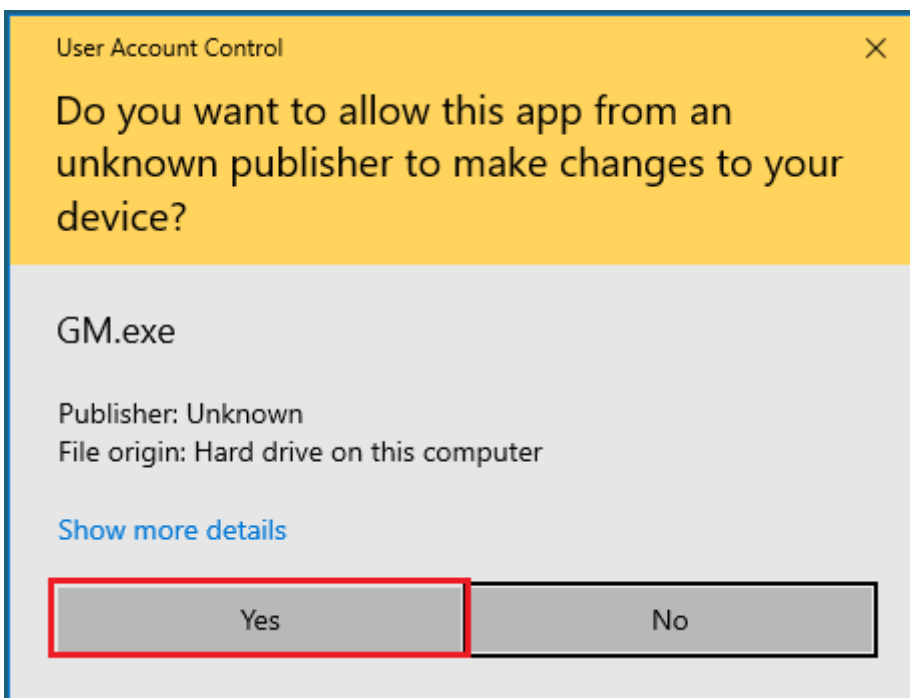

GM Programmer will be started.



3.4.2 How to quit



- Before closing GM Programmer, be sure to save any project files that you are editing and must save.

1 2

Procedure

1. From the menu bar, select **File>Exit**.
If changes have not been saved, the following window will be displayed.
If exiting without saving, select [No].
If changes need to be saved, select [Yes] to perform the save process.

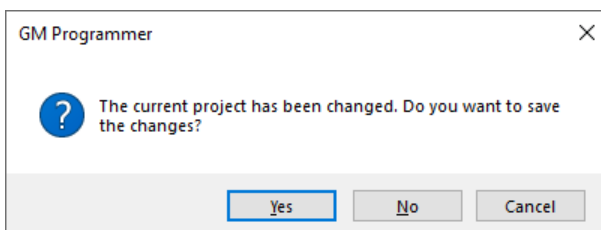

2. Click the [Yes] button.
GM Programmer will be closed.

Info.

- You can also close GM Programmer by clicking the [x] button on the title bar.

3.5 Component Names

3.5 Component Names

This section presents the name and display content of each component of GM Programmer.

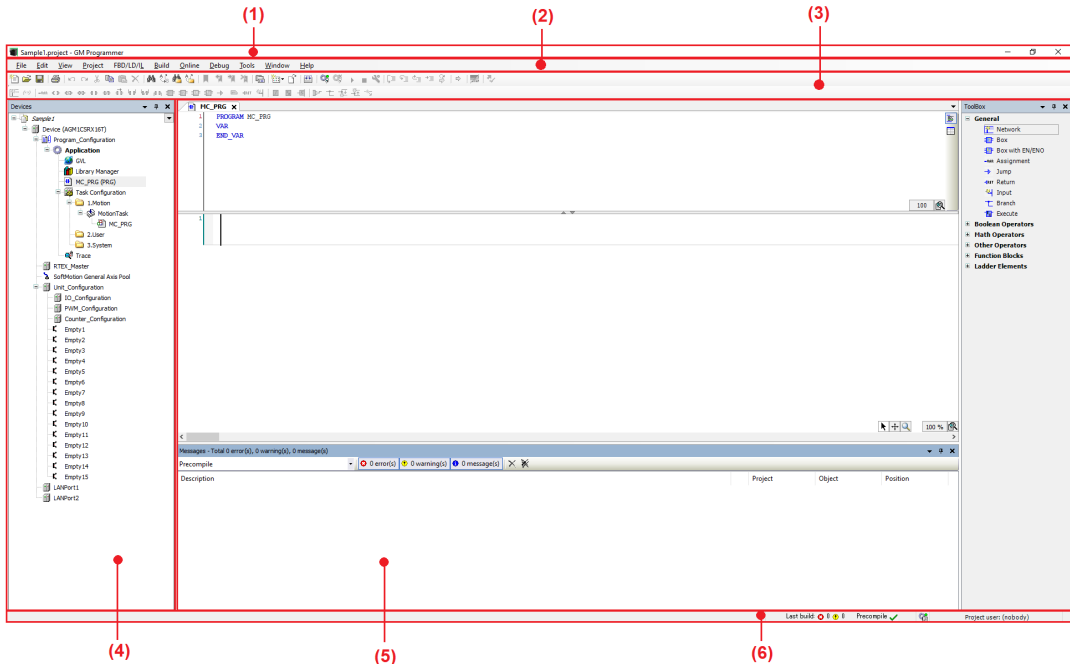

No.	Name	Description
(1)	Title bar	The title bar displays the project file name, [minimize] button, [maximize] button, and [close] button.
(2)	Menu bar	The menu bar displays the menu commands for each purpose in list format.
(3)	Toolbar	The toolbar displays each command as an icon.
(4)	Navigator pane	The navigator pane displays the objects (such as devices, applications, and programs) added to the project in a tree structure.
(5)	Main pane	The main pane displays a program, function settings, messages, and other data. The window can be switched by selecting a desired tab.
(6)	Status field	The status bar displays the build status, logged-in users, and other information.

3.5.1 Menu Bar

The menu bar displays the following menus:

File **Edit** **View** **Project** **FBD/LD/IL** **Build** **Online** **Debug** **Tools** **Window** **Help**

■ File

Item	Function	Refer
New Project	Creates a new project.	"P.4-3"
Open Project	Opens a project that is stored.	"P.4-11"

3.5 Component Names

Item	Function	Refer	
Close Project	Close the project that is currently viewed.	"P.4-10"	
Save Project	Saves the project that is currently viewed, in overwrite mode.	"P.4-9"	
Save Project As	Saves the project that is currently viewed, as a different file name.	"P.4-9"	
Project Archive	Unzip the archive.	Unzip the archive.	"P.4-41"
	Save the archive.	Save the archive.	"P.4-39"
Source Upload(Device→PC)	Loads the project source code as a project archive.	"P.7-15"	
Print	Prints the active editor screen.	"P.4-25"	
Print Preview	Displays the active editor screen in print preview mode.	-	
Page Setup	Opens the Page Setup dialog box to configure a print layout.	-	
Recent Projects	Displays the recently used projects.	-	
Exit	Closes GM Programmer.	"P.3-13"	

3.5 Component Names

■ Edit

Item	Function	Refer	
Undo	Reverses the results of a previous editing action.	-	
Redo	Allows the user to redo the last editing action after Undo.	-	
Cut	Cuts data.	-	
Copy	Copies data.	-	
Paste	Pastes data.	-	
Delete	Deletes data.	-	
Select All	Selects all text.	-	
Find Replace	-	Used to find and replace a string.	-
	Find	Opens the "Find" dialog box.	-
	Replace	Opens the "Replace" dialog box.	-
	Find in Project	Opens the "Find" dialog box to find the target within the entire project.	-
	Replace in Project	Opens the "Replace" dialog box to find the target within the entire project.	-
	Find Next	Finds the next match from the selected cursor position within the project.	-
	Find Next (Selected)	Finds the next match from the selected cursor position within the editor.	-
	Find Previous	Finds the previous match from the selected cursor position within the project.	-
	Find Previous (Selected)	Finds the previous match from the selected cursor position within the editor.	-
	Toggle Field for Incremental Search	Searches for the character string within the POU editor each time a single character is entered.	-
Browse	-	Used to browse the positions where the declaration part of a defined variable is referenced or used.	-
	Go To Definition	Allows the cursor to move to the position where the variable or function specified by the cursor is defined within the editor.	-
	Browse Cross References	Allows the positions where the variable specified by the cursor is used to be displayed in the "Cross reference List" view.	-
	Browse Call Tree	Allows the callee and caller of the variable specified by the cursor to be displayed in the "Call Tree" view.	-
	Go To Reference	Displays the declaration position of the variable to which the pointer variable specified by the cursor refers.	-
	Go To Instancev	Displays the instance of the function block specified by the cursor in the new editor.	-
Insert File as Text	Inserts the contents of the specified text file in the cursor position.	-	
Advanced	Executes functions related to the text editor.	-	

Item	Function	Refer	
	Overwrite Mode	Switches the text input mode from insert mode to overwrite mode.	-
	View Whitespace	Displays the control characters of spaces and tabs.	-
	View Indentation Guides	Inserts a broken line between indents when an indent is inserted in the program code.	-
	Go To Line	Displays a line number dialog box and moves the cursor to the specified line.	-
	Make Uppercase	Converts the selected character string in the text editor to uppercase letters.	-
	Make Lowercase	Converts the selected character string in the text editor to lowercase letters.	-
	Go to Matching Bracket	Moves the cursor to the corresponding bracket when the cursor is positioned in a bracket in the code.	-
	Select to Matching Bracket	Selects the entire code in brackets when the cursor is positioned in either of the brackets in the code.	-
	Expand All Folds	Unfolds the indented code segment.	-
	Collapse All Folds	Folds the indented code segment.	-
	Comment out selected lines	Comments out the selected line.	-
	Uncomment selected lines	Uncomments the selected line.	-
	Enable inline monitoring	Sets whether to enable or disable the function that displays the value of each variable on the code during online mode.	-
Bookmarks	-	Allows the cursor to move to bookmarked locations. Used to browse the positions where the declaration part of a defined variable is referenced or used.	"P.5-51"
	Toggle Bookmark	Saves the position selected in the active editor as a bookmark.	-
	Next Bookmark (active editor)	Moves to the previous bookmark in the active editor.	-
	Previous Bookmark (active editor)	Moves to the next bookmark in the active editor.	-
	Clear All Bookmarks (active editor)	Removes all bookmarks in the active editor.	-
Input Assistant		Allows the user to select variables, function blocks, operators, types, or other data that can be inserted in the cursor position from a category and insert them in the cursor position.	"P.5-59"
Function Block Guidance		Invokes the Function Block Guidance.	"P.5-54"
Auto Declare		Opens the Auto Declare dialog box to support variable declaration.	"P.5-8"
Next Message		Selects the next message in the message view	-
Previous Message		Selects the previous message in the message view.	-
Go To Source Position		Moves to the position of the source code applicable to the message selected in the message view.	-

3.5 Component Names

Item	Function	Refer
Refactoring	Displays the positions where the changed variable name is used and allows changes to be made collectively.	"P.5-61"

■ View

Item	Function	Refer
Devices	Displays the device view.	"P.4-6"
POUs	Displays the POU view.	-
Messages	Displays the message window.	-
Element properties	Displays element properties.	-
Watch	-	"P.5-10"
	Watch 1 to Watch 4	Displays a list of user-defined variables for the purpose of value monitoring.
	Watch all Forces	Displays a list of value-forced variables.
Cross Reference List	Displays the cross reference list window.	"P.5-52"
Bookmarks	Displays the bookmark window.	"P.5-51"
Breakpoints	Displays the breakpoint window.	"P.8-6"
Call Stack	Displays the call stack window.	"P.8-10"
Start Page	Displays the start page.	-
Security Screen	Displays the certificate creation and registration screen.	"P.13-57"
Full Screen	Displays the window in full-screen mode.	"P.3-37"
Properties	Displays the properties dialog box.	-

3.5 Component Names

■ Project

Item		Function	Refer
Add Object		Adds an object.	"P.4-13"
Add Folder		Adds a folder.	"P.3-37"
Edit Object		Allows the user to edit an object.	-
Online Config Mode		Removes the applications downloaded to the GM1 controller and allows connection to the GM1 controller.	"P.9-33"
Project Information		Allows the user to set project author information or check project file information.	-
Project Settings		Allows the user to configure project-related settings.	"P.4-17"
Project File Conversion		Allows the user to convert project files from the old project version to the new version.	"P.4-35"
Localization	-	Allows the user to translate and register comments, titles, and other information in the program to display the translated content in the program window.	"P.5-67"
	Create Localization Template	Creates and saves a localization template.	"P.5-67"
	Manage Localizations	Imports a localization template that has been created.	"P.5-67"
	Toggle Localization	Switches the language in the project.	"P.5-67"
Document		Allows the user to print the entire project.	"P.4-23"
Compare		Compares the displayed project with the stored project.	"P.4-26"
Commit accepted changes		Commits the difference between the objects compared by selecting Project>Compare from the menu bar.	"P.4-26"
Export		Outputs an object from the displayed project as an XML file.	"P.4-31"
Import		Imports an object into the displayed project.	"P.4-33"
User Management	-	Allows execution permissions for operations (such as executing menu commands and adding, editing, and deleting objects) to be assigned to each group in which users are registered.	"P.14-3"
	User Logon	Logs in to the displayed project.	-
	User Logoff	Logs off from the displayed project.	-
	Permissions	Logs off from the displayed project.	"P.14-8"

■ Build

Item	Function	Refer
Build	Verifies the syntax of objects.	"P.5-47"
Rebuild	Verifies the syntax of all objects again.	"P.5-47"
Generate code	Generates application codes.	"P.5-48"
Clean	Deletes application build information.	"P.5-49"
Clean all	Deletes all application build information in the same way as "Clean".	"P.5-50"

3.5 Component Names

■ Online

Item	Function	Refer	
Scan Network	Connect to the GM1 controller.	-	
Add USB Port	Adds a USB port as a communication interface.	"P.7-5"	
Login	Downloads the applications generated by code generation to the GM1 controller at the time of login.	"P.7-11"	
Logout	Logs out from the device to which the user logged in.	"P.7-12"	
Download	Downloads a program while the user is logged in.	"P.7-12"	
Online Change	Allows the user to change applications without having to stop the GM1 controller during operation.	"P.7-14"	
Source Download to Connected Device	Downloads the source to the connected GM1 controller.	-	
Status	Allows the user to check any errors that are currently occurring in the GM1 controller.	"P.8-103"	
System Data History	Allows the user to check any errors that occurred in the GM1 controller.	"P.8-104"	
Reset Warm	Initializes variables other than the RETAIN and PERSISTENT variables.	"P.8-98"	
Reset Cold	Initializes all variables. Removes active applications from the GM1 controller.	"P.8-98"	
Reset Origin	Initializes all variables. Removes active applications from the GM1 controller.	"P.8-98"	
Simulation	Allows the user to perform a login operation without connecting to the GM1 controller and check behaviors in the same way as if the user logged in.	"P.8-19"	
Security	-	Allows the user to configure user management, project encryption, and other settings.	"P.14-2"
	Logoff Current Device User	Logs off the users who are logged in to the device.	-
	Add Device User	Adds users who can log in to the device.	-
	Change Password Device User	Changes the passwords of users who are logged in to the device.	-
	Remove Device User	Removes users who can log in to the device.	-
SSL / TLS Certificate Management	Allows the user to register or delete the SSL / TLS certificate of the FTP server function.	"P.13-61"	
Operation Mode	-	Allows the user to prevent some debug operations from being executed.	-
	Debug	Allows all debug operations to be executed.	-
	Locked	Prohibits some operations such as adding new breakpoints or forcing variable values.	-
	Operational	Prohibits any changes other than writing variables.	-
Unit Composition Confirmation	Allows the users to confirm the configuration of the main unit being connected	"P.14-61"	
Unit Version Upgrade	Allows the users to update the firmware version of the unit.	"P.14-62"	

■ Debug

Item	Function	Refer
Start	Starts the application.	"P.8-3"
Stop	Stops the application.	"P.8-3"
Single Cycle	Executes the application in every single cycle.	"P.8-4"
New Breakpoint	Creates a new breakpoint.	"P.8-8"
Edit Breakpoint	Allows the user to edit breakpoints.	-
Toggle Breakpoint	Allows the user to set or delete breakpoints.	"P.8-6"
Disable Breakpoint	Disables invalid breakpoints.	-
Enable Breakpoint	Enables valid breakpoints.	-
Step Over	Executes the program line by line. When a block (function or function block) is executed in the block invocation location, the cursor moves to the next line.	-
Step Into	Executes the program line by line. When a block (function or function block) is executed in the block invocation location, the cursor moves to the first line of the called block.	-
Step Out	When the program is executed within the called block, the execution continues until control returns to the calling block. When the program is executed outside the called block, the execution continues until control returns to the beginning of the program.	-
Run to Cursor	Executes the program up to the line specified by the cursor.	-
Set next Statement	Regards the line specified by the cursor as the next statement to be executed and skips processes over to that line.	-
Show next Statement	Jumps the cursor to the program line to be executed as the next step.	-
Write Values	Sets a value (to be changed later) only once. This value can then be changed by the program.	"P.8-11"
Force Values	Sets a value to be changed in every cycle and maintains the value.	"P.8-11"
Unforce Values	Cancel forced value change.	"P.8-11"
Toggle Flow Control Mode	Performs monitoring by using different colors in positions where the program is executed and in positions where the program is not executed.	"P.8-14"
Display Mode	Allows the user to select binary, decimal, or hexadecimal as the display format of the variable value to be displayed.	-

3.5 Component Names

■ Tools

Item	Function	Refer
PANATERM Lite for GM	Allows the user to select a device to which PANATERM Lite for GM is to connect.	"P.14-64"
Library Repository	Allows the user to install a created library in the library repository in order to use the functions or function blocks in the library.	"P.5-27"
Customize	Allows the user to change the layout of the menu bar and toolbar, and the shortcut assignment.	"P.3-45"
Options	Allows the user to set up each function of GM Programmer.	"P.3-39"

■ Window

Item	Function	Refer
Next Editor	Displays the next window.	"P.3-36"
Previous Editor	Displays the previous window.	"P.3-36"
Close All Editors	Closed all windows.	"P.3-36"
Reset Window Layout	Resets the layout of the window to its initial state.	
New Horizontal Tab Group	Moves the selected window downward.	"P.3-36"
New Vertical Tab Group	Moves the selected window to the right.	"P.3-36"
Float	Sets the selected window in a floating state.	"P.3-32"
Dock	Sets the selected window in a docking state.	"P.3-32"
Auto Hide	Minimizes the window.	"P.3-34"
Next Pane	Switches the pane between the declaration section (first pane) and the implementation section (second pane).	"P.3-34"
Previous Pane	Switches the pane between the declaration section (first pane) and the implementation section (second pane).	"P.3-34"
Window	Displays a list of open windows.	-

















■ Help

Item	Function	Refer
About	Displays version information.	"P.3-43"

















3.5.2 Toolbar

















The toolbar displays the following icons:

















Name	Icon	Function
New Project		Creates a new project.
Open Project		Opens a project that is stored.
Save Project		Saves the project that is currently viewed, in overwrite mode.
Print		Prints the active editor screen.
Undo		Reverses the results of a previous editing action.
Redo		Allows the user to redo the last editing action after Undo.
Cut		Cuts data.
Copy		Copies data.
Paste		Pastes data.
Delete		Deletes data.
Find		Searches for a particular character string that appears in the active editor.
Find Replace		Searches for a particular character string that appears in the active editor and replaces it with another character string.
Find in Project		Searches for a specified character string within the current project.
Replace in Project		Searches for a specified character string within the current project and replaces it with another character string.
Toggle Bookmark		Saves the position selected in the active editor as a bookmark.
Previous Bookmark (active editor)		Moves to the previous bookmark in the active editor.
Next Bookmark (active editor)		Moves to the next bookmark in the active editor.

3.5 Component Names

Name	Icon	Function
Clear All Bookmarks (active editor)		Removes all bookmarks in the active editor.
Function Block Guidance		Displays the Function Block Guidance.
Properties		Displays the properties.
Add Object		Adds an object.
Edit Object		Opens an object.
Build		Compiles an object in the application.
Login		Downloads the applications generated by code generation to the GM1 controller at the time of login.
Logout		Logs out from the device to which the user logged in.
Start		Starts the application.
Stop		Stops the application.
Online Config Mode		Removes the applications downloaded to the GM1 controller and allows connection to the GM1 controller.
Step Over		Executes the program line by line. When a block (function or function block) is executed in the block invocation location, the cursor moves to the next line.
Step Into		Executes the program line by line. When a block (function or function block) is executed in the block invocation location, the cursor moves to the first line of the called block.
Step Out		When the program is executed within the called block, the execution continues until control returns to the calling block. When the program is executed outside the called block, the execution continues until control returns to the beginning of the program.
Run to Cursor		Executes the program up to the line specified by the cursor.
Set next Statement		Regards the line specified by the cursor as the next statement to be executed and skips processes over to that line.

Name	Icon	Function
Show next Statement		Jumps the cursor to the program line to be executed as the next step.
Toggle Localization		Switches the language to the one enabled in [Default Localization] in the window displayed by selecting [Project Localization] and then [Manage Localizations] from the [Project] menu.
Commit accepted changes		Commits the difference between the objects compared by selecting the [Project] > [Compare] from the menu bar.
Insert Network		Inserts an empty network.
Toggle network comment state		Changes the comment status of the selected network.
Insert Assignment		Inserts a new assignment in the specified position.
Insert Coil		Inserts a coil in the specified position.
Insert Set Coil		Inserts a set coil in the specified position.
Insert Reset Coil		Inserts a reset coil in the specified position.
Insert Contact		Inserts a normally open contact in the specified position.
Insert Negated Contact		Inserts a normally closed contact in the specified position.
Insert Contact (right)		Inserts a normally open contact on the right side of the specified position.
Insert Contact Parallel (below)		Inserts a normally open contact below and in parallel with the contact at the specified position.
Insert Negated Contact Parallel (below)		Inserts a normally closed contact below and in parallel with the contact at the specified position.
Insert Contact Parallel (above)		Inserts a normally open contact above and in parallel with the contact at the specified position.
Insert Box		Opens the Input Assistant to insert a box in the specified position.
Insert Empty Box		Inserts an empty box in the specified position.





3.5 Component Names

Name	Icon	Function
Insert Box with EN/ENO		Opens the Input Assistant to insert a box with EN/ENO in the specified position.
Insert Empty Box with EN/ENO		Inserts a box with EN/ENO in the specified position.
Insert Jump		Inserts a jump in the specified position.
Insert label		Inserts a label in the selected network.
Insert Return		Inserts a return value in the specified position.
Insert Input		Adds an input to the specified box.
Negation		Adds a negation to the selected element.
Edge Detection		Adds an edge detection (rising edge detection) to the selected element.
Set/Reset		Converts the selected coil to a set coil or reset coil.
Set output connection		Converts box output to forwarding box output.
Insert Branch		Inserts a branch on the right side of the selected contact.
Insert Branch below		Inserts a new branch below the selected branch.
Insert Branch above		Inserts a new branch above the selected branch.
Set Branch Start/End Point		Sets the selected line as the branch starting point.

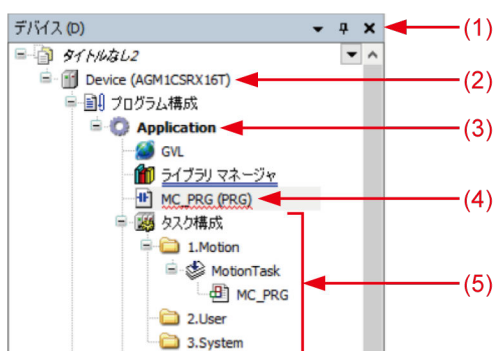
3.5.3 Navigator Pane

The navigator pane displays the following tree:



No.	Name	Icon	Function
(1)	Window Position		<ul style="list-style-type: none"> • New Horizontal Tab Group Moves the selected window to the right. • New Vertical Tab Group Moves the selected window downward. • Float Sets the selected window in a floating state. • Dock Sets the selected window in a docking state. • Auto Hide Minimizes the navigator pane to hide it.
	Auto Hide		Always shows the navigator pane.
			Minimizes the navigator pane to hide it.
	Close		Closes the navigator pane.
(2)	Device object		Sets up device objects.
(3)	Application object		Sets up application objects.
(4)	Program object (POU object)		Sets up program objects (POU objects).
(5)	Task object		Sets up task objects.

3.5 Component Names

3.5.4 Main Pane

The main pane displays the following sub-panes:

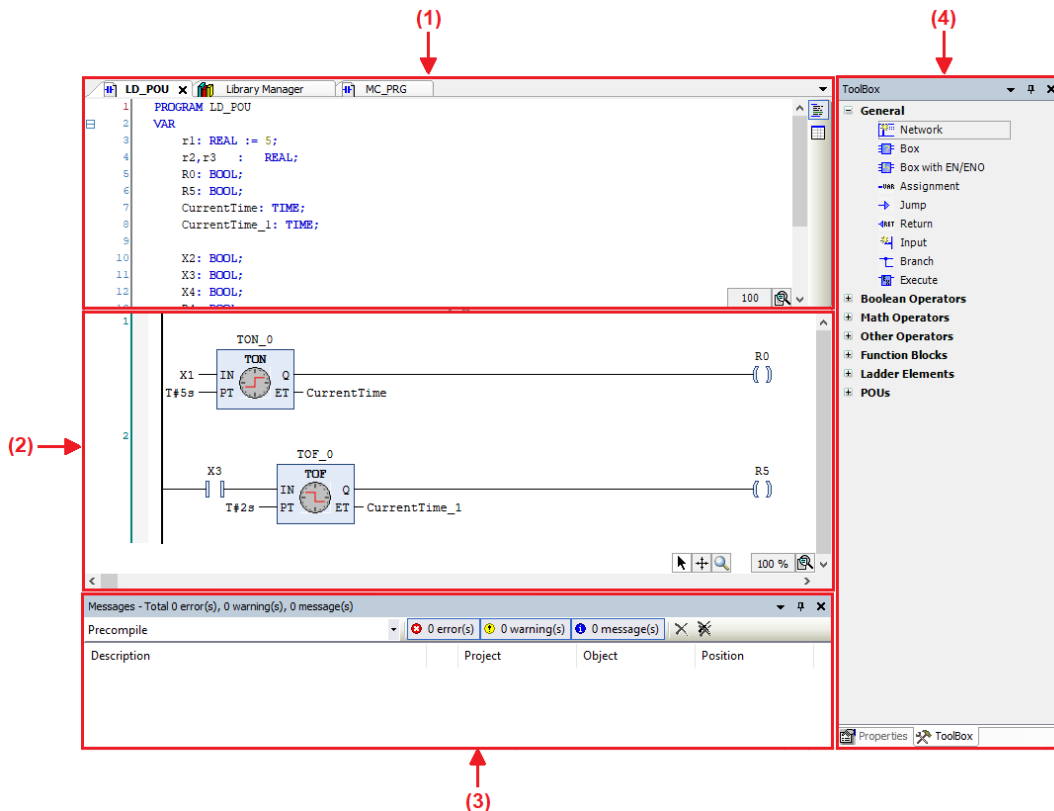



No.	Name	Function
(1)	Declaration section (first pane)	Allows the user to declare variables.
(2)	Implement section (second pane)	Allows the user to enter a program.
(3)	Message view	Displays any error or warning messages.
(4)	ToolBox	Allows the user to place elements in the implementation section by selecting them and then dragging and dropping them in the implementation section.

3.5.5 Status Bar

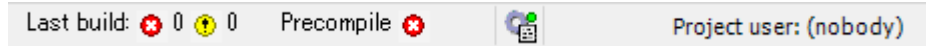
The status bar displays the following icons:



Name	Icon	Function
Last Build		Displays the number of errors in the results of the build process.
		Displays the number of warnings in the results of the build process.
Precompile	—	Displays the results of the precompile process.
Application Information		Compares the application information of the displayed project with the application information downloaded to the GM1 controller.
Project user	—	Displays the users who are logged in to the displayed project.

3.6 Window Operations

3.6 Window Operations

This section explains operations related to common windows for GM Programmer.

3.6.1 Moving the Pane Location

You can freely change the layout of each window for GM Programmer.

For example, use the following procedure to move the navigator pane from the left edge to the right edge of the window.

1 2 Procedure

1. Click the title bar of the navigator pane and then drag it to the main pane. The navigator pane will stay in a floating state and arrows indicating movable directions will be displayed.

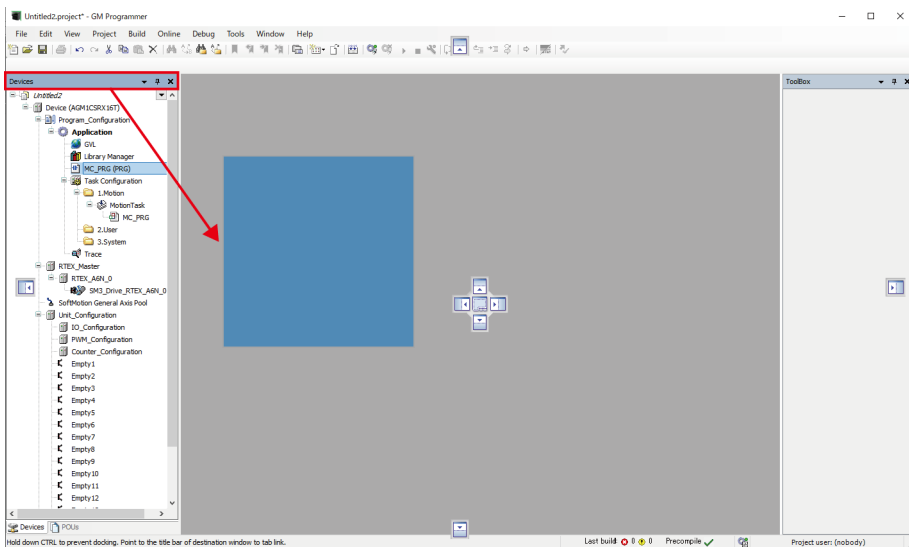

2. Drag the navigator pane in the direction in which you want to move it. The relocation destination will be displayed in light blue.

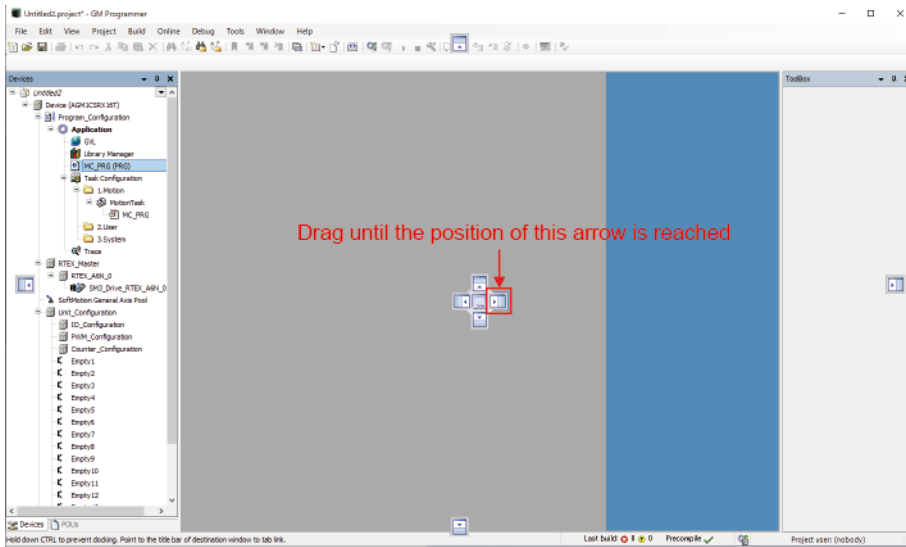

3. Release the left mouse button.

The navigator pane will be docked into the existing pane and the relocation will be completed.

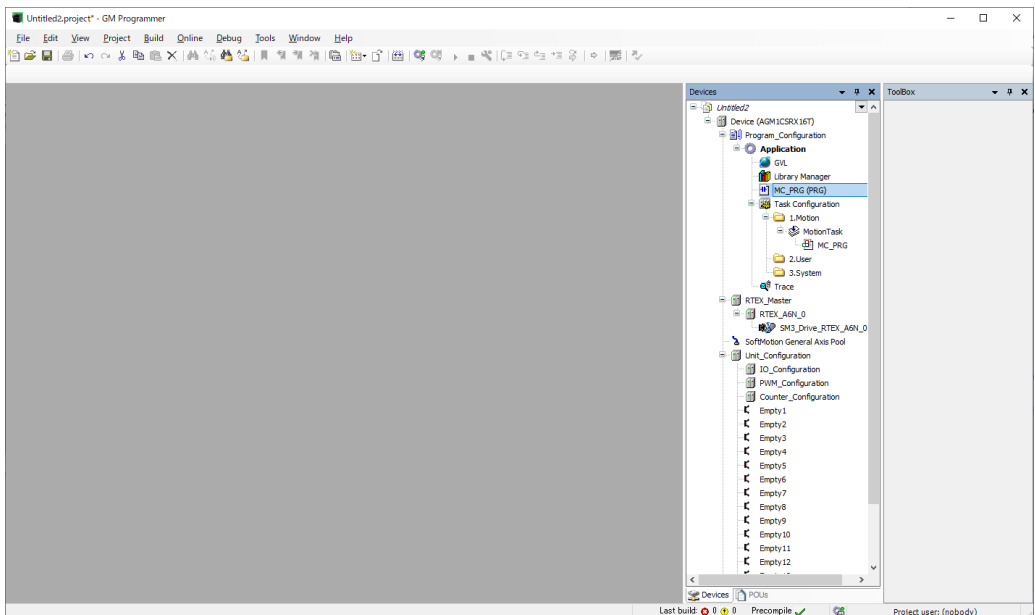

i Info.

- You can return the changed layout of the window to its initial state. From the menu bar, select **Window>Reset Window Layout**.
- You can put a pane in a floating or docking state. To put a pane in a floating state, select **Window>Float** from the menu bar. To put a pane in a docking state, right-click the title bar in the window in a floating state and then select Dock from the context-sensitive menu that is displayed.

3.6 Window Operations

3.6.2 Showing / Hiding Panes

You can normally hide the navigator pane and some sub-panes in the main pane and show them only when you use them.

1 2 Procedure

1. Click  on the title bar of the navigator pane.
The navigator pane will be minimized and hidden.

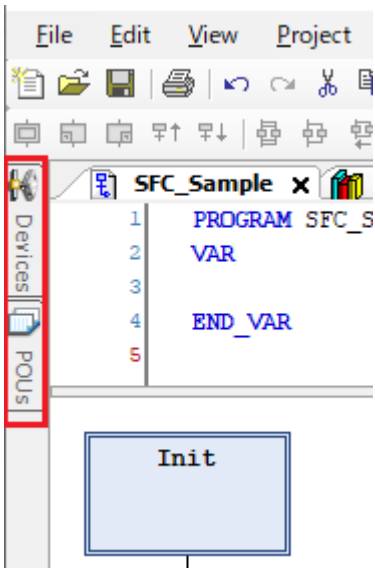

2. Click the minimized pane.
The navigator pane will be displayed. Clicking in another pane automatically hides the navigator pane again.

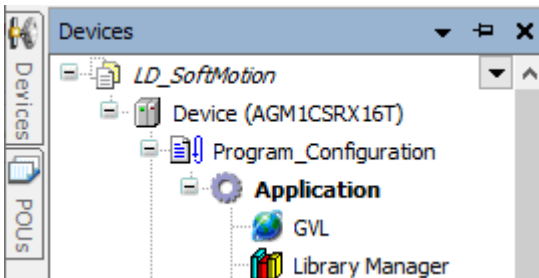

3. Click  on the title bar of the navigator pane.
The navigator pane will always be displayed.

i Info.

- You can also hide the navigator pane from the menu bar. From the menu bar, select **Window>Auto Hide**. To always display the navigator pane again, select **Window>Auto Hide** again from the menu bar.

3.6.3 Switching the Tab of the Main Pane

You can switch the tab of the main pane.

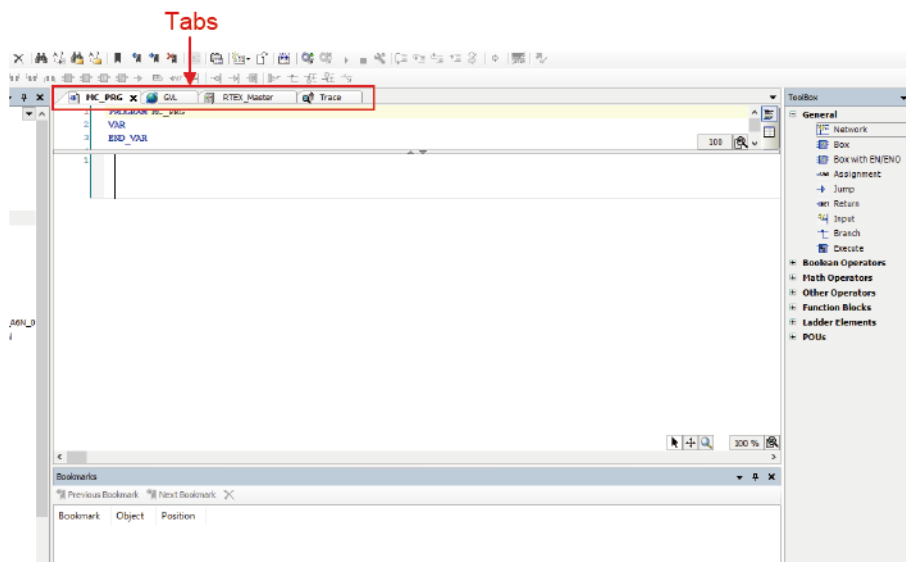

12 Procedure

- Press the shortcut keys "Ctrl+Tab" simultaneously. The window for switching the tab of the main pane will be displayed.

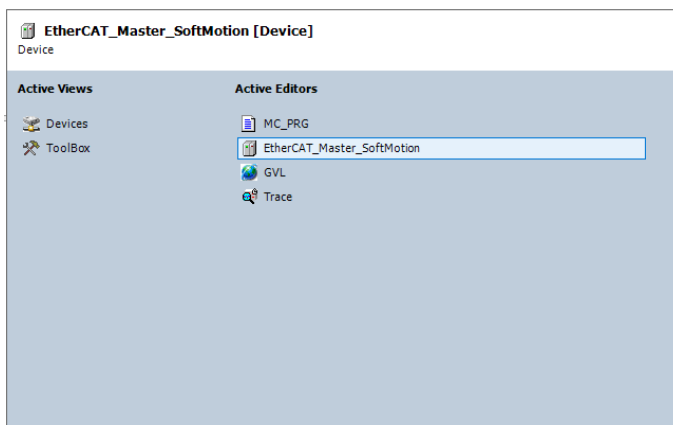

3.6 Window Operations

2. While holding down the "Ctrl" key, press the "Tab" key until the desired tab is selected.
3. Release the "Ctrl" key.
The current tab will be switched to the selected tab.

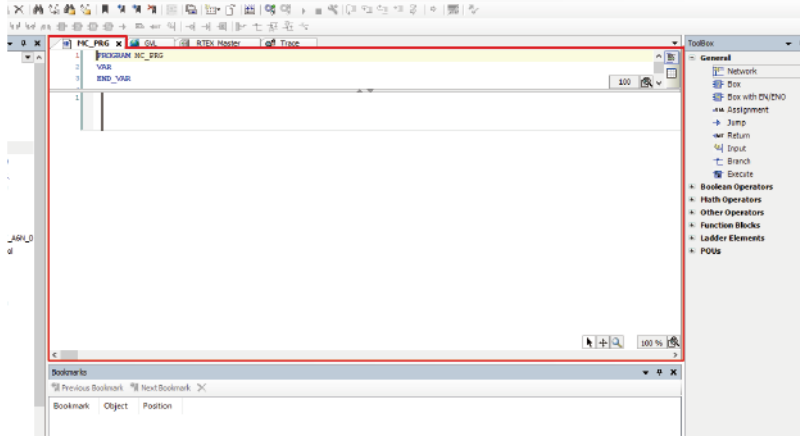

Tab is switched

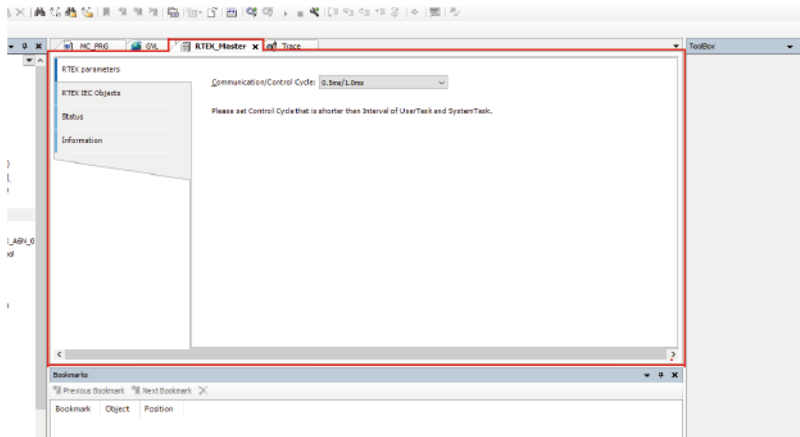

3.6.4 Operating the Object Window

The following operations can be performed on the object window displayed in the main pane.

Operation	Menu	Shortcut keys
Displaying the next window	Window>Next Editor	<Ctrl> + <F6>
Displaying the previous window	Window>Previous Editor	<Ctrl> + <Shift> + <F6>
Closing all windows	Window>Close All Editors	None
Moving the selected window downward	Window>New Horizontal Tab Group	None

Operation	Menu	Shortcut keys
Moving the selected window to the right	Window>New Vertical Tab Group	None

<Moving the selected window downward (New Vertical Tab Group)>



Move the selected pane downward until both panes are arranged vertically

<Moving the selected window to the right (New Horizontal Tab Group)>

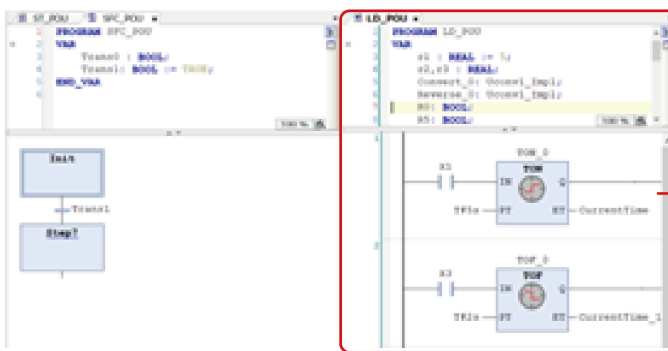

Move the selected pane to the right until both panes are arranged horizontally

3.6.5 Full-screen Display

You can display each window of GM Programmer in full-screen mode.

1 2 Procedure

1. From the menu bar, select **View>Full Screen**.
Then GM Programmer window will be displayed in full-screen mode.
2. From the menu bar, select **View>Full Screen** again.
Then GM Programmer window will return from full-screen mode to normal display mode.

3.6 Window Operations

Info.

- You can also switch to full-screen mode by pressing shortcut keys "Ctrl+Shift+F12" simultaneously.

3.7 Other Functions

3.7.1 Option Setting Function

GM Programmer allows the user to set up each function from the "Options" dialog box. The settings will be applied to all projects created with GM Programmer.

1 2 Procedure

1. From the menu bar, select **Tools>Options**.
The "Options" dialog box will be displayed.

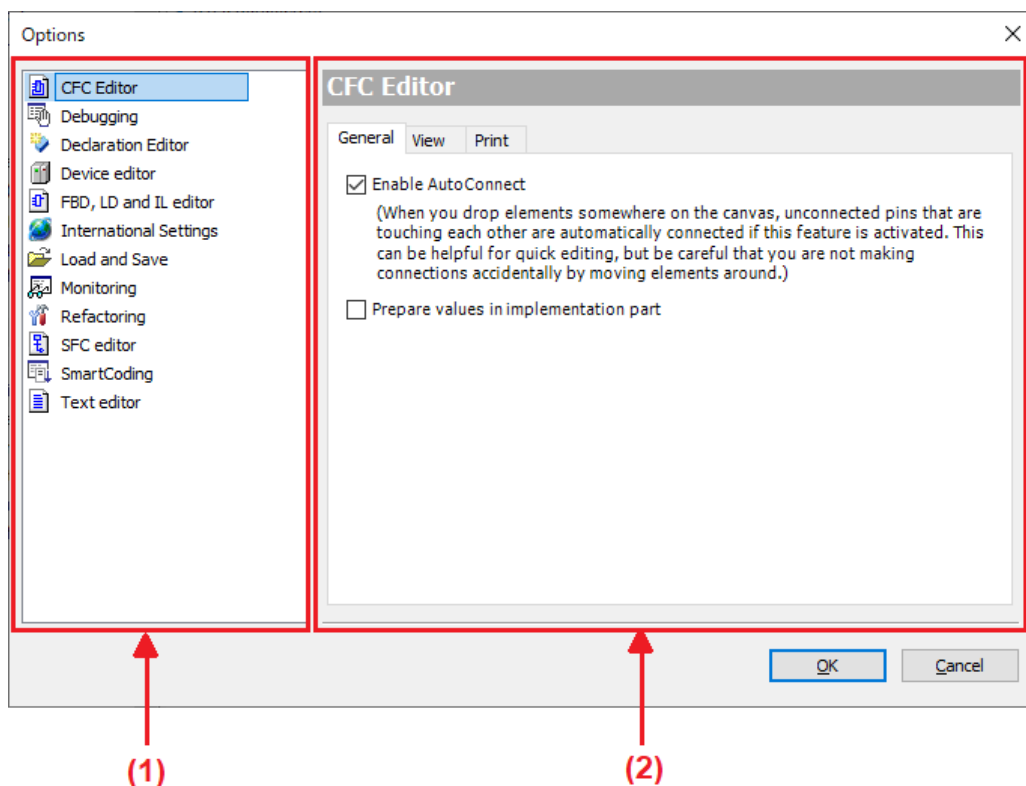

No.	Name	Function
(1)	Categories pane	Displays option categories.
(2)	Setting pane	Displays the settings of the selected category and allows the user to configure settings.

Option categories

Category name	Function	Reference page
CFC Editor	Allows the user to configure settings related to editing and printing CFC programs.	-

3.7 Other Functions

Category name	Function	Reference page
FBD, LD and IL editor	Allows the user to configure settings related to editing, commenting, and printing FBD, LD, and IL programs.	"P.6-11" "P.6-33"
SFC editor	Allows the user to configure settings related to the sizes and fonts of SFC editor elements, the behavior at the time of action element insertion, the display of embedded objects in the navigator pane, the display of properties, stepwise execution time during online operation, and other items.	"P.6-23"
SmartCoding	Allows the user to configure settings related to the functions for supporting program creation, such as Input Assistant.	"P.6-14" "P.5-8" "P.5-60"
Text editor	Allows the user to configure settings related to program editing and inline monitoring.	"P.8-16"
Device editor	Allows the user to configure settings related to displays for the device editor.	-
Debugging	Allows the user to configure settings regarding whether to restore breakpoints after resetting.	-
Monitoring	Allows the user to configure settings related to displays for monitoring.	-
Refactoring	Allows the user to configure settings for the valid range of refactoring.	"P.5-61"
Load and save	Allows the user to configure settings regarding whether to enable backup and auto saving of project files.	"P.4-21" "P.4-19"
International Settings	Allows the user to set a display language for GM Programmer and PANATERM Lite for GM, as well as a display language for the manual.	"P.3-41"
Declaration Editor	Allows the user to configure settings related to the display format (text format or table format) for the declaration section.	"P.5-5"

2. Select a desired category from the Categories pane.
The setting items for the selected category will be displayed in the setting pane.
3. Change the setting items as appropriate and click the [OK] button.
The setting items will be applied.

3.7.2 Display Language Setting Function

This function allows the user to change the display language setting for GM Programmer. The default setting is the same language as the one used in the operating system. If you want to use a different language from the one used in the operating system, change the display language setting. After you change the language setting, you must restart GM Programmer.

1 2 Procedure

1. From the menu bar, select **Tools>Options**.
The "Options" dialog box will be displayed.
2. Select "International Settings" from the Categories pane.
The "International Settings" pane will be displayed.

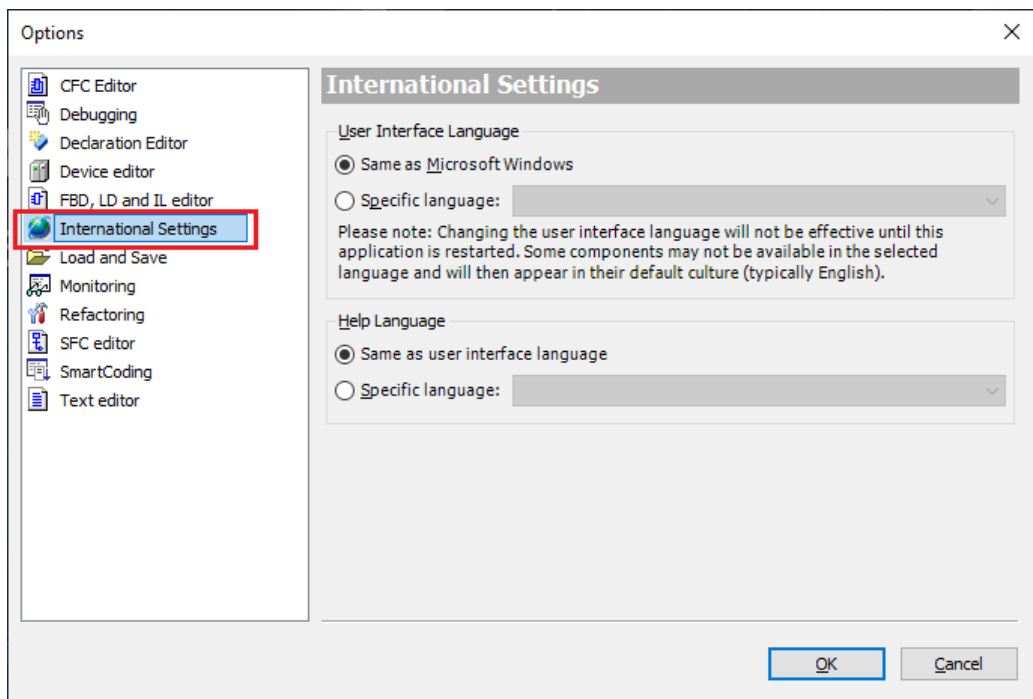

3. Select **User Interface Language>Specific language** option and specify a desired language in the field.
4. Click [OK].
The "Options" dialog box will be closed.
At this stage, the language has not been changed yet.
5. Close GM Programmer and then start GM Programmer again.
After GM Programmer is started, the selected language takes effect.

3.7 Other Functions

Info.

- The display language setting of GM Programmer is linked with that of PANATERM Lite for GM. Therefore, if the display language setting of PANATERM Lite for GM is changed, the display language setting of GM Programmer will also be changed automatically.

3.7.3 Version Display Function

This function allows the user to check the version, license, and other information for GM Programmer.

1 2 Procedure

- From the menu bar, select **Help>Version Info**.
The GM Programmer version is displayed in parentheses on the title bar.



- Click a desired button at the bottom of the window.

Button	Description
Version Info	Displays information about the plug-ins that have been applied and the operating system of the PC that is used.
License Info	Displays license information for the software used by GM Programmer.

Clicking the [Version Info] button displays the "Version Info" dialog box.

3.7 Other Functions

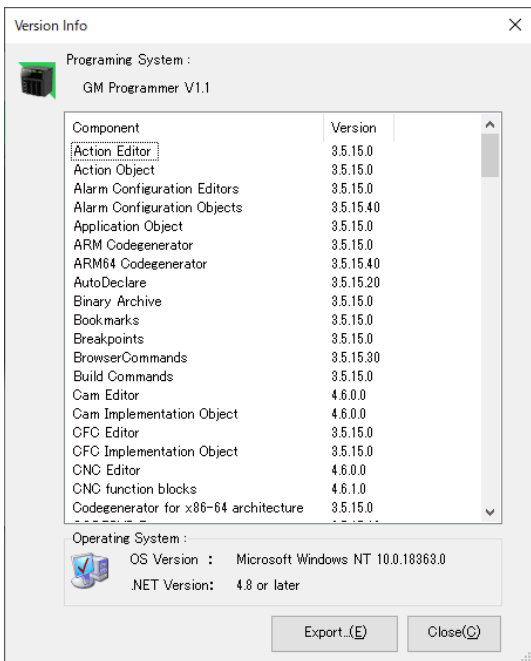

Clicking the [License Info] button displays the "License Information" dialog box.

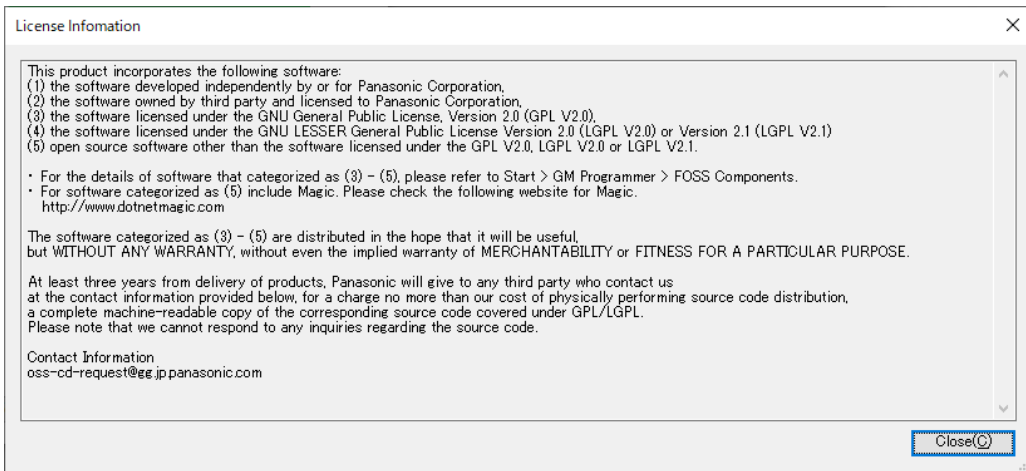

3.7.4 Customize function

You can use custom functions to change the configuration of the menu bar and toolbar. You can also change the assignment of shortcut keys and menu command icons.

Changing the menu bar

You can add menu commands to the category.

1 2 Procedure

1. Select [Tools] → [Customize] in the menu bar. The [Customize] dialog box appears.

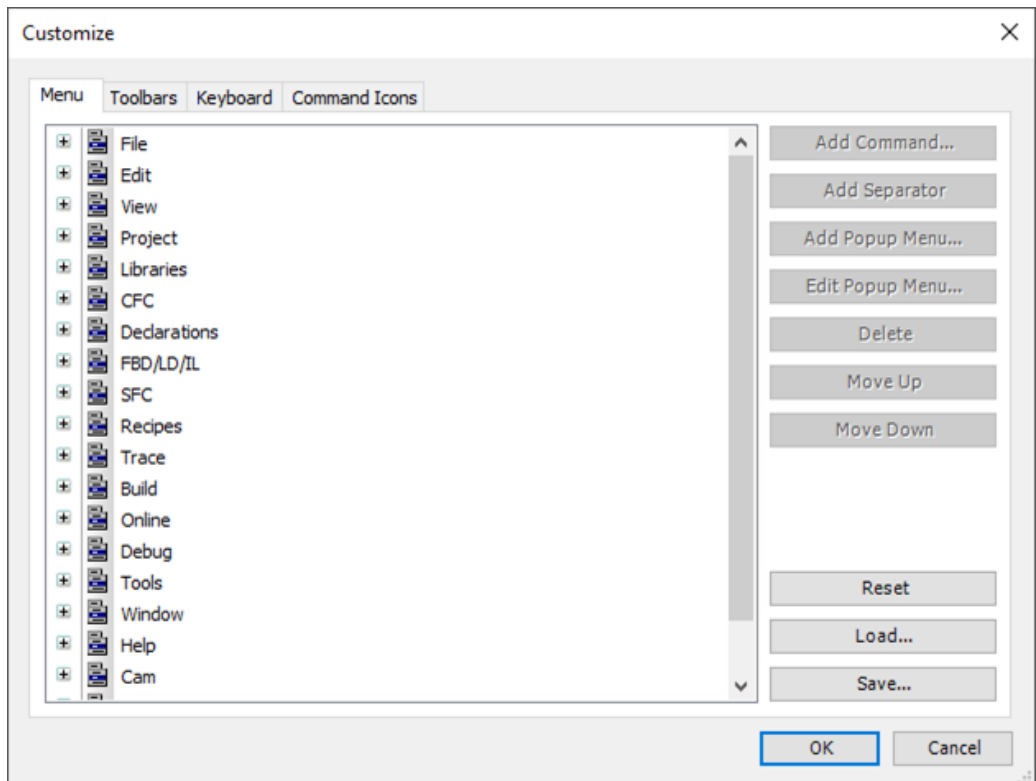

2. Select the category you want to add a new command to and expand the menu.
3. Select the menu below where you want to add the menu. Select the whitespace symbol () if you want to add it to the bottom of the category.
4. Click [Add Command]. The [Add Command] dialog box appears.

3.7 Other Functions

A list of commands that can be added by category appears.

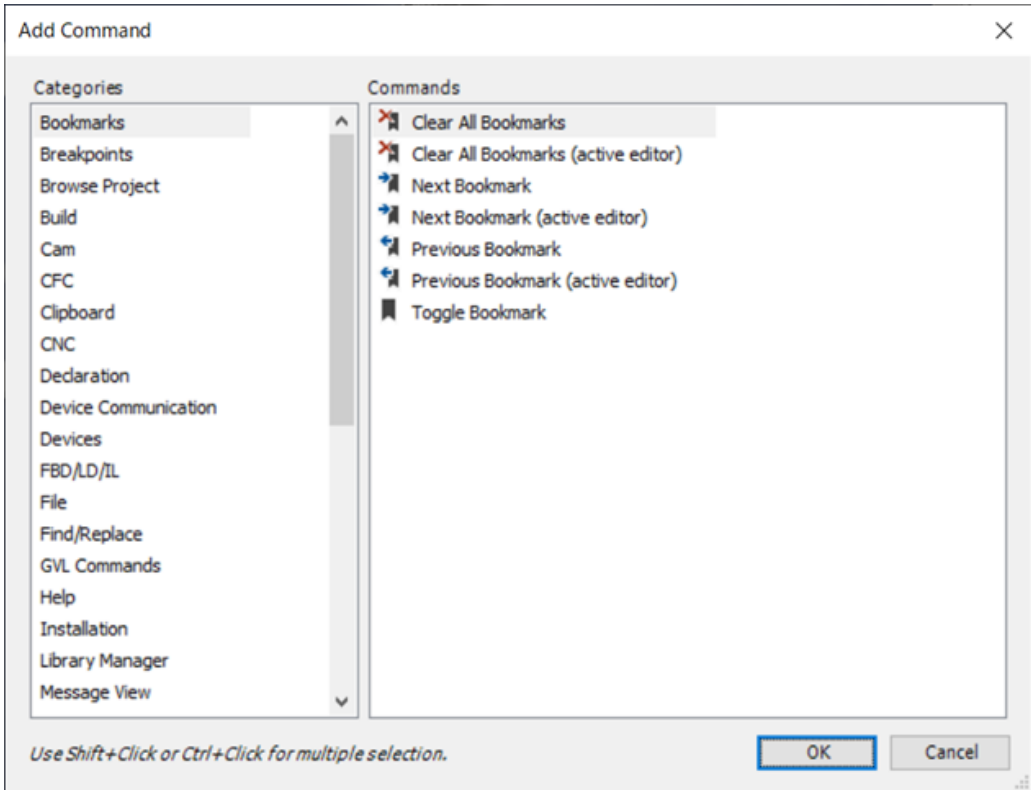

5. Select the command you want to add and click the [OK] button.
The command is added to the menu of the [Customize] dialog box.
You can change the order of the menus by clicking the [Move Up] and [Move Down] buttons.
You can add a border between the menus by clicking the [Add Separator] button.
6. Click the [OK] button.
The [Customize] dialog box closes and commands are added to the menu bar.

i Info.

- When the version of GM Programmer is updated, it will return to the default settings, so save the necessary settings before performing.
- You can delete the menu command by clicking the [Delete] button.
- When the [Reset] button is clicked, the menu configuration returns to the default state.
- You can save the menu configuration by clicking the [Save] button. The file extension of the saved menu configuration is ".opt.menu".
- You can load the saved menu configuration file by clicking the [Load] button.

Adding a Popup Menu

You can add a popup menu to the menu bar. A menu command can be added to the popup menu.

1 2 Procedure

1. Select [Tools] -> [Customize] in the menu bar.
The [Customize] dialog box appears.
2. Select the whitespace symbol () at the bottom of the hierarchy where you want to add a menu to the menu tree.

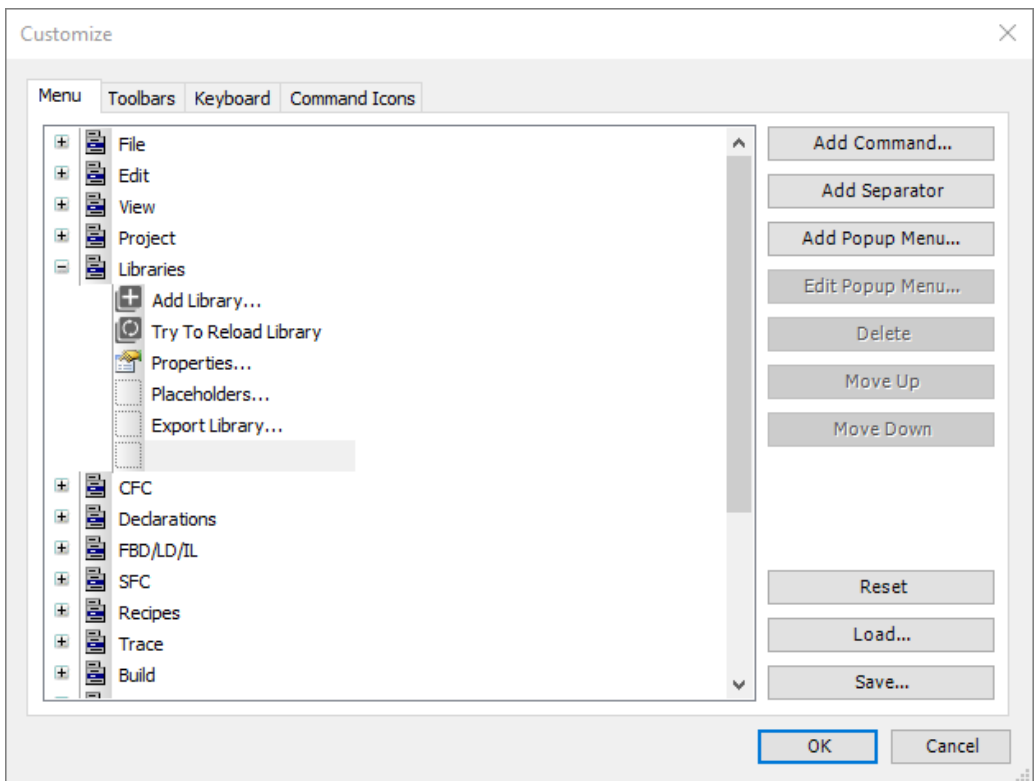

3. Click the [Add Popup Menu] button.
The [Add Popup Menu] dialog box appears.

3.7 Other Functions

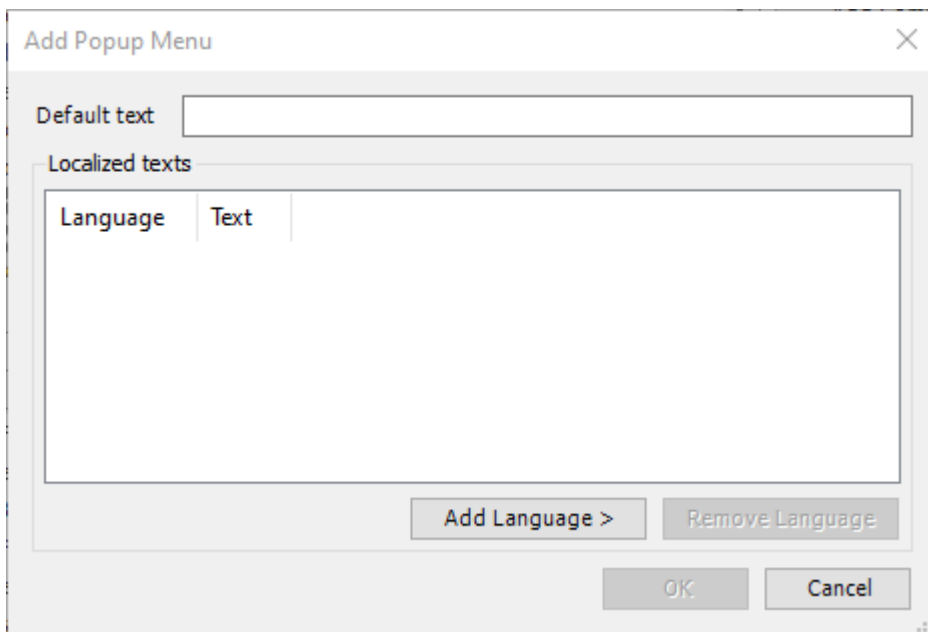

4. Enter a name for the new popup menu in the default text field.
You can use the [Add Language] button to add the name of the language you want to change. After selecting the language, click in the text field and enter text in the selected language.
5. Click the [OK] button.
A popup menu is added to the menu of the Customize dialog box.
You can change the order of the popup menus by clicking the [Move Up] and [Move Down] buttons.
6. Click the [OK] button.
The [Customize] dialog box closes and a popup menu is added to the menu bar.

i Info.

- When upgrading the version of GM Programmer, it will return to the default settings. Therefore, when upgrading the version of GM Programmer, please save the necessary settings in advance.
- You can edit the display of the added popup menu by clicking the [Edit Popup Menu] button.
- You can delete the added popup menu by clicking the [Delete] button.
- When the [Reset] button is clicked, the menu configuration returns to the default state.
- You can save the menu configuration by clicking the [Save] button. The extension of the saved file is `***.opt.menu`.
- You can load the saved menu configuration file by clicking the [Load] button.

Adding a toolbar

1 2 Procedure

1. Select [Tools] -> [Customize] in the menu bar.
The [Customize] dialog box appears.
2. Select the [Toolbar] tab.
The list of toolbars appears.

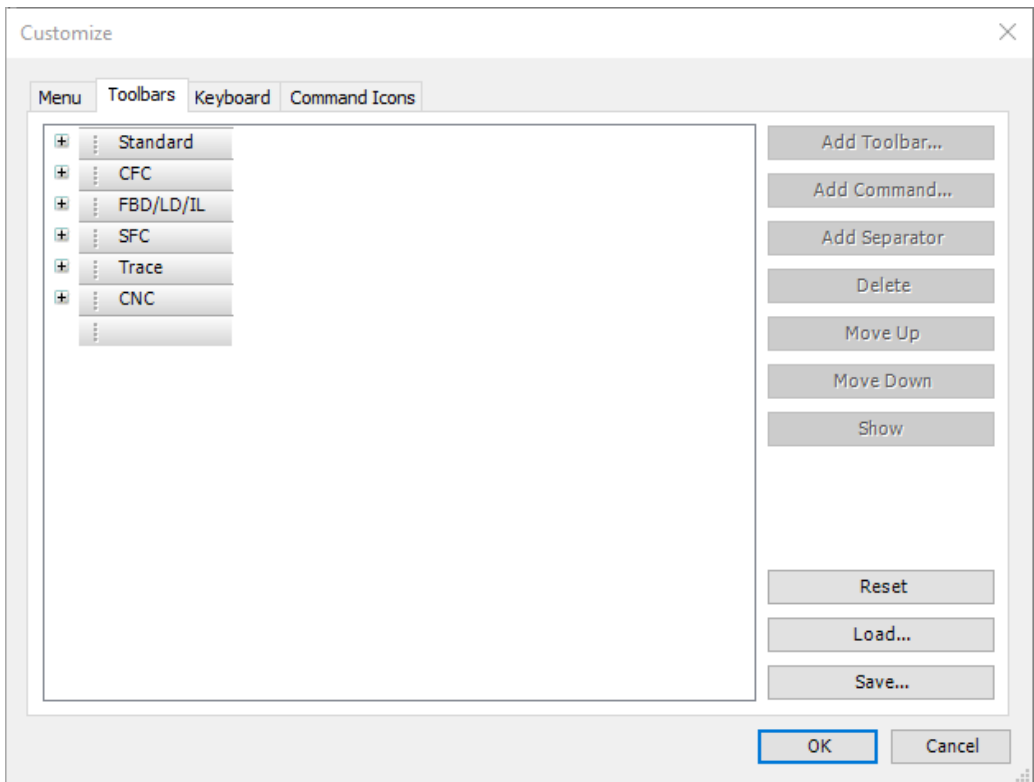

3. Select the toolbar and click the [Add Toolbar] button.
A new toolbar is added above the selected toolbar.
4. Enter a name for the toolbar.
The toolbar is added to the [Customize] dialog box.
You can change the order of the toolbars by clicking the [Move Up] and [Move Down] buttons.
This completes the addition of the toolbar.
5. This section explains how to add commands to the toolbar you've added. Expand the toolbar tree where you want to add new commands.
6. Select the whitespace symbol ().

3.7 Other Functions

7. Click [Add Command].

The [Add Command] dialog box appears.

A list of the commands you can add by category appears.

8. Select the command you want to add and click the [OK] button.

The command is added to the toolbar.

You can change the order of the commands by clicking the [Move Up] and [Move Down] buttons.

You can add a border between the commands by clicking the [Add Separator] button.

9. Click the [OK] button.

The Customize dialog box closes and the toolbar and commands are added.

i Info.

- When upgrading the version of GM Programmer, it will return to the default settings. Therefore, when upgrading the version of GM Programmer, please save the necessary settings in advance.
- You can delete added toolbars or commands by clicking the [Delete] button.
- Select the toolbar and click the [Hide] button to hide the toolbar. Click the [Show] button to make the toolbar visible again.
- Click the [Reset] button to reset the toolbar to the default state.
- You can save the toolbar by clicking the [Save] button. The extension of the saved file is `***.opt.tbar`.
- You can load a saved toolbar by clicking the [Load] button.

Changing command shortcut keys

You can change the shortcut keys assigned to commands.

1 2 Procedure

1. Select [Tools] -> [Customize] in the menu bar.
The [Customize] dialog box appears.
2. Select the [Keyboard] tab.
A list of commands by category appears.

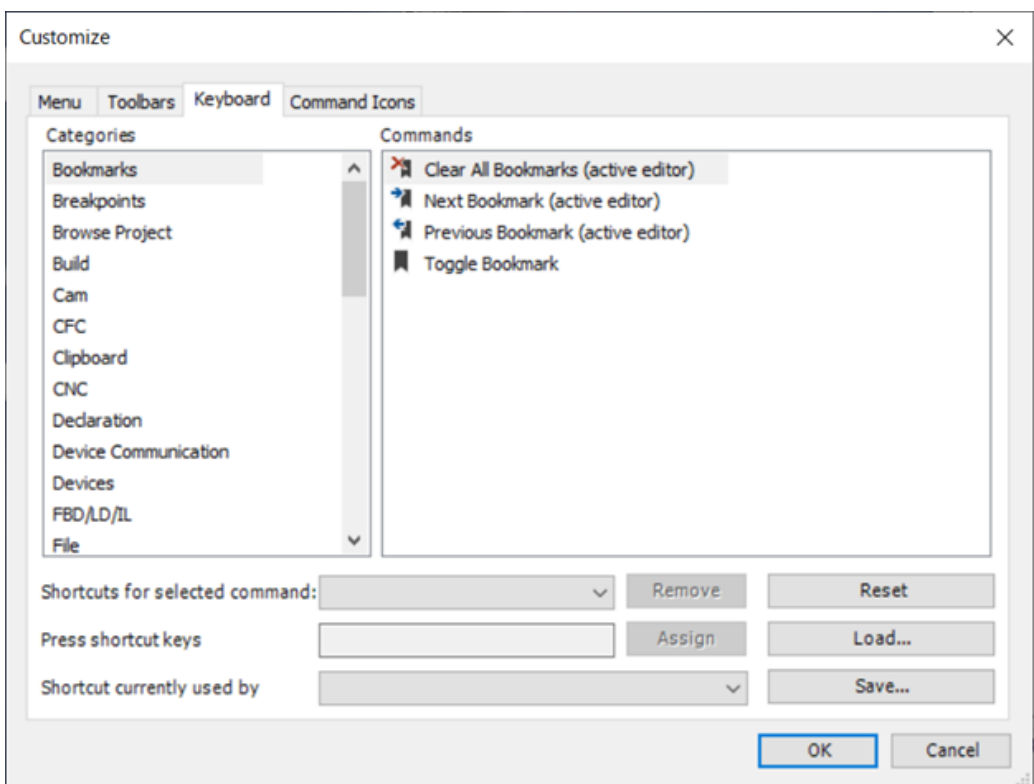

3. Select a category from the list in the Categories column.
The list of commands is displayed in the Commands field.
4. Select the command for which you want to set the shortcut key.
If a shortcut key is assigned to the selected command, it is displayed in the Shortcut field of the selected command.
5. In the shortcut key field, press the shortcut key you want to assign.
If the key you pressed appears in the field to press the shortcut key, it can be assigned.
 - <Ctrl>key + alphanumeric key or <F2>key to <F12>key
 - <Alt>key + alphanumeric key or <F2>key to <F12>key

3.7 Other Functions

- <Ctrl>key + <Shift>key + alphanumeric key or <F2>key to <F12>key
- <Shift>key + <F2>key to <F12>key
- key
- <Ins>key

6. Click the [Assign] button.

The shortcut that is assigned to the shortcut field for the selected command is shown.

7. Click the [OK] button.

The [Customize] dialog box closes and shortcut key is assigned to the command.

i Info.

- When upgrading the version of GM Programmer, it will return to the default settings. Therefore, when upgrading the version of GM Programmer, please save the necessary settings in advance.
- If you want to delete the shortcut key assigned to the command, select the command and click the [Delete] button.
Click the [OK] button to confirm the command shortcut key deletion.
- Select the toolbar and click the [Hide] button to hide the toolbar. Click the [Show] button to make the toolbar visible again.
- Click the [Reset] button to return the shortcut key assignment to the default state.
- You can save the shortcut key by clicking the [Save] button. The saved file has the extension `***.opt.keyb`.
- You can load the saved shortcut key file by clicking the [Load] button.

Changing command icons

You can change the icon assigned to a command.

1 2 Procedure

1. Select [Tools] -> [Customize] in the menu bar.
The [Customize] dialog box appears.
2. Select the [Command Icon] tab.
A list of commands by category appears.

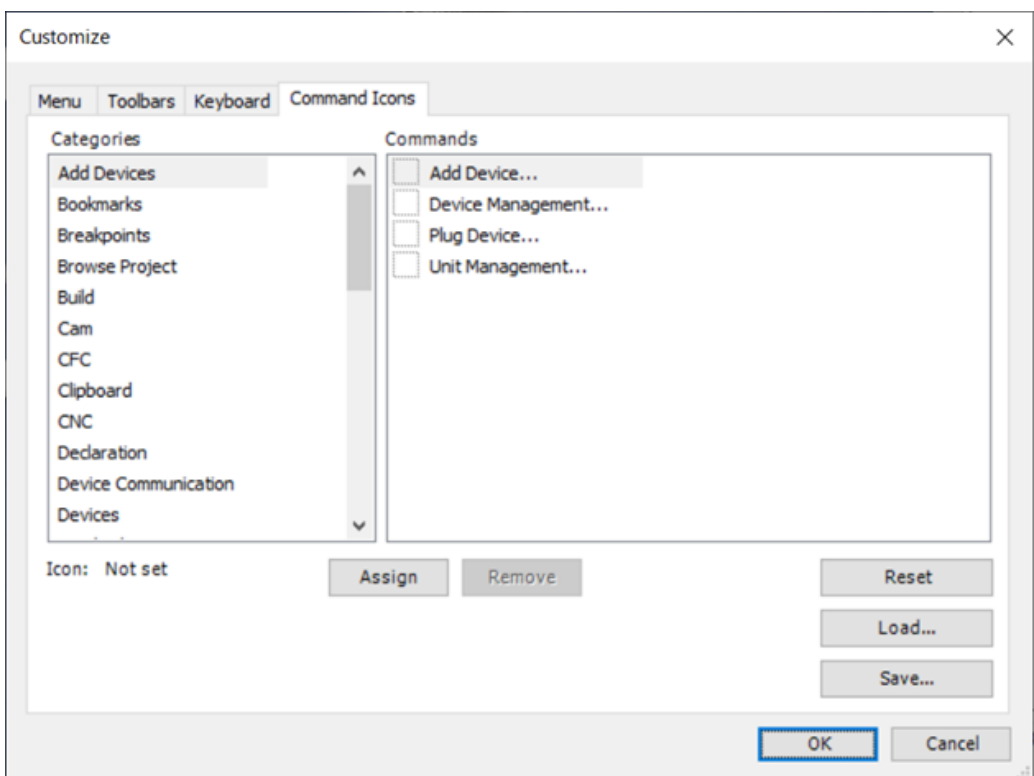

3. Select a category from the list in the Categories column.
The list of commands is displayed in the Commands field.
4. Select the command for which you want to set the icon.
5. Click the [Assign] button on the small icon and select an icon file (*.ico).
The selected icons are displayed.
6. Click the [OK] button.
The Customize dialog box closes and an icon is assigned to the command.

3.7 Other Functions

Info.

- When upgrading the version of GM Programmer, it will return to the default settings. Therefore, when upgrading the version of GM Programmer, please save the necessary settings in advance.
- You can delete the icon assignment by clicking the [Delete] button.
- Click the [Reset] button to return the icon assignment to the default state
- You can save the icon assignment state by clicking the [Save] button.
- You can load the saved file by clicking the [Load] button.

4 Project Operations

4.1 Project Creation Flow.....	4-2
4.2 Project operations	4-3
4.2.1 Creating a New Project	4-3
4.2.2 Device Tree Configuration	4-6
4.2.3 Project Configuration	4-8
4.2.4 Saving a Project.....	4-9
4.2.5 Closing a Project.....	4-10
4.2.6 Opening a Project	4-11
4.3 Setting up the GM1 Controller	4-12
4.4 Adding Objects.....	4-13
4.4.1 List of objects	4-16
4.5 Other project settings.....	4-17
4.5.1 Setting up a Project.....	4-17
4.5.2 Setting up a project save	4-19
4.5.3 Printing a Project and Object	4-23
4.5.4 Comparing Projects	4-26
4.5.5 Exporting and Importing Objects.....	4-31
4.5.6 Project File Conversion.....	4-35
4.5.7 Saving and unzipping the project archive	4-39

4.1 Project Creation Flow

4.1 Project Creation Flow

1. Setting up the GM1 controller(Refer to "[4.3 Setting up the GM1 Controller](#)")

Set up parameters for the GM1 controller.



2. Setting up motion control(Refer to "[9 Motion Control](#)")

- This section explains how to add device objects for servo amplifiers to a project and set them up.
- This section explains how to add device objects for free encoders and virtual drives to a project and set them up.



3. Setting up unit control(Refer to "[12 Unit Function](#)")

- This section explains how to set up general-purpose I/O, PWM output, and high-speed counter for the GM1 controller.
- This section explains how to add device objects for expansion units to a project and set them up.



4. Setting up the communication function(Refer to "[13 Communication Function](#)")

- This section explains how to add an object of the protocol to be used for the LAN/COM port to a project and set it up.



5. Program Creation(Refer to "[5 Program Creation](#)")

- Create the program.

4.2 Project operations

This section explains how to create a new project, open and close it.

4.2.1 Creating a New Project

When creating a program using the GM Programmer for the first time, create a new project. For the new project, set a device and a programming language to be used.

This section describes how to create a new project.

Given below is an example that explains the procedure to create a project for the GM1 controller (product number: AGM1CSRX16T) in Structured Text (ST) format.

1 2 Procedure

1. Start up the GM Programmer.

For details on how to start up, refer to "3.4.1 How to start".

When the GM Programmer is successfully started, the Start Page will be displayed.



2. Select "New Project" under "Basic Operations".
The "New Project" dialog box will be displayed.

4.2 Project operations

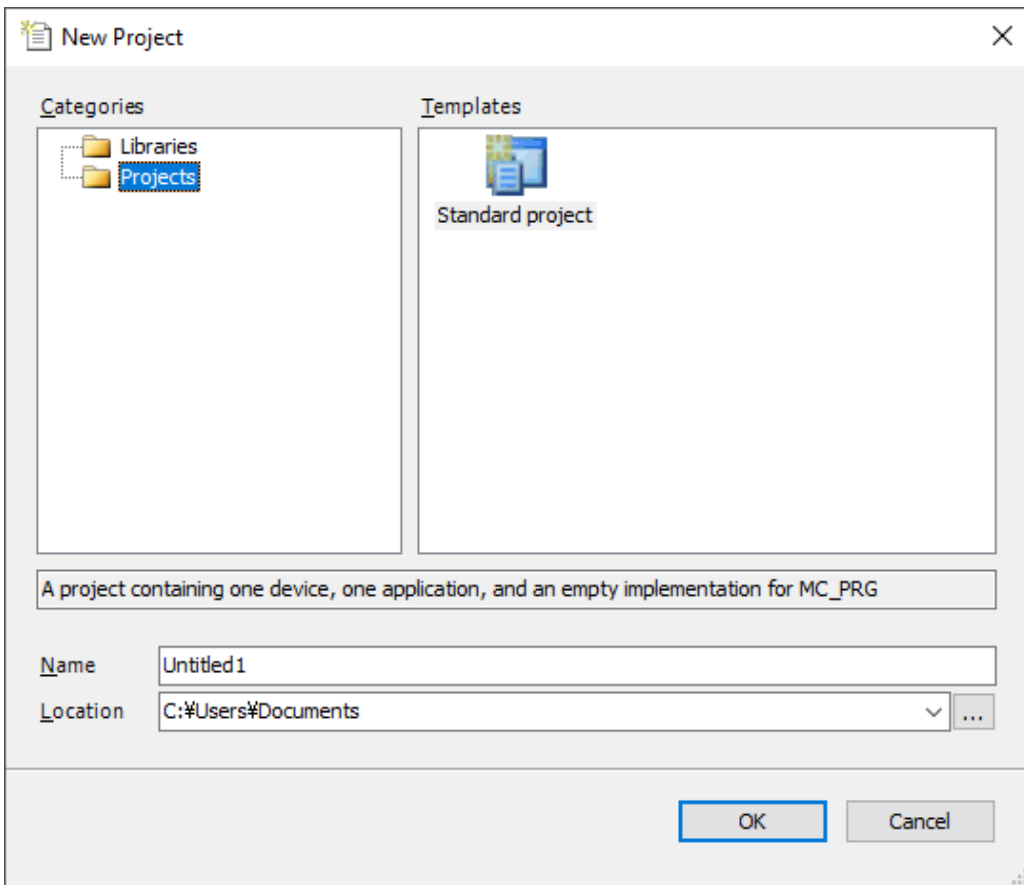

3. Select **Project>Standard project**, and specify a project file name in the "Name" field and a project storage location in the "Location" field.
4. Click the [OK] button.
The "Standard Project" dialog box will be displayed.

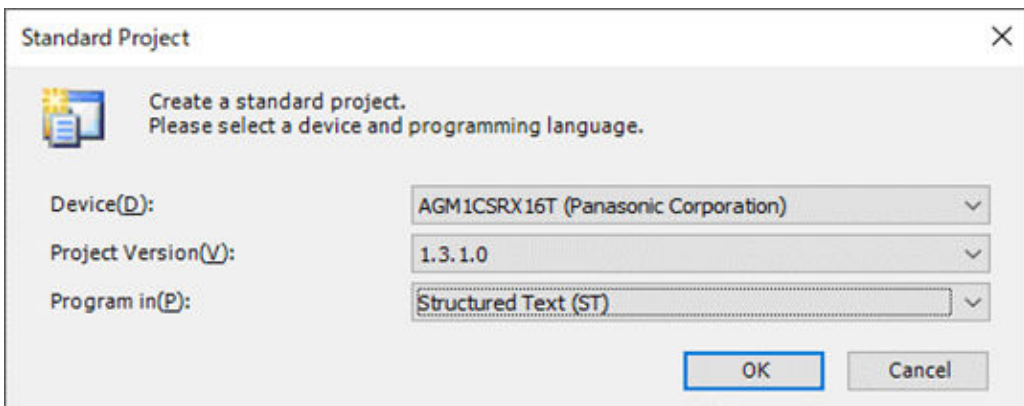

No.	Name	Function
(1)	Device	Sets up Device.

No.	Name	Function
		AGM1CSRX16T:RTEX communication AGM1CSEC16T/P : EtherCAT communication
(2)	Project version	Sets up Project version Refer to "3.2 Version System".
(3)	Programming language	Sets up Programming language. Refer to "6 Entering programs in each Programming language and Variable".

5. Select "AGM1CSRX16T(Panasonic Corporation)" in the "Device" field and "Structured Text (ST)." in the "Program in" field, and click the [OK] button.
A new project will be created. Device and other objects including objects for ST programs are arranged in the navigator pane.

<Uses of objects arranged in the navigator pane>

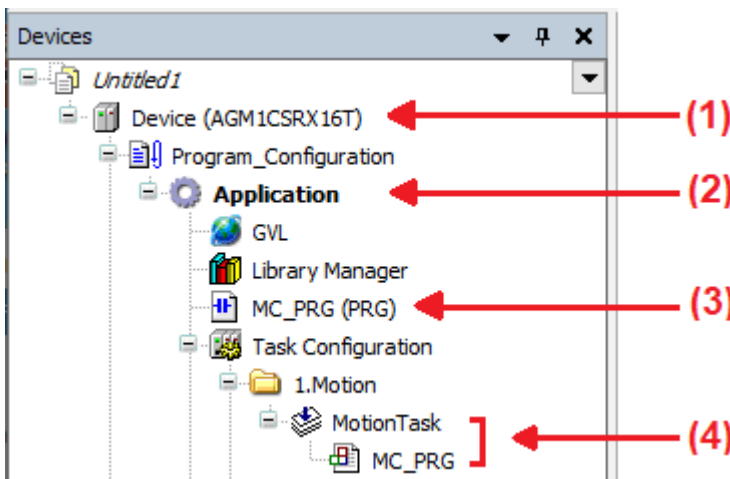

No.	Name	Function
(1)	Device object	Sets up device objects.
(2)	Application object	Sets up application objects.
(3)	Program object (POU object)	Sets up program objects (POU objects).
(4)	Task object	Sets up task objects.

i Info.

- A new project can also be created from the menu bar by selecting **File>New Project**.

4.2 Project operations

4.2.2 Device Tree Configuration

When a new project is created, it is started in the device tree configuration shown below.

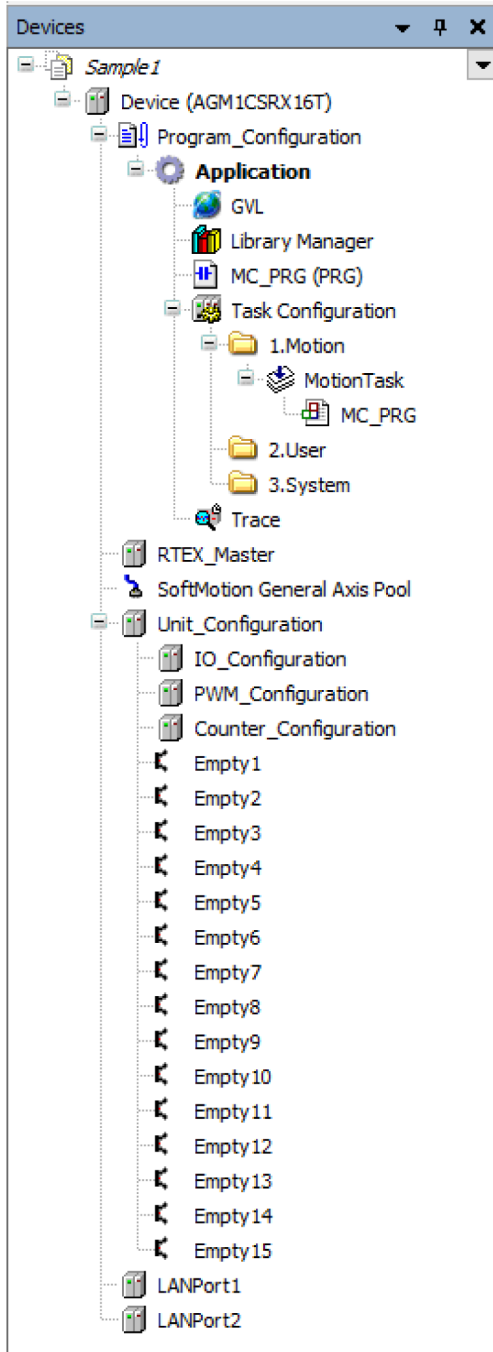

Name	Overview
Sample1	Project name
Device	GM1 Controller device
Program Configuration	Object that defines applications including source codes
Application	Application object
GVL	Global variable object
Library_Manager	List of all libraries linked to the project
MC_PRG(PRG)	Main program
Task Configuration	Configuration of tasks invoking application programs
1.Motion	User program tasks for motion control
MotionTask	
MC_PRG	
2.User	User program task for any control other than motion control
3.System	Task used by the system
Trace	Object that monitors variable data graphically
RTEX_Master	Object that is the parent node of servo amplifiers for RTEX (RTEX only)
EtherCAT_Master_SoftMotion	Object that is the parent node of servo amplifiers for EtherCAT (EtherCAT only)
SoftMotion General Axis Pool	Object that is an interface for inserting a free drive unit
Unit_Configuration	Object that is the parent node of I/O related devices
IO_Configuration	General-purpose I/O incorporated in GM1 controller
PWM_Configuration	PWM output incorporated in GM1 controller
Counter_Configuration	High-speed counter incorporated in GM1 controller
Empty1	Objects for adding I/O for expansion unit
Empty2	
Empty3	
Empty4	
Empty5	
Empty6	
Empty7	
Empty8	
Empty9	
Empty10	
Empty11	
Empty12	
Empty13	

4.2 Project operations

Name	Overview
Empty14	Objects that are the parent node of devices that use the Ethernet protocol
Empty15	
LAN Port1	
LAN Port2	

4.2.3 Project Configuration

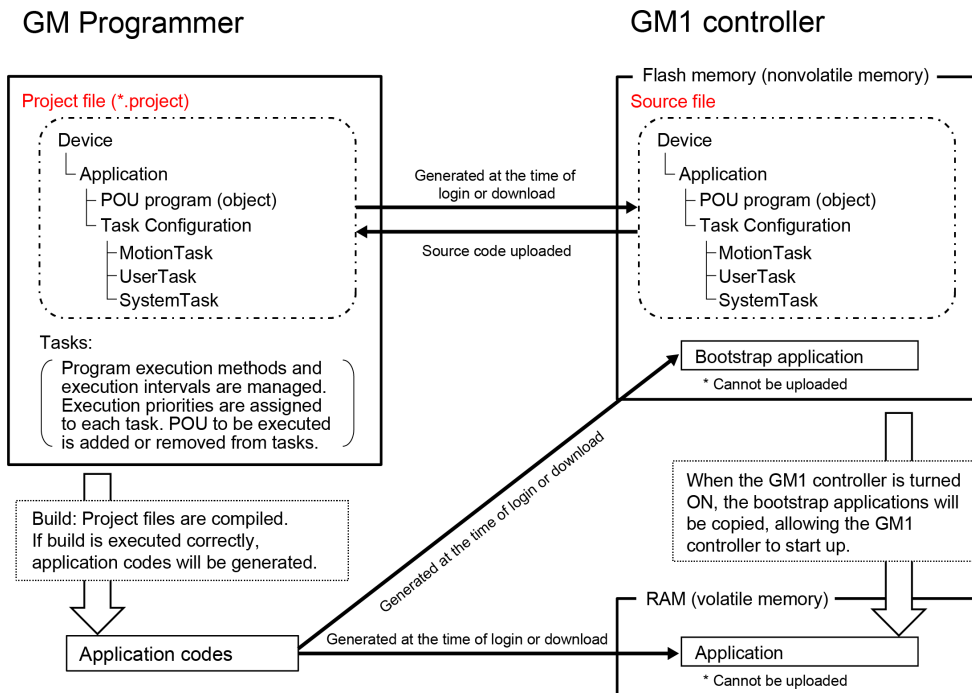

4.2.4 Saving a Project

Save a project that is created. The project will be saved as a file with extension ".project". Unsaved projects are indicated by "*" on the right side of their project file names on the title bar.

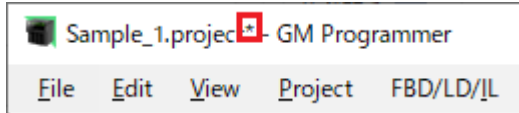

1 2 Procedure

1. From the menu bar, select **File>Save Project**, or press the shortcut keys "Ctrl+s". A project that has been created will be saved. "*" displayed on the right side of the project file name will disappear.

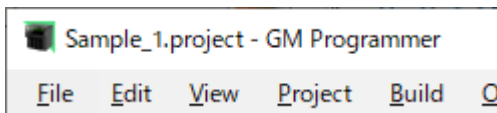

i Info.

- Before saving a project, you can change its project name. From the menu bar, select **File>Save Project As**.
- Project files can be saved automatically. For details, refer to "[Automatically Saving Project Files](#)".
- Before updating a file, you can save it as a backup file. For details, refer to "[Creating a Backup when a Project Is Saved](#)".

4.2 Project operations

4.2.5 Closing a Project

1² Procedure

1. From the menu bar, select **File>Close Project**.
The project that has been created will be closed.

i Info.

- If you select "Close Project" without saving a project file that has been updated, a confirmation dialog box will be displayed, asking whether to save the project. Click the [Yes] button to save the project.

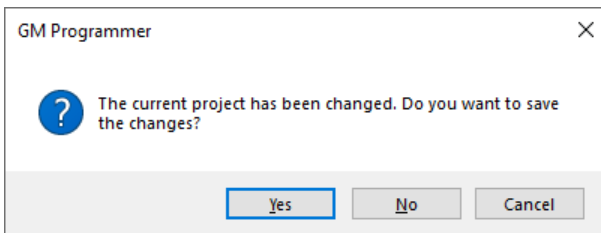

4.2.6 Opening a Project

1 2 Procedure

1. From the menu bar, select **File>Open Project**.
The "Open Project" dialog box will be displayed.

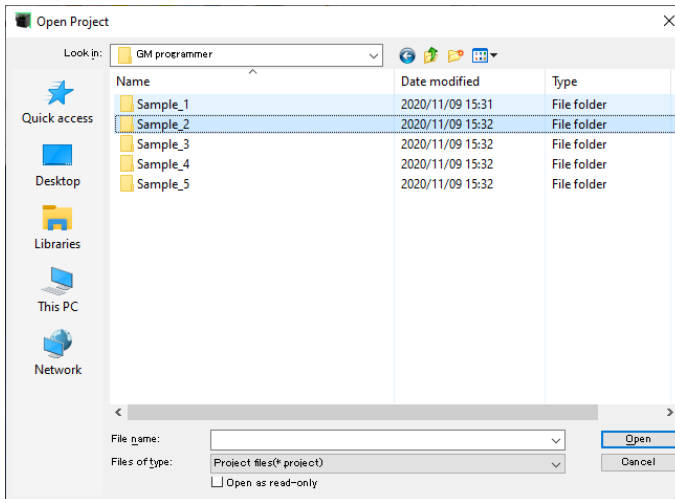

2. Select a project file and click the [Open] button.
The selected project file will be opened.

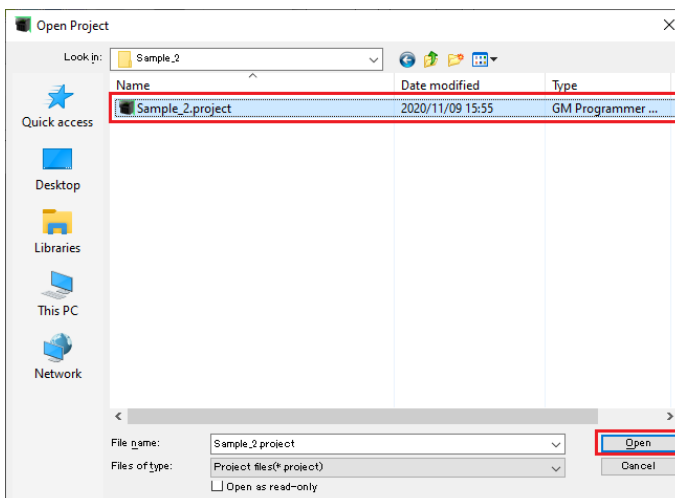

4.3 Setting up the GM1 Controller

4.3 Setting up the GM1 Controller

This section explains how to set up parameters for the GM1 controller.

1 2 Procedure

1. Double-click the [Device] object in the navigator pane. In the Device pane, the Communication Settings sub-pane will be displayed.

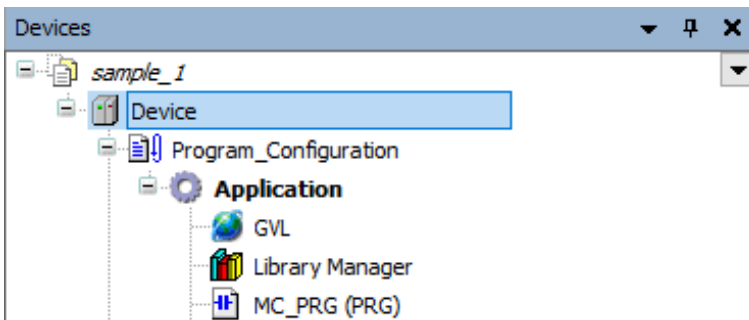

2. Click the "PLC parameters" tab. The parameter settings sub-pane will be displayed.

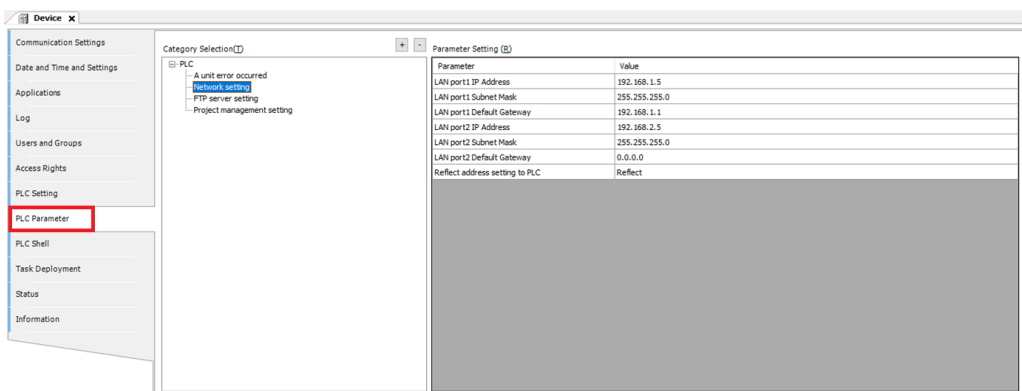

3. Change the values of the parameters that you want to update.
A unit error occurred : Select whether to stop or continue operation when an error occurs (For details, refer to "Unit Error" of high-speed counter function.)
Network setting : IP address, subnet mask, and default gateway of LAN port 1 and LAN port 2, Reflect address setting to PLC
FTP server setting : Set parameters related to FTP server (For details, refer to "13.7.3 List of Setting Items".)
Project management setting : Set parameters related to project management (For details, refer to "14.6 Project Management Function")

4.4 Adding Objects

Program creation objects (POU objects) and objects with various functions can be added to applications within a project.

For example, use the following procedure to add POU objects for ST programs.

1 2 Procedure

1. Right-click the [Application] object in the navigator pane and then select **Add Object>POU** from the context-sensitive menu that is displayed.

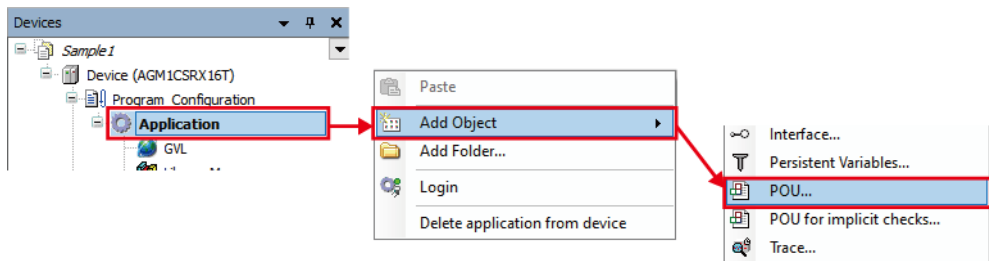

The "Add POU" dialog box will be displayed.

The 'Add POU' dialog box is shown with the following fields and options:

- Name:** POU
- Type:**
 - Program**
 - Function block**
 - Extends [] ...
 - Implements [] ...
 - Final Abstract
- Access specifier:** []
- Method implementation language:** Ladder Logic Diagram (LD)
- Function**
 - Return type:** [] ...
- Implementation language:** Continuous Function Chart (CFC)
- Buttons:** Add, Cancel

4.4 Adding Objects

2. Enter a program name in the "Name" field, select a programming language from the "Implementation Language" drop-down list, and click the [Add] button.

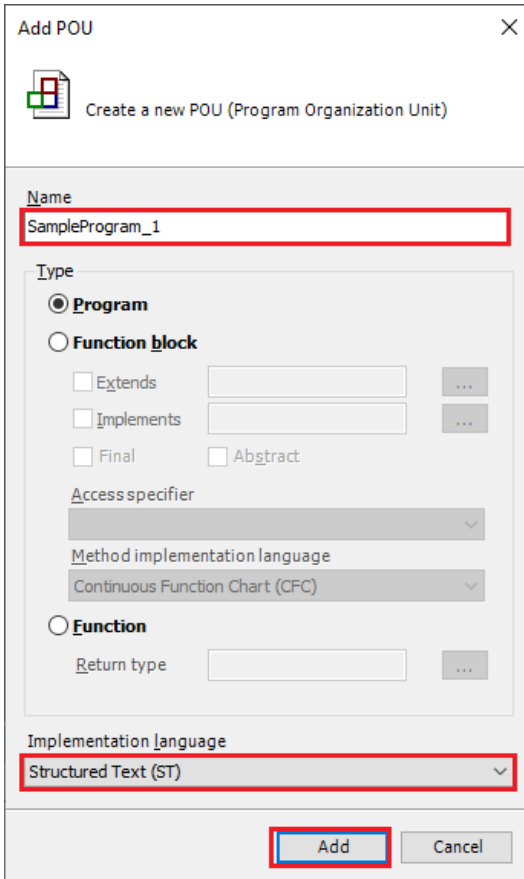

The screenshot shows the "Add POU" dialog box. At the top, it says "Add POU" with a close button. Below that is a document icon and the text "Create a new POU (Program Organization Unit)". The "Name" field contains "SampleProgram_1". Under the "Type" section, "Program" is selected with a radio button. There are options for "Function block" and "Function". Under "Function block", there are checkboxes for "Extends", "Implements", "Final", and "Abstract", each with a corresponding text field and a three-dot menu. There are also dropdown menus for "Access specifier" and "Method implementation language". Under "Function", there is a "Return type" field with a three-dot menu. At the bottom, the "Implementation language" dropdown is set to "Structured Text (ST)". The "Add" button is highlighted with a red box.

A [POU] object for the programming language selected in the "Implementation Language" drop-down list will be added to the navigator pane.

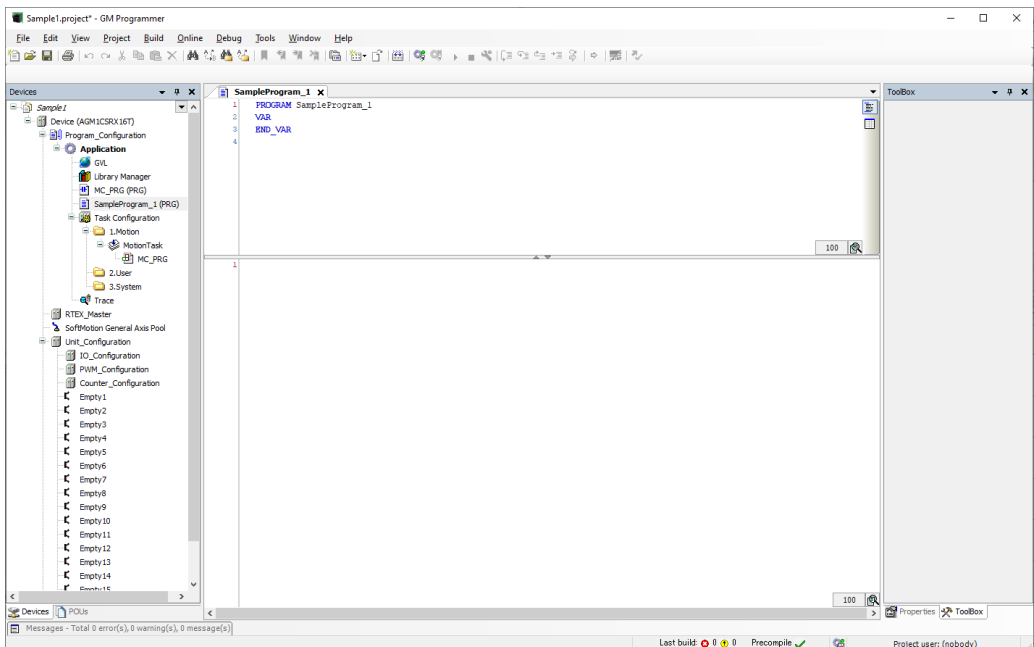

i Info.

- You can also add objects by selecting the [Application] object in the navigator pane and then selecting **Project>Add Object** from the menu bar.
- To remove an object, select the object in the navigator pane and then press the "Delete" key or right-click the object and then select "Delete" from the context-sensitive menu that is displayed.
- You can add folders under the [Application] object in the navigator pane. By adding objects under each folder, you can create a hierarchical structure.

Right-click the [Application] object in the navigator pane and then select "Add Folder" from the context-sensitive menu that is displayed. The "Add Folder" dialog box will be displayed. Enter a folder name and click the [OK] button.

Example: When a [POU] object is added under an added folder (program for project A)

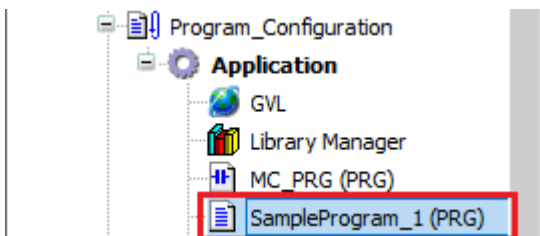

- You can also add an object for creating functions and function blocks. For details, refer to "5.5 Function and Function Block".

4.4 Adding Objects

4.4.1 List of objects

Check the following list for objects that can be added.

Addition source	Added object
Device	DeviceTrace
Application	CNC program CNC setting DUT POU Interface Cam table Global variable list Symbol Configuration Trace Visualization Recipe manager External file Extended Cam table Persistent variable POU for implicit checks
POU	Action Transition Property Methods
Interface	Interface property Interface method
Global Variables	Property
Persistent variable	Property
MotionTask	Program call
"2.User" folder	UserTask

4.5 Other project settings

4.5.1 Setting up a Project

Projects can be set up using the "Project Settings" dialog box. The settings will be applied to only the project that is set up.

1 2 Procedure

1. From the menu bar, select **Project > Project Settings**.

"Project Settings" dialog box will be displayed.

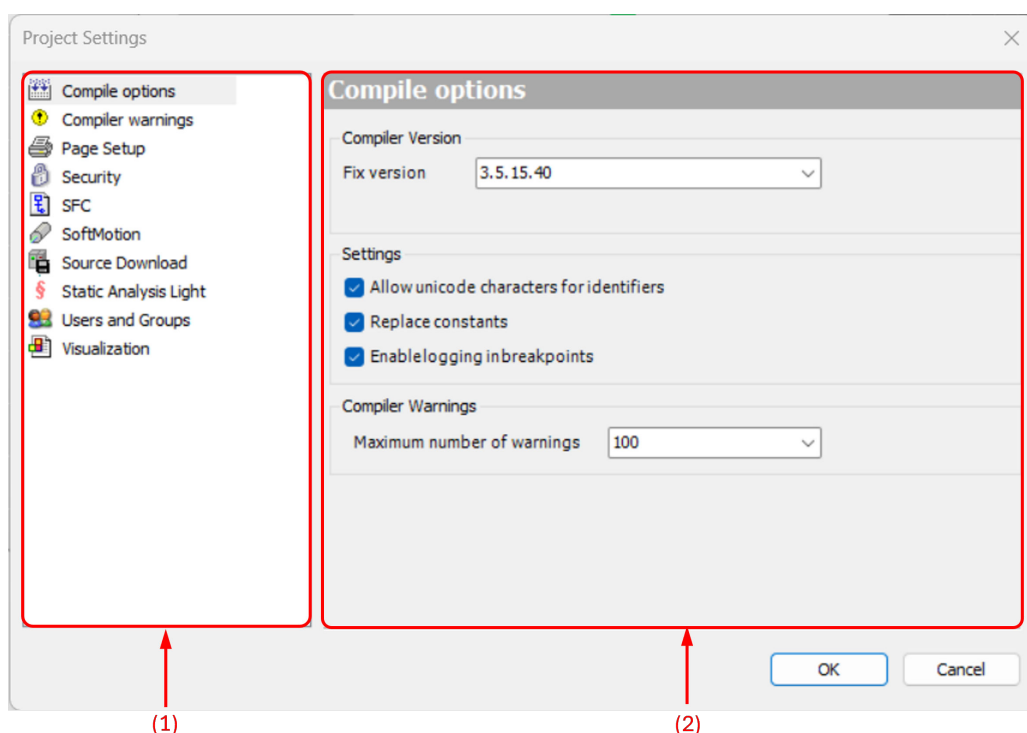

No.	Name	Function
(1)	Categories pane	Displays project setting categories.
(2)	Setting pane	Displays the settings of the selected category and allows the user to configure settings.

Project setting categories

Category name	Function	Reference page
SFC	Allows the user to configure settings related to variables used in SFC and code generation.	"P.6-23"
SoftMotion	Displays the version of the SoftMotion package.	"P.9-15"

4.5 Other project settings

Category name	Function	Reference page
Srarcic Analysis Light	Allows the user to configure settings regarding whether to enable code analysis during code generation.	"P.5-64"
Compiler warnings	Allows the user to configure settings regarding whether to enable warnings output during build.	"P.14-31"
Compile options	Allows the user to configure build-related settings such as whether to enable Unicode for the program objects (POU objects) and the number of compiler warnings to be output.	"P.8-8"
Security	Allows the user to configure settings related to project file encryption using passwords.	"P.14-16"
Source Download	Allows the user to configure settings related to the timing of source download.	—
Visualization	Allows the user to configure Visualization to be used for debugging.	"P.8-39"
Page Setup	Allows the user to configure printing-related settings.	—
Users and groups	Allows the user to add, edit, and remove users and groups for project user management.	"P.14-3"

2. Select a desired category from the Categories pane.
The setting items for the selected category will be displayed in the setting pane.
3. Change the setting items as appropriate and click the [OK] button.
The setting items will be applied.

4.5.2 Setting up a project save

Automatically Saving Project Files

Project files can be saved automatically during editing. Even if data disappears when GM Programmer terminates abnormally, a file up to the point in time when it was saved automatically can be restored. The extension of backup files is ".autosave".

1 2 Procedure

1. From the menu bar, select **Tools>Options**.
The "Options" dialog box will be displayed.
2. Select the "Load and Save" category.
The "Load and Save" pane will be displayed.

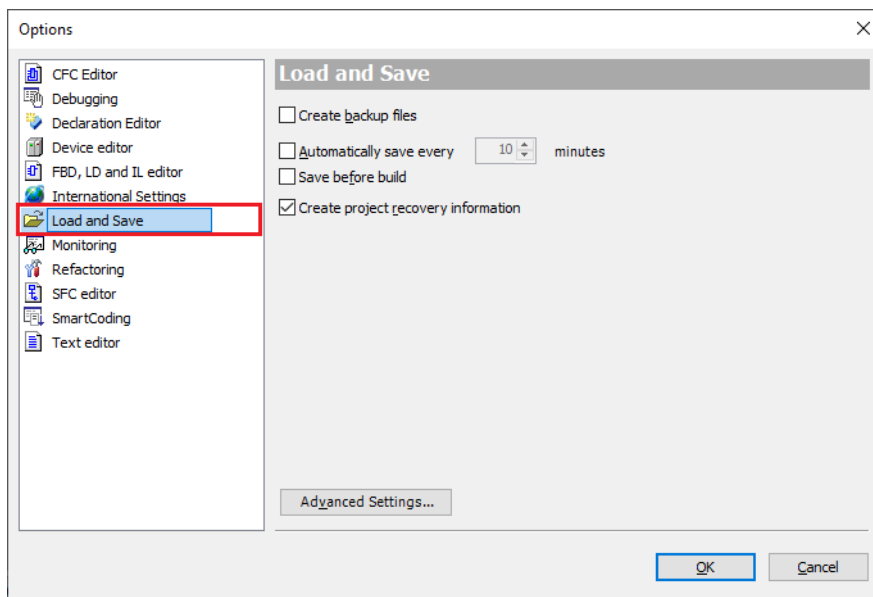

3. Select the "Automatically save every" check box and click the [OK] button.
The automatic save interval can be changed in minutes (default value: 10 minutes).

4.5 Other project settings

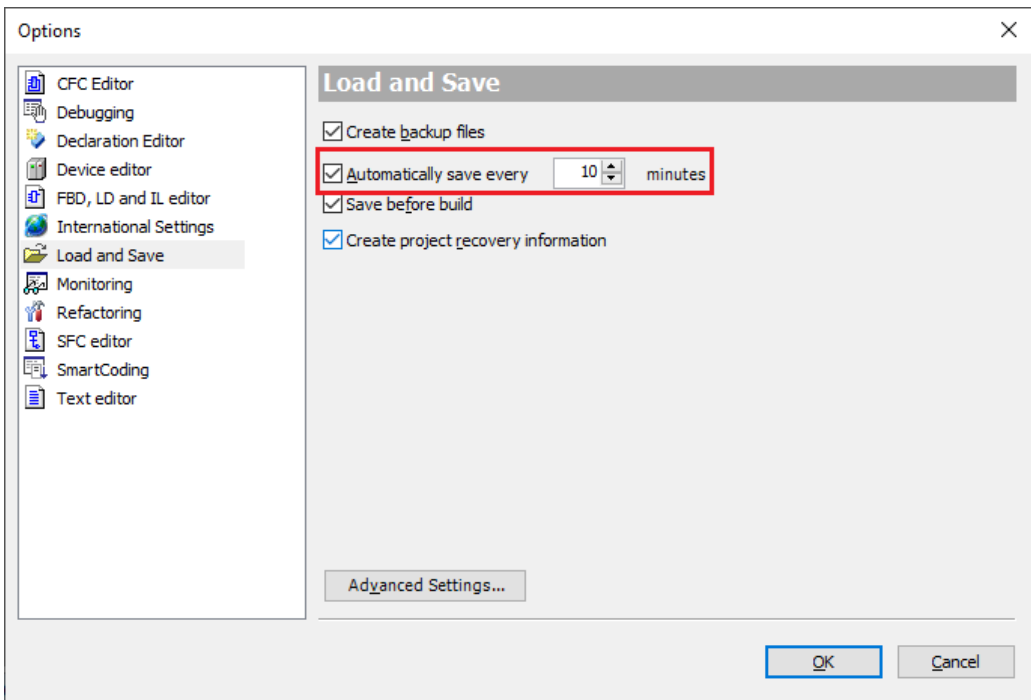

After auto save is set, project files will be automatically saved as files with extension ".autosave" at the specified interval during editing.

After a project file is closed due to abnormal termination of GM Programmer, when you open the project file again, you can select either the original project file with extension ".project" or the automatically saved project file with extension ".autosave". To open the automatically saved project file, click the [Open Auto Save File] button.

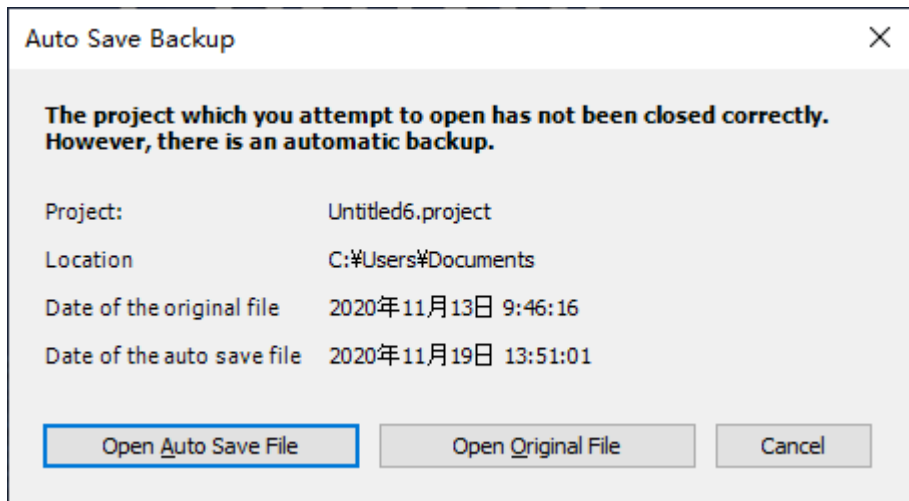

Creating a Backup when a Project Is Saved

When saving a project, you can create a backup file of the project file to be updated. The extension of backup files is ".backup".

1 2 Procedure

1. From the menu bar, select **Tools>Options**.
The "Options" dialog box will be displayed.
2. Select the "Load and Save" category.
The "Load and Save" pane will be displayed.

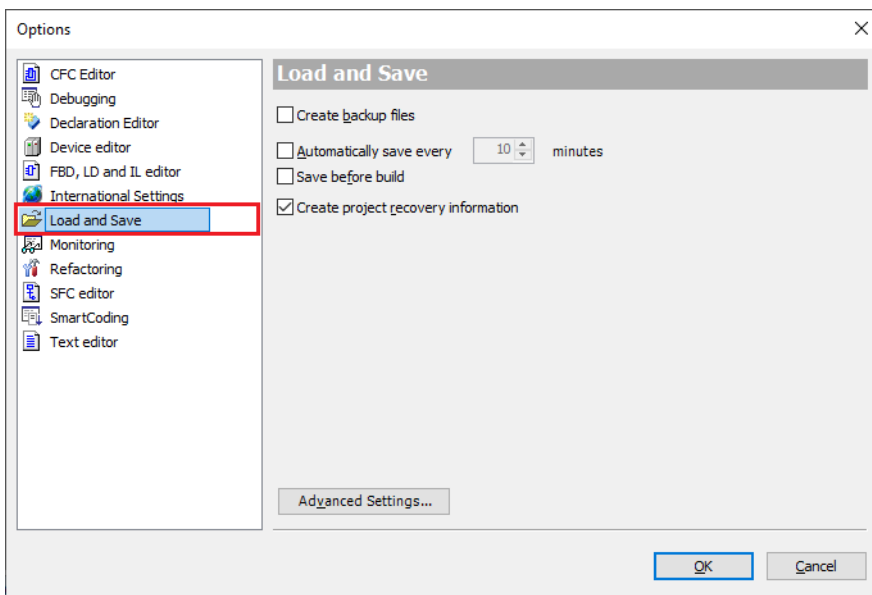

3. Select the "Create backup files" check box and click the [OK] button.
Then, whenever a project is saved, the project file to be updated will be automatically saved as a backup file (with extension ".backup").

4.5 Other project settings

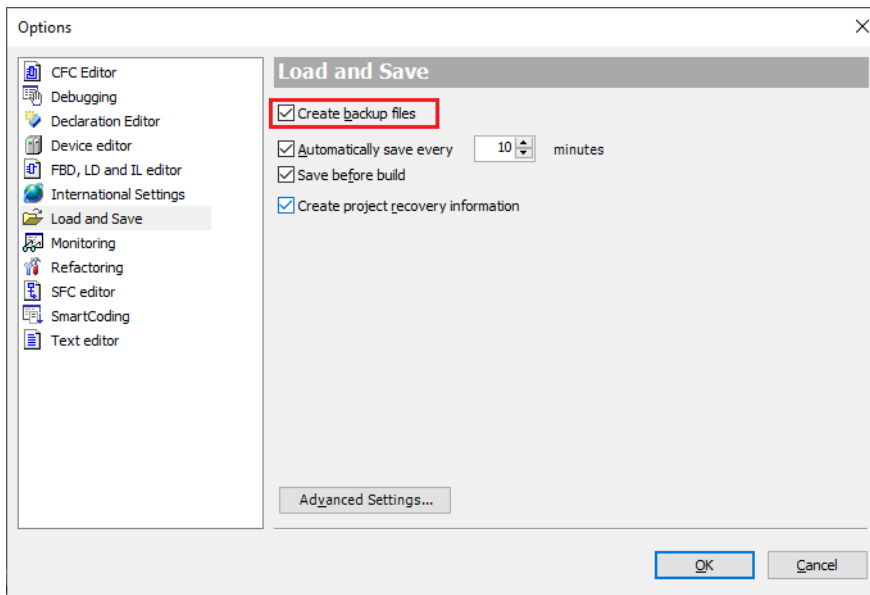

<Restoring backup files>

To restore a project file that has been backed up, manually change the extension of the file from ".backup" to ".project" and then open the project file in GM Programmer.

4.5.3 Printing a Project and Object

Printing a Project

You can print the entire project.

1 2 Procedure

1. From the menu bar, select **Project>Document**.
The "Document Project" dialog box will be displayed.

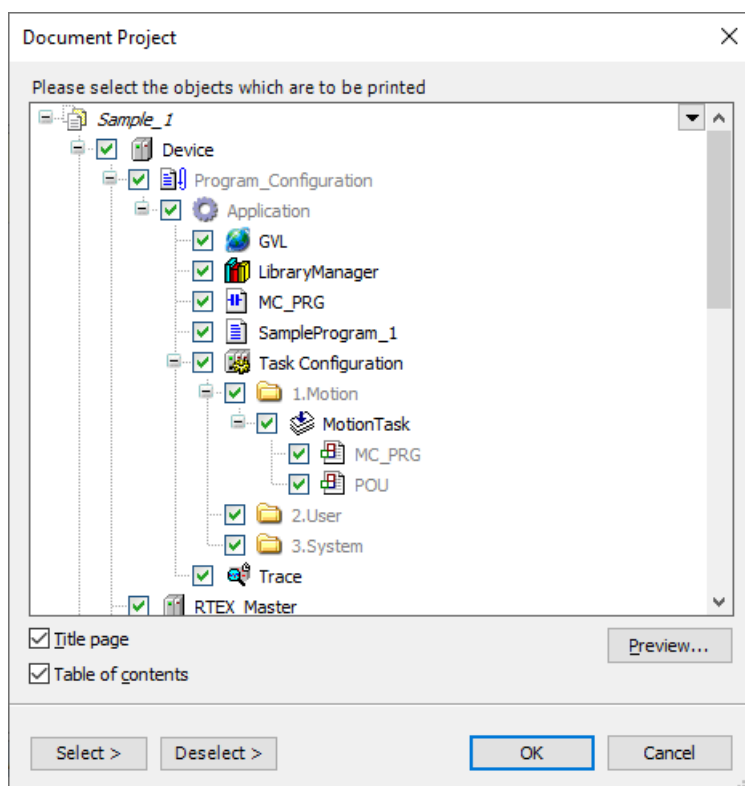

2. Select the check boxes of the devices and objects for which documents are to be printed, and click the [OK] button.
The "Print" dialog box will be displayed. Select a printer to be used and click the [OK] button.
Documents will be printed.

4.5 Other project settings

Info.

- By clicking the [Preview] button in the "Document Project" dialog box, a print preview window is displayed, so that you can check what a hard copy would look like when printed.
- You can edit page orientation, margin, header, footer, table of contents, and title page details. From the menu bar, select **File>Page Setup**. The "Project Settings" dialog box will appear with the Page Setup pane displayed. Select the tab of the item to be changed and change the settings.

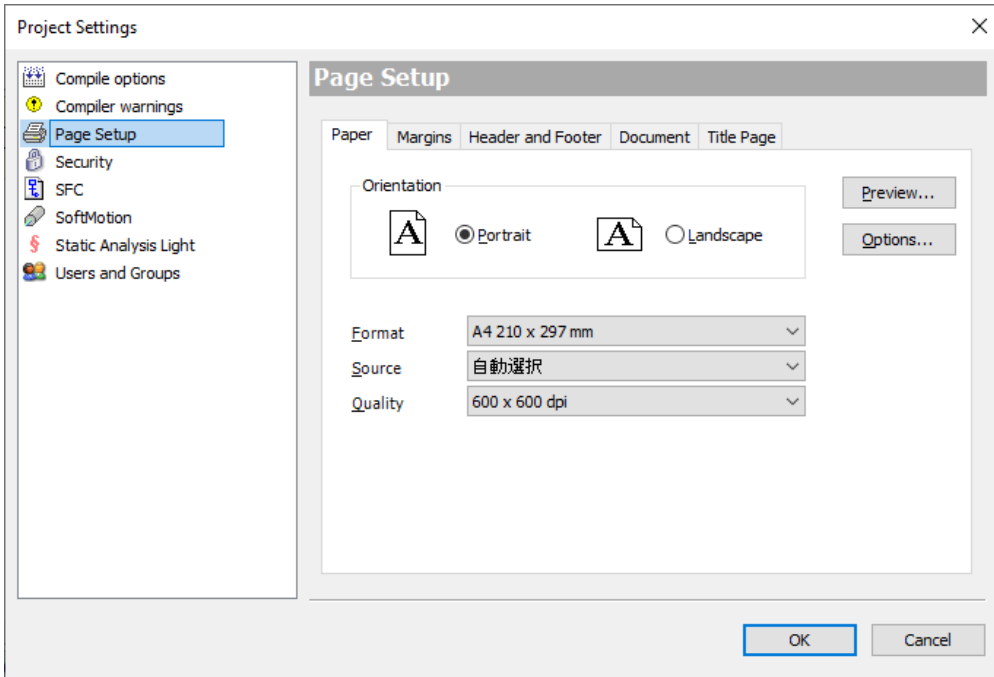

Printing an Object within a Project

1 2 Procedure

1. With the object editor opened, from the menu bar, select **File>Print**.
The "Print" dialog box will be displayed. Execute printing.

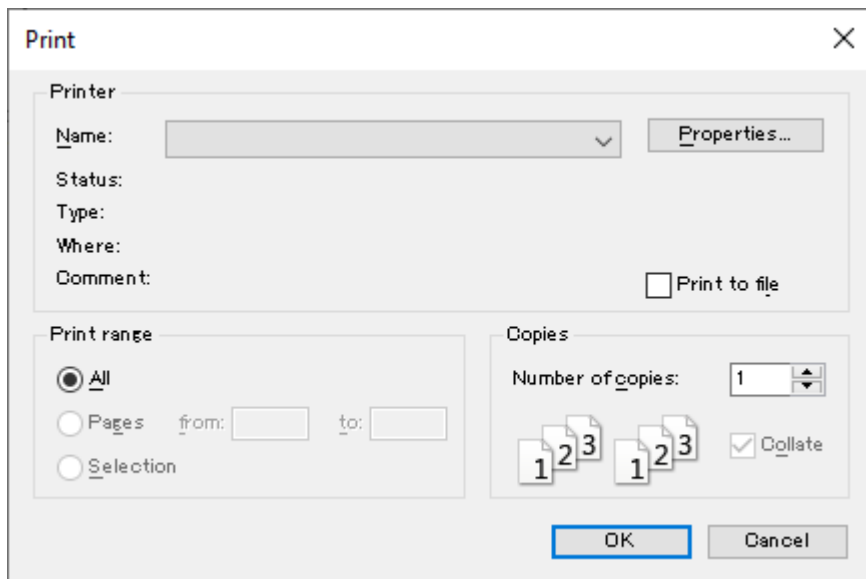

4.5 Other project settings

4.5.4 Comparing Projects

You can compare the opened project file with another project file to display and merge the differences between them.

Project Comparison Method

Compare the opened project file with another project file.

1 2 Procedure

1. From the menu bar, select **Project>Compare**.
The "Project Comparison" dialog box will be displayed.

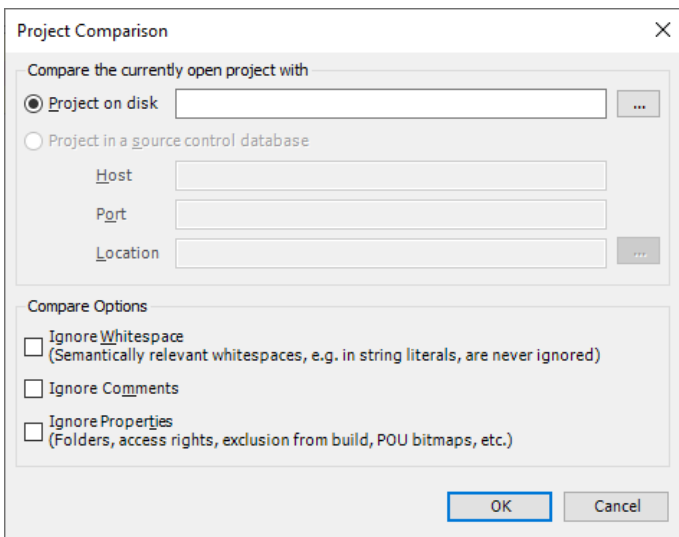

2. In the "Project on disk" field, specify a project file to be compared with and click the [OK] button.
The comparison results will be displayed in the main pane.
The backgrounds of object lines with differences are displayed in gray. The text color of each object indicates the type of difference.

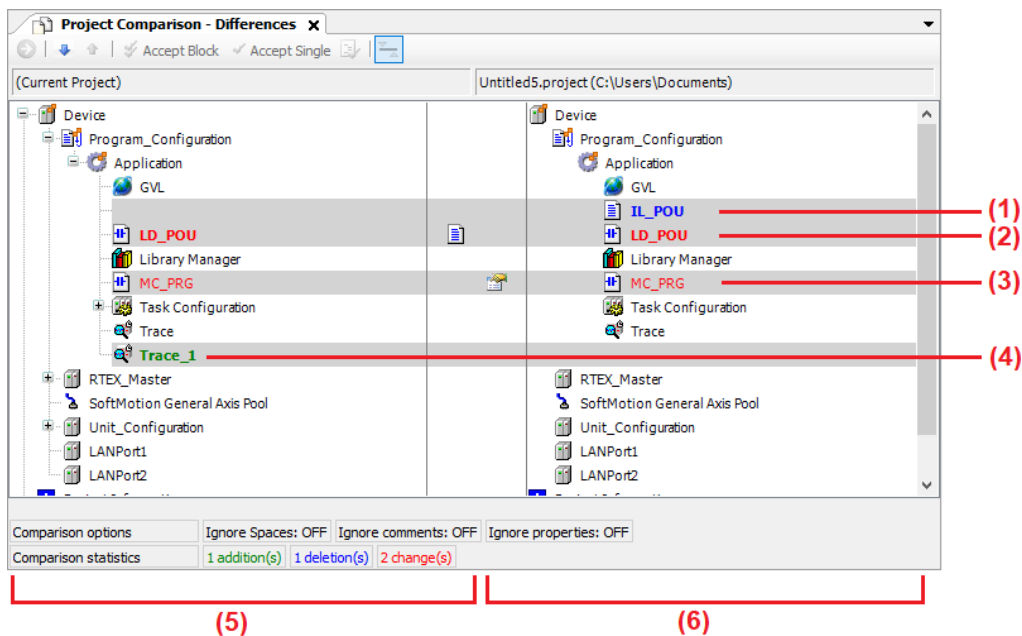



No.	Description
(1)	Removed object
(2)	Object with a difference in contents
(3)	Object with a difference in properties
(4)	Added object
(5)	Opened project
(6)	Specified project

Double-clicking an object line with a difference in contents displays the object comparison results.

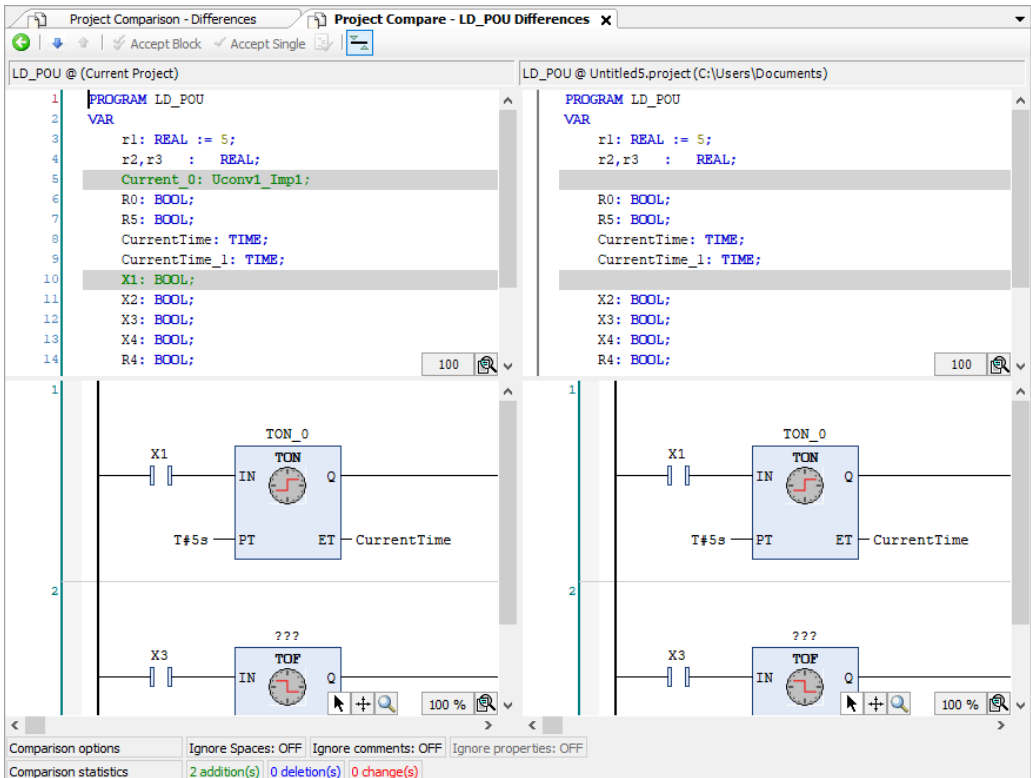
4.5 Other project settings



Clicking the  icon returns the display to the comparison view in the navigator pane.

Clicking the  icon switches to the mode in which comparison results including removed object lines are displayed. The above window in which comparison results are displayed will be switched to the window shown below. If the differences displayed as variable bVar0 and empty lines that have been added differ from the specifications of variable bVar0, differences will be displayed as changes in variable bVar0.

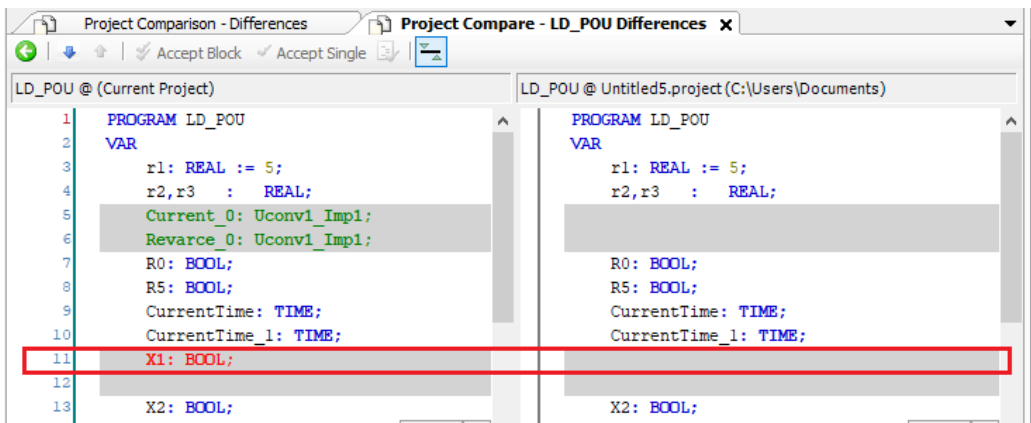

Merging Differences

Differences displayed by comparing projects can be merged into the opened project.

When there are differences in the contents of objects, the differences can be merged by using the [Accept Block] button or [Accept Single] button.

For example, use the following procedure to merge the differences in the contents of programs.

1 2 Procedure

1. Perform project comparison.

Project comparison results will be displayed.

For details on how to perform project comparison, refer to "[Project Comparison Method](#)".

2. Move the cursor to the difference location and click the [Accept Block] button or [Accept Single] button.

The difference will be merged into the opened project. The background of the merged section will be displayed in yellow. At this stage, the merged content has not been reflected in the project yet. To reflect the merged content, approval operation is required as below.

[Accept Block] button: Merges the entire block containing the difference at the cursor position

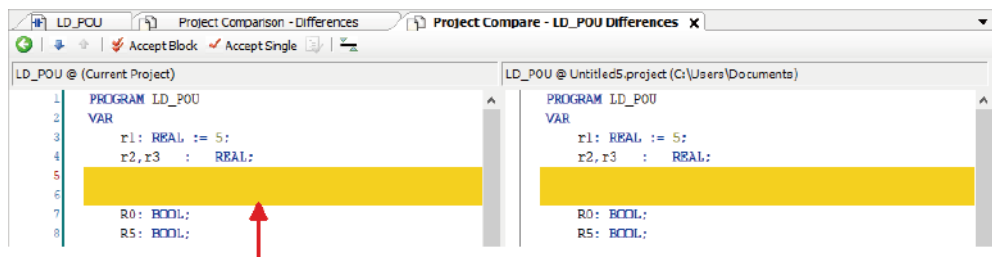

Merge the entire block containing the difference at the cursor position (delete two lines)

[Accept Single] button: Merges the difference at the cursor position

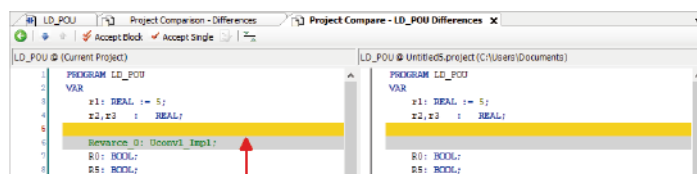

Merge the difference at the cursor position (delete one line)

3. From the menu bar, select **Project>Commit accepted changes**.

The merged content will be approved and reflected in the opened project. Because the reflected content has not been saved yet, save the project as necessary.

4.5 Other project settings

Info.

- To merge between objects whose properties are different, select an object with differences and click the  icon. The "Accept" dialog box will be displayed. Select the "Properties" check box and click the [OK] button.

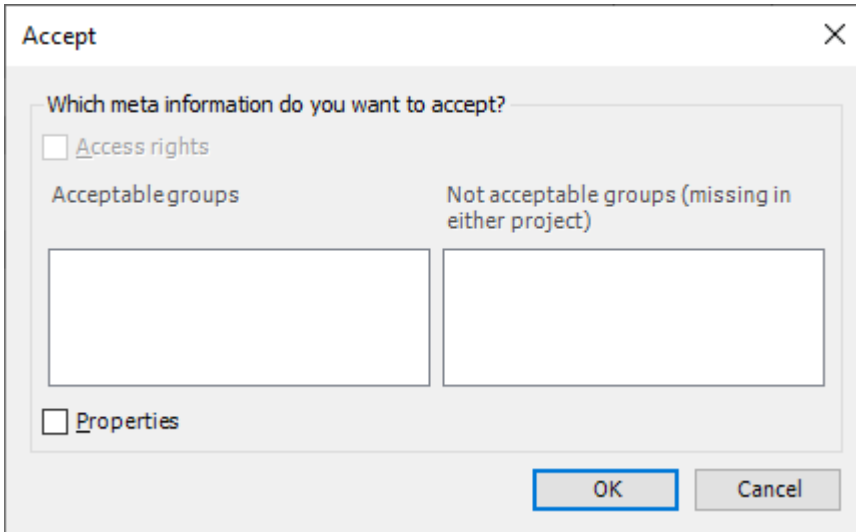

4.5.5 Exporting and Importing Objects

Objects in a project can be exported as XML files. The extension of exported files is ".export". Files that are being exported can be imported to GM Programmer.

Exporting Objects

1 2 Procedure

1. From the menu bar, select **Project>Export**.
The "Export" dialog box will be displayed.

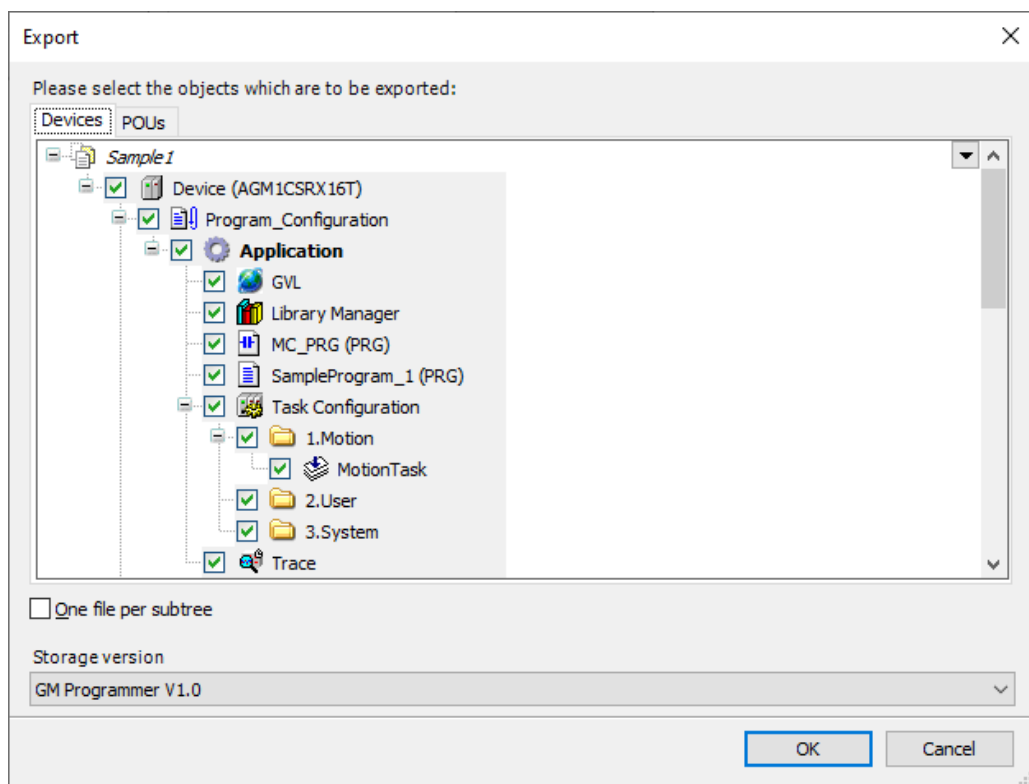

i Info.

- To import an object into GM Programmer, select only one object below the [Application] object and export it.
2. Select objects to be exported.
Normally, there is no need to make changes.
 3. Click the [OK] button.
The "Export" dialog box will be displayed.

4.5 Other project settings

If necessary, change the file name and save destination.

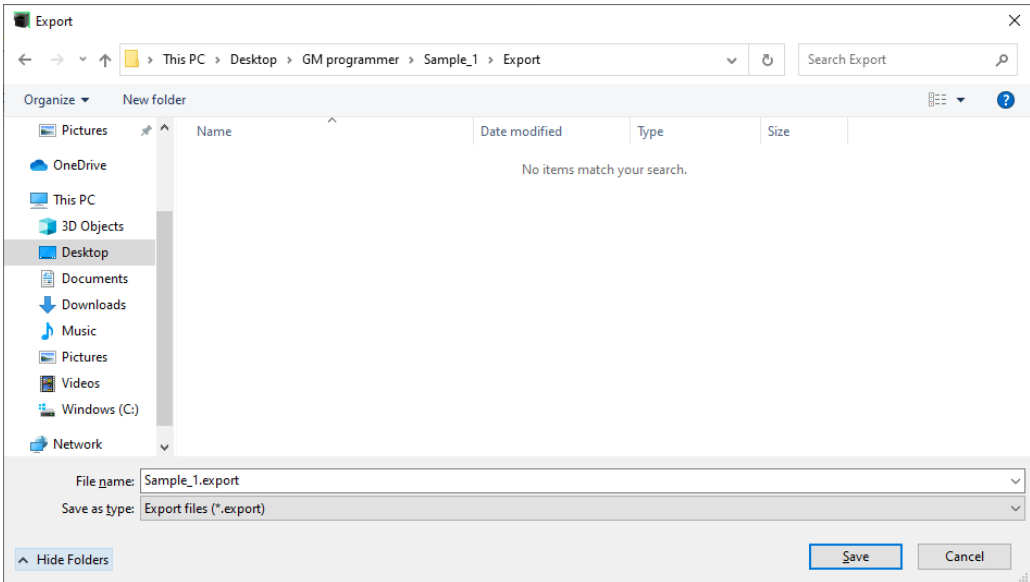

4. Click the [Save] button.
Export will be executed.

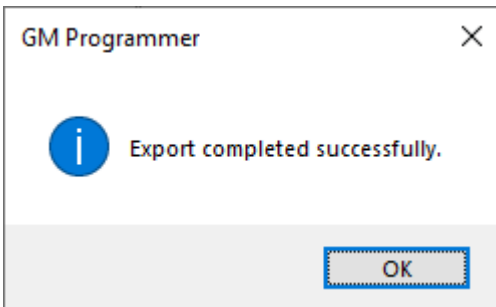

Importing Objects

This section explains the procedure for importing objects exported to a project into GM Programmer.

For example, use the following procedure to import objects below the "Application" object.

1 2 Procedure

1. Select the [Application] object in the navigator pane and then select **Project>Import** from the menu bar.

The "Import" dialog box will be displayed.

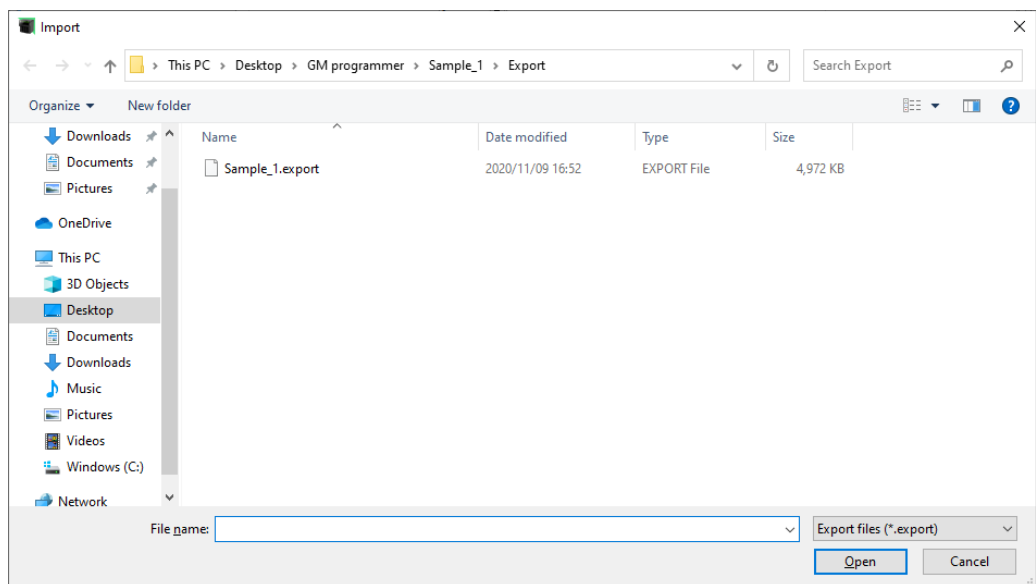

2. Select a file with extension ".export" and click the [Open] button.
The "Import" dialog box will be displayed.
Objects that can be imported will be displayed in the "Insertable items" area.

4.5 Other project settings

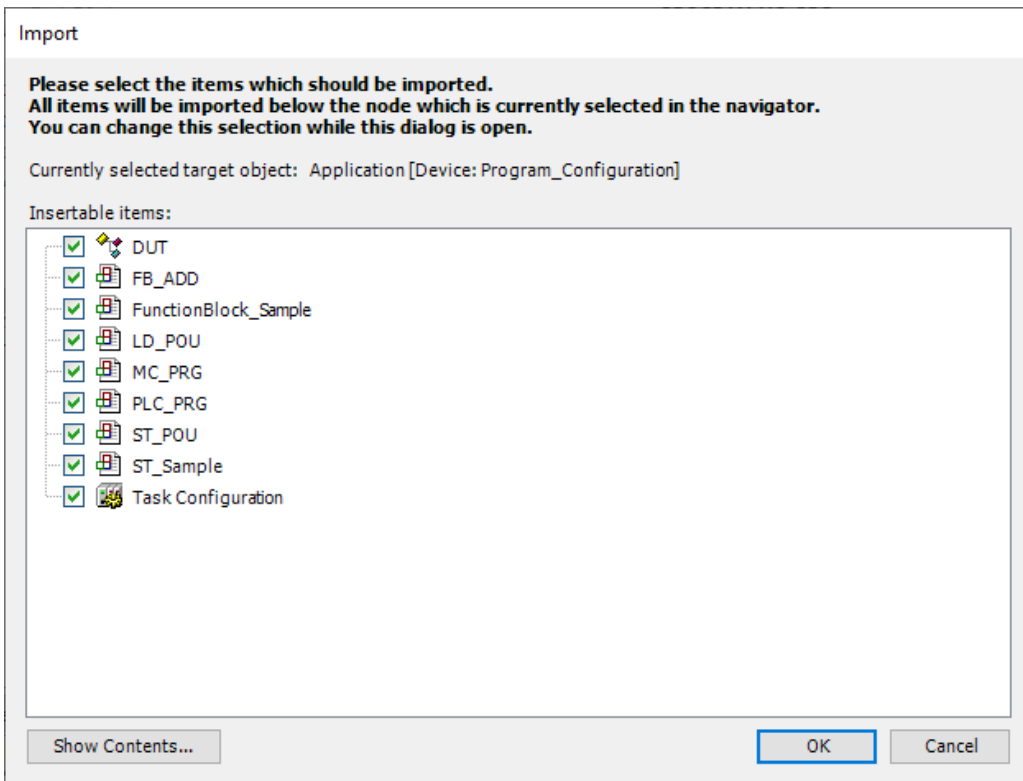

i Info.

- To import an object into GM Programmer, select an export file where only one object below the [Application] object is selected.
3. Clear the check boxes of the objects that do not need to be imported and click the [OK] button.
- Import will be executed.
- The objects that have been imported will be displayed below the [Application] object in the navigator pane.

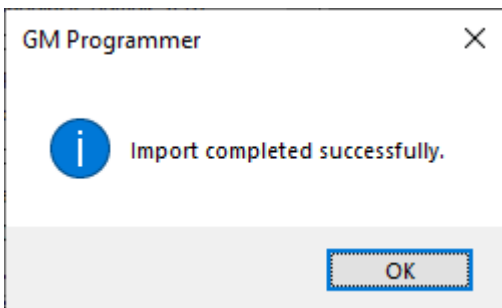

4.5.6 Project File Conversion

Converting Project File (.project) Version

Example: Converting the project version of a RTEX project file from 1.2.2.0 to 1.4.1.0

1 2 Procedure

1. Open a project file.
The "Project File Conversion" dialog box will be displayed.

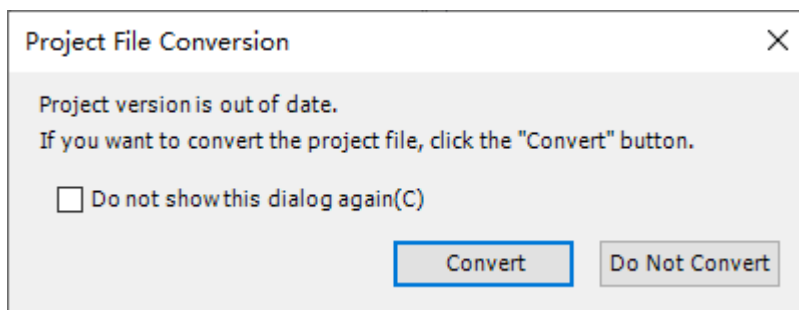

2. Click the [Convert] button.
The Project File Conversion dialog box will be displayed.
Confirm that the converted project version is shown at "Project version after conversion".

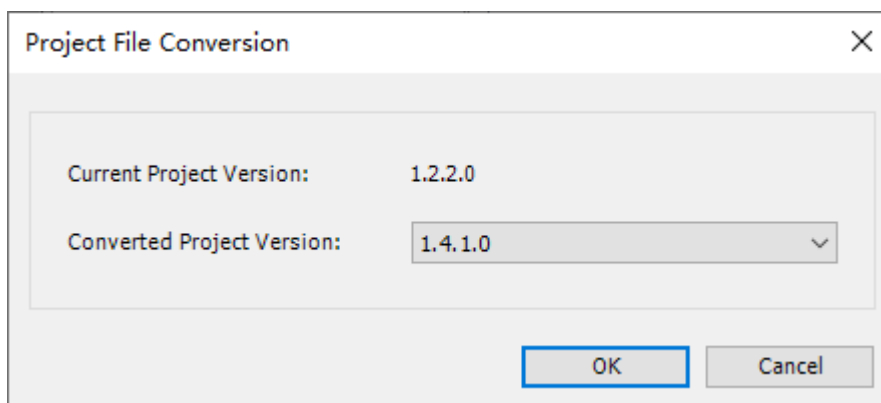

3. Click the [OK] button.
A confirmation dialog box will be displayed. Check the confirmation items about project file conversion.

4.5 Other project settings

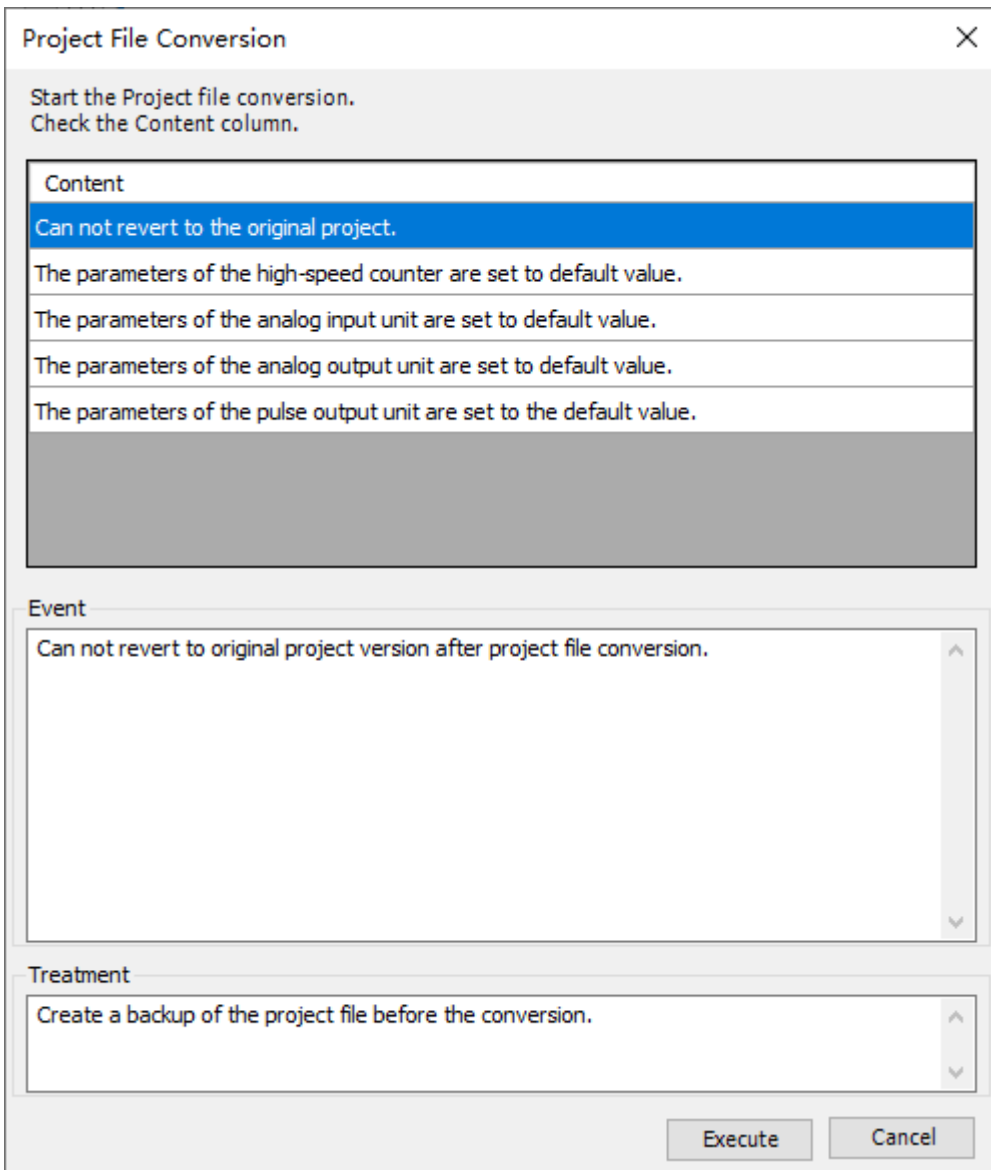

4. Click the [Execute] button.
Conversion of the project file starts.

i Info.

- The project version of project files cannot be converted to any project version older than the current project version before conversion.
- You can also convert the version of a project file by selecting Project > Project File Conversion from the menu bar.

Converting Library Project File (.library)

1 2 Procedure

1. Open a library project file.
The “Project File Conversion” dialog box will be displayed.

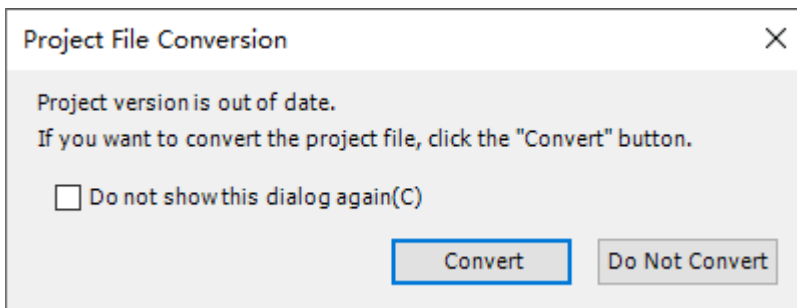

2. Click the [Convert] button.
The Project File Conversion dialog box will be displayed.
Confirm that the converted project version is shown at “Project version after conversion”.

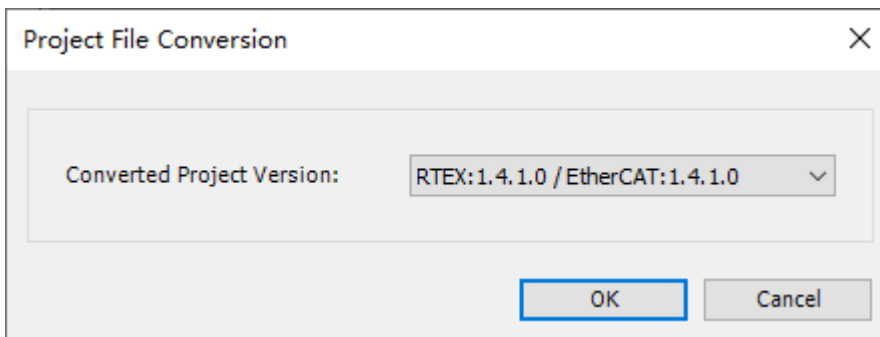

3. Click the [OK] button.
A confirmation dialog box will be displayed. Check the confirmation items about project file conversion.

4.5 Other project settings

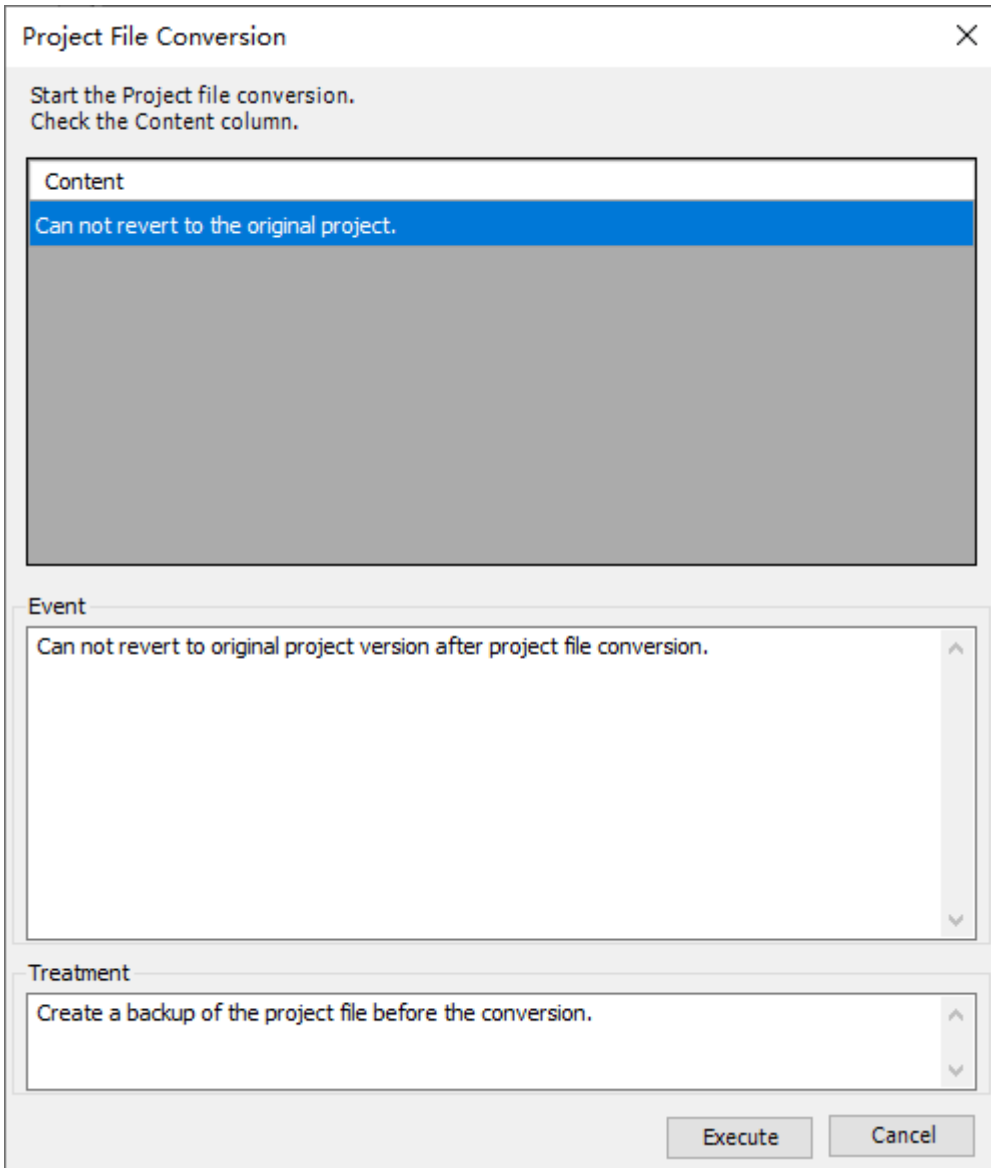

4. Click the [Execute] button.
Conversion of the project file starts.

i Info.

- The project version of project files cannot be converted to any project version older than the current project version before conversion.
- You can also convert the version of a project file by selecting Project > Project File Conversion from the menu bar.

4.5.7 Saving and unzipping the project archive

You can save project files and user libraries that have been added to the project together as a project archive file. You can extract the saved file in GM Programmer on another PC and edit the project file.

Project archive files have the extension “.projectarchive.”

Saving the project archive

1 2 Procedure

1. Select File → Project Archive → Save Archive from the menu bar.
The “Project Archive” dialog box appears.
2. Specify a file to save to the project archive.
Select the user libraries to add to the project archive, specify the files to add, and provide any comments that will be displayed during decompression.

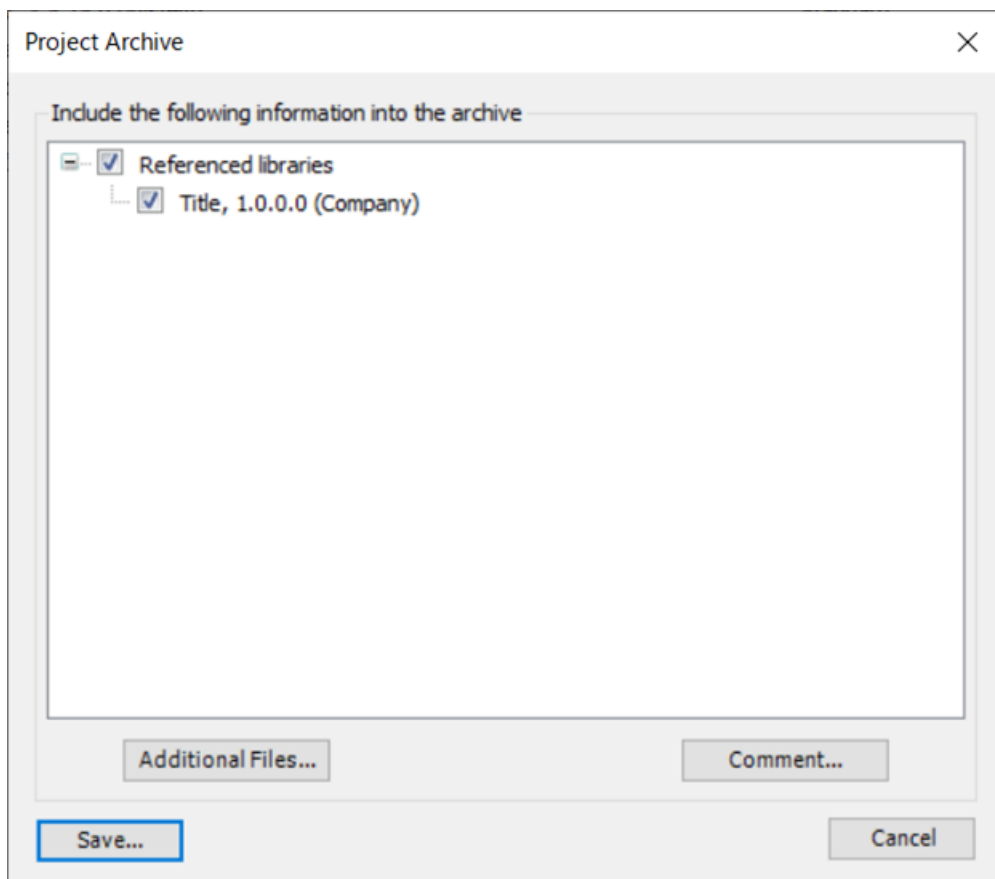

4.5 Other project settings

3. Click the [Save] button.
The “Save Project Archive” dialog box appears.
Specify a file name and save location, and then save.

Unzip Project Archive

1 2 Procedure

1. Select File → Project Archive → Extract Archive from the menu bar.
The “Extract Archive” dialog box appears.
2. Select the project archive file to unzip.
Once selected, the “Extract Project Archive” dialog box is displayed.
Specify the location to extract the project archive, select the user libraries to extract, and review the comments.
Click the [Advanced] button to display the “Advanced” dialog box where you can specify where to extract the added files.

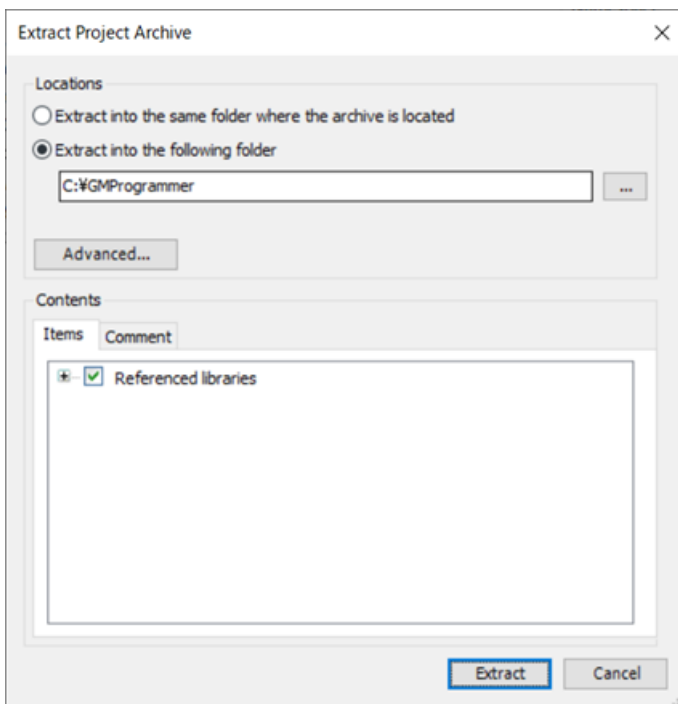

3. Click the [Extract] button.
The project files are extracted to the specified location.

(MEMO)

5 Program Creation

5.1	Flow of Program Creation	5-3
5.2	Program Creation Window	5-4
5.2.1	Main Pane	5-4
5.2.2	Declaration Editor	5-5
5.2.3	Auto Declaration	5-8
5.2.4	Toolbox	5-10
5.2.5	Setting up the Program Input Window	5-10
5.2.6	Window Operations for the Program Input Window	5-15
5.3	Creating a Program Object (POU Object).....	5-16
5.4	Types of Programming Language.....	5-17
5.5	Function and Function Block.....	5-20
5.5.1	Function	5-20
5.5.2	Function Block	5-24
5.6	User Library Function.....	5-27
5.6.1	Creating a Library and Adding to the Library Repository	5-28
5.6.2	Using Created Libraries	5-34
5.7	POU for implicit checks.....	5-36
5.7.1	Setting up POU for implicit checks.....	5-36
5.8	Tasks.....	5-38
5.8.1	Adding Programs	5-39
5.8.2	Adding a UserTask.....	5-43
5.8.3	Task Configuration Window	5-45
5.9	Build.....	5-47
5.9.1	Build	5-47
5.9.2	Rebuild	5-47
5.9.3	Code Generation.....	5-48
5.9.4	Clean.....	5-49
5.9.5	Clean All.....	5-50
5.10	Program Creation Support Functions	5-51
5.10.1	Bookmark.....	5-51
5.10.2	Call Tree View	5-52
5.10.3	Cross reference List View	5-53
5.10.4	Function Block Guidance	5-54
5.10.5	Short Form Function	5-58
5.10.6	Input Assistant Function.....	5-59
5.10.7	Argument / Variable Input Support (Component List)	5-60
5.10.8	Global Renaming (Refactoring)	5-61

5 Program Creation

5.10.9 Code Analysis (Static Analysis Light)	5-64
5.10.10 Displaying Programs in Multiple Languages (Project Localization).....	5-67
5.10.11 Start Instruction Help Function	5-71

5.1 Flow of Program Creation

1. Creating a POU object(refer to "5.3 Creating a Program Object (POU Object)")

Create an object (POU object) for the program.



2. Entering program data (refer to "6.1 Programming in Ladder Diagram (LD)" through to "6.7 Variables")

Open the POU object. Enter program data, declare variables, and perform other necessary work.



3. Executing build(refer to "5.9 Build")

- Execute build and check the program.
- If there are any errors, return to "Step 2" and correct the program.



4. Registering for a task (refer to "5.8 Tasks")

Register the POU objects (to be executed on the GM1 controller) for a task.

i Info.

- GM Programmer provides support functions that can be used to create programs efficiently. For details on support functions, refer to "5.10 Program Creation Support Functions".
- Programs consisting of functions and function blocks can be created. For details on functions and function blocks, refer to "5.5 Function and Function Block".

5.2 Program Creation Window

5.2 Program Creation Window

This section explains the window for creating programs in GM Programmer.

5.2.1 Main Pane

The upper section of the main pane is the declaration section where variables are declared.

The lower section of the main pane is the implementation section where program processes are coded. The declaration section and implementation section may be called the first and second panes, respectively.

The editing method in the implementation section differs according to the program. Refer to the section related to each program creation.

Example: Main pane for LD programs

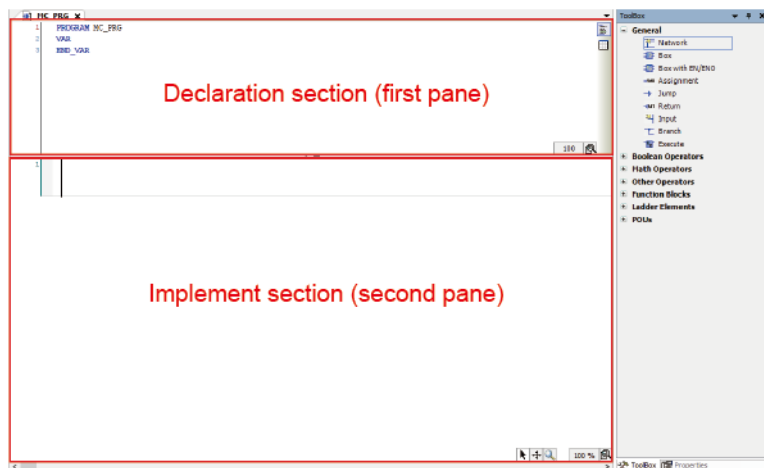

i Info.

- The selected pane can be switched between the declaration section (first pane) and the implementation section (second pane). To switch the selected pane, from the menu bar, select **Window>Next Pane** or "Previous Pane".
- You can also hide the declaration section (first pane) or the implementation section (second pane).
To hide the declaration section, from the menu bar, select **Window>Switch First Pane**.
To hide the implementation section, from the menu bar, select **Window>Switch Second Pane**.
- When the cursor stays in a variable position in the implementation section, the cursor can be moved to the declaration position of the variable by selecting **Edit>Browse>Go To Definition**.
- You can also declare variables of user-defined types such as structure. User-defined types must be defined in DUT objects beforehand. For details, refer to "[6.7.6 Structure, Enumeration, Alias, and Union Data Types](#)".

5.2.2 Declaration Editor

The declaration editor is used to declare variables.

The display format of declarations is divided into table format and text format. The table format and text format can be switched using the switching button on the top right of the declaration editor.

■ Table format

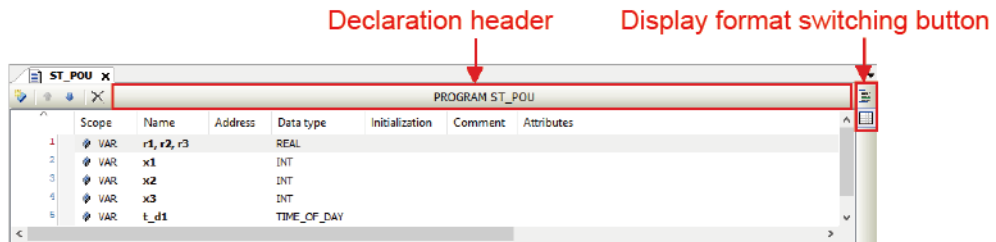

- To add a new declaration, click the [+] icon ("Insert") to add a new row. Enter a variable name in the "Name" column. For other items, double-click each cell to set the cell in an input-enabled state, and enter values as necessary.
- To sort variables, use the [↑ ↓] icon ("Move up" or "Move down").
- To delete variables, use the [X] icon ("Delete").
- When adding a program name or program name comment, click the declaration header section.

The "Edit Declaration Header" dialog box will be displayed.

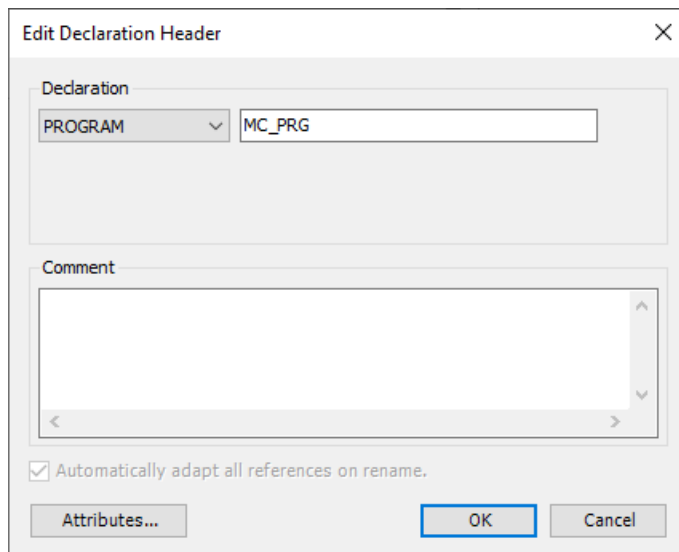

5.2 Program Creation Window

■ Text format

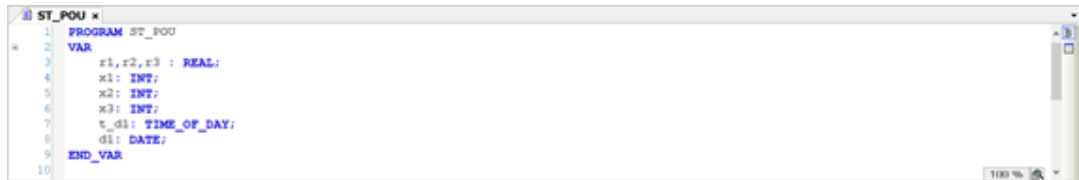

```
1 PROGRAM ST_POU
2
3 VAR
4   x1, x2, x3 : REAL;
5   x1: INT;
6   x2: INT;
7   x3: INT;
8   t_d1: TIME_OF_DAY;
9   d1: DATE;
10 END_VAR
```

- As is the case with the text editor, enter variables to be declared.
- You can use single-line comments (prefixed with //) and multiple-line comments (enclosed with *).
- Pressing the "F2" key starts Input Assistant, which allows the user to enter variable types and other items by selecting them. For details on Input Assistant, refer to ["5.10.6 Input Assistant Function"](#).

i Info.

- You can set the display format to be used, as below.
 1. From the menu bar, select **Tools>Options**.
The "Options" dialog box will be displayed.

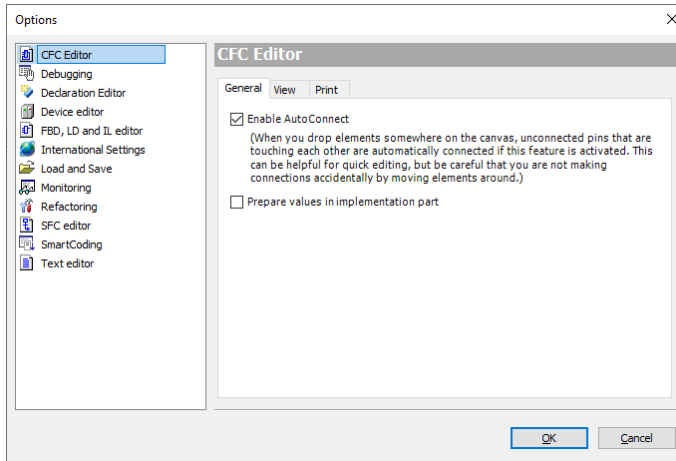

2. In the Options dialog box, select the "Declaration Editor" category.

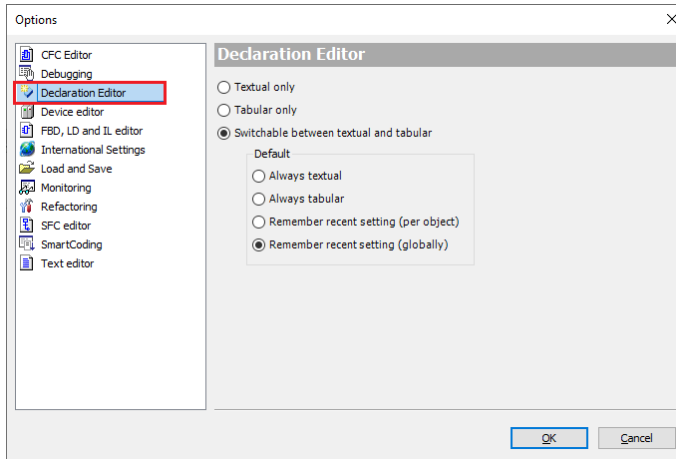

3. Select a desired display format.

5.2 Program Creation Window

5.2.3 Auto Declaration

If a variable that has not been declared in the declaration section is entered in the implementation section, the "Auto Declare" dialog box will be displayed.

If you change any necessary items and click the [OK] button, the variable will be declared in the declaration section.

Example: When the variable name of a contact is entered as bVar0 in an LD program

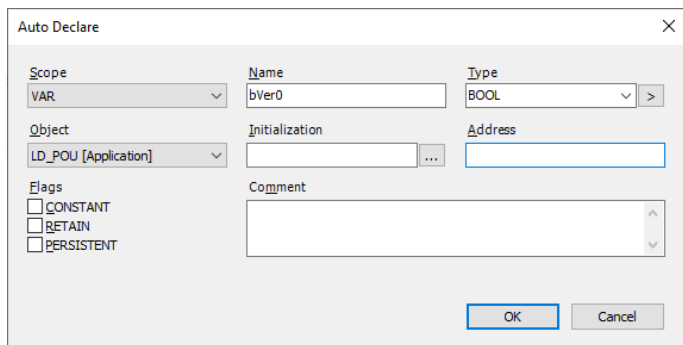

■ Address

In the Address field, you can specify the address of input data or output data for the GM1 controller or expansion unit. In such a case, the variable assigned to the input data or output data corresponding to the entered address is declared.

■ Flag

If you select the CONSTANT, RETAIN, and PERSISTENT check boxes in the Flag section, you can set variable attributes.

CONSTANT

Declares the variable as a constant. Enter a default value.

RETAIN

Declares the variable as a retain variable. For retain variables, values are not reset even if warm reset is performed. For details on warm reset, refer to ["8.8.1 Reset Warm, Reset Cold, and Reset Origin"](#).

PERSISTENT

Declares the variable as a persistent variable. To declare a persistent variable, you must also select the RETAIN check box. For persistent variables, values are not reset even if cold reset or warm reset is performed. For details on cold reset or warm reset, refer to ["8.8.1 Reset Warm, Reset Cold, and Reset Origin"](#).

i Info.

- You can also prevent the "Auto Declare" dialog box from being displayed when a variable that has not been declared is entered in the implementation section. From the menu bar, select **Tools>Options>SmartCoding** category and clear the "Declare unknown variables automatically (AutoDeclare)" check box.

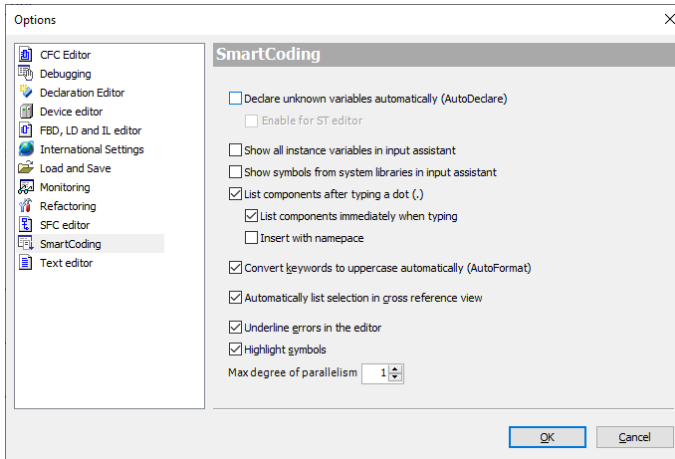

- Using the Array Wizard, you can declare an array only by entering an index and base type. Click  on the right side of the Type field and select "Array Wizard".

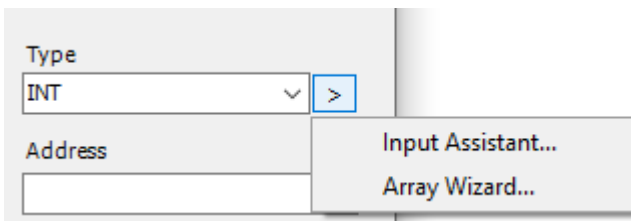

5.2 Program Creation Window

5.2.4 Toolbox

Programs can be created by dragging the programming elements displayed in the toolbox. For programs other than ST programs, programming elements are displayed in the toolbox.

For details on how to create programs, refer to the section related to each program creation.

Example: Toolbox for LD programs

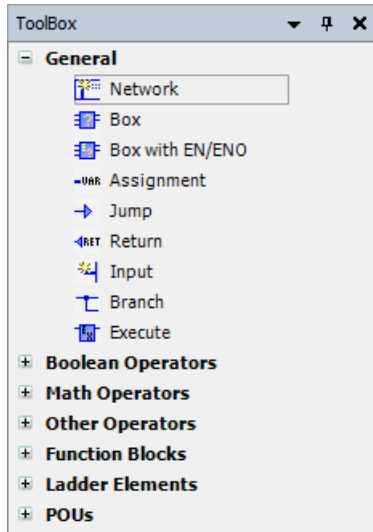

5.2.5 Setting up the Program Input Window

You can change settings related to the text editor.

From the menu bar, select **Tools>Options** to open the "Options" dialog box.

In the "Options" dialog box, select the "Text editor" category and change the settings.

Theme

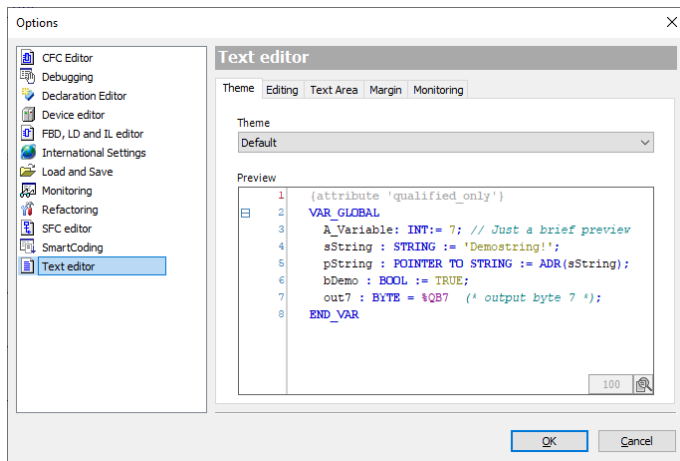

Item name	Default value	Settings
Theme	Default	Sets a color scheme theme for the text editor Default / Dark

Edit

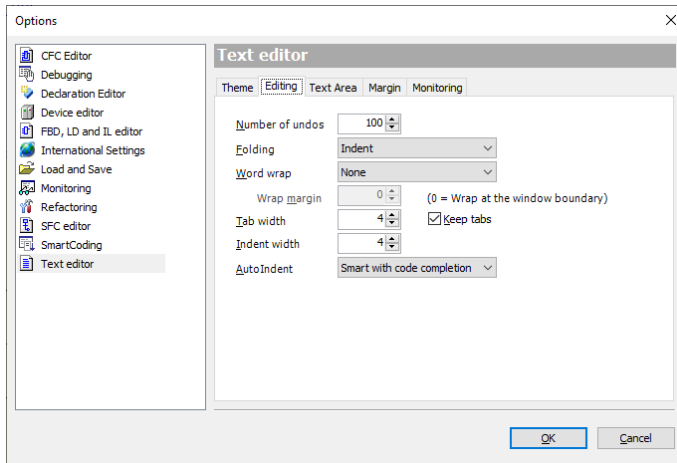

Item name	Default value	Settings
Number of undos	100	Sets the maximum number of times [Edit] - [Undo] can be executed from the menu bar Setting range: 1 to 1000 (times)
Folding	Indent	Specifies the method for defining the code structure None: Does not collapse code Indent: Combines all lines indented from the previous line as a unit Explicit: Explicitly marks a unit of code sections as a comment
Word wrap	None	Sets a rule for wrapping entered text automatically None: Does not collapse code Soft: If the number of characters entered in a single line exceeds the value specified in "Wrap margin", a code continuation mark (:) will be added and a line break will be inserted automatically. If "0" is selected in the "Wrap margin" drop-down list, a line break will be inserted at the right edge of the editor window. Hard: If the number of characters entered in a single line exceeds the value specified in "Wrap margin", a line break will be inserted automatically. However, a code continuation mark (":") will not be added. If the number of initially entered word characters exceeds the value specified in "Wrap margin", a line break will not be inserted.
Wrap margin	0	Specifies the number of characters per line that triggers a line feed

5.2 Program Creation Window

Item name	Default value	Settings
		Setting range: 0 to 240
Tab width	4	Specifies the number of space characters equivalent to the code to be inserted when the Tab key is pressed Setting range: 1 to 16
Keep tabs	Selected	Specifies whether to insert space characters or a tab character when the Tab key is pressed Selected: Inserts a tab character when the Tab key is pressed Cleared: Inserts space characters when the Tab key is pressed
Indent width	4	Inserts tab spaces with the specified width when "Auto" or "Auto coding" is selected from the "Auto indent" drop-down list. However, if the "Keep tabs" check box is cleared, space characters will be inserted. Setting range: 1 to 16
Auto Indent	Smart with code completion	Specifies the behavior to be performed when auto indentation is performed None: Does not insert indentation automatically Block: Inserts indentation with the same width as that of the previous line at the time of line feed Auto: Inserts indentation automatically for lines following a line containing keywords (such as VAR) according to the setting of "Indent width" Smart with code completion: Inserts applicable keywords such as "END_IF" and "END_VAR" automatically, in addition to the behavior performed by "Auto"

Text Area

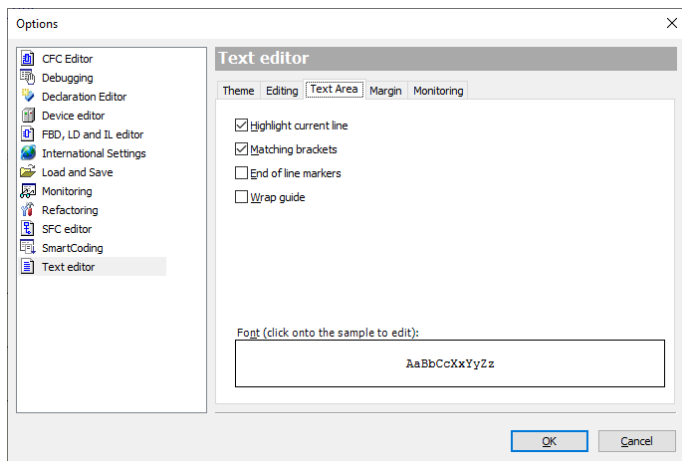

Item name	Default value	Settings
Highlight current line	Selected	Highlights the line selected by the cursor Selected / Cleared

Item name	Default value	Settings
Matching brackets	Selected	Highlights the corresponding bracket when the cursor is positioned at a bracket within code Selected / Cleared
End of line markers	Cleared	Indicates the end of a line as a small dash mark (".") with the color specified for the theme Selected / Cleared
Wrap guide	Cleared	Displays a guide as the vertical line specified for the theme, in the column used as the base of wrapping. If any value other than "0" is specified in "Wrap margin", a guide will be displayed. Selected / Cleared
Font	-	Displays a font dialog box for setting fonts.

Margin

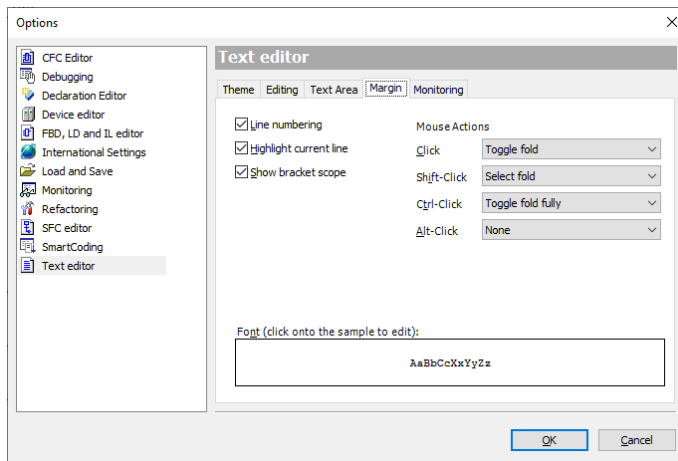

Item name	Default value	Settings
Line numbering	Selected	Displays line numbers in the variable declaration section and program implementation section
Highlight current line	Selected	Selected: Displays line numbers Cleared: Does not display line numbers Highlights the line selected by the cursor by changing the color of the line number. If the "Line numbering" check box is cleared, the current line will not be highlighted. Selected: Highlights the current line by changing the color of the line number Cleared: Does not change the color of the line number
Show bracket scope	Selected	Displays a scope in the space on the left side of the line number to indicate the beginning to the end of a keyword (such as "IF" to "END_IF") Selected: Displays a scope Cleared: Does not display a scope

5.2 Program Creation Window

Item name	Default value	Settings
Mouse Actions	-	<p>Assigns a mouse action to be performed when "+" or "-" in a space is clicked</p> <p>None: Assigns no mouse action</p> <p>Select fold: Selects all lines within the area enclosed in brackets</p> <p>Toggle fold: Expands or folds the area enclosed in brackets</p> <p>Toggle fold fully: Expands or folds all nested areas when areas are nested</p>
Font	-	Displays a "Font" dialog box for setting fonts

Monitoring

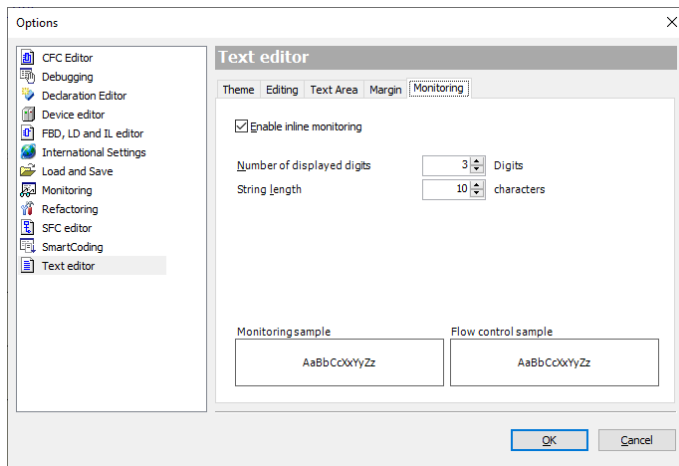

Item name	Default value	Settings
Enable inline monitoring	Selected	<p>Displays a monitoring field in the program implementation section in online mode</p> <p>Selected: Displays a monitoring field</p> <p>Cleared: Does not display a monitoring field</p>
Number of displayed digits	3	<p>Sets the number of digits after the decimal point that are displayed in the monitoring field</p> <p>Setting range: 1 to 20</p>
String length	10	<p>Sets the maximum length of string variables in the monitoring field</p> <p>Setting range: 1 to 80</p>

5.2.6 Window Operations for the Program Input Window

You can perform window operations such as increasing the display size in the program input window.

The window operation icons are displayed in the bottom right corner of the window.

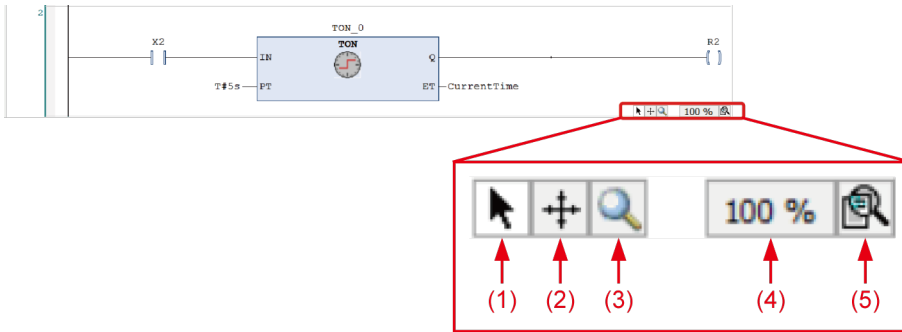

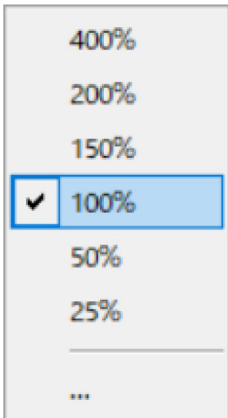
Number	Item	Description
(1)	Normal mode	This mode allows the user to select a component by clicking it.
(2)	Move mode	This mode allows the user to moves the window by clicking in the window and then dragging the mouse.
(3)	Enlarged view tool	Clicking the icon opens the enlarged view tool window. The display at the cursor position is enlarged in the window.
(4)	Current display size	This section indicates the current display size of the program input window
(5)	Change display size	<p>This icon is used to change the display size. Clicking the icon displays a menu. Select a desired size.</p>  <p>Selecting "..." displays the "Enlarge" dialog box where you can enter a magnification rate.</p>

5.3 Creating a Program Object (POU Object)

5.3 Creating a Program Object (POU Object)

■ Creating programs

Programs are created within POU objects. A single POU object allows the use of only one program. If you want to use different programs within a project, you must add POU objects.

■ Adding POU objects

To add POU objects, right-click the [Application] object in the navigator pane and then select **Add Object>POU** from the context-sensitive menu that is displayed.

For details, refer to "4.4 Adding Objects".

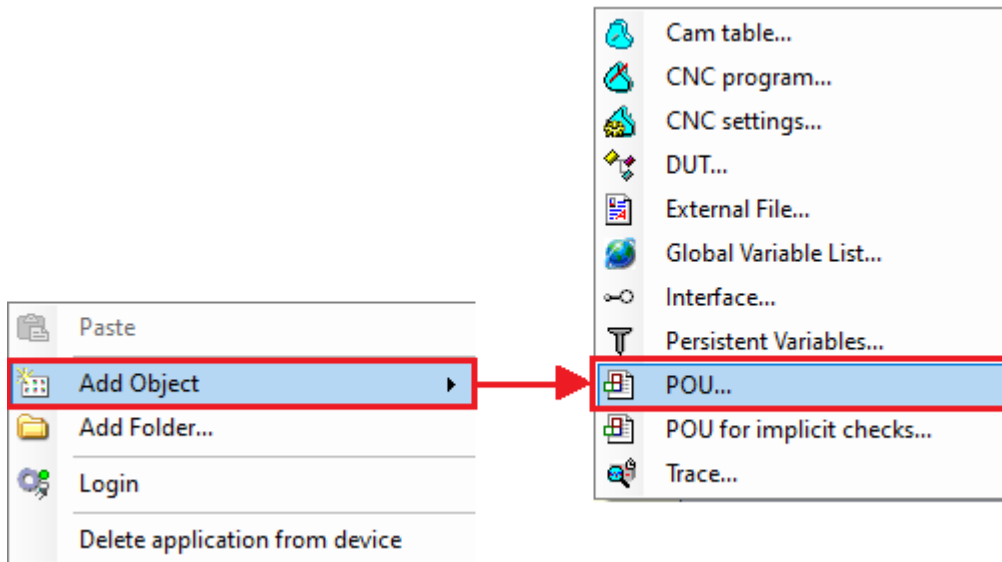

5.4 Types of Programming Language

GM Programmer supports five programming languages that comply with IEC 61131-3, the international standard for PLC programming languages.

i Info.

- Continuous Function Chart (CFC) and Page-Oriented CFC are not included in the five programming languages compliant with IEC 61131-3. However, the third edition of IEC 61131-3 defines them as object-oriented programming languages.

■ Ladder Diagram program (LD program)

Ladder Diagram is a graphical programming language used to create a program by arranging ladder logic elements such as contacts and coils on a network (circuit). It also allows the use of functions and function blocks with various functions.

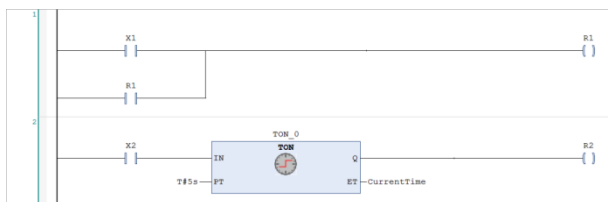

■ Structured Text program (ST program)

Structured Text is a programming language that creates expressions, conditional statements, and other program elements in text format. It is based on the Pascal programming language and suitable for numerical calculation, data processing, and processing such as conditional branch and repetitive processing.

```

1  x1 := i1 + 1;
2  x2 := i2 + 2;
3  x3 := i3 - 1;
4  ADD_3(x1, x2, x3);
5  CASE x1 OF
6      1: x2 := 44;
7      2: x2 := 55;
8      3: x2 := 66;
9  ELSE x2 := 77;
10 END_CASE
11 IF (x2 = 66) THEN
12     x3 := 88;
13     ELSIF (x2 = 77) THEN
14         x3 := 99;
15 END_IF
16 b1 S= b2;

```

5.4 Types of Programming Language

■ Sequential Function Chart program (SFC program)

Sequential Function Chart is a graphical programming language used to create a program by arranging steps, transitions, actions, and other elements sequentially from top to bottom. It is suitable for processing that describes state transitions.

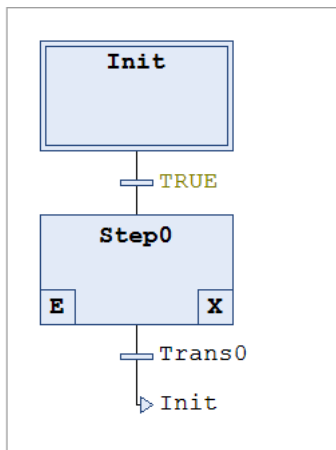

■ Function Block Diagram program (FBD program)

Function Block Diagram is a graphical programming language used to create a program by arranging functions and function blocks on a network (circuit). Unlike Ladder Diagram programs, contacts, coils and other ladder logic elements cannot be arranged in Function Block Diagram programs.

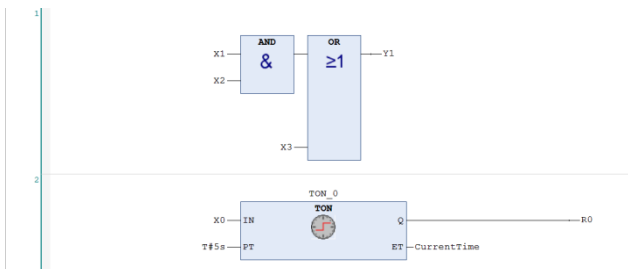

In addition to the five programming languages compliant with IEC 61131-3, Continuous Function Chart (CFC) and Page-Oriented CFC can also be used.

■ Instruction List program (IL program)

Instruction List is a programming language that creates assembler-like instructions sequentially in text format. This language is suitable when you want to perform high-speed processing, restrict the memory usage, and perform other similar operations.

1	LD	iVar	
	ADD	3	
	ST	iResult	
	LD	bVar1	
	JMPC	mark1	
2	mark1:		
	LD	bVar2	
	S	bVar3	

In addition to the five programming languages compliant with IEC 61131-3, Continuous Function Chart (CFC) and Page-Oriented CFC can also be used.

■ Continuous Function Chart (CFC) and Page-Oriented CFC programs

Continuous Function Chart (CFC) and Page-Oriented CFC are graphical programming languages used to create a program by arranging function blocks and other elements on the screen. Elements can be freely arranged on the screen and the order of execution can be specified.

CFC allows the user to create a program on a single screen, while Page-Oriented CFC allows the user to create a program while switching the screen called a page.

<CFC program>

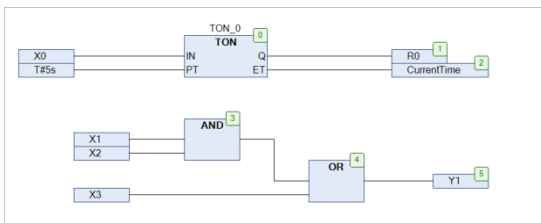

<Page-Oriented CFC program>

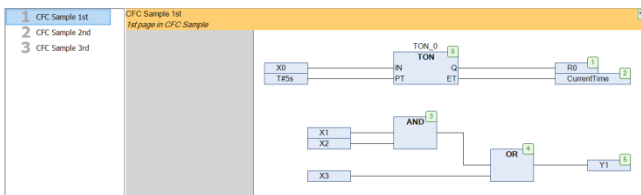

5.5 Function and Function Block

5.5 Function and Function Block

Functions and function blocks can be invoked from programs. Functions and function blocks can be created with POU objects.

The differences between functions and function blocks are as below.

■ Function (FUN)

- Functions can be used without being declared in the declaration section.
- Only one output is generated. However, additional outputs can be defined.
- Output variable and internal variable values are not saved.

■ Function block (FB)

- Function blocks can be used by declaring instances in the declaration section.
- Multiple outputs can be generated.
- Output variable and internal variable values are saved.
- Object-oriented definitions can be made by using EXTENDS (inheritance), IMPLEMENTS (interface implementation), or access qualifiers.

5.5.1 Function

A function generates one output in response to one or more inputs. Functions can be used without declaring variables.

For example, use the following procedure to create and invoke function "ADD_SUB", which uses three INT type arguments as inputs, calculates (first argument) + (second argument) - (third argument), and output the result.

1 2 Procedure

1. Right-click the [Application] object in the navigator pane and then select **Add Object>POU** from the context-sensitive menu that is displayed.

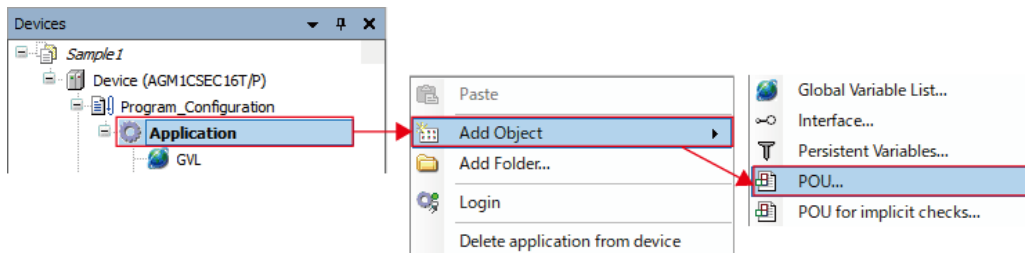

The "Add POU" dialog box will be displayed.

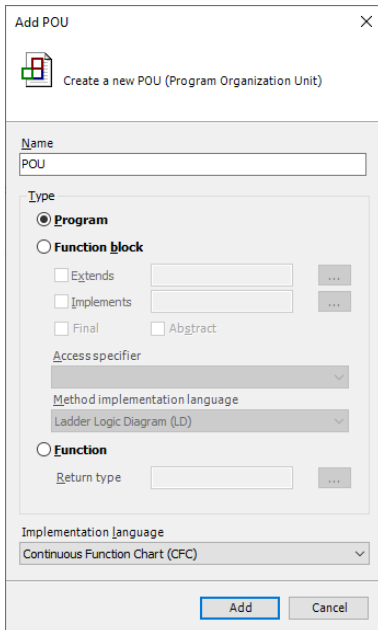

Add POU

Create a new POU (Program Organization Unit)

Name
POU

Type

Program

Function block

Extends Implements Final Abstract

Access specifier

Method implementation language
Ladder Logic Diagram (LD)

Function

Return type

Implementation language
Continuous Function Chart (CFC)

Add Cancel

2. Select the "Function" radio button, enter appropriate values in the Name and Return type fields, and select an appropriate programming language from the Implementation Language drop-down list.

In the Name field, specify a function name. In the Return type field, select a return value to be output when the function is executed. From the Implementation Language drop-down list, select a programming language that is used to code function processing.

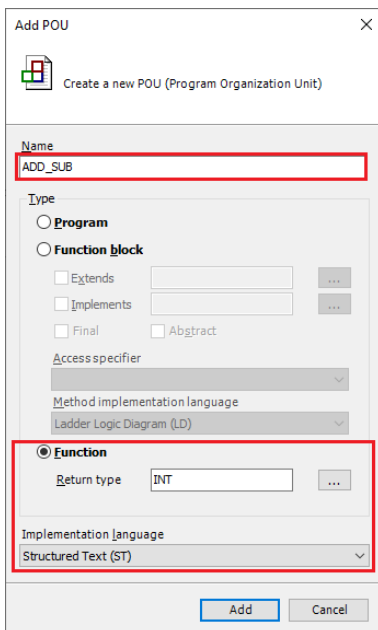

Add POU

Create a new POU (Program Organization Unit)

Name
ADD_SUB

Type

Program

Function block

Extends Implements Final Abstract

Access specifier

Method implementation language
Ladder Logic Diagram (LD)

Function

Return type
INT

Implementation language
Structured Text (ST)

Add Cancel

3. Click the [Add] button.
A POU object of the function will be added.

5.5 Function and Function Block

The POU object is displayed as "function-name (FUN)" in the navigator pane.

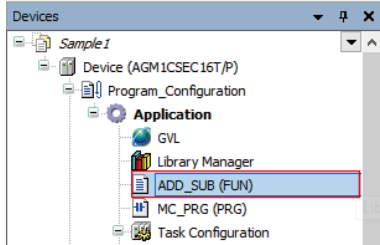

4. Enter function processing.
Open the POU object of the function and create a function.
In "VAR_INPUT", declare input variables for the function.
Substitute function output for the variable of the function name.



This completes the function creation procedure.
Next, the procedure for invoking the created function is explained below.

5. Open the POU object from which the function is to be invoked, and invoke the function.
The function can be invoked by using its name. To invoke the function, there is no need to declare variables.

Example: Invoking the function from LD program

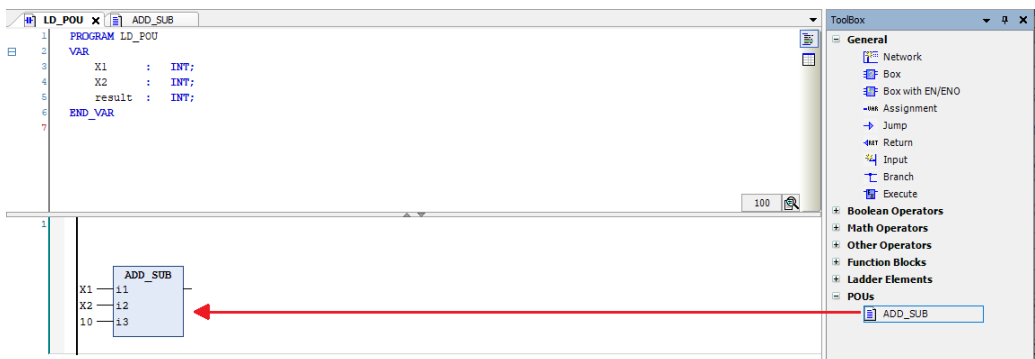

Example: Invoking the function from ST program

```

1  ADD_SUB    ST_POU x
2  PROGRAM ST_POU
3  VAR
4  X1      : INT;
5  X2      : INT;
6  result  : INT;
7  END_VAR
8
9  result  := ADD_SUB(X1,X2,10);
10

```

i Info.

- Additional outputs can be defined for the function. Declare an additional output as variable "VAR_OUTPUT" in the declaration section of the POU object that defines the function.

Example: Definition of function "ADD_SUB" to which variable iOut that outputs the sum of three input variables is added

```

1  ADD_SUB x
2  VAR_INPUT
3  i1 : INT;
4  i2 : INT;
5  i3 : INT;
6  END_VAR
7  VAR_OUTPUT
8  o1 : INT;
9  END_VAR
10 VAR
11 END_VAR
12
13
14
15
16
17
18
19
20
21
22
23
24
25
26
27
28
29
30
31
32
33
34
35
36
37
38
39
40
41
42
43
44
45
46
47
48
49
50
51
52
53
54
55
56
57
58
59
60
61
62
63
64
65
66
67
68
69
70
71
72
73
74
75
76
77
78
79
80
81
82
83
84
85
86
87
88
89
90
91
92
93
94
95
96
97
98
99
100
101
102
103
104
105
106
107
108
109
110
111
112
113
114
115
116
117
118
119
120
121
122
123
124
125
126
127
128
129
130
131
132
133
134
135
136
137
138
139
140
141
142
143
144
145
146
147
148
149
150
151
152
153
154
155
156
157
158
159
160
161
162
163
164
165
166
167
168
169
170
171
172
173
174
175
176
177
178
179
180
181
182
183
184
185
186
187
188
189
190
191
192
193
194
195
196
197
198
199
200

```

Invoking function "ADD_SUB" from LD program



Invoking function "ADD_SUB" from ST program

```

1  ADD_SUB    ST_POU x
2  PROGRAM ST_POU
3  VAR
4  X1      : INT;
5  X2      : INT;
6  result  : INT;
7  X3      : INT;
8  END_VAR
9
10 result  := ADD_SUB(X1,X2,10,o1 => X3);
11

```

5.5 Function and Function Block

5.5.2 Function Block

A function block generates one or more outputs in response to one or more inputs. To use function blocks, variables (instances) must be declared.

For example, use the following procedure to create function block "FB_ADD", which uses three INT type variables as inputs and outputs the sum of three arguments, and to invoke an instance.

1 2 Procedure

1. Right-click the [Application] object in the navigator pane and then select **Add Object>POU** from the context-sensitive menu that is displayed.

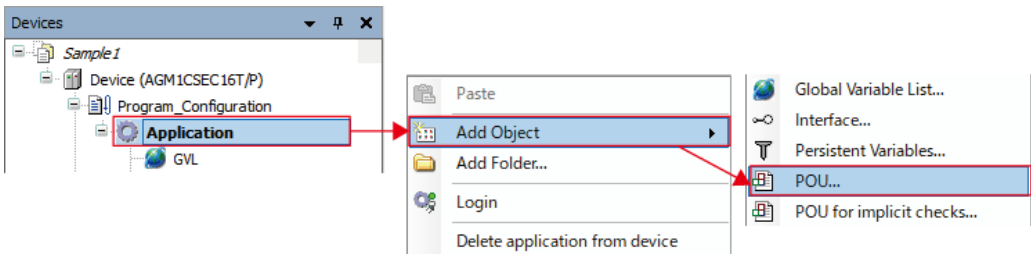

The "Add POU" dialog box will be displayed.

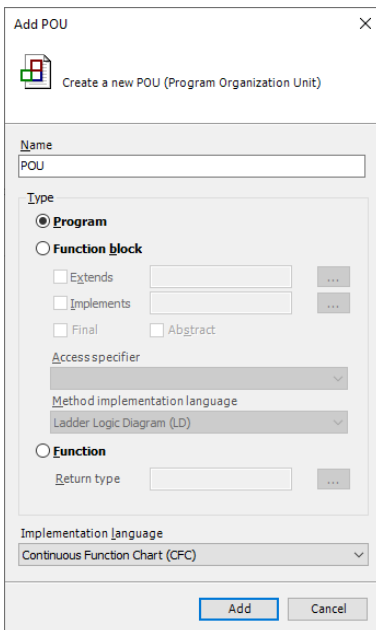

2. Select the "Function block" radio button, enter a name in the Name field, and select a programming language from the Implementation Language drop-down list.
In the Name field, specify a function block name. In the Implementation Language drop-down list, select a programming language that is used to code function block processing.

Add POU

Create a new POU (Program Organization Unit)

Name
FB_ADD

Type

Program

Function block

Extends ...

Implements ...

Final Abstract

Access specifier
...

Method implementation language
Structured Text (ST)

Function

Return type INT ...

Implementation language
Structured Text (ST)

Add Cancel

- Click the [Add] button.
A POU object of the function block will be added.
The POU object is displayed as "function-block-name (FB)" in the navigator pane.

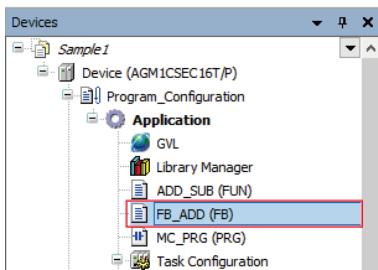

- Enter function block processing.
Open the POU object of the function block and create a function block.
In "VAR_INPUT", declare input variables to the function block.
In "VAR_OUTPUT", declare output variables from the function block.

```

1  FUNCTION_BLOCK FB_ADD
2  VAR_INPUT
3      i1 : INT;
4      i2 : INT;
5      i3 : INT;
6  END_VAR
7  VAR_OUTPUT
8      o1 : INT;
9  END_VAR
10 VAR
11 END_VAR
12
13 o1 := i1 + i2 + i3;

```

- This completes the function block creation procedure.
Next, the procedure for invoking the created function block is explained below.

5.5 Function and Function Block

5. Open the POU object from which the function block is to be invoked, and declare an instance of the function block in the declaration section.
Declare an instance that is a copy of the function block.
Declare an instance name in the form of "instance-name: function-block-name".



```
1 PROGRAM ST_POU
2 VAR
3   FB_inst : FB_ADD;
4   result : INT;
5 END_VAR
```

6. Invoke the instance of the function block.
Invoking the instance of the function block executes the processing defined with the function block. Input variables and output variables can be accessed by specifying "instance.variable-name".

Example: Invoking the instance from LD program



```
1 PROGRAM LD_POU
2 VAR
3   FB_inst : FB_ADD;
4   result : INT;
5 END_VAR
```

The screenshot shows a ladder logic diagram with a normally open contact labeled '10' and a coil labeled 'FB_inst'. A red arrow points from the 'FB_inst' coil to the 'FB_ADD' function block icon in the Toolbox on the right.

Example: Invoking the instance from ST program

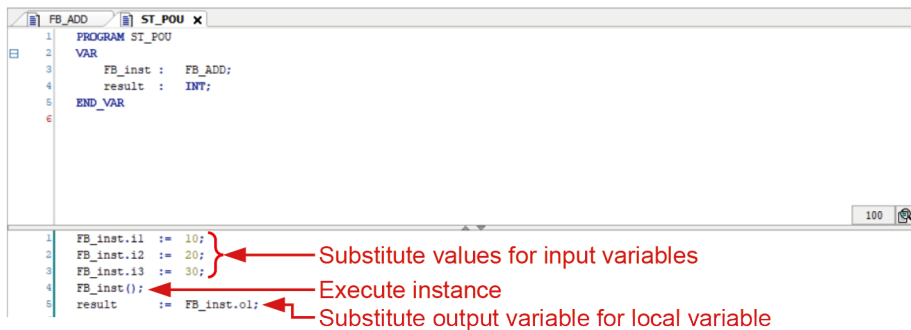

```
1 PROGRAM ST_POU
2 VAR
3   FB_inst : FB_ADD;
4   result : INT;
5 END_VAR
```

The screenshot shows the following ST code with red annotations:

```
1 FB_inst.i1 := 10;
2 FB_inst.i2 := 20;
3 FB_inst.i3 := 30;
4 FB_inst();
5 result := FB_inst.o1;
```

- Substitute values for input variables (lines 1-3)
- Execute instance (line 4)
- Substitute output variable for local variable (line 5)

5.6 User Library Function

Combining created functions and function blocks as a library enables other projects to use these functions and function blocks.

The library that has been created must be installed in the library repository. Adding the library installed in the library repository to the project makes it possible to use the functions and function blocks in the library. Libraries in the project are managed by the "Library_Manager" object.

The following sections describe a procedure for creating a library, installing the created library into the library repository, and adding libraries to a project.

Example

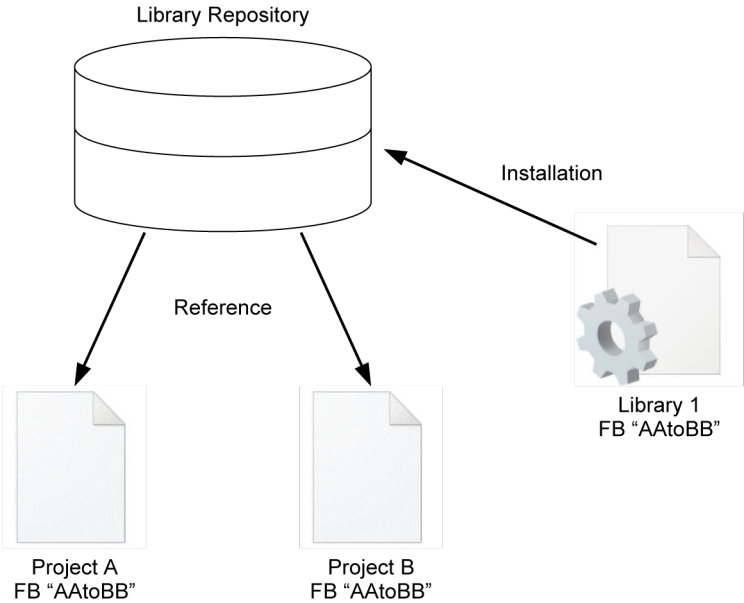

5.6 User Library Function

5.6.1 Creating a Library and Adding to the Library Repository

This section explains the entire procedure from creating a project for libraries through to installing libraries in the library repository.

1 2 Procedure

1. From the menu bar, select **File>New Project**.
The "New Project" dialog box will be displayed.

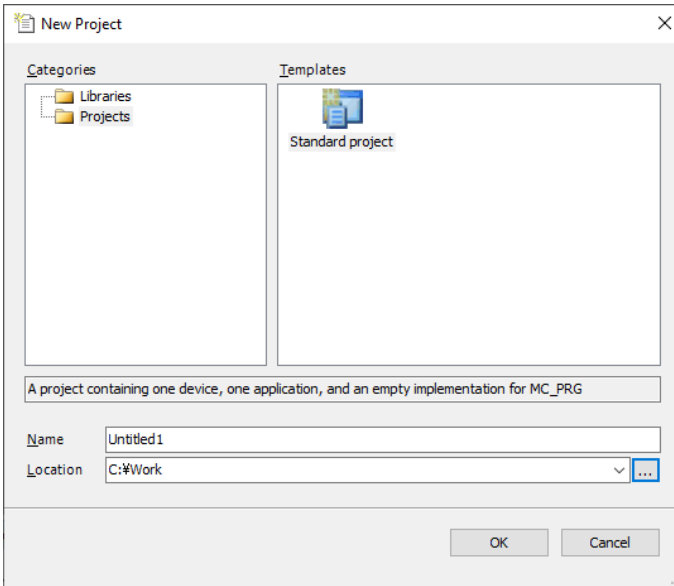

2. Select "Libraries" in the Categories pane and then "Standard library" in the Template pane.

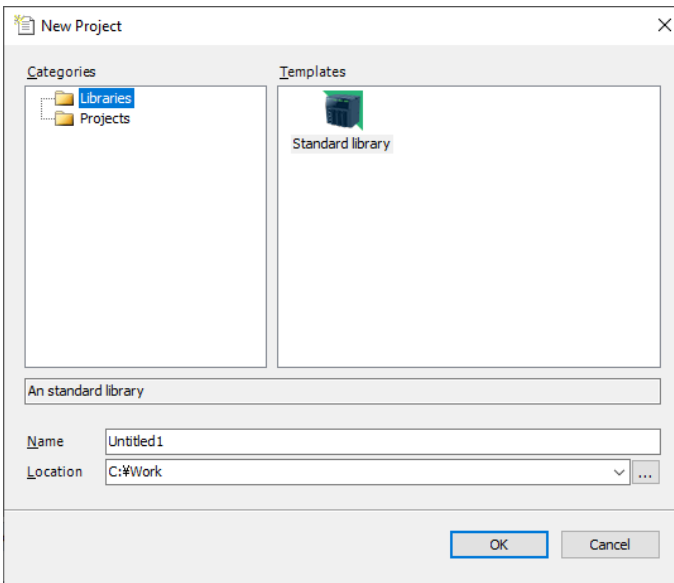

- Click the [OK] button.
The "Standard library" dialog box will be displayed.

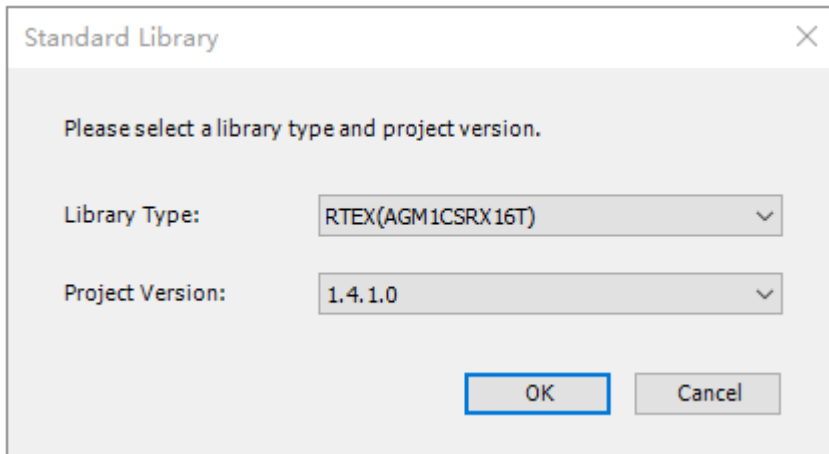

- Click the [OK] button.
A project for libraries will be created. The extension of project files for libraries is "library". For libraries, the POU view is displayed in the navigator pane. Add objects required for creating libraries to the POU view.

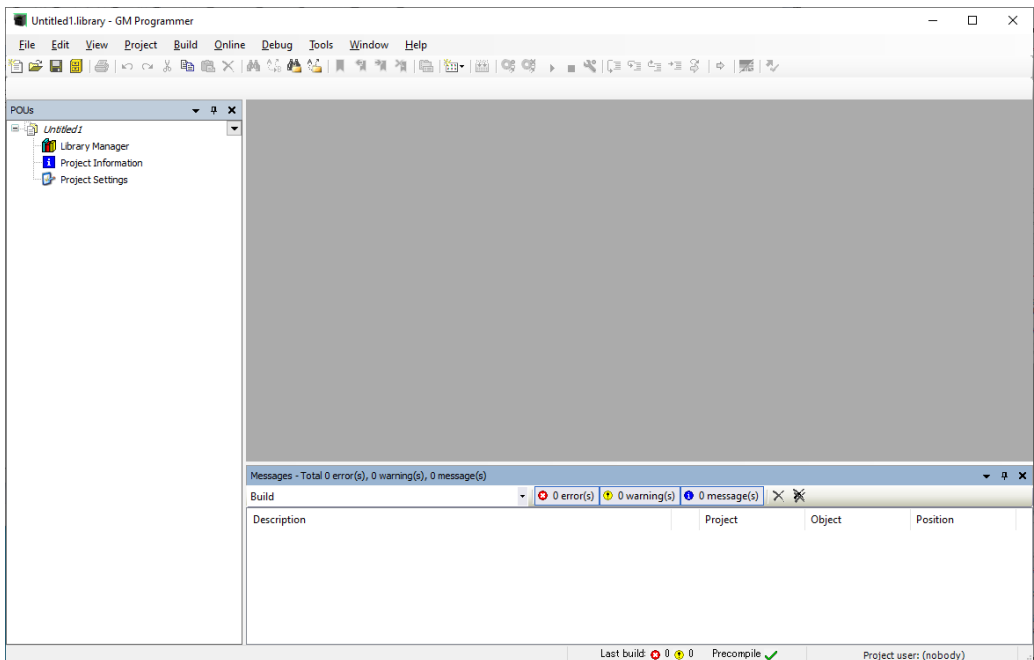

- Double-click the "Project Information" object in the POU view.
The "Project Information" dialog box will be displayed.
If necessary, change the settings in the "Company", "Title", and "Version" fields. The information set in these fields will be displayed in the selection window when created libraries are added to the project.

5.6 User Library Function

If the "Release" check box is selected, a confirmation message will be displayed when an attempt is made to change a library.

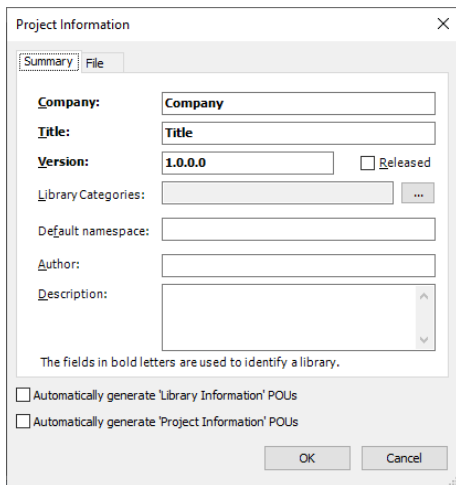

Project Information

Summary | File

Company: Company

Title: Title

Version: 1.0.0.0 Released

Library Categories: ...

Default namespace:

Author:

Description:

The fields in bold letters are used to identify a library.

Automatically generate 'Library Information' POUs

Automatically generate 'Project Information' POUs

OK Cancel

- Click the [OK] button.
The project information will be set.
- Right-click the <file name> object at the top of the navigator pane and then select **Add Object>POU** from the context-sensitive menu that is displayed.
The "Add POU" dialog box will be displayed.

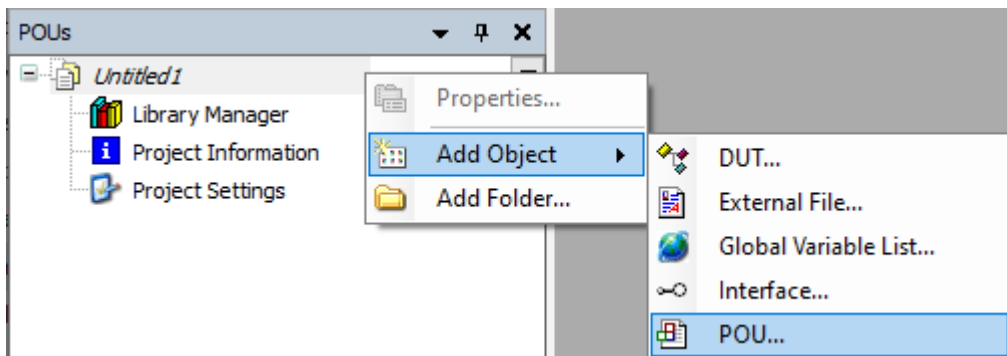

- Select the "Function block" check box, enter a name in the Name field, and select a programming language from the Implementation Language drop-down list.
For details on functions blocks, refer to "5.5 Function and Function Block".

9. Click the [Add] button.

An object of the function block will be added to the POU view in the navigator pane.

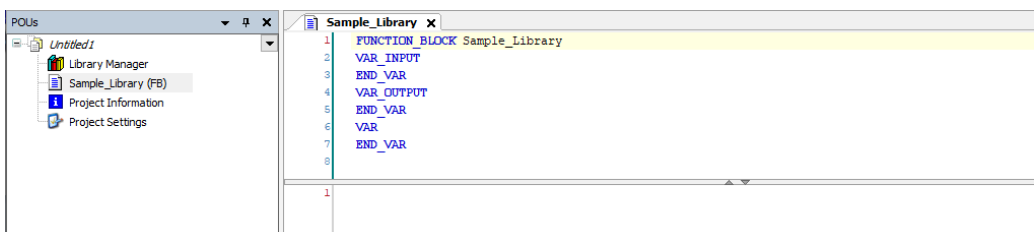

10. Enter a program in the function block.

After entering a program, from the menu bar, execute **Build>Check All Pooled Objects**. Build will be executed to perform a syntax check. After the above command is executed, if any error is displayed, correct the program and execute build again.

11. From the menu bar, select **File>Save Project and Install into Library Repository**.

The library that has been created will be installed in the library repository.

12. From the menu bar, select **Tools>Library Repository**.

The "Library Repository" dialog box will be displayed. Check that the created library is displayed in the "Installed library" section.

5.6 User Library Function

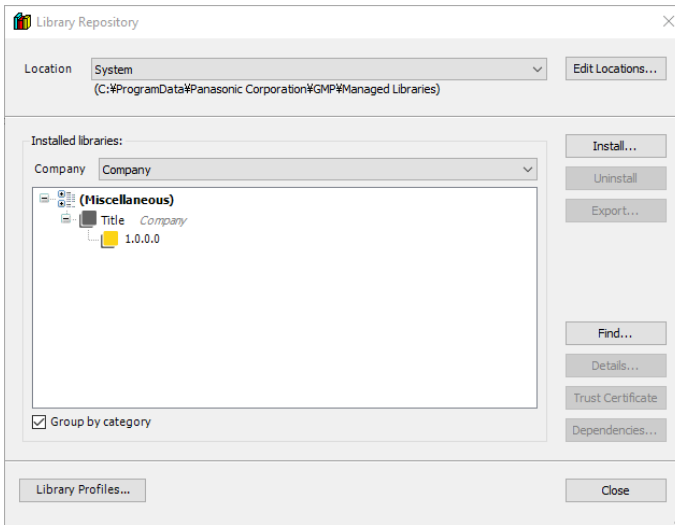

Clicking the [Detail] button enables the user to check information such as function blocks included in the library.

This completes the procedure for installing the library in the library repository.

i Info.

- Difference between libraries (.library) and compiled libraries (.compiled-library).
If a library is installed as a library file into the repository, the user can refer to codes by step-in execution during debugging and check execution details.
The user cannot execute codes in any compiled library while referring to the codes.

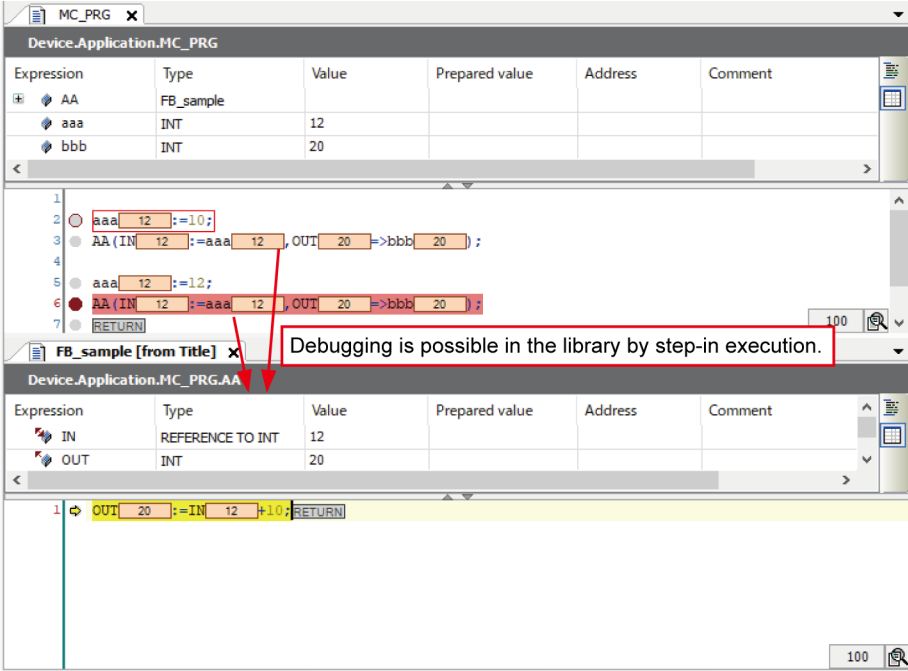

- Method for installing a compiled library
In Step 10, select **File>Save Project as Compiled Library** from the menu. The library is saved as a compiled library file (.compiled-library).
Then, click the [Install] button in the "Library Repository" dialog box and select the saved compiled library file.

5.6 User Library Function

5.6.2 Using Created Libraries

This section explains how to add libraries installed in the library repository to the project.

1 2 Procedure

1. Open the project file and select the "Library Manager" object.
The "Library Manager" window will be displayed.
2. Click the [Add Library] button.
The "Add Library" dialog box will be displayed, showing the libraries added to the library repository.

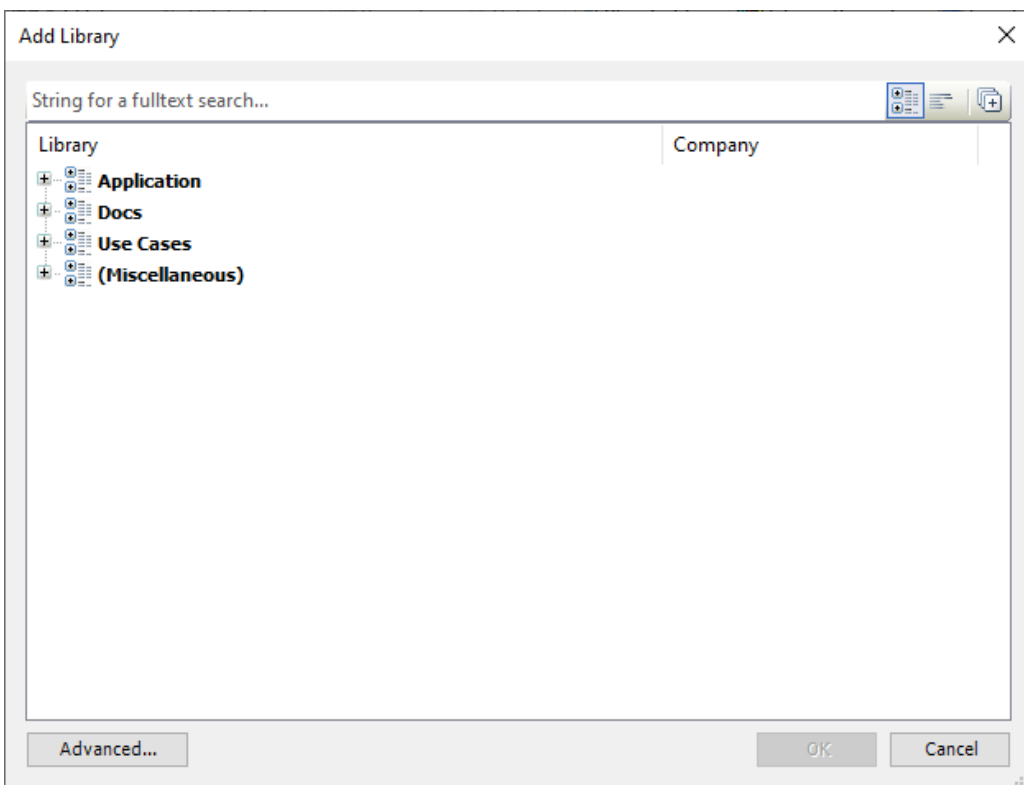

3. Select a created library and click the [OK] button.
The selected library will be added to the application in the project.
The title and company name specified when the library was created will be displayed.

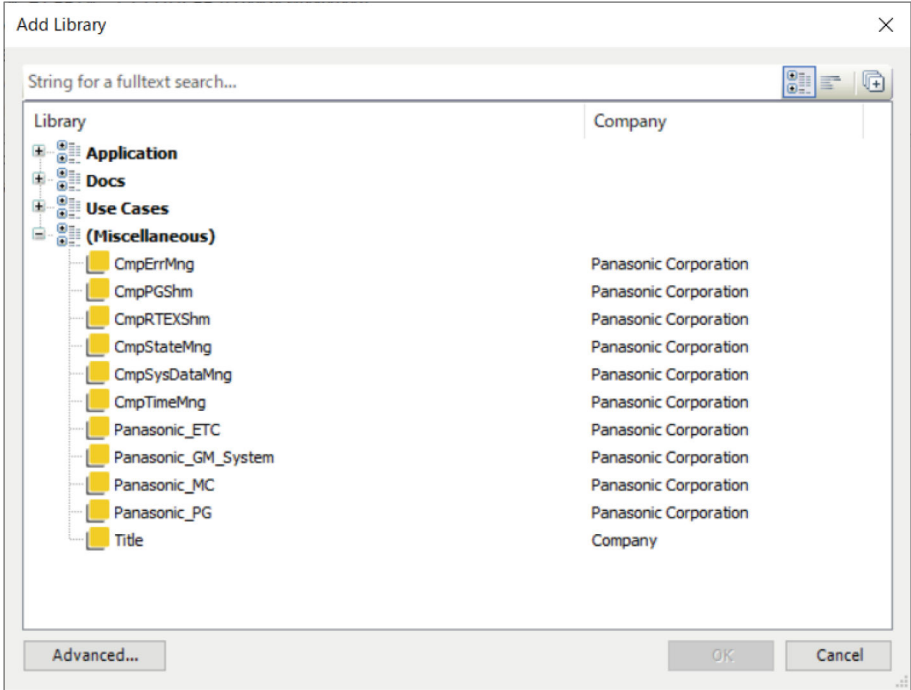

This completes the procedure for adding the library to the application. The function blocks in the added library can be used in the program.

5.7 POU for implicit checks

POU for implicit checks is an object with functions that check the range of array indexes or subrange type variables, validity of pointer addresses, and division by zero. Adding this object to the project makes it possible to automatically call these functions and perform checks, without calling the functions explicitly within the program.

5.7.1 Setting up POU for implicit checks

This section explains how to add POU for implicit checks objects.

1 2 Procedure

1. Right-click the [Application] object in the navigator pane and then select **Add Object>POU for implicit checks** from the context-sensitive menu that is displayed. The "Add POU for implicit checks" dialog box will be displayed.

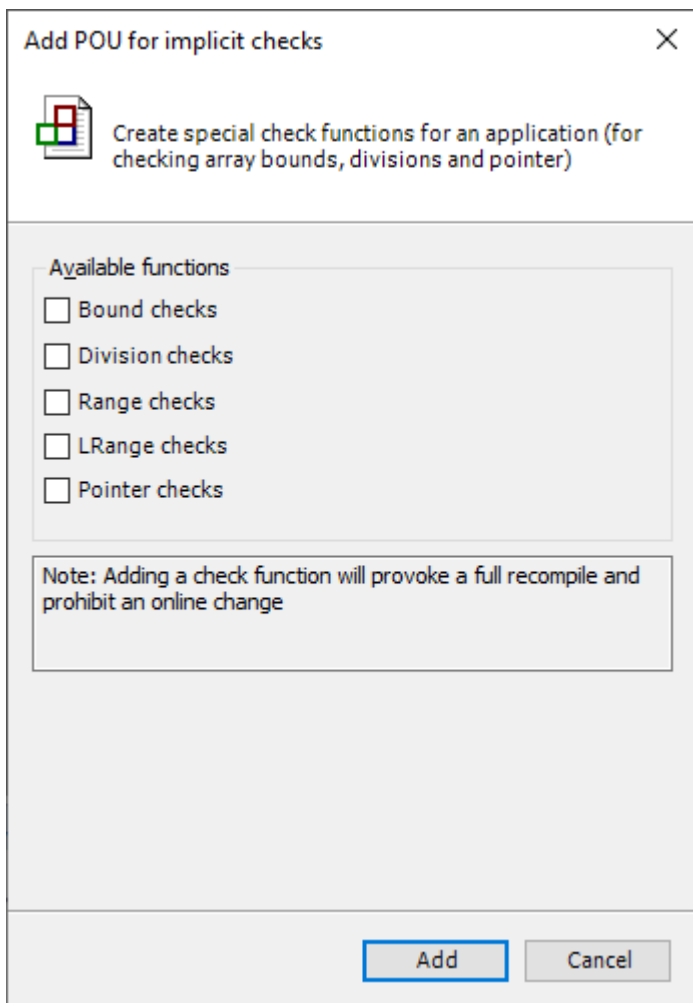

2. Select the check box of a function that you want to add.
Multiple functions (objects) will be added, depending on the item that you select.

Check type	Function name (object name)
Bound checks	CheckBounds
Division checks	CheckDivDInt
	CheckDivLInt
	CheckDivLReal
	CheckDivReal
Range checks	CheckRangeSigned
	CheckRangeUnsigned
LRange checks	CheckLRangeSigned
	CheckLRangeUnsigned
Pointer checks	CheckPointer

3. Click the [Add] button.
The function (object) for the selected item will be added.
If necessary, edit the implementation section of the object that has been added.

The check details of each check item are as below.

Bound Checks

Checks whether the bound is violated.

Division Checks

Checks whether anything is divided by zero.

Range Checks

Checks whether values of DINT or UDINT subrange type variables are within the specified range.

LRange Checks

Checks whether values of LINT or ULINT subrange type variables are within the specified range.

Pointer Checks

Checks whether the returned pointer refers to a valid memory address or whether the contents of a memory address that is referred to match the variable type that refers to the pointer.

For Pointer Checks, a program must be created for the function.

5.8 Tasks

5.8 Tasks

The GM1-series motion controller executes the following three tasks.

Task	Description
MotionTask	This is a user program task to perform motion control. It is given the highest priority. Only one MotionTask is allowed for each project.
UserTask	This is a user program task to perform control other than motion control. The user can set the level of priority. Up to 50 tasks can be registered in a single project.
SystemTask	This is a task that is used by the system and cannot be added by user programs. It is processed while other tasks are inactive.

To execute a user program, the program (POU object) must be added to tasks. Add motion control programs to MotionTask. Add other control programs to UserTask.

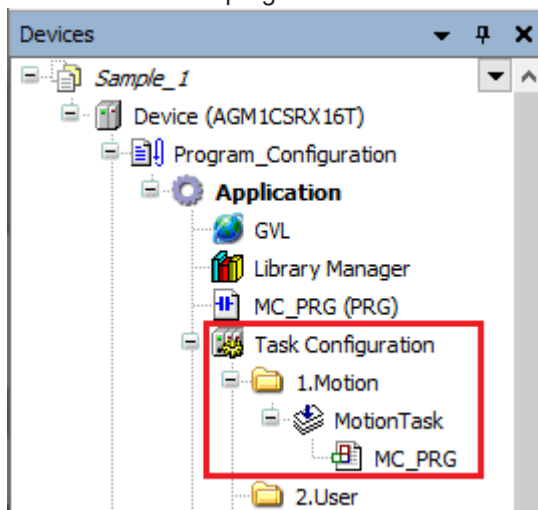

5.8.1 Adding Programs

POU objects of programs can be added to tasks.

For example, use the following procedure to add program "LD_POU" to task "MotionTask".

1 2 Procedure

1. Double-click the "MotionTask" object in the navigator pane.
The "MotionTask" task configuration window will be displayed in the main pane.

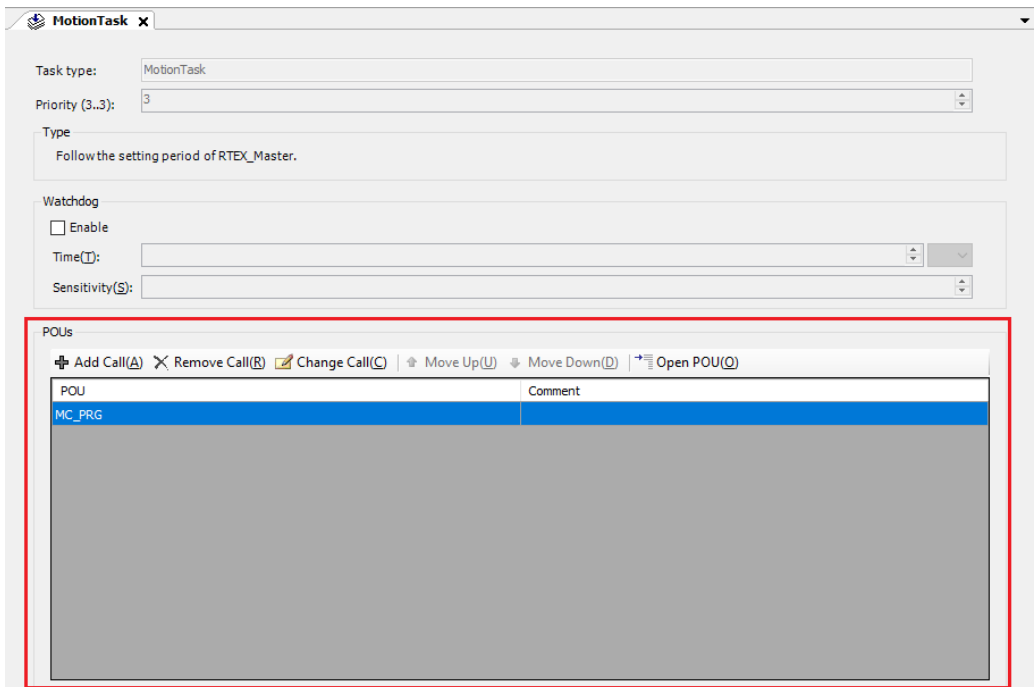

2. In the "MotionTask" window, click the [Add Call] button.

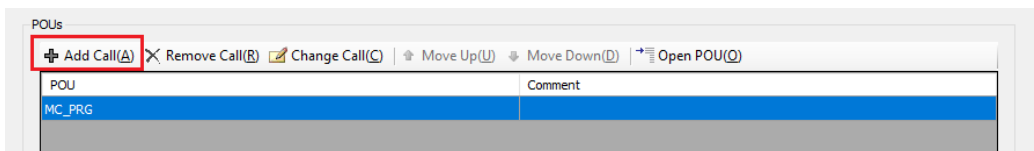

The "Input Assistant" dialog box will be displayed.

5.8 Tasks

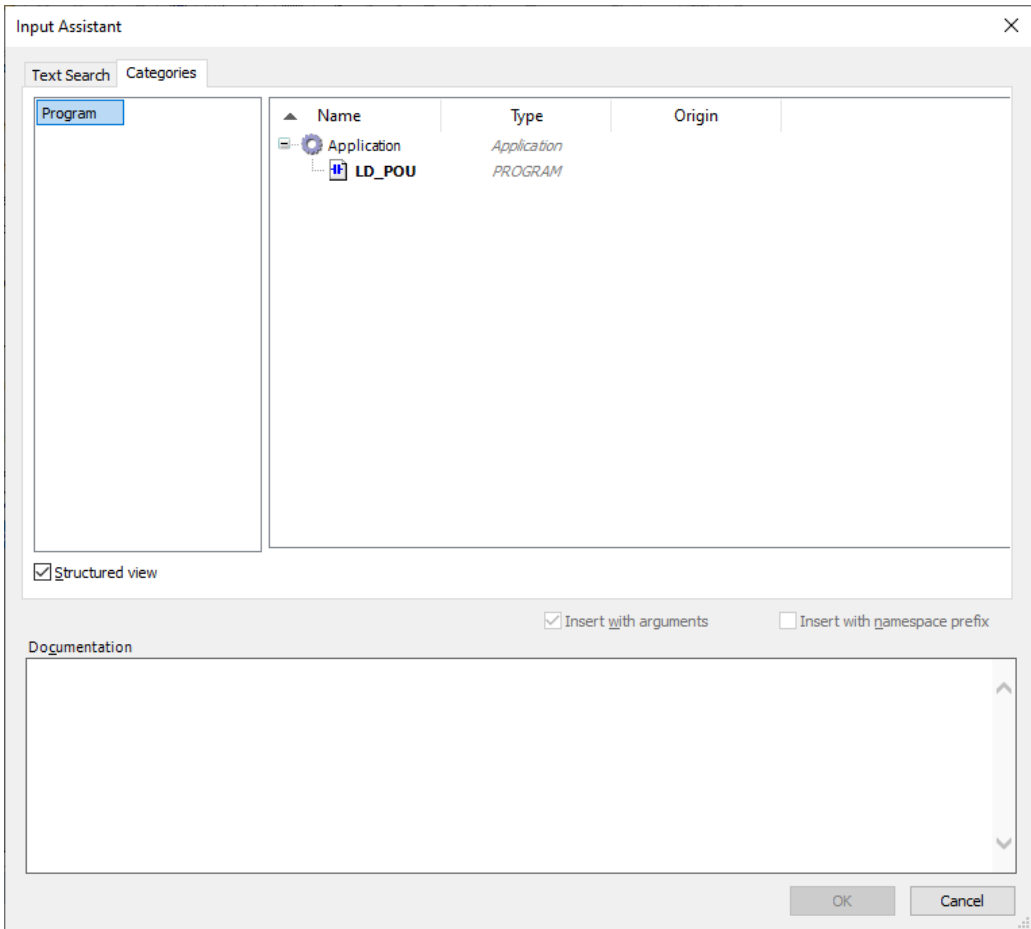

3. Select the POU object (LD_POU) of the program to be added to the task and click the [OK] button.

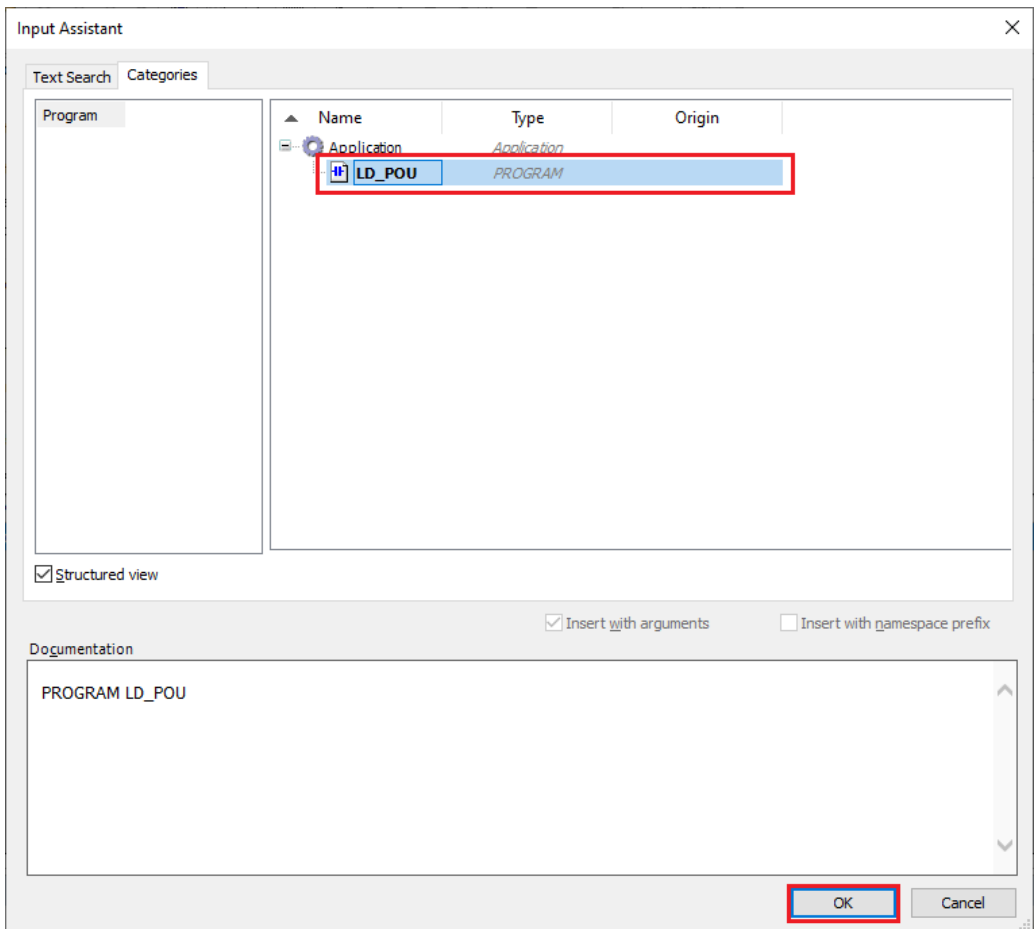

The POU object of the program will be added to the task.

5.8 Tasks

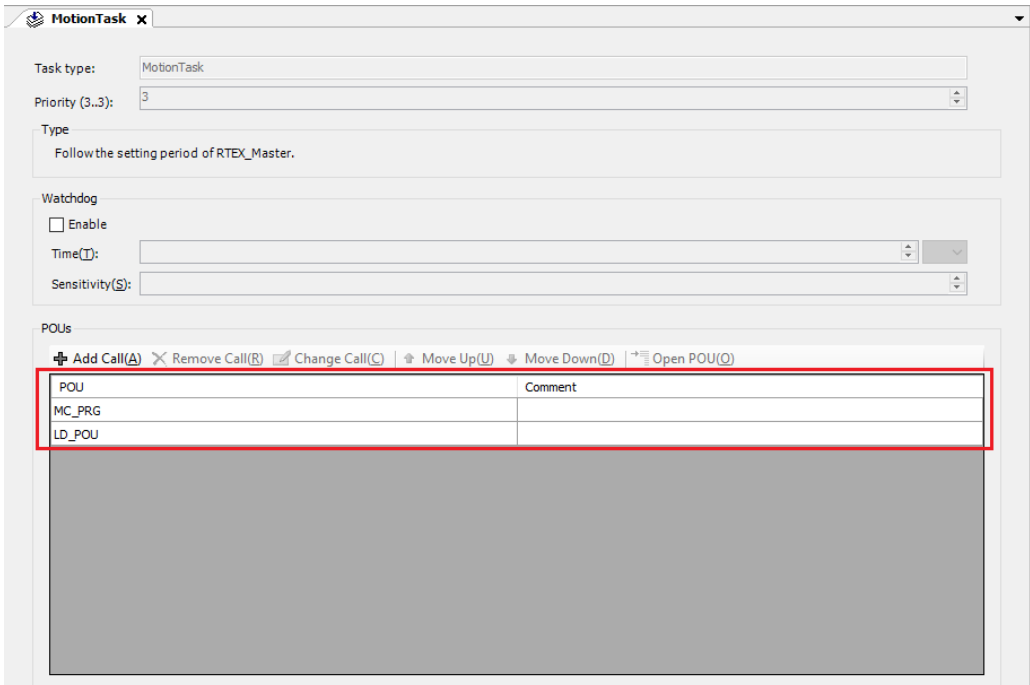

Selecting a cell in the "Comment" column allows you to edit the comment. The task will also be added to the navigator pane.

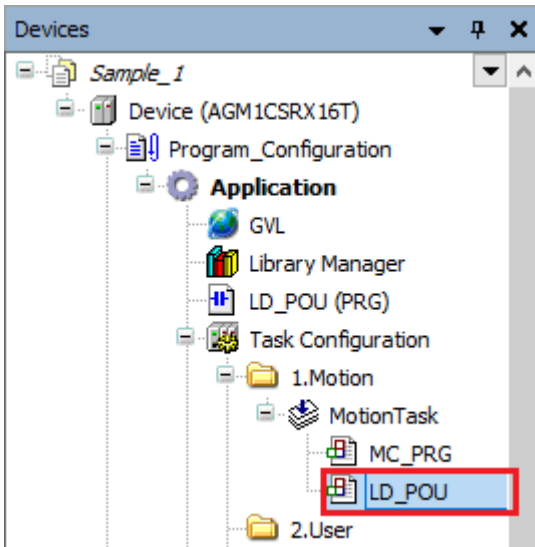

i Info.

- You can also add a POU object to a task by dragging the POU object in the navigator pane and dropping it onto the task object.

5.8.2 Adding a UserTask

UserTask can be added to a project.

1 2 Procedure

1. Right-click "2.User" in the navigator pane and then select **Add Object>UserTask** from the context-sensitive menu that is displayed.

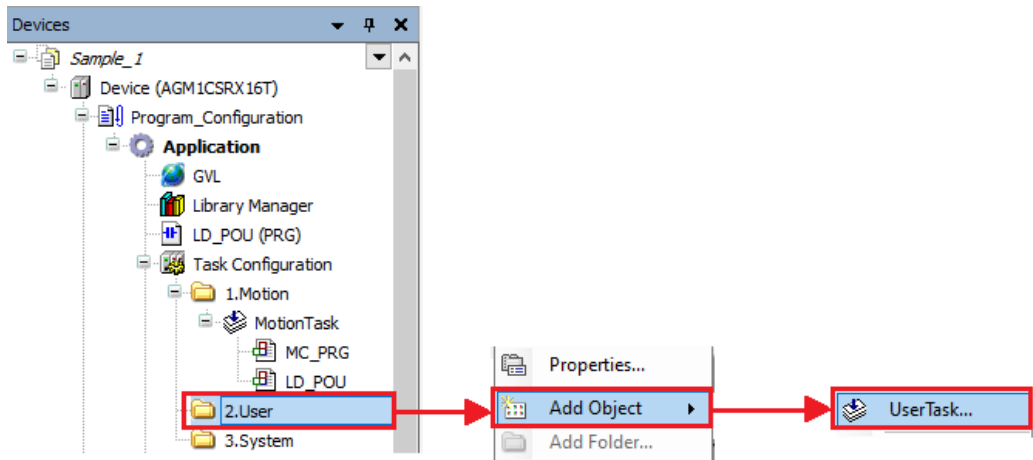

The "Add UserTask" dialog box will be displayed.

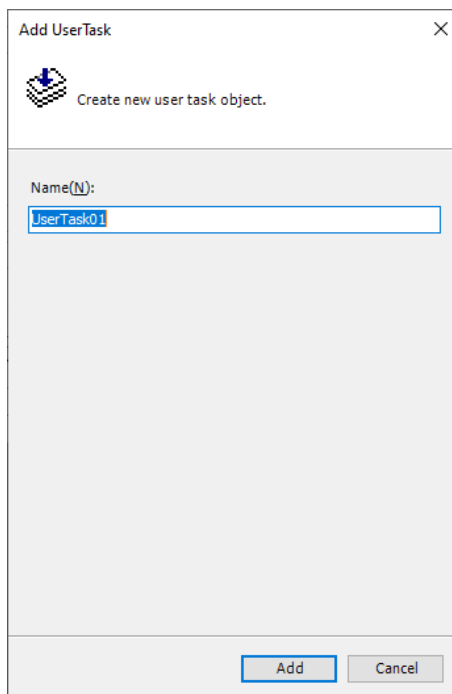

2. Enter a task name in the Name field and click the [Add] button.

5.8 Tasks

The task object will be added.

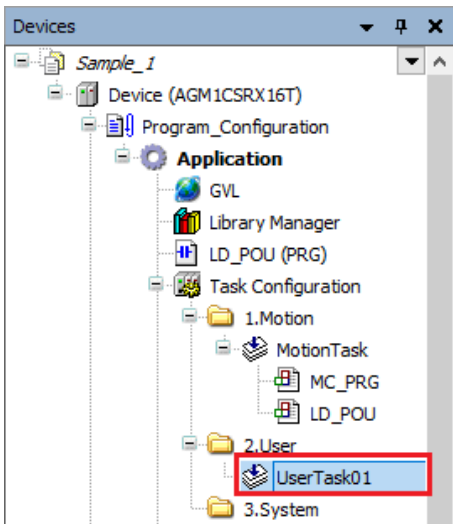

3. Add a POU object to the UserTask.

The added POU object will be executed as a UserTask.

Double-clicking the object of the added UserTask displays a task configuration window where task settings can be configured.

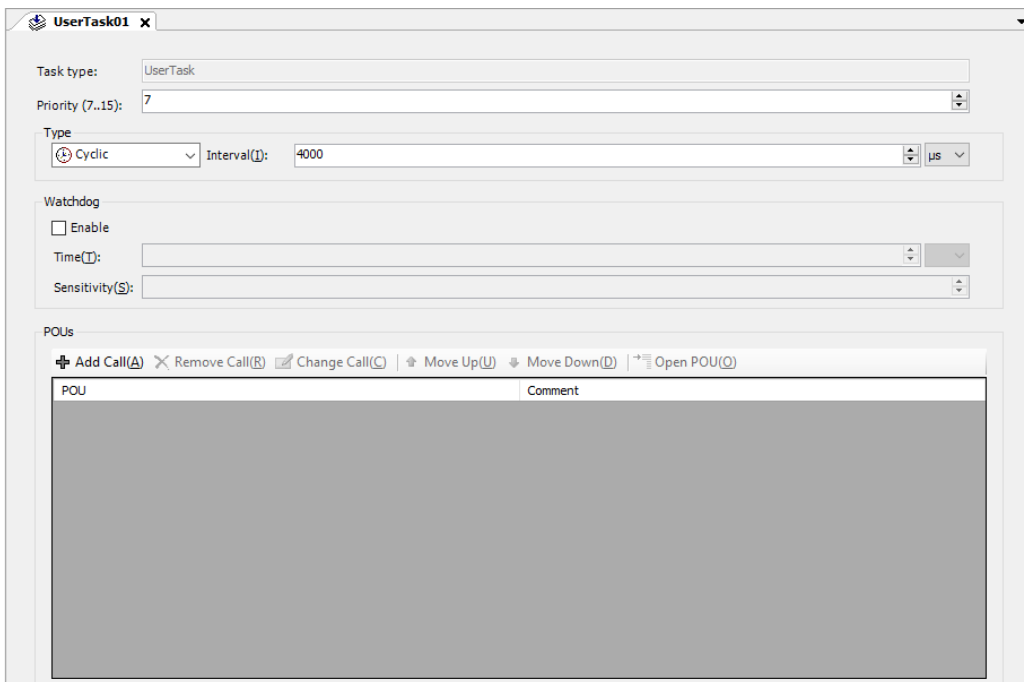

5.8.3 Task Configuration Window

The task configuration window allows the user to configure settings related to task execution, such as execution priorities, execution methods, execution intervals, and watchdog timer.

For the procedure for displaying the task configuration window, refer to ["5.8.1 Adding Programs"](#).

Example: Task configuration window for task "MotionTask"

The screenshot shows the 'MotionTask' configuration window. The title bar reads 'MotionTask [Device: Program_Configuration: Application: Task Configuration]'. The window is divided into several sections:

- Task type:** A text field containing 'MotionTask'.
- Priority (3..3):** A spin box set to '3'.
- Type:** A text area containing 'Follow the setting period of RTEK_Master.'
- Watchdog:**
 - An 'Enable' checkbox, which is currently unchecked.
 - A 'Time(T):' field with a spin box and a unit dropdown set to 'ms'.
 - A 'Sensitivity(S):' field with a spin box.
- POUs:** A table with two columns: 'POU' and 'Comment'. The table contains two rows: 'MC_PRG' and 'LD_POU'. Above the table are several icons for actions: 'Add Call(A)', 'Remove Call(R)', 'Change Call(C)', 'Move Up(U)', 'Move Down(D)', and 'Open POU(O)'.

Item	Description
Task type	This field displays the type of the task. It displays MotionTask, UserTask, or SystemTask.
Priority	This field displays the priority of the task. The smaller the value, the higher the priority. For UserTask, the priority can be set between 7 and 15 inclusive.
Type	This section specifies the processing method for the task. For UserTask, one of the following two types can be selected. <ul style="list-style-type: none"> • Cyclic: Processes the task at intervals. Specify a task interval in the "Period" field. • Event: Starts task processing as soon as a rising edge of the global variable specified in the "Event" field is detected
Watchdog	If the "Enable" check box is selected, when the program execution time exceeds the preset time, the task will enter an error state and comes to a halt. The stop conditions are divided into the following two cases: <ul style="list-style-type: none"> • Case where the program execution time exceeds the number of times specified in "Sensitivity" or the time specified in "Time"

5.8 Tasks

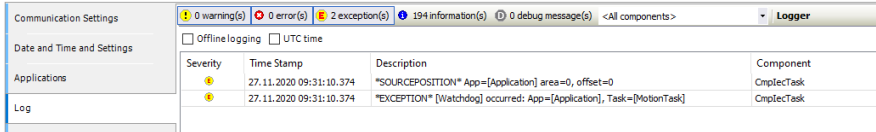
Item	Description												
	<ul style="list-style-type: none"> Case where the program execution time exceeds "Sensitivity" × "Time" during a single cycle (Example: If "Sensitivity" is set to "3" and "Time" is set to "t#20ms", when the execution time exceeds 60 ms during a single cycle, the task will stop.) <p>If the watchdog timer causes the task to stop, the event will be recorded in the "Log" tab of the device editor.</p>  <p>The screenshot shows the 'Log' tab of the device editor. At the top, there are summary statistics: 0 warning(s), 0 error(s), 2 exception(s), 194 information(s), and 0 debug message(s). Below this, there are checkboxes for 'Offline logging' and 'UTC time'. The main log area contains a table with the following data:</p> <table border="1"> <thead> <tr> <th>Severity</th> <th>Time Stamp</th> <th>Description</th> <th>Component</th> </tr> </thead> <tbody> <tr> <td>Warning</td> <td>27.11.2020 09:31:10.374</td> <td>*SOURCEPOSITION* App=[Application] area=0, offset=0</td> <td>CmpIecTask</td> </tr> <tr> <td>Exception</td> <td>27.11.2020 09:31:10.374</td> <td>*EXCEPTION* [Watchdog] occurred: App=[Application], Task=[MotionTask]</td> <td>CmpIecTask</td> </tr> </tbody> </table>	Severity	Time Stamp	Description	Component	Warning	27.11.2020 09:31:10.374	*SOURCEPOSITION* App=[Application] area=0, offset=0	CmpIecTask	Exception	27.11.2020 09:31:10.374	*EXCEPTION* [Watchdog] occurred: App=[Application], Task=[MotionTask]	CmpIecTask
Severity	Time Stamp	Description	Component										
Warning	27.11.2020 09:31:10.374	*SOURCEPOSITION* App=[Application] area=0, offset=0	CmpIecTask										
Exception	27.11.2020 09:31:10.374	*EXCEPTION* [Watchdog] occurred: App=[Application], Task=[MotionTask]	CmpIecTask										

5.9 Build

When a created program is subject to a build process, objects in the application are compiled. If code generation is executed after the build process is executed, an application to be downloaded to the GM1 controller will be generated.

5.9.1 Build

The syntax of all objects is verified when the build process is executed for the first time.

The syntax of only differences is verified when the build process is executed a second time and thereafter. No application code will be generated.

5.9.2 Rebuild

Verifies the syntax of all objects again.

As is the case with build, no application code will be generated.

1 2 Procedure

1. From the menu bar, select **Build>Rebuild**.

The syntax of all objects will be verified. If an error or warning occurs, an error or warning message will be displayed in the message view.

Check the message displayed in the message view and correct the program as necessary.

After correcting the program, execute rebuild again.

5.9.3 Code Generation

The GM1 controller generates codes (application codes) to be executed when the application starts.

Displays the remaining program capacity and variable capacity during code generation.

1 2 Procedure

1. From the menu bar, select **Build>Code Generation**.

Tests will be executed to check memory allocations, data types, and library availability and code size (in bytes), data size (in bytes), allocated memory contents, and most frequently used address (in bytes) will be displayed in the Messages view.

Example: Messages view displayed when code generation is completed correctly

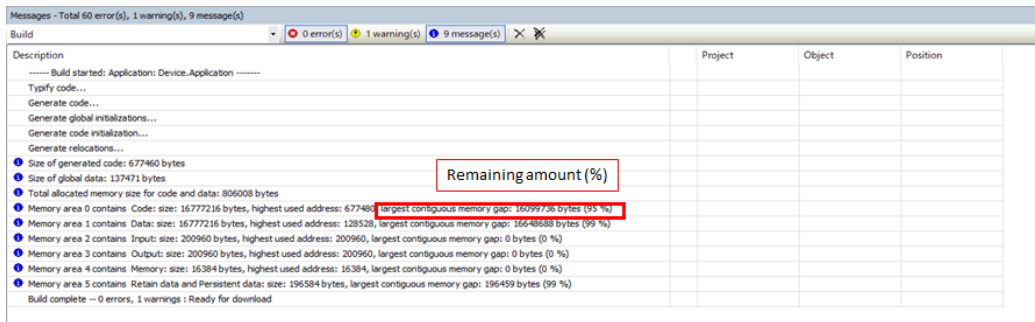

Memory area 0	Program capacity	For the maximum capacity, refer to the GM1 Series Reference Manual (Hardware).
Memory area 1	Variable capacity (non-hold)	For the maximum capacity, refer to the GM1 Series Reference Manual (Hardware).
Memory area 2	Input variable	Automatic assignment during code generation
Memory area 3	Output variable	Automatic assignment during code generation
Memory area 4	Internal memory	Automatic assignment during code generation
Memory area 5	Variable capacity (hold)	For the maximum capacity, refer to the GM1 Series Reference Manual (Hardware).

i Info.

- After application codes are generated, if some codes are changed and code generation is executed again, differential compilation will reallocate memory to only newly added and changed blocks and variables. If memory fragmentation occurs as a result of memory reallocation, the amount of memory that can be actually used will be reduced. To eliminate memory fragmentation, you must perform the procedure described in "5.9.4 Clean".

5.9.4 Clean

Deletes application build information.

1 2 Procedure

1. From the menu bar, select **Build>Clean**.

If "Clean" is executed, the following confirmation message will be displayed.

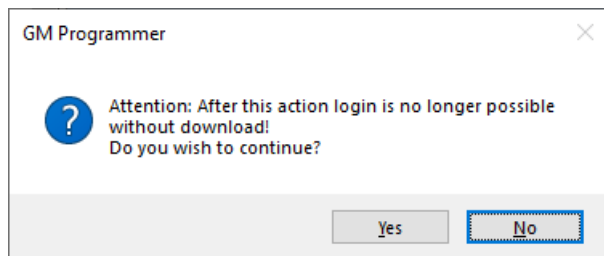

Clicking the [Yes] button executes "Clean".

i Info.

- If "Clean" is executed, online change can no longer be performed. Therefore, to log in to the GM1 controller again, you must download the applications.
- If you copy a program object (POU object), execute "Clean" for the copied POU object.

p Note

- Even if "Clean" is executed, the variables registered in the global persistent variable list will not be initialized. Other variables and persistent variables will be initialized.

5.9.5 Clean All

Deletes all application build information in the same way as "Clean".

1 2 Procedure

1. From the menu bar, select **Build>Clean All**.

If "Clean All" is executed, the following confirmation message will be displayed.

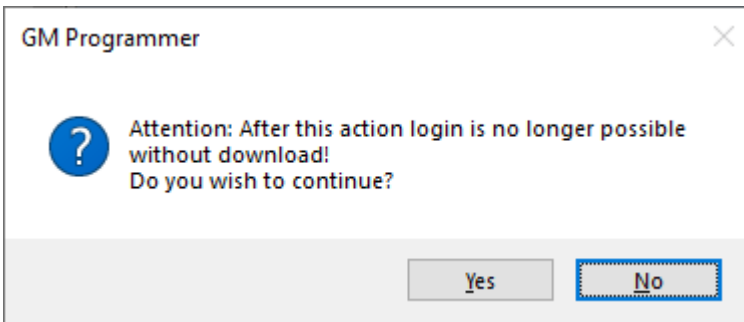

2. Clicking the [Yes] button executes "Clean All".

If variables have been registered in the persistent variable list, the following confirmation message will be displayed.

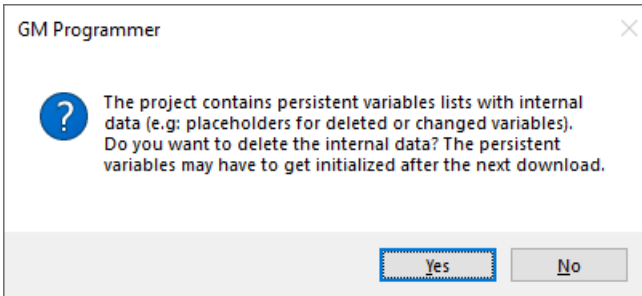

3. If you delete internal data, click the [Yes] button.
If you do not delete it, click the [No] button.

Note

- If you have made changes such as "Add new variables to the top of persistent variable list", note that actual variable values could become different values because the memory areas for retaining variables have become misaligned.

5.10 Program Creation Support Functions

This section explains the program creation support functions used to create programs.

5.10.1 Bookmark

The bookmark function allows the cursor to move to bookmarked locations.

The bookmark function can be used in all programs other than SFC programs.

This section explains the procedures for setting bookmarks and moving the cursor between bookmarks, using an LD program as an example.

1 2 Procedure

1. Select the network (circuit) where you want to set a bookmark. From the menu bar, select **Edit>Bookmarks>Toggle Bookmark**, or click the <Ctrl> key + <F12> key simultaneously.

A bookmark () will be set in the selected network (circuit).

Performing the above operation again clears (deletes) the set bookmark.

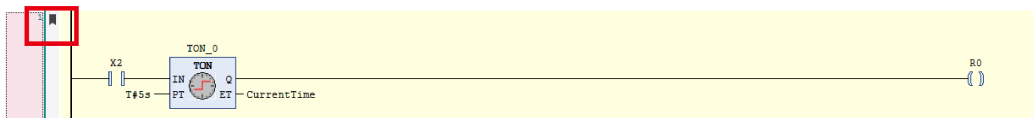

2. To move to the next bookmark, press the <F12> key. To move to the previous bookmark, press the <Shift> key + <F12> key simultaneously.

i Info.

- To clear (delete) all the set bookmarks, from the menu bar, select **Edit>Bookmarks>Clear All Bookmarks**.
- You can also perform bookmark operations by clicking appropriate icons on the toolbar.

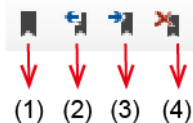

No.	Item
(1)	Toggle Bookmark
(2)	Previous Bookmark
(3)	Next Bookmark
(4)	Clear All Bookmarks

5.10 Program Creation Support Functions

5.10.2 Call Tree View

Opening the Call Tree view enables the user to search the callers and callees of blocks such as functions, function blocks, or POU.

1 2 Procedure

1. From the menu bar, select **View>Call Tree**.
The Call Tree view will be displayed.

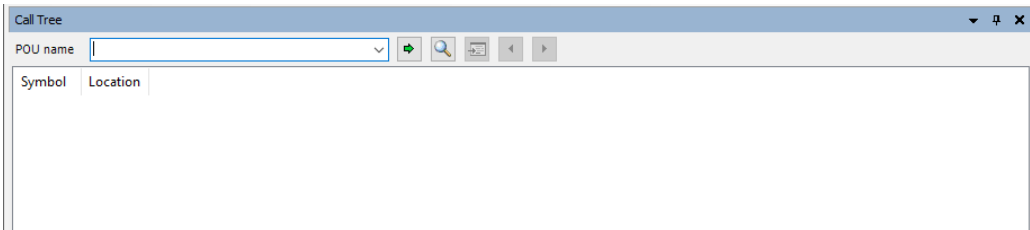

2. Enter a block to be searched in the POU Name field and press the <Enter> key.
The caller and callee of the block will be displayed in tree structure.
Double-clicking in any search result line displays the corresponding window in the main pane.

Example: Searching the caller and callee of FunctionBlock_Sample

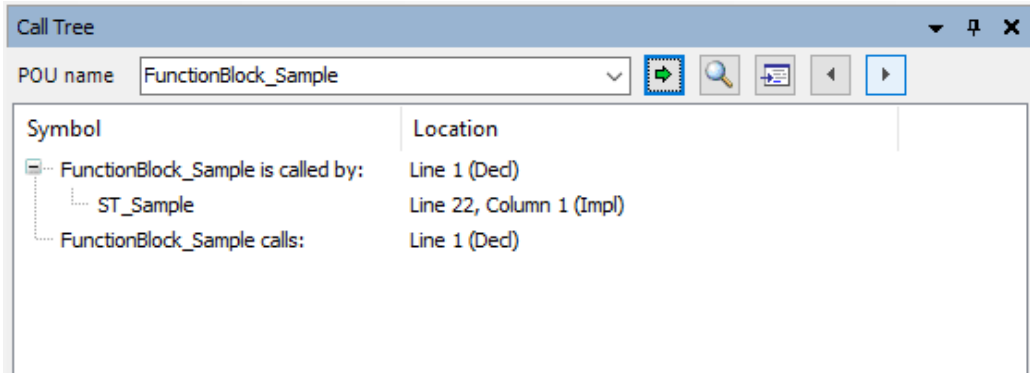

i Info.

- Pressing the <F4> key moves the cursor to the next search result line. Pressing the <Shift> key + <F4> key simultaneously moves the cursor to the previous search result line.
- Position the cursor on a block in the implementation section. From the menu bar, select **Edit>Browse>Browse Call Tree**. The Call Tree view will be displayed with a search conducted for the block at the cursor position.

5.10.3 Cross reference List View

Opening the Cross reference List view allows the user to search the locations of variables and other elements used within the entire project.

1 2 Procedure

1. From the menu bar, select **View>Cross Reference List**.

The Cross reference List view will be displayed.

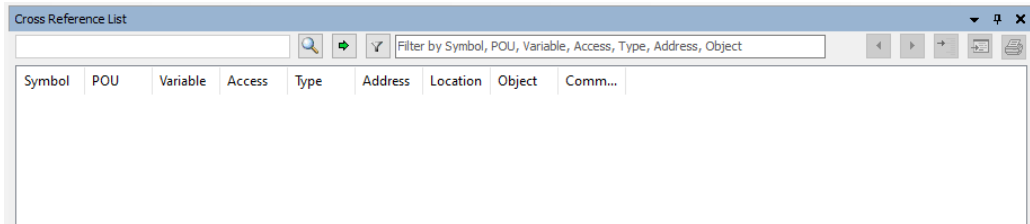

2. Enter a variable name (or another element name) to be searched in the search field and press the <Enter> key.

The locations of the variable (or element) used will be displayed in list form.

Double-clicking in any search result line displays the corresponding section in the main pane.

Example: When variable iVar0 is entered

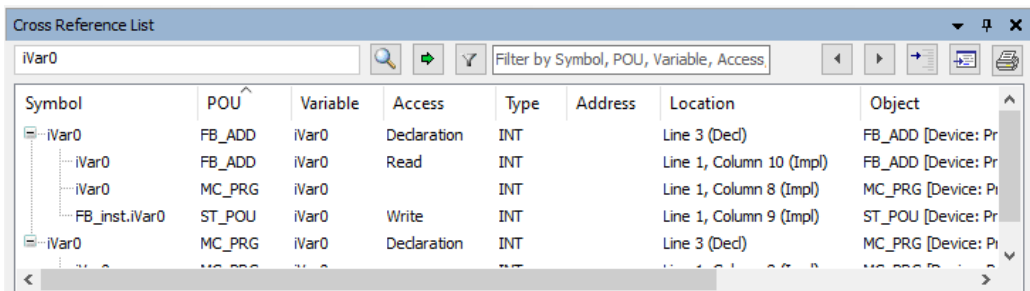

i Info.

- Pressing the <F4> key moves the cursor to the next search result line. Pressing the <Shift> key + <F4> key simultaneously moves the cursor to the previous search result line.
- For searches, you can use an asterisk (*) that represents any character string or a question mark (?) that represents a single character.
- Position the cursor on a variable in the implementation section. From the menu bar, select **Edit>Browse>Browse Cross Reference**. The Cross-reference view will be displayed with a search conducted for the variable at the cursor position.

5.10 Program Creation Support Functions

5.10.4 Function Block Guidance

The Function Block Guidance allows the user to enter motion function blocks into a program. The Function Block Guidance can be used in LD programs, ST programs, FBD programs, and CFC programs.

The following procedure is explained, using an example in which "Power" is searched and function block "MC_Power" is inserted into an LD program.

1 2 Procedure

1. Double-click the [MC_PRG(PRG)] object in the navigator pane.

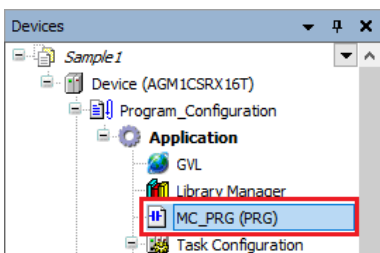

The "MC_PRG" window will be displayed.



2. Select the network in the implementation section and, from the menu bar, select **Edit>Function Block Guidance**.



The "Function Block Guidance" dialog box will be displayed.

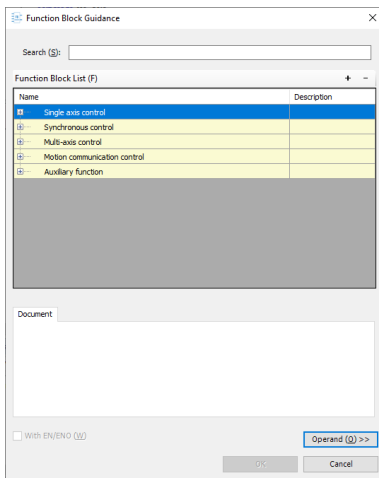

3. Enter a character string in the Search field.
Function blocks related to the entered character string will be displayed in the Function Block List table.

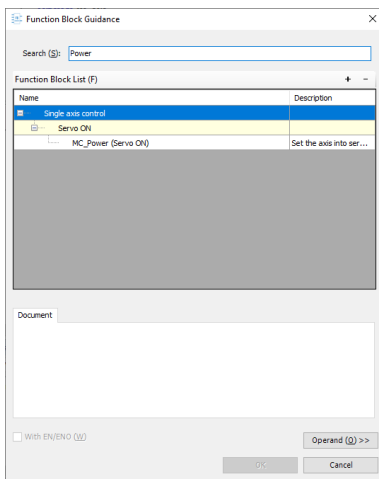

4. Select a function block that you want to insert into the program.
A description of the selected instruction will be displayed in the Document tab pane.

5.10 Program Creation Support Functions

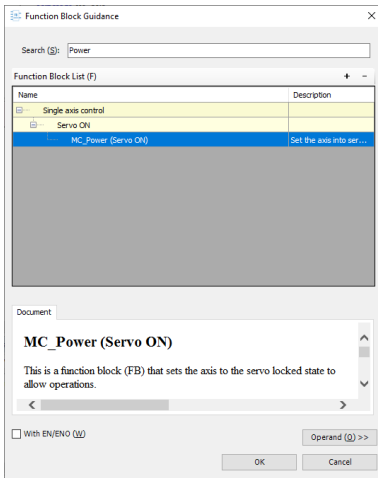

- Click the [Operand] button.
The instance and operand input fields will be displayed.

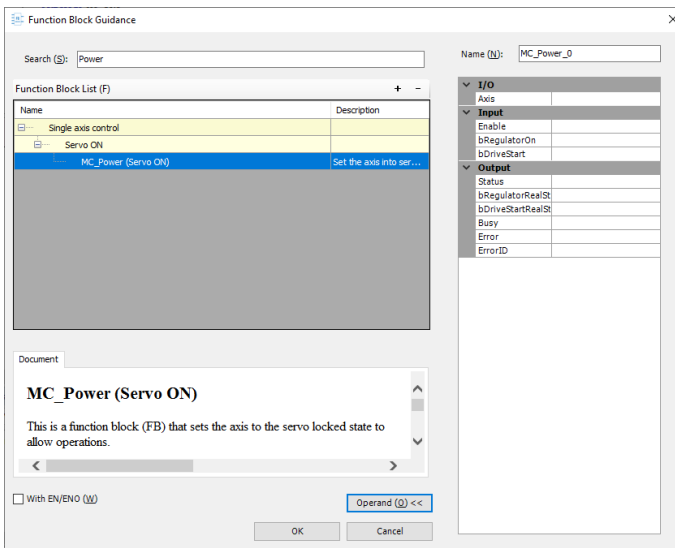

- Enter an instance name in the Name field and values in each operand field.
If the operand for which a value has been entered is a variable that has not been declared, the "Auto Declare" dialog box will be displayed, so that the variable can be declared.

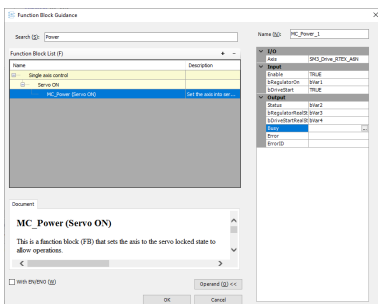

7. Click the [OK] button.

If an instance name has not been declared, the "Auto Declare" dialog box will be displayed, so that an instance can be declared.

The function block will be inserted into the program.

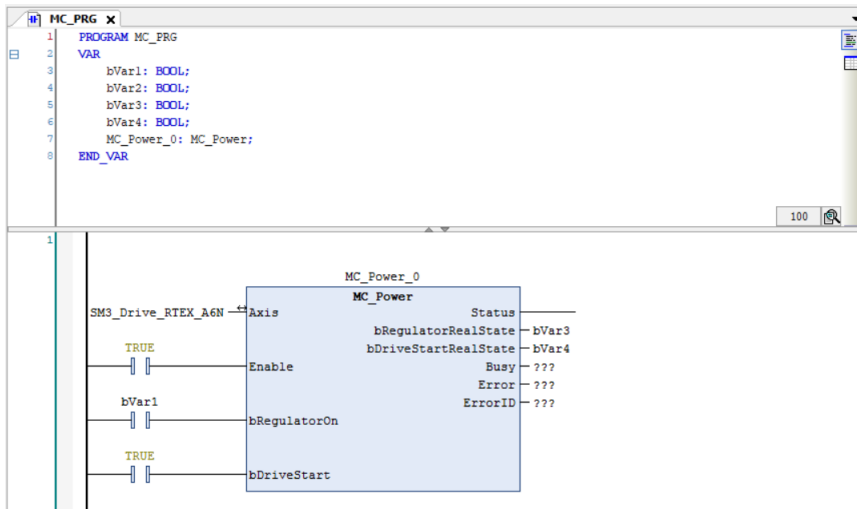

i Info.

- To insert a function block into a CFC program, insert a box first and, with the box selected, start the Function Block Guidance.
- If the "With EN / ENO" check box is selected, a function block with EN input and ENO output will be inserted. When the value of EN input is TRUE, the function block is executed. Similarly, when the value of EN input is FALSE, the function block is not executed. The same value as EN input is output to ENO output.
- The Function Block Guidance can also be started using the following operations:
 - Click the "Function Block Guidance" icon on the toolbar.
 - Press the <Alt> key + <F2> key simultaneously.
 - Select the network in the implementation section, and then right-click and select "Function Block Guidance" from the context-sensitive menu that is displayed.

5.10 Program Creation Support Functions

5.10.5 Short Form Function

Using the short form function in the declaration section in character string format enables variables to be declared by entering fewer characters.

- **Example: Declaring Boolean variables bVar0 and bVar1 with the short form function**

1 2 Procedure

1. Enter variables bVar0 and bVar1, and press the <Ctrl> key + <Enter> key simultaneously. "bVar0, bVar1:BOOL;" will be entered automatically.

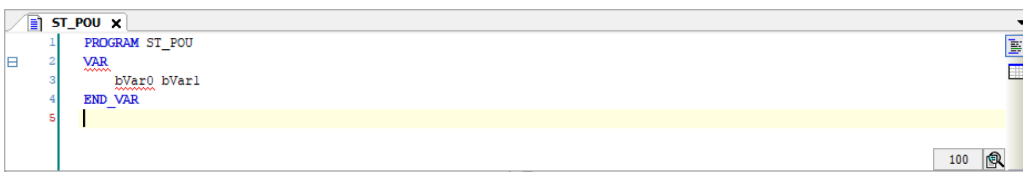

```
1 PROGRAM ST_POU
2 VAR
3   bVar0 bVar1
4 END_VAR
5 |
```

↓ <Ctrl> key + <Enter> key

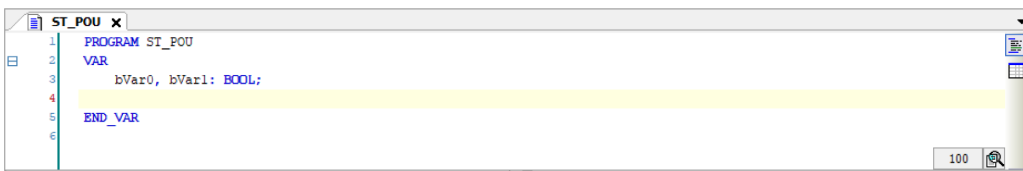

```
1 PROGRAM ST_POU
2 VAR
3   bVar0, bVar1: BOOL;
4
5 END_VAR
6
```

The table below shows examples of input using the short form function. Strings entered following a semicolon (;) are treated as comments.

Input in short form	Result after the <Ctrl> key + <Enter> key are pressed simultaneously
bVar0	bVar0:BOOL;
iVar0 iVar1 6	iVar0, iVar1: INT := 6;
strVar S 8	strVar: STRING(8)
wVar w; wVar comment	wVar: WORD; // wVar comment

5.10.6 Input Assistant Function

By using the Input Assistant Function, variables, function blocks, operators, types, and other elements that can be inserted in the cursor position can be selected from categories.

1 2 Procedure

1. Move the cursor to the position where you want to insert a desired element and press the <F2> key.

The "Input Assistant" dialog box will be displayed.

Select a desired element from the "Categories" tab pane or the "Text Search" tab pane.

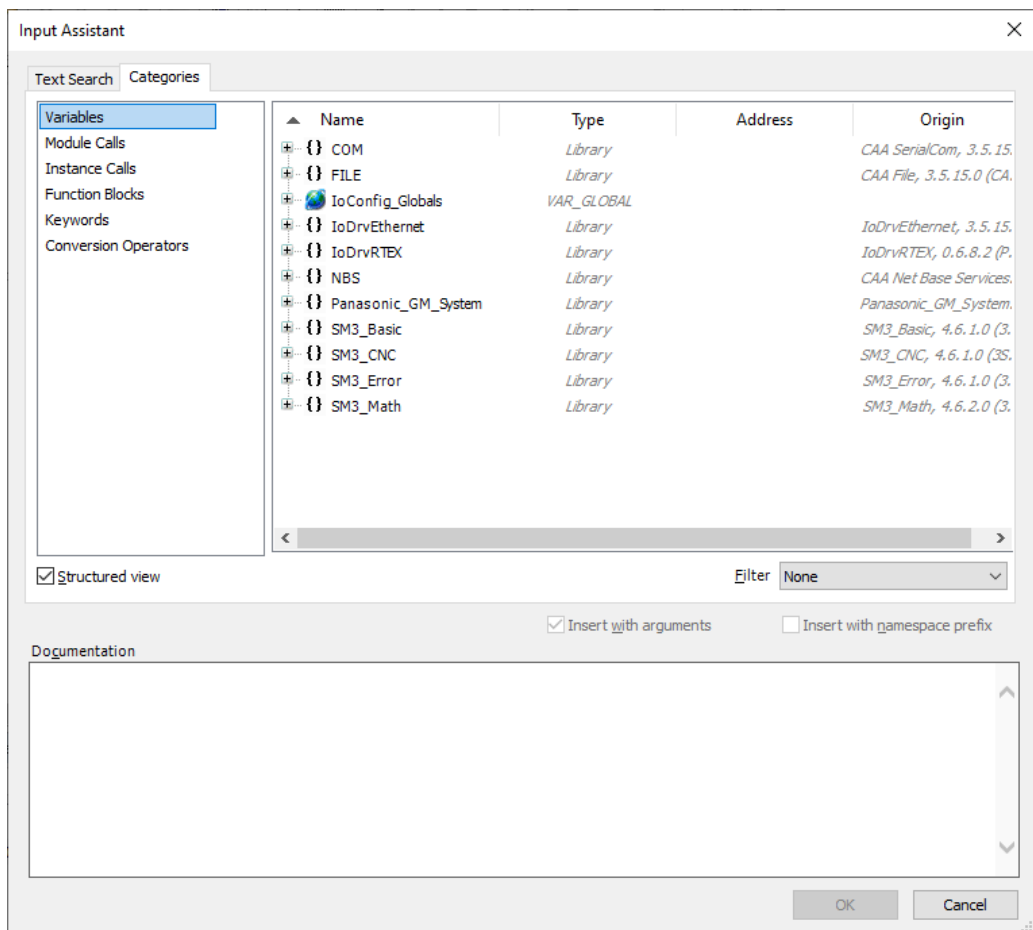

2. Click the [OK] button.
The selected element will be inserted.

i Info.

- You can also open the "Input Assistant" dialog box by selecting **Edit>Input Assistant** from the menu bar.

5.10 Program Creation Support Functions

5.10.7 Argument / Variable Input Support (Component List)

This section explains the functions (component list) that support input of arguments and other data for function blocks during program creation.

The following three input support functions are available.

■ Displaying candidates for arguments that can be entered

Entering a dot (.) after a name such as a function block name or structure name displays a list of candidates for arguments that can be entered.

To enable this function, in the Options window, select **SmartCoding>List components after typing a dot(.)**.

Example: Displaying a list of members of structure variable stVar after structure variable stVar and a dot are entered

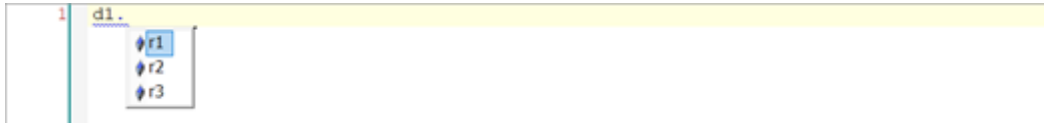

■ Displaying candidates for variables or other components starting with the entered character string

Entering any character string and then pressing the <Ctrl> key + <Space> key simultaneously displays a list of elements that can be inserted.

Example: Entering "TI" and pressing the <Ctrl> key + <Space> key simultaneously selects and displays the positions of variables or other components starting with "TI"

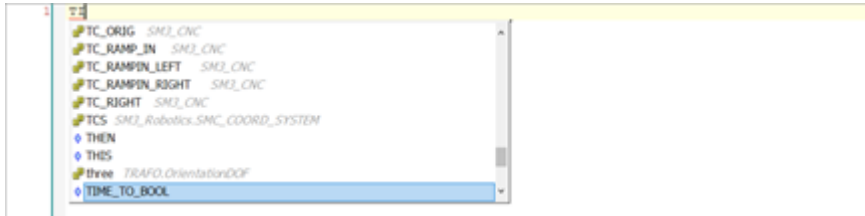

■ Displaying a description of function block or function

Entering a function block name (or some other name) followed by a left parenthesis displays a description of the function block in a pop-up window.

To open the closed pop-up window again, press the <Ctrl> key + <Shift> key + <Space> key simultaneously.



5.10.8 Global Renaming (Refactoring)

When a POU object name in the navigator pane or a variable name in the declaration section is changed, the sections where the changed name is used are displayed, so that the name can be changed collectively (this function is called "refactoring").

This section explains the procedure for changing the variable name of input variable "iVar2" in function block "FB_ADD" and using the refactoring function to change the variable name in the sections where the variable is called.

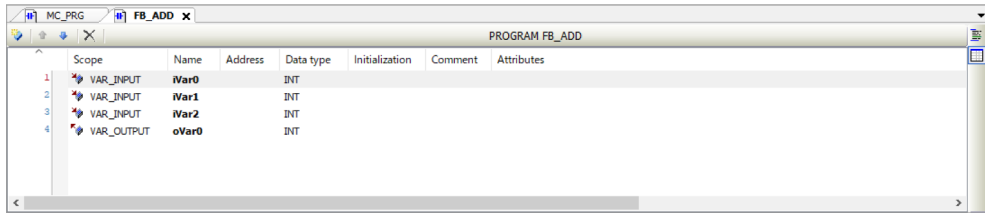

1 2 Procedure

1. Change the name of variable "iVar2" in the declaration section of the function block to "iVar3".

The "Automatic Refactoring" dialog box will be displayed.

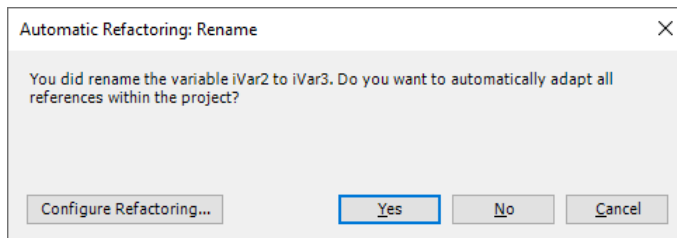

2. Click [Yes].

The "Refactoring" dialog box will be displayed.

Each section where the changed variable is used is displayed in red and the background of the section is displayed in yellow.

5.10 Program Creation Support Functions

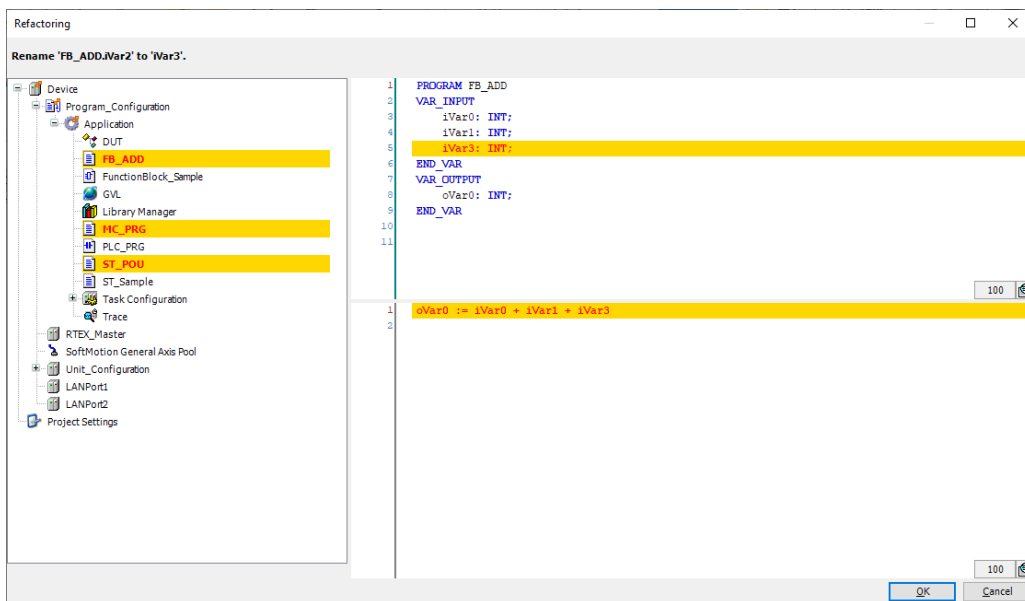

By clicking an object in the navigator pane, you can check the change details of the object. At this stage, the changes have not been reflected yet.

When ST_POU object is selected:



3. Click the [OK] button.
All changes will be reflected.

Info.

- When the sections where the changed variable is used are displayed by the refactoring function, you can individually select whether to reflect the change. Right-click in the sections where the changed variable is used and select whether to reflect the change, from the context-sensitive menu that is displayed.

"Reject this change": Does not reflect the change in the selected section

"Accept this object": Reflects the change in the object

"Reject this object": Does not reflect the change in the object

```
FB_inst.iVar0 := 10;
FB_inst.iVar1 := 20;
FB_inst.iVar3 := 30;
FB_inst()
result := FB_inst.oVar0
```

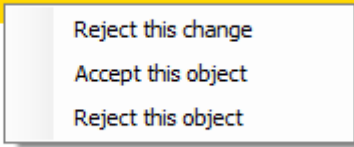

Reject this change
Accept this object
Reject this object

100

- In the Options window, you can specify the situations where the refactoring function is enabled. Open the Options window (by selecting **Tools>Options**), select the "Refactoring" category, and specify the situations where the refactoring function is enabled.

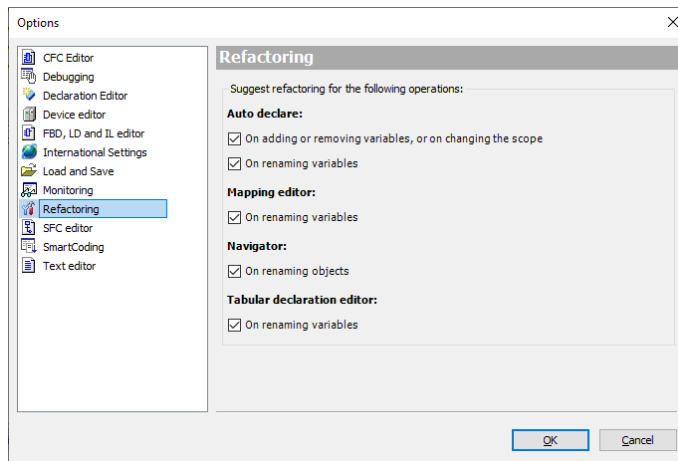

5.10 Program Creation Support Functions

5.10.9 Code Analysis (Static Analysis Light)

Code analysis (Static Analysis Light) can be conducted on programs that are created. Code analysis can check for the following errors.

Error number	Description
SA0033	Unused variables
SA0028	Overlapping memory areas
SA0006	Write access from several tasks
SA0004	Multiple write accesses on output
SA0027	Multiple uses of identifiers
SA0167	Report of temporary function block instance

1 2 Procedure

1. From the menu bar, select **Project>Project Settings**. The Project Settings dialog box will be displayed.

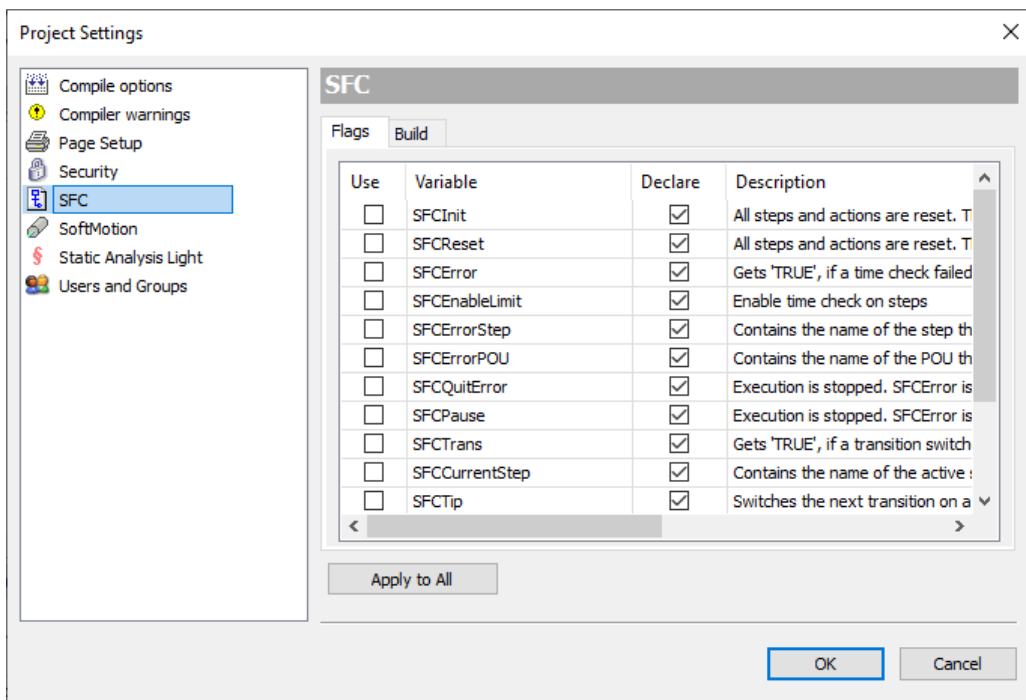

2. In the "Project Settings" dialog box, select the "Static Analysis Light" category.

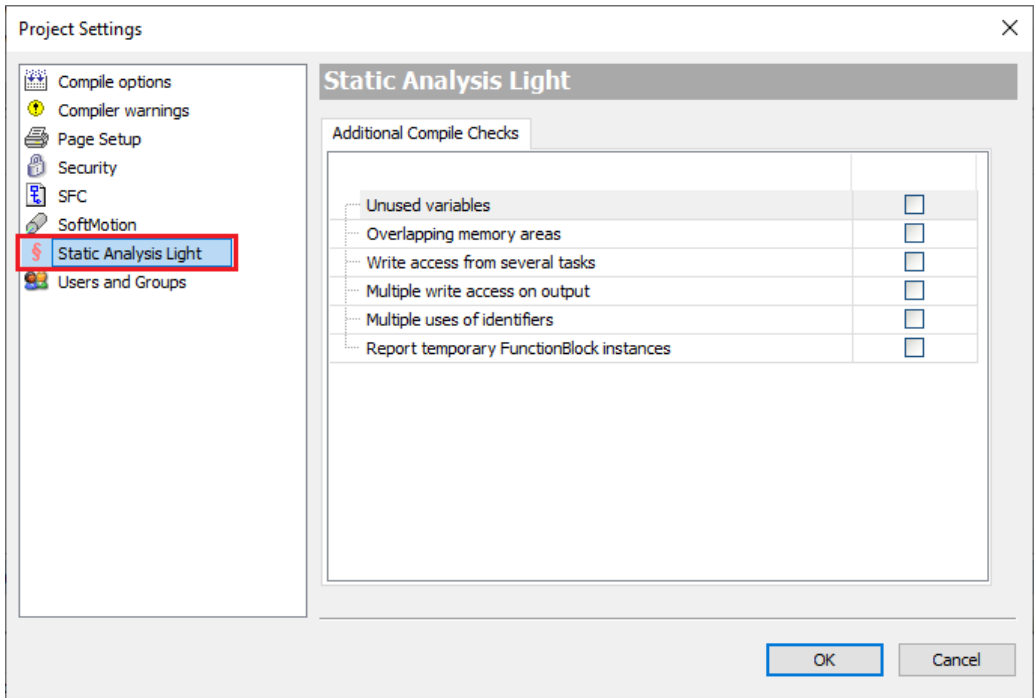

3. Select the check boxes of the items to be checked.

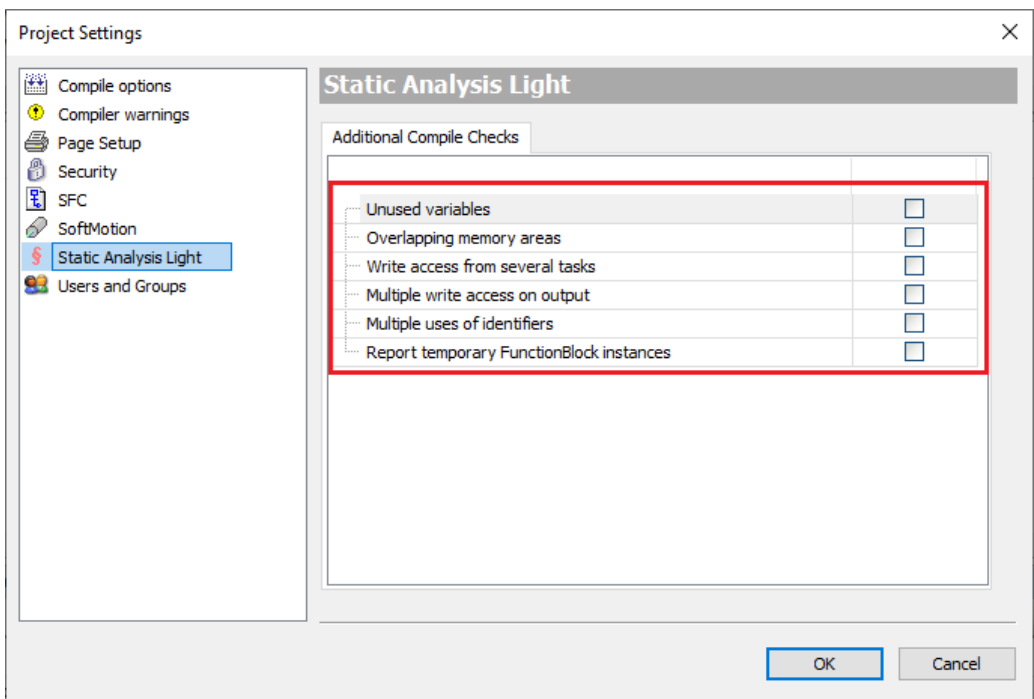

4. Click the [OK] button.

5.10 Program Creation Support Functions

Info.

- If the items to be checked are set beforehand, code analysis will be performed automatically during login.

5.10.10 Displaying Programs in Multiple Languages (Project Localization)

The project localization function allows the user to translate and register comments, titles, and other information in the program to display the translated content in the program window.

1 2 Procedure

1. From the menu bar, select **Project>Project Localization>Create Localization Template**. The "Create Localization Template" dialog box will be displayed.
2. Select information to be translated.
To translate comments and titles in a program, select the "Comments" check box.
To add location information to a template, select "First Appearance" or "All" in the Location information drop-down list.

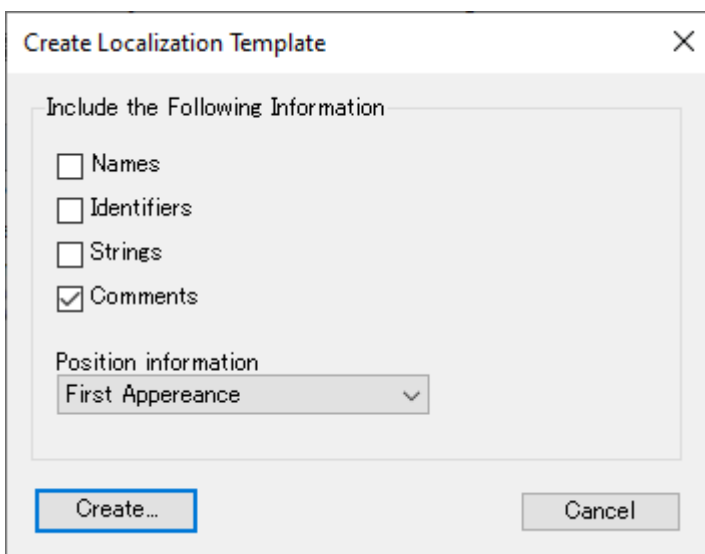

3. Click the [Create] button.
The "Save As" dialog box will be displayed.

5.10 Program Creation Support Functions

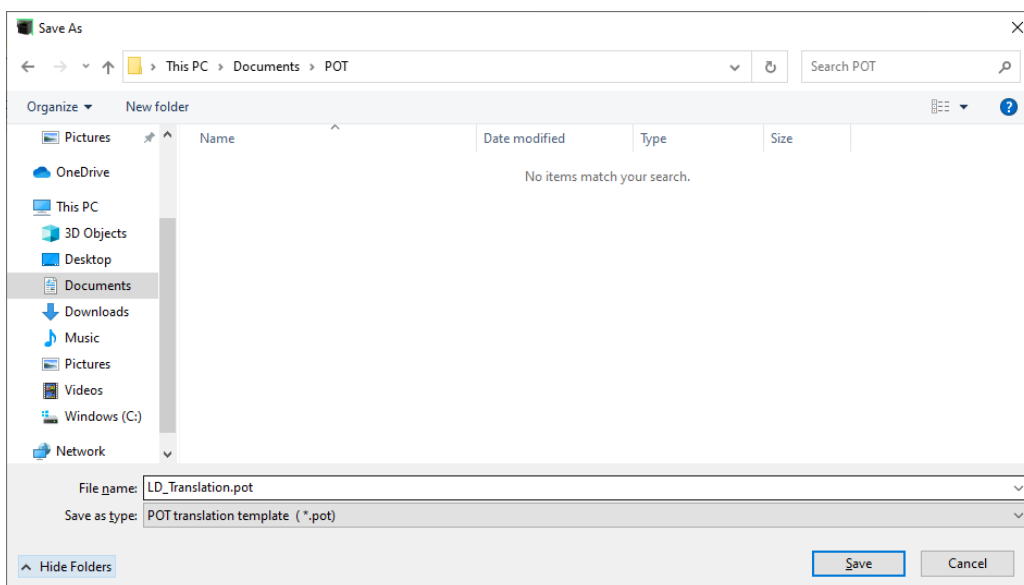

4. Enter a file name and click the Save button.
A POT translation template file (".pot") will be created.
5. For localization, use an editor such as PoEditor to enter translations.
Create a localization file (".po").

Source text — Japanese	Translation — English
// TONの現在時間	// TON Current Time
// 入力X1	// Input X1
自己保持回路	Self-holding circuit
TONファンクションブロックの実行	Execute TON FunctionBlock

6. From the menu bar, select **Project>Project Localization>Manage Localizations**.
The "Manage Localizations" dialog box will be displayed.
7. Click the [Add] button.
The "Open Localization File" dialog box will be displayed. Select a localization file (".po") that has been created.
The added localization file will be displayed in the "Available Localizations" area.

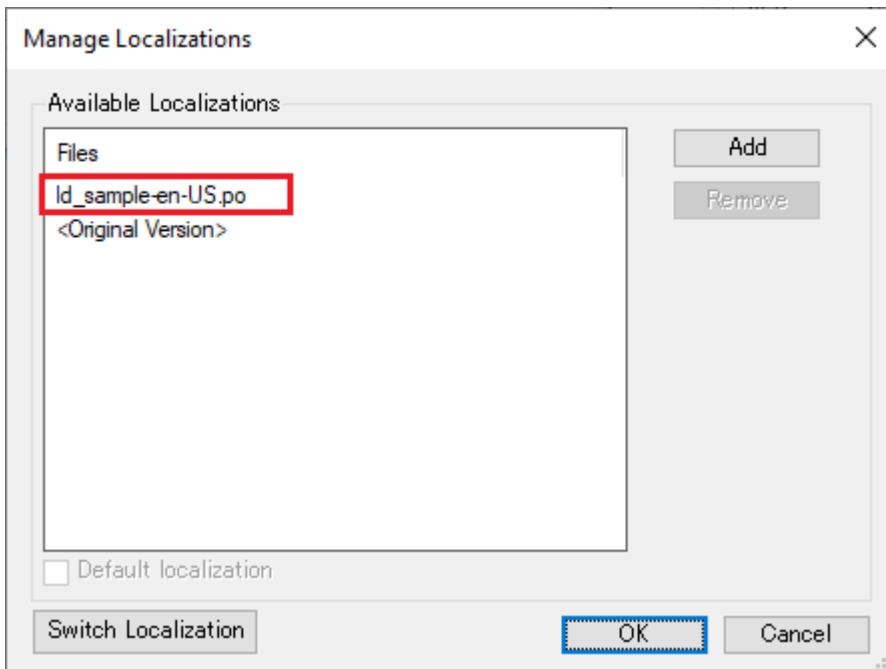

8. Click the [OK] button.

The "Manage Localizations" dialog box will be closed.

This completes the localization file creation procedure.

Next, the procedure for switching the display is explained below.

9. From the menu bar, select **Project>Project Localization>Switch Localization**.

Symbol comments and title comments will be displayed according to the translations in the added localization file.

To return the display to its original state, select "Switch Localization" again.

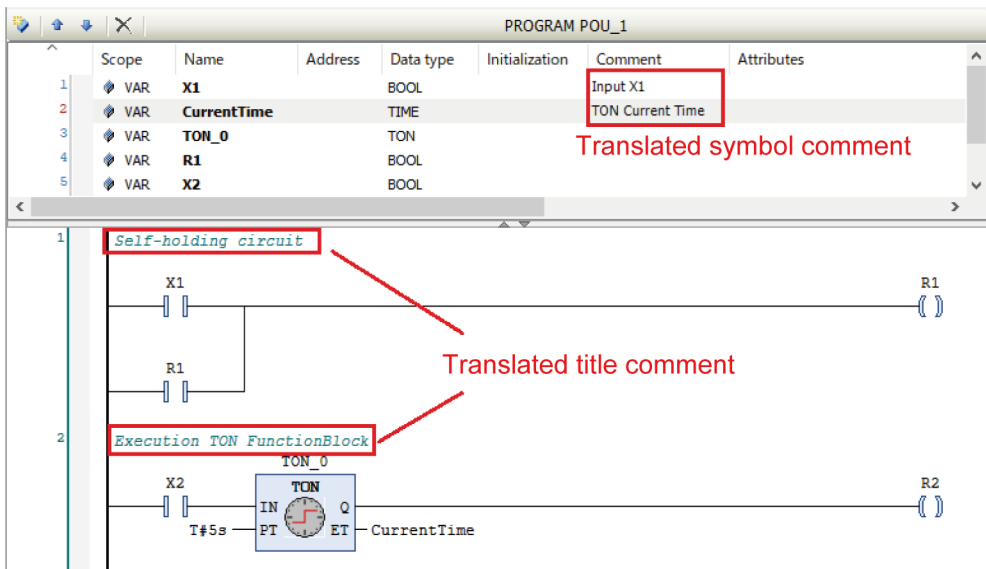

5.10 Program Creation Support Functions

Info.

- You can also switch the localization file by clicking  on the toolbar.

5.10.11 Start Instruction Help Function

The start instruction help function can be used to check the functions of instructions supported by the GM1 controller.

1 2 Procedure

1. Click an instruction.
For LD

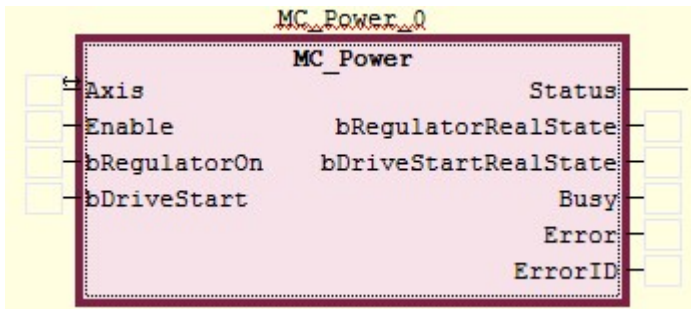

For ST

```

1  MC Power 1(
2      Axis:= ,
3      Enable:= ,
4      bRegulatorOn:= ,
5      bDriveStart:= ,
6      Status=> ,
7      bRegulatorRealState=> ,
8      bDriveStartRealState=> ,
9      Busy=> ,
10     Error=> ,
11     ErrorID=> );
12

```

2. Press the "Ctrl + F1" keys.
You can check the description of the selected instruction.

5.10 Program Creation Support Functions

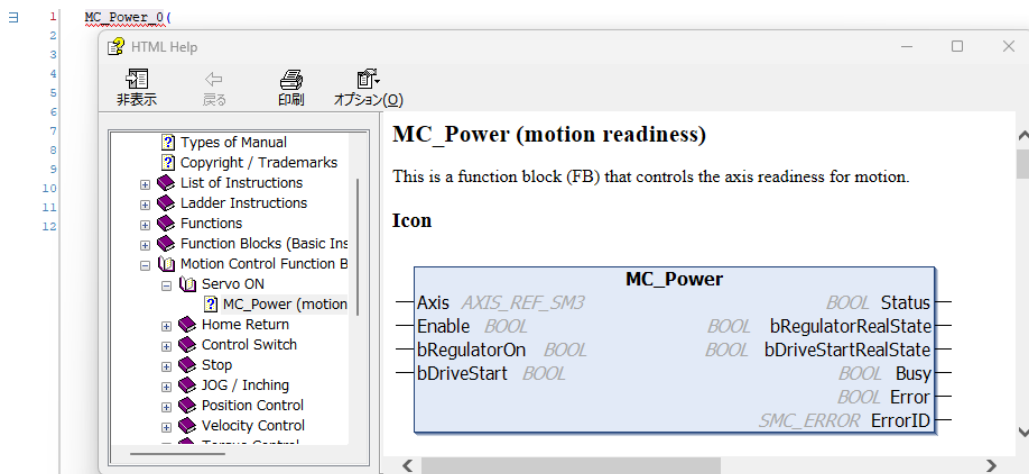

i Info.

- The GM1 controller references the *GM1 Series Reference Manual (Instruction Edition)* to display the help contents of instructions.
- The "start instruction help function" can also be activated by selecting a structure and then following the above steps.

6 Entering programs in each Programming language and Variable

6.1	Programming in Ladder Diagram (LD)	6-2
6.1.1	Inserting Contacts, Coils, and Function Blocks	6-2
6.1.2	Inserting Contacts in Parallel	6-7
6.1.3	Inserting a Network (Circuit)	6-9
6.1.4	Inserting a Branch	6-10
6.1.5	Input of Title and Comment (LD)	6-11
6.1.6	Commenting out a Network (Circuit)	6-13
6.2	Programming in Structured Text (ST)	6-14
6.2.1	ST Program Syntax	6-14
6.2.2	Commenting out Code in ST Program	6-16
6.3	Programming in Sequential Function Chart (SFC)	6-18
6.3.1	Inserting Elements from Menu	6-18
6.3.2	Inserting Elements from Toolbox	6-20
6.3.3	Inserting Elements from Toolbar	6-22
6.3.4	Setting up the SFC Editor	6-23
6.3.5	Setting SFC Program Execution Conditions	6-25
6.4	Programming in Function Block Diagram (FBD)	6-27
6.4.1	Entering Function Blocks	6-27
6.4.2	Inserting and Commenting out a Network (Circuit)	6-32
6.4.3	Input of Title and Comment (FBD)	6-32
6.4.4	Settings in FBD Program	6-33
6.5	Programming in Instruction List (IL)	6-34
6.5.1	Entering Instructions and Operands	6-34
6.5.2	Settings in IL Program	6-37
6.6	Programming in Continuous Function Chart (CFC)	6-38
6.6.1	Inserting and Connecting Elements	6-39
6.6.2	Connection Mark	6-43
6.7	Variables	6-44
6.7.1	Standard Data Types	6-44
6.7.2	STRING type	6-45
6.7.3	WSTRING type	6-45
6.7.4	Array	6-46
6.7.5	Subrange Types	6-47
6.7.6	Structure, Enumeration, Alias, and Union Data Types	6-48
6.7.7	Constants	6-52
6.7.8	Object for Global Variable Declaration	6-53
6.7.9	Global Variables	6-54
6.7.10	Persistent Variables	6-56

6.1 Programming in Ladder Diagram (LD)

6.1 Programming in Ladder Diagram (LD)

This section explains how to create programs (LD programs) in Ladder Diagram compliant with IEC 61131-3, the international standard for PLC programming languages.

To create LD programs, POU objects for LD programs are required. Set the object setup language to Ladder Diagram (LD).

6.1.1 Inserting Contacts, Coils, and Function Blocks

This section explains how to create an LD program that consists of the normally open contact, coil, and function block TON shown below.

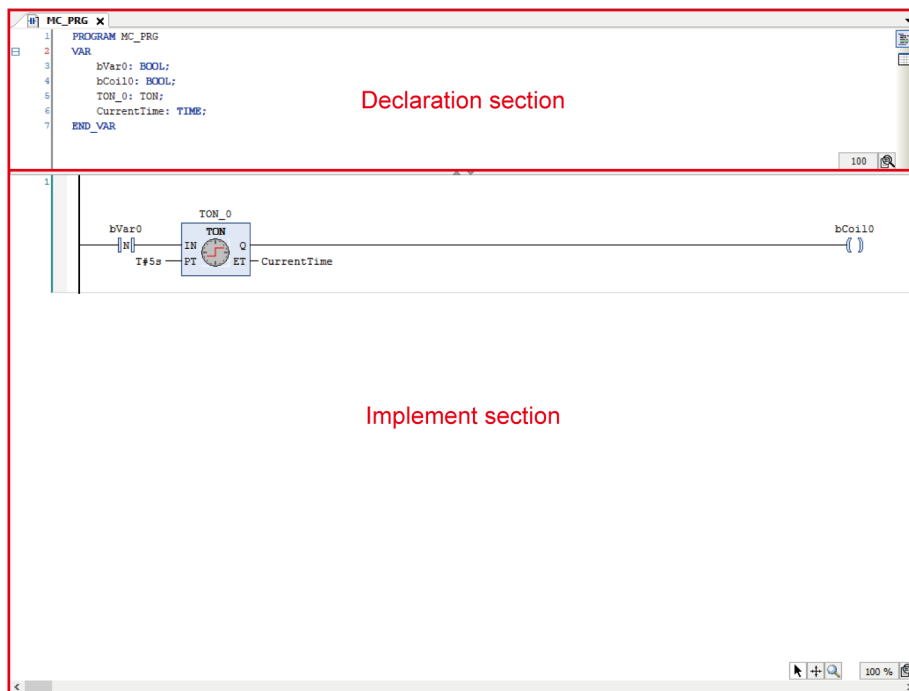

12

Procedure

1. In Toolbox, select **Ladder elements>Contact** and drag the mouse until "Start here" is displayed in the main pane.
"Start here" will be displayed in the implementation section.



When you drag the mouse until the position of "Start here" is reached, the display of "Start here" turns green.



When you stop dragging the mouse at the position of "Start here", a normally open contact will be placed in the network (circuit).



i Info.

- You can also insert a normally open contact in the network (circuit) using the following procedure:
 - Right-click in the network (circuit) and select "Insert Contact" from the context-sensitive menu that is displayed.
 - Click the ****** icon on the toolbar.
 - From the menu bar, select **FBD/LD/IL>Insert Contact**.
 - Press the <Ctrl> key + <k> key simultaneously.
- Select "???" of the normally open contact and enter variable bVar0, and then press the <Enter> key.

The "Auto Declare" dialog box will be displayed.

- Click the [OK] button.
Variable bVar0 will be declared in the declaration section.

6.1 Programming in Ladder Diagram (LD)



4. In Toolbox, select **Ladder elements>Coil** and drag the mouse until "Add output or jump here" is displayed in the main pane.

When you drag the mouse until the position of "Add output or jump here" is reached, the display of "Add output or jump here" turns green.

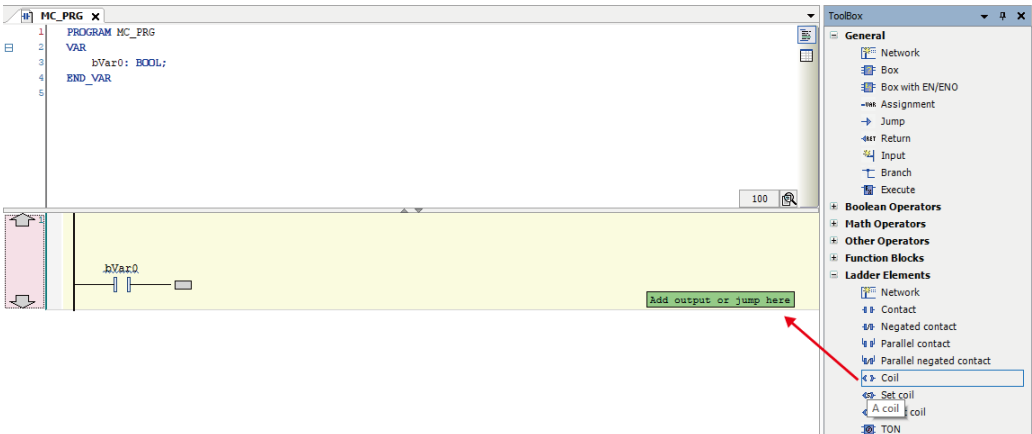

When you stop dragging the mouse at the position of "Add output or jump here", a coil will be placed in the network (circuit).



5. Select "???" of the coil and enter variable bCoil0, and then press the <Enter> key.

The "Auto Declare" dialog box will be displayed.

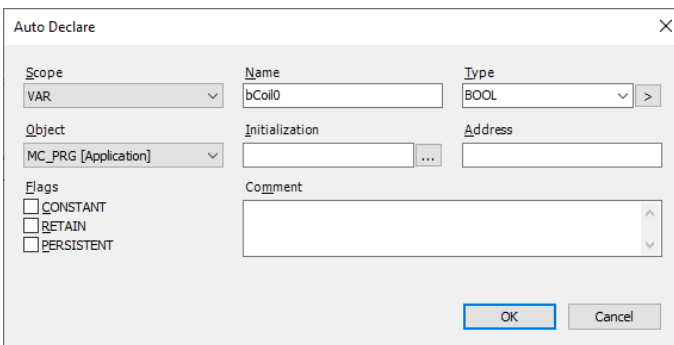

6. Click the [OK] button.

Variable bCoil0 will be declared in the declaration section.

6.1 Programming in Ladder Diagram (LD)



7. In Toolbox, select **Function block>TON** and drag the mouse until  is displayed in the main pane. Function block TON will be displayed.

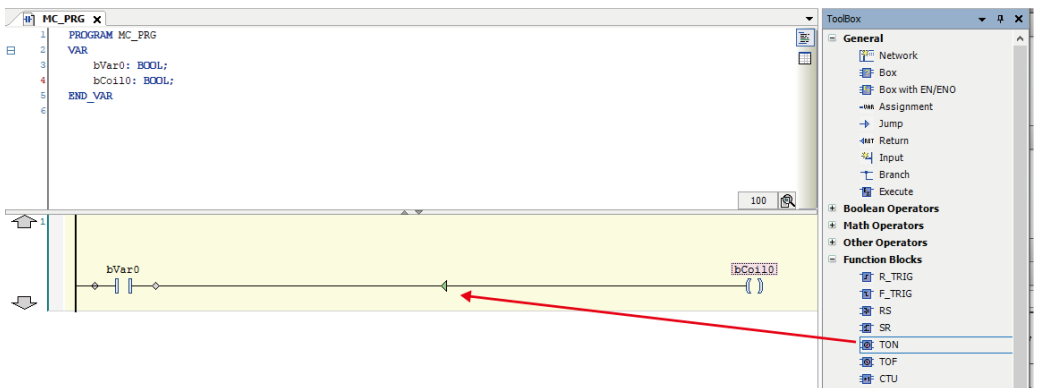

TON will be placed in the implementation section.

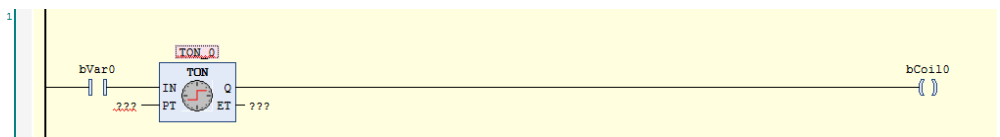

8. Select TON and enter a variable name, and then press the <Enter> key. The "Auto Declare" dialog box for TON will be displayed.

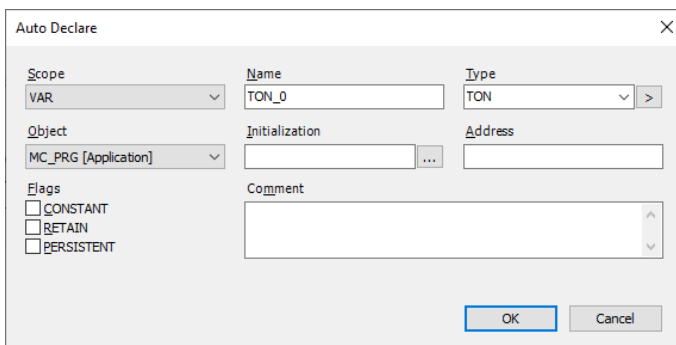

9. Click the [OK] button. The name of TON will be declared as variable TON_0.

6.1 Programming in Ladder Diagram (LD)



10. Enter "T#5s" for input PT ("IN PT") and "CurrentTime" for output ET ("O ET"), as shown below.



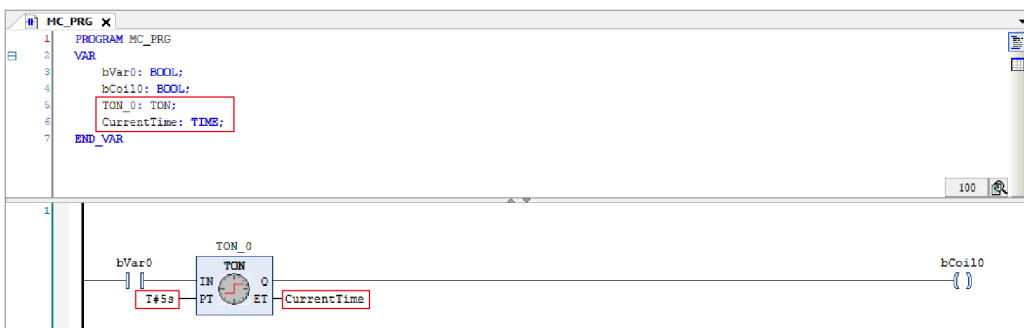

In the declaration section, declare "CurrentTime" as a TIME type variable.



This completes insertion of a normally open contact, coil, and function block TON.

The network (circuit) is now complete.

i Info.

- To remove an element that has been placed, select the element and press the <Delete> key. You can also remove an element by right-clicking the element and selecting "Delete" from the context-sensitive menu that is displayed.
- The normally open contact that is placed can be set as a normally open contact for detecting a rising edge (). To do so, perform the following procedure with the normally open contact selected.
 - Right-click the normally open contact and select "Edge Detection" from the context-sensitive menu that is displayed.
 - From the menu bar, select **FBD/LD/IL>Edge Detection**.
 - Press the <Ctrl> key + <e> key simultaneously.
 - Click the  icon on the toolbar.If the above procedure is performed one more time, the normally open contact that is placed can be set as a normally open contact for detecting a falling edge ().
- Input to the function block can be negated. To do so, perform the following procedure with the connection line to the input selected.
 - Right-click the function block and select "Negation" from the context-sensitive menu that is displayed.
 - From the menu bar, select **FBD/LD/IL>Negation**.
 - Press the <Ctrl> key + <n> key simultaneously.
 - Click the  icon on the toolbar.A negation mark will be displayed on the left side of the input ("IN").

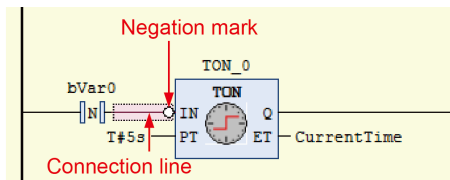

- The LD program can be converted and displayed as an FBD program.
From the menu bar, select **FBD/LD/IL>View** and select a post-conversion programming language.

6.1.2 Inserting Contacts in Parallel

This section explains how to place a contact in parallel with a normally open contact.

In Toolbox, select **Ladder elements>Parallel contact** and drag the mouse until the position of ▼ displayed on the right side of the normally open contact is reached.

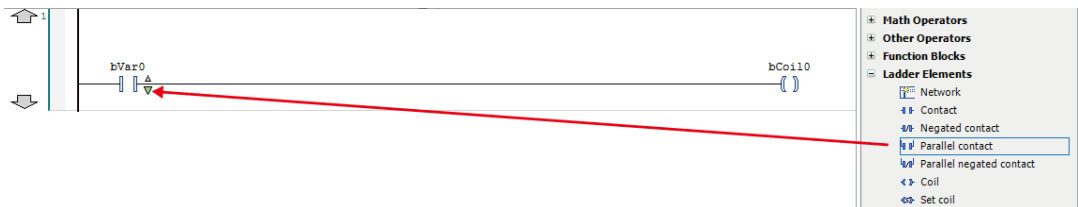

The normally open contacts will be placed in parallel with the other one.



■ Placing a contact in parallel with multiple contacts

The following explains how to place a contact in parallel with multiple contacts.

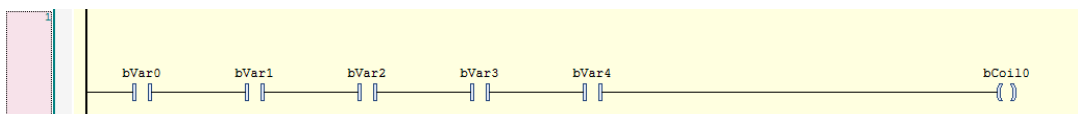

While holding down the <Ctrl> key, select relevant contacts and then right-click.

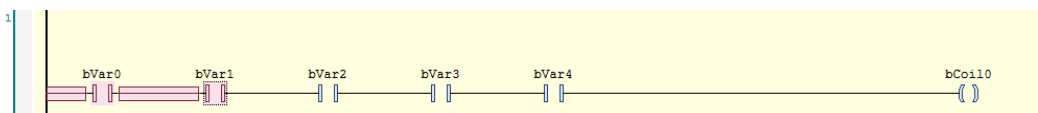

6.1 Programming in Ladder Diagram (LD)

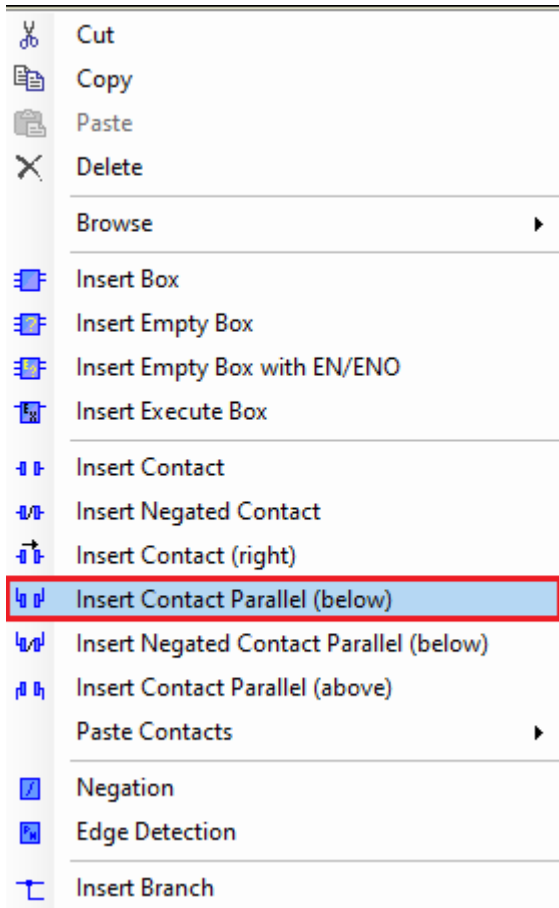

Select "Insert Contact Parallel (below)" from the context-sensitive menu that is displayed. A contact will be placed in parallel with the selected contacts.

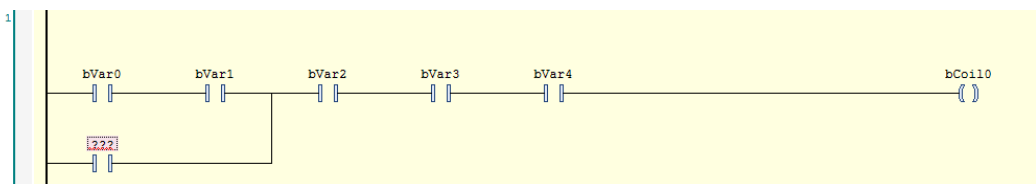

6.1.3 Inserting a Network (Circuit)

This section explains how to insert a new network (circuit).

1 2 Procedure

1. In Toolbox, select **General>Network** and drag the mouse until  displayed in the network (circuit) in the main pane is reached.

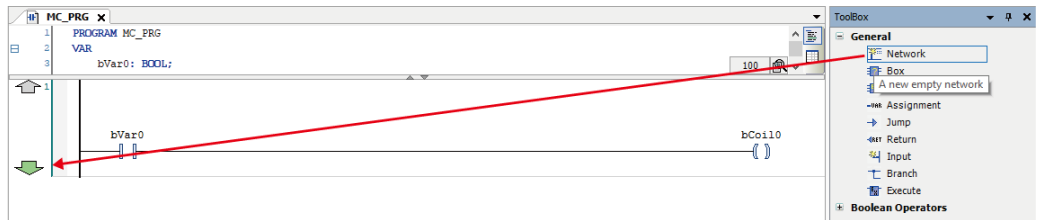

A network (circuit) will be inserted underneath.

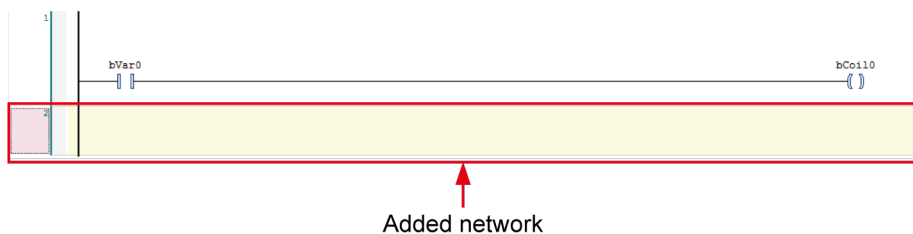

i Info.

- You can also insert a network (circuit) underneath using the following procedure:
 - Right-click in the network (circuit) and select "Insert Network (Below)" from the context-sensitive menu that is displayed.
 - From the menu bar, select **FBD/LD/IL>Insert Network (below)**.
 - Press the <Ctrl> key + <t> key simultaneously.
- To add a network (circuit) above the existing network, in Toolbox, select **General>Network** and drag the mouse until the position of  is reached.

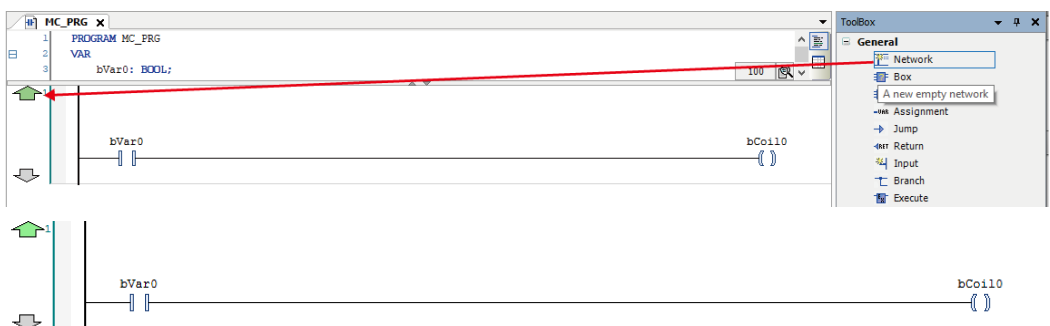

- To remove a network (circuit), select the network (circuit) and press the <Delete> key.

6.1 Programming in Ladder Diagram (LD)

6.1.4 Inserting a Branch

This section explains how to add a branch by specifying the starting point and end point of the branch.

Example: Creating a branch in the following network (circuit) that extends from a point between contacts bVar1 and bVar2 to a point between contacts bVar3 and bVar4

1 Procedure

1. In Toolbox, select **Ladder elements>Branch Start/End** and drag the mouse until  displayed on the right side of contact bVar1 in the main pane is reached.

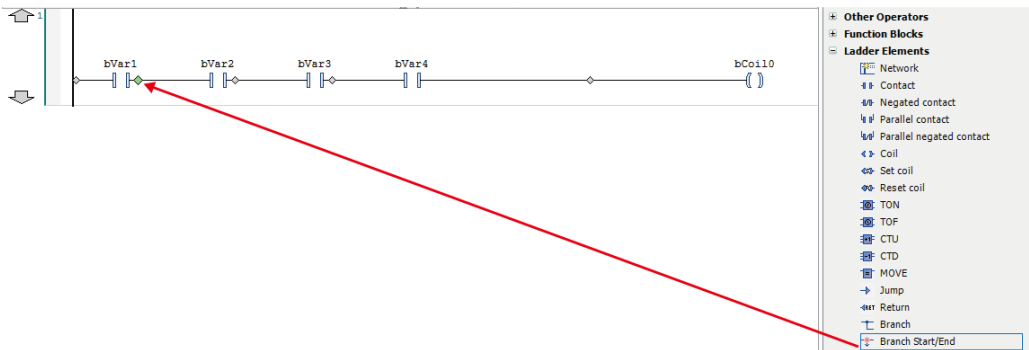

When you stop dragging the mouse, a red square mark indicating the starting point of a branch is displayed between contacts bVar1 and bVar2. Blue square marks indicate candidates for the end point of the branch.

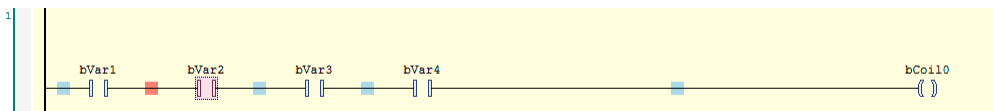

2. Click the blue square mark between contacts bVar3 and bVar4. A branch that extends from the point between contacts bVar1 and bVar2 to the point between contacts bVar3 and bVar4 will be inserted.

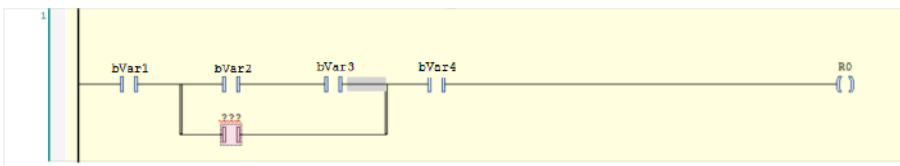

6.1.5 Input of Title and Comment (LD)

The Ladder Diagram programming language allows the user to enter the following four types of titles and comments.

Display examples of titles and comments are shown below.

```

1  PROGRAM POU_1
2  VAR
3  // X0 symbol comment
4  X0: BOOL;
5  // R0 symbol comment
6  R0: BOOL;
7  // TON_0 symbol comment
8  TON_0: TON;
9  //CurrentTime
10 //symbol comment
11 CurrentTime: TIME;
12 END_VAR
13

```

The ladder diagram shows a network with the following elements and comments:

- Network title:** Network title
- Network comment:** Network comment
- Operands:** X0 (with comment X0 operand comment), TON_0 (with comment TON_0 operand comment), R0 (with comment R0 operand comment).
- TON_0 Block:** IN, Q, PT (T#5s), ET (CurrentTime).
- Comments:** X0 symbol comment, TON_0 symbol comment, R0 symbol comment, CurrentTime symbol comment.

No.	Item	Description
(1)	Symbol comment	This is a comment on a declared variable. The same comment is displayed for the same variable. Enter a comment on a variable in the declaration section. The comment will be displayed in a cell with a black background.
(2)	Network title (circuit title)	A title can be assigned to each network (circuit). Click the top left of the network (circuit) and enter a title.
(3)	Network comment (circuit comment)	A comment can be assigned to each network (circuit). Click the top left of the network (circuit) and enter a comment.
(4)	Operand comment	This is a comment on a variable. Different comments can be assigned to the same variable. Click a position above each variable in the implementation section and enter a comment.

To display titles and comments, you must configure settings.

Open the Options window (by selecting **Tools>Options**), select the "FBD, LD, and IL editors" category and then the General tag, and select the items to be displayed in the Display section.

6.1 Programming in Ladder Diagram (LD)

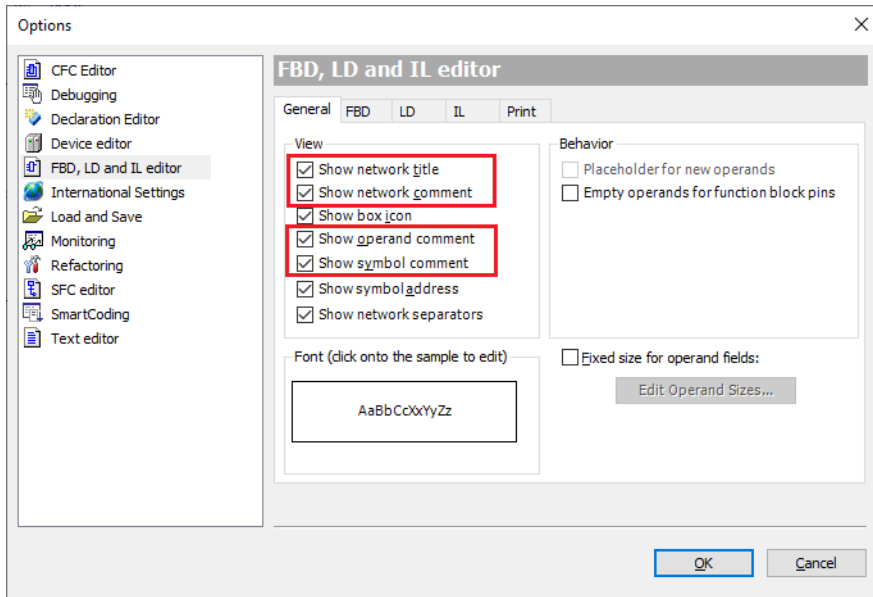

Info.

- Titles and comments can be displayed as those translated in a particular language beforehand. For details, refer to "[5.10.10 Displaying Programs in Multiple Languages \(Project Localization\)](#)".

6.1.6 Commenting out a Network (Circuit)

Networks (circuits) can be commented out. A network (circuit) that is commented out cannot be executed.

1 2 Procedure

1. Select a network (circuit) to be commented out.



2. Click the  icon (Toggle Network Comment State) on the toolbar. The network (circuit) will be commented out. To cancel the comment-out state, perform the same operation again.

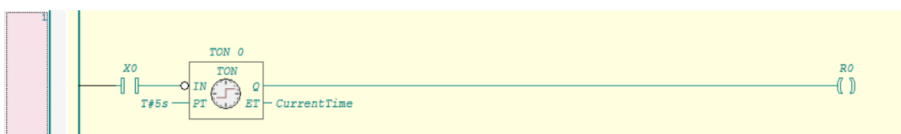

Info.

- You can also comment out the selected network (circuit) using the following procedure:
 - Right-click in the network (circuit) and select "Toggle network comment state" from the context-sensitive menu that is displayed.
 - From the menu bar, select **FBD/LD/IL>Toggle network comment state**.
 - Press the <Ctrl> key + <o> key simultaneously.

6.2 Programming in Structured Text (ST)

6.2 Programming in Structured Text (ST)

This section explains how to create programs (ST programs) in Structured Text compliant with IEC 61131-3, the international standard for PLC programming languages.

- To create ST programs, POU objects for ST programs are required. Set the object setup language to Structured Text (ST).
- An ST program is made up by combining expressions and instructions. Expressions and instructions can also be executed under certain conditions or within a loop. Each instruction must end with a semicolon (;).

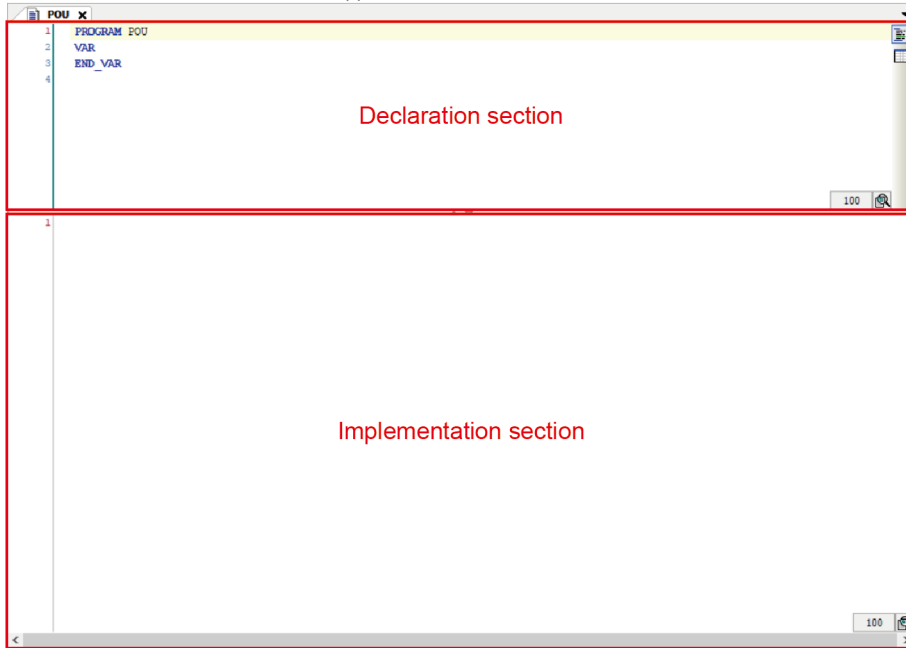

6.2.1 ST Program Syntax

For ST programs, the following syntax can be used.

Item	Example
Assignment statement	The value of the right side is set on the left side. Example: iVar1 := 4;
Set assignment statement	If the value of the right side is judged to be TRUE, TRUE will be set on the left side. Once the value of the left side is judged to be TRUE, the left side will maintain TRUE even if the value of the right side is judged to be FALSE. Do not leave any spaces between "S" and "=". Example: bVar0S=bVar1;
Reset assignment statement	If the value of the right side is judged to be TRUE, FALSE will be set on the left side. Once the value of the left side is judged to be FALSE, the left side will maintain FALSE even if the value of the right side is judged to be FALSE. Do not leave any spaces between "R" and "=".

6.2 Programming in Structured Text (ST)

Item	Example
	Example: bVar0R=bVar1;
IF instruction	Conditions are judged and subordinate instructions are executed according to the judgment result. Example: IF (iVar0 = 4) THEN iVar1 := 5; ELSIF (iVar0 = 7) THEN iVar1 := 10; ELSE iVar1 := 15; END_IF;
FOR instruction	Subordinate instructions are executed repeatedly the specified number of times. Example: FOR iVar0 := 1 TO 10 BY 1 DO iVar1 := iVar1 + 1; END_FOR;
WHILE instruction	Conditions are judged and subordinate instructions are executed repeatedly as long as the conditions are satisfied. Example: WHILE (iVar0 <> 0) DO iVar1 := iVar1 * 2; END_WHILE;
CASE instruction	Conditions are judged and subordinate instructions are executed according to the judgment result. Example: CASE iVar0 OF 1 : iVar1 := iVar1 / 2; 2 : iVar1 := iVar1 / 4; ELSE iVar1 := iVar1 / 8; END_CASE;
REPEAT instruction	Conditions are judged and subordinate instructions are executed repeatedly as long as the conditions are satisfied. Example: REPEAT iVar0 := iVar0 + 1; UNTIL iVar0 = 100 END_REPEAT;
EXIT instruction	The EXIT instruction is used to terminate a loop within the FOR, WHILE, or REPEAT instruction.
RETURN instruction	The RETURN instruction is used to terminate a program organization unit (POU). Instructions within POU's following the RETURN instruction will not be executed.
JMP instruction	The JMP instruction is used to unconditionally move control to the line indicated by the JMP label. Example:

6.2 Programming in Structured Text (ST)

Item	Example
	<pre>iVar0 := 0; Label1 : iVar0 := iVar0 + 1; IF (iVar1 = 5) THEN JMP Label1; END_IF;</pre>
CONTINUE instruction	The CONTINUE instruction is used to move control to the beginning of the loop within the FOR, WHILE, or REPEAT instruction.

i Info.

- Entered keywords are converted to uppercase letters automatically (AutoFormat). To disable this function, clear the "Convert keywords to uppercase automatically (AutoFormat)" check box in the Options window.

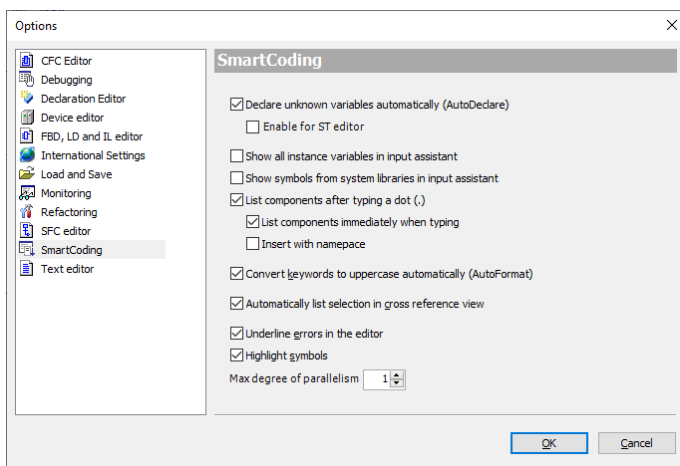

6.2.2 Commenting out Code in ST Program

In ST programs, code can be commented out. Program code that is commented out cannot be executed.

Comment type	Description
Single line	<p>Program code from // to the end of the line is treated as a comment.</p> <p>Example:</p> <pre>bVar1 := 2; // Single-line comment</pre>
Multiple lines	<p>Program code from (* to *) is treated as a comment. (**) can also be inserted into another comment enclosed between (* and *).</p> <p>Example:</p> <pre>(* Multiple-line comment 1 Multiple-line comment 2 *)</pre>

Example: Single-line and multiple-line comments

```
1 X1 := 2; //Single line comment
2 (*
3 Multi-line comment 1
4 Multi-line comment 2
5 *)
6
```

6.3 Programming in Sequential Function Chart (SFC)

6.3 Programming in Sequential Function Chart (SFC)

This section explains how to create programs (SFC programs) in Sequential Function Chart compliant with IEC 61131-3, the international standard for PLC programming languages.

- To create SFC programs, POU objects for SFC programs are required. Set the object setup language to Sequential Function Chart (SFC).
- The SFC program editor is divided into the declaration section and implementation section. Three elements are originally coded in the implementation section.

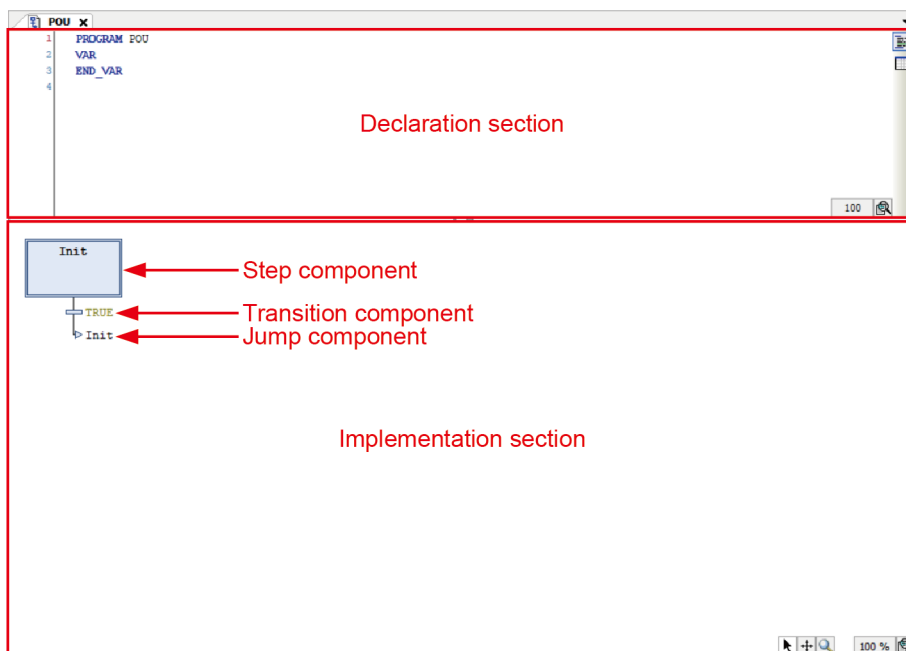

6.3.1 Inserting Elements from Menu

For example, step elements and transition elements can be inserted from the menu, as below.

1 2 Procedure

1. Select the TRUE transition element in the implementation section. The selected transition element will turn red.

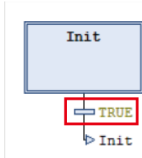

2. Click the right mouse button and select "Insert Step-transition After" from the context-sensitive menu that is displayed.

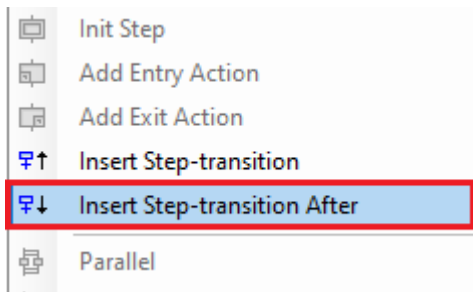

"Step0" step element and "Trans0" transition element will be inserted below the TRUE element.

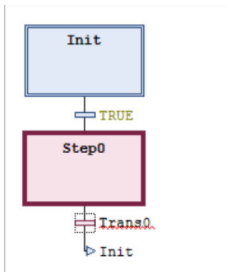

3. Select the "Trans0" element.

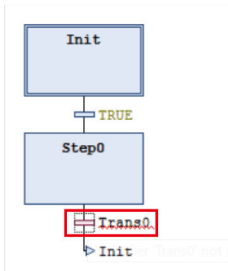

4. Click the right mouse button and select "Insert Step-transition" from the context-sensitive menu that is displayed.

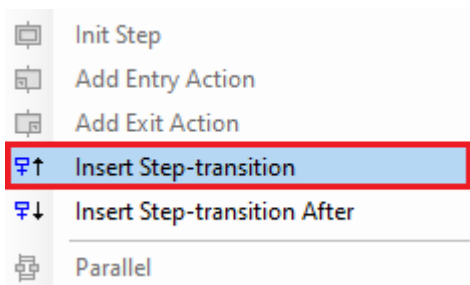

"Step1" step element and "Trans1" transition element will be inserted above the "Trans0" transition element.

6.3 Programming in Sequential Function Chart (SFC)

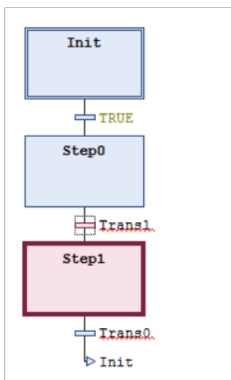

6.3.2 Inserting Elements from Toolbox

Each element can be inserted from Toolbox.

This section explains the procedure for inserting elements from Toolbox, using a step element as an example.

1 Procedure

1. In Toolbox, select "Step" and then drag the step element to the position where you want to insert it.

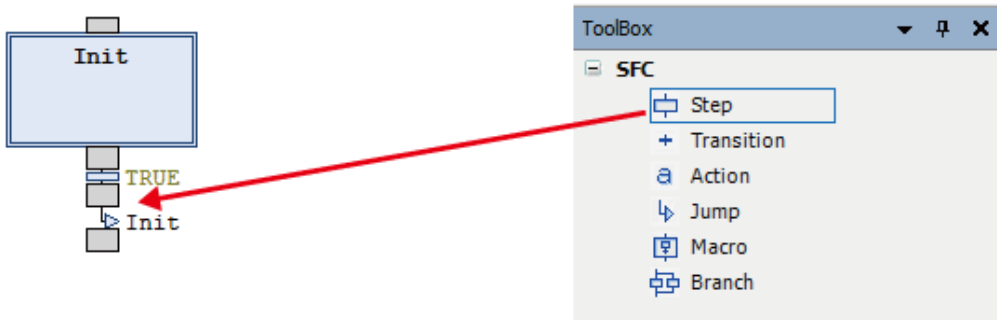

When you drag the step element to the insertion position, the step element is transformed into  .

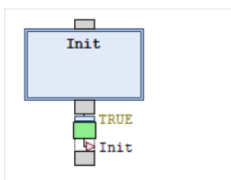

2. Stop dragging the mouse.
The step element will be inserted.

6.3 Programming in Sequential Function Chart (SFC)

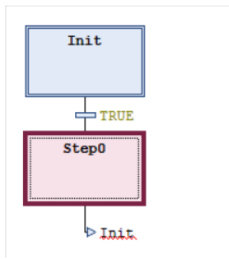

6.3 Programming in Sequential Function Chart (SFC)

6.3.3 Inserting Elements from Toolbar

For example, step elements and transition elements can be inserted from the toolbar, as below.

1 2 Procedure

1. Select the TRUE transition element in the implementation section.
The selected transition element will turn red.

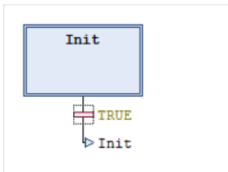

2. Click the  icon ("Insert Step-transition After") on the toolbar.
"Step0" step element and "Trans0" transition element will be inserted below the TRUE element.

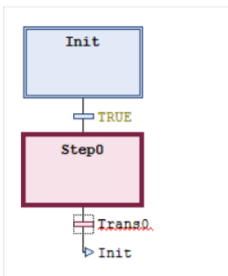

3. Select the "Trans0" transition element and click the  icon ("Insert Step-transition") on the toolbar.
"Step1" step element and "Trans1" transition element will be inserted above the "Trans0" transition element.

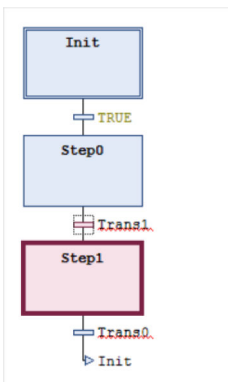

6.3.4 Setting up the SFC Editor

For SFC editor elements, you can change step specifications, fonts, and other settings. From the menu bar, select **Tools>Options** to open the "Options" dialog box. In the "Options" dialog box, select the "SFC editor" category and change the settings.

Layout

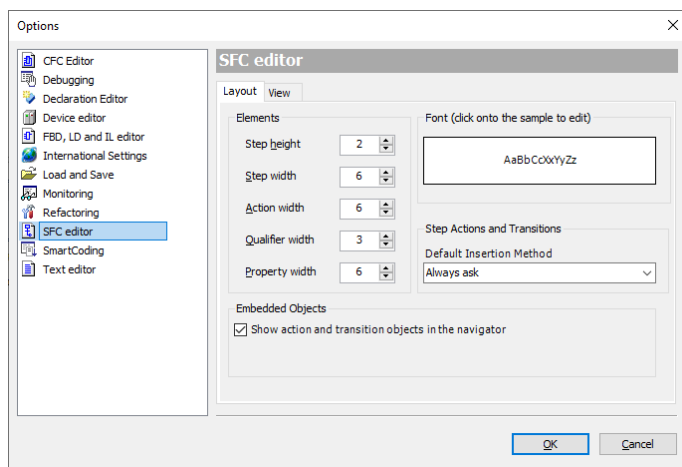

Item name	Default value	Function
Elements	Step height	2 Sets the height of a step. Setting range: 1 to 100 matrix units ^(Note 1)
	Step width	6 Sets the width of a step. Setting range: 2 to 100 matrix units ^(Note 1)
	Action width	6 Sets the width of an action. Setting range: 2 to 100 matrix units ^(Note 1)
	Qualifier width	3 Sets the width of a qualifier. Setting range: 2 to 100 matrix units ^(Note 1)
	Property width	6 Sets the width of a property. Setting range: 2 to 100 matrix units ^(Note 1)
Font	-	Sets a font to be displayed on the SFC editor.
Step Actions and Transitions	Always check	<p>Sets the operation to be performed when an action is added to a step.</p> <p>Copy reference: When a step is copied, a link to the step action is also copied. The step that is copied invokes the same action.</p> <p>Copy implementation: The step action of a step that is copied is embedded. A new action object is copied to a new step.</p>

6.3 Programming in Sequential Function Chart (SFC)

Item name	Default value	Function
		Always ask: Which of the above operations is to be executed is checked each time an action is initially added to a step.
Embedded Objects	Show actions and transition objects in navigator pane	Selected Selected: An action that is embedded in a step by "Copy implementation" is displayed in the Device view or POU view. Cleared: An action that is embedded in a step by "Copy implementation" is not displayed in the Device view or POU view.

(Note 1) "1 matrix unit" is equal to the font size specified in Font in **Options>Text editor>Text area** tab.

View

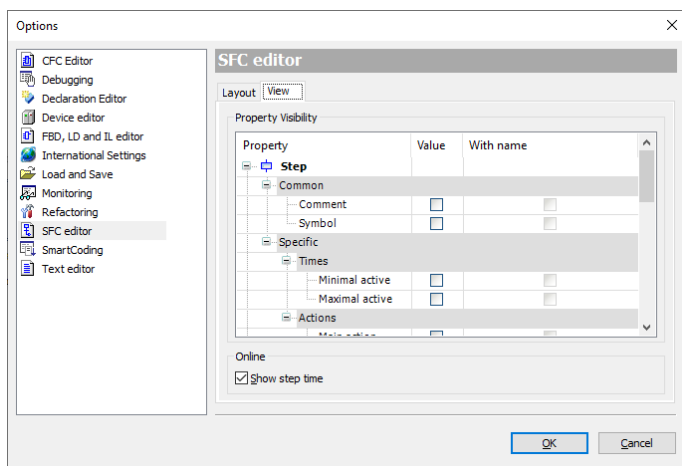

Item name	Default value	Settings
Property Visibility	Cleared	Specifies whether to display property values and names beside steps, etc. Selected: Displays property values and names Canceled: Does not display property values or names
Online	Display step time	Selected Specifies whether to display step active time beside the step in online mode Selected: Displays active time Cleared: Does not display active time

6.3.5 Setting SFC Program Execution Conditions

■ Setting SFC program execution conditions

For SFC programs within a project, you can specify whether to generate code for variables used to check processing or for active transitions during build.

From the menu bar, select **Project>Project Settings**. In the Project Settings dialog box, select the "SFC" category.

The settings will be applied to all SFC objects.

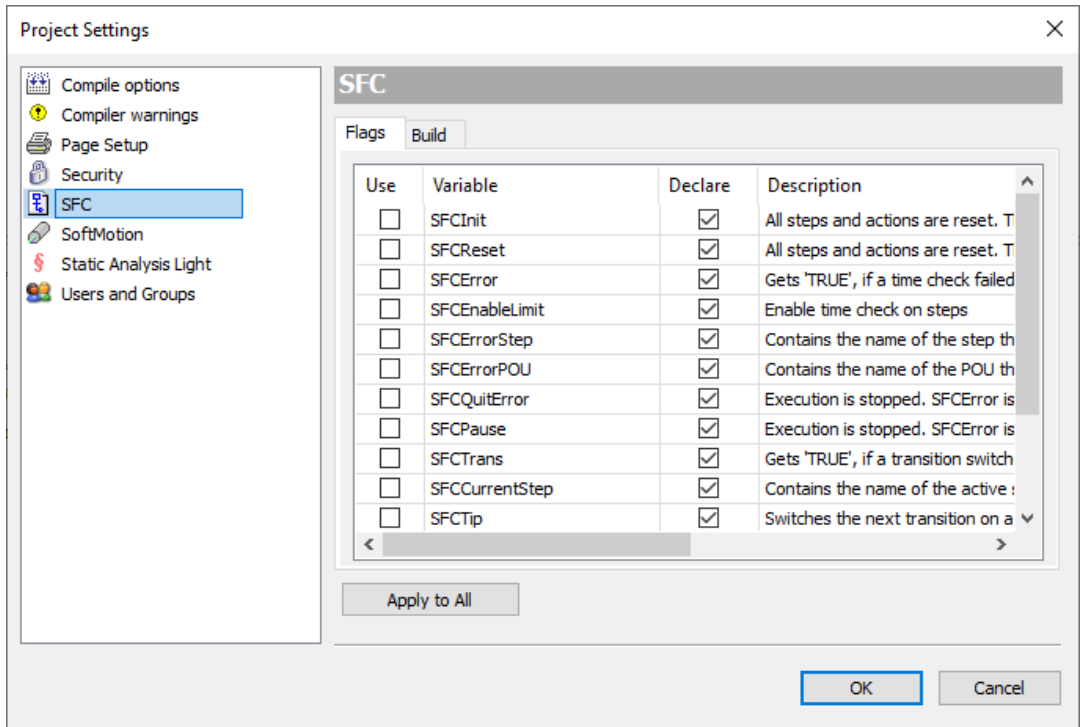

The "Properties" dialog box for SFC objects can be enabled for only particular SFC objects.

Right-click the POU object in the navigator pane and then select "Properties" from the context-sensitive menu that is displayed.

6.3 Programming in Sequential Function Chart (SFC)

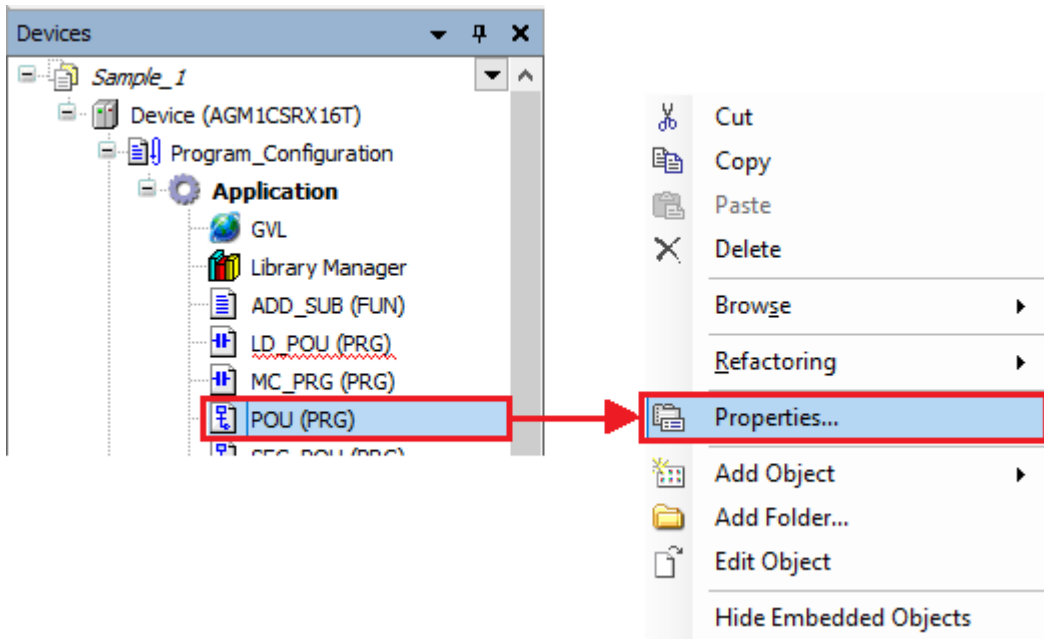

In the "Properties" dialog box, select the "SFC Settings" tab and clear the "Use default" check box.

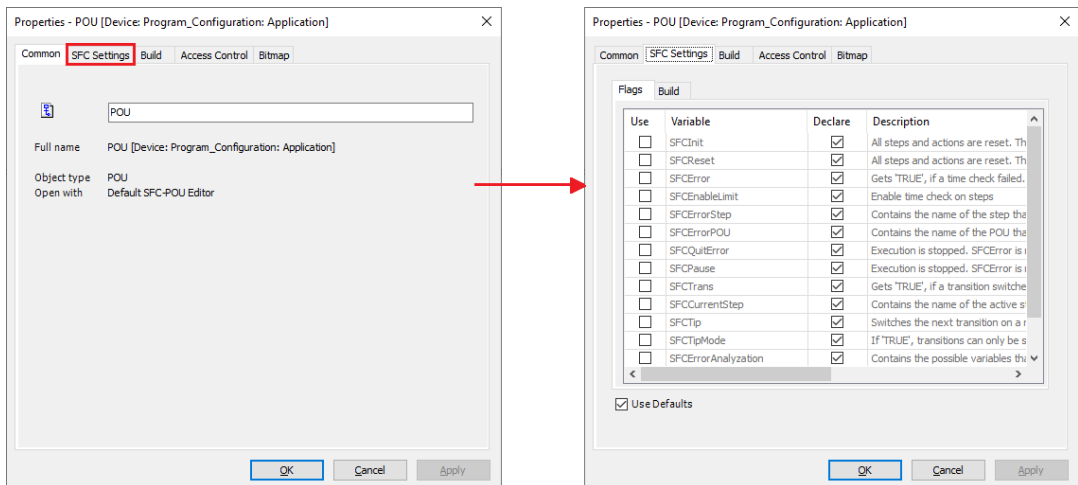

Clearing the check box allows settings to be changed and the Properties dialog box to be enabled for only particular SFC objects.

6.4 Programming in Function Block Diagram (FBD)

This section explains how to create programs (FBD programs) in Function Block Diagram compliant with IEC 61131-3, the international standard for PLC programming languages.

- To create FBD programs, POU objects for FBD programs are required. Set the object setup language to Function Block Diagram (FBD).
- The editor for FBD programs is a window like the one shown below. It consists of the declaration section used to declare variables and the implementation section used to enter program data. Elements can be arranged in the implementation section by selecting them from Toolbox and then dragging and dropping them in the implementation section.

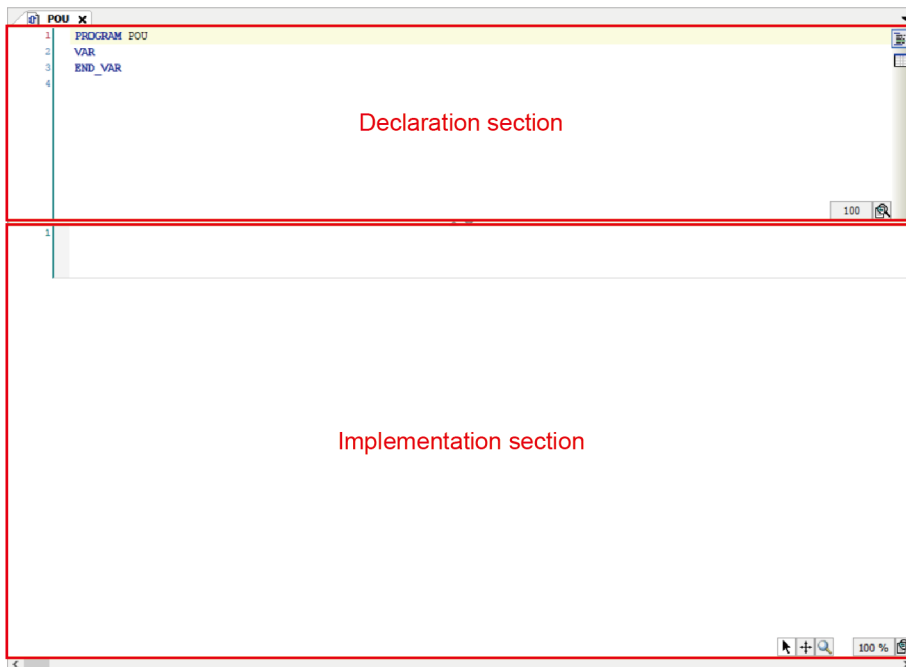

6.4.1 Entering Function Blocks

This section explains the procedure for entering function blocks, using an FBD program consisting of the following variables and function block TON as an example.

6.4 Programming in Function Block Diagram (FBD)

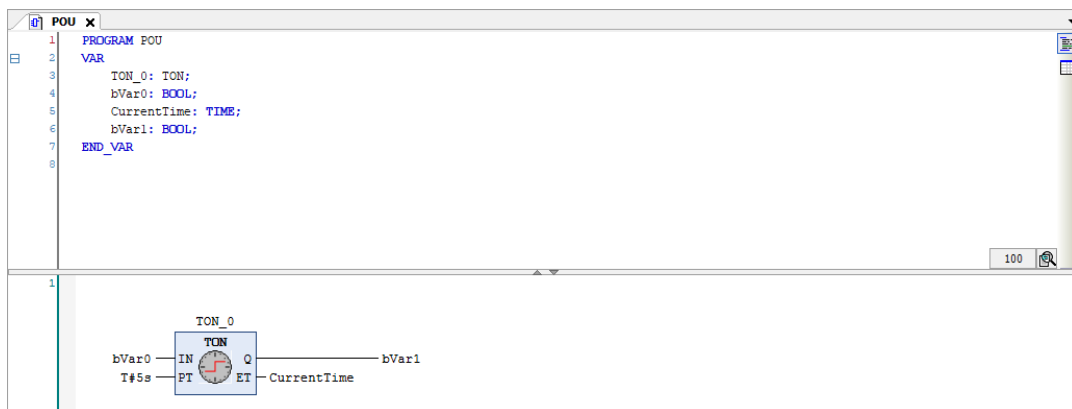

1 2 Procedure

1. In Toolbox, select **Function block>TON** and drag the mouse until the mouse pointer reaches the position where "Start here" is displayed in the implementation section. "Start here" will be displayed in the implementation section.

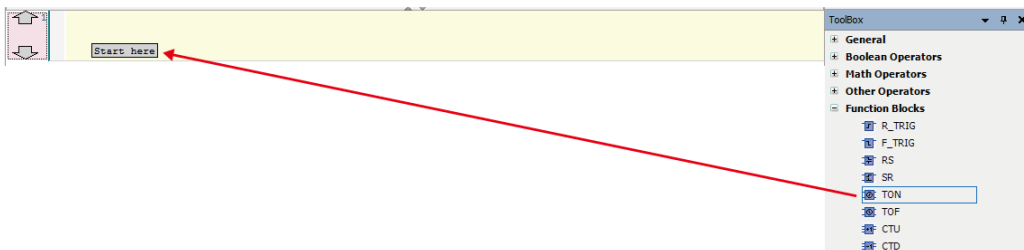

When you drag the mouse until the position of "Start here" is reached, the display of "Start here" turns green.



When you stop dragging the mouse at the position of "Start here", function block TON will be placed in the network (circuit).

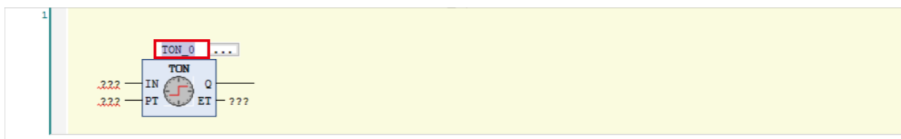

2. Select TON and enter variable TON_0, and then press the <Enter> key. The "Auto Declare" dialog box will be displayed.

6.4 Programming in Function Block Diagram (FBD)

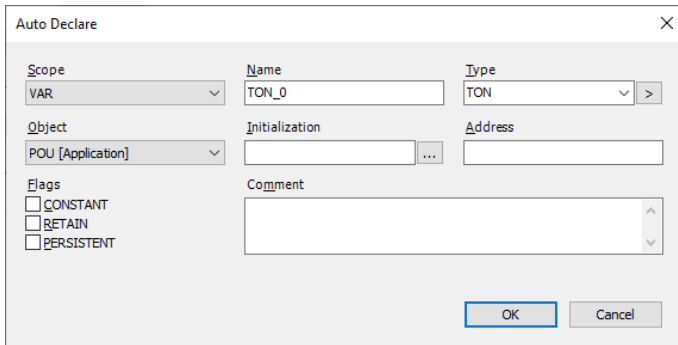

The "Auto Declare" dialog box is shown with the following fields:

Scope	Name	Type
VAR	TON_0	TON

Object: POU [Application]

Initialization: [] ...

Address: []

Flags:

- CONSTANT
- RETAIN
- PERSISTENT

Comment: []

Buttons: OK, Cancel

3. Click the [OK] button.

Instance variable TON_0 for function block TON will be declared in the declaration section.

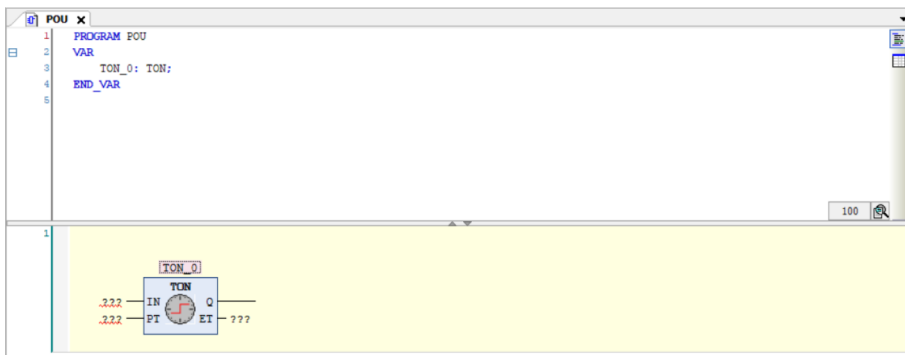

4. Select "???" beside IN of function block TON and enter variable bVar0, and then press the <Enter> key.

The "Auto Declare" dialog box will be displayed.

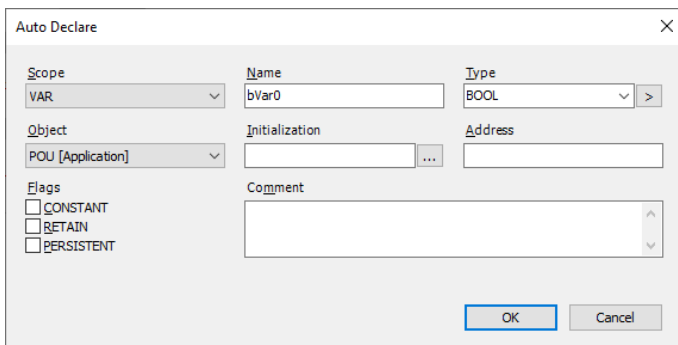

The "Auto Declare" dialog box is shown with the following fields:

Scope	Name	Type
VAR	bVar0	BOOL

Object: POU [Application]

Initialization: [] ...

Address: []

Flags:

- CONSTANT
- RETAIN
- PERSISTENT

Comment: []

Buttons: OK, Cancel

5. Click the [OK] button.

Variable bVar0 will be declared in the declaration section.

6.4 Programming in Function Block Diagram (FBD)



6. In function block TON, enter "T#5s" for input PT ("IN PT") and variable "CurrentTime" for output ET ("O ET").

When "CurrentTime" is entered, the "Auto Declare" dialog box is displayed.

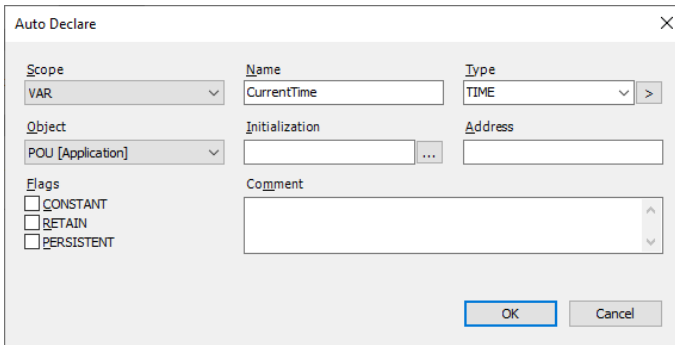

When making a declaration, check that the type is "Time".

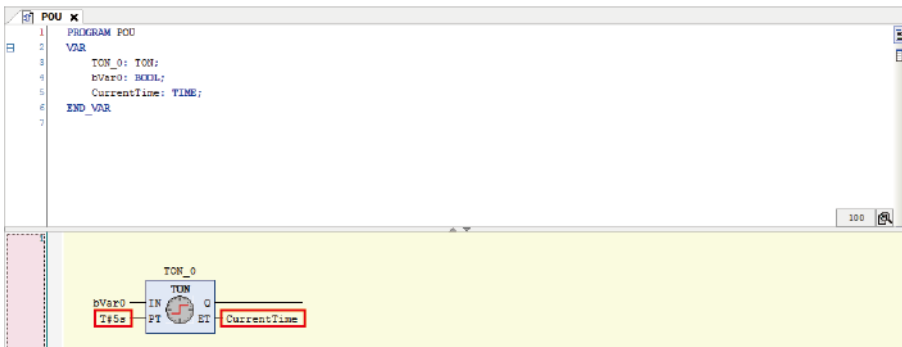

7. In Toolbox, select **General>Assignment** and drag the mouse until a diamond-shaped icon appears on the right side of output "Q" in function block TON.

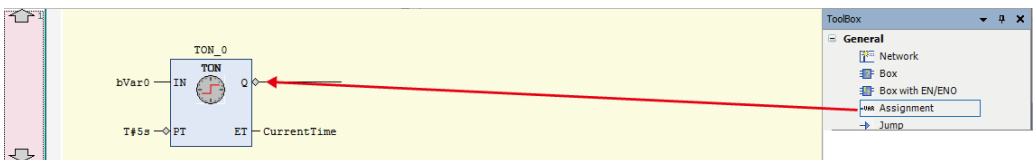

6.4 Programming in Function Block Diagram (FBD)

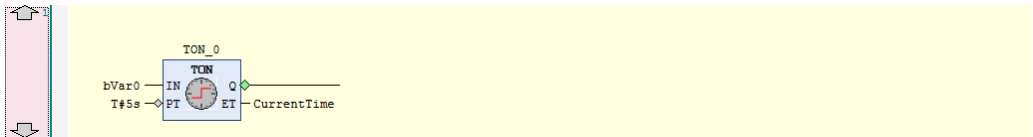

When you stop dragging the mouse, "???" appears on the right side of output "Q".



8. Select "???" on the right side of output "Q" and enter variable bVar1, and then press the <Enter> key.

The "Auto Declare" dialog box will be displayed.

Scope	Name	Type
VAR	bVar1	BOOL

Object	Initialization	Address
POU [Application]		

Flags

CONSTANT

RETAIN

PERSISTENT

Comment

OK Cancel

Declare variable bVar1.

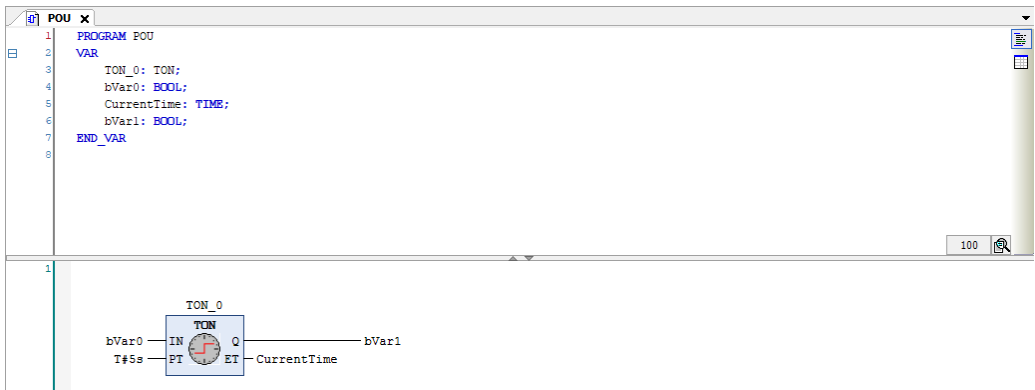

i Info.

- The FBD program can be converted and displayed as an LD program. From the menu bar, select **FBD/LD/IL>View** and select a post-conversion programming language.

6.4 Programming in Function Block Diagram (FBD)

6.4.2 Inserting and Commenting out a Network (Circuit)

The procedure for inserting a new network (circuit) is the same as for LD programs.

Refer to "6.1.3 Inserting a Network (Circuit)".

Networks (circuits) can be commented out. The procedure for commenting out a network (circuit) is the same as for LD programs.

Refer to "6.1.6 Commenting out a Network (Circuit)".

6.4.3 Input of Title and Comment (FBD)

In FBD programs, titles and comments can be entered in the same way as for LD programs.

Refer to "6.1.5 Input of Title and Comment (LD)".

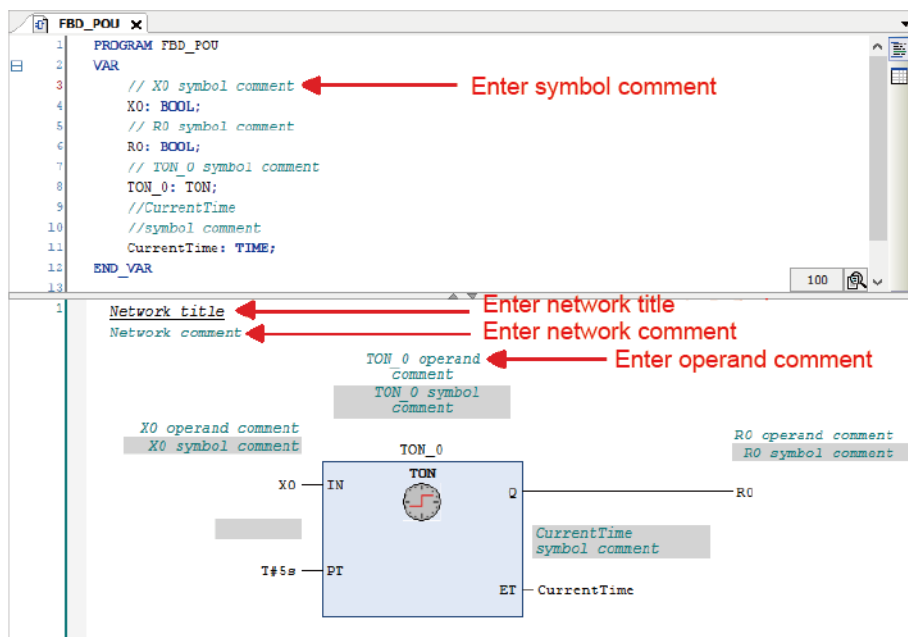

6.4.4 Settings in FBD Program

For FBD programs, the following settings can be configured.

Open the Options window (by selecting **Tools>Options**), select the "FBD, LD and IL editors" category and specify settings in the "FBD" tag window.

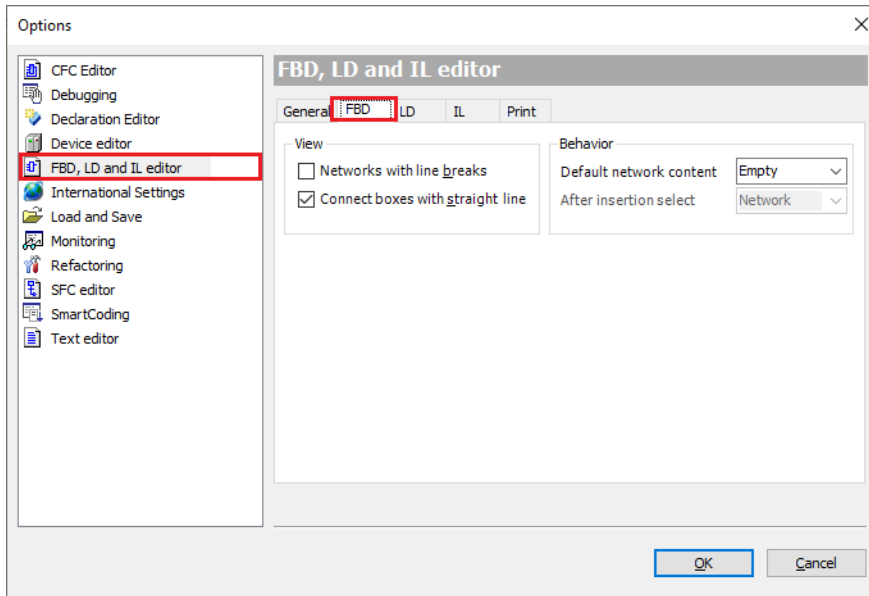

Type	Item	Description
View	Networks with line breaks	Selects whether to arrange elements by inserting line breaks automatically so that the display fits in the lateral width of the main pane.
	Connect boxes with straight line	Selects whether to fix the shortest length of a line connecting boxes.
Behavior	Default network content	Selects whether to arrange elements and variables automatically or arrange nothing when a network (circuit) is inserted.
	After insertion select	Selects whether to select a circuit or element after a network (circuit) is inserted.

6.5 Programming in Instruction List (IL)

6.5 Programming in Instruction List (IL)

This section explains how to create programs (IL programs) in Instruction List compliant with IEC 61131-3, the international standard for PLC programming languages.

- IL programs are text-based programs that consist of instructions and operands.
- To create IL programs, POU objects for IL programs are required. Set the object setup language to Instruction List (IL).
- The editor for IL programs is a window like the one shown below. It consists of the declaration section used to declare variables and the implementation section used to enter program data.

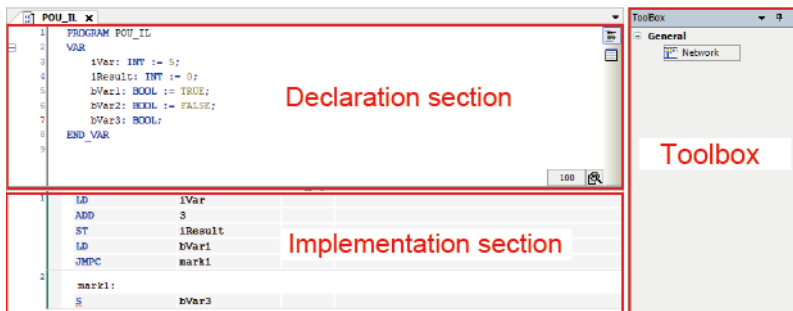

- To use POU objects for IL programs, the "Enable IL" check box must be selected as below.
- From the menu bar, select **Tools>Options>FBD, LD and IL editors>** and select the "Enable IL" check box in the "IL" tab.

6.5.1 Entering Instructions and Operands

This section explains how to create an IL program that consists of the following instructions.

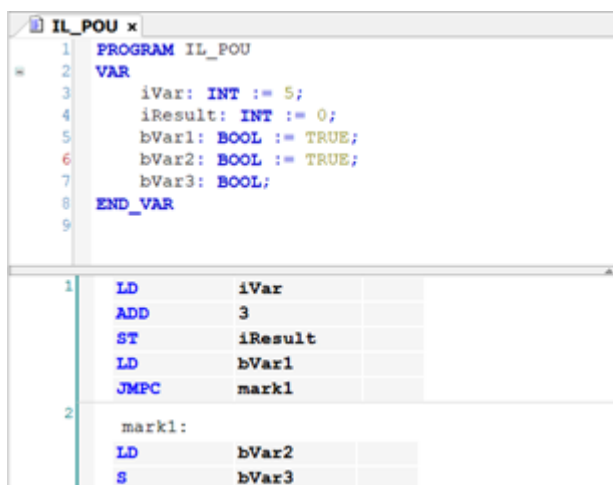

1 2 Procedure

1. Select the cell in the first row and the first column, and enter instruction "LD".
The LD instruction will be entered.

1	LD			
---	----	--	--	--

2. Press the <Tab> key to move to another cell and enter operand "iVar".
The operand will be entered and the "Auto Declare" dialog box will be displayed.
In the "Auto Declare" dialog box, declare a variable.

3. Press the <Ctrl> key + <Enter> key simultaneously.
The cursor will move to the next row.

1	LD	iVar		

In the second and subsequent rows, enter instructions and operands in the same way as above.

1	LD	iVar		
	ADD	3		
	ST	iResult		
	LD	bVar1		
	JMPC	mark1		

4. In Toolbox, select **General>Network** and drag the mouse until  displayed in the network (circuit) in the main pane is reached.
A new network (circuit) will be inserted.

1	LD	iVar		
	ADD	3		
	ST	iResult		
	LD	bVar1		
	JMPC	mark1		
2				

5. From the menu bar, select **FBD/LD/IL>Insert label**.
"Label" will be inserted.

1	LD	iVar		
	ADD	3		
	ST	iResult		
	LD	bVar1		
	JMPC	mark1		
2	Label:			

6. Enter label name "mark1" and add instructions and operands to the network (circuit) that has been inserted.

6.5 Programming in Instruction List (IL)

1	LD	iVar	
	ADD	3	
	ST	iResult	
	LD	bVar1	
	JMPC	mark1	
2	mark1:		
	LD	bVar2	
	S	bVar3	

Info.

- To create IL programs, the "Enable IL" check box in the Options dialog box must be selected. Refer to "[6.5.2 Settings in IL Program](#)".
- To delete a row, select the row and press the <Ctrl> key + <Delete> key simultaneously.
- Networks (circuits) can be commented out. The procedure for commenting out a network (circuit) is the same as for LD programs. Refer to "[6.1.6 Commenting out a Network \(Circuit\)](#)".
- The IL program can be converted and displayed as an LD or FBD program. From the menu bar, select **FBD/LD/IL>View** and select a post-conversion programming language.

6.5.2 Settings in IL Program

For IL programs, the following settings can be configured.

Open the Options window (by selecting **Tools>Options**), select the "FBD, LD and IL editors" category and specify settings in the "IL" tab window.

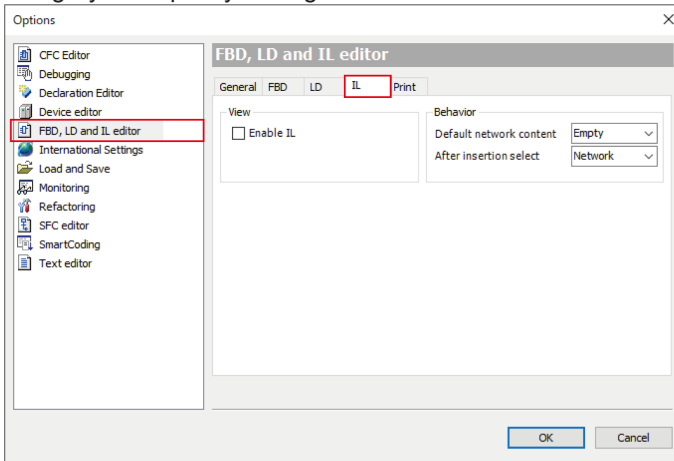

Type	Item	Description
View	Enable IL	Enables the use of IL programming language. If this check box is cleared, IL will not be displayed in the list of programming languages for setting objects when a new project is created.
Behavior	Default network content	Selects whether to arrange elements and variables automatically or arrange nothing when a network (circuit) is inserted.
	After insertion select	Selects whether to select a circuit or element after a network (circuit) is inserted.

6.6 Programming in Continuous Function Chart (CFC)

6.6 Programming in Continuous Function Chart (CFC)

Continuous Function Chart is a graphical programming language that allows programs to be created by arranging elements within the CFC editor. Elements can be freely arranged within the editor and the order of execution is determined according to the list of elements inserted.

- CFC programs are classified into standard CFC programs and page-oriented CFC programs. Page-oriented CFC programs allow page-based switchover.
- To create CFC programs, POU objects for CFC programs are required. Use "Add Object" to add POU objects for CFC programs.

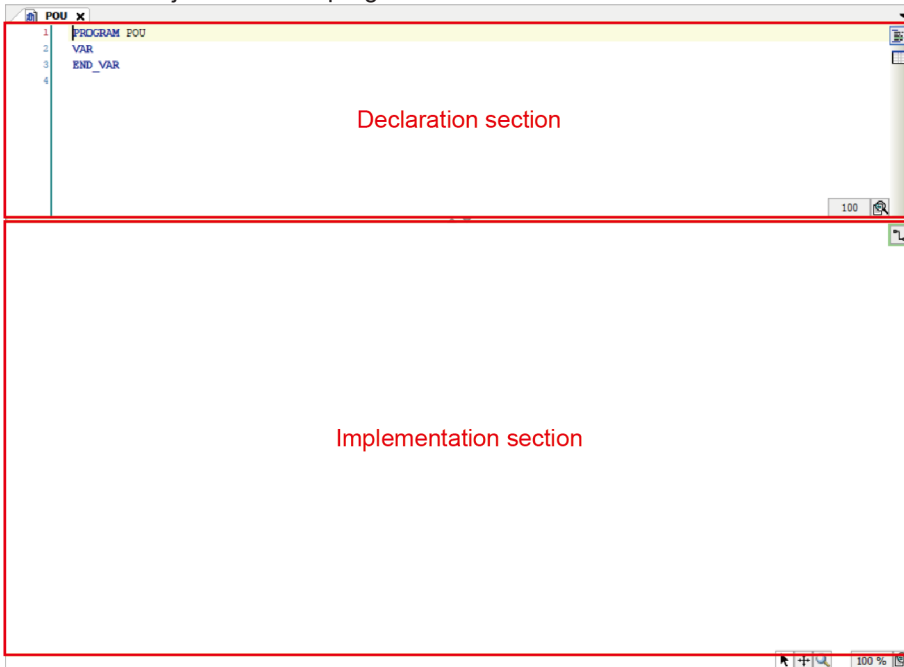

6.6.1 Inserting and Connecting Elements

This section explains how to create a CFC program that consists of the variables and function block TON shown below.

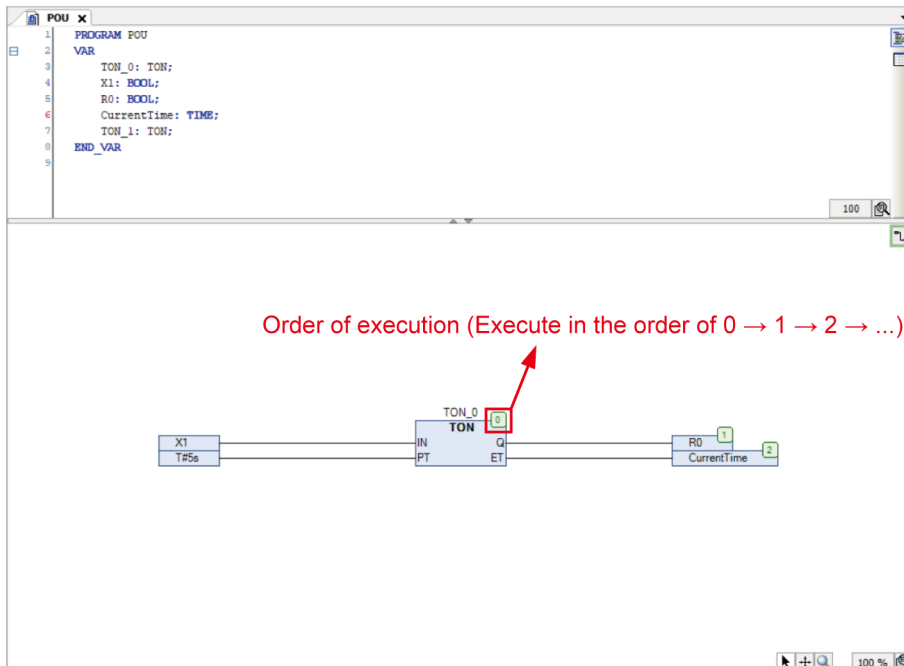

1 2 Procedure

1. In Toolbox, select **CFC>Box** and drag the box element and drop it in the implementation section.

The box element will be placed in the implementation section.

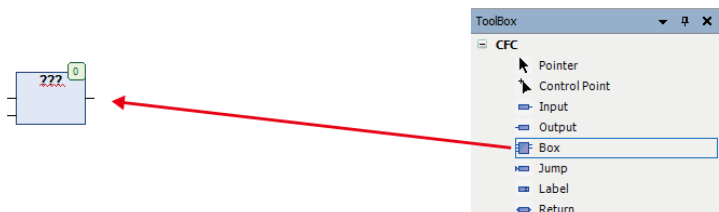

2. Enter an instance name in "???".

The box element will be transformed into function block TON and an instance name can be entered for function block TON.

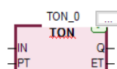

3. Select TON and enter variable TON_0, and then press the <Enter> key. The "Auto Declare" dialog box will be displayed.

6.6 Programming in Continuous Function Chart (CFC)

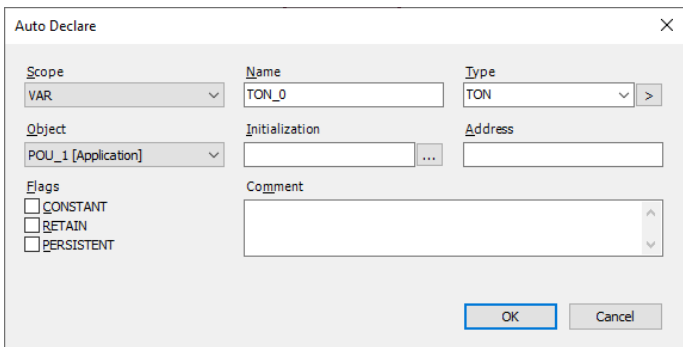

4. Click the [OK] button.

Variable TON_0 for function block TON will be declared in the declaration section.

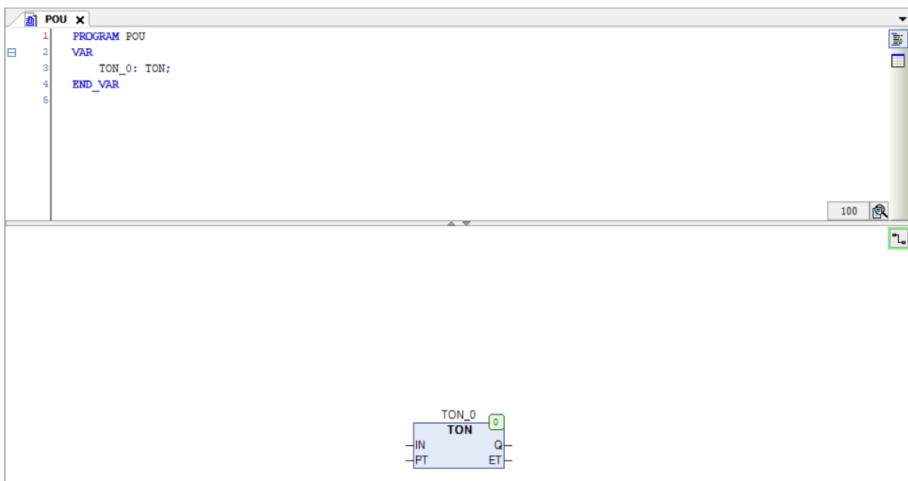

5. In Toolbox, select **CFC>Input** and drag the input element and drop it in the implementation section.

The input element will be placed in the implementation section.



6. Enter variable bVar0 in input element "???" and press the "Enter" key.
The "Auto Declare" dialog box will be displayed. Declare Boolean variable bVar0.

6.6 Programming in Continuous Function Chart (CFC)

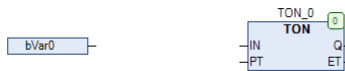
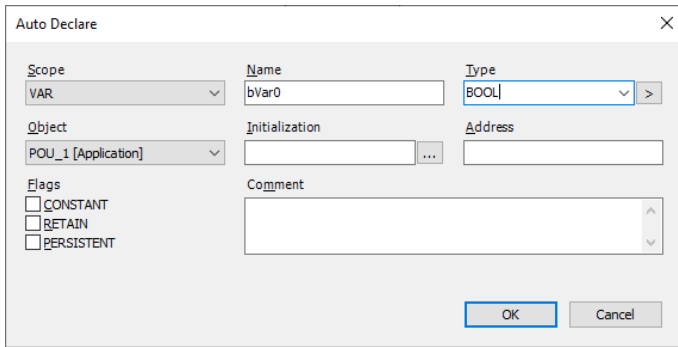

7. Select the pin on input element "variable bVar0" and drag it to "IN" on TON. Input element "variable bVar0" and "IN" on TON will be connected with a line.

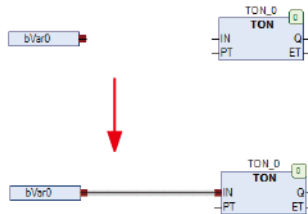

8. In Toolbox, select **CFC>Input** and drag the input element and drop it in the implementation section. The input element will be placed in the implementation section.



9. Enter "T#5s" in "???" and press the "Enter" key.



10. Select the pin on input element "T#5s" and connect it to "PT" on TON. Input element "T#5S" and "PT" on TON will be connected with a line.

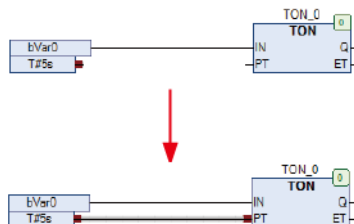

6.6 Programming in Continuous Function Chart (CFC)

- 11.** In Toolbox, select **CFC>Output** and drag the output element and drop it in the implementation section.

The output element will be placed in the implementation section.

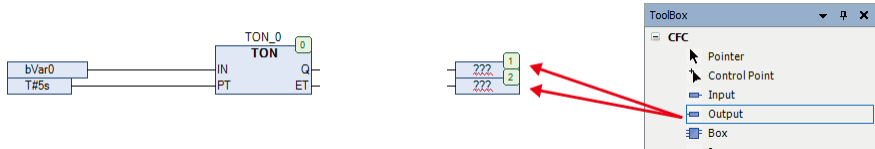

- 12.** Enter variable `bVar1` and "CurrentTime" in output element "???" and press the "Enter" key.

The "Auto Declare" dialog box will be displayed. Declare a Boolean variable for variable `bVar1` and a Time variable for variable "CurrentTime".

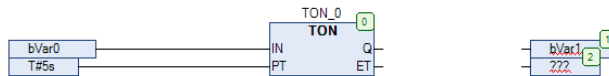
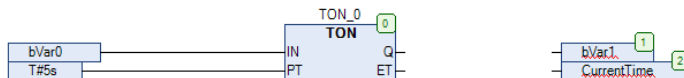
- 13.** Connect output element "variable `bVar1`" and "Q" on TON and connect output element "CurrentTime" and "ET" on TON.

6.6 Programming in Continuous Function Chart (CFC)



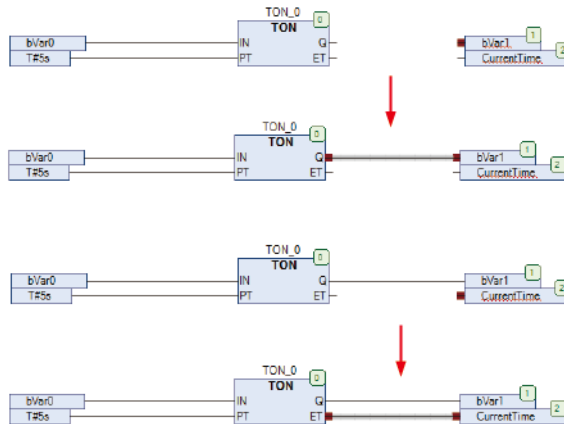

6.6.2 Connection Mark

Connection marks can be used to separate connection lines.

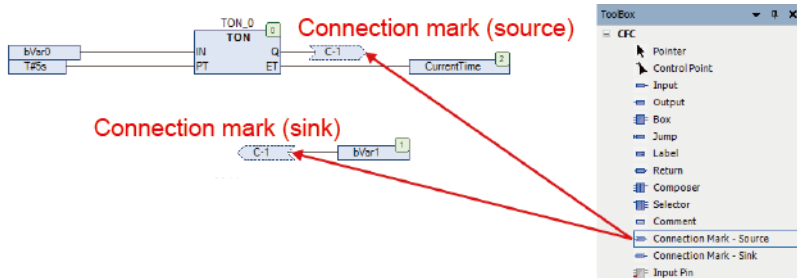
In Toolbox, select **CFC>Connection Mark - Source** and **CFC>Connection Mark - Sink**, arrange them in the implementation section, and enter the same name for them.



i Info.

- You can also separate a connection line as a connection mark by selecting **CFC>Connection Mark** from Toolbox or clicking the  icon on the toolbar, with the connection line selected. Conversely, you can restore the connection mark to a connection line by selecting **CFC>Connection Mark** from Toolbox or clicking the  icon on the toolbar, with the connection mark selected.

6.7 Variables

6.7 Variables

Variables are declared in the main pane of POU objects for programs.

6.7.1 Standard Data Types

GM Programmer allows the following data types to be used as standard data types.

Type	Type	Range	Size (in bits)
Truth	BOOL	TRUE (1) and FALSE (0)	8
Integer	BYTE	0 to 255	8
Integer	WORD	0 to 65535	16
Integer	DWORD	0 to 4294967295	32
Integer	LWORD	0 to $2^{64} - 1$	64
Integer	SINT	-128 to 127	8
Integer	USINT	0 to 255	8
Integer	INT	-32768 to 32767	16
Integer	UINT	0 to 65535	16
Integer	DINT	-2147483648 to 2147483647	32
Integer	UDINT	0 to 4294967295	32
Integer	LINT	-2^{63} to $2^{63} - 1$	64
Integer	ULINT	0 to $2^{64} - 1$	64
Floating-point number	REAL	-3.402823e+38 to 3.402823e+38	32
Floating-point number	LREAL	-1.7976931348623158e+308 to 1.7976931348623158e+308	64
Character string	STRING		(Number of characters + 1) × 8
Character string	WSTRING		(Number of characters + 1) × 16
Time	TIME	0 to 4294967295	32
Time	LTIME	0 to 213503d23h34m33s709ms551us615ns	64
Time	TIME_OF_DAY(TOD)	0 (00:00:00:000) to 4294967295 (11:59:59 PM:999)	32
Date	DATE	0 (1970-01-01) to 4294967295 (2106-02-07)	32
Date and time	DATE_AND_TIME(DT)	0 (1970-01-01,00:00:00) to 4294967295 (2106-02-07,06:28:15)	32

i Info.

- You can also use user-defined data types such as structure, enumeration, alias, and union. For details, refer to "[6.7.6 Structure, Enumeration, Alias, and Union Data Types](#)".

6.7.2 STRING type

The STRING type data can be used by enclosing the data with single quotation marks.

Usable characters are half-width English letters (a to z and A to Z), Arabic numerals (0 to 9), symbols, and space characters in the ASCII code.

Characters other than ASCII characters cannot be used correctly.

Possible to set the memory size when declaring variables.

Declaration example of a 35-letter character string:

```
str : STRING(35):= 'This is a String';
```

i Info.

- In principle, there are no restrictions on the length of a character string. However, when using character string functions, only the length of 1 to 255 characters are processed. Any characters exceeding 255 characters will be truncated from the right.

6.7.3 WSTRING type

The WSTRING type data can be used by enclosing the data with double quotation marks.

Usable characters are Unicode characters.

Typical example: ASCII characters, hiragana characters, katakana characters, kanji characters, symbols, ancient characters, Korean characters, etc.

Some of them may not be used correctly.

Possible to set the memory size when declaring variables.

Declaration example of a 35-letter character string:

```
wstr : WSTRING(35):= "This is a WString";
```

6.7 Variables

6.7.4 Array

GM Programmer allows the use of arrays.

Using arrays enables multiple data items to be used as a single variable.

This feature is useful when variables of the same type are handled collectively.

Example: When one-dimensional array a1 with eight INT type data items is declared and used in an ST program

```
ST_POU x
1 PROGRAM ST_POU
2 VAR
3   a1: ARRAY [0..7] OF INT;
4   i: INT;
5 END_VAR
6
7
8
9
10
11
12
13
14
15
16
17
18
19
20
21
22
23
24
25
26
27
28
29
30
31
32
33
34
35
36
37
38
39
40
41
42
43
44
45
46
47
48
49
50
51
52
53
54
55
56
57
58
59
60
61
62
63
64
65
66
67
68
69
70
71
72
73
74
75
76
77
78
79
80
81
82
83
84
85
86
87
88
89
90
91
92
93
94
95
96
97
98
99
100
101
102
103
104
105
106
107
108
109
110
111
112
113
114
115
116
117
118
119
120
121
122
123
124
125
126
127
128
129
130
131
132
133
134
135
136
137
138
139
140
141
142
143
144
145
146
147
148
149
150
151
152
153
154
155
156
157
158
159
160
161
162
163
164
165
166
167
168
169
170
171
172
173
174
175
176
177
178
179
180
181
182
183
184
185
186
187
188
189
190
191
192
193
194
195
196
197
198
199
200
201
202
203
204
205
206
207
208
209
210
211
212
213
214
215
216
217
218
219
220
221
222
223
224
225
226
227
228
229
230
231
232
233
234
235
236
237
238
239
240
241
242
243
244
245
246
247
248
249
250
251
252
253
254
255
256
257
258
259
260
261
262
263
264
265
266
267
268
269
270
271
272
273
274
275
276
277
278
279
280
281
282
283
284
285
286
287
288
289
290
291
292
293
294
295
296
297
298
299
300
301
302
303
304
305
306
307
308
309
310
311
312
313
314
315
316
317
318
319
320
321
322
323
324
325
326
327
328
329
330
331
332
333
334
335
336
337
338
339
340
341
342
343
344
345
346
347
348
349
350
351
352
353
354
355
356
357
358
359
360
361
362
363
364
365
366
367
368
369
370
371
372
373
374
375
376
377
378
379
380
381
382
383
384
385
386
387
388
389
390
391
392
393
394
395
396
397
398
399
400
401
402
403
404
405
406
407
408
409
410
411
412
413
414
415
416
417
418
419
420
421
422
423
424
425
426
427
428
429
430
431
432
433
434
435
436
437
438
439
440
441
442
443
444
445
446
447
448
449
450
451
452
453
454
455
456
457
458
459
460
461
462
463
464
465
466
467
468
469
470
471
472
473
474
475
476
477
478
479
480
481
482
483
484
485
486
487
488
489
490
491
492
493
494
495
496
497
498
499
500
501
502
503
504
505
506
507
508
509
510
511
512
513
514
515
516
517
518
519
520
521
522
523
524
525
526
527
528
529
530
531
532
533
534
535
536
537
538
539
540
541
542
543
544
545
546
547
548
549
550
551
552
553
554
555
556
557
558
559
560
561
562
563
564
565
566
567
568
569
570
571
572
573
574
575
576
577
578
579
580
581
582
583
584
585
586
587
588
589
590
591
592
593
594
595
596
597
598
599
600
601
602
603
604
605
606
607
608
609
610
611
612
613
614
615
616
617
618
619
620
621
622
623
624
625
626
627
628
629
630
631
632
633
634
635
636
637
638
639
640
641
642
643
644
645
646
647
648
649
650
651
652
653
654
655
656
657
658
659
660
661
662
663
664
665
666
667
668
669
670
671
672
673
674
675
676
677
678
679
680
681
682
683
684
685
686
687
688
689
690
691
692
693
694
695
696
697
698
699
700
701
702
703
704
705
706
707
708
709
710
711
712
713
714
715
716
717
718
719
720
721
722
723
724
725
726
727
728
729
730
731
732
733
734
735
736
737
738
739
740
741
742
743
744
745
746
747
748
749
750
751
752
753
754
755
756
757
758
759
760
761
762
763
764
765
766
767
768
769
770
771
772
773
774
775
776
777
778
779
780
781
782
783
784
785
786
787
788
789
790
791
792
793
794
795
796
797
798
799
800
801
802
803
804
805
806
807
808
809
810
811
812
813
814
815
816
817
818
819
820
821
822
823
824
825
826
827
828
829
830
831
832
833
834
835
836
837
838
839
840
841
842
843
844
845
846
847
848
849
850
851
852
853
854
855
856
857
858
859
860
861
862
863
864
865
866
867
868
869
870
871
872
873
874
875
876
877
878
879
880
881
882
883
884
885
886
887
888
889
890
891
892
893
894
895
896
897
898
899
900
901
902
903
904
905
906
907
908
909
910
911
912
913
914
915
916
917
918
919
920
921
922
923
924
925
926
927
928
929
930
931
932
933
934
935
936
937
938
939
940
941
942
943
944
945
946
947
948
949
950
951
952
953
954
955
956
957
958
959
960
961
962
963
964
965
966
967
968
969
970
971
972
973
974
975
976
977
978
979
980
981
982
983
984
985
986
987
988
989
990
991
992
993
994
995
996
997
998
999
1000
```

Info.

- Whether indexes are within the declared range can be automatically checked when variables in an array are accessed. Use a POU for implicit checks that checks boundaries. For details, refer to "[5.7 POU for implicit checks](#)".
- Using the array wizard for auto declaration enables array variables to be declared only by entering index and base types. For details, refer to "[5.2.3 Auto Declaration](#)".

6.7.5 Subrange Types

GM Programmer allows the use of subrange types. Subrange types allow the user to specify the range of values for standard data types.

The following is a declaration example of subrange type variables in character string format.

If an attempt is made to substitute an out-of-range value for a variable, an error will be displayed during build.

```

1  PROGRAM ST_POU
2  VAR
3      i : INT (-255..255);
4      ui : USINT (0..100);
5  END_VAR
6
1  i := 300;
2  ui := 105;
3

```

INT type value within the range between -255 and 255
 USINT type value within the range between 0 and 255
 Out-of-range error

Subrange types can also be declared in table format.

PROGRAM ST_POU							
	Scope	Name	Address	Data type	Initialization	Comment	Attributes
1	VAR	i		INT (-255..255)			
2	VAR	ui		USINT (0..100)			

i Info.

- Whether values are within the declared range can be automatically checked when subrange type variables of the DINT, UDINT, LINT, or ULINT data type are accessed. Use a POU for implicit checks that checks ranges. For details, refer to "5.7 POU for implicit checks".

6.7 Variables

6.7.6 Structure, Enumeration, Alias, and Union Data Types

User-defined structure, enumeration, alias, and union data types can be declared using DUT objects.

When using these data types, add DUT objects to the project.

1 2 Procedure

1. Right-click the [Application] object in the navigator pane and then select **Add Object>DUT** from the context-sensitive menu that is displayed.

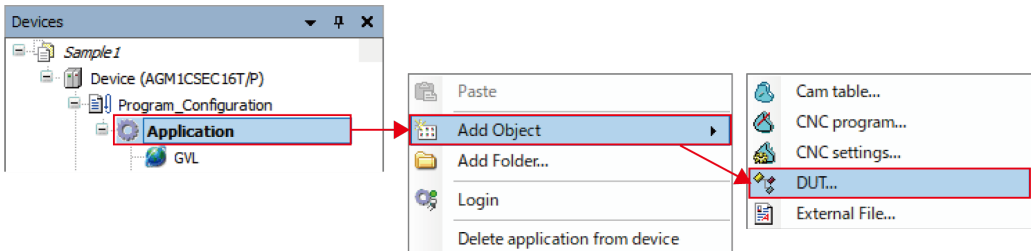

The "Add DUT" dialog box will be displayed.

The name in the "Name" field will be used as the name when the data unit type is accessed by programs.

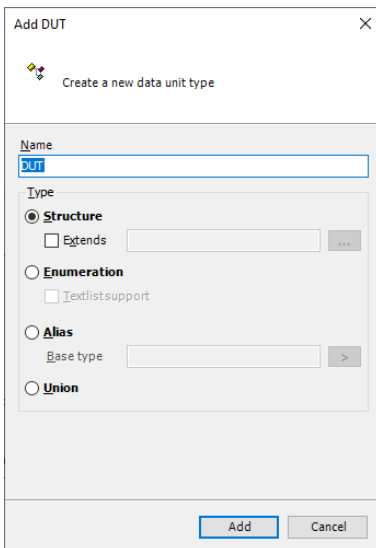

2. Select a data type to be defined, enter the necessary information, and then click the [Add] button.

A DUT object for defining the selected data type will be added to the navigator pane.

Example: Adding a structure data type

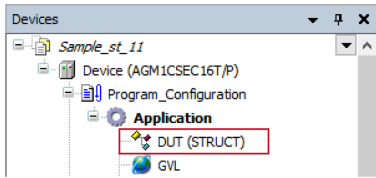

3. Select an object to be added and enter definitions in the main pane.
How to define and use each data type is described below.

Structure

The following is an example of declaring structures struct1 and struct2. struct2 is an extended structure of struct1.

To extend a structure before declaration, select the "Extends" check box in "Step 2" and enter an extension declaration.

struct1	struct2
1 TYPE struct1 :	1 TYPE struct2 EXTENDS struct1 :
2 STRUCT	2 STRUCT
3 member1 : INT;	3 member3 : BOOL;
4 member2 : INT;	4 member4 : BOOL;
5 END_STRUCT	5 END_STRUCT
6 END_TYPE	6 END_TYPE
7	7

The variable declared as a variable for structure struct2 can access the members of struct1 and struct2.

6.7 Variables

Example: An ST program that accesses members of structure struct2

```
ST_POU x struct1 struct2
1 PROGRAM ST_POU
2 VAR
3   C : struct2;
4 END_VAR
5
1 C.member1 := 10;
2 C.member3 := TRUE;
3
```

i Info.

- The BIT data type can be used as members of a structure. TRUE (1) or FALSE (0) can be used as a value. The size of the BIT data type is one bit.

Enumeration

The following are a declaration that defines enumeration enum1 and an example of an ST program that accesses members of enum1.

"0" and "3" are substituted for variables iVar0 and iVar1, respectively.

```
enum1 x ST_POU x
1 {attribute 'qualified_only'}
2 {attribute 'strict'}
3 TYPE enum1 :
4 (
5   enum_member0 := 0,
6   enum_member1,
7   enum_member2,
8   enum_member3
9 );
10 END_TYPE
11
1 PROGRAM ST_POU
2 VAR
3   i1: INT;
4   i2: INT;
5 END_VAR
6
1 i1 := enum1.enum_member0;
2 i2 := enum1.enum_member3;
3
```

Alias

An alias can be used to assign a user-defined name as the name of a data type. Declare a variable by using an alias defined in the declaration section.

The following are an alias declaration that defines alias "alias1" for LINT and an example of a declaration section that declares variable iVar0 of the alias1 data type.

Variable iVar0 declared as the alias1 data type is handled as a variable for the LINT data type.

```
alias1 x ST_POU x
1 TYPE alias1 : LINT; END_TYPE
2
1 PROGRAM ST_POU
2 VAR
3   i1: alias1;
4 END_VAR
5
```

Union

The following are a union declaration that defines union "union1" and an example of an ST program that accesses members of union1.

union1 x	ST_POU x
1 TYPE union1 :	1 PROGRAM ST_POU
2 UNION	2 VAR
3 member1 : BOOL;	3 u : union1;
4 member2 : BOOL;	4 b1 : BOOL;
5 member3 : BOOL;	5 b2 : BOOL;
6 member4 : BOOL;	6 END_VAR
7 END_UNION	7
8 END_TYPE	
9	
	1 b1 := u.member1;
	2 b2 := u.member3;

6.7 Variables

6.7.7 Constants

GM Programmer allows the use of constants.

Constants are declared according to the following syntax.

VAR CONSTANT

Constant name:Type:=Default value;

END_VAR

Type	Constant type	Description
BOOL	BOOL	TRUE (1), FALSE (0)
Integer	Types that can be used as numerical values	Binary, octal, decimal, and hexadecimal numbers For numbers other than decimal numbers, integer constants are entered after number base and #. Examples: 14, 2#0101, 8#27, 16#34AB
Decimals and exponents	REAL / LREAL	Decimals and exponents Examples: 1.4, 2.34e+008
Time	TIME	32-bit time constants compliant with IEC 61131-3 Syntax: t#, T#, time#, TIME# Examples: T#12ms, T#12h32m24s
Time	LTIME	64-bit time constants In addition to TIME constants, the following units can be used. Microsecond: m Nanosecond: ns Syntax: LTIME# Example: LTIME#123m456ns
Time	TIME_OF_DAY	Time Syntax: tod#, TOD#, time_of_day#, TIME_OF_DAY# Example: tod#12:24:20.123
Date	DATE	Date Syntax: d#, D#, date#, DATE# Example: d#2018-01-01
Date and time	DATE_AND_TIME	Date and time Syntax: dt#, DT#, date_and_time#, DATE_AND_TIME# Example: dt#2018-01-01-07:04:13
Character string	STRING	Enclosed with single quotation marks Example: 'Hello World'
	WSTRING	Enclosed with double quotation marks Example : "Hello World"

6.7.8 Object for Global Variable Declaration

GM Programmer allows the use of global variables that can be used within the entire project.

■ Global variable list

This is an object for declaring global variables.

Variables declared in the global variable list can be accessed by using "object-name.global-variable-name" in the global variable list.

Example: When variables in global variable list "Object GVL" are accessed by an ST program

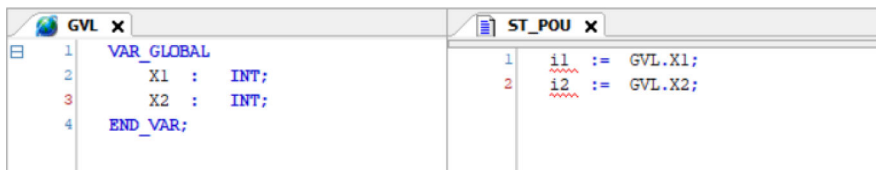

For details, refer to "6.7.9 Global Variables".

■ Persistent variable list

This is an object for declaring global variables that are persistent variables.

From "Add Object", select "Persistent Variables".

For details, refer to "6.7.10 Persistent Variables".

6.7 Variables

6.7.9 Global Variables

GM Programmer allows the use of global variables that can be used with all projects. Global variables are declared within the global variable list (GVL) object. This section explains how to declare global variables and access the declared variables.

1 2 Procedure

1. Double-click the GVL object in the navigator pane.

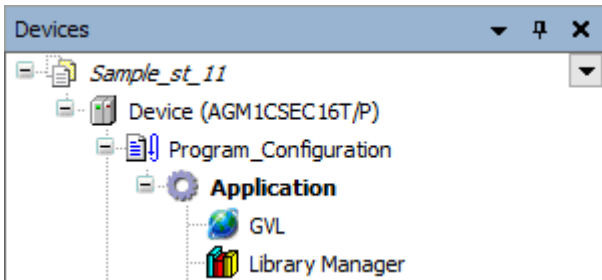

The GVL window will be displayed in the main pane.

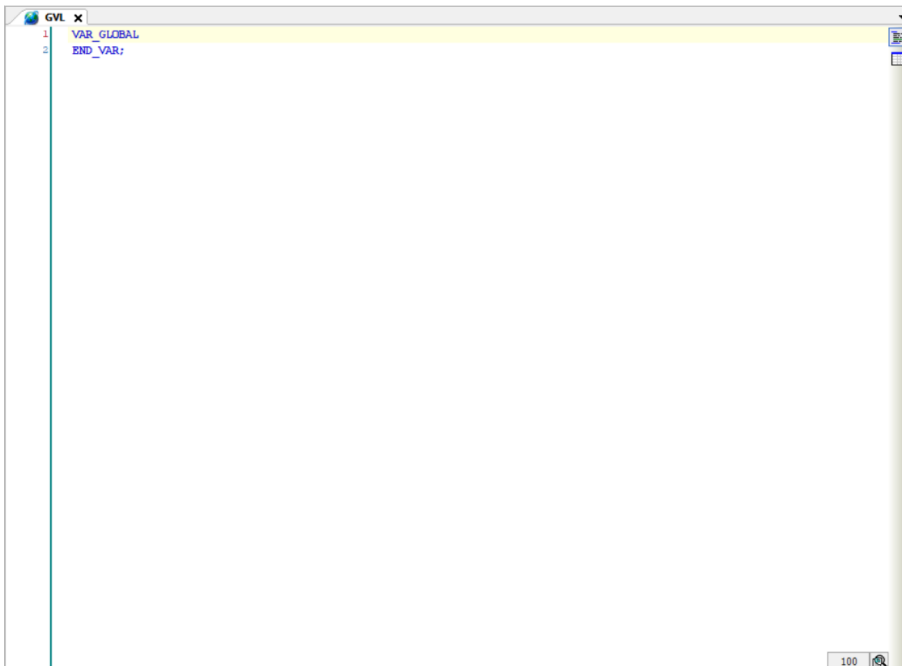

2. Declare variables in the global variable list (GVL).

Example: Declaring global variable g_iVar0 of INT data type

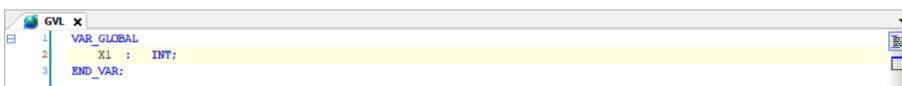

The declared variable can be accessed from the program by using "name.variable name".

Example: Substituting value "5" for global variable g_iVar0

```
1 PROGRAM ST_POU_1
2 VAR
3 END_VAR
4
1 GVL.X1 := 5;
```

i Info.

- Variables declared before the build process can be imported and exported in XML format. Right-click the object in the global variable list and then select "Properties" from the context-sensitive menu that is displayed. The "Properties" dialog box will be displayed. Open the "Link To File" tab window, select either the check box for import or the check box for export, and enter the path to the file to be imported or exported in the File name field.

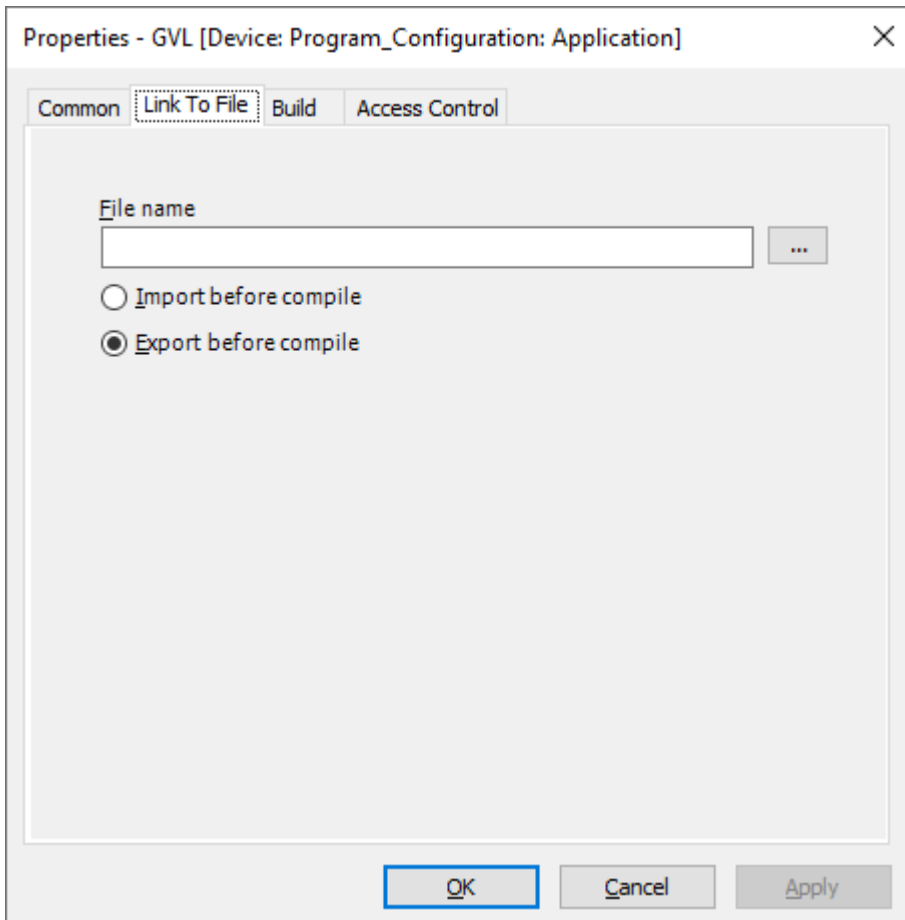

6.7 Variables

6.7.10 Persistent Variables

GM Programmer allows the use of global variables that are persistent variables which hold values without initializing them at the time of reset.

Persistent variables that can be used as global variables are declared within the persistent variable list object.

Only one persistent variable list object can be registered.

1 2 Procedure

1. Right-click the [Application] object in the navigator pane and then select **Add Object>Persistent Variable** from the context-sensitive menu that is displayed.

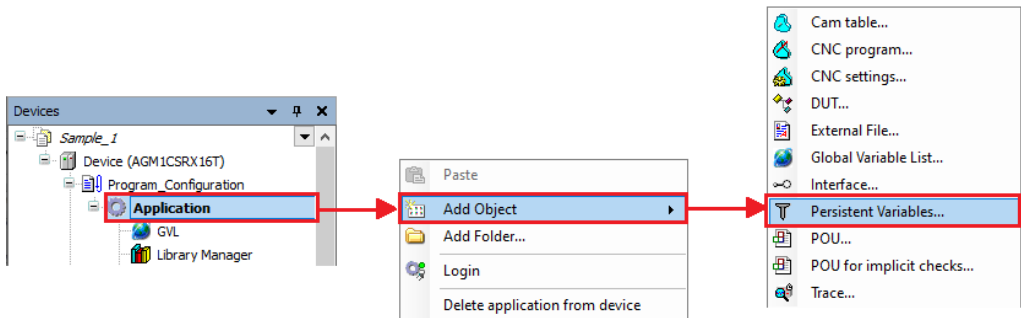

The "Add Persistent Variable" dialog box will be displayed.

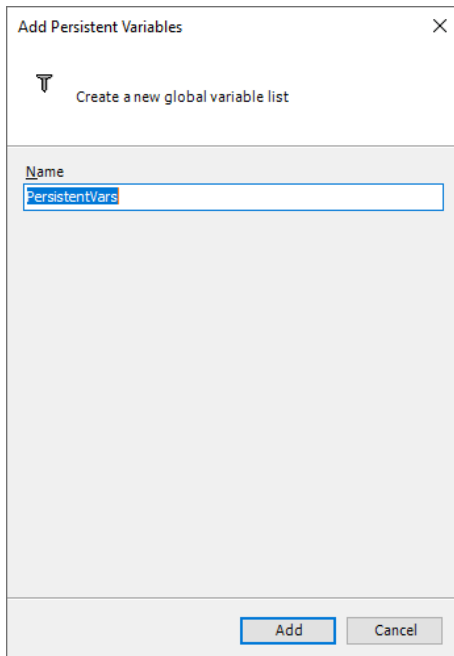

2. Enter a name for the persistent variable list and click the [Add] button.
A "Persistent variable list" object will be added to the navigator pane.

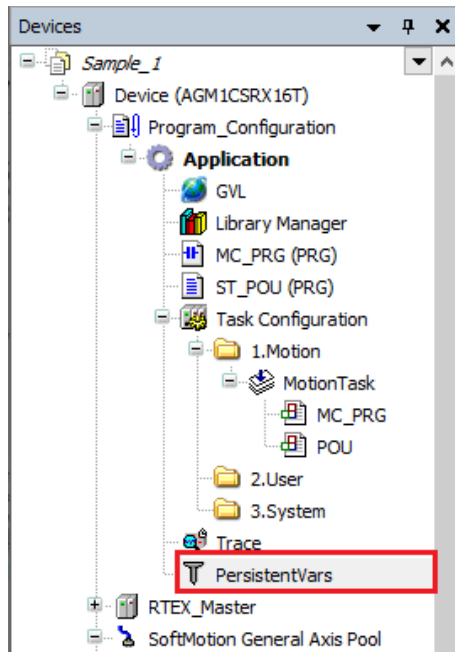
Example: Persistent variable list object with name "PersistentVars"

3. Declare variables in the persistent variable list.

Example: Declaring global variable g_iVar0 that is a persistent variable of INT type

```

1  {attribute 'qualified_only'}
2  VAR_GLOBAL PERSISTENT RETAIN
3    g_iVar0 : INT;
4
5  END_VAR

```

The declared variable can be accessed from the program by using "name.variable name".

Example: Substituting value "6" for global variable g_iVar0 that is a persistent variable

```

1  FUNCTION_BLOCK ST_POU2
2  VAR
3  END VAR

```

```

1  PersistentVars.g_iVar0 := 6;
2

```

6.7 Variables

i Info.

- Persistent variables used as local variables can be declared (as VAR PERSISTENT RETAIN) in the declaration section for each POU object.
- If you update the variable registered in the persistent variable, the retained data of the persistent variable will be cleared at the time of download, so perform the ["14.5.5 Saving and restoring persistent variables"](#) operation.
- Instance paths of persistent variables declared in each POU object can be added to the persistent variable list.

With the persistent variable list declaration section selected, from the menu bar, select **Declare>Add All Instance Paths**.



```
1 {attribute 'qualified_only'}
2 VAR_GLOBAL PERSISTENT RETAIN
3   XS : INT;
4
5 // The generated instance path of the persistent variable
6 LD_POU.X11 : BOOL;
7 END_VAR
```

7 Connecting the GM1 Controller and PC

7.1	Flow of Operation Check	7-2
7.2	Connecting the GM1 Controller and PC	7-3
7.2.1	Selecting a Connection Port for GM Programmer	7-3
7.2.2	Connecting the GM1 Controller and PC with a Cable.....	7-3
7.3	Communication Setting.....	7-4
7.3.1	Setting the LAN Port	7-4
7.3.2	Adding USB Ports	7-5
7.4	Time Function	7-7
7.4.1	Settings Based on GM Programmer	7-7
7.4.2	Settings Based on Function Blocks	7-7
7.5	Connecting to the GM1 Controller	7-8
7.6	Login / Logout	7-10
7.6.1	Login	7-11
7.6.2	Logout	7-12
7.6.3	Download	7-12
7.6.4	Online Change	7-14
7.7	Source Upload	7-15
7.8	Other Settings	7-17
7.8.1	Changing the Device Name	7-17
7.8.2	Sending Echo services	7-18
7.8.3	Device preference management	7-20
7.8.4	Confirmed online mode	7-22

7.1 Flow of Operation Check

7.1 Flow of Operation Check

This chapter explains how to connect the PC where GM Programmer is installed and the GM1 controller and operate the GM1 controller from the PC.

First, this section explains the flow of operation check for a program that is created.

1. Build(Refer to "5.9 Build")

Execute build to check a program that is created. If an error occurs, correct the program and execute build again. If code generation is executed after build is completed normally, an application will be generated.



2. Connecting to the GM1 controller(Refer to "7.3 Communication Setting")

Connect the PC where GM Programmer is installed to the GM1 controller.



3. Login(Refer to "7.6.1 Login")

Log in to the GM1 controller. When you log in to the GM1 controller, applications are downloaded to the GM1 controller.



4. Debug(Refer to "8 Debug")

Execute the application and perform debugging. If there are any problems with behaviors, log out of the GM1 controller, correct the problem, and execute build again.

7.2 Connecting the GM1 Controller and PC

7.2.1 Selecting a Connection Port for GM Programmer

Select either LAN port connection or USB port connection. (Image is the GM1 RTEX)

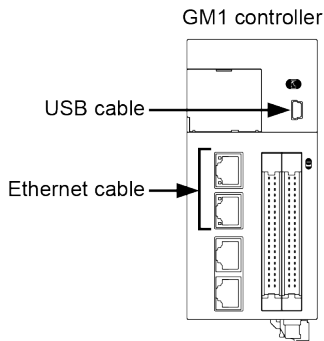

7.2.2 Connecting the GM1 Controller and PC with a Cable

Use an Ethernet cable or USB cable to connect the GM1 Controller and a PC on which the GM Programmer is installed.

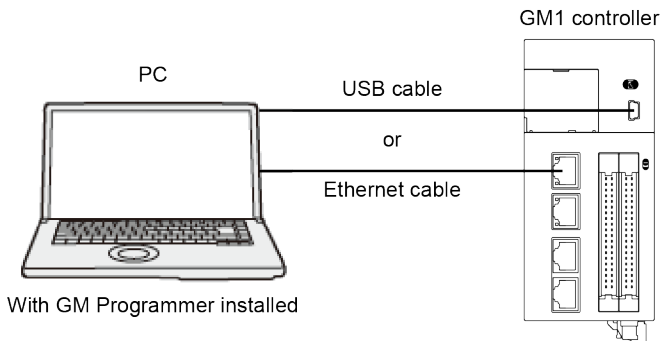

7.3 Communication Setting

7.3.1 Setting the LAN Port

Configure communication settings for the LAN port using "Network setting" in the "PLC Parameters" tab.

When connecting GM Programmer and the GM1 Controller via the LAN port, match the network settings of the PC with those of the GM1 Controller.

1 2 Procedure

1. Double-click the "Device(AGM1CSEC16T/P)" object in the navigator pane. The device editor will open.
2. Open the "PLC Parameters" tab.

Parameter	Type	Value	Default Value	Unit	Description
Unit error occurred	Enumeration of BYTE	Stop operation	Stop operation		Please select the operation when a unit error occurred.
Network setting					Network setting
LAN port1					LAN port1 network settings
IP Address	STRING	'192.168.1.5'	'192.168.1.5'		Specify the ip address for LAN port1.
Subnet Mask	STRING	'255.255.255.0'	'255.255.255.0'		Specify the subnet mask for LAN port1.
Default Gateway	STRING	'192.168.1.1'	'192.168.1.1'		Specify the default gateway for LAN port1.
LAN port2					LAN port2 network settings
IP Address	STRING	'192.168.2.5'	'192.168.2.5'		Specify the ip address for LAN port2.
Subnet Mask	STRING	'255.255.255.0'	'255.255.255.0'		Specify the subnet mask for LAN port2.
Default Gateway	STRING	'0.0.0.0'	'0.0.0.0'		Specify the default gateway for LAN port2.

3. Check the network settings of the GM1 Controller and match the network settings of the PC with those of the GM1 Controller.
4. Open the "Communication Settings" tab and click "Network scan".
5. Select a GM1 Controller to which you want to connect and click the [OK] button.



- If the network settings of the GM1 Controller have been changed, the changes will take effect after the project is downloaded.

7.3.2 Adding USB Ports

This function allows the user to set a USB port as the communication interface between a tool such as GM Programmer or PANATERM Lite for GM and the GM1 Controller.

1 2 Procedure

1. Connect the GM1 Controller and PC with a USB cable.
2. From the menu bar, select **Online>Add USB Port**.

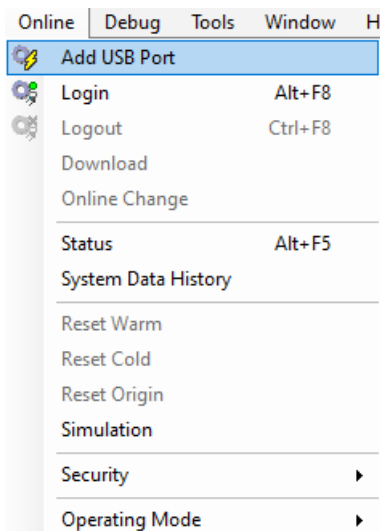

The "Add USB Port" dialog box will be displayed.

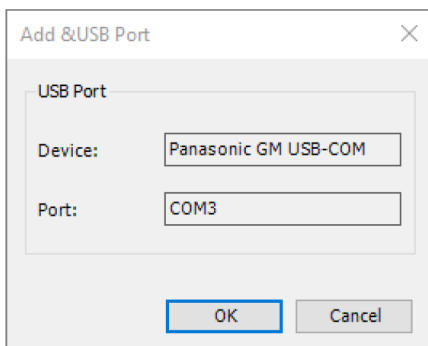

3. Click the [OK] button.
A dialog box to restart the Gateway will be displayed.

7.3 Communication Setting

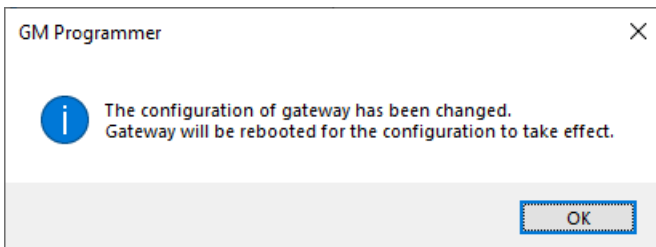

4. Click the [OK] button.
The "Select Device" dialog box will be displayed.

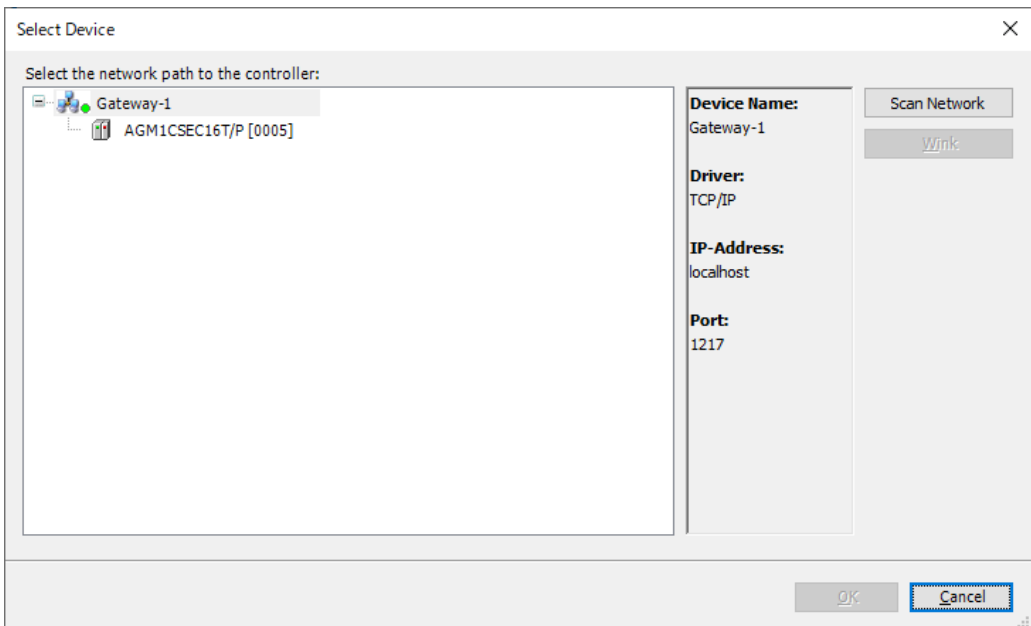

5. Select a GM1 Controller to which you want to connect and click the [OK] button.
When the connection is completed, a dialog box will be displayed to notify successful connection.

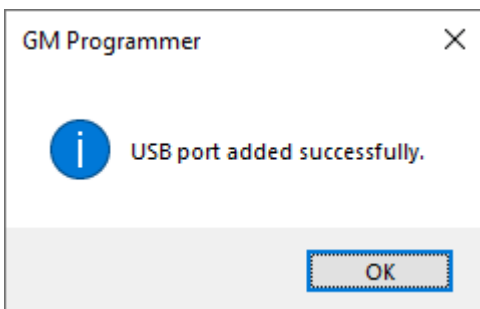

6. Click the [OK] button.
A USB port will be added as the communication interface between the PC and GM1 Controller.

7.4 Time Function

7.4.1 Settings Based on GM Programmer

Date and time settings and monitoring for the GM1 controller can be performed using the "Date and Time Settings" window of GM Programmer. Connect to the GM1 controller and select the "Date and Time Settings" tab of the "Device" window.

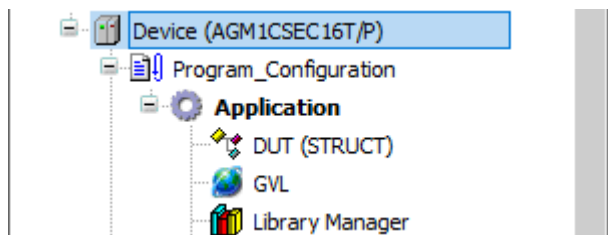

Date and Time Settings pane

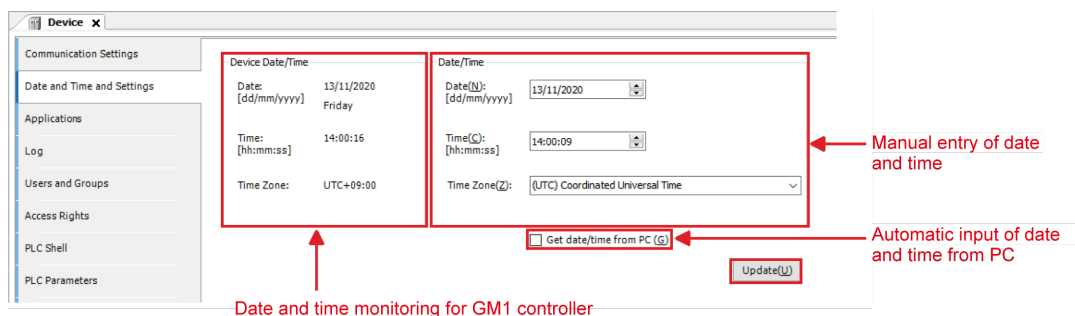

The "Device Date and Time" frame on the left side of the pane displays the date / time information of the GM1 controller. To set date and time, enter date and time in the "Date and Time" frame on the right side of the pane and click the [Update] button. The entered date and time will be set in the GM1 controller.

If the "Get date / time from PC" check box is selected, the date/time information of the PC will be automatically set in the GM1 controller. In this case, the time zone of the PC will be automatically set in the GM1 controller.

7.4.2 Settings Based on Function Blocks

With the GM1 controller, you can obtain and set the current time, obtain and set a time zone, and obtain the SNTP time.

For details on how to use this function, refer to the *GM1 Series Reference Manual (Instruction Edition)*.

7.5 Connecting to the GM1 Controller

7.5 Connecting to the GM1 Controller

Connect the PC where the GM Programmer is installed to the GM1 Controller.

The connection status of the PC includes "Connected", "Connection as a device user", "Login", and "Online config mode".

Depending on the connection status, operations that can be executed are different.

If the Controller is provided with a device user registration, connection must be made as the device user.

■ Without device user registration

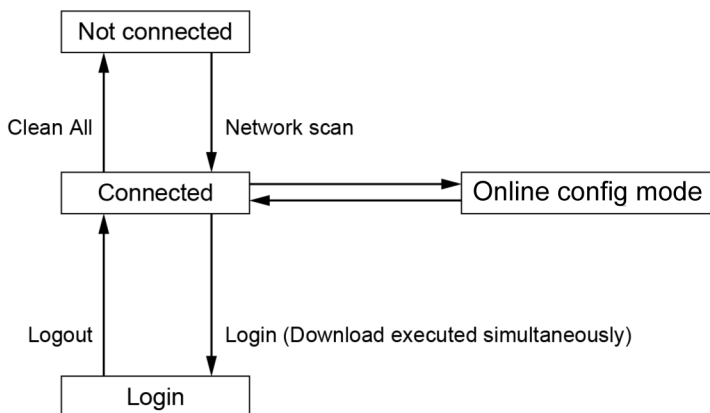

List of available GM1 Controller operations

Function	Not connected	Connected	Login	Online config mode
Setting / acquiring Controller information	x	o	o (Note 1)	x
Application management	x	x (Note 2)	o	x
Reset	x	x (Note 3)	o	x (Note 4)
Security	x	x	o	o
Debug	x	x	o	x
Commissioning	x	x	x	o

(Note 1) Not possible to operate the PLC Shell.

(Note 2) Possible to upload the source.

(Note 3) Possible to reset the device (PLC initialization) or to delete device application from the device.

(Note 4) Possible to reset the device (PLC initialization).

■ With device user registration

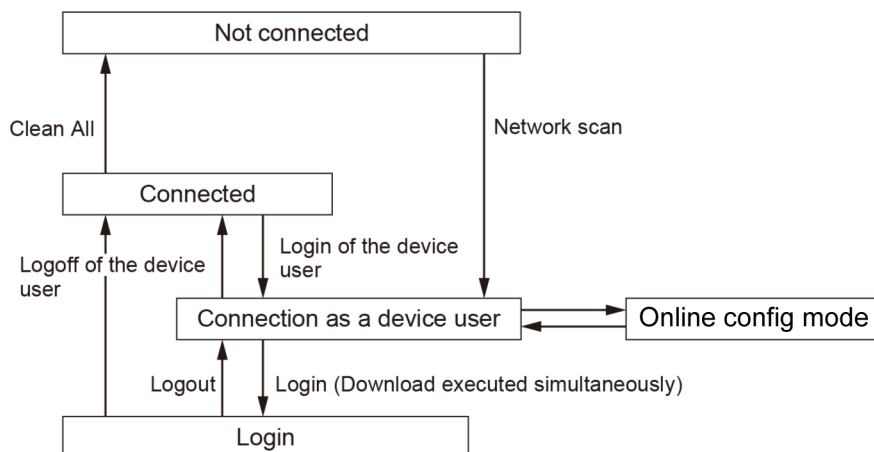

List of available GM1 Controller operations

Function	Not connected	Connected	as a device user	Login	Online config mode
Setting / acquiring Controller information	x	x	o	o (Note 1)	x
Application management	x	x	x (Note 2)	o	x
Reset	x	x	x (Note 3)	o	x (Note 4)
Security	x	x	o (Note 5)	o	o
Debug	x	x	x	o	x
Commissioning	x	x	x	x	o

(Note 1) Not possible to operate the PLC Shell.

(Note 2) Possible to upload the source.

(Note 3) Possible to reset the device (PLC initialization) or to delete device application from the device.

(Note 4) Possible to reset the device (PLC initialization).

(Note 5) Addition of the device user, changing the password for the device user, or deletion of the device user cannot be made if the user of the Device Editor is not synchronized with "Synchronization" of the group tab.

7.6 Login / Logout

7.6 Login / Logout

GM Programmer allows the user to log in to the GM1 controller.



- During login, the application and source code generated by code generation are downloaded to the GM1 controller.
- You can set up the project so that the source is not downloaded during login. Refer to "4.5.1 Setting up a Project".

- The combination of the application and source code downloaded to the GM1 controller differs according to the operations shown in the table below.

○: Downloaded

×: Not downloaded

Operation	Boot application	Source code
Login	○	○
Initial download	○	○
Downloading after changing the program "Update boot project"check box: Selected	○	○
Downloading after changing the program "Update boot project"check box: Cleared	×	×
Downloading after changing the project	○	○
Online change "Update boot project"check box: Selected	○	○
Online change "Update boot project"check box: Cleared	×	×
Generating a boot application	○	○

After logging in to the GM1 controller, you can perform debug operations such as starting or stopping the GM1 controller.

7.6.1 Login

GM Programmer allows the user to log in to the GM1 Controller. When "Login" is executed, applications are downloaded to the GM1 Controller.

1 2 Procedure

1. From the menu bar, select **Online>Login**, or press the <Alt> key and the <F8> key simultaneously.

A confirmation message will be displayed, asking whether to download the applications to the GM1 controller (device).

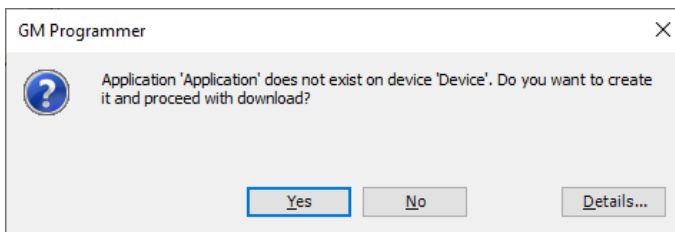

2. Click [Yes].

The applications will be downloaded to the GM Programmer at the same time as you log in to the GM1 Controller (device).

"connected" will be displayed at the [Device] object in the navigator pane and the status of the downloaded applications will be displayed.

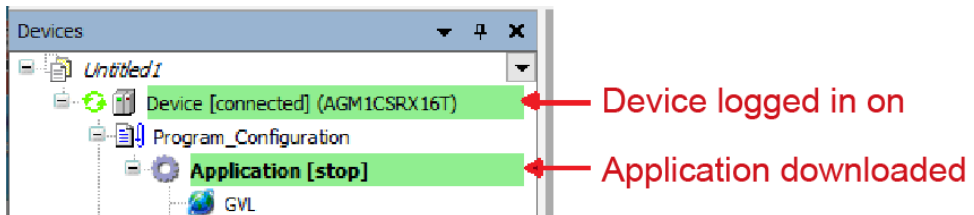

i Info.

- You can also log in by clicking  on the toolbar.
- If you log in again after the applications have been downloaded, the confirmation message will not be displayed.

7.6 Login / Logout

7.6.2 Logout

This function allows the user to log out from the device to which the user logged in.

1 2 Procedure

1. From the menu bar, select **Online>Logout**, or press the <Ctrl > + <F8> key simultaneously. You will be logged out.

i Info.

- You can also log out by clicking  on the toolbar.

7.6.3 Download

After changing programs and logging in without executing online change, you can download applications while being logged in.

The boot application is also updated during download.

1 2 Procedure

1. When executing "login", select "Login without any change" and click the [OK] button.

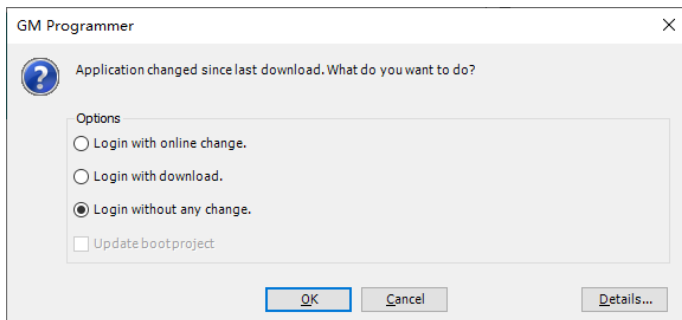

Applications will not be downloaded to the GM1 controller.

2. From the menu bar, select **Online>Download**.

A confirmation message will be displayed, asking whether to download the source code to the GM1 controller.

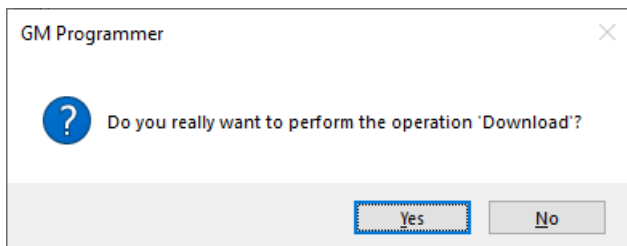

3. Click[Yes].

If the project has not yet been saved, a confirmation message will be displayed, asking whether to save the project.

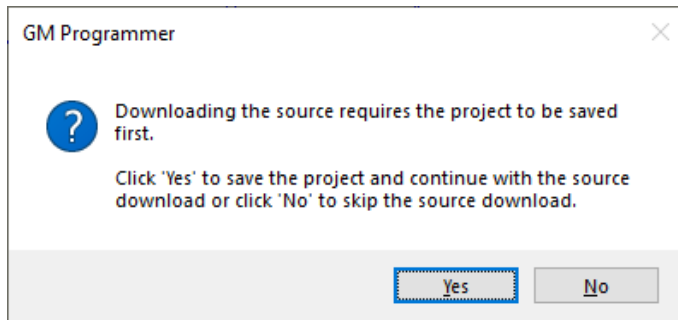
4. If you do not save the project, the source code will not be downloaded. In this case, click the[Yes]button.**i Info.**

- To delete the downloaded source code from the GM1 controller, execute "Reset Device". For details on reset, refer to ["8.8.1 Reset Warm, Reset Cold, and Reset Origin"](#).
- You can set up the project so that the source is not downloaded while the application is downloaded. Refer to ["4.5.1 Setting up a Project"](#).

7.6 Login / Logout

7.6.4 Online Change

Online change allows the user to change applications without having to stop the GM1 controller during operation. Executing online change downloads only different applications to the GM1 controller.

If the applications generated by build during login differ from the applications within the GM1 controller, the following dialog box will be displayed.

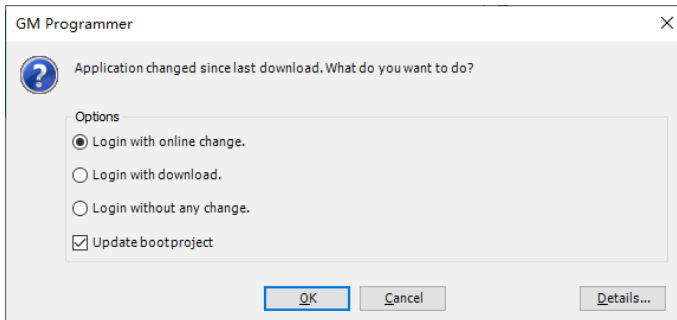

Login with online change

Executes login by downloading only different applications without stopping the GM1 controller

Login with download

Executes login by downloading applications generated by build with the GM1 controller stopped

Login without any change

Executes login without downloading the applications generated by build

Info.

- Do not clear the "Update bootproject" check box. If you clear the check box, the applications will not be saved when the GM1 controller is turned OFF.
- When changing the initial value of a variable with online change, be sure to add "attribute 'init_on_onlchange'" declaration to the attribute of the target variable.
If the declaration is not added, the initial value changed with online change will not be applied.

	Scope	Name	Address	Data type	Initial Value	Comment	Attributes
1	VAR	data		INT	5		attriute 'init_on_onlchange'

7.7 Source Upload

Upload the source code from the GM1 controller to the PC and retrieve it, as below.

1 2 Procedure

1. From the menu bar, select **File>Source Upload(Device→PC)**.
The "Select Device" dialog box will be displayed.

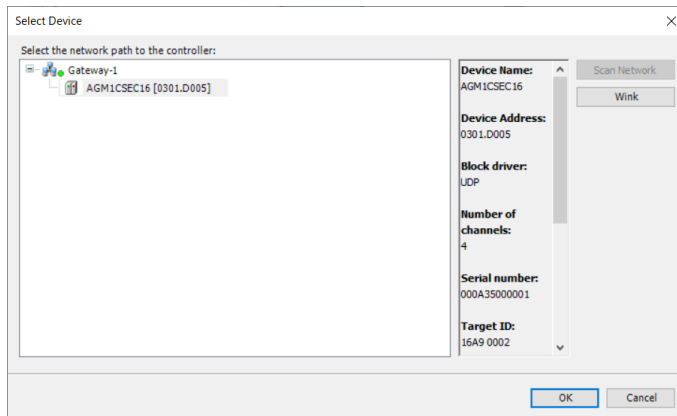

2. Select the GM1 controller from which the source code is to be retrieved and click the [OK] button.
The "Extract Project Archive" dialog box will be displayed.

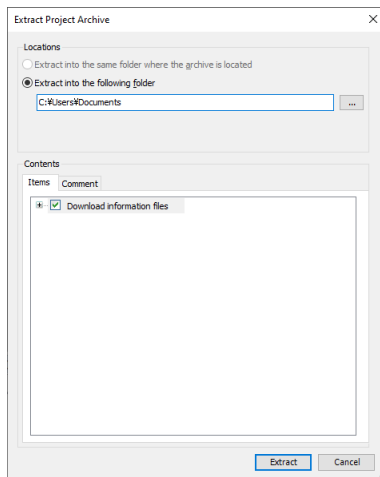

7.7 Source Upload

i Info.

- If the source code does not exist in the selected GM1 controller, the following error message will be displayed.

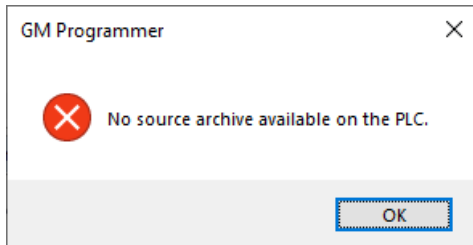

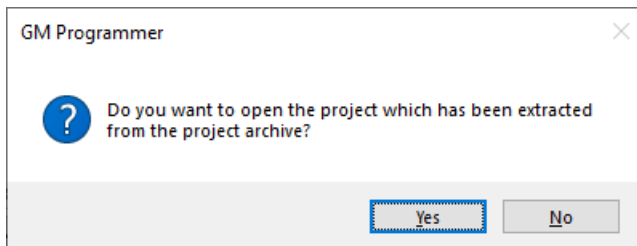

3. Specify the upload destination folder and click the [Extract] button.

A confirmation dialog box will be displayed, asking whether to open the uploaded source code as a project file. Click the [Yes] button to open the uploaded source code as a project file.



4. In the folder specified as the upload destination, "Archive.prj" and "<project name>.project" will be created.

Name	Date modified	Type
 Archive.prj	2020/11/11 13:43	PRJ File
 Sample1.project	2020/11/11 13:43	GM Programmer ...

7.8 Other Settings

For the connected device, configure settings described in "Change Device Name", "Sending Echo services", "Device preference management", and "Confirmed Online Mode".

7.8.1 Changing the Device Name

This section explains how to change the name of the device connected via "Network Scan".

1 2 Procedure

1. Double-click the "Device" object in the navigator pane.

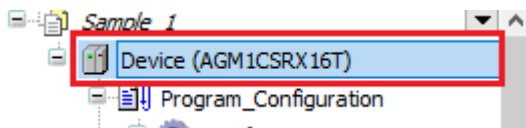

The setting pane will be displayed in the main pane.

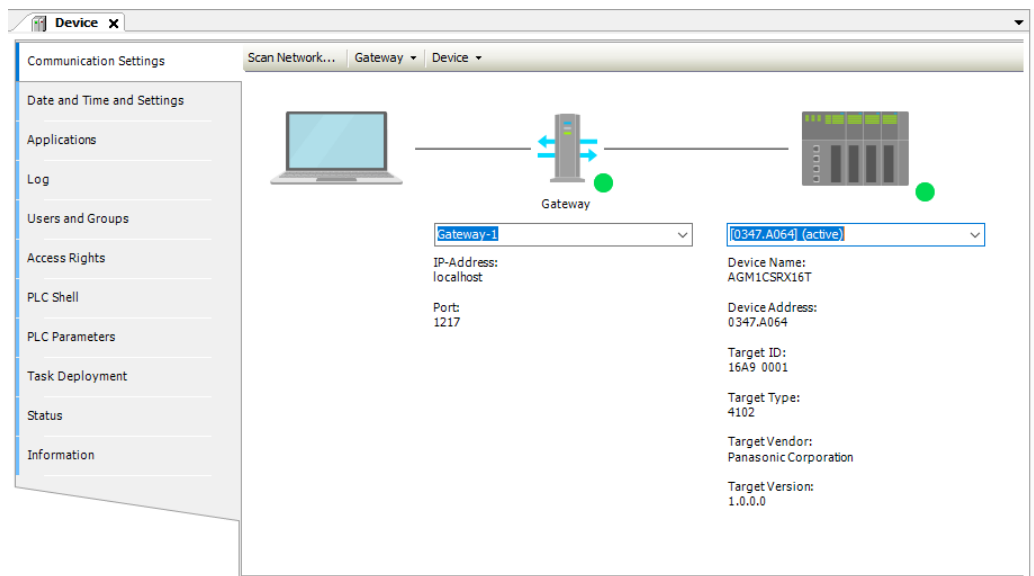

2. Select "Rename Active Device" from the "Device" menu. The "Change Device Name" dialog box will be displayed.

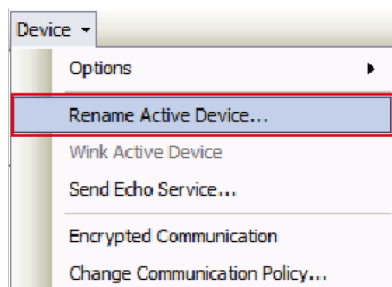

7.8 Other Settings

3. Enter a new device name and click the [OK] button.
The device name will be changed.

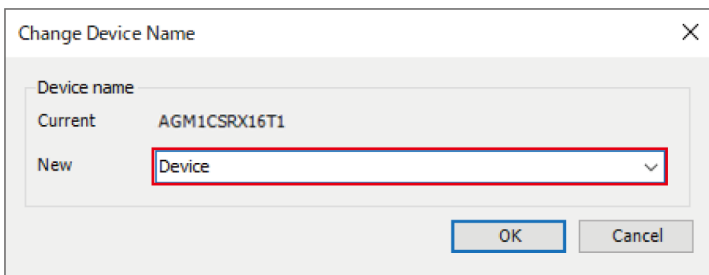

7.8.2 Sending Echo services

This section explains how to send Echo services to the device connected via "Network Scan". Echo services can be used to conduct a network test.

1 2 Procedure

1. Double-click the "Device" object in the navigator pane.

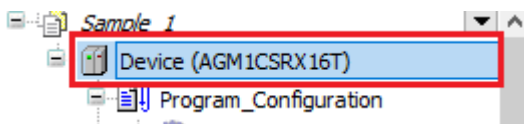

The setting pane will be displayed in the main pane.

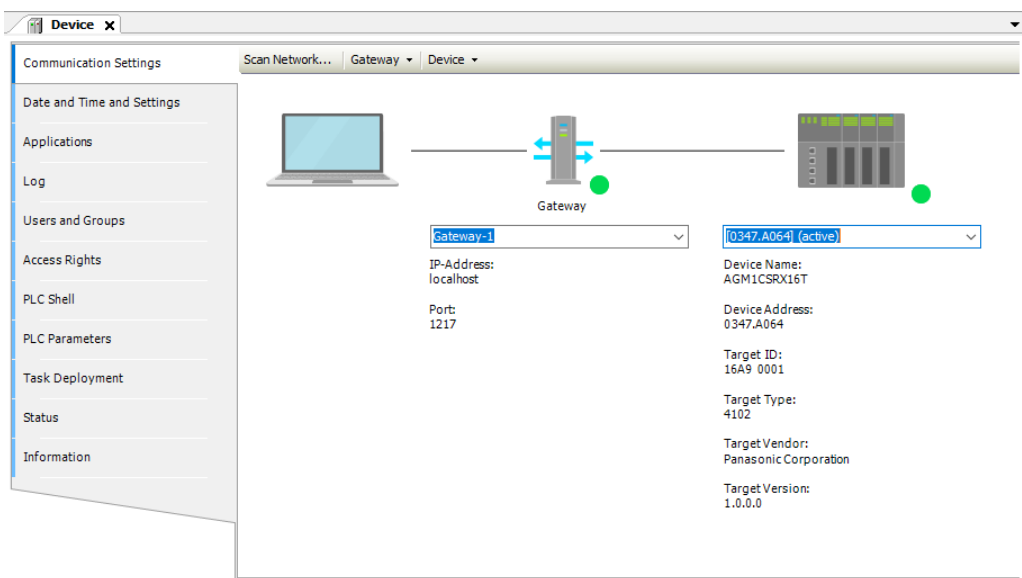

2. Select "Send Echo Service" from the "Device" menu.

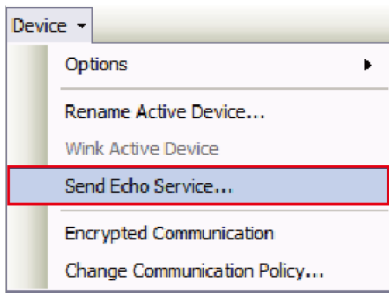

The results of five transmissions with no data size followed by five transmissions with data size will be displayed.

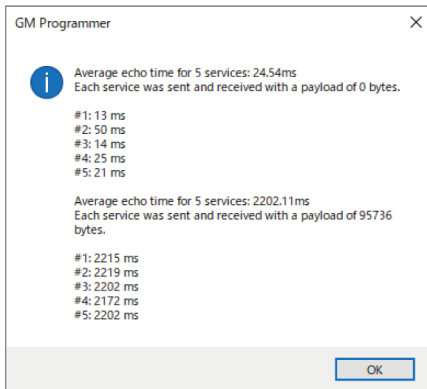

7.8 Other Settings

7.8.3 Device preference management

Devices connected via "Network Scan" can be managed by registering them as favorite devices.

Devices registered as favorite devices will be displayed in the device selection list in the Communication Settings window.

1 2 Procedure

1. Double-click the "Device" object in the navigator pane.

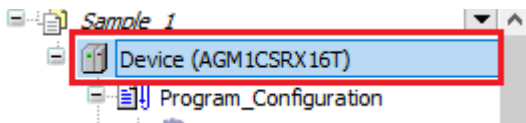

The setting pane will be displayed in the main pane.

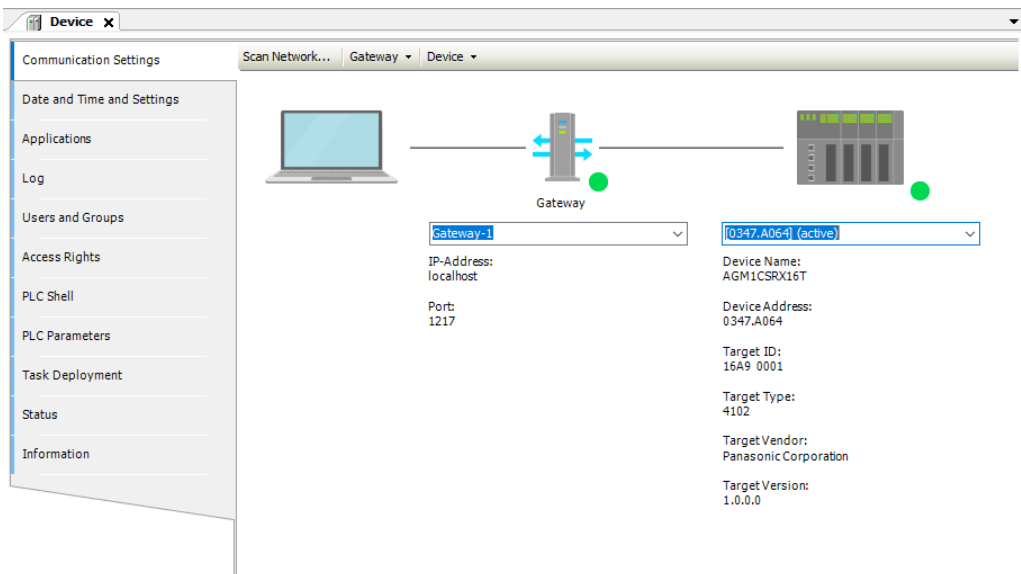

2. From the "Device" menu, select "Options" and then "Add Current Device to Favorites". The connected device will be registered as a favorite device.

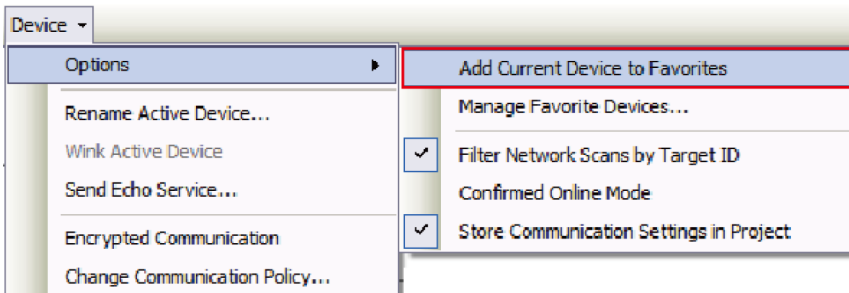

i Info.

- Devices registered as favorite devices can be viewed in the "Manage Favorite Devices" dialog box.

The "Manage Favorite Devices" dialog box can be displayed by selecting "Options" and then "Manage Favorite Devices" from the "Device" menu.

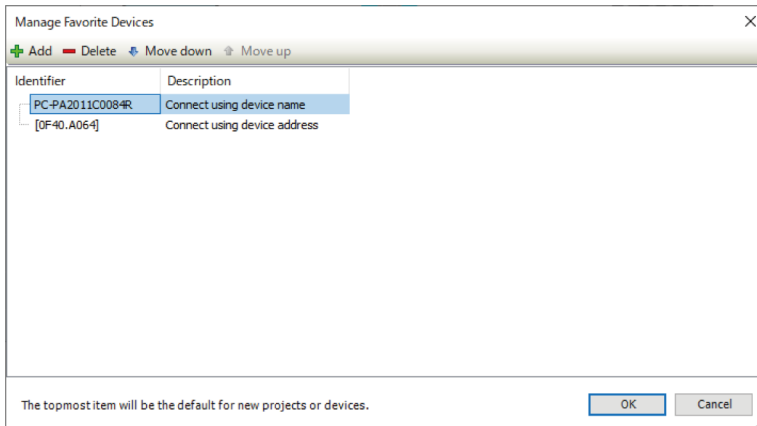

7.8 Other Settings

7.8.4 Confirmed online mode

A confirmation message can be displayed when an attempt is made to implement the following actions.

- Login
- Operation
- Stop
- Single Cycle
- Force Values
- Write values
- Unforce Values

1 2 Procedure

1. Double-click the "Device" object in the navigator pane.

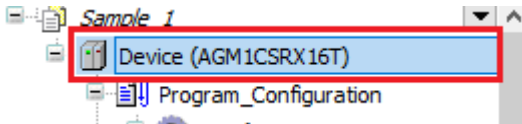

The setting pane will be displayed in the main pane.

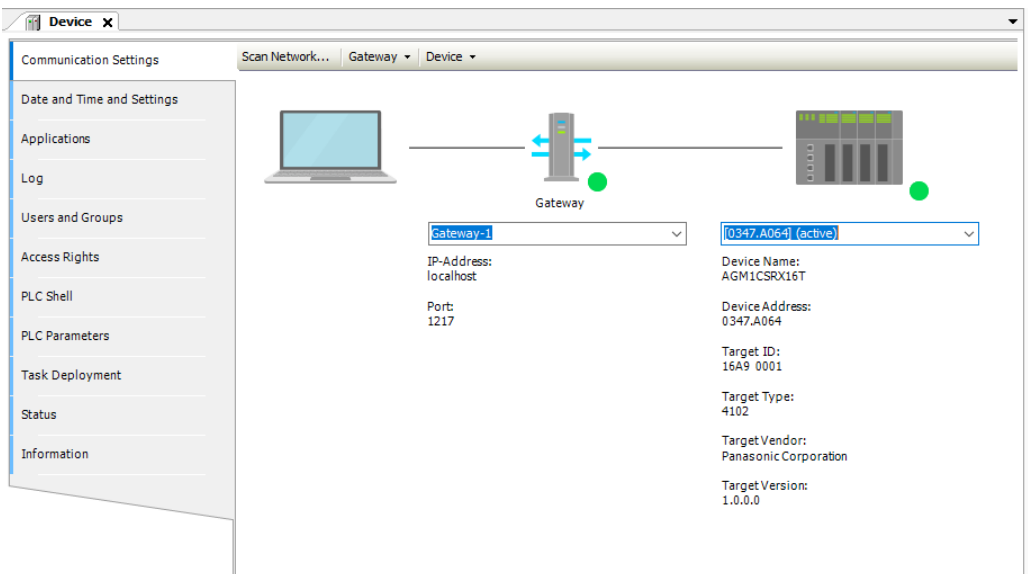

2. From the "Device" menu, select "Options" and then "Confirmed Online Mode".

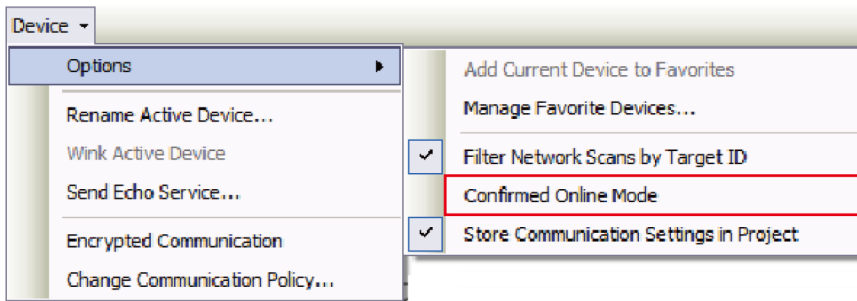

When an attempt is made to log in with "Confirmed Online Mode" selected, the following message is displayed.

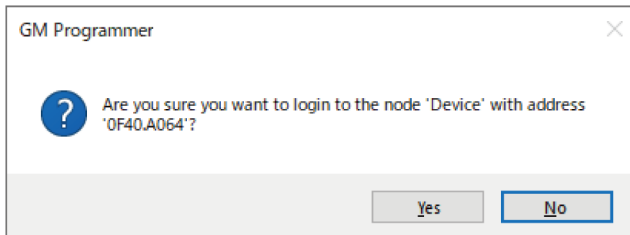

(MEMO)

8 Debug

8.1	Running and Stopping the GM1 Controller	8-3
8.1.1	Running and Stopping the GM1 Controller	8-3
8.1.2	Single Cycle	8-4
8.2	Breakpoint.....	8-6
8.2.1	Setting a Breakpoint.....	8-6
8.2.2	Setting an Execution Point.....	8-8
8.2.3	Call Stack View	8-10
8.3	Debug Operations.....	8-11
8.3.1	Writing Values and Forcibly Changing Values	8-11
8.3.2	Watch	8-13
8.3.3	Flow Control.....	8-14
8.4	Monitoring Function	8-16
8.5	Simulation Function	8-19
8.6	Trace Function	8-20
8.6.1	Setting up Trace.....	8-20
8.6.2	Trace Menu.....	8-29
8.6.3	Executing Trace	8-33
8.6.4	Saving Trace	8-34
8.7	Visualization Function	8-39
8.7.1	Setting of Visualization.....	8-40
8.7.2	Setting of TextList.....	8-56
8.7.3	List of Available Tool Elements	8-64
8.7.4	List of Properties of Tool Elements	8-65
8.7.5	Visualization examples.....	8-86
8.8	Reset of Controller	8-97
8.8.1	Reset Warm, Reset Cold, and Reset Origin	8-98
8.8.2	Executing Device Reset from GM Programmer.....	8-99
8.8.3	Executing Device Reset from GM1 Controller	8-100
8.9	Checking the Status of GM1 Controller	8-101
8.9.1	Checking Logs	8-101
8.9.2	Checking the Status.....	8-103
8.9.3	Checking the System Data History	8-104
8.9.4	Task Monitoring.....	8-104
8.9.5	Device Trace Function	8-105
8.10	Checking the Performance of GM1 Controller.....	8-112
8.10.1	Checking Missing RTEXT Command or EtherCAT Packets	8-112
8.10.2	Performance Check Based on Device Trace	8-114

8 Debug

8.11 Error Notification Function.....	8-116
8.11.1 Overview of Errors.....	8-116
8.11.2 Checking and Clearing Errors Using GM Programmer	8-117
8.11.3 Obtaining Error Information Using User Programs.....	8-118
8.11.4 Error Recovery Processing	8-121
8.11.5 Error Code List	8-123

8.1 Running and Stopping the GM1 Controller

This section explains how to run and stop the GM1 controller and how to run a single cycle operation that is executed in units of a cycle.

8.1.1 Running and Stopping the GM1 Controller

1 2 Procedure

1. After logging in, from the menu bar, select **Debug>Start** or press the <F5> key. The applications downloaded to the GM1 controller will start running.

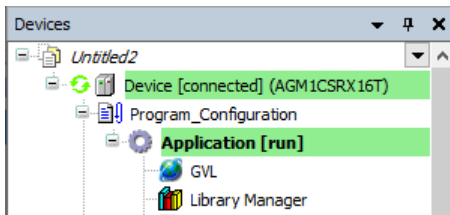

2. From the menu bar, select **Debug>Stop**, or press the <Shift> key + <F8> key simultaneously. The applications will be stopped. During debug operation, you can check the current value of each variable in the declaration section and implementation section.

8.1 Running and Stopping the GM1 Controller

Expression	Type	Value
CurrentTime	TIME	T#0ms
R1	BOOL	FALSE
R2	BOOL	FALSE
X1	BOOL	FALSE
X2	BOOL	FALSE
TON_0	TON	
X3	BOOL	FALSE
TOF_0	TOF	

i Info.

- You can start the GM1 controller by clicking on the toolbar and also stop it by clicking .
- You can select binary, decimal, or hexadecimal as the display format of the variable values to be displayed. From the menu bar, select **Debug>Display Mode** and select a display format from those shown.
- If you select confirmed online mode, a confirmation message will be displayed before you start or stop the GM1 controller. For confirmed online mode, refer to "7.8.4 Confirmed online mode".

8.1.2 Single Cycle

You can execute the application in simulation mode in a single cycle to check whether a created program is executed as intended.

1 2 Procedure

1. After logging in, open the POU.

```
1  iVar2 0 := iVar1 2 + 2; RETURN
```

2. From the menu bar, select **Debug>Single Cycle** or press <Ctrl+F5>.

8.1 Running and Stopping the GM1 Controller

The opened POU will enter a state in which it has been executed in a single cycle.

```
1 |  iVar2 4 := iVar1 2 + 2; RETURN
```

8.2 Breakpoint

8.2 Breakpoint

By setting a breakpoint in a particular position in a program, you can forcibly stop executing the program and check the variable values.

All programming languages support breakpoints.

8.2.1 Setting a Breakpoint

12 Procedure

1. Select a position where you want to set a breakpoint. From the menu bar, select **Debug>Toggle Breakpoint** or press the <F9> key.

The breakpoint will be enabled.

Example: Setting a breakpoint in line 12 in an ST program







```
11 | ● FB_inst.iVar0 0 :=10;
12 | ● FB_inst.iVar1 0 :=20;
13 | ● FB_inst.iVar2 0 :=30;
14 | ● FB_inst() ;
```

If operation is started, the operation will be stopped when the position of the set breakpoint is reached.

```
11 | ● FB_inst.iVar0 10 :=10;
12 | ● FB_inst.iVar1 0 :=20;
13 | ● FB_inst.iVar2 0 :=30;
14 | ● FB_inst() ;
```

In the stopped state, the following debug operations can be executed.

From the menu bar, select "Debug" and then one of the following menu items.

Menu item	Shortcut key	Icon on the toolbar
Step Over	<F10>	
Step Into	<F8>	
Step Out	<Shift> + <F10>	
Run to Cursor	None	
Set next Statement	None	
Show next Statement	None	

To cancel set breakpoints, from the menu bar, select **Debug>Toggle Breakpoint** or click the <F9> key again.

Info.

- You can specify conditions under which operation is stopped when a breakpoint is reached. From the menu bar, select **Debug>New Breakpoint**. The "New Breakpoint" dialog box will be displayed. Select the "Condition" tab and specify conditions under which operation is stopped when a breakpoint is reached.

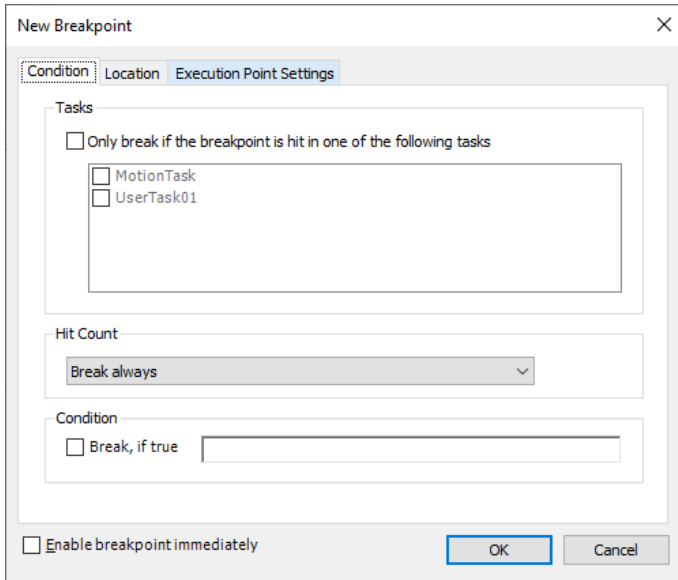

The "New Breakpoint" dialog box is shown with the "Condition" tab selected. It contains the following elements:

- Tasks:** A checkbox labeled "Only break if the breakpoint is hit in one of the following tasks" is unchecked. Below it is a list box containing "MotionTask" and "UserTask01", both with unchecked checkboxes.
- Hit Count:** A dropdown menu is set to "Break always".
- Condition:** A checkbox labeled "Break, if true" is unchecked, followed by an empty text input field.
- Bottom:** A checkbox labeled "Enable breakpoint immediately" is unchecked, and "OK" and "Cancel" buttons are present.

- The Breakpoint view allows the user to check a list of set breakpoints. You can check breakpoint positions, break conditions, and the hit count was reached. You can also add, delete, enable, and disable breakpoints.

To display the Breakpoint view, from the menu bar, select **View>Breakpoint**.

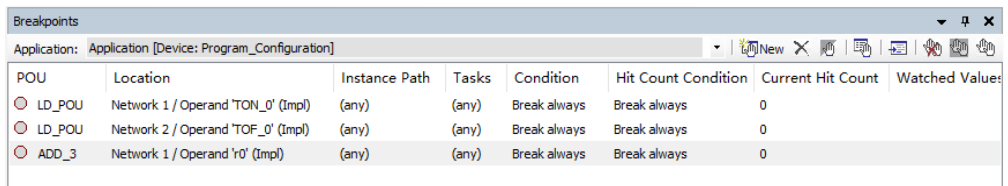

POU	Location	Instance Path	Tasks	Condition	Hit Count Condition	Current Hit Count	Watched Values
LD_POU	Network 1 / Operand 'TON_0' (Impl)	(any)	(any)	Break always	Break always	0	
LD_POU	Network 2 / Operand 'TOF_0' (Impl)	(any)	(any)	Break always	Break always	0	
ADD_3	Network 1 / Operand 'r0' (Impl)	(any)	(any)	Break always	Break always	0	

8.2 Breakpoint

8.2.2 Setting an Execution Point

If an execution point is set, when the position of the execution point is reached, processing that is specified beforehand can be executed and the execution result can be output to the log of the GM1 controller. The application does not stop at the position where an execution point is set.

1.2 Procedure

1. Select a position where you want to set an execution point. From the menu bar, select **Debug>New Breakpoint**.

The "New Breakpoint" dialog box will be displayed.

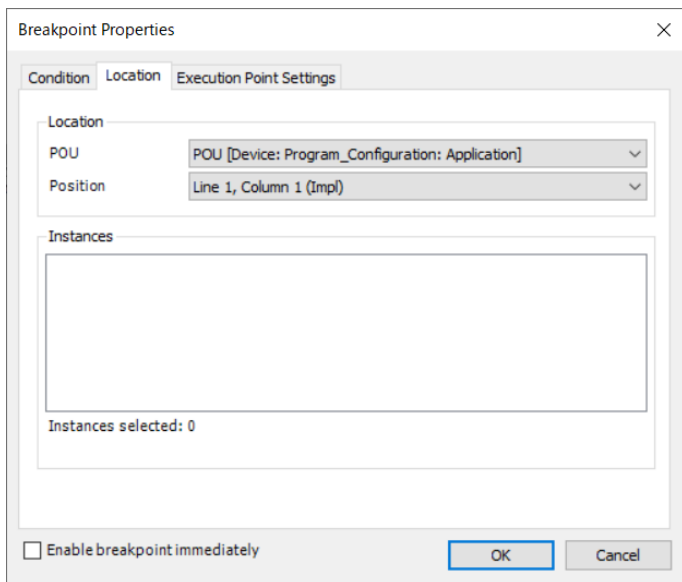

2. Click the "Execution Point Settings" tab.
The Execution Point Settings window will be displayed.

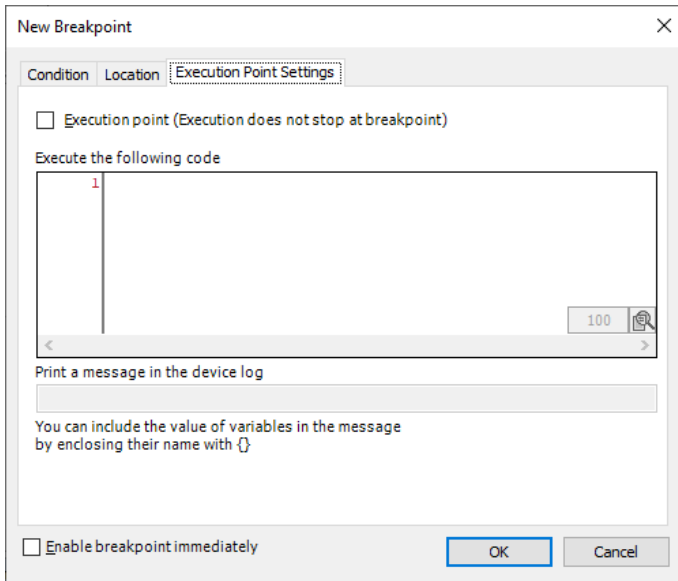

3. Select the "Execution point" check box and enter the code to be executed at the execution point and the message to be output to the log.

In the "Execute the following code" area, enter executable code in structure text format. In the "Print a message in the device log" field, enter the message to be output to the log.

Example: Multiplying the value of "x3" by 5 and outputting the value to the log

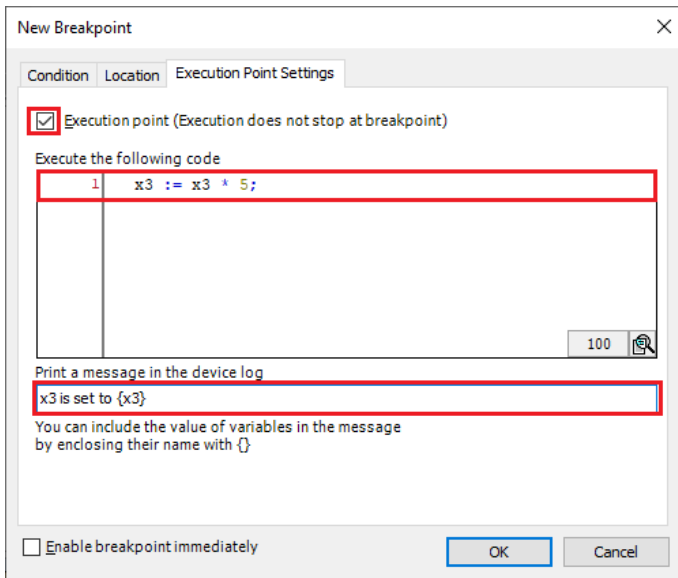

4. Click the [OK] button.

The execution point will be set. When the execution point is enabled, ● appears at the execution point.

8.2 Breakpoint

i Info.

- To output a message to the log when an execution point is reached, from the menu bar, select **Project>Project Settings**. In the "Project Settings" dialog box, select the "Compile options" category. Change the setting in **Setting>Enable logging in breakpoints** to "Enabled".

8.2.3 Call Stack View

In the Call Stack view, you can check a stop position when operation is stopped due to a breakpoint or for some other reason. If the position is called from another block, the position of the block can also be checked.

1 2 Procedure

1. From the menu bar, select **View>Call Stack**.

The Call Stack view will be displayed.



2. Set a breakpoint and stop the application.

The stop position and the POU calling the POU at the stop position will be displayed.

Example: When operation stops at line 1 of function "ADD_3" and "ST_POU" calls "ADD_3"

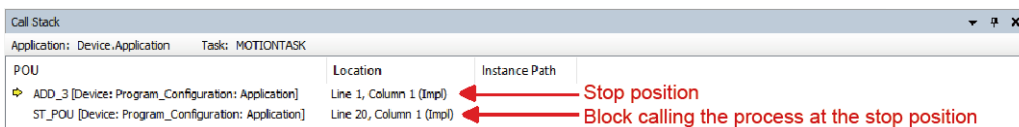

8.3 Debug Operations

This section explains how to perform debug operations such as writing values and watch.

8.3.1 Writing Values and Forcibly Changing Values

Variable values for the GM1 controller can be changed. There are two methods for changing values: Writing values and forcibly changing values.

Writing values: Sets a value (to be changed later) only once. This value can then be changed by the program.

Force Values: Sets a value to be changed in every cycle and maintains the value.

For example, use the following procedure to change the value of Boolean variable "x1" from FALSE to TRUE by writing the value.

1 2 Procedure

1. In the implementation section, double-click the element whose value is to be changed. A new value will be preset.
You can also preset a value by clicking a cell in the "Preset value" column of the declaration section.

The screenshot displays the SIMATIC Manager interface. At the top, there are tabs for 'LD_POU' and 'ADD_3'. Below the tabs, the title bar reads 'Device.Application.LD_POU'. The main area is divided into two sections. The upper section is a table with the following data:

Expression	Type	Value	Prepared value
CurrentTime	TIME	T#0ms	
R1	BOOL	FALSE	
R2	BOOL	FALSE	
X1	BOOL	FALSE	TRUE
X2	BOOL	FALSE	
TON_0	TON		

The lower section shows a ladder logic diagram. A normally open contact labeled 'X1' is connected to the 'IN' input of a timer coil labeled 'TON_0'. The timer coil has a preset time of 'T#5s' and a 'PT' (Preset Time) label. The output of the timer coil is labeled 'Q' and is connected to a coil labeled 'CurrentTime' with a preset time of 'T#0ms'. The 'ET' (Elapsed Time) label is also visible on the timer coil.

2. From the menu bar, select **Debug>Write Values**, or press the <Ctrl> key + <F7> key simultaneously.
The preset value will be written.

8.3 Debug Operations

Expression	Type	Value	Prepared value
◆ CurrentTime	TIME	T#0ms	
◆ R1	BOOL	FALSE	
◆ R2	BOOL	FALSE	
◆ X1	BOOL	TRUE	
◆ X2	BOOL	FALSE	
⊕ TON_0	TON		

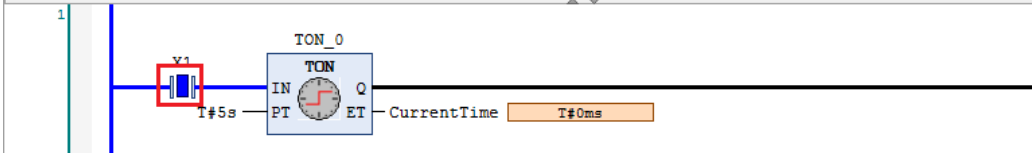

From the menu bar, select **Debug>Force Values**, or press the <F7> key. The variable value will be forcibly changed. **F** appears in front of a variable whose value has been forcibly changed, and then the value will not be updated by the program.

Expression	Type	Value	Prepared value
◆ CurrentTime	TIME	T#0ms	
◆ R1	BOOL	FALSE	
◆ R2	BOOL	FALSE	
◆ X1	BOOL	F TRUE	
◆ X2	BOOL	FALSE	
⊕ TON_0	TON		

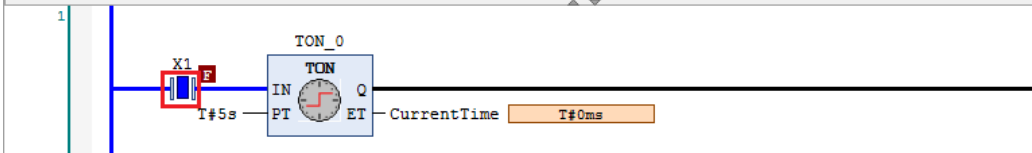

From the menu bar, select **Debug>Unforce Values**, or press the <Alt> key + <F7> key simultaneously. Forced value change will be canceled.

8.3.2 Watch

By registering variables in the watch view, you can perform variable value management such as checking or changing variable values.

You can use up to four watch views (Watch 1 to Watch 4).

For example, use the following procedure to register variable "x1" in watch view "Watch 1".

1 2 Procedure

1. From the menu bar, select **View>Watch>Watch 1**.

Watch view "Watch 1" will be displayed.

Watch 1					
Expression	Application	Type	Value	Prepared value	Execution point

2. Drag the variable "x1" element in the implementation section and drop it in the watch view. Variable "x1" will be registered in the watch view.

You can also register the variable in the watch view by dragging it from the declaration section and dropping it in the watch view.

The diagram shows a ladder logic implementation with a variable **x1** highlighted in a red box. A red arrow points from **x1** to the watch view table below. The watch view table is titled "Watch 1" and contains the following data:

Watch 1					
Expression	Application	Type	Value	Prepared value	Execution point
LD_POU.X1	Device.Application	BOOL	FALSE		Cyclic Monitoring

Red text above the table says: "Drag variable x1 and drop it into the watch view".

This completes the procedure for registering the variable in the watch view. You can check variable values in the Value column.

i Info.

- Variables whose values have been forcibly changed are automatically registered in the "Watch all Forces" view.

From the menu bar, select **View>Watch>Watch all Forces**.

- If an execution point has been set, the timing of display in the watch view can be set to the point in time when the execution point is reached. In the "Execution point" column, select the execution point that has been set. For details on how to set execution points, refer to ["8.2.2 Setting an Execution Point"](#).

8.3 Debug Operations

8.3.3 Flow Control

Flow control enables monitoring to be performed by using different colors in positions where the program is executed and in positions where the program is not executed.

Flow control can be used in LD programs, ST programs, and FBD programs.

1 2 Procedure

1. After logging in, from the menu bar, select **Debug>Toggle Flow Control Mode**.
The flow control notification dialog box will be displayed.

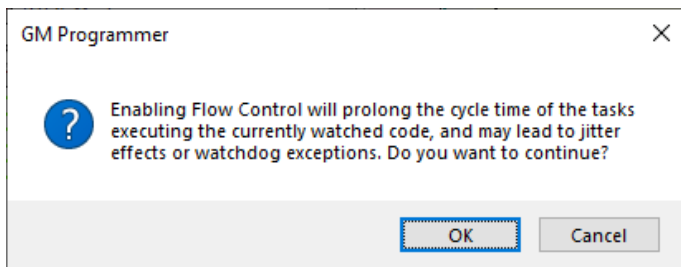

2. Click the [OK] button.
The display will be switched to flow control display.
The positions where the program was executed are displayed in green and the positions where the program was not executed are displayed in white.

Example: Flow control display for LD programs

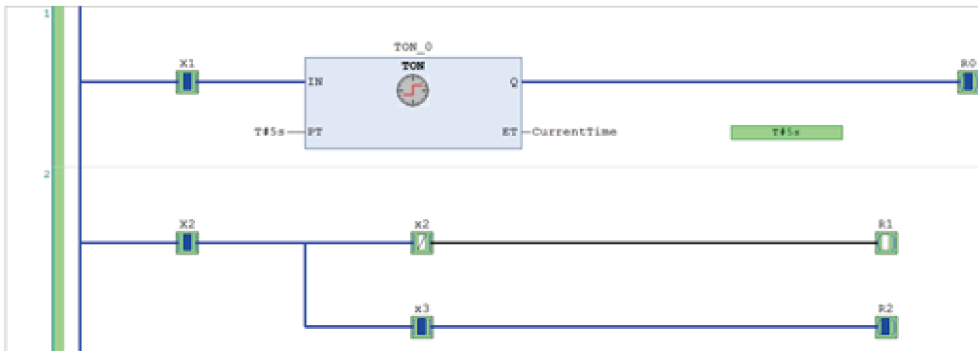

Example: Flow control display for ST programs

```
6 x1 3 := 3;
7 CASE x1 3 OF
8   1: x2 65 := 44;
9   2: x2 65 := 55;
10  3: x2 66 := 66;
11 ELSE x2 65 := 77;
12 END_CASE
13
14 IF (x2 66 = 66) THEN
15   x3 88 := 88;
16   ELSIF (x2 65 = 77) THEN
17     x3 88 := 99;
18 END_IF
```

i Info.

- By using confirmed online mode, you can have a confirmation message dialog box displayed before you execute flow control. For confirmed online mode, refer to "7.8.4 Confirmed online mode".

8.4 Monitoring Function

8.4 Monitoring Function

The monitoring function allows the user to check the variables in the program and the current values of the device parameters in real time while being logged in the GM1 controller.

■ Monitoring variables in the declaration editor

The variables declared in the declaration editor can be monitored.

F appears in front of forcibly changed values. For details on forced value change, refer to "8.3.1 Writing Values and Forcibly Changing Values".

Expression	Type	Value	Prepared value
CurrentTime	TIME	T#0ms	
R1	BOOL	TRUE	
R2	BOOL	FALSE	
X1	BOOL	F TRUE	
X2	BOOL	FALSE	TRUE

Current values

■ Monitoring variables in the implementation section of the program

- Variables can be monitored in the implementation section of the program (inline monitoring).
- The current value is displayed on the right side of each variable, such as **T#1e805ms** or **2**.
- Contacts, coils, and connection lines are displayed in blue when the current value is TRUE.

<Inline monitoring for LD programs>

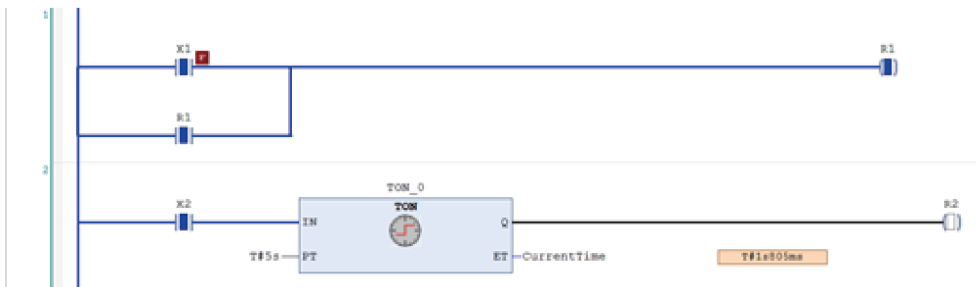

<Inline monitoring for ST programs>

```

1 x1 2 := i1 75 + 1;
2 x2 77 := i2 50 + 2;
3 x3 99 := i3 25 - 1;
4 ADD_3(x1 2, x2 77, x3 99);
5 CASE x1 2 OF
6   1: x2 77 := 44;
7   2: x2 77 := 55;
8   3: x2 77 := 66;
9 ELSE x2 77 := 77;
10 END_CASE
11 IF (x2 77 = 66) THEN
12   x3 99 := 88;
13 ELSIF (x2 77 = 77) THEN
14   x3 99 := 99;
15 END_IF
16 b1 TRUE S= b2 TRUE;

```

i Info.

- Inline monitoring can be disabled. Open the Options window (by selecting **Tools>Options**), select the "Text editor" category and then "Monitoring" tab, and clear the "Enable inline monitoring" check box.

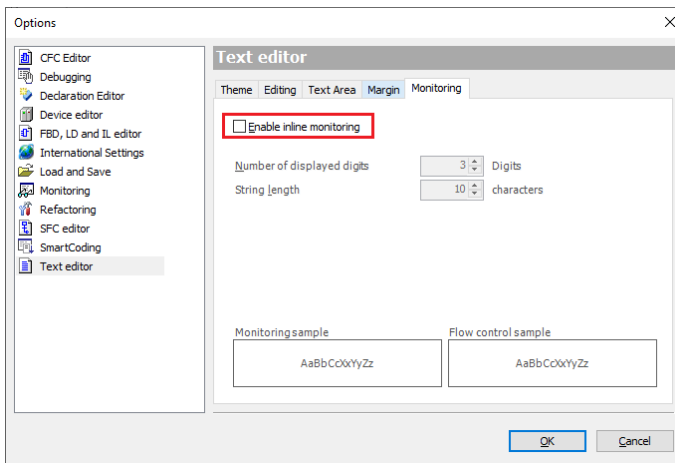

8.4 Monitoring Function

■ Monitoring variables in the watch view

By registering variables in the watch view, you can monitor the variables.

You can use up to four watch views, as well as a dedicated view where variables whose values are forcibly changed are automatically registered.

For details on how to register variables in the watch view, refer to "8.3.2 Watch".

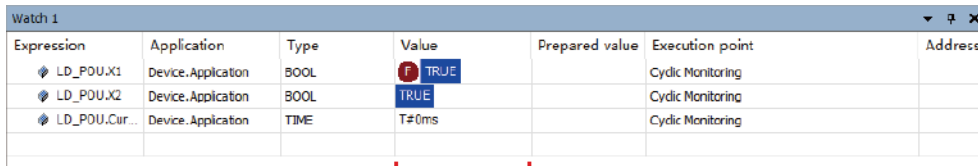

Expression	Application	Type	Value	Prepared value	Execution point	Address
LD_POU.X1	Device.Application	BOOL	 TRUE		Cyclic Monitoring	
LD_POU.X2	Device.Application	BOOL	TRUE		Cyclic Monitoring	
LD_POU.Cur...	Device.Application	TIME	T#0ms		Cyclic Monitoring	

Current values

8.5 Simulation Function

Simulation mode allows the user to perform a login operation without connecting to the GM1 controller. It also allows the user to check behaviors in the same way as if the user logged in.

1 2 Procedure

1. From the menu bar, select **Online>Simulation**.

Simulation mode will be invoked and "Simulation" will be displayed on the status bar.

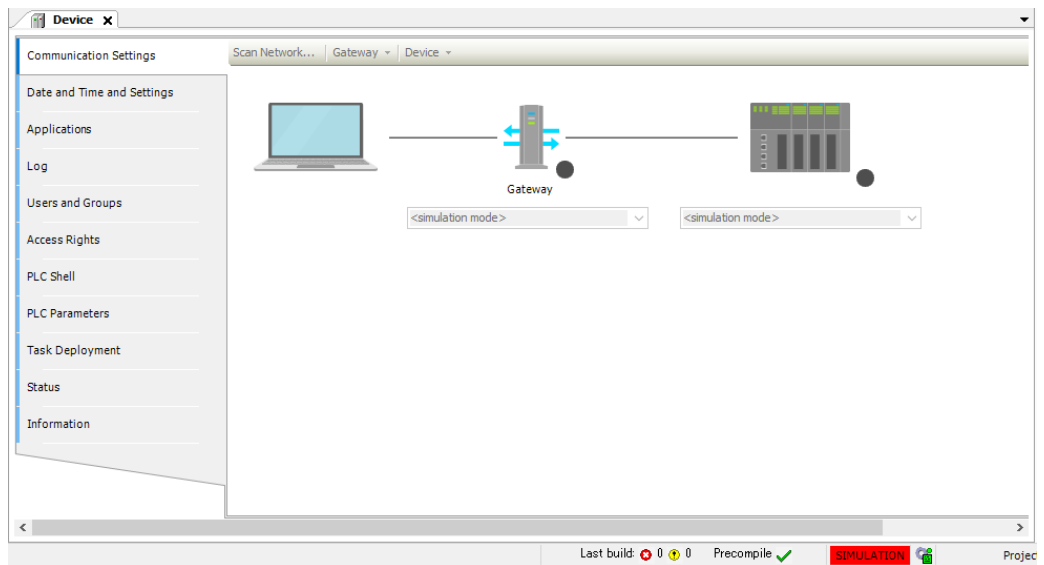

2. From the menu bar, select **Online>Login**, or press the <Alt> key and the <F8> key simultaneously.

Login will occur in simulation mode. When login occurs in simulation mode, the device object is displayed in italic.

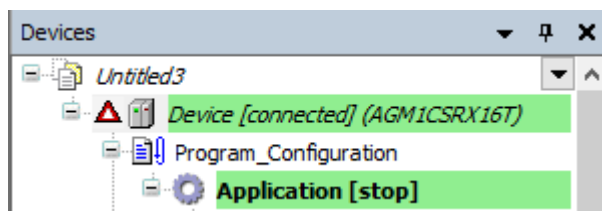

Simulation will start.

i Info.

-  is displayed in front of the object of a device that is operated in simulation mode.

8.6 Trace Function

8.6 Trace Function

The trace function allows variable value changes in the GM1 controller over time to be displayed in graph form and be checked. Thus, you can check a motion operation locus and log whether a process or communication computed at high speeds is properly dealt with. You can save obtained trace data in an external file and check such data by an external tool. Saved files can also be read offline.

8.6.1 Setting up Trace

To use the trace function, after adding a trace object, you must register variables to be traced. This section describes a procedure for setting up a trace.

1 2 Procedure

1. Right-click Application in the navigator pane and then select “Add Object>Trace” from the menu that is displayed.
The "Add Trace" dialog box will be displayed.

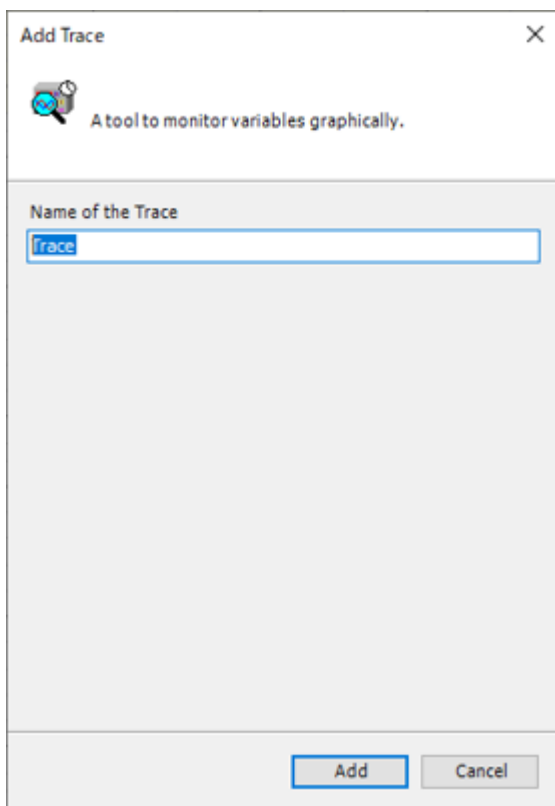

2. Enter a desired trace name and click the “Add” button.
When the trace is added, a trace object screen appears.

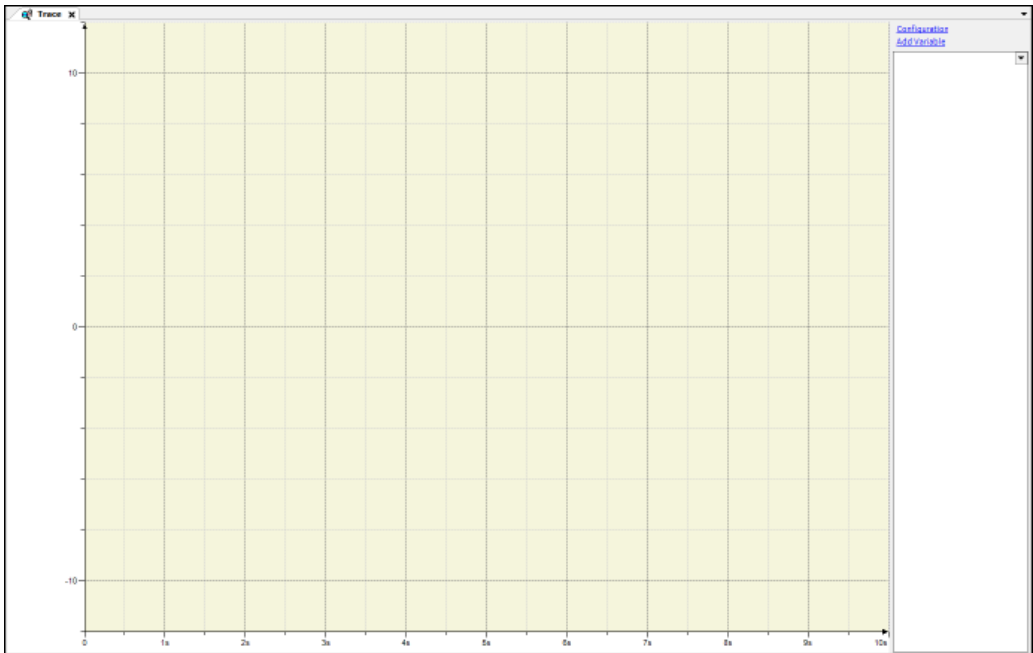

3. Configure trace settings.

Click "Configuration" at the upper right of the object screen to display the settings pane. Configure record settings shown in the table below and after that, click the OK button.

- Record settings
Trigger and record time settings can be primarily configured.

8.6 Trace Function

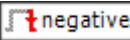
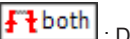
Setting items	Overview
Enable Trigger	Trigger is enabled. If trigger is not enabled, data is always sampled after the start of a trace, and old data is deleted depending on the number of samples.
Trigger variable / parameter	Set a variable that constitutes a trigger condition. When the variable is an integer or a real number other than Booleans, you must set a trigger level.
Trigger edge	Set a trigger detection edge. <ul style="list-style-type: none"> •  : Detect a rising edge •  : Detect a falling edge •  : Detect both rising / falling edges
Posttrigger (samples)	Set the number of samples recored after detection of a trigger. Record time depending on the number of samples set at the right side is displayed.
Trigger Level	Set a value at which an edge is detected according to the variable set in Trigger edge.
Task ^(Note 1)	Select a task from MotionTask and a created UserTask. The cycle of the selected task is a cycle of the trace.
Record condition	Set a condition for executing a trace. A trace is executed only when the set condition is met. Description example: Trace_Record (Boolean type) = TRUE, Axis.Velocity (Integer type) = 100
Comment	Write a comment. If data is saved in a trace file and a trace dump file, details of the comment are also output.
Resolution	Set trace time resolution. You can select us or ms. ^(Note 2)
Automatic restart	Do not use.
Advanced settings	Details will be described later.

(Note 1) To start the trace function, you must set a task.

(Note 2) You must set the trace resolution that is smaller than the task cycle. If the task cycle is 1 ms or less, you must set the trace resolution to us.

- **Advanced trace settings**

The number of measurement cycles and a buffer size can be specified. Click the [Advanced...] button to display the setting window.

<EtherCAT>

Advanced Trace Settings

Measure in every n-th cycle: 1 4ms

Recommended runtime buffer size (samples): 501 2s

Override runtime buffer size

Trace editor buffer size per variable (samples): 10001 40s

OK Cancel

<RTEX>

Advanced Trace Settings

Measure in every n-th cycle: 1

Recommended runtime buffer size (samples):

Override runtime buffer size: 501

Trace editor buffer size per variable (samples): 10001

OK Cancel

Setting items	Overview
Measurement frequency (number of cycles)	Set a sampling interval. ^(Note 3) Sampling interval = Number of cycles × task cycle Settable number of cycles: 1 to 20, 100, 200, 500, 1000
Recommended runtime buffer size (sample)	A value is automatically specified to suit the set measurement frequency (number of cycles). This setting is not displayed in RTEX. ^(Note 3)
Override runtime buffer size	You can change the runtime buffer size. When the check box is not selected, the recommended runtime buffer size is adapted. ^(Note 3)
Trace editor buffer size for each variable (sample)	Set the maximum sampling number for each variable. When the maximum sampling number is exceeded, pieces of the sampling data are deleted in the order of their occurrence. ^{(Note 3)(Note 4)}

(Note 1) In RTEX, record time depending on the set number of samples is not displayed.

(Note 2) You must set this buffer size to at least twice the runtime buffer size.

4. Next, register a variable to be traced.

Click "Add variable" at the upper right of the object screen to display the Variable settings pane.

8.6 Trace Function

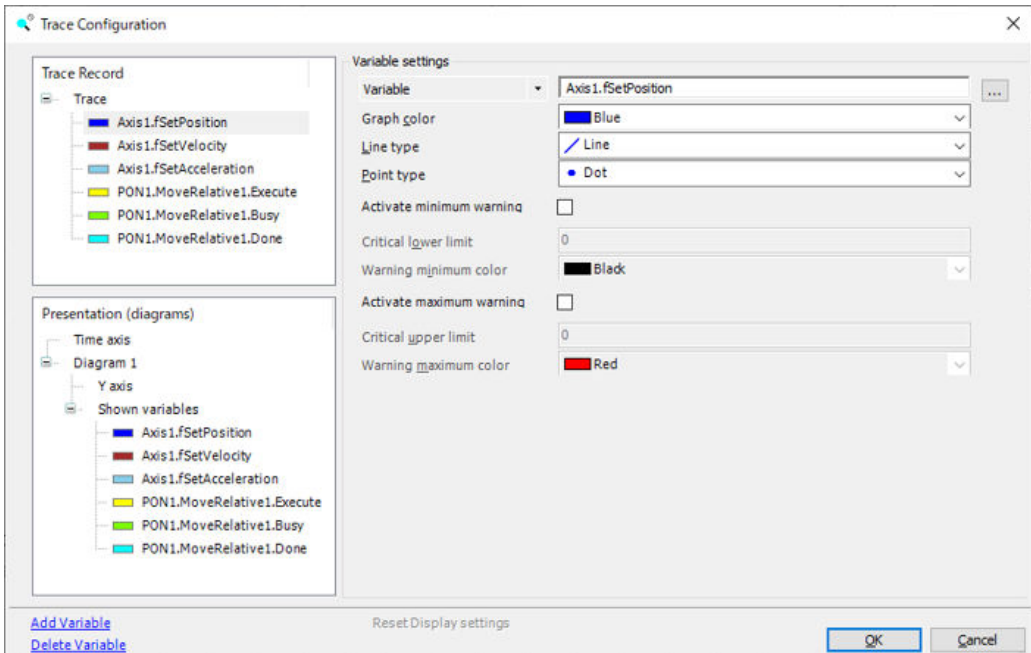

5. Enter a variable you want to trace and set a line color, type, and other items.

Either directly enter a variable or click the  button to select a desired variable from the Input Assistant window. The registered variables are displayed in the Trace Record pane at the upper left.

- Variable settings

You can set a graph color and line/point types for the variable.

Setting items	Overview
Variable / Parameter	Specify a variable or parameter to be traced.
Graph color	Set the line color of the graph.
Line type	Set the line type of the graph.
Point type	Set the point type of the graph.
Activate minimum warning	When the trace value is smaller than the critical lower limit, the graph is displayed in warning minimum color.
Critical lower limit	Set the lower limit for minimum warning.
Warning minimum color	Set the color of the graph for minimum warning.
Activate maximum warning	When the trace value is larger than the critical upper limit, the graph is displayed in warning maximum color.
Critical upper limit	Set the upper limit for maximum warning.
Warning maximum color	Set the color of the graph for maximum warning.

6. Configure diagram settings.

From the Presentation (diagrams) pane at the lower left, you can configure diagram settings. Configure settings to add a diagram or assign a variable to be traced.

- Diagram settings

You can add a diagram and set a background color. Click “Diagram” to display the settings pane on the right side. For two or more diagrams, settings of each diagram can be configured.

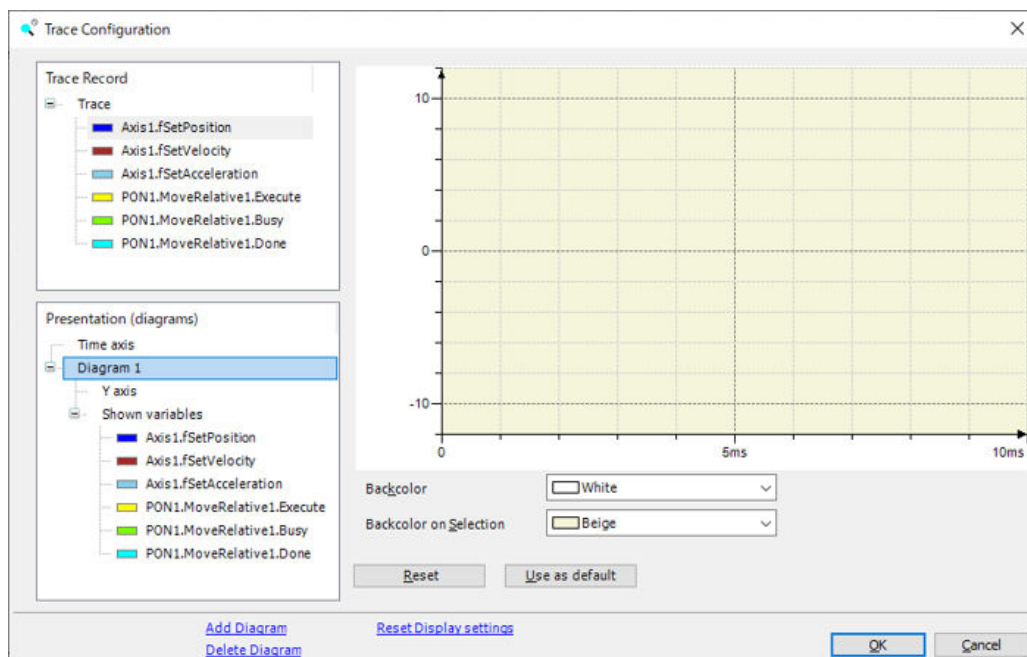

Setting items	Overview
Add Diagram	Add one diagram you want to display on the trace screen.
Delete Diagram	Delete the specified diagram.
Reset Display settings	All display settings return to default values.
Backcolor	Set the background color of the diagram.
Backcolor on Selection	Set the background color of the diagram that is selected (active).
Reset	Display settings of the diagram return to default values.
Use as default	Default display settings of diagrams change to the current settings.

- Setting of assigning variable to be displayed on diagram

Assign a variable to be displayed on the diagram. Right-click “Shown variables” to display a menu for variable assignment.

8.6 Trace Function

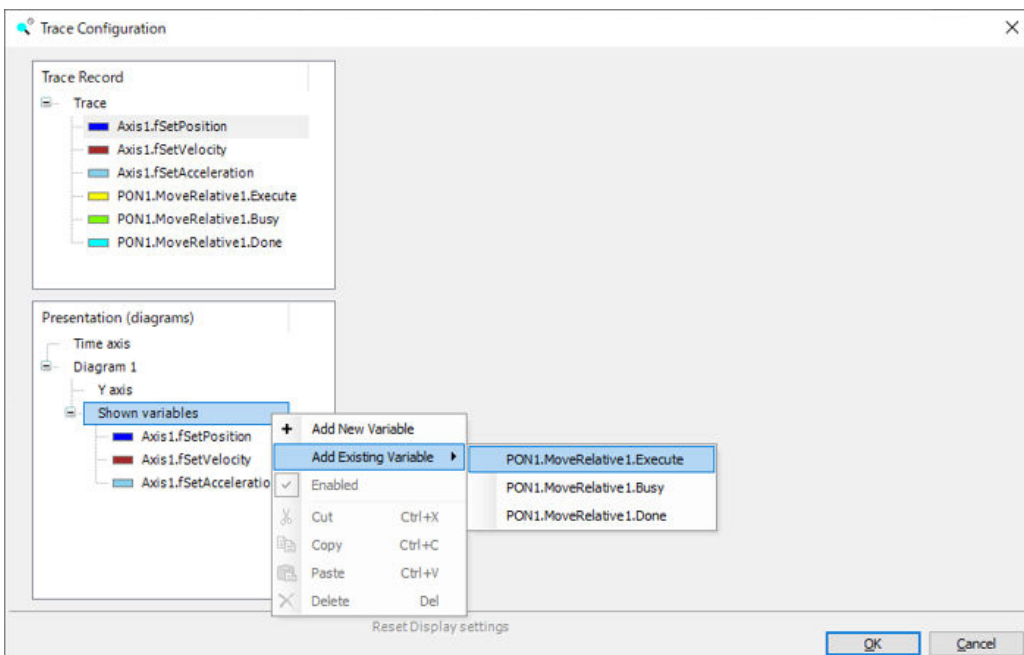

Setting items	Overview
Add new variable	A new variable to be traced is registered and added to the diagram.
Add existing variable	Select a registered variable to add it to the diagram.

- Time axis settings

Click “Time axis” in the Presentation pane to display the settings pane on the right side.

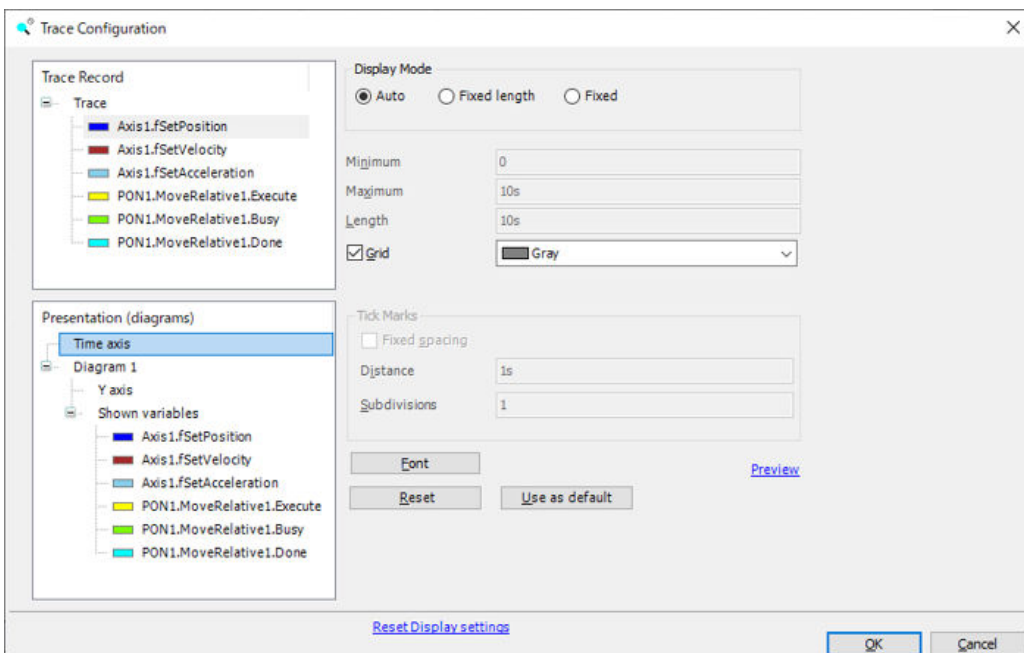

Setting items		Overview
Display Mode		Set the time axis display mode. <ul style="list-style-type: none"> • Auto: Time axis tick marks suitable for the trace are automatically displayed. • Fixed length: The display width of the time axis is fixed to a value set in "Length" and the time axis is displayed by automatic scrolling. • Fixed: The time axis is displayed in a range between points that are fixed to values set in "Minimum" and "Maximum".
Grid		A grid that fits tick marks is displayed. Also set the color of the grid.
Tick Marks	Fixed spacing	The space between the tick mark and auxiliary tick mark can be set. (Note 5)
	Distance	Set the space between tick marks in units of time.
	Subdivisions	Sets the number of auxiliary tick mark.
Font		Set the display font of the time axis.
Preview		Display a preview.
Result		Time axis settings return to default values.
Use as default		Default time axis settings change to the current settings.

(Note 1) The auto display mode cannot be specified.

• Y axis settings

Click "Y axis" to display the settings pane on the right side.

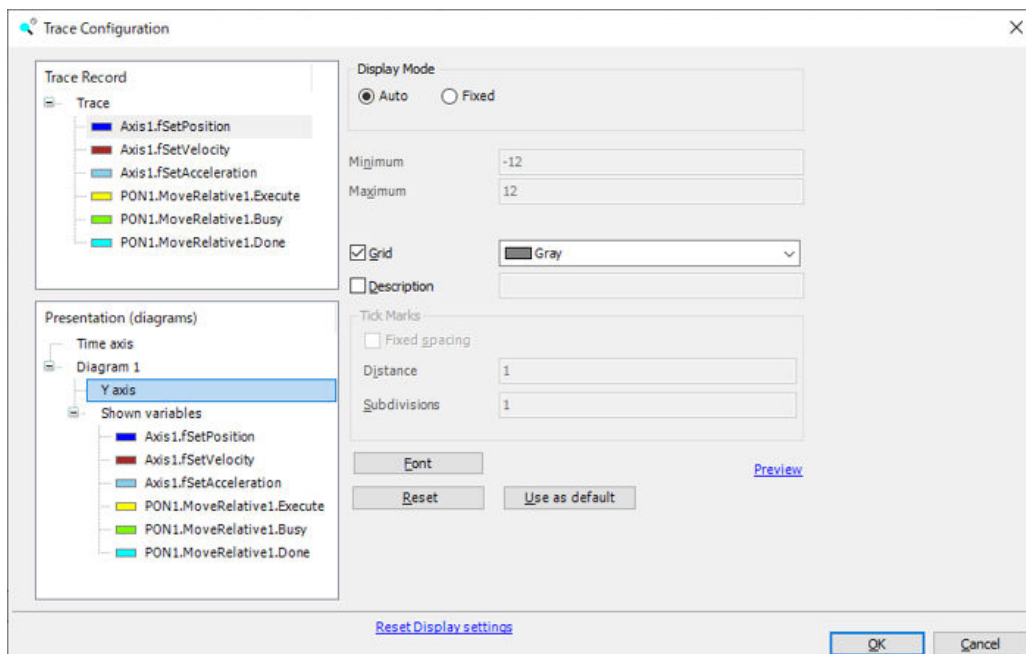

Setting items		Overview
Display mode		Set the Y axis display mode. <ul style="list-style-type: none"> • Auto: Y axis tick marks suitable for the trace are automatically displayed.

8.6 Trace Function

Setting items		Overview
		<ul style="list-style-type: none">Fixed: The Y axis is displayed in a range between points that are fixed to values set in "Minimum" and "Maximum".
Grid		A grid that fits tick marks is displayed. Also set the color of the grid.
Description		Display a label on the Y axis.
Tick Marks	Fixed spacing	The space between the tick mark and auxiliary tick mark can be set. (Note 6)
	Distance	Set the space between tick marks in units of time.
	Subdivisions	Sets the number of auxiliary tick mark.
Font		Set the display font of the Y axis.
Preview		Display a preview.
Result		Y axis settings return to default values.
Use as default		Default Y axis settings change to the current settings.

(Note 1) The auto display mode cannot be specified.

7. After the settings are configured, click the "OK" button.

This completes the procedure for registering variables to be traced and configuring trace settings.

8.6.2 Trace Menu

The trace menu allows you to perform actions, such as operating a trace or the display screen and saving a file, on the trace object.

■ Trace menu

To display the trace menu, select Trace from the menu bar or right-click the trace screen with the mouse cursor put on it.

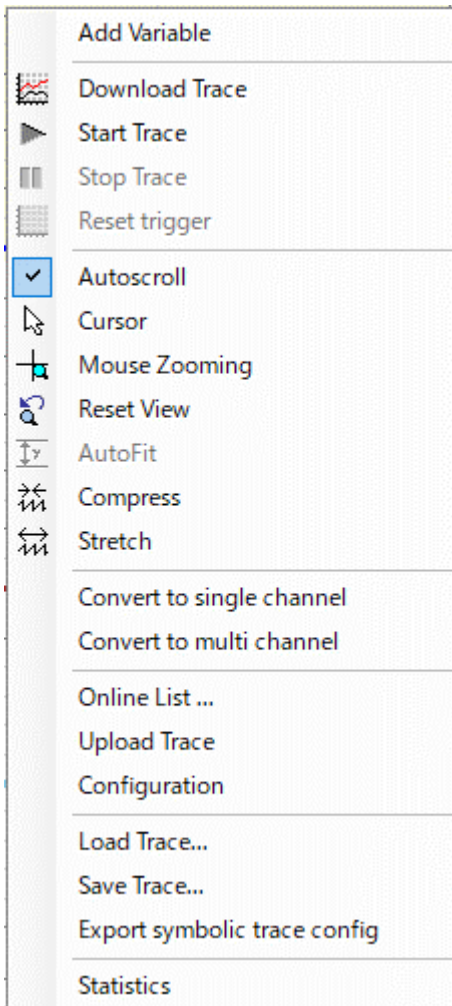

Setting items	Overview
Add Variable	The Variable settings pane (Trace Configuration) appears.
Download Trace	A trace is downloaded and starts.
Start Trace	The stopped trace starts again.
Stop Trace	Stop the active trace.

8.6 Trace Function

Setting items	Overview
Reset trigger	Reset the trigger in progress and put the trace in a state of waiting for trigger again.
Autoscroll	The trace screen automatically scrolls in response to the latest trace data.
Cursor	A maximum of two cursors can be displayed. A trace value at the cursor place is displayed.
Mouse Zooming	The mouse pointer changes to a zoom cursor to allow a selected trace part to be enlarged.
Reset View	Trace object display settings return to default values.
AutoFit	The Y axis tick marks of the diagram are automatically optimized.
Compress	Shorten the time (X) axis of the diagram.
Stretch	Lengthen the time (X) axis of the diagram.
Convert to single channel	Display all variables registered in Trace Record on one diagram.
Convert to multi channel	Display all variables registered in Trace Record on separate diagrams.
Online List	Display a list of variables saved in the runtime buffer.
Upload Trace	Display trace data saved in the runtime buffer.
Configuration	The Trace Configuration window appears.
Load Trace	A trace file (.trace / .trace.csv) is imported and displayed.
Save Trace	The trace is saved as a trace file (.trace / .txt / .trace.csv).
Export symbolic trace config	Not supported. Do not use.
Statistics	Display trace statistics. Display the upper limit, lower limit, mean value, median, root-mean-square (RMS), and suchlike of trace data by variable.

Info.

- Diagram reduction/enlargement

You can reduce or enlarge a diagram by operating a mouse or a keyboard. The operation method is shown below.

Operation items	Mouse operation	Keyboard operation
Shorten time (X) axis	Rotate the mouse wheel rearward.	"_"
Lengthen time (X) axis	Rotate the mouse wheel forward.	"+"
Shorten Y-axis	With "Ctrl" held depressed, rotate the mouse wheel rearward.	"Ctrl" + "-"
Lengthen Y-axis	With "Ctrl" held depressed, rotate the mouse wheel forward.	"Ctrl" + "+"

■ **Cursor Function**

A maximum of two cursors can be displayed on the trace screen, and a value at the cursor place can be displayed. Whenever you select Trace>Cursor from the menu bar, the cursor display toggles through “one cursor display > two cursors display > no cursor display”. Values are displayed under the name of each variable on the right side of the trace object, as shown below.

A value at the left cursor place | A value at the right cursor place | A Δ value (the value at the right cursor place - the value at the left cursor place)

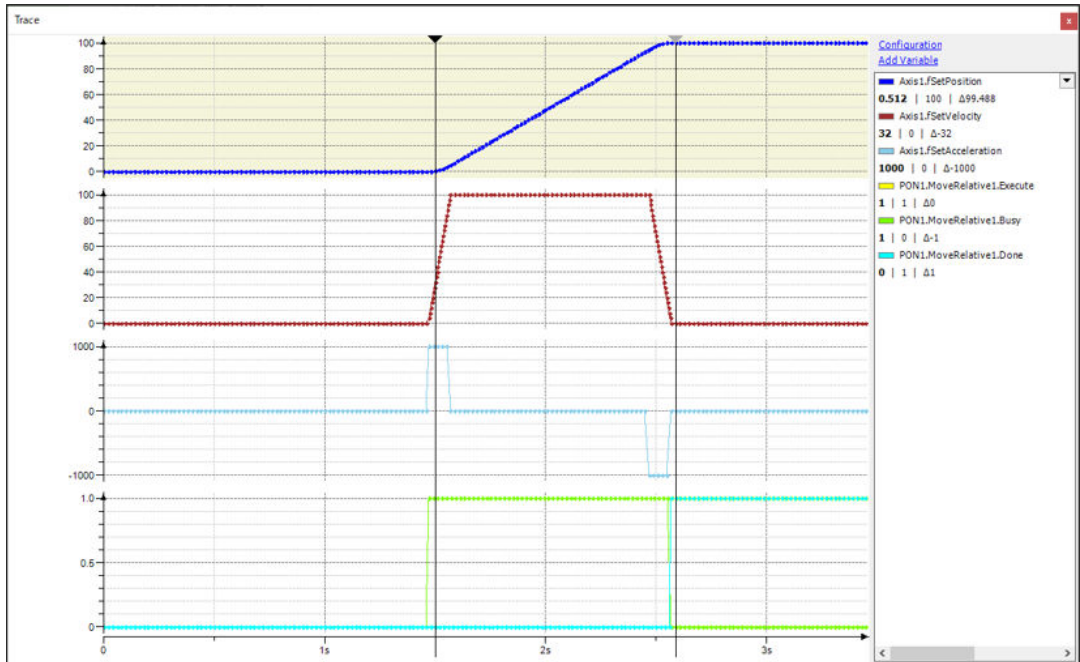

■ **Trace Statistics Function**

The trace statistics function is used to display the upper limit, lower limit, mean value, median, root-mean-square (RMS), and suchlike of trace data by variable. When you select **Trace>Statistics** from the menu bar, trace statistics are displayed as shown below. For two cursors display, statistics of trace data between the cursors are displayed.

Trace Statistics 1s511ms866us - 2s613ms526us (Δ 1s101ms658us)

Signal	Index	N	Min	Avg	Median	RMS	StdDev	Max	Integral	Min Δt [s]	Avg Δt [s]	Median Δt [s]	StdDev Δt [s]	Max Δt [s]
Axis1.FsetPosition	0	271	0.392	51.6578302583026	51.8	60.2046662319663	30.9192199750799	100	57.2728800000001	0.003	0.0041	0.004	0.00034651745...	0.006
Axis1.FsetVelocity	1	271	0	91.9409594095941	100	94.4161564168292	21.477210665021	100	102.112	0.003	0.0041	0.004	0.00034651745...	0.006
Axis1.FsetAcceleration	2	271	-1000	-25.830258302583	0	399.069903826181	398.233079861353	1000	-29	0.003	0.0041	0.004	0.00034651745...	0.006
PONI.MoveRelative1.Execute	3	271	1	1	1	1	1	0	1.107	0.003	0.0041	0.004	0.00034651745...	0.006
PONI.MoveRelative1.Busy	4	271	0	0.9889288928893	1	0.994469927061558	0.104824185573267	1	1.099	0.003	0.0041	0.004	0.00034651745...	0.006
PONI.MoveRelative1.Done	5	271	0	0.011070110701107	0	0.105407102379458	0.104824185573267	1	0.008	0.003	0.0041	0.004	0.00034651745...	0.006

Close

8.6 Trace Function

■ Variable Menu

To display the variable menu, right-click a registered variable on the right side of the trace screen with the mouse cursor put on it. The selected variable can be operated.

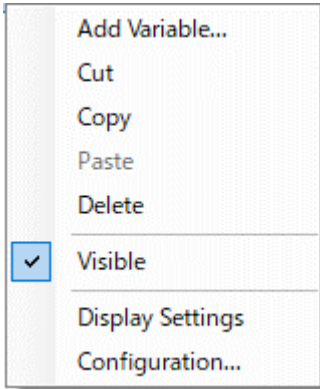

Setting items	Overview
Add Variable	The Variable settings pane (Trace Configuration) appears.
Cut	Cut the selected variable.
Copy	Copy the selected variable.
Paste	Paste the copied variable.
Delete	Delete the selected variable.
Visible	The diagram display for the selected variable switches. With check box selected: Display, With check box not selected: No display
Display settings	The Display settings pane (Trace Configuration) appears.
Configuration	The Trace Configuration window appears.

8.6.3 Executing Trace

By executing a trace, you can check values of the variables registered in the object.

1 2 Procedure

1. Connect the PC where GM Programmer is installed and the GM1 controller and log in to the GM1 controller.
2. From the menu bar, select “Trace > Download Trace”.

A trace will be started. The values of the variables assigned to each diagram are recorded, and trace data is displayed in graph form.

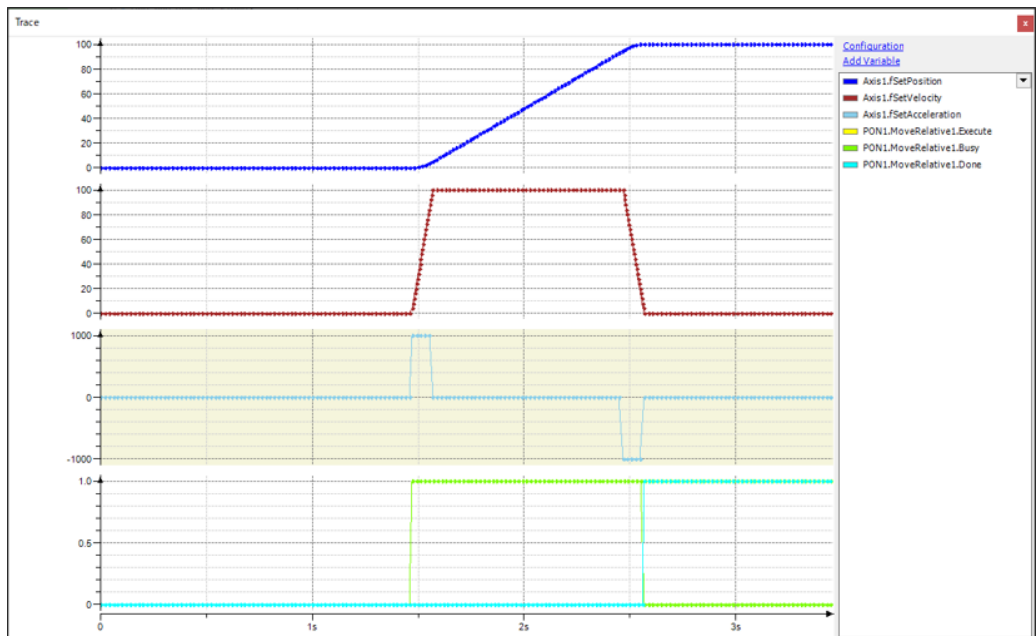

3. From the menu bar, select “Trace > Stop Trace”.
The trace will be stopped. To automatically stop the trace, enable Trigger in the trace settings.

8.6 Trace Function

8.6.4 Saving Trace

Data recorded through execution of the trace can be saved.

1 2 Procedure

1. From the menu bar, select “Trace > Save Trace”.
2. The Save Trace pop-up window appears. Specify a destination where the trace data is saved, as well as a file name. From the File Type menu, select a file format in which the trace data is saved.

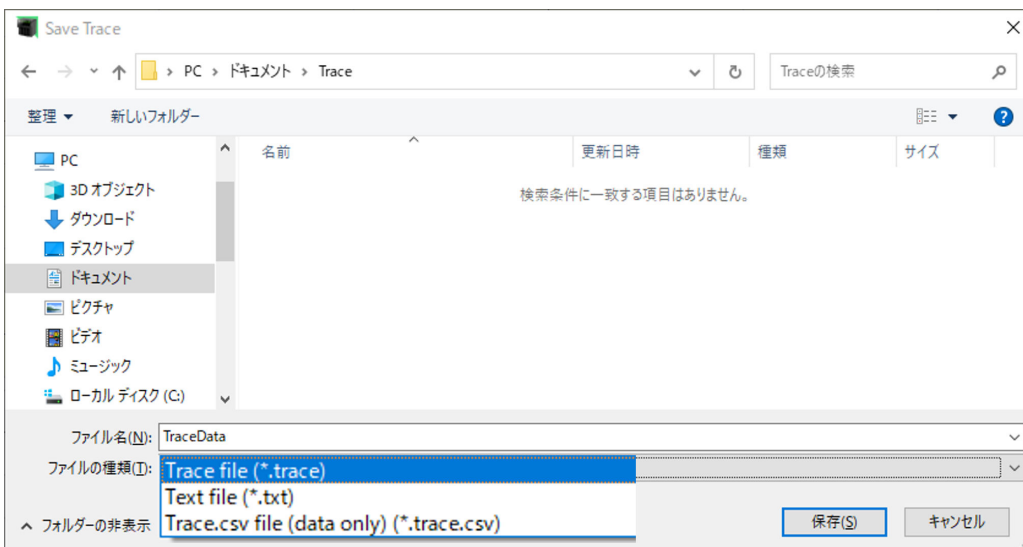

3. After the settings are configured, click the “Save” button.
4. If the data is saved in trace file (*.trace) format, you can open it on the trace object screen by selecting “Trace > Load Trace” from the menu bar.

Trace File Types

There are three trace file formats.

Through the trace file (.trace) format, all of recorded variable values (hereinafter referred to as trace data) and trace configuration data can be saved. By importing a file saved in this format, you can display a trace waveform identical to that shown when the file was saved. A file in trace file format can be imported offline to change the save format to trace dump file or text file.

Thus, when you use such data, you are recommended to save it in trace file (.trace) format.

Setting items	Extension	Overview
Trace file	*.trace	Trace data and trace configuration data are output in XML format. You can import output trace files and analyze trace data offline.
Trace dump file	*.trace.csv	Trace data and part of trace configuration data are output in CSV format. You can import output trace files and analyze trace data offline. (Note 1)
Text file	*.txt	Trace data is output in text (ASCII) format. You can edit such a file using an external tool. However, text files cannot be imported.

(Note 1) To output a trace dump file, do not set any record condition in the record settings.

Examples of Output Trace Files

Examples in which trace object data as shown below is output into trace file.

Variable0 = Axis1.fSetPosition, Variable1 = Axis1.fSetVelocity

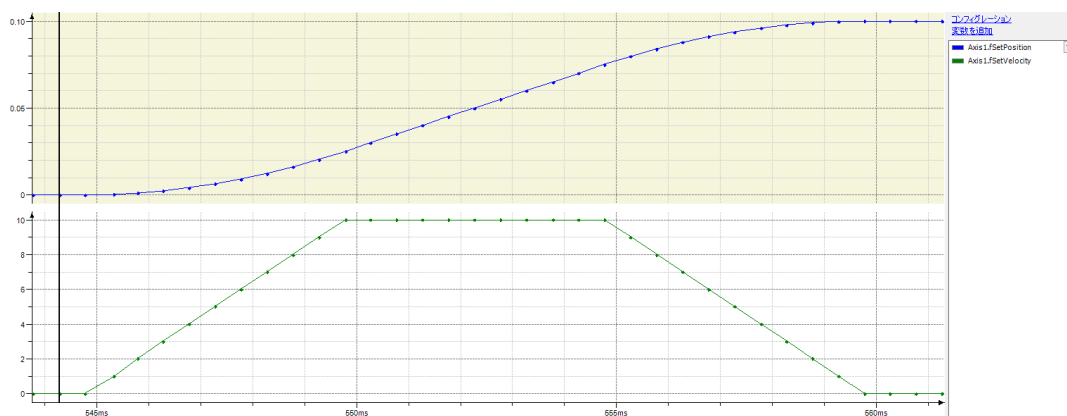

8.6 Trace Function

Example of output trace file (.trace)

```
<Trace>
<TraceConfiguration>
  <Single xml:space="preserve" Type="{f7aa3620-8073-4c91-b6ec-86ed9eb60303}" Method="IArchivable">
  <Dictionary Type="System.Collections.Hashtable" Name="TraceDataConfig" />
  <Dictionary Type="System.Collections.Hashtable" Name="TraceOutputConfig" />
  :
  : Configuration Data
  : Trigger setting Data
  : Variable setting Data
</TraceConfiguration>
<TraceData Version="1.0.0.0">
  <TraceRecord>
    <TriggerState>3</TriggerState>
    <StartTime>10534190988</StartTime>
    <TriggerStartDate>2022/11/11 1:11:11</TriggerStartDate>
    <TriggerTimeStamp>10534609669</TriggerTimeStamp>
    <TriggerHistory>418681</TriggerHistory>
    <TraceVariable VarName="Axis1.fSetPosition" VariableIndex="0" Type="System.Double">
      <Values>0,0.00025,0.001,0.00225,0.004,0.00625,0.00901,0.01225,0.016,0.02025,0.02505,0.03006,
        0.035,0.04008,0.04505,0.05,0.05507,0.06005,0.065,0.07,,,</Values> Trace Data (Axis1.fSetPosition)
    <Timestamps>419187,419734,420175,420676,421205,421678,422176,422676,423188,423677,424182,424681,
      425210,425675,426175,426681,427196,427676,428177,428676,,,</Timestamps>
    </TraceVariable>
    <TraceVariable VarName="Axis1.fSetVelocity" VariableIndex="0" Type="System.Double">
      <Values>0,1,2,3,4,5,6,7,8,9,0.018,10,10,10,
        10,10,10,10,10,10,10,10,,,</Values> Trace Data (Axis1.fSetVelocity)
      <Timestamps>419187,419734,420175,420676,421205,421678,422176,422676,423188,423677,424182,424681,
        425210,425675,426175,426681,427196,427676,428177,428676,,,</Timestamps>
    </TraceVariable>
  </TraceRecord>
</TraceData>
</Trace>
```

Example of output trace dump file (.trace.csv)

```

[key]; [value]
Version; 0x03050000
Name; Application.Trace
ApplicationName; Application
ApplicationDataGuid; 00000000-0000-0000-0000-000000000000
IecTaskName; MotionTask
Comment; Trace_Coment
:
: Configuration Data
: Trigger setting Data
: Variable0 setting Data
:
0.Data;
; 419187; 0
; 419734; 0.00025
; 420175; 0.001
; 420676; 0.00225
; 421205; 0.004
; 421678; 0.00625
; 422176; 0.00901
:
1.Variable; Axis1.fSetVelocity
:
: Variable1 setting Data
:
1.Data;
; 419187; 0
; 419734; 1
; 420175; 2
; 420676; 3
; 421205; 4
; 421678; 5
; 422176; 6
:

```

8.6 Trace Function

Example of output text file (.txt)

```
GM Programmer V** Trace: Trace
E:¥GMP_Trace.project
Timestamp(µs) Axis1.fSetPosition Axis1.fSetVelocity
191 0 0
687 0 0
1198 0 0
1686 0 0
2186 0 0
2684 0 0
3184 0 0
```

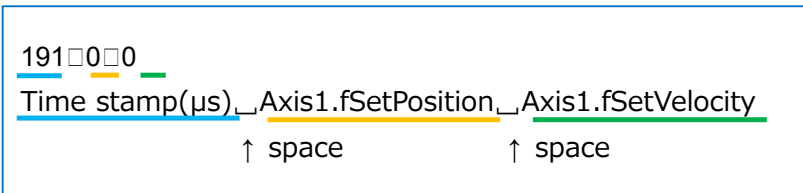

```
:
419187 0 0
419734 0.00025 1
420175 0.001 2
420676 0.00225 3
421205 0.004 4
421678 0.00625 5
422176 0.00901 6
422676 0.01225 7
423188 0.016 8
423677 0.02025 9.0018
424182 0.02505 10
424681 0.03006 10
425210 0.035 10
425675 0.04008 10
426175 0.04505 10
426681 0.05 10
427196 0.05507 10
427676 0.06005 10
428177 0.065 10
428676 0.07 10
:
```

8.7 Visualization Function

By using the visualization function, POU variables can be read or written from the tool elements such as switches and check boxes that are placed on the visualization object. It can be used when performing a debug or other application.

You can create a visualization object that can be used to check parameters during axis operation as shown below.

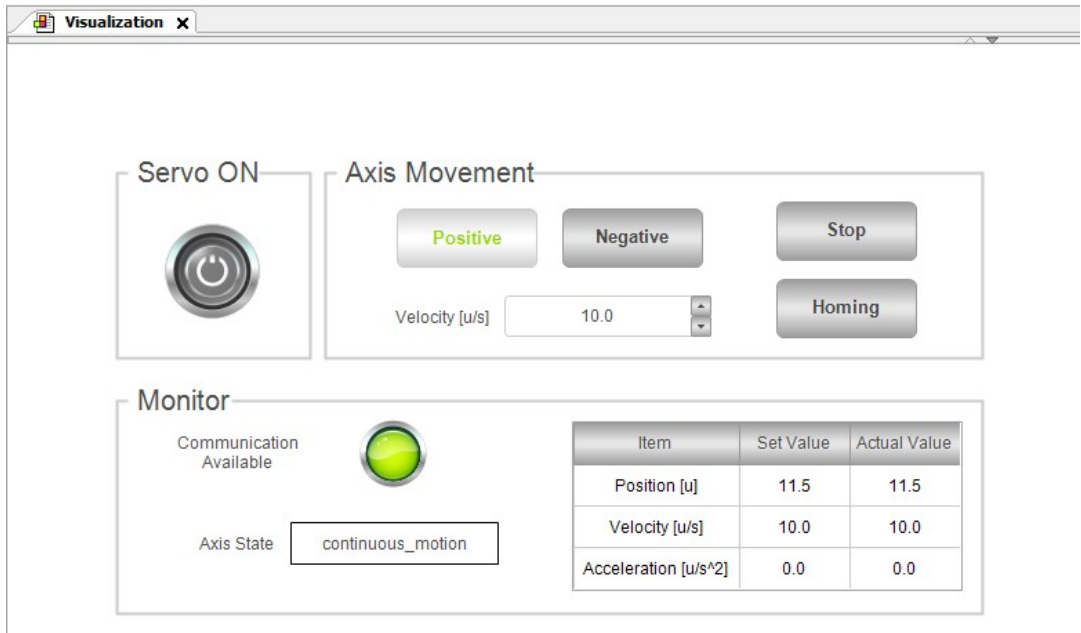

8.7 Visualization Function

8.7.1 Setting of Visualization

This section explains how to add and set a Visualization object.

1 2 Procedure

1. Right-click the “Application” object in the navigation pane and then select **Add Object>Visualization** from the context-sensitive menu that is displayed.

The “Add Visualization” dialog box will be displayed.

- First addition

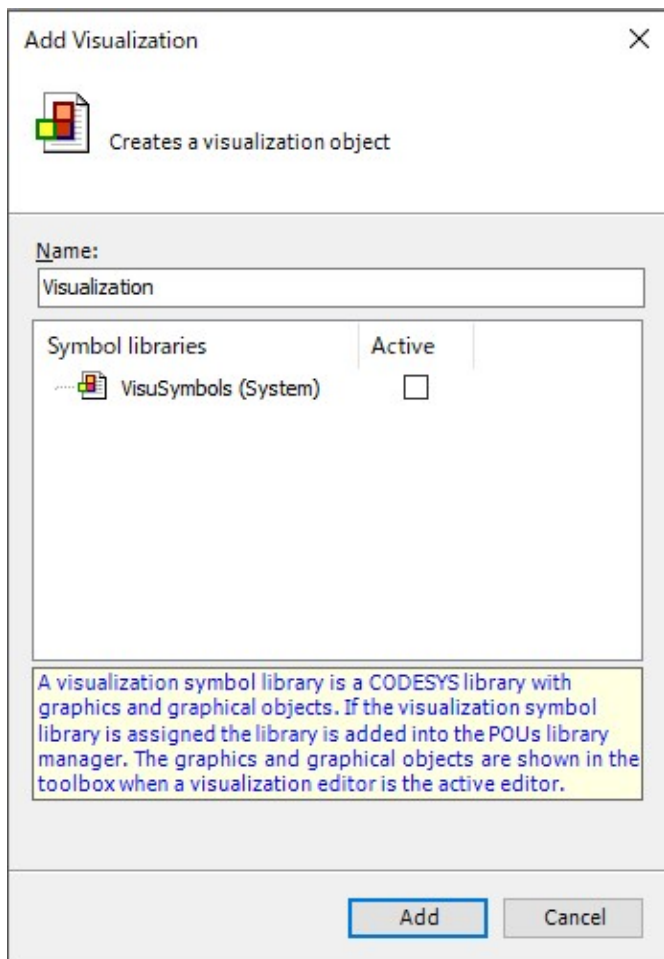

- After the Second addition

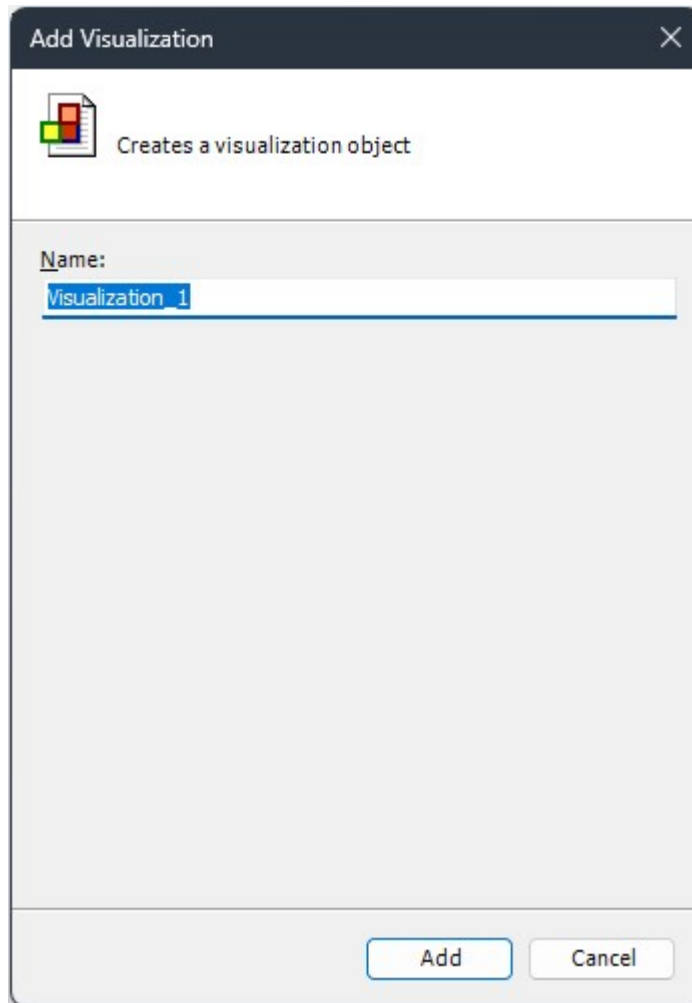

2. Enter a desired visualization name and then click the [Add] button.
When the addition is completed, the Visualization pane will be displayed.

8.7 Visualization Function

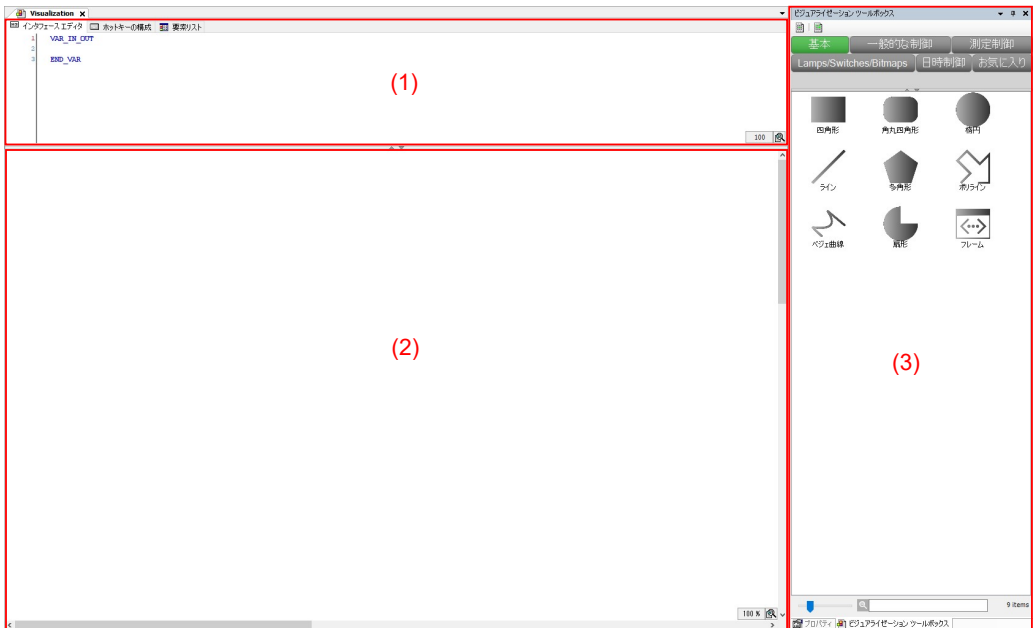

The Visualization pane displays the following:

No.	Name	Function
1	Declaration section	Declare variables for using the visualization as a dialog. Refer to "About editor of the Visualization".
2	Implementation section	Place the tool element.
3	Visualization tool box or properties	Displays the tool element and the properties of the tool element that you want to place in the visualization. The available tool elements are described below.

- For placing the tool element, select a tool element in the visualization tool box, and then click a desired point in the visualization section.

For the list of tool elements that can be used by GM Programmer, refer to "8.7.3 List of Available Tool Elements".

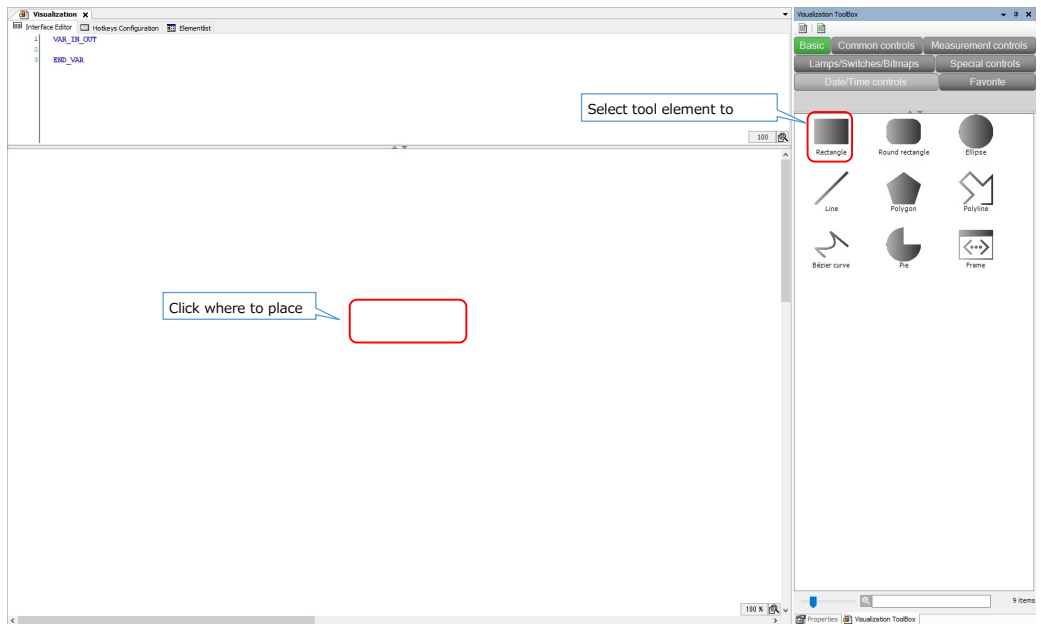

4. Set the properties of the tool element.
 [Properties] will be displayed. On the displayed [Properties], set POI object variables, [Input configuration] that can be used to switch variables by mouse operation.
 For the list of [Properties] of tool elements, refer to "8.7.4 List of Properties of Tool Elements".

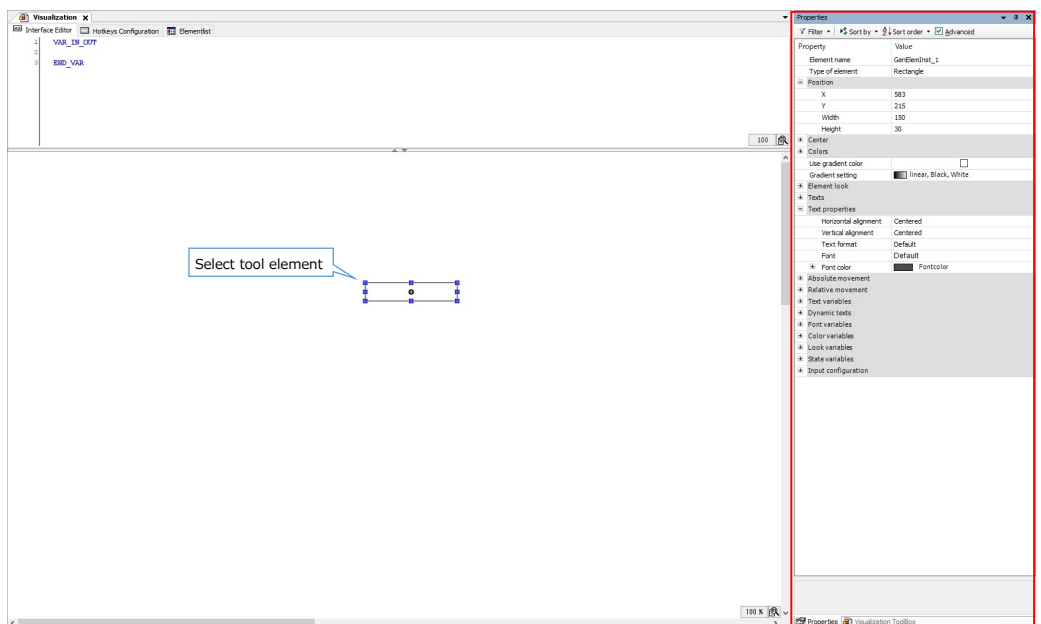

This completes the Visualization setting procedure.

8.7 Visualization Function

About editor of the Visualization

There are three editors (tabs) in the declaration section of a visualization object

Editor	Function
InterFace Edeitor (InterFace Edeitor Tab)	Declares variables for when the visualization is used as a dialog
HotKeys Edeitor (HotKeys Configuration Tab)	Do not use.
Elementlist Edeitor (Elementlist Tab)	You can change the position and size of placed tool elements.

■ InterFace Edeitor (InterFace Edeitor Tab)

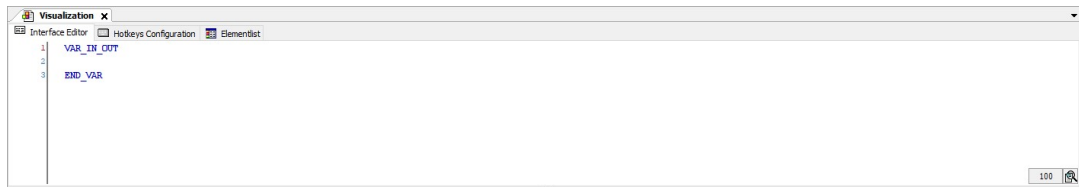

Variables can be declared as in a normal POU. However, the following restrictions apply.

- You can use VAR_IN_OUT, VAR_OUTPUT, and VAR_INPUT. Use them according to the input/output variables, output variables, and input variables used in the dialog.
- They can only be used when the visualization is used as a dialog.

If you declare variables in the interface editor when using it as a visualization, it will not work as a visualization.

- Initial values cannot be set for declared variables. (NG example : iVarible : INT := 5;)

■ Elementlist Editor (Elementlist Tab)

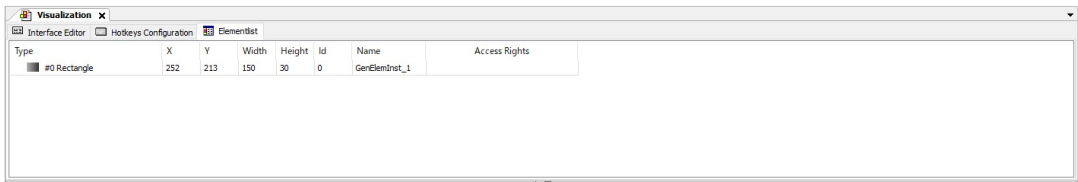

A list of tool elements placed in the visualization and their positions and other information are displayed.

items	Function
Type	The object name of the placed tool element is displayed. The number after # indicates the order in which the tool elements are placed. #0 is the tool element that resides farthest to the rear.
X	X position of tool element Can be changed on the visual element list editor.
Y	Y position of tool element Can be changed on the visual element list editor.
Width	Width of the tool element Can be changed on the visual element list editor.
Height	Height of the tool element Can be changed on the visual element list editor.
ID	Internally set identification number of the tool element
Name	Element name of the tool element Can be changed on the visual element list editor.
Access Rights	Do not use.

8.7 Visualization Function

Visualization Menu

The Visualization Menu allows for the alignment and grouping of tool elements.

■ Visualization Menu

Select "Visualization" from the Menu bar, or right-click on the object screen in the Visualization area to display it.

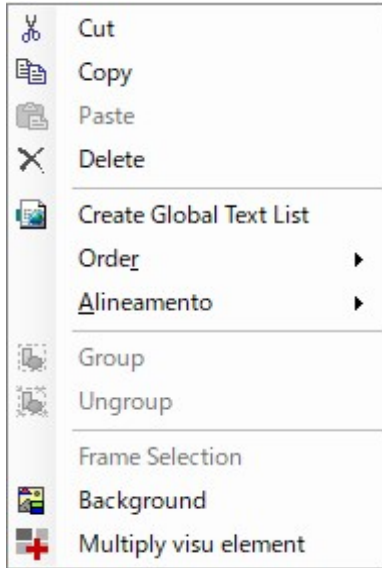

Items	Overview
Create Global Text List	Create a GlobalTextList from the [Text] currently used in each Visualization.
InterFace Edeitor	Open the InterFace editor of the Visualization.
HotKeys Edeitor	Do not use.
Elementlist Edeitor	Open the Elementlist of the Visualization.
Order	Change the order in which selected tool elements overlap with other tool elements.
Allineamento	Align multiple selected tool elements.
Group	group multiple selected tool elements. Grouped tool elements are treated as a single object and cannot be selected and edited individually.
Ungroup	Ungroups the selected tool elements.
Frame Selection	Open the "Frame Configuration" dialog for the selected frame object or tab control object.
Background	Set the Background in Visualization. <ul style="list-style-type: none"> • User color: Fill the background with the selected color. • Use image : Do not use.
Multiply visu element	Expand the selected tool element and text variables to the specified number of rows and columns.

■ About Matrix Expansion of Visualization Elements

To use this function, you need to set the properties of the tool element according to the conditions.

- Conditions
 - Array type variables are set to [text] or [Text variable] of the tool element.
 - The format of the variables to be set for the property is as follows
 - 1st dimension array:"variable name"[\$FIRSTDIM\$]
 - 2nd dimension array:"variable name"[\$FIRSTDIM\$, \$SECONDDIM\$]
 - When expanding Array type variables of 3rd dimension or higher, set fixed values except for the 2 indices that set \$FIRSTDIM\$ and \$SECONDDIM\$.
- Expansion settings

Select a tool element that can be expanded and choose "Multiply visu element" from the menu to open the configuration window for expansion. After setting the necessary parameters and pressing the "OK" button, the tool element is copied according to the description and each element of the Array type variables is assigned.

 - Basic Settings tab

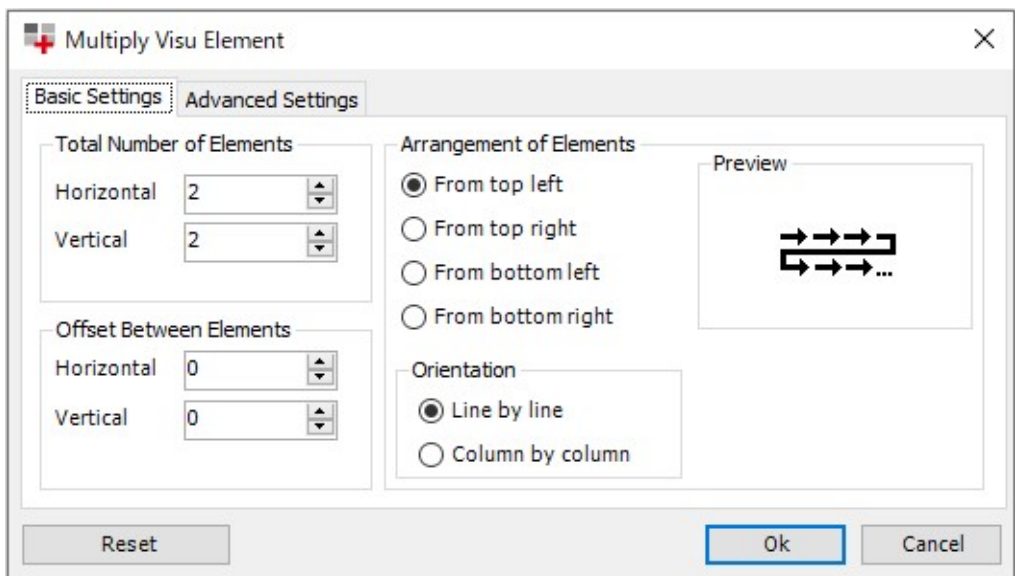

Items		Overview	
Basic Settings	Total Number of Elements	Horizontal	Number of elements in each row As an initial value, the number of indices corresponding to \$FIRSTDIM\$ of the set Array type variables is set.
		Vertical	Number of rows required to place all elements The number of indexes corresponding to \$SECONDDIM\$ (or \$FIRSTDIM\$) of the set Array type variables is set as the initial value.
	Offset Between Elements	Distance (pixels) between tool elements created when expanded <ul style="list-style-type: none"> ● 0: The tool elements will be expanded with their borders overlapping by 1 pixel. ● 1: The tool elements will be expanded so that they touch each other. 	

8.7 Visualization Function

Items		Overview	
			<ul style="list-style-type: none"> n: The tool elements are expanded so that they are separated by n - 1 pixels.
		Horizontal	Distance between tool elements in row direction (pixels)
		Vertical	Distance between tool elements in columns (pixels)
	Arrangement of Elements		Specify the direction of placement after expansion <ul style="list-style-type: none"> From top left,From top Right,From bottom left,From bottom right From left,From right From top,From bottom
		Orientation	Specification of the direction of \$FIRSTDIM\$ increment after expansion <ul style="list-style-type: none"> Line by line,Column by column

- Advanced Settings tab

The screenshot shows a dialog box titled "Multiply Visu Element" with a close button (X) in the top right corner. It has two tabs: "Basic Settings" and "Advanced Settings", with "Advanced Settings" selected. Under the "Advanced Settings" tab, there is a section titled "Array Access" containing four spinners arranged in a 2x2 grid. The top row has "1st dimension" and "2nd dimension" labels above the spinners. The bottom row has "Start index" and "Increment" labels to the left of the spinners. All four spinners are currently set to the value "1". At the bottom of the dialog, there are three buttons: "Reset", "Ok", and "Cancel". The "Ok" button is highlighted with a blue border.

Items		Overview	
Advanced Settings	Array Access	Start index	Specify Start index of Array type variables to be expanded
		Increment	Specify the Increment of the index of the Array type variables to be expanded
		1st dimension	Set for \$FIRSTDIM\$.
		2nd dimension	Set for \$SECONDDIM\$

- Example: A 5 × 10 STRING type array declared in GVL is expanded with a Rectangleobject.
 - Declaration (GVL)

```
strVars : ARRAY [1..5, 1..10] OF STRING;
```

- Setting Properties on Rectangle Objects

Item1	Item2	Description
Text	Text	strVars[\$FIRSTDIM\$, \$SECONDDIM\$]

- The result of matrix expansion with default settings

```
strVars[$FIRSTDIM$, $SECONDDIM$]
```



strVars[1, 1]	strVars[2, 1]	strVars[3, 1]	strVars[4, 1]	strVars[5, 1]
strVars[1, 2]	strVars[2, 2]	strVars[3, 2]	strVars[4, 2]	strVars[5, 2]
strVars[1, 3]	strVars[2, 3]	strVars[3, 3]	strVars[4, 3]	strVars[5, 3]
strVars[1, 4]	strVars[2, 4]	strVars[3, 4]	strVars[4, 4]	strVars[5, 4]
strVars[1, 5]	strVars[2, 5]	strVars[3, 5]	strVars[4, 5]	strVars[5, 5]
strVars[1, 6]	strVars[2, 6]	strVars[3, 6]	strVars[4, 6]	strVars[5, 6]
strVars[1, 7]	strVars[2, 7]	strVars[3, 7]	strVars[4, 7]	strVars[5, 7]
strVars[1, 8]	strVars[2, 8]	strVars[3, 8]	strVars[4, 8]	strVars[5, 8]
strVars[1, 9]	strVars[2, 9]	strVars[3, 9]	strVars[4, 9]	strVars[5, 9]
strVars[1, 10]	strVars[2, 10]	strVars[3, 10]	strVars[4, 10]	strVars[5, 10]

- Example: $A_{2 \times 5 \times 10}$ STRING type array declared in GVL is expanded with a Rectangleobject.
 - Declaration (GVL)

```
strVars : ARRAY [1..2, 1..5, 1..10] OF STRING;
```

- Setting Properties on Rectangle Objects

Item1	Item2	Description
Text	Txet	strVars[\$FIRSTDIM\$, 3, \$SECONDDIM\$]

- The result of matrix expansion with default settings

8.7 Visualization Function

strVars[\$FIRSTDIM\$, 3, \$SECONDDIM\$]



strVars[1, 3, 1]	strVars[2, 3, 1]
strVars[1, 3, 2]	strVars[2, 3, 2]
strVars[1, 3, 3]	strVars[2, 3, 3]
strVars[1, 3, 4]	strVars[2, 3, 4]
strVars[1, 3, 5]	strVars[2, 3, 5]
strVars[1, 3, 6]	strVars[2, 3, 6]
strVars[1, 3, 7]	strVars[2, 3, 7]
strVars[1, 3, 8]	strVars[2, 3, 8]
strVars[1, 3, 9]	strVars[2, 3, 9]
strVars[1, 3, 10]	strVars[2, 3, 10]

Visualization Properties

Visualization Properties can be set to use the created Visualization as a dialog.

■ Properties List

Right-click on the Visualization object in the Navigator window and select "Properties" from the menu that appears. Select the "Visualization" tab in the Properties window.

Properties - Visualization [Device: Program_Configuration: Application] X

Common Build Access Control Visualization

Use Visualization as

Visualization

Dialog

Numpad/Keypad/Dialog for input configuration

Dialog is opaque

Use automatic detected visualization size

Include background image

Use specified visualization size

Visualization Size

Width Height

Internal

OK Cancel Apply

Item	Overview	
Use Visualization as	Visualization	Use as normal window.
	Dialog	Use as a Pop-up window.
	Numpad/keypad/Dialog for input configuration	Do not use.
Dialog is opaque	Do not use.	
Use automatic detected visualization size	All tool elements will be sized and displayed as they appear.	
Include background image	Do not use.	

8.7 Visualization Function

Item	Overview
Use specified visualization size	The visualization will be displayed in the size specified in the "Height" and "Width" fields.
Internal	Do not use.

Visualization Option

The Visualization Option allows you to configure grid display and other settings.

■ Option list

It is displayed by selecting **Tool>Option** from the menu bar.

Option Category

Category name	Function
Visualization styles	Do not use.
Visualization user management	
Visualization	Configure settings such as the display of Visualization.

- Category:Visualization
General Tab

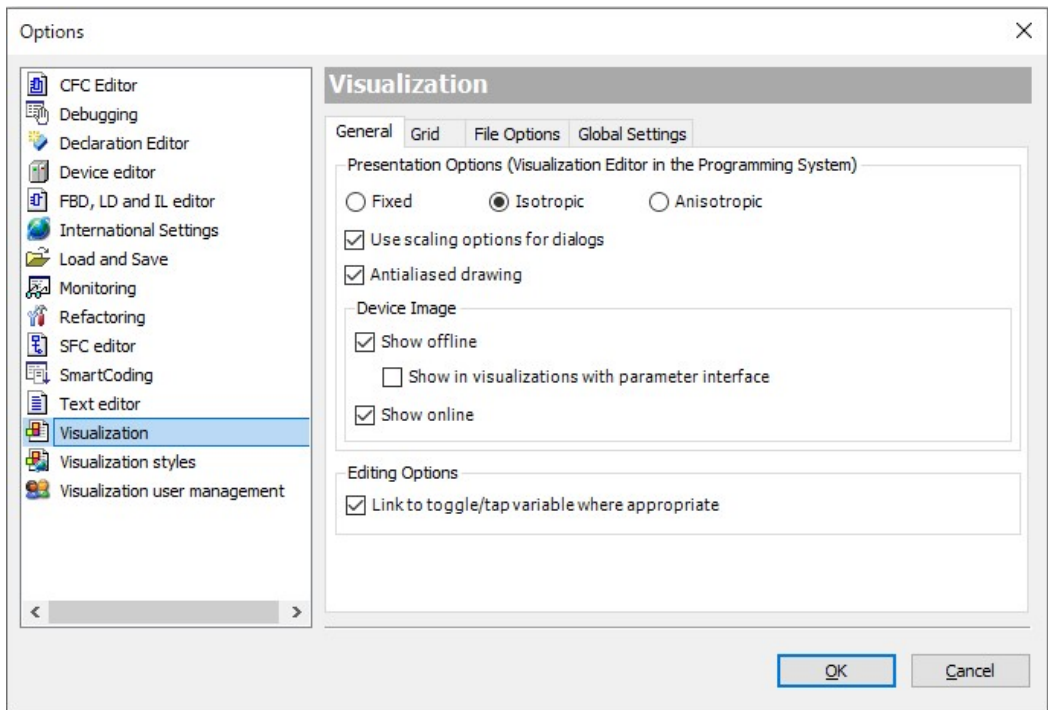

Setting items	Overview	
Presentation Options	Fixed	Visualization is displayed in its original size.
	Isotropic	Visualization will be scaled to fit on the screen while maintaining the aspect ratio.

Setting items		Overview
	Anisotropic	Visualization will be scaled to fit within the screen, but the aspect ratio will not be preserved.
	Use scaling options for dialogs	If checked, the Isotropic / Anisotropic setting will also be applied to dialogs displayed by the input configuration.
Device Image	Show offline	Do not use.
	Show in visualizations with parameter interface	
	Show online	
Editing Options	Link to toggle/tap variable where appropriate	If checked, the variables set in [Input configuration] - [Tap] or [Toggle] will be automatically applied to the tool element property [Color variables] - [Toggle color]. The variable set to [Tap] will be used first.

Grid Tab

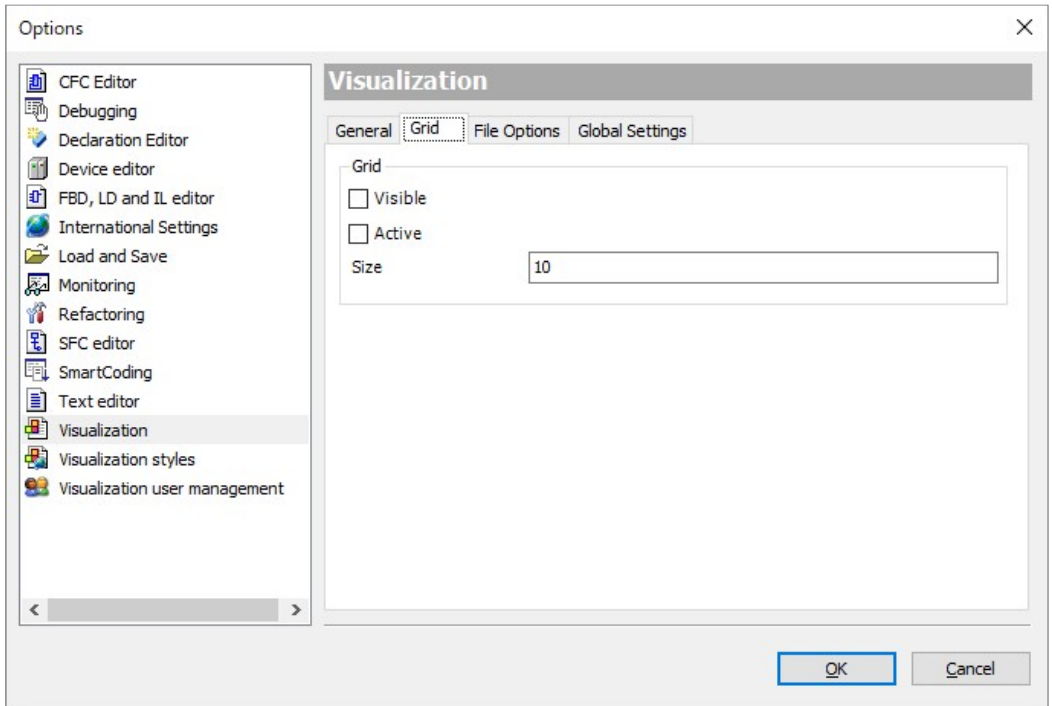

Setting items	Overview
Visible	If checked, grid points are displayed in Visualization.
Active	If checked, placement of tool elements in Visualization is restricted to grid points.
Size	Specify the distance between grid points in pixels.

File Options Tab

8.7 Visualization Function

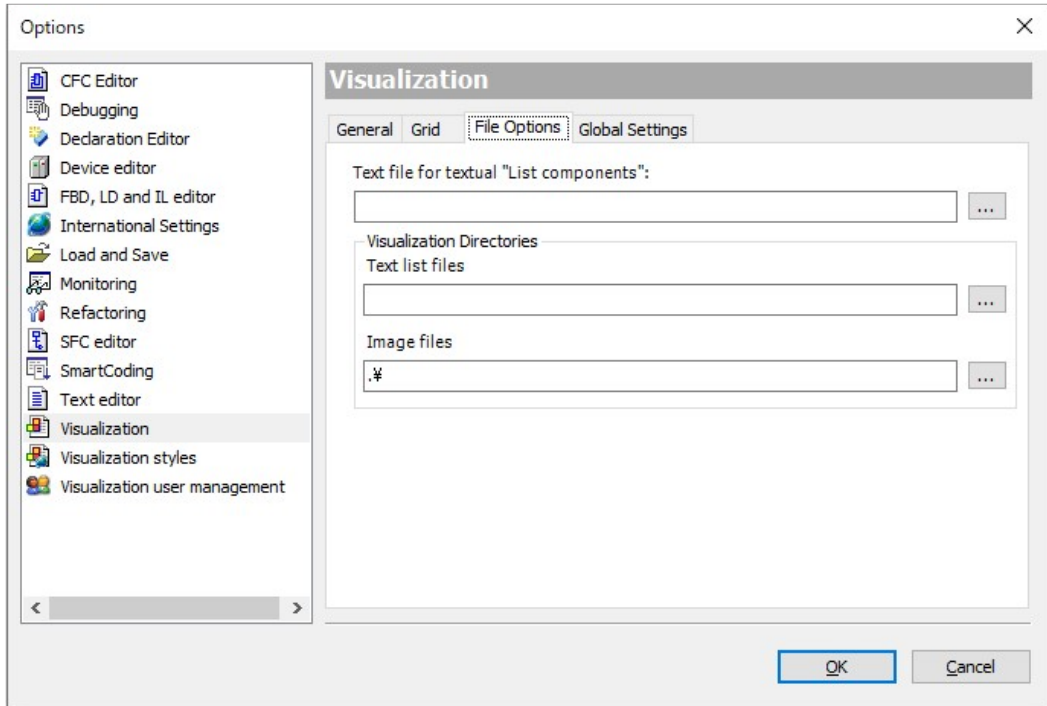

Setting items	Overview
Text list files for textual "List components"	Set up a .csv file in text list format. When entering text for tool element properties, the text in the text list file will be displayed as input candidates.
Text list files	Do not use.
Image files	

Global Settings Tab

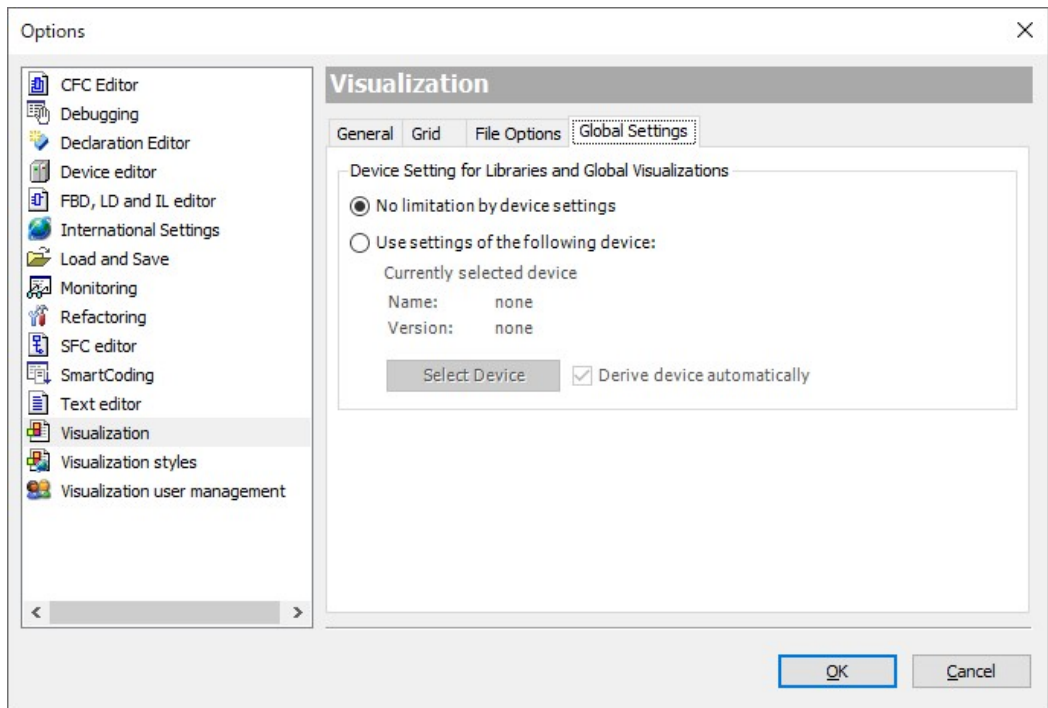

Setting items	Overview
No limitation by device settings	Fixed to selected state
Currently selected device	Do not use.
Select Device	
Derive device automatically	

8.7 Visualization Function

8.7.2 Setting of TextList

TextList is an object that lists texts identified with ID numbers. When using TextList to create visualization, add a TextList object.

The following section explains how to add and set a TextList object.

1 2 Procedure

1. Right-click the “Application” object in the navigation pane and then select **Add Object>TextList** from the context-sensitive menu that is displayed.

The “Add TextList” dialog box will be displayed.

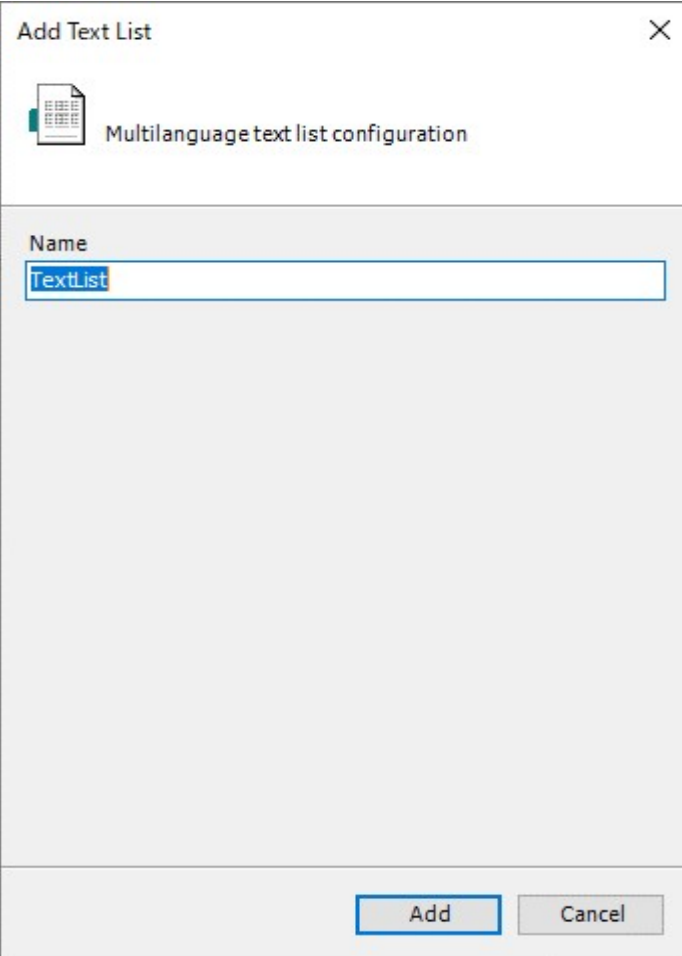

The screenshot shows a dialog box titled "Add Text List" with a close button (X) in the top right corner. Below the title bar, there is a document icon and the text "Multilanguage text list configuration". A "Name" label is positioned above a text input field that contains the text "TextList". At the bottom of the dialog, there are two buttons: "Add" and "Cancel".

2. Enter a desired TextList name and click the [Add] button.
When the addition is completed, the TextList pane will be displayed.



ID	Default

The TextList pane displays the following contents.

Name	Function
ID	Set the ID number for the text described in "Default". The same ID number cannot be set.
Default	Set the text to be listed. If the text is set with "ID" left blank, an ID is automatically set.

3. Set the TextList object.

Shown below is an example of the display when "Apple", "Orange", and "Grape" are described in this order in the "Default" field, 10 is assigned as an ID number, and "Banana" is described in the "Default" field.

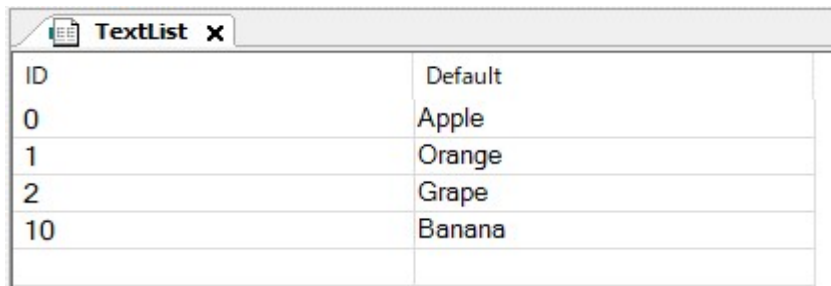

ID	Default
0	Apple
1	Orange
2	Grape
10	Banana

This completes the TextList setting procedure.

8.7 Visualization Function

GlobalTextList

GlobalTextList is automatically added to the POU tree when you set the [Text] property or other properties of a tool element.

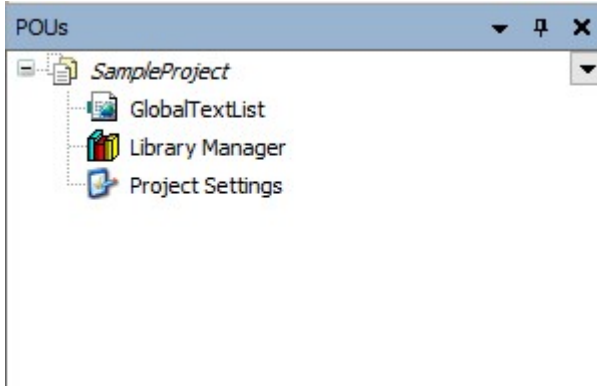

Name	Function
ID	<ul style="list-style-type: none">• When the tool element [Text] - [Text] is set: The [TextID] value is automatically set.• When the tool element [Text] - [ToolTip] is set: The [HintID] value is automatically set.
Default	When the tool element [Text] - [Text] and [Text] - [ToolTip] are set: The text is automatically described.

i Info.

- The contents of the GlobalTextList cannot be edited.
- By using the "Import Replace File" described below, you can replace the text of all tool elements associated with GlobalTextList at once.

TextList Menu

The TextList Menu allows you to add other languages and import and export TextLists.

■ TextList Menu

Select "TextList" from the menu bar or right-click on the TextList object screen.

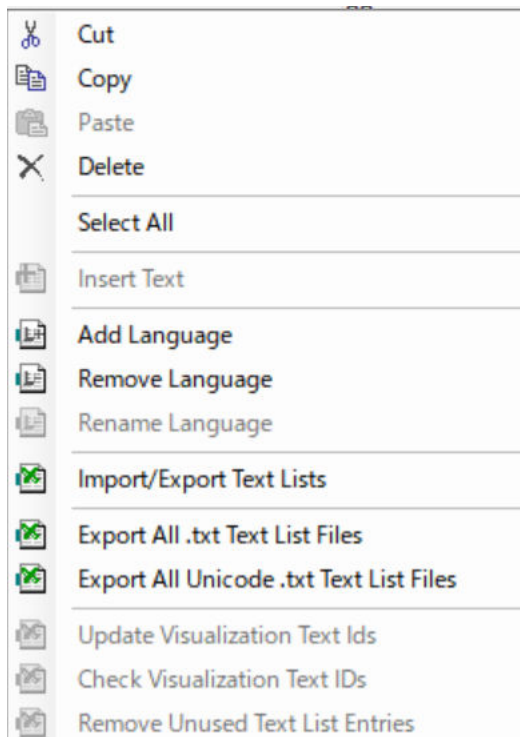

Items	Overview
Cut	Cut the selected text.
Copy	Copy the selected text.
Paste	Paste the copied text.
Delete	Delete selected text.
Select All	ID, selects all text.
Browse	Do not use.
Insert Text	Insert text. The "ID" will be set automatically.
Add Language	Add a new language column.
Remove Language	Delete selected language. You cannot delete the "default" language.
Rename Language	Rename the selected language. "Default" cannot be renamed.
Import/Export Text Lists	Import/Export TextList.

8.7 Visualization Function

Items	Overview
	See below for details.
Export All .txt Text List Files	Do not use.
Export All Unicode.txt Text List Files	
Update Visualization Text Ids	Add the text currently used in the visualization to the GlobalTextList. Can be used on a GlobalTextList.
Chek Visualization Text IDs	Do not use.
Remove Unused Text List Entries	Remove text from the GlobalTextList that is not currently used in the visualization. Can be used on a GlobalTextList.

i Info.

- By adding or writing other languages to TextList, languages other than the default language can be displayed in the visualization.
- You can change the language displayed in the visualization by setting the "Language switch" in the "Input configuration" property of the tool element.

■ About Import/Export

TextList can be imported and exported for saving and reuse. In the "Import/Export TextList" menu of the TextList Menu, set and execute the following items

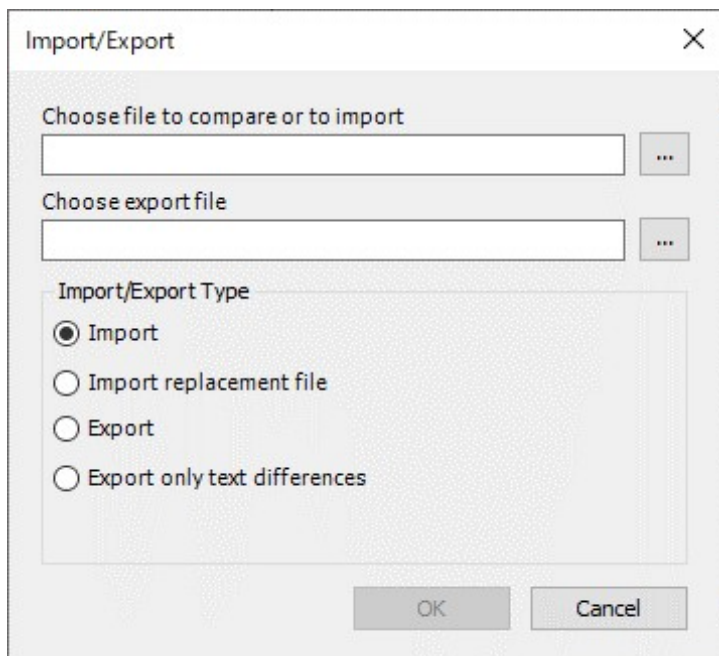

Setting Item	Overview
Choose file to compare or to import	Specify a tab-delimited CSV file to import. <ul style="list-style-type: none"> • The contents of the CSV file to be imported will be reflected in all TextLists in the project.

Setting Item		Overview
		<ul style="list-style-type: none"> If a CSV file contains a TextList name that does not exist, a TextList will be generated in the device tree.
Choose export file		Specify CSV file to export TextList. <ul style="list-style-type: none"> All TextList and GlobalTextList in the project are exported. If the specified file does not exist, a new tab-delimited CSV file is created.
Import/Export type	Import	Import the specified tab-delimited CSV file into TextList Incorrect CSV files, such as using the same ID number or the same language name, will not be imported correctly.
	Import replacement file	Replaces the contents of GlobalTextList based on the contents of the specified replacement file. The replacement file must follow the specified format, and an error will occur if a file with a different format is specified. For details, please refer to the example below.
	Export	Export TextList to a specified tab-delimited CSV file.
	Export only text differences	Do not use.

i Info.

- When "Import" is executed on GlobalTextList, the new TextList by TextList file is imported into the POU tree.

8.7 Visualization Function

■ Example 1: "Export" is executed

The following TextList exists in the project, and in the visualization object there is a button object with the text 'ON'.

The "Export" is performed on one TextList object.

- TextList

TextList name	ID	Default	ja
TextList1	0	Apple	りんご
	1	Orange	みかん
	2	Grape	ぶどう
TextList2	0	Lemon	れもん
	1	Cherry	さくらんぼ
	2	Peach	もも

- Visualization

Tool element	Item1	Item2	Description
Button	Text	Text	ON

- GlobalTextList

TextList name	ID	Default	ja
GlobalTextList	21	ON	

The result of "Export" is as follows

TextList	Id	Default	ja
GlobalTextList		ON	
TextList2	0	Lemon	れもん
TextList2	1	Cherry	さくらんぼ
TextList2	2	Peach	もも
TextList1	0	Apple	りんご
TextList1	1	Orange	みかん
TextList1	2	Grape	ぶどう

Text used in visualization is also exported.
'ID' is not exported.

Object names are displayed in the 'TextList' column.

■ Example 2: "Importing a replacement file"

Change the contents of GlobalTextList using a replacement file.

- Before replacement

ID	Default
836	Text_Before
124	ToolTip_Before

- Replacement files

Each is created as a tab-delimited file.

defaultold	defaultnew	REPLACE
Text_Before	Text_After	REPLACE
ToolTip_Before	ToolTip_After	REPLACE

- After replacement

ID	Default
836	Text_After
124	ToolTip_After

- Visualization

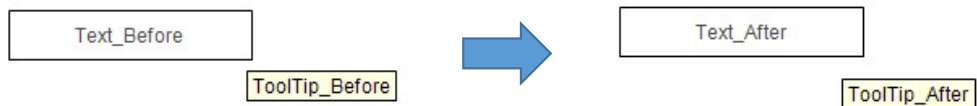

8.7 Visualization Function

8.7.3 List of Available Tool Elements

■ Tool element

The following tool elements can be used with the GM Programmer.

Class	Name	Description
Basic	Rectangle	Displays a rectangle.
	Rounded rectangle	Displays a rounded rectangle
	Ellipse	Displays an ellipse.
	Line	Displays a straight line. Place a line by clicking two points as the both ends of the straight line.
	Polygon	Displays a polygon.
	Polyline	Displays a polyline.
	Bezier curve	Displays a Bezier curve.
	Pie	Displays a pie.
	Frame	The visualization created in the project will be displayed as a frame. By setting the frame switching variable, you can switch between multiple visualizations.
Common controls	Label	Displays a text. The text cannot be rewritten in the online mode.
	Tab control	The visualization created in the project will be displayed as a frame that can be switched with tabs.
	Button	Displays a button. The button can be used to switch between TRUE and FALSE of the BOOL type variable.
	Group box	Displays a box for grouping tool elements. Group name can be set.
	Table	Data array is displayed as a table. Data such as one-dimensional array, two-dimensional array, array of arrays, structures, or function blocks can be set.
	Text field	Displays a text box. The text can be rewritten even in the online mode.
	Scroll bar	Displays a scroll bar. Variable value can be set according to the scroll bar position.
	Slider	Displays a slider bar. Variable value can be set according to the slider position.
	Spin control	Displays a spin control. The variable value can be increased or decreased by a specified numerical width each time one of the arrow buttons is pressed.
	Invisible input	A rectangle object that is not displayed in the online mode can be added.
	Check box	Displays a check box.

Class	Name	Description
		Depending on whether it is checked or not, the BOOL type variable is switched between TRUE and FALSE
	Radio button	Displays radio buttons grouped together. The number of the selected radio button is identified by an integer value.
	Progress bar	Displays a variable value in the progress bar.
Measurement controls	Bar display	Displays a variable value in the bar.
	Meter 90°	Displays a variable value with a meter.
	Meter 180°	
	Meter	
	Potentiometer	Displays a variable value with a potentiometer. The value can be changed by moving the pointer position.
	Histogram	One-dimensional array data is displayed as a histogram.
Lamps/ Switches/ Bitmaps	Lamp	Displays a lamp. Displays a BOOL type variable value with the lamp turned ON or OFF. TRUE: Lamp is ON., FALSE: Lamp is OFF
	DIP switch	Displays a DIP switch. It can be used to switch between TRUE and FALSE of the BOOL type variable.
	Power switch	
	Push switch	
	Push switch LED	
	Rocker switch	
	Rotary switch	
Date and time control	Analog clock	Displays an analog clock.

8.7.4 List of Properties of Tool Elements

The following properties can be used with the GM Programmer. If the same property set values exist in more than one tool element items, repeated descriptions are omitted.

■ Class: Basic

Setting item		Overview	Tool element
Element name		Name of the tool element. The name is assigned automatically.	Common
Type of element		The object name of the tool element is displayed.	
Center		Set the coordinates of the center point of the tool element.	
Color	Normal state Alarm state	Set the frame color and fill color for the normal state and alarm state and also set the transparency of each one.	
Use gradient color		If this item is checked, the object is filled with the contents of [Gradient setting].	

8.7 Visualization Function

Setting item		Overview	Tool element
Gradient setting		Set the fill gradation of the tool element. On the "Gradient editor" dialog box, specify the gradation type, color, etc.	
Element look	Line width	Set the frame line width.	
	Fill attributes	Set the fill format of the tool element. Filled, unfilled	
	Line style	Set the line style. Solid line, dashed line, dotted line, dash-dotted line, dash-dotted-dotted line, outline line	
Texts	Text	Set the text to be displayed on the tool element. When using text variables, specify the numerical format.	
	Tooltip	Set the text to be displayed on the tooltip of the tool element. When using tooltip variables, specify the numerical format.	
Text properties	Horizontal alignment Vertical alignment	Set the position where the text is displayed.	
	Text format	Set the display method when the text protrudes from the tool element.	
	Font	Set the font and size of the text.	
	Font color	Set the font color and transparency of the text.	
Absolute motion	Movement	Specify the distance from the current coordinates in the online mode.	
	Rotation	Set the angle to rotate around the center point in the online mode.	
	Scaling	Set the reduce/enlarge ratio from the center point in the online mode. The original size is 1000.	
	Use REAL values	If this item is checked, the [Absolute motion] value is set as a REAL type value. Therefore, the movement becomes smoother than when the item is not checked.	
Relative move	Movement top-left Movement bottom-right	Specify the distance that the Movement top-left or the Movement bottom-right of the tool element moves in the online mode. Since it is a relative move, the size of the tool element changes.	
	Text variable	Set the variable of the text to be displayed on the tool element.	
Text variable	Text variable	Set the variable of the text to be displayed on the tool element.	
	Tooltip variable	Set the text variable to be displayed when a mouse cursor is placed over the tool element.	
Dynamic text	TextList	Set the TextList name to be used.	
	Text index	Set the TextList ID. The content of the corresponding "ID" is displayed in the text.	

Setting item		Overview	Tool element
	Tooltip index	Set the TextList ID. The content of the corresponding "ID" is displayed on the tooltip.	
Font variables	Font name	Set a STRING type variable.	
	Size	Set the numerical data type variable. Units: <pt> = point, <px> = pixel	
	Flags	Set a DWORD type variable. The following display formats can be used and their combined use is possible. <ul style="list-style-type: none"> • 2#0001: Italic • 2#0010: Bold • 2#0100: Underline • 2#1000: Strikethrough 	
	Character set	Do not use.	
	Color	Set a DWORD type variable. 16#[Transparent_8bit][R_8bit][G_8bit][B_8bit]	
	Flags for text alignment	Set a DWORD type variable. The following display formats can be used and their combined use is possible. <ul style="list-style-type: none"> • 2#0000: Align top and left • 2#0001: Center horizontally • 2#0010: Align right • 2#0100: Center vertically • 2#1000: Align bottom 	
Color variables	Toggle color	Set a BOOL type variable for switching colors. In the initial state, the variable set in [Tap] or [Switching] for [Input configuration] is linked. <ul style="list-style-type: none"> • TRUE: Alarm state settings are used. • FALSE: Normal state settings are used. 	
	Normal state Alarm state	Set the frame color and fill color for the normal state and alarm state using variables.	
Look variables	Line width	Set the frame line width using variables.	
	Fill attributes	Set the fill format of the tool element using variables. <ul style="list-style-type: none"> • 0: Fill • 1: Unfill 	
	Line style	Set the line style using variables. <ul style="list-style-type: none"> • 1: Solid line • 2: Dashed line • 3: Dash-dotted line • 4: Dash-dotted-dotted line • 5: Outline line 	
Status variables	Invisible	Set the BOOL type variable that switches between Show and Hide of the tool element in the online mode. When set to TRUE, the tool element is hidden.	
	Deactivate inputs	Set the BOOL type variable that switches between Enable and Disable of the character input or mouse operation in the online mode.	

8.7 Visualization Function

Setting item		Overview	Tool element
		When set to TRUE, mouse operation is disabled.	
Input configuration	OnDialogClosed	When the dialog is closed, the event is raised.	
	OnMouseClicked	An event is fired when the mouse button is pressed and released on a tool element.	
	OnMouseDown	An event occurs when the mouse button is pressed on a tool element.	
	OnMouseEnter	An event occurs when the mouse pointer enters the tool element.	
	OnMouseLeave	An event occurs when the mouse pointer leaves the tool element.	
	OnMouseMove	Do not use.	
	OnMouseUp	An event occurs when the mouse button is released on the tool element (regardless of where it is pressed) or when the mouse button is pressed and released on the tool element (regardless of where it is released).	
	Tap	<ul style="list-style-type: none"> Variable: Set the BOOL type variable that switches between TRUE and FALSE while the mouse remains clicked on the tool element. If “Change to FALSE using Tap” is checked, the set variable switches from TRUE to FALSE while the mouse remains clicked. If “Tap enter if captured” is checked, the tool element is considered to be tapped even when the mouse is placed over the tool element while the mouse remains clicked after it is clicked in the area outside the tool element. 	
Toggle	<ul style="list-style-type: none"> Variable: Set the BOOL type variable that switches between TRUE and FALSE when the mouse is clicked on the tool element. If “Tap up arrow if captured” is checked, the variable changes even when the mouse click is released in an area outside the tool element while the mouse remains clicked after it is clicked on the tool element. 		
Hot key	Do not use.		
Position		Set the coordinates, width, or height of the tool element. Operate the tool element using the mouse to change the coordinates, width, or height.	Common
		Set the coordinates of each vertex of the tool element. Operate the tool element using the mouse to change the vertex coordinates.	Polyline Bezier curve Polygon
Radius setting	Radius	Set the style of the corner rounding radius. <ul style="list-style-type: none"> From the style: The corner is rounded to the radius that matches the visualization style. Proportional to the element size: The corner is rounded to the radius that matches the size of a rounded corner rectangle object. Explicit: The corner is rounded to the set radius. 	Rounded rectangle
Line width variable	Integral value	Set the line width using variables.	Line

Setting item		Overview	Tool element
Line style variable	Integral value	Set the line style using variables.	
Begin End		Set the begin and end angles of the pie.	Pie
Variable for begin Variable for end		Set the variables that specify begin and end angles of a sector.	
Only show cirde line		If this item is checked, only the portion of an arc is displayed.	
Dynamic points	Array of points Number of points	Do not use. Do not use.	
Clipping		If you check the box, only the visualization within the frame of the tool element will be displayed.	Frame
Show frame		You can set the visibility of the frame of the tool element.	
Scaling type		You can set the type of zoom for the image: <ul style="list-style-type: none"> • Isotropic: The visualization will be scaled while maintaining the aspect ratio of the image. • Anisotropic: The visualization will be scaled without maintaining the aspect ratio of the image. • Fixed: Only the size of the frame of the tool element will be changed. The visualization will be displayed in its original size. • Fixed and Scrollable: Only the part of the visualization within the frame of the tool element will be displayed. You can scroll to view different parts using scrollbars.。 	
Scroll bar settings	Left-Right Scroll Position Variable Vertical Scroll Position Variable	Do not use.	
Deactivate background drawing		Do not use.	
Reference		Set the visualization to display on the frame object.	
Switch frame variable	variable	Sets the index number of the visualization to display on the frame object. Integer type variables can be set.	

■ Class: General control

Setting item		Overview	Tool element
Value, variable, data array		Set the variable, array, etc.used by the tool element.	Common
Tab Width		Set the tab width.	Tab controll
Tab height		Set the tab height	
References	Header ImageID	Set the heading text to be displayed on the tab. Do not use.	
Bitmap info	Static ID	Do not use.	Button
Bitmap ID variable			

8.7 Visualization Function

Setting item		Overview	Tool element
Columns	Show row header	Set the title of the show row header.	Table
	Show column header	Set the width of the column.	
	Image column	Do not use.	
	Image configuration	Do not use.	
	Alignment of headline text	Set the position of the headline text.	
	Use template	If this item is checked, [Templates] is displayed. In the online mode, cells are drawn in the style according to the settings set in [Templates].	
	Alignment of template headline text	If this item is checked, the headline is drawn in the style according to the settings set in [Templates] in the online mode.	
Maximum array index		Set the maximum number of items of each data array to be displayed.	
Row height		Set the row height.	
Scroll bar size		Set the scroll bar size.	
Display the row header Display the column header		If this item is checked, the row header and column header are displayed.	
Row header width		Set the width of the row header.	
Selection	selection color	Set the display color of the selected cell.	
	Selection font color	Set the font color of the selected cell.	
	Selection type	Set the type of the cell selection.	
	Frame around selected cells.	If this item is checked, the border of the selected cell becomes thicker.	
	Variable for selected column Variable for selected row	Set the variable that indicates the number of the selected columns or rows.	
	Variable for valid column selection Variable for row valid selection	Set the BOOL type variable that reflects the selected state of column or row.	
Shadow type		Set the shadow type of the border.	Text field
Selection and caret configuration	Caret position	Set the variable that indicates the position of the caret (that displays the insertion point).	
	Selection start Selection end	Set the variable that indicates the selection start position and selection end position when multiple texts are selected.	
	All selected	Set the BOOL type variable for selecting all texts. When set to TRUE, all texts are selected.	
Minimum value Maximum value	Set the maximum value and the minimum value of the bar.		Scroll bar Progress bar

Setting item		Overview	Tool element
Page size		Set the movement amount of a value when the scroll area is clicked.	Scroll bar Slider
Move to click		If this item is checked, the tab moves to the position (value) where the mouse is clicked in the scroll area.	
Bar	Diagram type (slider only)	Set the position where the scale is displayed.	
	Orientation	Set the orientation of the scale.	
	Running direction	Set the direction in which the scale values increase.	
Scale	Show scale	If this item is checked, the graduations are displayed.	Slider
	Scale start Scale end	Set the maximum value and the minimum value of the scale.	
	Main scale	Set the interval between the main scale graduations.	
	Sub scale	Set the interval between the sub scale graduations. If set to 0, the sub scale is disabled.	
	Scale format	Set the numerical value format.	
	Scale proportion	Set the ratio (%) occupied by the scale to the entire object size. The default is 0.	
Number format		Set the numerical value format.	Spin control
Interval		Set the interval in which the scale value increases or decreases when the arrow button is pressed.	
Value range	Minimum value Maximum value	Set the maximum value and the minimum value.	
Text properties	Usage of	If this item is checked, select whether to use the default for the text style or to individually set it.	Check box Radio button
Number of columns		Set the number of columns for displaying radio buttons.	Radio button
Radio button order		Set the radio button placement order. <ul style="list-style-type: none"> From left to right: Radio buttons are placed in order from the left top to the right direction for the number of set columns. From top to bottom: Radio buttons are placed from the left top to the bottom direction equally for the number of set columns. 	
Radio button settings	Radio button	<ul style="list-style-type: none"> New creation of buttons: Newly create radio buttons. Area: Individually set the text or tooltip to be displayed on the radio button. Set the offset value that shifts the radio button downward for the line height (pixel). Delete button: Used to delete the selected radio button. 	

8.7 Visualization Function

■ Class: Measurement control

Setting item		Overview	Tool element
Background	Image color	Set the image color of the tool element.	Bar display Meter Meter 90° Meter 180° Potentiometer
	Own Image	Set the background image. <ul style="list-style-type: none"> Image: Use in the initial state (< default >). Transparent color: Set a color that makes the background transparent. 	
	Optimized drawing	Please use the initial state (with the checkbox checked).	
Scale	Refer also to scale settings under "Class: General control".		
	Sub scale position	Set the position where the sub scale is displayed.	
	Scale type	Set the type of graduations indicated on the scale. Line, dot, square	
	Scale line width	Set the width of the scale graduation line.	
	Scale color	Set the color of the scale graduation line.	
	scale in 3D	If this item is checked, a gray shadow is added to each graduation of the scale.	
	Element frame	If this item is checked, a frame line is displayed outside the tool element.	
	Inside frame Outside frame	If this item is checked, a frame line is displayed inside and outside of the scale.	
Base line	Set the baseline value for the histogram to be displayed.	Histogram	
Bar	Refer also to bar settings under "Class: General control".		Bar display
	Optimum size for bar	If this item is checked, the bar width is expanded to match the element size.	
Positioning	Horizontal offset Vertical offset	The scale position is offset by the specified value from the original position. If a positive value is specified, the position is offset to the right direction and downward direction.	Bar display
	Horizontal scaling Vertical scaling	The scale size is enlarged or reduced by the specified value from the original size. If a positive value is specified, the size in the horizontal direction is reduced to the center direction and the one in the vertical direction is reduced to the downward direction.	
Arrow	Arrow type	Set the type of the arrow mark.	Meter 90° Meter 180° Meter Potentiometer
	Color	Set the color of the arrow mark.	
	Angle range	Set the direction of the meter.	
	Additional arrow	If this item is checked, an arrow mark is added to the scale portion of the meter.	
Subrange array	Use subrange	Do not use.	Histogram
	Start Index End Index		
	Display type	Set the type of the histogram.	

Setting item		Overview	Tool element
		Bar, line, curve	
Line width		Set the line width (pixel) of the histogram to be displayed.	
Relative bar width		Set the bar width of the histogram relative to the graph area.	
Color - Color areas	Dorable Color areas	If checked, the colors within the range set in the color areas will always be displayed in the tool element. If neither "Persistent Color areas" nor "Use Color areas on Scale" is checked, the tool element will display the set color when the value in the "Value" field is within the range of the color range.	Bar display Meter 90° Meter 180° Meter Potentiometer Histogram
	Use color areas for scale	If checked, the colors within the range set in the color areas will be applied to the scale and number parts of the tool element. If unchecked, the color areas settings will be applied to the background of the scale when the checkbox is not selected.	
Color - color areas -Areas	Begin of area	Set the starting value of the color area.	
	End of areas	Set the ending value of the color area.	
	Color	Set the display color of the color area.	

■ Class: Lamps/Switches/Bitmaps

Setting item		Overview	Tool element
Image setting	Transparent Transparent color	If [Transparent] is checked, the color set in [Transparent color] becomes transparent.	Dip switch Power switch Push switch LED switch Rocker switch Rotary switch
	Isotropic type	You can set the type of zoom: <ul style="list-style-type: none"> Isotropic: The image will be scaled while maintaining the aspect ratio of the width and height. Anisotropic: The image will be scaled without maintaining the aspect ratio of the width and height. Fixed: Only the size of the frame will be changed. The elements inside will remain at a fixed size. 	
	Horizontal alignment Vertical alignment	The display will appear when the "Isotropic" option is selected in the Isotropic Type. Set the position of the elements within the frame.	
Element behavior		Set the switch operation to "Toggle" or "Tap". <ul style="list-style-type: none"> Image toggler: Toggles between TRUE and FALSE of the set "Variable" every time the tool element is pressed. Image tapper: The set "Variable" remains TRUE while the tool element is pressed. 	

■ Class: Date and time control

Setting item		Overview	Tool element
Display time	Use system time	If this item is checked, the system time is displayed.	Analog clock

8.7 Visualization Function

Setting item	Overview	Tool element
	If this item is not checked, the time of the TOD type variable set in the displayed [Variable] is displayed.	

■ Numerical value format

The following table shows numerical value formats that can be set in properties.

Numerical data type	Numerical value format	Overview
Integer type	%d	Decimal notation
	%o	Unsigned integer in octal notation
	%x	32-bit unsigned integer in hexadecimal notation (with the letters a to f in lower case)
	%X	32-bit unsigned integer in hexadecimal notation (with the letters A to F in upper case)
	%u	Unsigned integer in decimal notation
Float	%f	Decimal notation with decimal point
	%e	Exponent notation
Time	%t[d] %t[dd]	Date display <ul style="list-style-type: none"> • %t[d]: 1 to 31 • %t[dd]: 01 to 31 (with 0 prefix if single digit)
	%t[H] %t[HH] %t[h] %t[hh]	Hour display <ul style="list-style-type: none"> • %t[H]: 1 to 24 • %t[HH]: 01 to 24 (with 0 prefix if single digit) • %t[h]: 0 to 12 • %t[hh]: 00 to 12 (with 0 prefix if single digit)
	%t[m] %t[mm]	Minute display <ul style="list-style-type: none"> • %t[m]: 0 to 59 • %t[mm]: 00 to 59 (with 0 prefix if single digit)
	%t[s] %t[ss]	Second display <ul style="list-style-type: none"> • %t[s]: 0 to 59 • %t[ss]: 00 to 59 (with 0 prefix if single digit)
	%t[ms] %t[us] %t[ns]	Milli/micro/nano-second display <ul style="list-style-type: none"> • %t[ms]: 0 to 999 • %t[us]: 0 to 999 • %t[ns]: 0 to 999
	%t[yyyy] %t[yy] %t[y]	Year display <ul style="list-style-type: none"> • %t[yyyy]: The year is displayed in four digits. • %t[yy]: The year is displayed in two digits (00 to 99) • %t[y]: The year is displayed in one or two digits (0 to 99)
	%t[MMMM] %t[MMM] %t[MM] %t[M]	Month display <ul style="list-style-type: none"> • %t[MMMM]: The month is displayed in English (Example: January) • %t[MMM]: The month is displayed in abbreviated English (Example: Jan) • %t[MM]: The month is displayed in two digits (01 to 12)

Numerical data type	Numerical value format	Overview
		<ul style="list-style-type: none"> • %t[M]: The month is displayed in one or two digits (1 to 12)
	%t[dddd] %t[ddd] %t[dd] %t[d]	Day display <ul style="list-style-type: none"> • %t[dddd]: The day of the week is displayed in numerals (1 = Monday, ..., 7 = Sunday) • %t[ddd]: The day of the week is displayed in English (Example: Monday) • %t[dd]: The day of the week is displayed in abbreviated English (Example: Mon) • %t[dd]: The date is displayed in two digits (01 to 31) • %t[d]: The date is displayed in one or two digits (1 to 31)
	%t[jjjj]	Day of year display %t[jjjj] = 001 to 366
String	%s	The character string is displayed in STRING type or WSTRING type.
Other	%%	The percent symbol is displayed. The percent notation can be displayed by adding another numerical value format to the beginning. (Example: Specifying %d %% will display "decimal number" %.)
	%c	Hexadecimal notation character is displayed in ASCII. Example: "16#41" is displayed as "A" in the tool element.

■ Regarding the main property settings of the tool elements

Below are the main properties and their corresponding settings for each tool element.

Tool Element	Property	Setting Value
Lamp	Variable	BOOL type variable
DIP Switch Power Switch Push switch Push switch LED Rocker Switch Rotary switch		
Checkbox		
scroll bar Bar display Meter 90° Meter 180° Meter	Value	Numeric variables
Slider Spin Control Potentiometer Radio button Progress bar	Variable	
Analog Clock	Variable	TOD type variables
Table	Data arrays	Array type variables

8.7 Visualization Function

Tool Element	Property	Setting Value
Histogram		
Rectangle Round rectangle Ellipse Pie Button	Input configuration	Set in each Input configuration

Info.

- About the display priority of input text

Tool elements, such as Rectangle, have several display settings: Text, Text Variable, Dynamic Text (text index) and Tooltip, Tooltip Variable, and Dynamic Text (tooltip index). If you set them at the same time, the display order is fixed.

Setting item 1	Setting item 2	Items to display
Texts	Text variable	Texts
Tooltip	Tooltip variable	Tooltip
Texts	Dynamic text (Text index)	Dynamic text
Tooltip	Dynamic text (Tooltip index)	Dynamic text
Text variable	Dynamic text (Text index)	Dynamic text
Tooltip variable	Dynamic text (Tooltip index)	Dynamic text

Input Configuration

The properties of some tool elements, such as "Rectangle" and "Button", include [Input Configuration], which enables opening a dialog or rewriting a variable by a mouse click or other action.

■ List of input configuration items

The following [Input Configuration] items are available.

Setting item	Overview
OnDialogClosed	When the dialog is closed, an event occurs. This setting item applies to dialogs that are opened by [Input Configuration] of the same tool element as OnDialogClosed.
OnMouseClicked	When the mouse button is pressed and released on the tool element, an event occurs.
OnMouseDown	When the mouse button is pressed on the tool element, an event occurs.
OnMouseEnter	When the mouse pointer is placed on the tool element, an event occurs.
OnMouseLeave	When the mouse pointer is moved away from the tool element, an event occurs.
OnMouseMove	Do not use.
OnMouseUp	When the mouse button is released on the tool element (regardless of where it is pressed) or when the mouse button is pressed and released (regardless of where it is released), an event occurs.
Tap	While the tool element remains clicked, the set BOOL type variable is switched between TRUE and FALSE.
Switching	Every time the tool element is clicked, the set BOOL type variable is switched between TRUE and FALSE.
Hot key	Do not use.

Info.

- Do not set more than one [Input Configuration] for one tool element.
- Do not set more than one event for one [Input Configuration].

■ List of events

The following events are available depending on the input configuration. Details on each event will be described later.

Setting item	Overview
Close Dialog	Close the set visualization dialog. The variables declared in the interface editor can be used.
Open Dialog	Open the set visualization dialog. The variables declared in the interface editor can be used.
Change the language	Change the language to be displayed in the visualization. You can change to the language displayed in the Language field, which you added to the TextList/GlobalTextList as text.
Change shown visualization	Change the visualization that will be displayed.

8.7 Visualization Function

Setting item	Overview
Write a Variable	Write a value to the set variable. Enter the value to be written from the keyboard of the PC.
Toggle a variable	Switch the BOOL type variable between TRUE and FALSE.

■ Close Dialog

Double-click "Close Dialog" to display the settings pane on the right side.

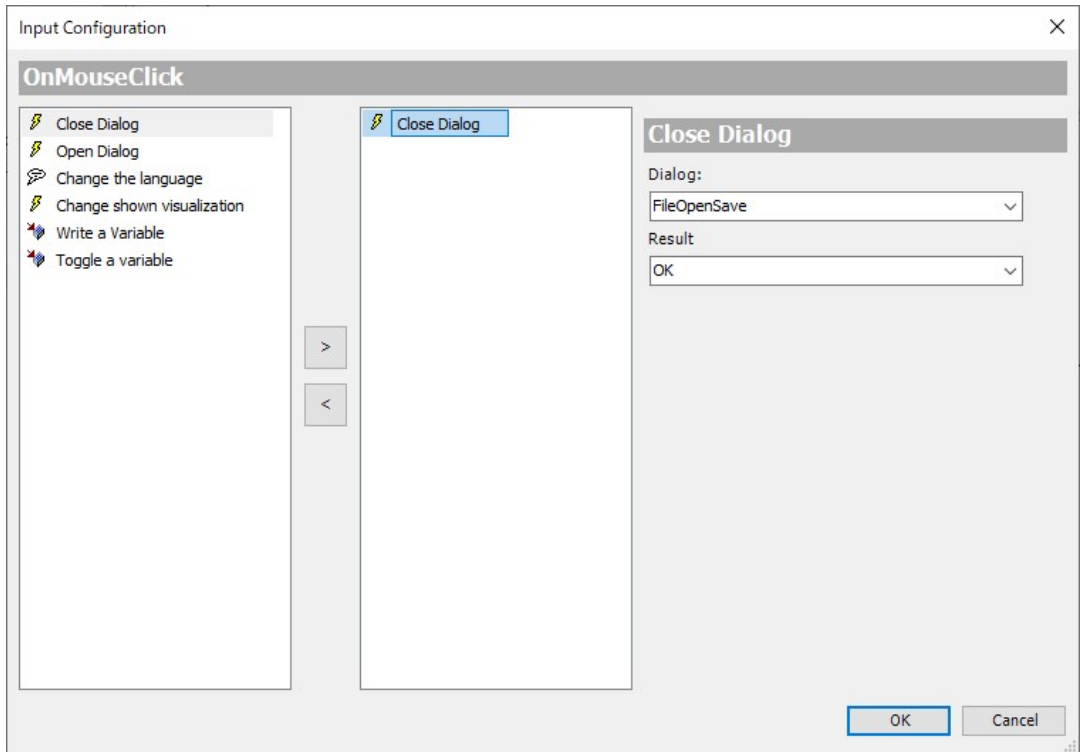

Setting item	Overview
Dialog	Set the visualization name for the dialog to be closed. (Note 1)
Result	Set the return value when the dialog is closed. None, OK, Cancel, Abort, Retry, Ignore, Yes, No

(Note 1) Do not use set values other than those of the visualization in the project.

■ Open Dialog

Double-click "Open Dialog" to display the settings pane on the right side.

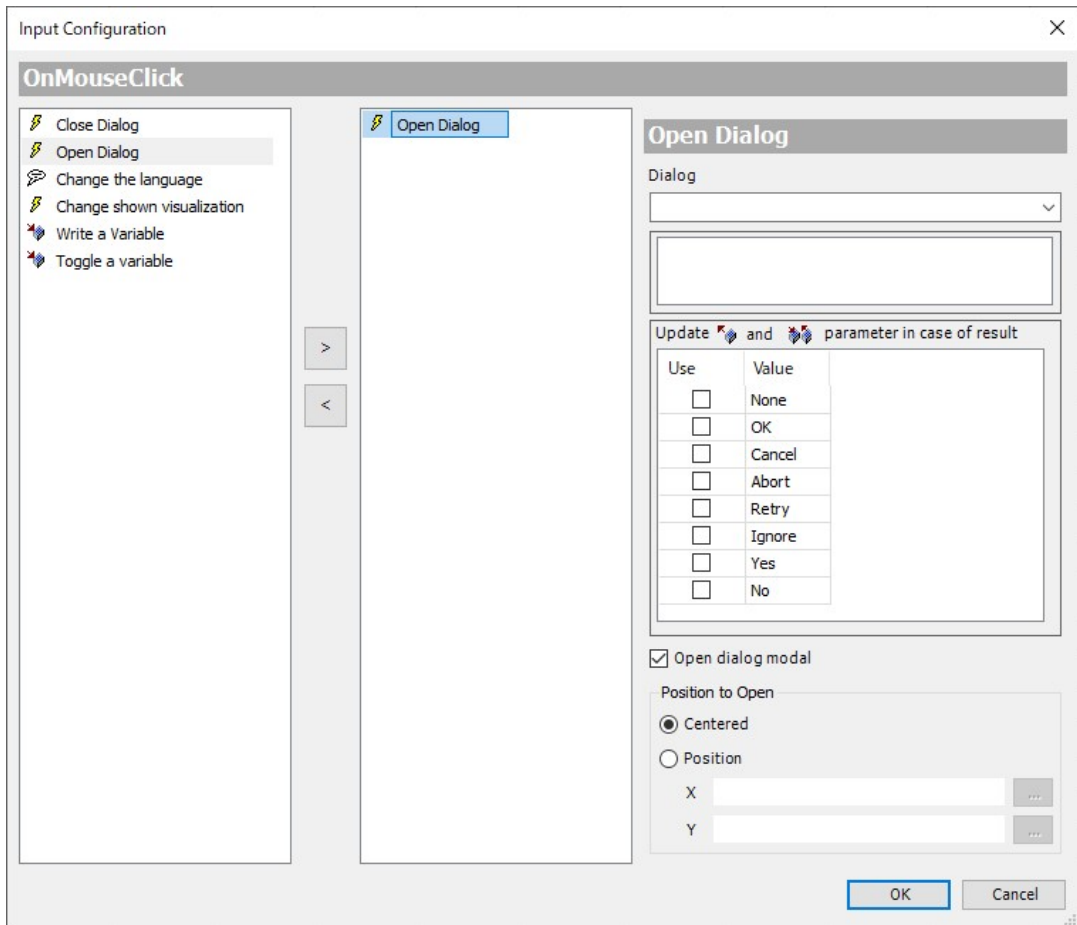

Setting item		Overview
Dialog		Set the name of the visualization to be opened as a dialog. If any variable is declared in the interface editor for the visualization to be opened as a dialog, the following setting values are displayed in the blank field under "Dialog". <ul style="list-style-type: none"> Parameter: The variable name declared in the interface editor is displayed. Type: The type of the variable declared in the interface editor is displayed. Value: The variable declared in the project is set.
Update		Define the return value for the dialog. None, OK, Cancel, Abort, Retry, Ignore, Yes, No
Open dialog modal		If checked, the visualization displaying dialogs can only operate on the dialogs. Use in the initial state (checked state).
Position to Open	Centered	The dialog will open in the center of the implementation section of the visualization being displayed.

8.7 Visualization Function

Setting item		Overview
	Position	Do not use.

Info.

- For visualizations used in "Open Dialog" and "Close Dialog", you need to set "Use visualization as" to 'Dialog' in the object's properties settings.
For details, refer to "[Visualization Properties](#)".

- Variable declared in the interface editor and return value

"Open Dialog" and "Close Dialog" use the variable declared in the interface editor. The behavior of the variable differs depending on the variable type declared.

- Variable declared in VAR_INPUT

This is used as an input variable to the dialog.

When a dialog is opened by "Open Dialog", the variable value set in "Parameter" is substituted for the variable set in "Value".

- Variable declared in VAR_OUTPUT

This is used as an output variable from the dialog.

When a dialog is closed by "Close Dialog", if the return values specified for "Open Dialog" and "Close Dialog" are the same, the variable value set in "Value" is substituted for the variable set in "Parameter".

- Variable declared in VAR_IN_OUT

This is used as an input/output variable for the dialog.

It performs the above two operations.

■ Change the language

Double-click "Change the language" to display the settings pane on the right side.

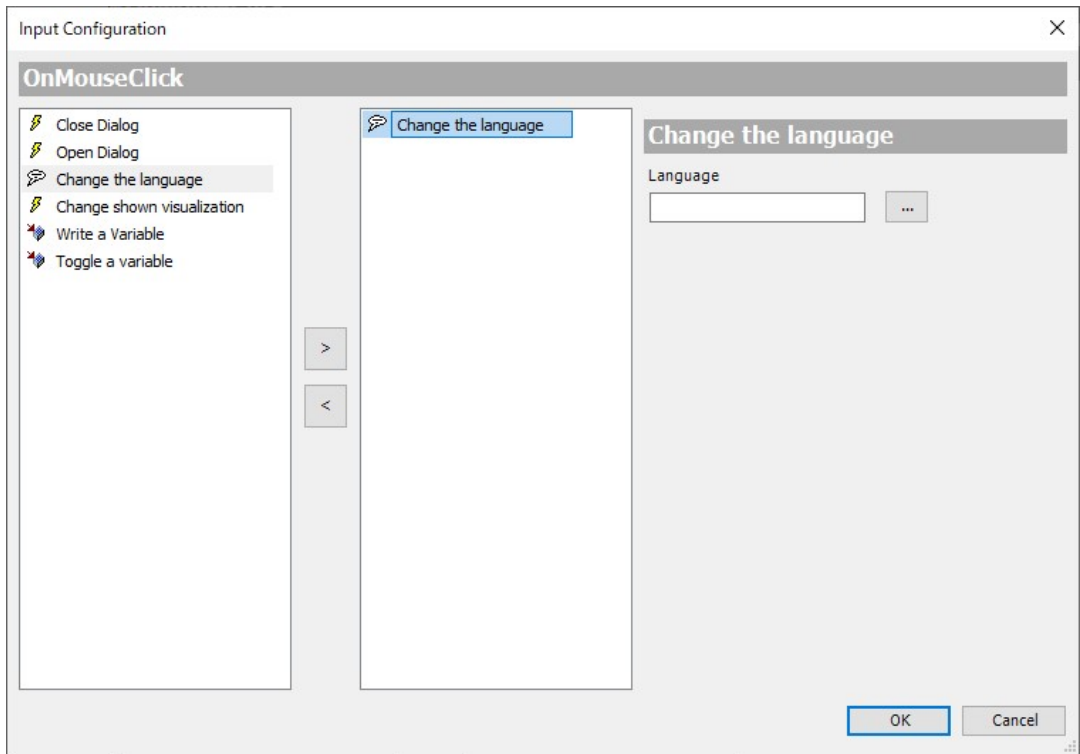

Setting item	Overview
Language	Set the name of the language you want to display from those specified in the TextList. If this field is left blank or set to a nonexistent language name, the language specified in the 'Default' field will be set.

i Info.

- The following shows the range in which "Change the language" will change the language when executed.
 - Text of the visualization that executed "Change the language"
 - Text of dialogs opened from the visualization that executed "Change the language"
 - Text of visualizations opened from the visualization that executed "Change the language"
- For text of visualizations that do not execute "Change the language", the language will not be changed.
- If you close the visualization being displayed, the language will return to the language specified in the 'Default' field.

8.7 Visualization Function

■ Change shown visualization

Double-click "Change shown visualization" to display the settings pane on the right side.

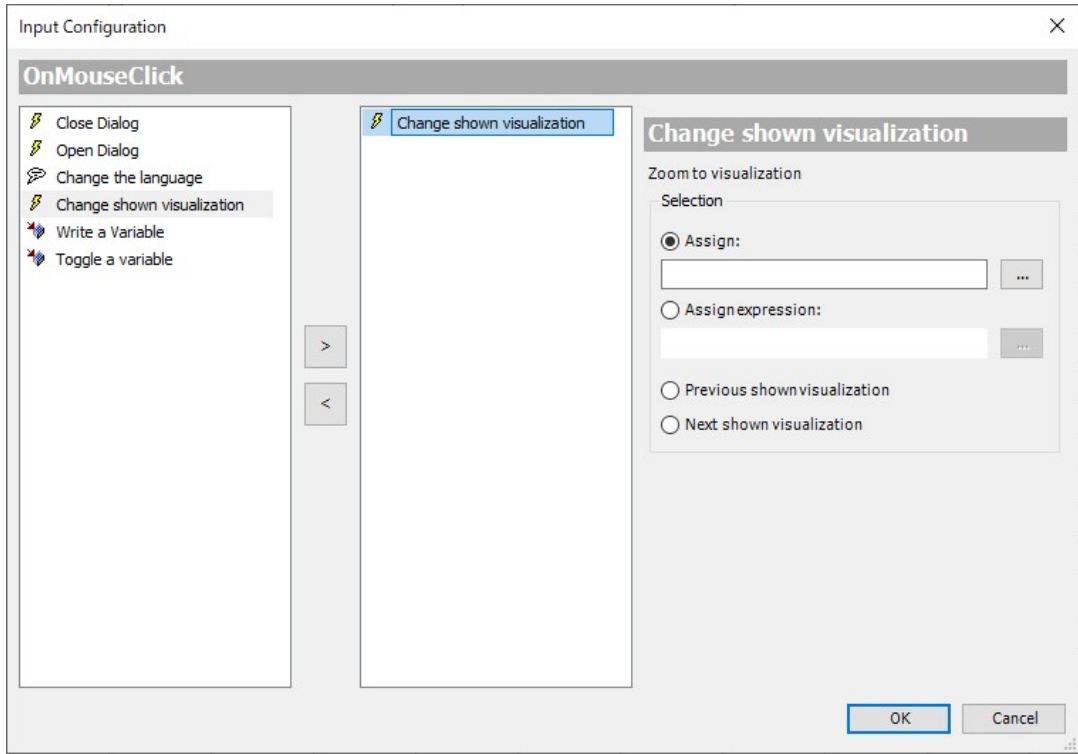

Setting item		Overview
Selection	Assign	Specify the visualization to change to as an object name.
	Assign expression	Specify the visualization to change to as a STRING type variable.
	Previous shown visualization	The previously displayed visualization is displayed. You can return to up to nine previous visualizations.
	Next shown visualization	If the visualization is changed by "Previous shown visualization", the visualization before the change is displayed.

■ Write a Variable

Double-click "Write a Variable" to display the settings pane on the right side.

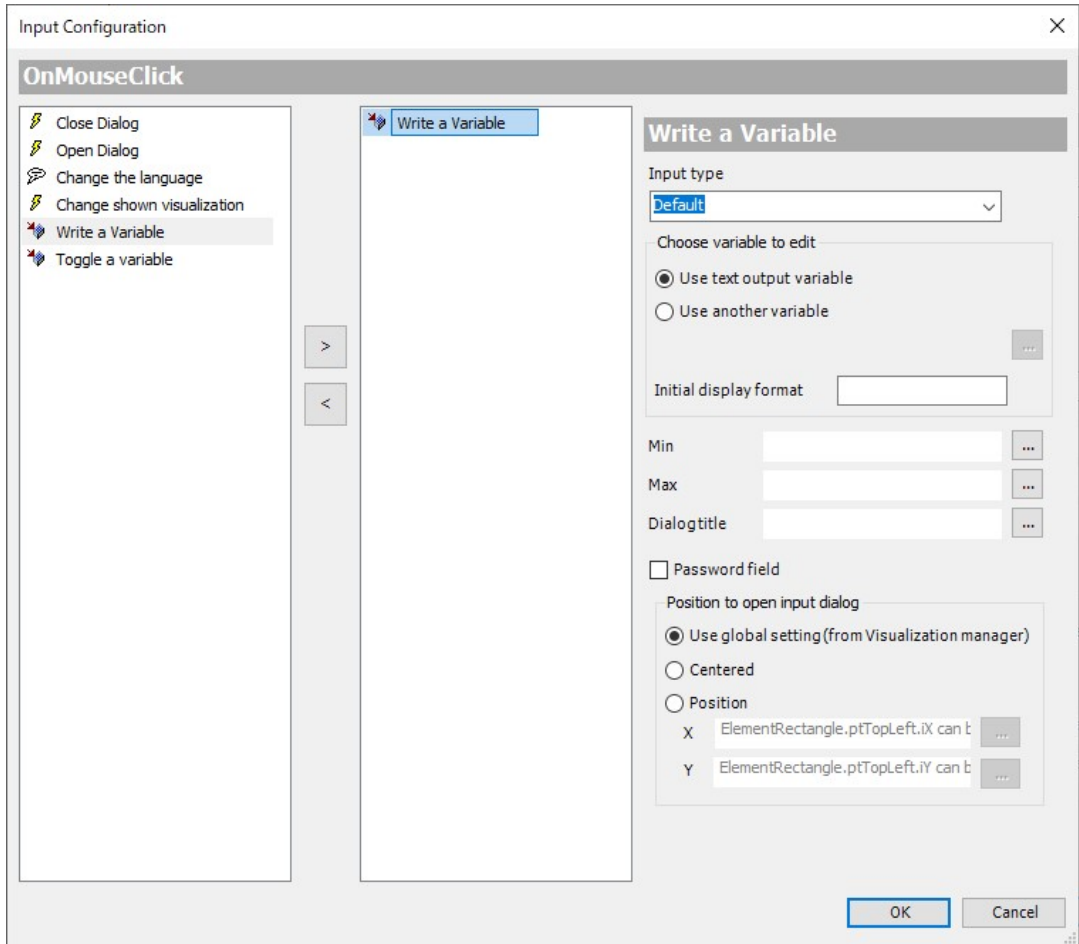

Setting item		Overview
Input type	Default	You can enter a numerical value or text in the input field that will be displayed.
	Text input	
	Limited text input	You can enter a numerical value or text in the input field that will be displayed as a dialog. When "Min" and "Max" are set, the lower and upper limits of the input range will be displayed in 'Min' and 'Max', respectively. If you enter a value outside the input range, the value in 'Min' or 'Max' will be displayed in red.
	VisuDialogs.Keypad	Do not use.
	VisuDialogs.Numpad	
	VisuDialogs.NumpadExtended	

8.7 Visualization Function

Setting item		Overview
Choose variable to edit	Use text output variable	Use the variable set in the tool element property [Text variable]-[Text variable] as the variable to be written.
	Use another variable	Set a variable to be written.
	Initial display format	Do not use.
Min		Set the lower limit of the input range. ^(Note 1) The value will not be written if it is less than the lower limit.
Max		Set the upper limit of the input range. ^(Note 1) The value will not be written if it is more than the upper limit.
Dialog title		Do not use.
Password field		If checked, the variable value to be written will be displayed as asterisks (*).
Position to open input dialog	Use global setting (from Visualization manager)	Do not use.
	Centered	An input dialog will open in the center of the implementation section of the visualization being displayed.
	Position	Do not use.

(Note 1) Set the value so that "Min" is less than "Max".

■ Toggle a variable

Double-click "Toggle a variable" to display the settings pane on the right side.

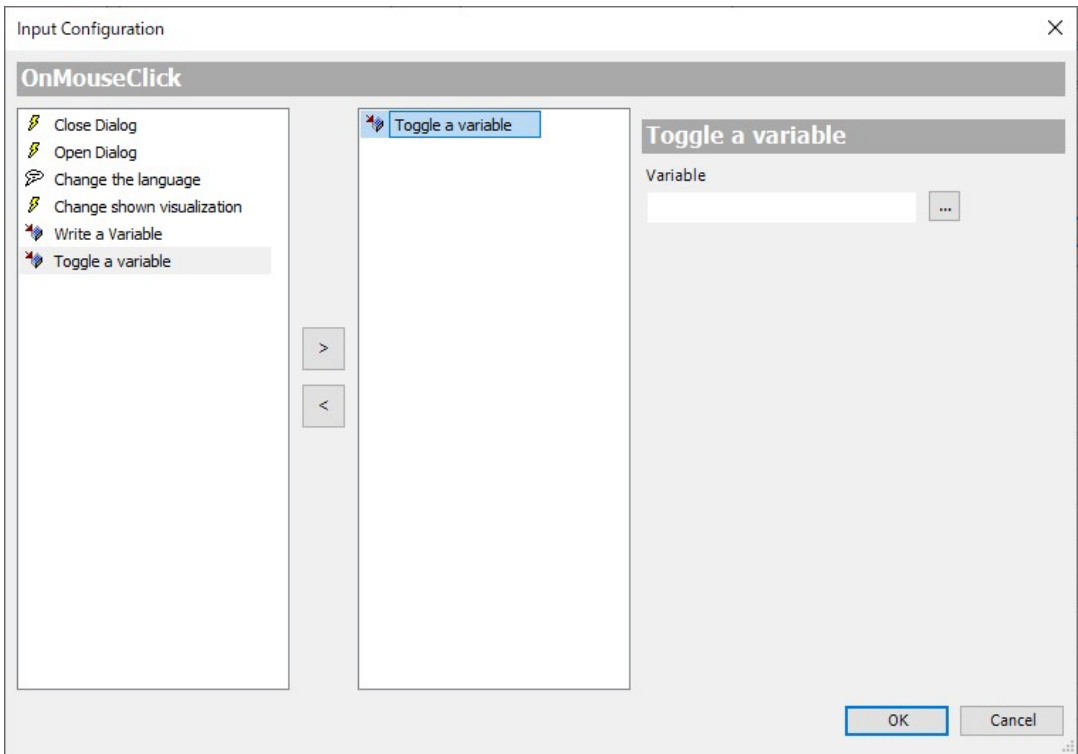

Setting item	Overview
Variable	Set a BOOL type variable to switch between TRUE and FALSE.

8.7 Visualization Function

8.7.5 Visualization examples

Visualization Example1 : axis movement and Monitor window

Create a monitor window to execute a jog or axis stop and to retrieve each parameter of the axis.



1.2 Procedure

- Place the tool elements required for visualization.
The tool elements used for this visualization are as follows.

Tool element	volume
Rectangle	1
Label	3
Button	4
Group box	3
Table	1
Spin control	1
Lamp	1
Power switch	1

- Set "Text" for each Tool element.

Tool element	Setting item1	Setting item2	Description
Rectangle	Text	Text	%s
Label1	Text	Text	Velocity [u/s]
Label2	Text	Text	Communication Available
Label3	Text	Text	Axis State
Button1	Text	Text	Positive
Button2	Text	Text	Negative
Button3	Text	Text	Stop
Button4	Text	Text	Homing
Group box1	Text	Text	Servo ON
Group box2	Text	Text	Axis Movement
Group box3	Text	Text	Monitor

3. Write a program that works with Visualization.

Add a POU object to the project named 'MC_PRG' and include the following

- Declaration section

```
// Motion
MC_Power_0      : MC_Power;
bRegON          : BOOL;

MC_Jog_0        : MC_Jog;
bForward        : BOOL;
bBackward       : BOOL;
lrVel           : LREAL:=10;
lrAcc           : LREAL:=100;
lrDec           : LREAL:=200;

MC_Stop_0       : MC_Stop;
bStop           : BOOL;

ETC_CO_SdoWrite_0 : ETC_CO_SdoWrite;
bExe_SdoWrite   : BOOL;
wIndexW         : WORD;
bySubIndexW     : BYTE;
diWriteData     : DINT;
eWriteSize      : CAA.SIZE;

MC_Home_0       : MC_Home;
bExe_Home       : BOOL;
bHome           : BOOL;
iStep           : INT;

// Monitor
alrParameters   : ARRAY [1..3] OF ARRAY [1..3] OF LREAL:=[[0,1,2],[0,0,0],[0,0,0]];
```

- Implementation section

8.7 Visualization Function

```
MC_Power_0(  
    Axis:=Axis1,  
    Enable:=TRUE,  
    bRegulatorOn:=bRegON,  
    bDriveStart:=TRUE,  
);  
  
MC_Jog_0(  
    Axis:=Axis1,  
    JogForward:=bForward,  
    JogBackward:=bBackward,  
    Velocity:=lrVel,  
    Acceleration:=lrAcc,  
    Deceleration:=lrDec,  
);  
  
MC_Stop_0(  
    Axis:=Axis1,  
    Execute:=bStop,  
    Deceleration:=10000,  
);  
  
ETC_CO_SdoWrite_0(  
    xExecute:=bExe_SdoWrite,  
    uiDevice:=1001,  
    wIndex:=wIndexW,  
    bySubIndex:=bySubIndexW,  
    udiTimeOut:=5000,  
    pBuffer:=ADR(diWriteData),  
    szSize:=eWriteSize  
);  
  
MC_Home_0(  
    Axis:=Axis1,  
    Execute:=bExe_Home,  
    Position:=0,  
);  
  
// MC_Home Sequence  
CASE iStep OF  
    0:  
        diWriteData:=16#21;  
        wIndexW:=16#6098;  
        eWriteSize:=1;  
        IF bHome = TRUE THEN  
            bExe_SdoWrite:=TRUE;  
        END_IF  
        IF ETC_CO_SdoWrite_0.xDone = TRUE THEN  
            bExe_SdoWrite:=FALSE;  
            iStep:=1;  
        END_IF  
    1:  
        diWriteData:=16#D55550;  
        wIndexW:=16#6099;  
        bySubIndexW:=1;  
        eWriteSize:=4;
```

```

bExe_SdoWrite:=TRUE;
IF ETC_CO_SdoWrite_0.xDone = TRUE THEN
    bExe_SdoWrite:=FALSE;
    iStep:=2;
END_IF
2:
diWriteData:=16#155550;
wIndexW:=16#6099;
bySubIndexW:=2;
eWriteSize:=4;
bExe_SdoWrite:=TRUE;
IF ETC_CO_SdoWrite_0.xDone = TRUE THEN
    bExe_SdoWrite:=FALSE;
    iStep:=3;
END_IF
3:
diWriteData:=16#F42400;
wIndexW:=16#609A;
bySubIndexW:=0;
eWriteSize:=4;
bExe_SdoWrite:=TRUE;
IF ETC_CO_SdoWrite_0.xDone = TRUE THEN
    bExe_SdoWrite:=FALSE;
    bExe_Home:=TRUE;
    iStep:=4;
END_IF
4:
IF MC_Home_0.Busy = FALSE THEN
    bHome:=FALSE;
    bExe_Home:=FALSE;
    iStep:=0;
END_IF
END_CASE

// Monitor Table
alrParameters[2][1]:=Axis1.fSetPosition;
alrParameters[2][2]:=Axis1.fSetVelocity;
alrParameters[2][3]:=Axis1.fSetAcceleration;
alrParameters[3][1]:=Axis1.fActPosition;
alrParameters[3][2]:=Axis1.fActVelocity;
alrParameters[3][3]:=Axis1.fActAcceleration;

```

4. Set the variable required for each Tool element to work.

Tool element	Setting item1	Setting item2	Setting item3	Description
Rectangle	Text variable	Text variable		Axis1.nAxisState
Button1	Input configuration	Toggle	variable	MC_PRG.bForward
Button2	Input configuration	Toggle	variable	MC_PRG.bBackward
Button3	Input configuration	Toggle	variable	MC_PRG.bStop

8.7 Visualization Function

Tool element	Setting item1	Setting item2	Setting item3	Description
Button4	Input configuration	Toggle	variable	MC_PRG.bHome
Table	Data arrays			MC_PRG.alrParameters
Spin control	variable			MC_PRG.IrVel
	Number format			%3.1f
	Interval			1
	Value range	Minimum value		1
		Maximum value		500
Input configuration	OnMouseDown		Refer to the next image for details.	
Lamp	variable			Axis1.bCommunication
Power switch	variable			MC_PRG.bRegON

- Input configuration of Spin control

The screenshot shows the 'Input Configuration' dialog box for the 'OnMouseDown' event. On the left, a list of actions includes 'Close Dialog', 'Open Dialog', 'Change the language', 'Change shown visualization', 'Write a Variable' (which is selected and highlighted), and 'Toggle a variable'. The main area is titled 'Write a Variable' and contains the following settings:

- Input type:** Default
- Choose variable to edit:**
 - Use text output variable
 - Use another variable
- Initial display format:** (empty text field)
- Min:** (empty text field)
- Max:** (empty text field)
- Dialog title:** (empty text field)
- Password field
- Position to open input dialog:**
 - Use global setting (from Visualization manager)
 - Centered

Buttons for 'OK' and 'Cancel' are located at the bottom right of the dialog.

5. Create a TextList.

Add the TextList object to the project as 'TextList' and describe the following. The contents described here will be used in the Table object.

ID	Default
0	Position [u]
1	Velocity [u/s]

ID	Default
2	Acceleration [u/s^2]

6. Set the properties of the Table.

Set the header of the item to be displayed in the [Show row header] of each [Columns] in the table.

Setting item1	Setting item2	Setting item3	Setting item4	Description
Columns	Columns	[0]	Show row header	Item
		[1]	Show row header	Set Value
		[2]	Show row header	Actual Value

Next, uncheck [Display the row header] and check [Columns] - [Use template] for each column. In the [template] field that appears, set the contents to be displayed in each column of the Table.

- Creation of 'item' column

Setting item1	Setting item2	Setting item3	Setting item4	Description
[0]	template	Dynamic text	TextList	'TextList'
			TextIndex	MC_PRG.alrParameters[1] [INDEX]

- Creation of 'Set Value' column

Setting item1	Setting item2	Setting item3	Setting item4	Description
[1]	template	Text	Text	%3.1f

- Creation of 'Actual Value' column

Setting item1	Setting item2	Setting item3	Setting item4	Description
[2]	template	Text	Text	%3.1f

Adjust the alignment, size, etc. of each Tool element.

8.7 Visualization Function

Visualization Example2 : Language Change and Dialog Window

Use the textList language addition to change the language displayed on the Visualization window or to create a parameter setting window using a dialog box. In this example, the language is changed from Japanese to English.

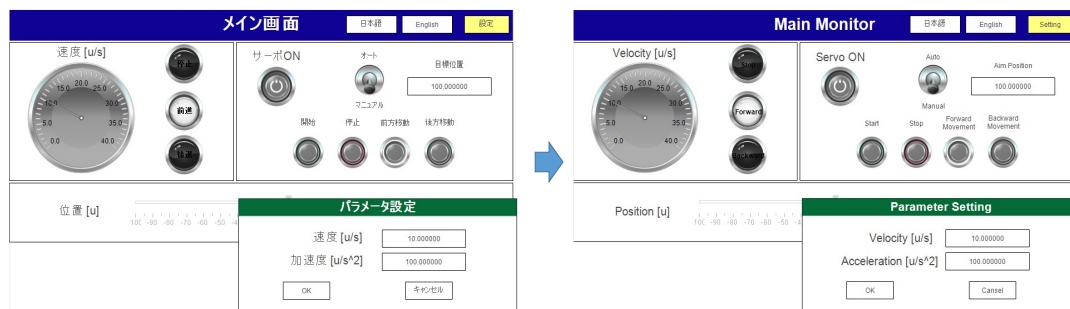

1.2 Procedure

1. Create a Visualization that will serve as the main window.
Add the Visualization to the project and place the necessary Tool elements. Then, set each property (text, variable, etc.).



Of these, the following tool elements are used to change the language and display dialogs.

Tool element	Setting item1	Setting item2	Description	purpose
Rectangle	Text	Text	日本語	Language Change
Rectangle	Text	Text	English	Language Change
Rectangle	Text	Text	Setting	Displaying Dialogs

2. Create a Visualization for the dialog window.
Add Visualization to the project and declare the variables to be passed in the dialog in InterFace Edeitor.

```

VAR_IN_OUT
  Velocity      : LREAL;
  Acceleration  : LREAL;
END_VAR

```

Next, place the required Tool element and set its properties.

Descriptions of the main properties are shown below.

The "Text variable" set in Rectangle1 and Rectangle2 refers to the variable declared in the InterFace Edeitor.

Item	Setting item1	Setting item2	Description
Rectangle1	Text	Text	%f
	Text variable	Text variable	Velocity
	Input configuration	OnMouseClicked	Writing Variables
Rectangle2	Text	Text	%f
	Text variable	Text variable	Acceleration
	Input configuration	OnMouseClicked	Writing Variables
Rectangle3	Text	Text	OK
	Input configuration	OnMouseClicked	dismiss a dialog
Rectangle4	Text	Text	Cancel
	Input configuration	OnMouseClicked	dismiss a dialog

Setting background and Visualization properties

Item	Setting item1	Setting item2	Description
Background	Color setting	User color	Enable
			White
Visualization property	Visualization tab	Use Visualization as follows	Dialog
		Use the specified Visualization size	Enable
		Visualization size	Width : 500 Height : 200

For the Input configuration of Rectangle 3 and Rectangle 4, set "dismiss a dialog".

8.7 Visualization Function

- For "Dialog," select the Visualization for the created dialog screen. (In this example, the Visualization name for the Dialog is "EX02_Dialog".)
- In the "Result" section, select the text that is to be included in each Rectangle object.

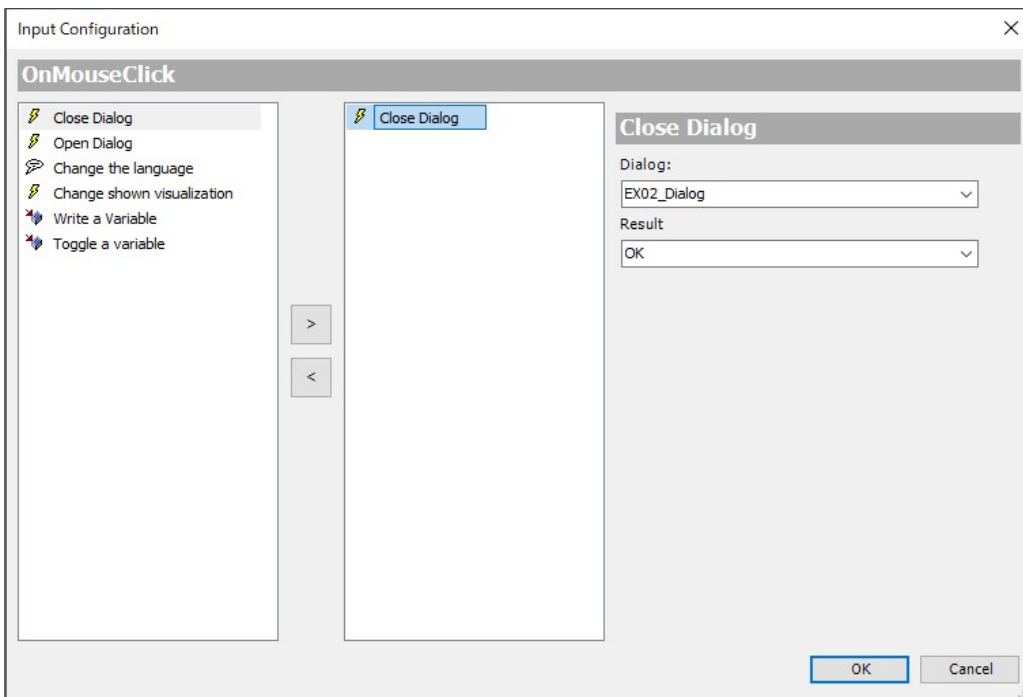

3. Add the language to be changed to TextList.

Add "en" column to GlobalTextList in the device tree. Put 日本語 in the "Default" column and the English translation for the "Default" column in the "en" column. A partial example is shown below.

- GlobalTextList

ID	Default	en
943	English	
365	キャンセル	Cansel
108	サーボ ON	Servo ON
588	日本語	
238	速度 [u/s]	Velocity [u/s]

4. Set [Input configuration] for language change.

In the properties of each Rectangle object for language change on the main screen, set the "Change language" action to [Input configuration] - [OnMouseClicked].

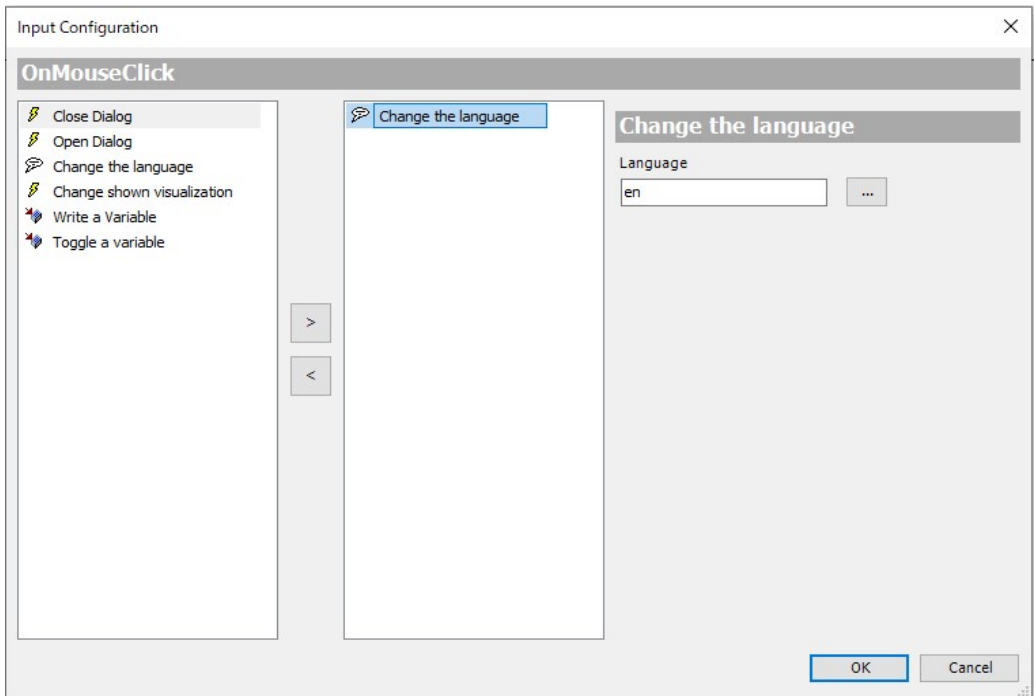

Set the language of each Rectangle object as follows. For "日本語," the "Language" field in [Input configuration] should be left blank, since the content is listed in the "Default" column of the TextList.

Text	Language
日本語	
English	en

- Set [Input configuration] to display a dialog.
Set the "Open Dialog" action to [Input configuration] - [OnMouseClicked] in the properties of the Rectangle object for displaying the main window language.

8.7 Visualization Function

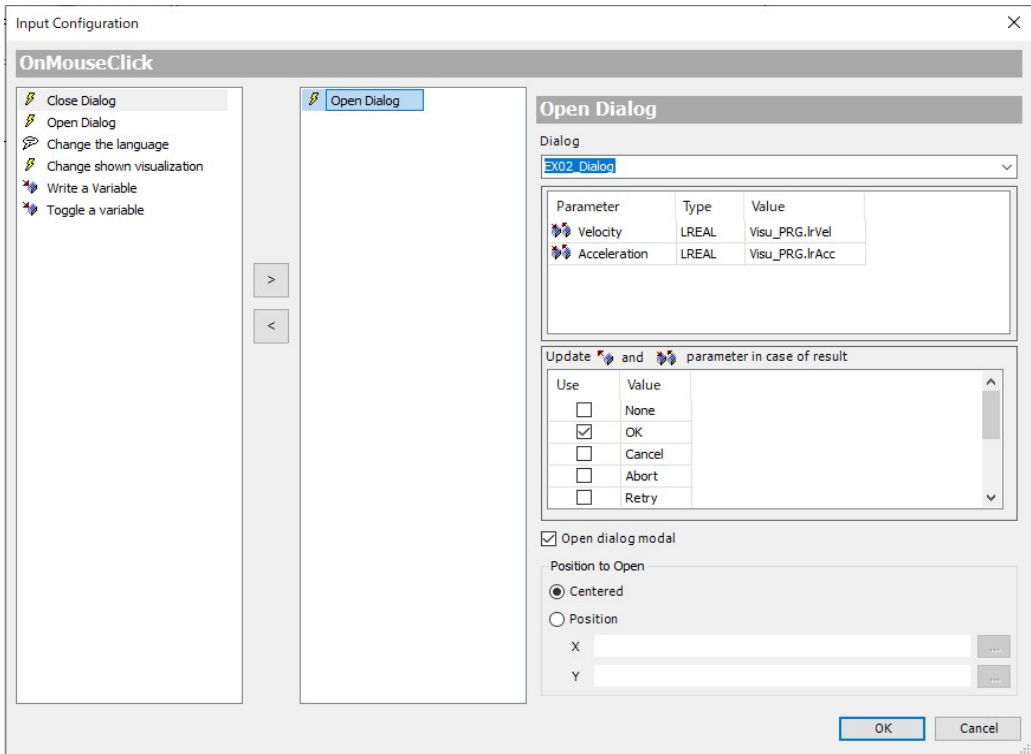

- Set the "Dialog" to the Visualization name created in step 2.
- Set "Value" to the variable on the POU that reflects each "Parameter" entered in the dialog.
- For the "Update" part, check the "Value" is "OK" checkbox to reflect the value in the POU only when the "OK" button in the dialog is clicked.
- The other settings are to be used as they are in the initial state.

This completes the settings.

8.8 Reset of Controller

Reset operation resets the active applications and initializes the variables and settings.

Reset is divided into the following four types and variables and settings that are initialized differ according to the reset type.

Reset Warm

Initializes variables other than the RETAIN and PERSISTENT variables.

Reset Cold

Initializes variables other than the PERSISTENT variable.

Reset Origin

Initializes all variables. Active applications are deleted from the GM1 controller.

Device Reset

Initializes all variables and device user management information. Applications and source code are deleted from the GM1 controller.

- The following table shows the items that are initialized by reset or other tool operation or controller operation.

○ : Retained × : Initialized Update: Updated

* : If you change the structure of the data by adding or deleting variables, the persistent variables will be cleared if you download it as it is, so please implement it together with "14.5.5 Saving and restoring persistent variables"

Operation		Variable s other than "RETAIN / PERSIS TENT"	RETAIN variable (RETAIN)	PERSIS TENT Variable s (PERSIS TENT)	(Boot) Applicati on	User manage ment	Source file	IP address	RTC time zone
Tool operation	Stop	○	○	○	○	○	○	○	○
	Reset warm	×	○	○	○	○	○	○	○
	Reset Cold	×	×	○	○	○	○	○	○
	Downlo ad	×	×	○*	Update	○	Update	Update	○
	Online change	○	○	○*	Update	○	Update	○	○
	Reset Origin	×	×	×	×	○	○	○	○
	Resetting "Device"	×	×	×	×	×	×	○	○
Controlle r operation	Power cycling	×	○	○	○	○	○	○	○
	Resetting "Device" by means of	×	×	×	×	×	×	○	○

8.8 Reset of Controller

Operation	Variable s other than "RETAIN / PERSIS TENT"	RETAIN variable (RETAIN)	PERSIS TENT Variable s (PERSIS TENT)	(Boot) Applicati on	User manage ment	Source file	IP address	RTC time zone
hard switching								

8.8.1 Reset Warm, Reset Cold, and Reset Origin

Execute Warm Reset, Cold Reset, and Reset Origin by selecting them from "Online" on the menu bar. This section explains the execution procedure, using Warm Reset as an example.

1 Procedure

- From the menu bar, select **Online>Reset Warm**.

Example: "Reset Warm" execution procedure

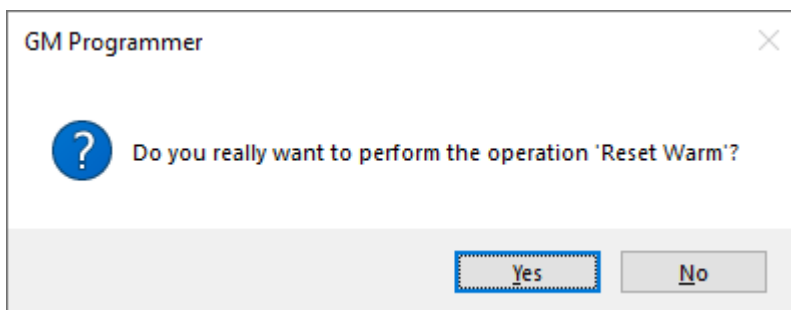

- Click the [Yes] button.
Reset warm will be executed.

8.8.2 Executing Device Reset from GM Programmer

Device reset can be executed from the GM1 controller as well as from GM Programmer. To execute device reset from GM Programmer, right-click in the navigator pane and execute device reset from the context-sensitive menu that is displayed.

1 2 Procedure

1. Right-click the [Device] object in the navigator pane and then select "Reset Origin" from the context-sensitive menu that is displayed.

A confirmation message will be displayed, asking whether to execute device reset.

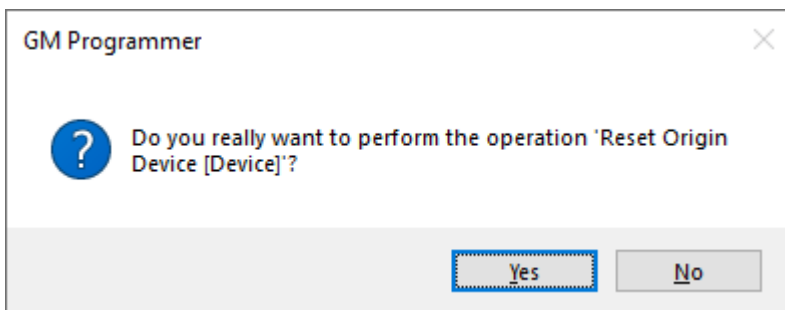

2. Click the [Yes] button.
Device reset will be executed. When device reset is executed, you are logged out.

i Info.

- If you right-click the [Application] object in the navigator pane and select "Delete application from device", the selected application will be removed.

8.8 Reset of Controller

8.8.3 Executing Device Reset from GM1 Controller

Device reset can be executed from the GM1 controller.

1 2 Procedure

1. Check that the power is OFF, set the mode selector switch to STOP, and set the reset bit of the DIP switch to ON.

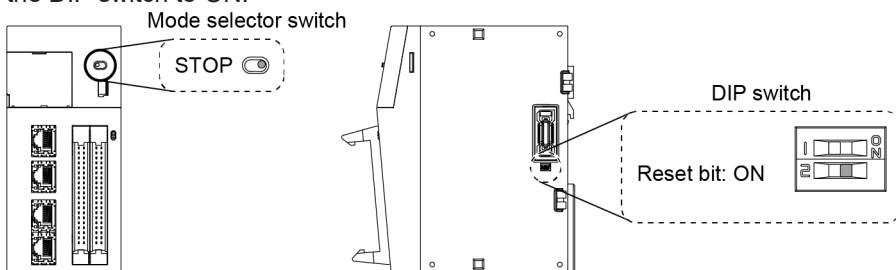

2. Turn the power ON.
Device reset will be executed.
3. When the "RUN", "STOP", and "ERROR" LEDs go out, device reset is completed.

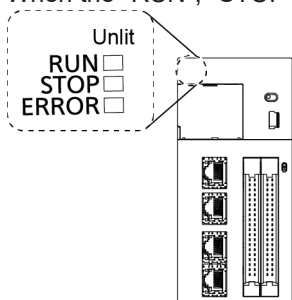

After device reset is completed, turn the power OFF and set the reset bit of the DIP switch

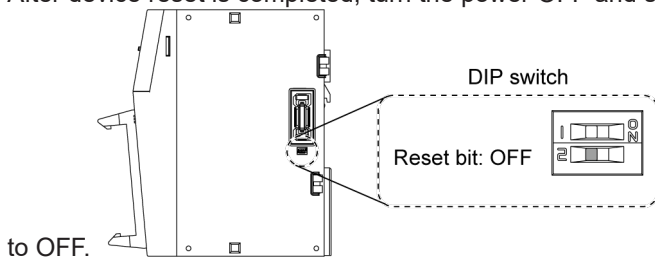

to OFF.

8.9 Checking the Status of GM1 Controller

8.9.1 Checking Logs

You can check logs of GM1 controller startup, shutdown, application download, and other events.

1 2 Procedure

1. Connect the PC where GM Programmer is installed and the GM1 controller. For details, refer to "7.5 Connecting to the GM1 Controller". Double-click the [Device] object in the navigator pane.

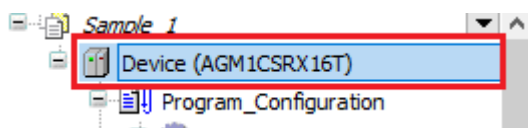

The Device setting window will be displayed.

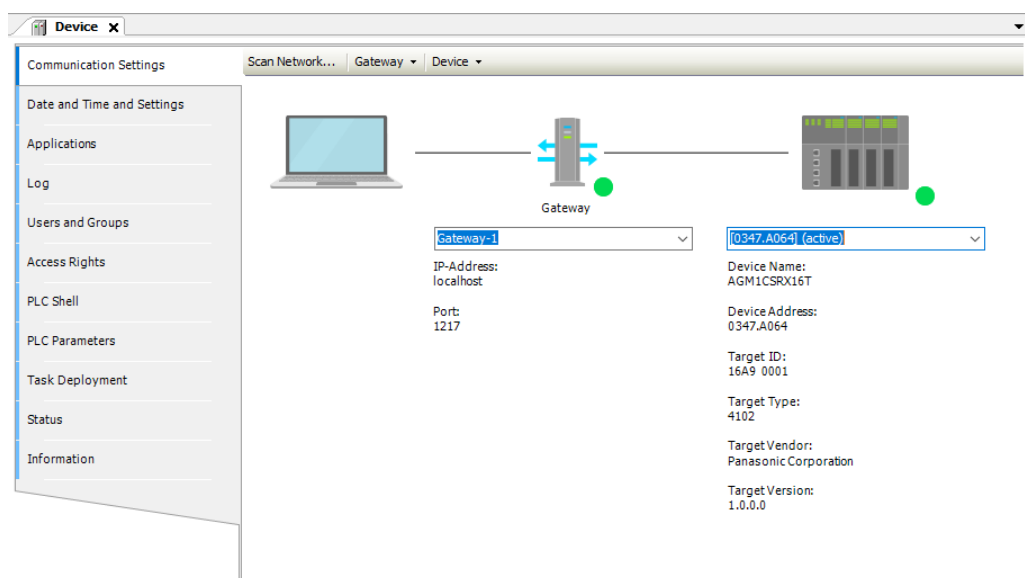

2. Click the [Log] tab. The log window will be displayed.



8.9 Checking the Status of GM1 Controller

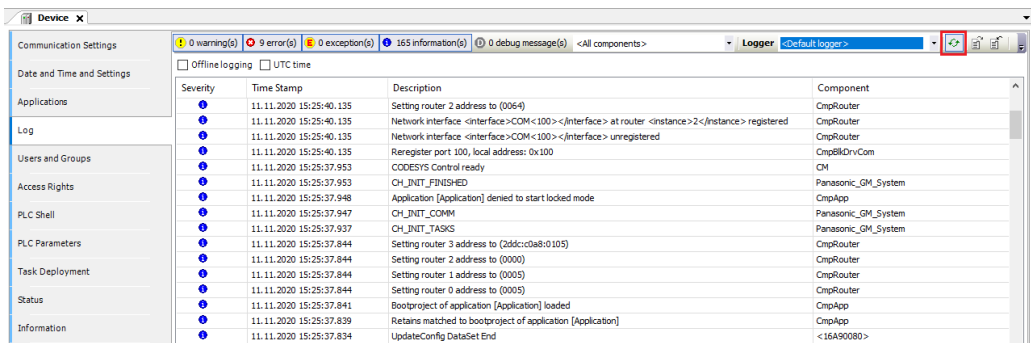

3. Click the  icon.
The log will be displayed.



Info.

- The displayed log can be exported (by clicking ) or imported (by clicking ) as an XML file.

8.9.2 Checking the Status

You can check only one error item that has the highest severity level among all errors currently occurring in the GM1 controller.

1 2 Procedure

1. Connect the PC where GM Programmer is installed and the GM1 controller.
For details, refer to "7.5 Connecting to the GM1 Controller".

2. From the menu bar, select **Online>Status**.

The "Status" dialog box will be displayed. You can check only one error item that has the highest severity level among all errors currently occurring in the GM1 controller.

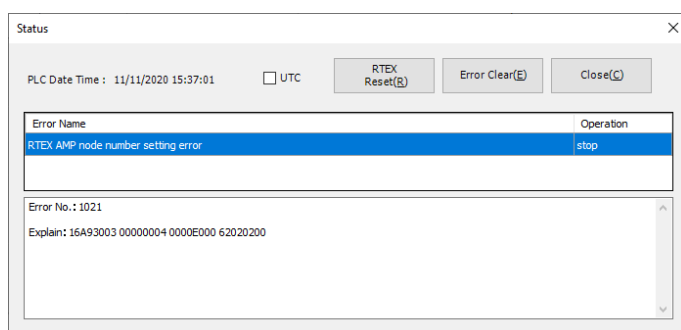

3. Click the "Close" button.
The "Status" dialog box will be closed.

i Info.

Error types

The following table shows the types and recovery methods of errors that are displayed. Clicking the [Error Clear] button or [RTEX Reset] button deletes the target status item.

Error type	Recovery method
System error (power cycle)	Turn the GM1 controller OFF and then ON.
System error (Reinitialize)	Reinitialize the system. (Applications will be downloaded without executing a reset and the mode will be set to RUN.)
System error (Stop operation)	Click the [Error Clear] button.
System error (Continue operation)	Click the [Error Clear] button.
Incorporation / expansion error	Reinitialize the system.
Unit error	Click the [Error Clear] button or reinitialize the system.
RTEX error	Click the [RTEX Reset] button.

Refer to "8.11.2 Checking and Clearing Errors Using GM Programmer".

8.9 Checking the Status of GM1 Controller

8.9.3 Checking the System Data History

You can check histories of errors that have occurred up until now.

1 2 Procedure

1. Connect the PC where GM Programmer is installed and the GM1 controller.

For details, refer to "7.5 Connecting to the GM1 Controller".

2. From the menu bar, select **Online>System Data History**.

The "System Data History" dialog box will be displayed. You can check errors that have occurred up until now.

Clicking the [Update] button collects system data histories again.

Clicking the [Export] button outputs the system data histories displayed in the dialog box to a ".csv" file.

Clicking the [Clear History] button deletes the system data histories that are displayed.

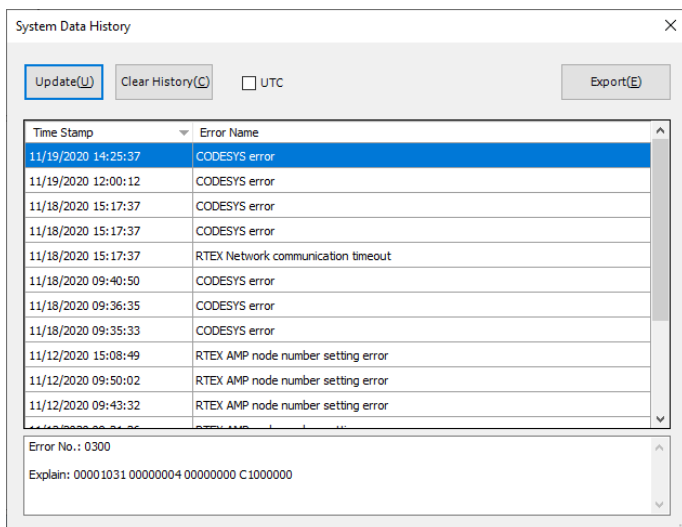

3. Click the "x" button.

The "System Data History" dialog box will be closed.

i Info.

For details, refer to "8.11.2 Checking and Clearing Errors Using GM Programmer".

8.9.4 Task Monitoring

You can check the task status, the number of cycles, cycle time, and jitter while being logged in the GM1 controller.

Double-click the "Task Configuration" object in the navigator pane and select the "Monitor" tab.

8.9.5 Device Trace Function

The Device Trace function of GM Programmer can monitor the CPU load factor of the GM1 controller.

This function allows you to check whether the entire task falls within the appropriate CPU time range.

1 2 Procedure

1. Right-click "Device" and select **Add Object>DeviceTrace...**

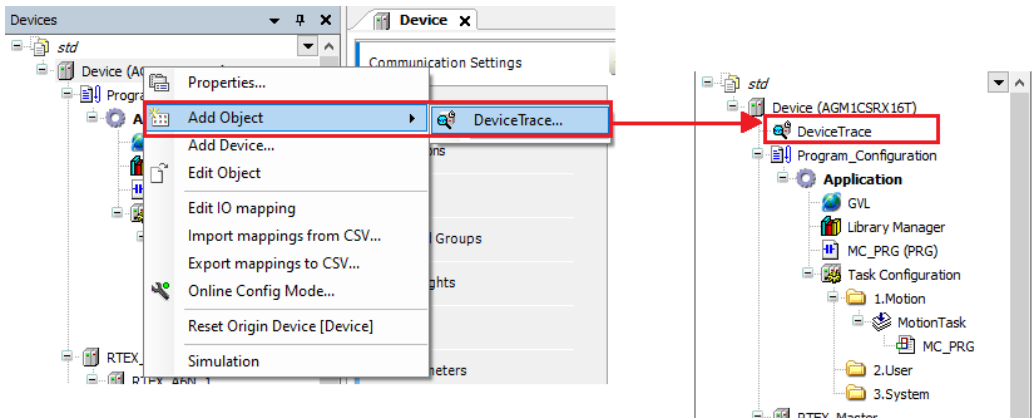

2. You will be logged in to the device.
3. Double-click the "DeviceTrace" object that has been added. The "DeviceTrace" window will be displayed.

8.9 Checking the Status of GM1 Controller

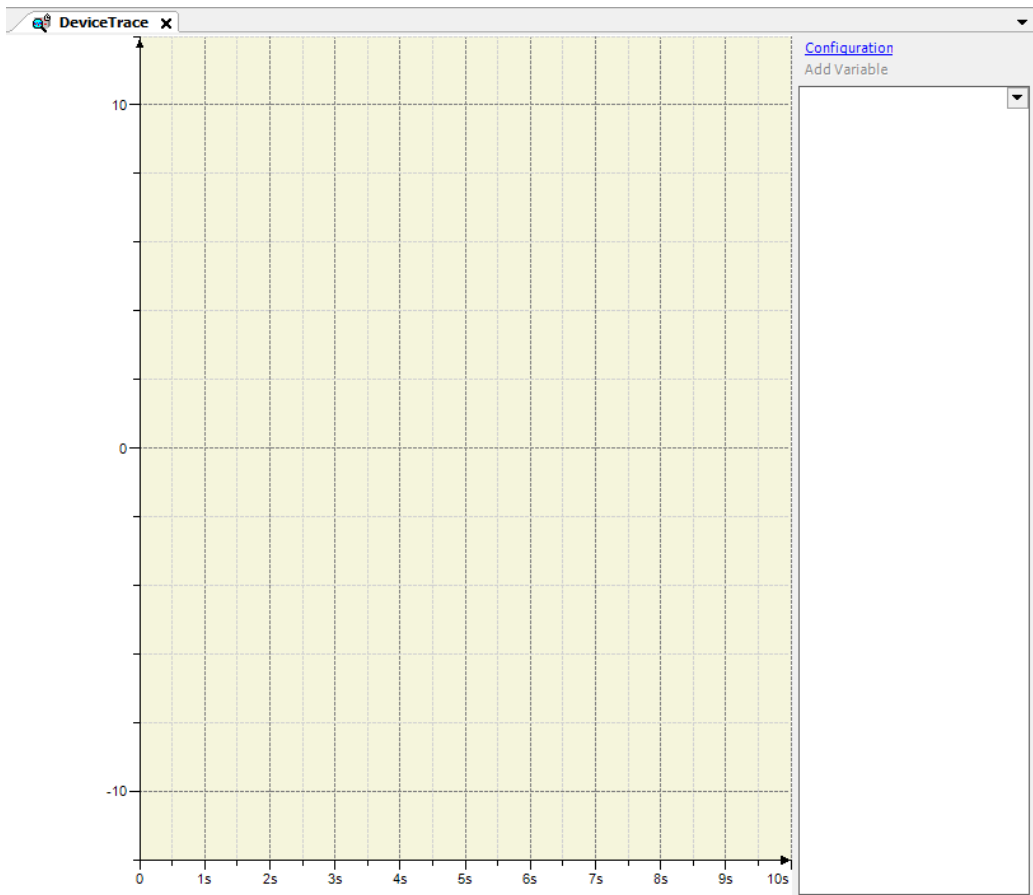

4. From the menu bar, select **Trace>Online List....**

5. The "Online List" window will be displayed. With "CpuLoadRatePacket" selected, click "Upload".

Plotting the CPU load factor will start.

Note: As the Online List window is still open, click the [OK] button to close the window.

8.9 Checking the Status of GM1 Controller

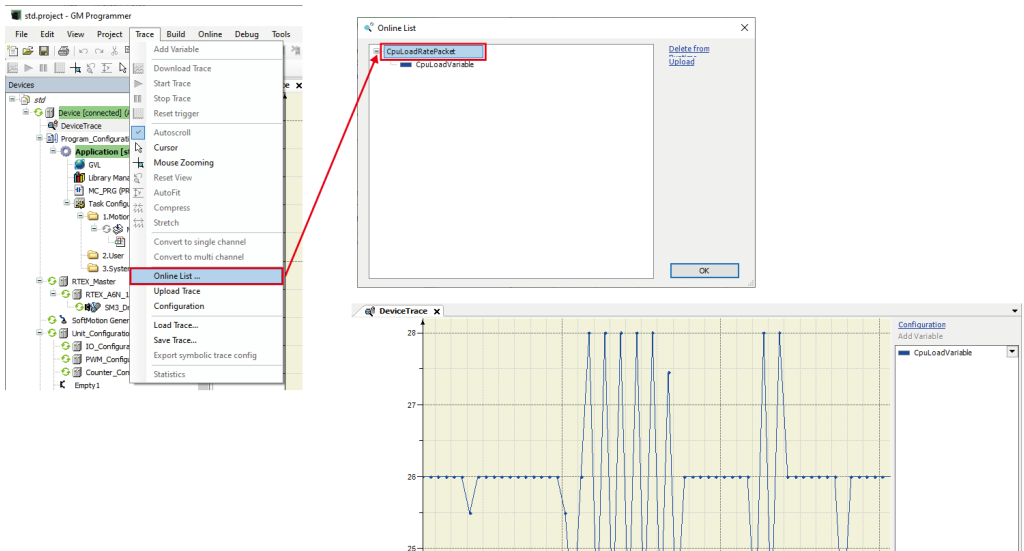

6. To change the graph display settings, click "Configuration" in the top right corner of the "DeviceTrace" window to open the "Trace Configuration" window.

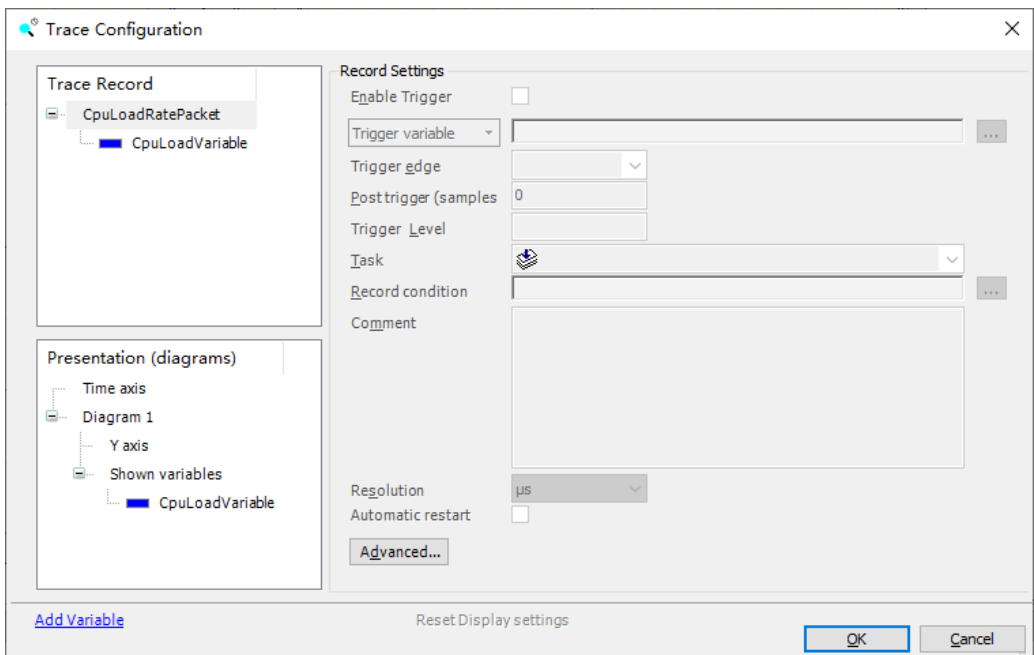

8.9 Checking the Status of GM1 Controller

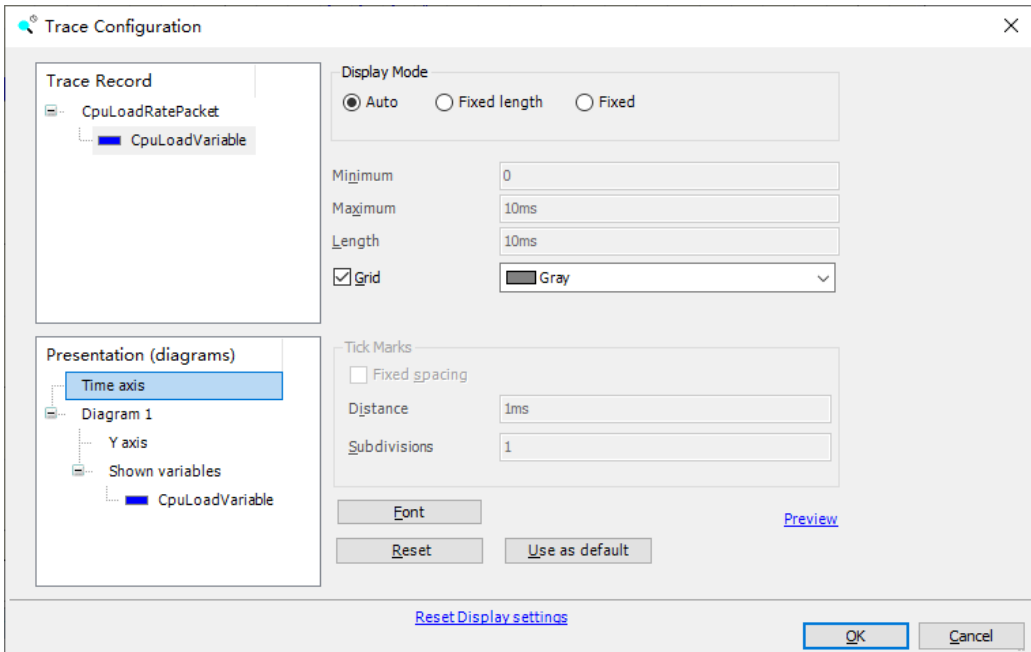
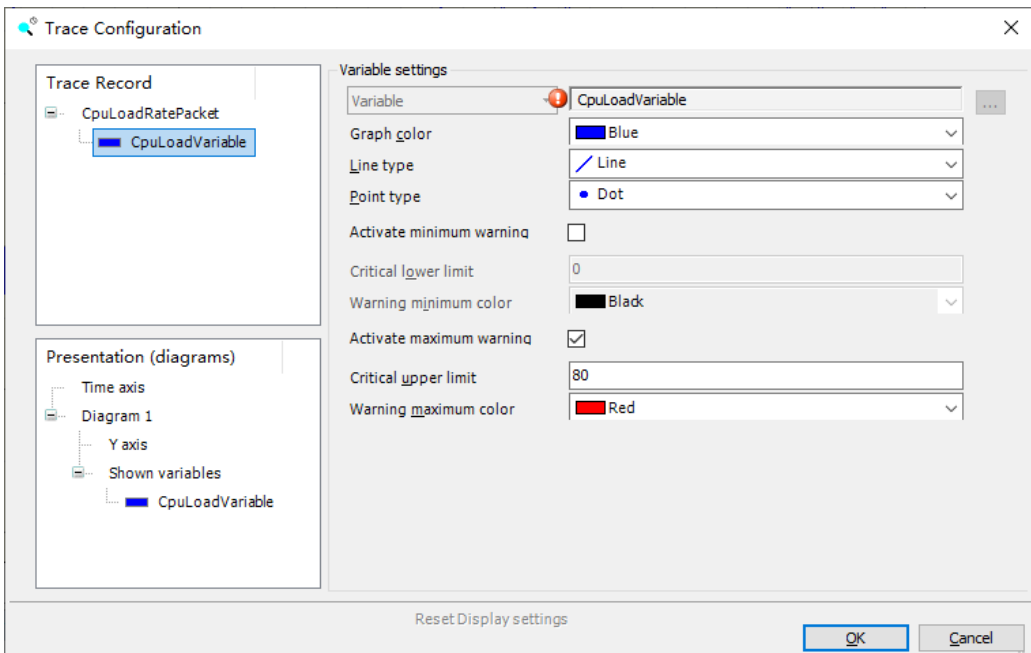

8.9 Checking the Status of GM1 Controller

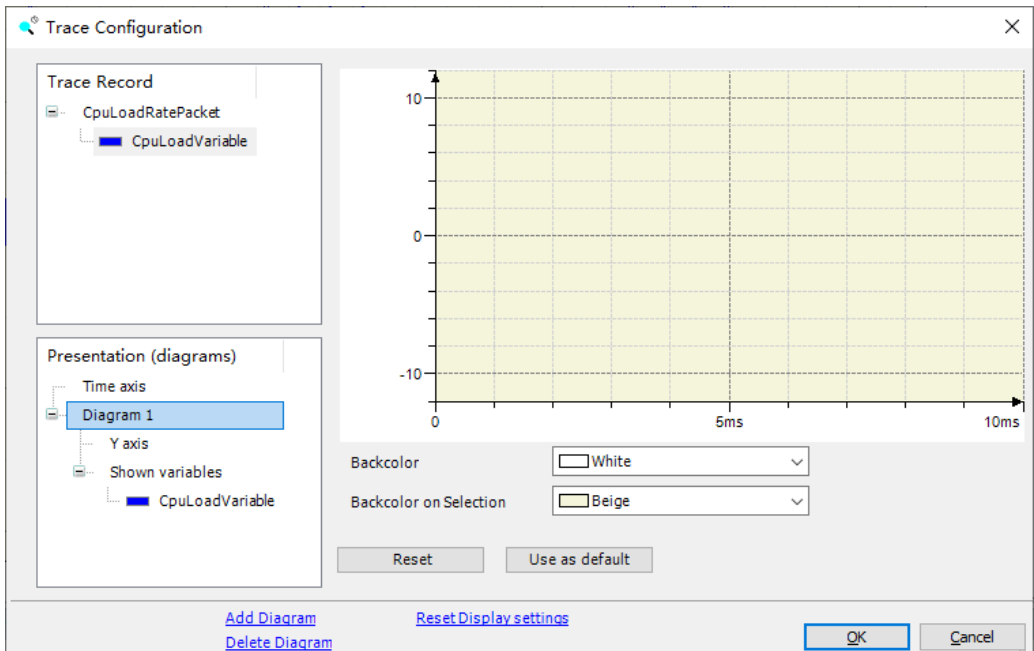
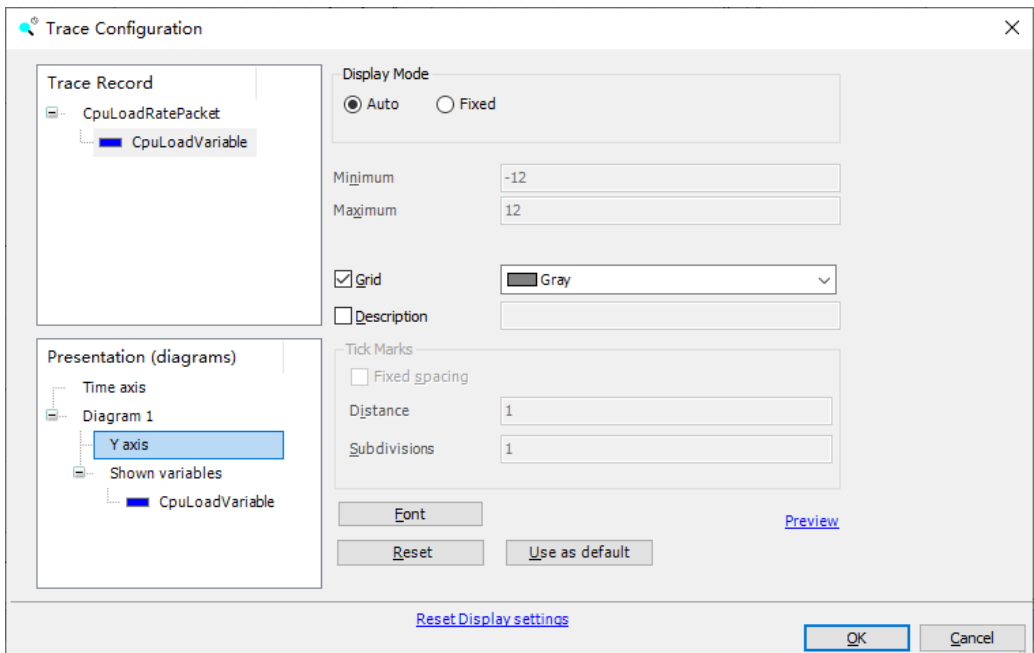

8.9 Checking the Status of GM1 Controller

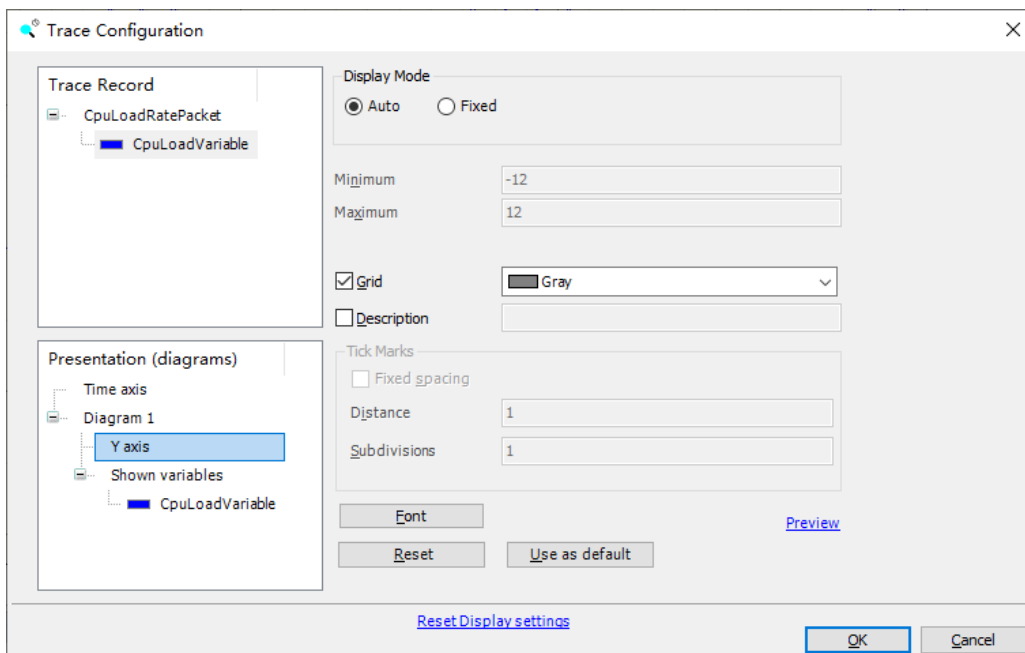

7. The following operations can be performed on the graph.

- Dragging the mouse: To move the time axis
- Dragging the mouse while holding down the Ctrl key: To move the Y-axis
- Scrolling the screen: To lengthen or shorten the time axis
- Scrolling the screen while holding down the Ctrl key: To lengthen or shorten the Y-axis

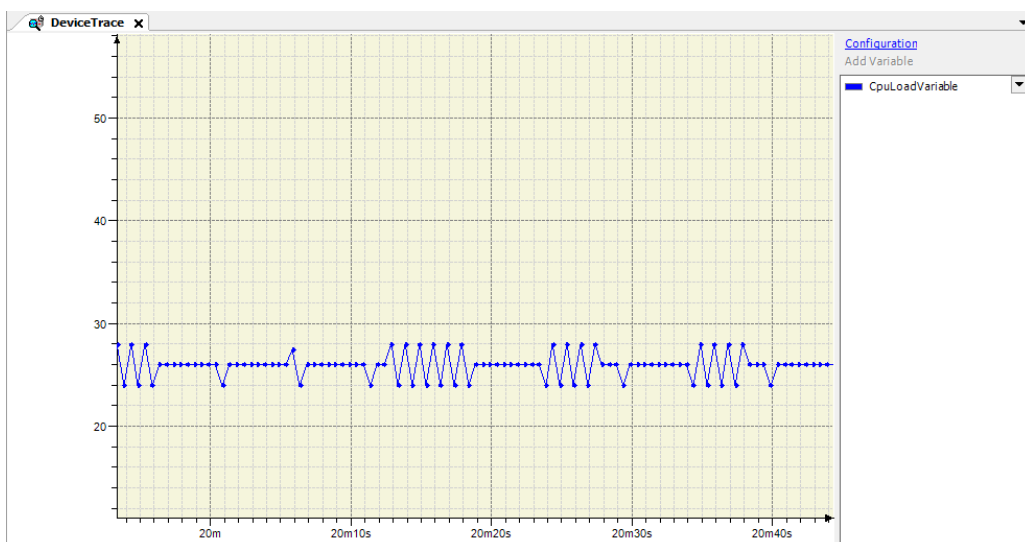

8. The following right-click menu items can be selected.

- Save Trace: Allows you to save the data plotted on the graph as a file
- Load Trace: Allows you to load the trace file saved by selecting "Save Trace" onto the graph screen

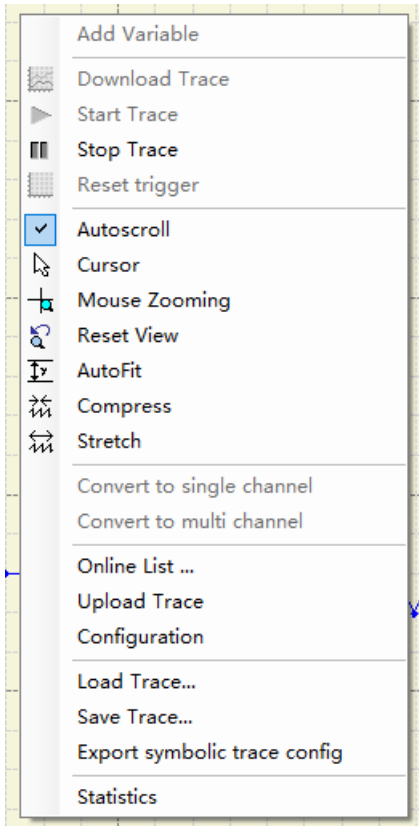

Note

- Use the GM1 controller so that the average CPU load factor is no more than 90%. If 90% is exceeded, stable operation may not be achieved.

8.10 Checking the Performance of GM1 Controller

The GM1-series motion controller is a system in which multiple tasks run.

To ensure that the GM1 controller operates as a system normally, CPU resources must be allocated to each task properly.

- If CPU resources are insufficient:
 - MotionTask and cyclic tasks cannot be operated at the specified intervals. Refer to "8.9.5 Device Trace Function" and keep the CPU load factor at 80% or less as a guideline.
- If the CPU load factor exceeds 80%:
 - Review the program in either one of the following ways.
 - Extend the interval of MotionTask and cyclic tasks.
 - For the program that does not require high speed processing, reassign to the tasks with long intervals.

Also, if the CPU load factor is high, missing RTEXX command may occur. This section explains how to check missing RTEXX command.

8.10.1 Checking Missing RTEXX Command or EtherCAT Packets

The GM1 controller allows POU to be executed by allocating the POU to a task. To execute POU normally, the processing time ("cycle time") of the task must be smaller than the specified interval (*1) of the task.

*1: In the case of "MotionTask"

RTEXX: Equivalent to the control cycle of the "RTEXX_Master"

EtherCAT: Equivalent to the cycle time (control cycle) of "EtherCAT_Master_SoftMotion"

■ Task processing time

Task processing time can be viewed via the navigator pane and **Task Configuration>Monitor**. In the following example, cycle times of "MotionTask" can be viewed.

Task	Status	IEC-Cycle Count	Cycle Count	Last Cycle Time (μs)	Average Cycle Time (μs)	Max. Cycle Time (μs)	Min. Cycle Time (μs)	Jitter (μs)	Min. Jitter (μs)	Max. Jitter (μs)
MotionTask	Valid	0	125624	82	83	358	59	-	-	-

Because cyclic communications are performed over the RTEXX network, if the cycle time exceeds the task interval, the RTEXX command will not be updated in the next cycle, causing the commanded position to remain the same as the previous value. (Missing RTEXX command)

■ Example of missing RTEXX command

In the following example, missing RTEXX command occurs because the cycle time of cycle n+1 exceeds the control cycle.

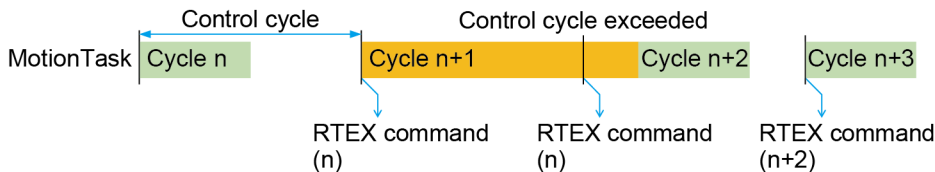

■ Example of missing EtherCAT command

In the following example, missing EtherCAT command occurs because the cycle time of cycle n+1 exceeds the control cycle.

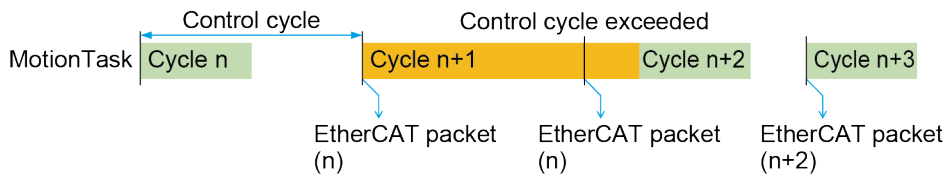

The occurrence of missing RTEX or EtherCAT command can be checked in the following ways.

1. Checking in POU

Function block "RTEX_GetTrackingCommandError" can be used to monitor the occurrence situation of missing RTEX command on the program.

Using the "IoDrVEtherCAT.GetStatistics.udiLostFrameCount" method, the occurrence situation of the missing EtherCAT packet can be checked on the program.

refer to the *GM1 Series Reference Manual (Instruction Edition)*.

2. Checking with GM Programmer settings

Using the task watchdog timer function makes it possible to check whether the cycle time has exceeded the target value. In the example shown in the figure above, if $\text{time}=1\text{ms}$ and $\text{sensitivity}=1$ are set, a watchdog timer error will occur in cycle n+1, causing the program to stop.

8.10 Checking the Performance of GM1 Controller

8.10.2 Performance Check Based on Device Trace

The GM1 controller allows multiple tasks to run. However, use the GM1 controller so that the CPU load factor (processing load of all tasks) is no more than 80%. The CPU load factor can be checked using the "Device Trace" function.

1 2 Procedure

1. Right-click the [Device] object in the navigator pane and then select **Add Object>DeviceTrace** from the context-sensitive object that is displayed.

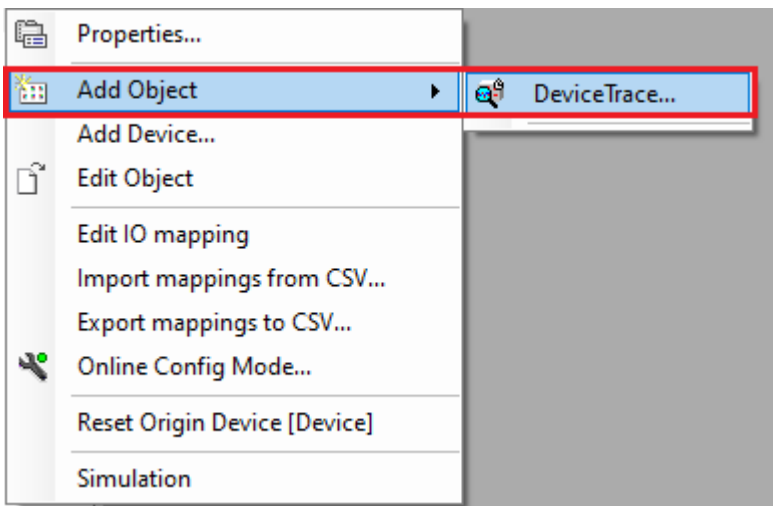

The "Add DeviceTrace" dialog box will be displayed.

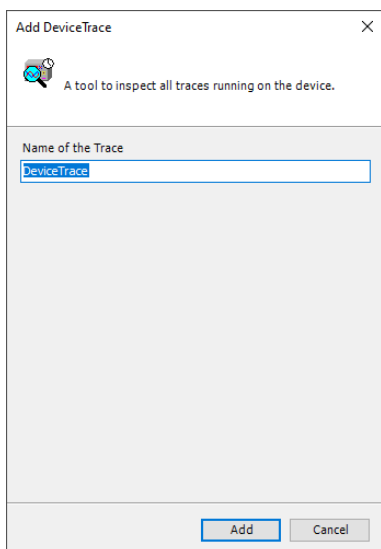

The selected "DeviceTrace" object will be added to the navigator pane.

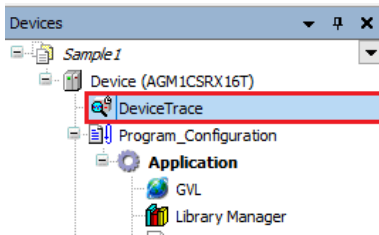

i Info.

- If the CPU load factor constantly exceeds 95%, the GM1 controller will judge the system to be out of control, causing the system to terminate with an error.

8.11 Error Notification Function

8.11.1 Overview of Errors

The GM1 controller has a self-diagnostic function which identifies errors and stops operation if necessary.

Indications concerning self-diagnosis are as follows.

■ **LEDs related to self-diagnostic errors**

●: Lit, ▲: Flashing, ○: Unlit, —: Indefinite (Lit or unlit)

	LED display				Description	Operation status
	RUN	STOP	ERROR	ALARM		
Normal	●	○	○	○	Normal operation	Operating
	○	●	○	○	STOP mode	Stopped
Error	●	○	▲	○	When a self-diagnostic error occurs (Operation continues.)	Operating
	○	●	▲	○	When a self-diagnostic error occurs (Operation stops.)	Stopped
	○	●	-	●	System error	Stopped

■ **PLC parameter setting**

Operation mode at the time of error can be set to continue operation or stop operation in the PLC parameter setting.

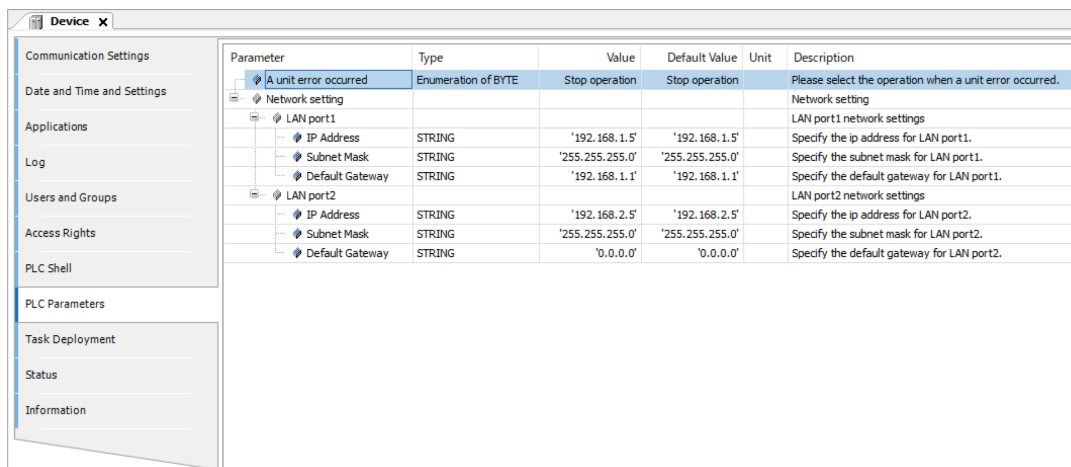

8.11.2 Checking and Clearing Errors Using GM Programmer

Error information can be checked in the status window of GM Programmer.

In case of an operation continue error, the error can be resolved by RTEX Reset / Error Clear.

Info.

- Since the error resolution method varies depending on the error, refer to "[8.11.5 Error Code List](#)".

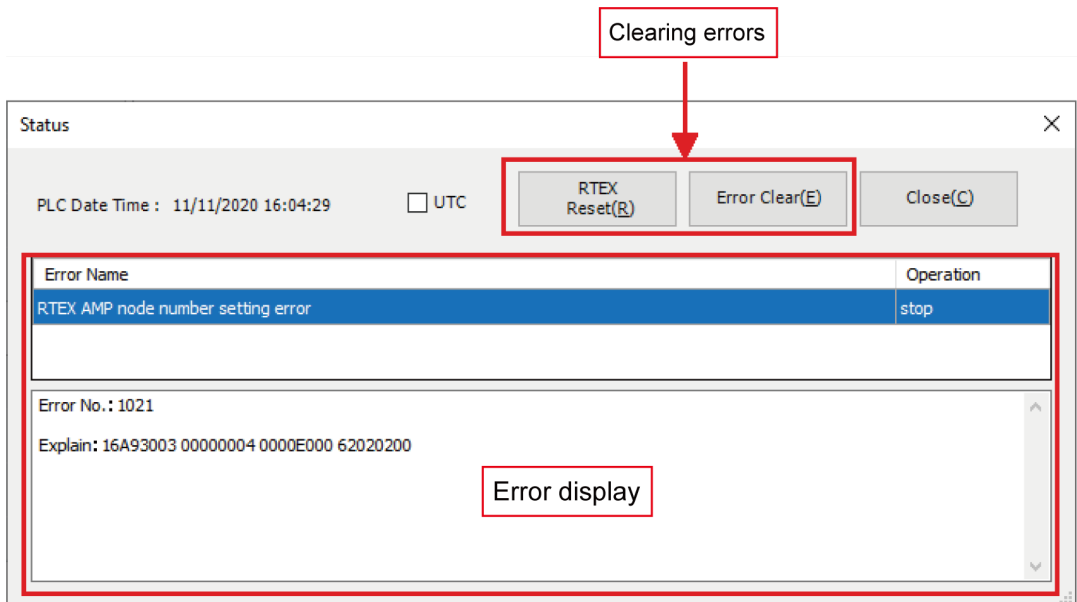

8.11 Error Notification Function

8.11.3 Obtaining Error Information Using User Programs

The following function block can be used to obtain error information for the GM1 controller.

- SYS_SysGetSystemError

This function block is used to obtain error information for the GM1 controller from external devices such as display units.

1 2 Procedure

1. Define the variables to be used in the SYS_SysGetSystemError function block, as global variables.

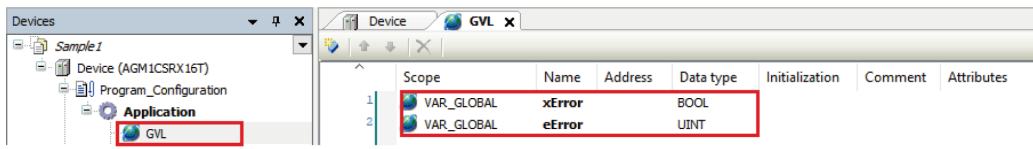

Define global variables that are the same data type as parameters of SYS_SysGetSystemError.

2. Select "Task Configuration" and then the "System Events" tab, and register the function to be executed when a particular event occurs.

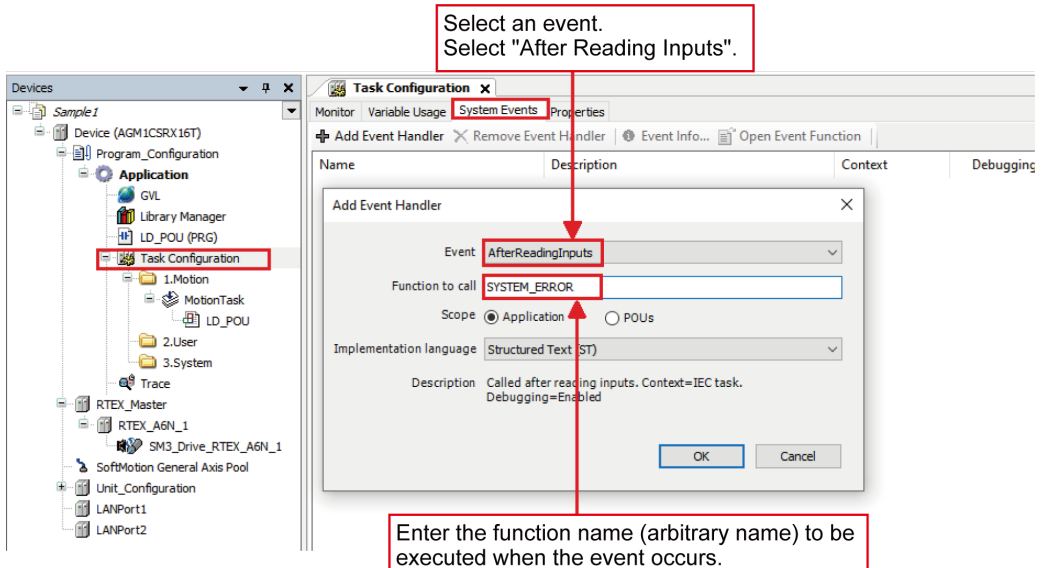

3. In the function that has been added, write a program for SYS_SysGetSystemError.

SYSTEM_ERROR function will be added.

Define an instance of SYS_SysGetSystemError.

Write a program using an instance that has been declared. For parameters, specify global variables that have been defined.

4. Map the defined global variables to the I/O map of the ModbusTCP Slave Device to allow external devices to get error information for the GM1 controller.

Add "ModbusTCP_Slave_Device".

Register the declared global variables on the I/O map.

Variable	Mapping	Channel	Address	Type	Unit	Description
Application.xError	B10	输出[0]	%QW34	ARRAY [0..9] OF WORD		Modbus保持寄存器
	B11	输出[1]	%QW34	ARRAY [0..9] OF WORD		Modbus输入寄存器
	B12	输出[2]	%QW34	ARRAY [0..9] OF WORD		
	B13	输出[3]	%QW34	ARRAY [0..9] OF WORD		
	B14	输出[4]	%QW34	ARRAY [0..9] OF WORD		
	B15	输出[5]	%QW34	ARRAY [0..9] OF WORD		
	B16	输出[6]	%QW34	ARRAY [0..9] OF WORD		
	B17	输出[7]	%QW34	ARRAY [0..9] OF WORD		
	B18	输出[8]	%QW34	ARRAY [0..9] OF WORD		
	B19	输出[9]	%QW34	ARRAY [0..9] OF WORD		
	B20	输出[10]	%QW34	ARRAY [0..9] OF WORD		
	B21	输出[11]	%QW34	ARRAY [0..9] OF WORD		
	B22	输出[12]	%QW34	ARRAY [0..9] OF WORD		
	B23	输出[13]	%QW34	ARRAY [0..9] OF WORD		
	B24	输出[14]	%QW34	ARRAY [0..9] OF WORD		
	B25	输出[15]	%QW34	ARRAY [0..9] OF WORD		
Application.eError		输出[16]	%QW36	WORD		
		输出[17]	%QW36	WORD		
		输出[18]	%QW36	WORD		
		输出[19]	%QW36	WORD		
		输出[20]	%QW36	WORD		
		输出[21]	%QW36	WORD		
		输出[22]	%QW36	WORD		
		输出[23]	%QW36	WORD		
		输出[24]	%QW36	WORD		
		输出[25]	%QW36	WORD		
		输出[26]	%QW36	WORD		
		输出[27]	%QW36	WORD		
		输出[28]	%QW36	WORD		
		输出[29]	%QW36	WORD		
		输出[30]	%QW36	WORD		
		输出[31]	%QW36	WORD		

5. If an error occurs, the error code will be set in the variable, so that external devices can get error information for the GM1 controller.

8.11 Error Notification Function

If errors occur, error codes will be updated. Error codes can be obtained from external devices such as display units.

General	Find	Filter	Show all	+ Add FB for IO Channel...		
Modbus TCP Slave Device I/O Mapping	Variable	Mapping	Channel	Address	Type	Current Value
			Inputs	%IW40	ARRAY [0..9] OF WORD	
			Outputs	%QW34	ARRAY [0..9] OF WORD	
			Outputs[0]	%QW34	WORD	
	Application.xError		Bit0	%QX68.0	BOOL	TRUE
			Bit1	%QX68.1	BOOL	FALSE
			Bit2	%QX68.2	BOOL	FALSE
			Bit3	%QX68.3	BOOL	FALSE
			Bit4	%QX68.4	BOOL	FALSE
			Bit5	%QX68.5	BOOL	FALSE
			Bit6	%QX68.6	BOOL	FALSE
			Bit7	%QX68.7	BOOL	FALSE
			Bit8	%QX69.0	BOOL	FALSE
			Bit9	%QX69.1	BOOL	FALSE
			Bit10	%QX69.2	BOOL	FALSE
			Bit11	%QX69.3	BOOL	FALSE
			Bit12	%QX69.4	BOOL	FALSE
			Bit13	%QX69.5	BOOL	FALSE
			Bit14	%QX69.6	BOOL	FALSE
			Bit15	%QX69.7	BOOL	FALSE
	Application.eError		Outputs[1]	%QW35	WORD	16#0300

8.11.4 Error Recovery Processing

Info.

- For errors during simulation, check the log window or each function block. When an error occurs, normally, stop the operation.

■ When **ERROR_LED** flashes

A self-diagnostic error has occurred.

■ Solution

Check the condition according to the following procedure.

1. On the GM Programmer, select **Online>Status** and check the error content (error code).
2. Switch the mode to the PROG mode.
3. Cancel the situation in accordance with the error code.

■ When **ALARM_LED** lights up

Timeout of the system watchdog timer has been detected.

■ Solution

Check the condition according to the following procedure.

1. Turn the controller OFF and then ON.
If the problem persists, consult your Panasonic representative.

■ Sample code

For a program that is used for error recovery processing, refer to the following.

8.11 Error Notification Function

<Sample program>

```
1 PROGRAM RTEX_ERROR_CLR
2 VAR
3 // SYS_GetSystemError instance
4 SYS_GetSystemError_0: SYS_GetSystemError;
5 bSYS_Error:BOOL;
6 uiSYS_ErrorID:UINT;
7 iSequence: UDINT;
8
9 // SYS_ClearSystemError instance
10 SYS_ClearSystemError_0: SYS_ClearSystemError;
11
12 // MC_Reset instance
13 MC_Reset_0:MC_Reset;
14
15 // RTEX_Reset instance
16 RTEX_Reset_0: RTEX_Reset;
17
18 // SMC_ReadFBError instance
19 SMC_ReadFBError_0:SMC_ReadFBError;
20
21 // SMC_CheckAxisCommunication instance
22 SMC_CheckAxisCommunication_0:SMC_CheckAxisCommunication;
23 END_VAR
24
25 SYS_GetSystemError_0(
26     Error=>bSYS_Error,
27     ErrorID=>uiSYS_ErrorID);
28
29 IF bSYS_Error = TRUE THEN // Select Reset target from Error ID
30     IF (uiSYS_ErrorID = 16#0106) OR (uiSYS_ErrorID = 16#0200) OR ((uiSYS_ErrorID >= 16#0221) AND (uiSYS_ErrorID <= 16#022F)) OR (uiSYS_ErrorID
31         iSequence := 1;
32     END_IF
33 END_IF
34
35 IF uiSYS_ErrorID <> 0 THEN
36     CASE iSequence OF
37     1: // GML SystemError Clear
38         SYS_ClearSystemError_0(
39             xExecute := TRUE);
40         IF SYS_ClearSystemError_0.xDone = TRUE THEN
41             iSequence := 2;
42         END_IF
43     2: // Call MC_Reset only on the error axis
44         IF Axis1.nAxisState = errorstop THEN
45             MC_Reset_0(
46                 Axis:=Axis1,
47                 Execute:=TRUE);
48         END_IF
49         IF (Axis1.nAxisState <> errorstop) THEN
50             iSequence := 3;
51         END_IF
52     3: // Call RTEX_Reset
53         // Note: Do not call RTEX_Reset in succession
54         // It takes time to complete the reset (RTEX_Reset.Done = TRUE)
55         RTEX_Reset_0(
56             Execute := TRUE);
57         iSequence := 4;
58     4: // Wait for RTEX_Reset to complete
59         IF RTEX_Reset_0.Done = TRUE THEN
60             // FB initialization
61             SYS_ClearSystemError_0(
62                 xExecute:=FALSE);
63             RTEX_Reset_0(
64                 Execute:=FALSE);
65             MC_Reset_0(
66                 Axis:=Axis1,
67                 Execute:=FALSE);
68             iSequence := 5;
69         END_IF
70     5: // FB error check and clear for each axis
71         SMC_ReadFBError_0(
72             Axis := Axis1,
73             bEnable := TRUE);
74         IF SMC_ReadFBError_0.bFBError = TRUE THEN
75             SMC_ClearFBError(
76                 pDrive:=ADR(Axis1));
77         END_IF
78
79         // Check the communication status of the axis
80         SMC_CheckAxisCommunication_0(
81             Axis:=Axis1,
82             bEnable:=TRUE);
83
84         IF SMC_CheckAxisCommunication_0.bOperational = TRUE THEN
85             iSequence := 6;
86         END_IF
87     6: //End
88     ;
89 END_CASE
90 END_IF
```

8.11.5 Error Code List

Error No.	Operation	Name	Error description and action method	Recovery method
0x0001	Stop	System error (serious)	Notify us of the error information or system data history information displayed on the status window of GM Programmer.	Power cycle
0x0002	Stop	System error (CODESYS)	Notify us of the error information or system data history information displayed on the status window of GM Programmer.	Power cycle
0x0003	Continue	System error (minor)	Notify us of the error information or system data history information displayed on the status window of GM Programmer.	Power cycle
0x0106	Continue	Device date and time, RTC error	Because the duration of the power failure exceeded the guaranteed period (14 days), the RTC time information was initialized. The device must be left ON for at least 10 minutes. (Time information is reset to April 1, 2019.)	Clear the error
0x0110 to 0x113	Continue	PWM Frequency setting error	The cycle setting is out of range. Check whether the duty ratio is within the allowable range.	Re-download
0x0120 to 0x123	Continue	PWM Duty ratio setting error	The duty ratio setting is out of range. Check whether the duty ratio is within the allowable range.	Re-download
0x0130 to 0x131	Stop	Counter Overflow error	The counter value exceeds the upper limit. Perform reset or preset operation so that the counter value falls within the range between the upper and lower limits.	Re-download
0x0140 to 0x141	Stop	Counter Underflow error	The counter value drops below the lower limit. Perform reset or preset operation so that the counter value falls within the range between the upper and lower limits.	Re-download
0x0150 to 0x151	Continue	Counter Reset abnormal error	The count value becomes 0 under the reset conditions and goes out of the range between the upper and lower limits. Check the settings of the upper and lower limits of the counter. If 0 does not exist in the range between the upper and lower limits, make a preset request.	Re-download
0x0160 to 0x161	Continue	Counter Preset abnormal error	The count value goes out of the range between the upper and lower limits under the preset conditions. Check whether the preset value falls within the range between the upper and lower limits.	Re-download
0x0170 to 0x171	Continue	Counter Current value change abnormal error	The count value goes out of the range between the upper and lower limits when the current value is changed. After the current value is changed, check whether the new value falls within the range between the upper and lower limits.	Re-download
0x0200	Continue	Expansion unit Communication error	An expansion unit communication error has occurred. Check connections.	Clear the error
0x0201	Stop	Expansion unit	More than 15 expansion units are connected. Check connections.	Power cycle

8.11 Error Notification Function

Error No.	Operation	Name	Error description and action method	Recovery method
		Number of connections exceeded		
0x0203	Stop	Expansion unit Startup error	An attempt to upgrade the expansion unit could have failed. Upgrade again.	Re-download
0x0205	Stop	Expansion unit Startup wait timeout error	Waiting for expansion unit startup has timed out. Check connections.	Re-download
0x020C	Stop	Expansion unit Connection number mismatch	The number of expansion units in the project does not match the number of expansion units mounted. Check connections.	Re-download
0x020D	Stop	Expansion unit Model code mismatch	The expansion unit model in the project does not match the expansion unit model mounted. Check connections.	Re-download
0x020E	Stop	Expansion unit Version mismatch	The version of the expansion unit registered in the project does not match the version of the expansion unit mounted.	Re-download
0x020F	Stop	Expansion unit Unit initialization error	Expansion unit initialization has failed. Check connections.	Re-download
0x0221 to 0x022F	Continue	Expansion unit I/O data error	An I/O data error has occurred in the expansion unit. Check the installation environment.	Clear the error
0x0300	Continue	CODESYS error	A CODESYS error has occurred. Check the error details in the log window of GM Programmer.	Clear the error
0x1000 to 0x100F ^(Note 1)	Continue	RTEX Amplifier alarm	An alarm has occurred in the servo amplifier. Use PANATERM Lite to check the alarm number.	Reset the amplifier
0x1010 to 0x101F ^(Note 1)	Continue	RTEX Amplifier warning	A warning has occurred in the servo amplifier. Use PANATERM Lite to check the warning number.	Reset the amplifier
0x1020	Stop	RTEX AMP node duplication error	There are duplicate MAC IDs among servo amplifiers. Check the MAC ID settings of servo amplifiers.	Power cycle
0x1021	Stop	RTEX AMP node number setting error	The number of axes in the project does not match the number of axes for the servo amplifiers. Check the number of axes in RTEX_Master.	Re-download
0x1022	Stop	RTEX AMP node number setting error	The MAC ID in the project does not match the MAC ID of the servo amplifier. Check the settings.	Re-download

8.11 Error Notification Function

Error No.	Operation	Name	Error description and action method	Recovery method
0x1023	Stop	RTEX Over the number of amplifier connections	The number of servo amplifiers that are connected is more than the maximum allowed number. Check connections.	Power cycle
0x1024 ^(N) <small>ote 1)</small>	Stop	RTEX Amplifier parameter error RTEX function enhancement setting 1	There is an error with the settings of the servo amplifier parameter (RTEX function enhancement setting 1 "Pr7.22"). Review the settings.	Power cycle
0x1025	Stop	RTEX Amplifier connection error	The connected servo amplifiers are not supported by the GM1 controller.	Power cycle
0x1026	Stop	RTEX Communication / Control Cycle setting error	RTEX_Master Communication / Control Cycle settings do not match the settings for the servo amplifiers. Review the settings.	Re-download
0x1030 ^(N) <small>ote 1)</small>	Stop	RTEX Amplifier parameter error RTEX function enhancement setting 1	There is an error with the settings of the servo amplifier parameter (RTEX function enhancement setting 1 "Pr7.22"). Review the settings.	Power cycle
0x1040 to 0x104F ^(N) <small>ote 1)</small>	Stop	RTEX Amplifier parameter error RTEX speed unit setting	There is an error with the settings of the servo amplifier parameter (RTEX speed unit setting "Pr7.25"). Review the settings.	Reset the amplifier
0x1050 to 0x105F ^(N) <small>ote 1)</small>	Stop	RTEX Amplifier parameter error Absolute encoder setting	There is an error with the settings of the servo amplifier parameter (absolute encoder setting "Pr0.15"). Review the settings.	Reset the amplifier
0x1060 to 0x106F	Stop	RTEX Amplifier parameter error RTEX function enhancement setting 2	There is an error with the settings of the servo amplifier parameter (RTEX function enhancement setting 2 "Pr7.23"). Review the settings.	Reset the amplifier
0x1070	Stop	RTEX	An attempt to clear a servo amplifier alarm has failed.	Reset the amplifier

8.11 Error Notification Function

Error No.	Operation	Name	Error description and action method	Recovery method
		Amplifier alarm clearing timeout		
0x1071	Stop	RTEX Amplifier communication error	An RTEX communication error has occurred. Check the network connection / installation environment.	Reset the amplifier
0x1072	Stop	RTEX Network communication timeout	RTEX communication has timed out. Check network connections.	Reset the amplifier
0x1077	Continue	RTEX Reset error	An attempt to reset RTEX has failed. Check network connections.	Reset the amplifier
0x1200 to 0x121F	Continue	RTEX Amplifier alarm	An alarm has occurred in the servo amplifier. Use PANATERM Lite to check the alarm number.	Reset the amplifier
0x1240 to 0x125F	Continue	RTEX Amplifier warning	A warning has occurred in the servo amplifier. Use PANATERM Lite to check the warning number.	Reset the amplifier
0x1280 to 0x129F	Stop	RTEX Amplifier parameter error RTEX function enhancement setting 1	There is an error with the settings of the servo amplifier parameter (RTEX function enhancement setting 1 "Pr7.22"). Review the settings.	Clear the error
0x12C0 to 0x12DF	Stop	RTEX Amplifier parameter error RTEX function enhancement setting 1	There is an error with the settings of the servo amplifier parameter (RTEX function enhancement setting 1 "Pr7.22"). Review the settings.	Power cycle
0x1300 to 0x131F	Stop	RTEX Amplifier parameter error RTEX speed unit setting	There is an error with the settings of the servo amplifier parameter (RTEX speed unit setting "Pr7.25"). Review the settings.	Reset the amplifier
0x1340 to 0x135F	Stop	RTEX Amplifier parameter error Absolute encoder setting	There is an error with the settings of the servo amplifier parameter (absolute encoder setting "Pr0.15"). Review the settings.	Reset the amplifier

(Note 1) For project version V1.3.3.0 or earlier, these error codes are reported.

9 Motion Control

9.1 Basic Setting	9-2
9.1.1 Setting the Master axis	9-2
9.1.2 Basic Settings of the Axis	9-2
9.1.3 Axis Extended Setting	9-7
9.1.4 Adding and Setting up Free Encoder and Virtual Drive	9-15
9.2 Initial Setup for Servo Amplifiers	9-19
9.2.1 RTEX parameter settings for servo amplifier	9-21
9.2.2 EtherCAT parameter settings for servo amplifier	9-22
9.3 Preparation for Operation	9-23
9.3.1 Checking Wiring	9-23
9.3.2 Checking Safety Circuit Design	9-24
9.3.3 Operation Mode Switching	9-28
9.3.4 Operation Check	9-29
9.4 Operation up to running	9-32
9.4.1 Servo ON or OFF	9-32
9.4.2 Commissioning	9-33
9.5 Single-axis Operation	9-35
9.5.1 Overview of Single-axis Operation	9-35
9.5.2 Switching the Control Mode	9-35
9.6 Synchronous Control	9-37
9.6.1 Overview of Synchronous Control	9-37
9.7 Cam synchronous Control	9-38
9.7.1 Overview of Cam Control and How to Use It	9-38
9.7.2 Creating Cam Data	9-41
9.7.3 Types and Setting of Cam Curves	9-61
9.7.4 Cam Control (POU Programming)	9-74
9.8 CNC Control	9-75
9.8.1 Overview of CNC Control and How to Use It	9-75
9.8.2 Creating a CNC Program	9-77
9.8.3 Import DXF File Function	9-85
9.8.4 Dynamical Analysis for CNC Program	9-89
9.9 Motion Function Errors	9-91
9.9.1 Overview of Motion Function Errors	9-91
9.9.2 Error Check Method	9-92
9.9.3 Clearing Errors	9-93

9.1 Basic Setting

9.1 Basic Setting

9.1.1 Setting the Master axis

Refer to the following for how to set the master axis.

RTEX: "11.1.1 Setting up the RTEX master"

EtherCAT: "10.1.1 Setting up the EtherCAT master"

9.1.2 Basic Settings of the Axis

To use the motion function, configure the RTEX and EtherCAT axes.

See below for how to add an axis.

RTEX: "11.1.2 Adding and Setting up Servo Amplifiers"

EtherCAT: "10.1.3 Adding and Setting up Servo Amplifiers"



- Be sure to set the axis

12

Procedure

1. Double-click the servo amplifier object in the navigator pane.
 - RTEX

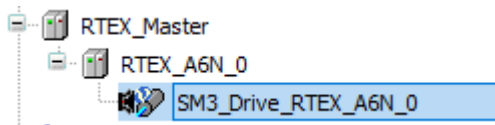

- EtherCAT

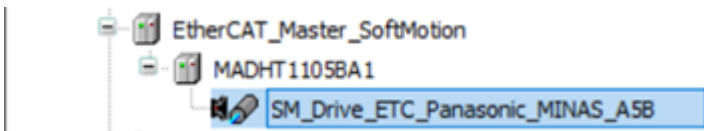

2. From the displayed menu, select "Edit Object".
The settings window will be displayed in the main window.
 - RTEX

General

Scaling/Mapping

Commissioning

Home Return Settings

SM3_Drive_RTEX_Panasonic: IEC Objects

Status

Information

Axis type and limits

Virtual mode
 Modulo
 Finite

Software limits

 Activated

Negative [u]:

Positive [u]:

Software error reaction

Deceleration [μs^2]:

Max. distance [u]:

Dynamic limits

Velocity [u/s]:	Acceleration [μs^2]:	Deceleration [μs^2]:	Jerk [μs^3]:
<input type="text" value="10"/>	<input type="text" value="100"/>	<input type="text" value="8388608"/>	<input type="text" value="10000"/>

Velocity ramp type

 Trapezoid
 Sin²
 Quadratic
 Quadratic (smooth)

Identification

ID:

Position lag supervision

▼

Lag limit [u]:

• EtherCAT

SM_Drive_ETC_Panasonic_MINAS_A5B x

General

Scaling/Mapping

Commissioning

SM_Drive_ETC_Panasonic_MINAS_A5B: I/O Mapping

SM_Drive_ETC_Panasonic_MINAS_A5B: IEC Objects

Status

Information

Axis type and limits

Virtual mode
 Modulo
 Finite

Software limits

 Activated

Negative [u]:

Positive [u]:

Software error reaction

Deceleration [μs^2]:

Max. distance [u]:

Dynamic limits

Velocity [u/s]:	Acceleration [μs^2]:	Deceleration [μs^2]:	Jerk [μs^3]:
<input type="text" value="5"/>	<input type="text" value="100"/>	<input type="text" value="100"/>	<input type="text" value="10000"/>

Velocity ramp type

 Trapezoid
 Sin²
 Quadratic
 Quadratic (smooth)

Identification

ID:

Position lag supervision

▼

Lag limit [u]:

General Settings

Select the "General" tab and set the following items.

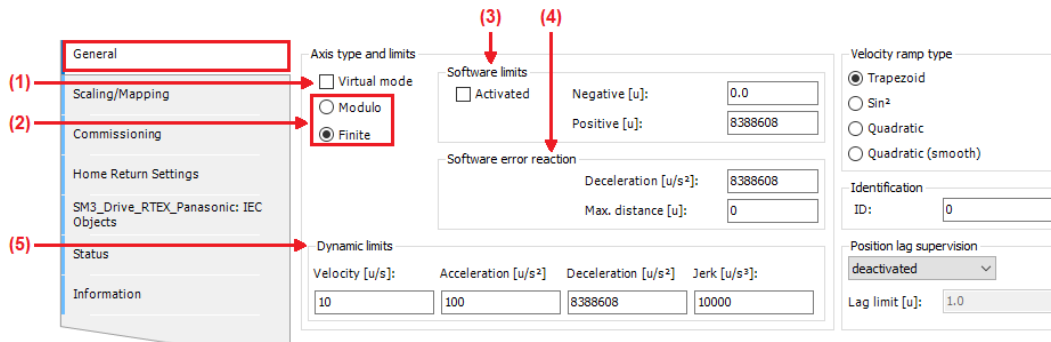

(1) Virtual mode

You can set the real axis or virtual axis.

Use of the real axis: The real axis is used to actually control the servo amplifier.

Use of the virtual axis: A virtual servo amplifier is created in the GM1 Controller and its virtual axis is used.

(2) Modulo / Finite

The axis type can be specified.

- Modulo

Modulo: The motor rotates infinitely (belt drive, etc.) without limiting the travel range.

- The command position value keeps looping between 0 and modulo value.
- The maximum settable modulo value is "255×units in application" (*1).
- *1: Set the units in application in the Scaling / Mapping.
- A negative value cannot be set. (A warning is issued. If the data is downloaded as is, an error will occur when executing the GM1.

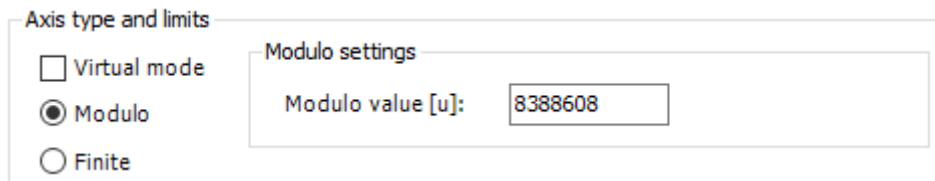

- Finite

The set value for the command position is a finite value.

Software limit can be set. Note that an error will occur if a 32-bit real number is exceeded.

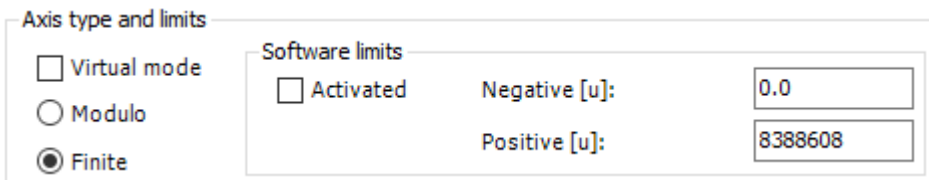

(3) Software limit

A software limit can be set if the axis type is set to "Finite".

If the command position is outside the software limit setting range, an error stop occurs and operation stops.

When operation is stopped by exceeding the software limit, the shortest time from the start of deceleration to the stop among the following settings is applied: the value set for the deceleration in response to the software error, for the maximum distance in response to the software error, or for the dynamic limit.

Axis type and limits			
<input type="checkbox"/> Virtual mode	Software limits		
<input type="radio"/> Modulo	<input type="checkbox"/> Activated	Negative [u]:	0.0
<input checked="" type="radio"/> Finite		Positive [u]:	8388608

(4) Software error reaction

Settings can be made to stop operation when an error occurs.

Software error reaction	
Deceleration [u/s^2]:	8388608
Max. distance [u]:	0

i Info.

- When operation is switched from Run to Stop, an emergency stop is made regardless of the software error reaction.
- For the stop operation that takes place when an error stop occurs or when the software limit is exceeded, the shortest time from the start of deceleration to the stop among the following settings is applied.
 - Deceleration in software error reaction
 - Maximum distance in software error reaction
 - Dynamic limit
- If the deceleration and maximum distance in software error reaction are set to 0, these become invalid. In that case, operation stops according to the deceleration rate set in the dynamic limit.

(5) Dynamic limit

Speed, acceleration, and deceleration settings cannot be set to 0. If they are set to 0, a warning is issued.

Dynamic limits			
Velocity [u/s]:	Acceleration [u/s^2]	Deceleration [u/s^2]	Jerk [u/s^3]:
10	100	8388608	10000

The values set in the dynamic limit can be checked if they are exceeded during axis operations using the "SMC_CheckLimits" function block. Note that an excess of the jerk cannot be detected using the "SMC_CheckLimits" function block. Therefore, do not use the jerk column.

Scaling / Mapping Settings

Select the "Scaling/Mapping" tab and set the following items.

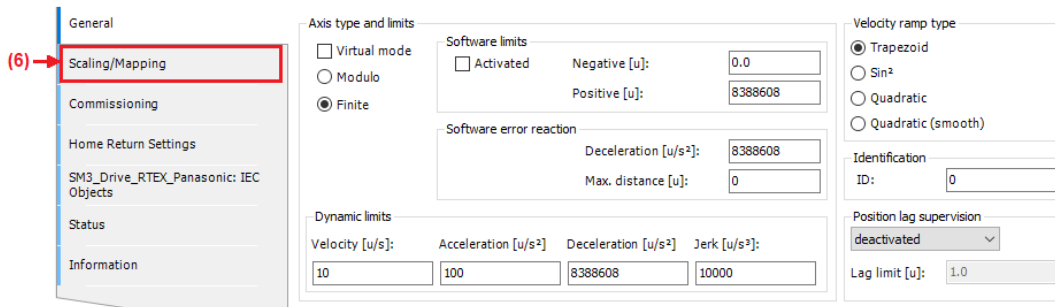

(6) Scaling/Mapping

- Rotary type

When the axis type is set to modulo, the ratio in the conversion from the drive increment to the application unit is set.

The unit on the servo amplifier and the unit on the application (POU) are converted.

Example:

One rotation of the MINAS A6N is 0x800000. To treat one rotation as 360 on the application, set this to 360.

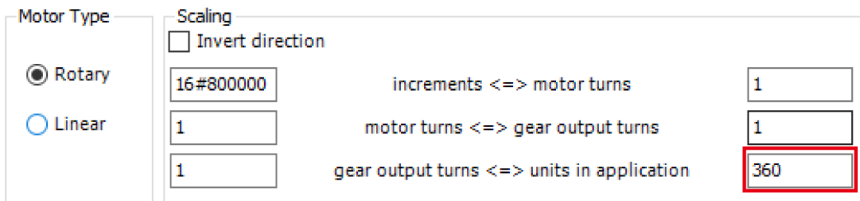

Note: Invert direction: The direction is inverted.

- Linear type

When the axis type is set to finite, the ratio in the conversion from the drive increment to the application unit is set.

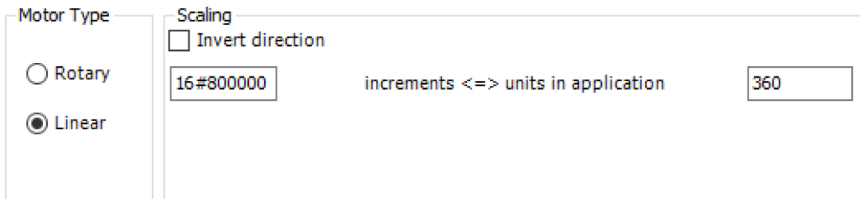

Note: Invert direction: The direction is inverted.

9.1.3 Axis Extended Setting

Configure Axis extended settings as required.

Right-click the object in the navigator pane and then select "Edit Object" from the context-sensitive menu that is displayed. The "RTEX or EtherCAT Axis Setting" dialog box will be displayed.

Select the "General" tab and set the following items.

■ (1) Position lag supervision

Axis operations automatically stop when the difference (absolute value) between the command position of the axis and the actual position has exceeded the value set in Lag limit. The following stop methods are available.

You can enter a positive real number greater than or equal to 0 in Lag limit. Negative values cannot be entered.

The axis state is Errorstop after the operation stops with an error. Execute MC_Reset to recover from the error.

Stop methods	Details
deactivated	The position lag supervision function is disabled. (Default)
disable drive	Power is turned Off. In the program, the bRegulatorOn parameter of the axis structure (AXIS_REF_SM3) is forcibly switched to OFF.
do quickstop	The axis operation comes to a quick stop. Do not use.
stay enabled	The axis is brought to a stop according to the settings in Software error reaction. The axis remains powered On.

9.1 Basic Setting

■ (2) Velocity ramp type

Velocity profiles are defined for each axis.

■ Trapezoid

In the trapezoidal velocity profile, velocity continues linearly.

The refore, acceleration can rise sharply.

In this mode, jerk restriction does not work in each function block.

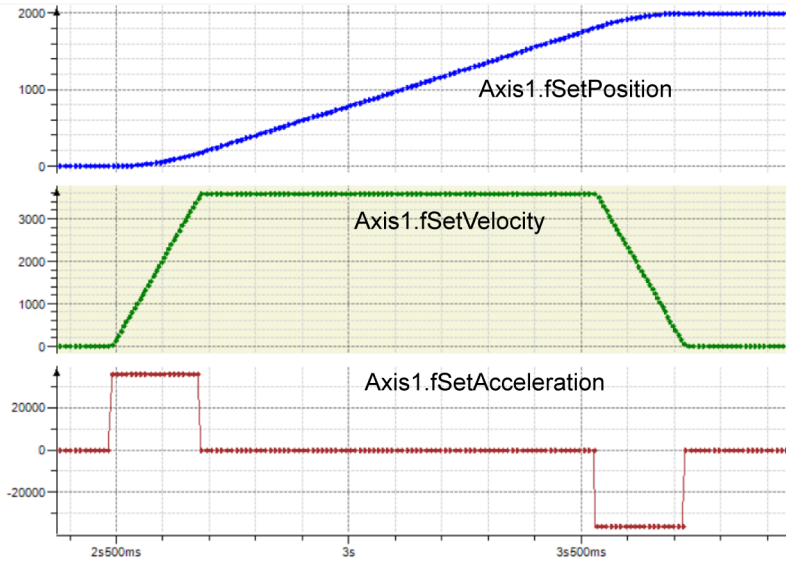

■ \sin^2

In the velocity profile defined with the \sin^2 function, transition motion within each section of the velocity profile is smooth and acceleration does not rise discontinuously.

In this mode, jerk restriction does not work in each function block.

However, if you are using GM Programmer version 1.4.1.0 or earlier, jerk restriction works only when the acceleration is not zero at the start of function block execution.

i Info.

- If you are using GM Programmer version 1.4.2.0 or later, jerk restriction is enabled when the acceleration is not zero at the start of function block execution only with the following setting. Right-click the "Application" object in the navigator pane and then select "Properties" from the context-sensitive menu that is displayed.

In the Properties window, click the "Build" tab and add "SM3_BASIC_SINSQUARE_ACC_RAMP" to the "Compiler constant definitions".

- To use the GM Programmer version with jerk restriction enabled, set an appropriate jerk value for the function block.

A \sin^2 curve has a characteristic that the acceleration before and after the velocity profile is zero.

If motion in a \sin^2 curve is interrupted and the current acceleration is not equal to zero, the acceleration value is gradually reduced to zero in order to start from zero acceleration.

Within this section, jerk restriction works due to the jerk input of the function block.

If the jerk value is too low at this time, this interval will become longer. This is dangerous because it may cause continuous motion in the opposite direction to the target value.

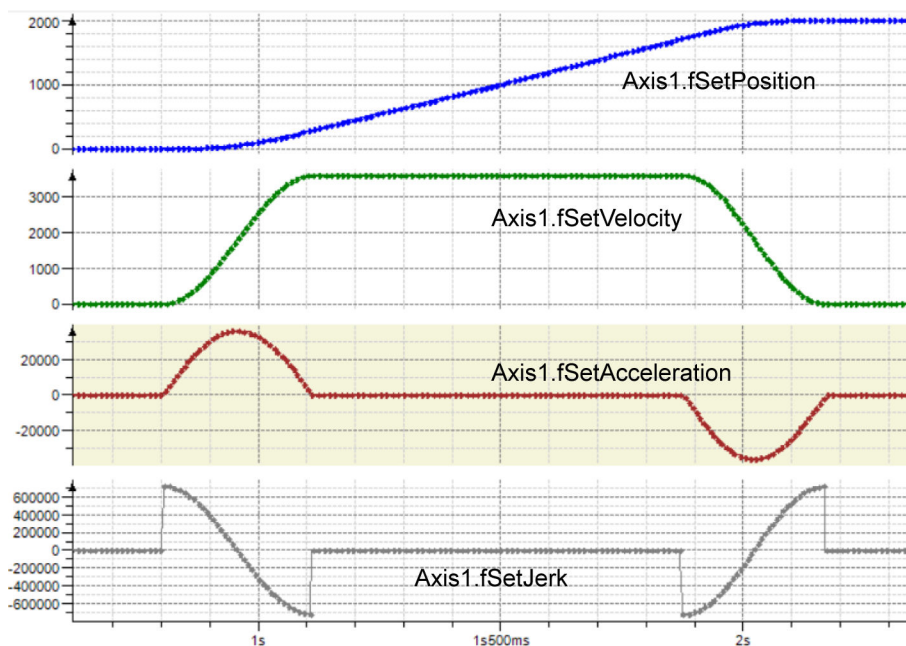

9.1 Basic Setting

■ Quadratic

This is a trapezoidal acceleration profile with jerk restriction.

Acceleration changes partially linearly and continuously and jerk rises sharply.

The maximum value of jerk can be limited by jerk values in each function block.

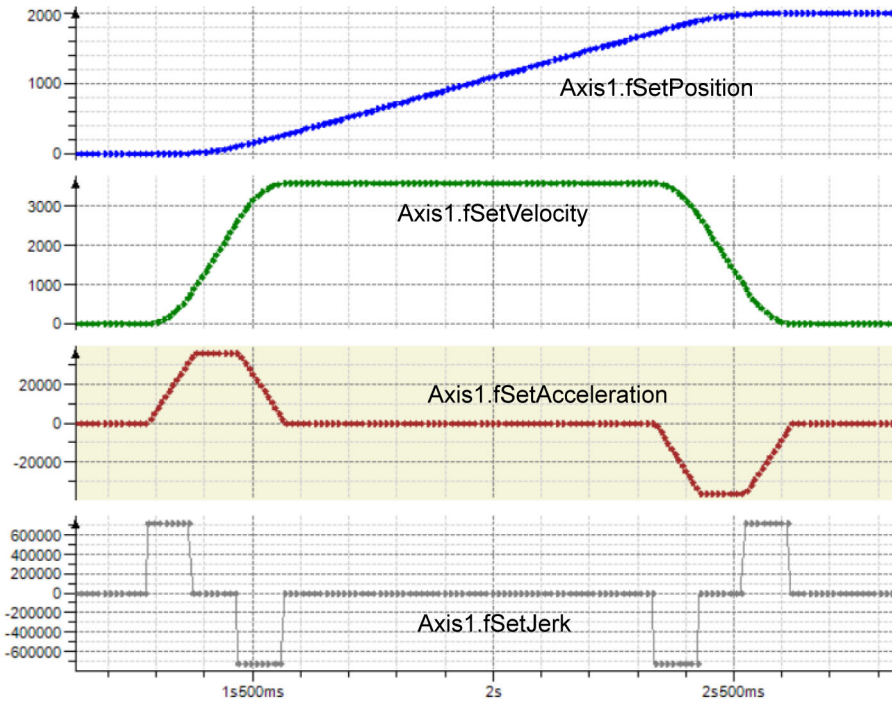

■ Quadratic (Smooth)

This is similar to "Quadratic", except that jerk does not rise sharply.

The maximum value of jerk can be limited by jerk values in each function block.

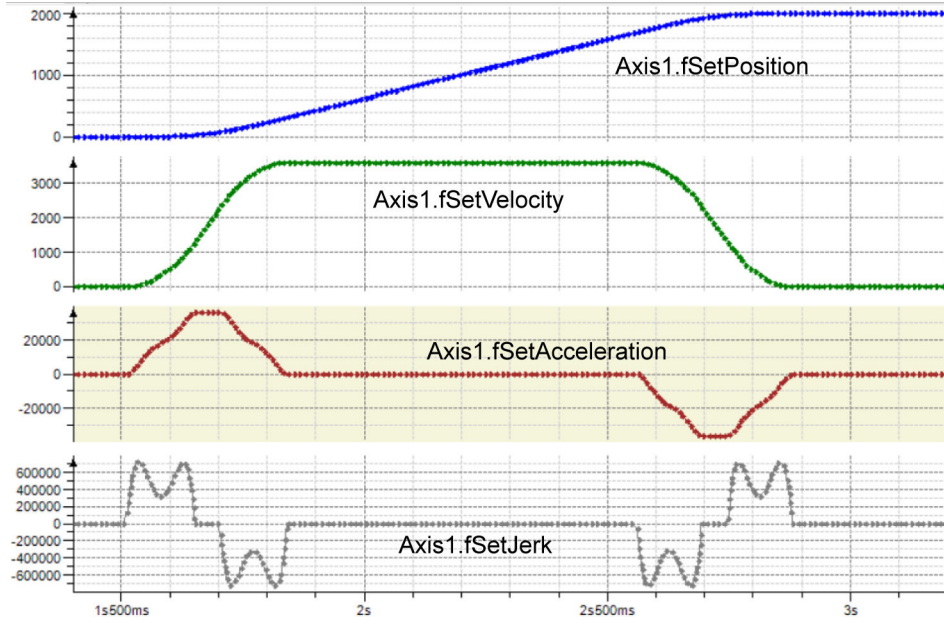

9.1 Basic Setting

■ (3) Axis state window in online mode

When "Modulo" is selected

Axis type and limits

Virtual mode
 Modulo
 Finite

Modulo settings
Modulo value [u]:

Software error reaction
Deceleration [u/s²]:
Max. distance [u]:

Dynamic limits
Velocity [u/s]: Acceleration [u/s²]: Deceleration [u/s²]: Jerk [u/s³]:

Velocity ramp type
 Trapezoid
 Sin²
 Quadratic
 Quadratic (smooth)

Identification
ID:

Position lag supervision
deactivated
Lag limit [u]:

Online

variable	set value	actual value
Position [u]	360.00	360.00
Velocity [u/s]	0.00	0.00
Acceleration [u/s ²]	0.00	0.00
Torque [Nm]	0.00	0.00

Status:

Communication:

Errors

Axis Error:

FB Error:

uiDriveInterfaceError:

strDriveInterfaceError:

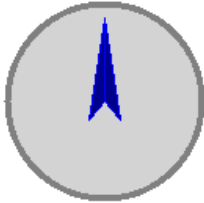

When "Finite" is selected

Axis type and limits

Virtual mode
 Modulo
 Finite

Software limits

Activated

Negative [u]:

Positive [u]:

Software error reaction

Deceleration [u/s²]:

Max. distance [u]:

Velocity ramp type

Trapezoid
 Sin²
 Quadratic
 Quadratic (smooth)

Identification

ID:

Dynamic limits

Velocity [u/s]:	Acceleration [u/s ²]	Deceleration [u/s ²]	Jerk [u/s ³]:
<input type="text" value="10"/>	<input type="text" value="100"/>	<input type="text" value="8388608"/>	<input type="text" value="10000"/>

Position lag supervision

deactivated ▼

Lag limit [u]:

Online

variable	set value	actual value
Position [u]	0.00	0.00
Velocity [u/s]	0.00	0.00
Acceleration [u/s ²]	0.00	-0.12
Torque [Nm]	0.00	0.00

Status:

Communication:

Errors

Axis Error:

FB Error:

uiDriveInterfaceError:

strDriveInterfaceError:

9.1 Basic Setting

■ (4) "Online" - "State"

This indicates one of the axis states in the following figure.

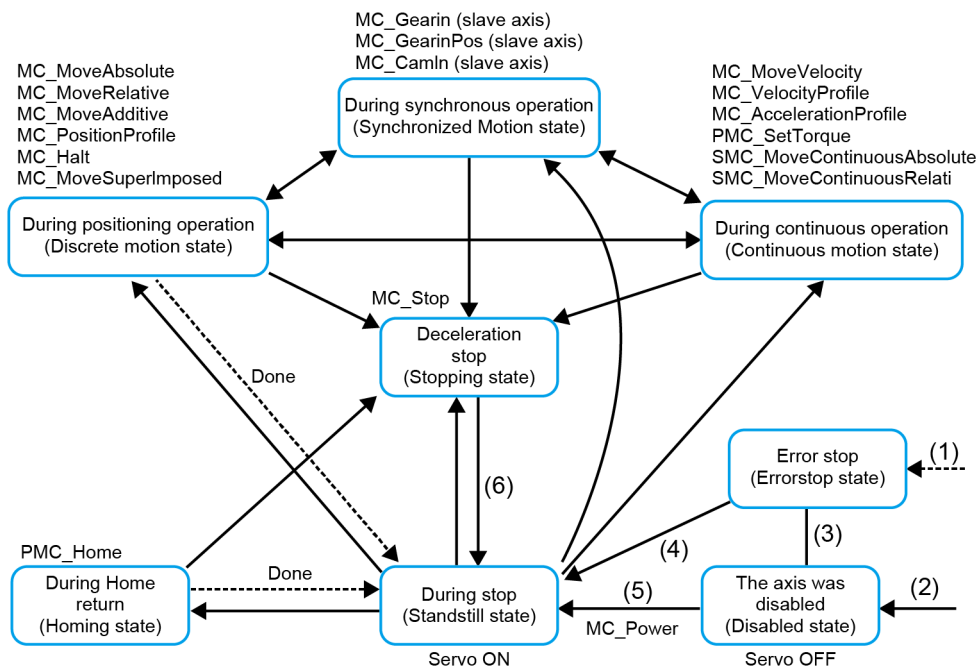

■ (5) "Online" - "Communication"

This indicates one of the following communication states.

Stopped
Variable initialized
Basic communication initialized
Drive initialized
Drive synchronization on standby
Initialization done
Operational
Re-initialized
Error
Unknown

■ (6) "Online" - "Error"

- FB error
The oldest error that occurred on the axis, "SMC_ReadFBError", is displayed. "SMC_ReadFBError" function block.
- uiDriveInterfaceError / strDriveInterfaceError
This is an internal error in the GM1 series.

9.1.4 Adding and Setting up Free Encoder and Virtual Drive

This section explains how to add device objects for free encoders and virtual drives to a project and set them up.

For example, use the following procedure to add a device object for a virtual drive to a project and set it up.

1 2 Procedure

1. Right-click the [SoftMotion General Axis Pool] object in the navigator pane and then select "Device Management" from the context-sensitive menu that is displayed.

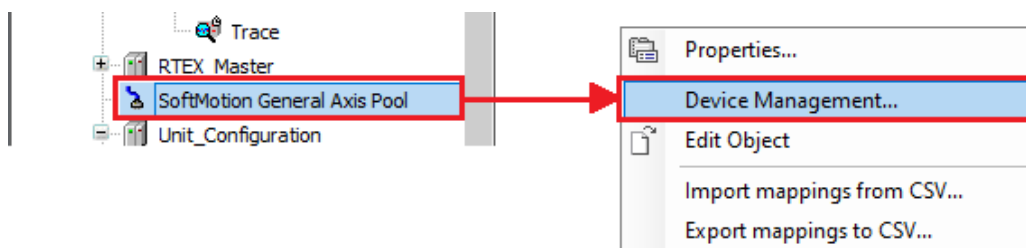

The "Device Management" dialog box will be displayed.

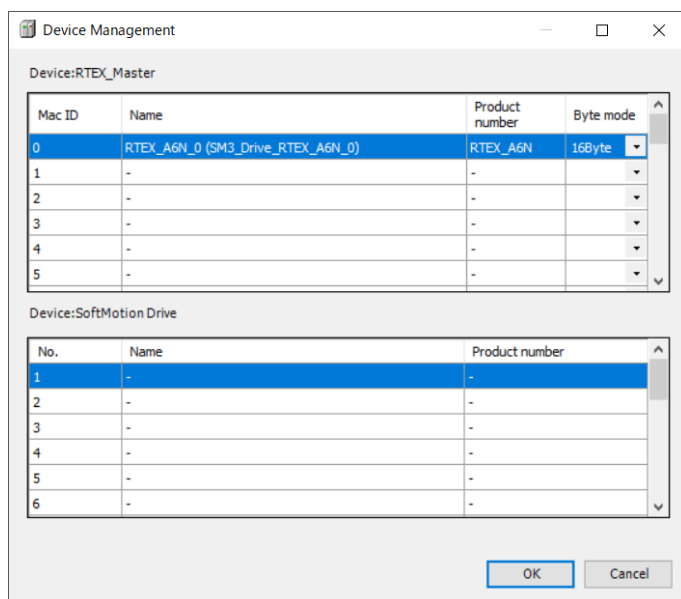

2. Double-click the first row in the "Device: SoftMotion drive" table. The "Select Device" dialog box will be displayed.

9.1 Basic Setting

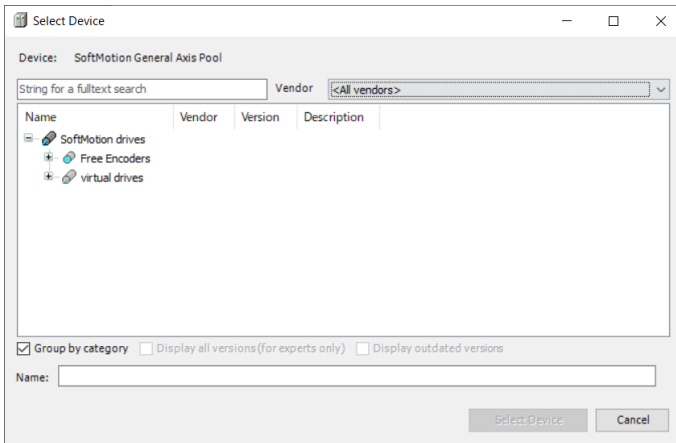

3. Select a device object for the virtual drives.

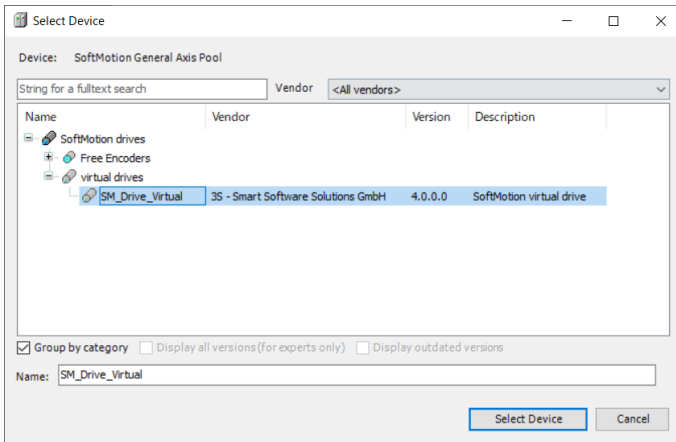

4. Click the [Select Device] button.
The selected device object of the virtual drive will be added.

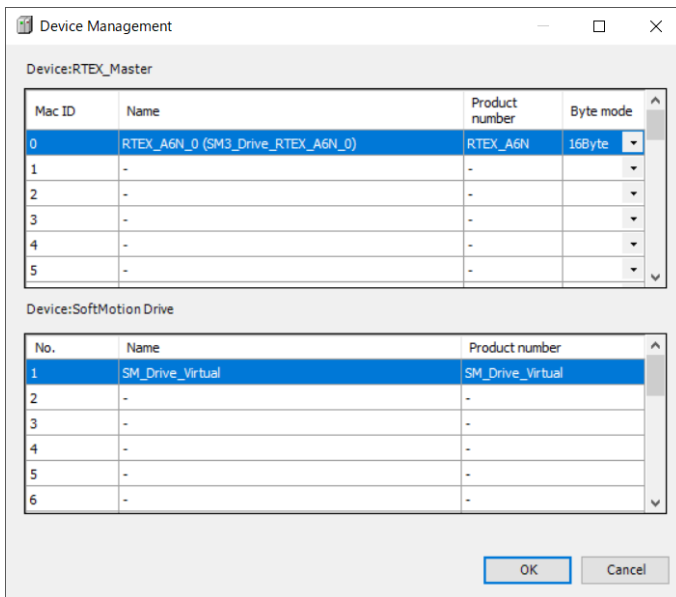

5. Click the [OK] button.

The selected device object of the virtual drive will be added to the navigator pane.

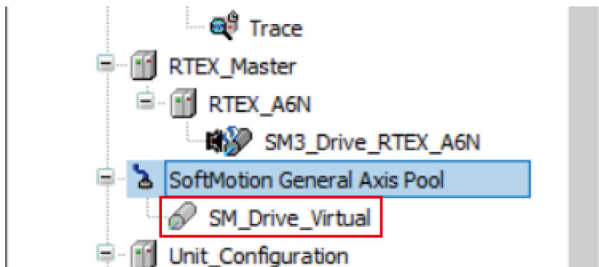

6. Double-click the added object.

The setting pane will be displayed in the main pane. Specify settings related to the virtual drive.

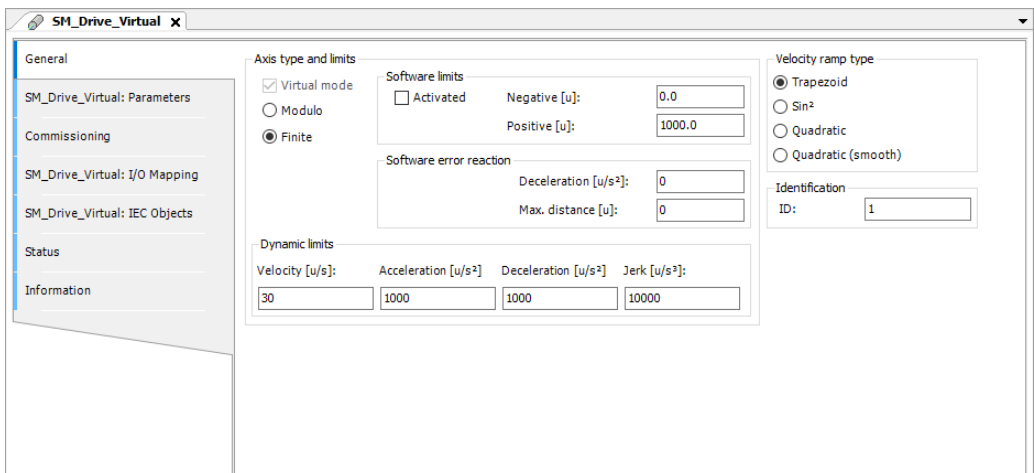

9.1 Basic Setting

Info.

- To remove a device object that has been added, select the device object in the navigator pane and press the "Delete" key.

9.2 Initial Setup for Servo Amplifiers

In this section, initialize the servo amplifier.

1 2 Procedure

1. Please refer to "15.3.1 Connecting the Servo Amplifier and PC" to connect
2. Start PANATERM Lite for GM.
The "Connect" dialog box will be displayed.

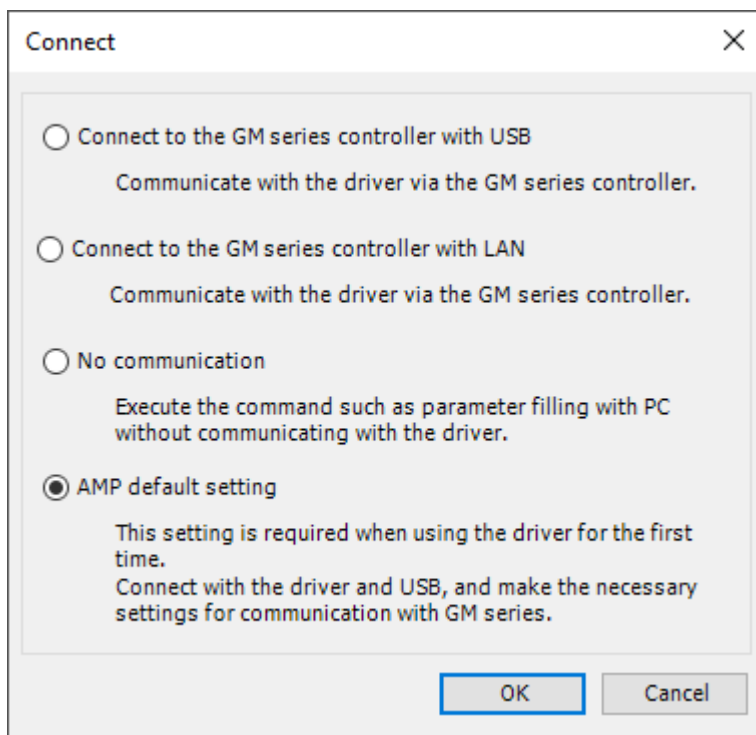

3. Select "AMP default setting" and click [OK].
The "Model confirmation" dialog box will be displayed.

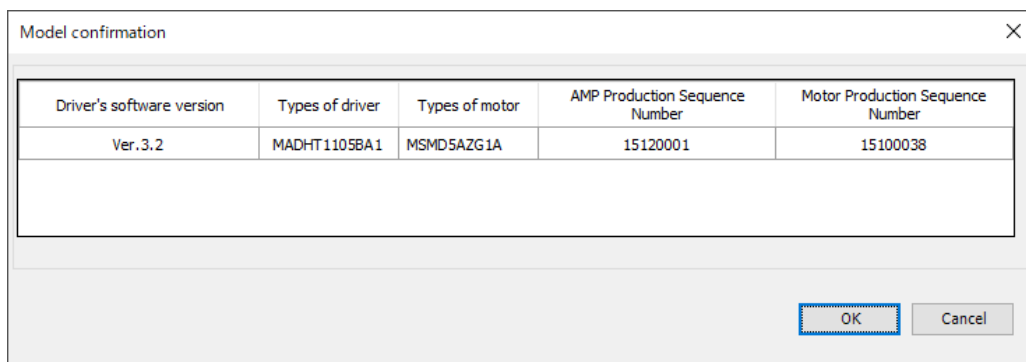

9.2 Initial Setup for Servo Amplifiers

4. Check the software version of the servo amplifier for which settings are to be changed and then click [OK].

The "Parameter change" dialog box will be displayed.

Please refer to the following for parameter change.

RTEX: "9.2.1 RTEX parameter settings for servo amplifier"

EtherCAT: "9.2.2 EtherCAT parameter settings for servo amplifier"

Parameter change

writing to AMP EEPROM.

Class	No	Parameter Name	Setup Range	Value
00	11	Output pulse counts per one motor rev...	1 - 2097152	2500
00	15	Absolute encoder setup	0 - 4	1
07	20	RTEX communication cycle setup	-1 - 12	3
07	21	RTEX command updating cycle setup	1 - 2	2
07	22	RTEX function extended setup 1	-32768 - 32767	1
07	25	RTEX speed unit setup	0 - 1	1

Set A/B phase output counts per motor revolution.

OK Cancel

5. Click the [OK] button.
The "Setting Complete" dialog box will be displayed.
6. Click the [OK] button.
The main panel will be displayed. Start the servo amplifier.

9.2.1 RTEX parameter settings for servo amplifier

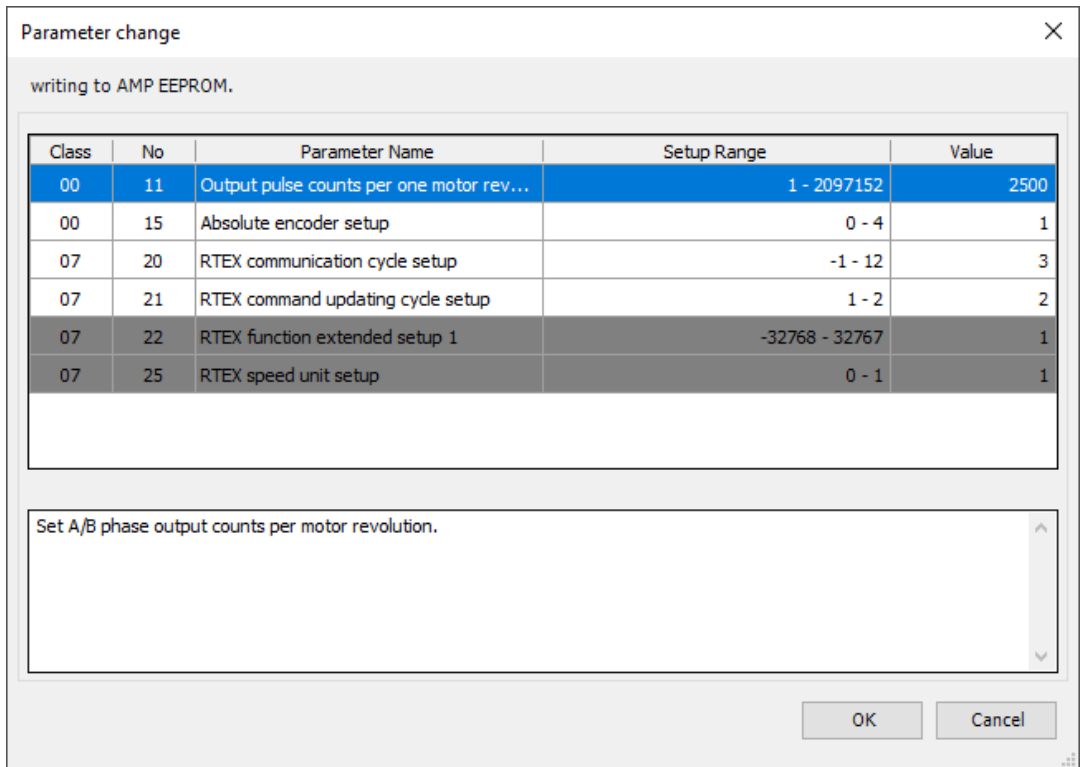

If you are using the following settings, please change them according to your operating environment.

- "Absolute encoder setup"
- "Output pulse counts per one motor rev..."
- "RTEX communication cycle setup"
- "RTEX command updating cycle setup"

9.2 Initial Setup for Servo Amplifiers

9.2.2 EtherCAT parameter settings for servo amplifier

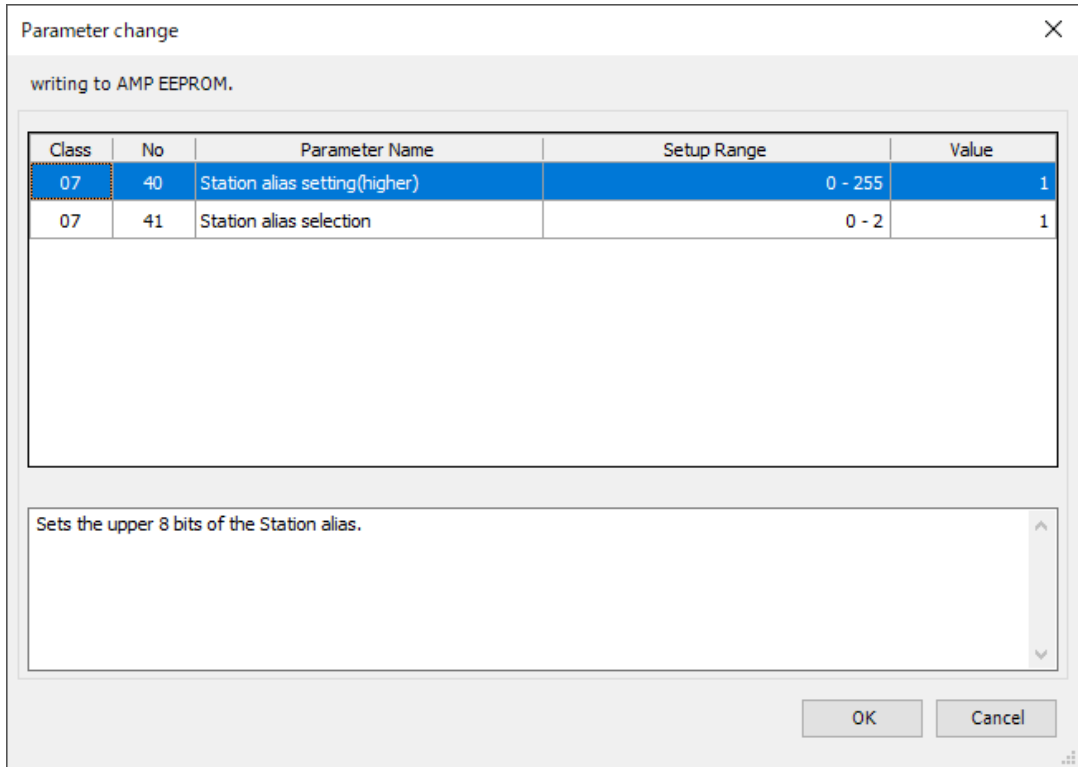

If Pr7.41 is set to 0, the setting of the rotary switch on the front panel of the servo amplifier and the setting of Pr7.40 will be set as Station alias.

Station alias	
High-order 8 bits	Low-order 8 bits
3740H setting	Rotary switch setting

If Pr7.41 is set to 1, the value of the SII area (0004h) will be set as Station alias.

The value of the SII area (0004h) can be set using the EtherCAT slave device object of GM Programmer.

9.3 Preparation for Operation

9.3.1 Checking Wiring

Firstly, check whether the GM1 Controller, expansion units, servo amplifier, and PC are connected correctly.

Example) EtherCAT connection:

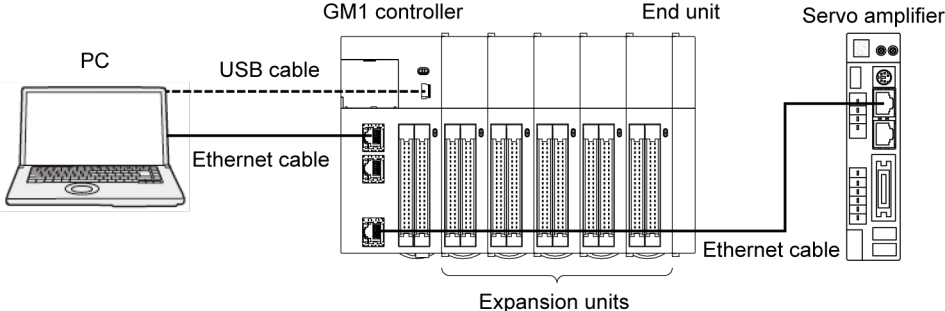

Example) RTEX connection:

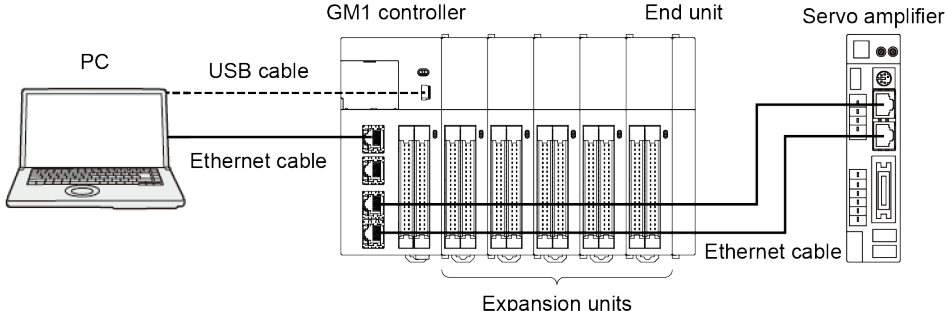

9.3 Preparation for Operation

9.3.2 Checking Safety Circuit Design

Safety Circuit Design

■ Example of a safety circuit

Be sure to create a safety circuit when using this product.

Installation of over limit switches

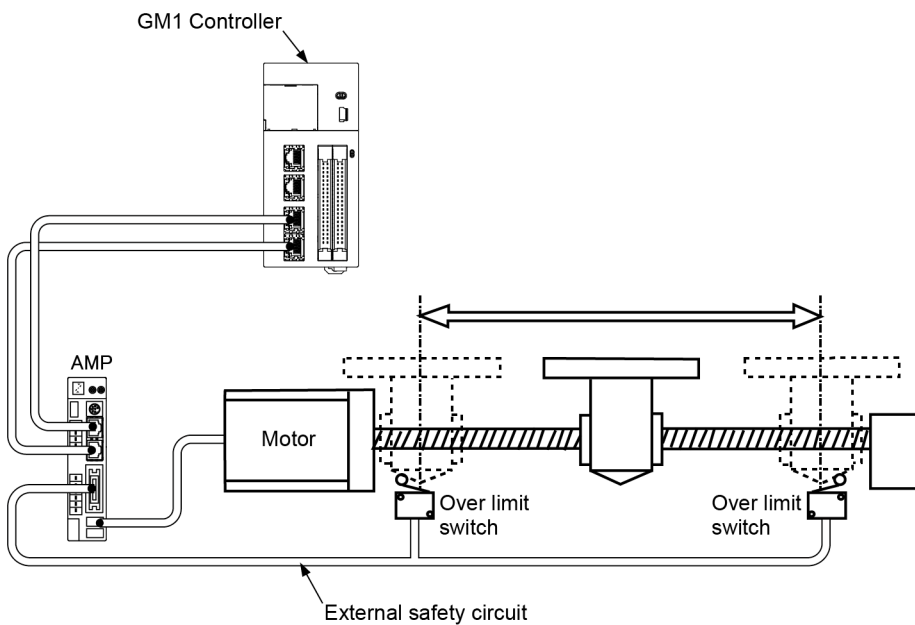

- Install over limit switches as shown above.
- Connect them to the CW and CCW over-travel inhibit inputs of the parallel I/O connector of the servo amplifier. For the GM1 Controller, connect them to the limit input (+) and limit input (-) through the network.



- Install the safety circuit recommended by the manufacturer of the motor being used.

Items to Check during Wiring

■ System configuration example

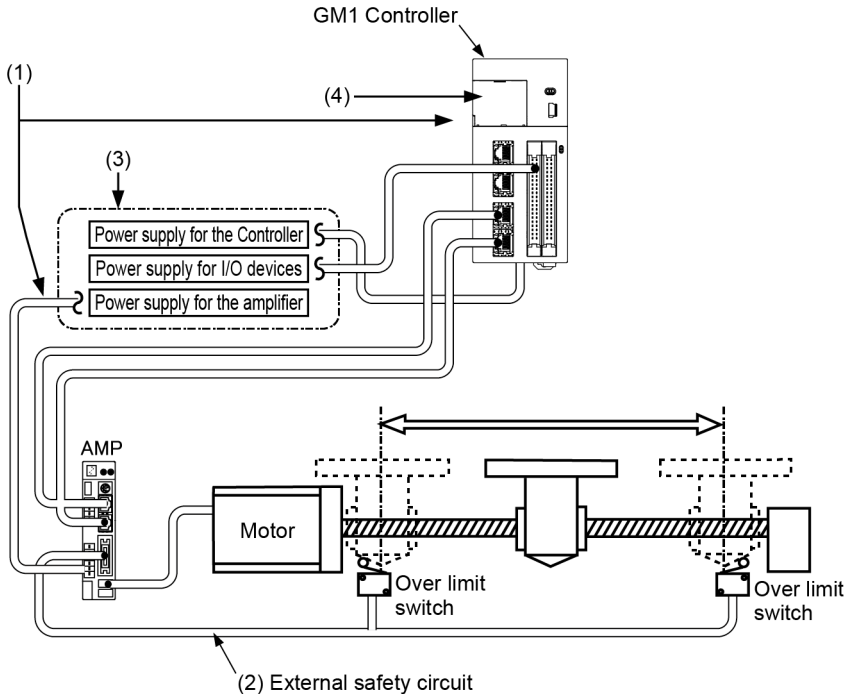

(1) Checking connections of each device

Check to make sure that each device has been connected as indicated by the design.

(2) Checking the installation of the external safety circuit

Check to make sure the safety circuit (wiring and installation of over limit switch) based on the external circuit has been installed properly.

(3) Checking the settings for power ON sequence

Make sure that settings have been entered so that power supplies will be turned according.

(4) Checking the GM1 Controller mode selector switch

Set the GM1 Controller to the STOP mode. Setting it in the RUN mode can cause inadvertent operation.

9.3 Preparation for Operation

Power ON Operation

When turning ON the power supply to the system incorporating the GM1 Controller, turn ON the power supply in the following order.



- Consider the nature and statuses of any external devices connected to the system, and take sufficient care so that turning ON the power supply will not initiate unexpected movements.

1 2 Procedure

1. Turn ON the power supplies to the I/O devices connected to the GM1 Controller.
2. Turn ON the power supply to the servo amplifier.
3. Turn ON the power supply to the GM1 Controller.

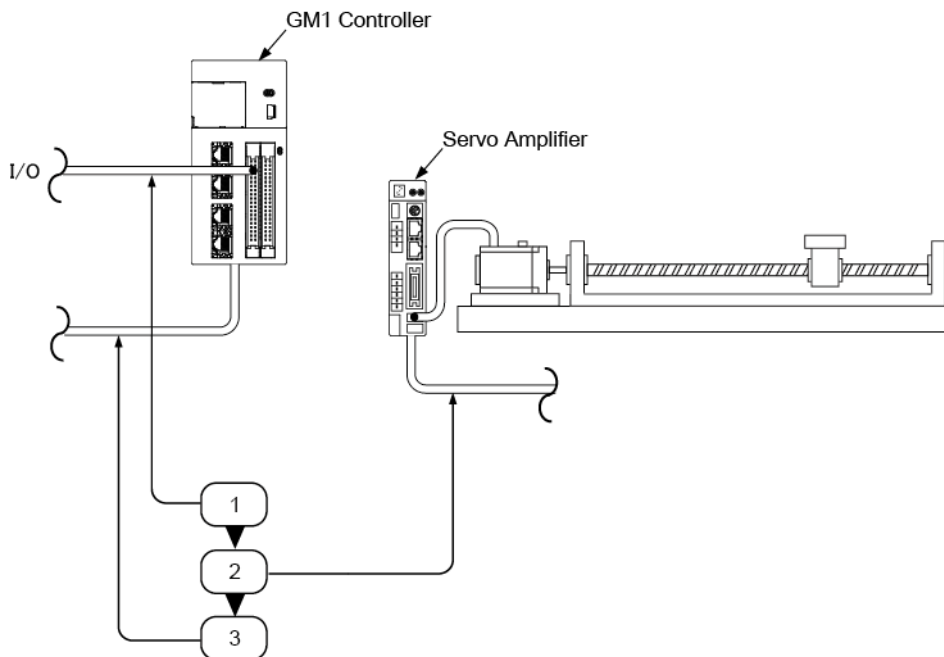

Power OFF Operation

1 2 Procedure

- 1. Check to make sure the rotation of the motor has stopped, and then turn OFF the power supply to the GM1 Controller.
- 2. Turn OFF the power supply to the servo amplifier.
- 3. Turn OFF the power supplies to the I/O devices connected to the GM1 Controller.

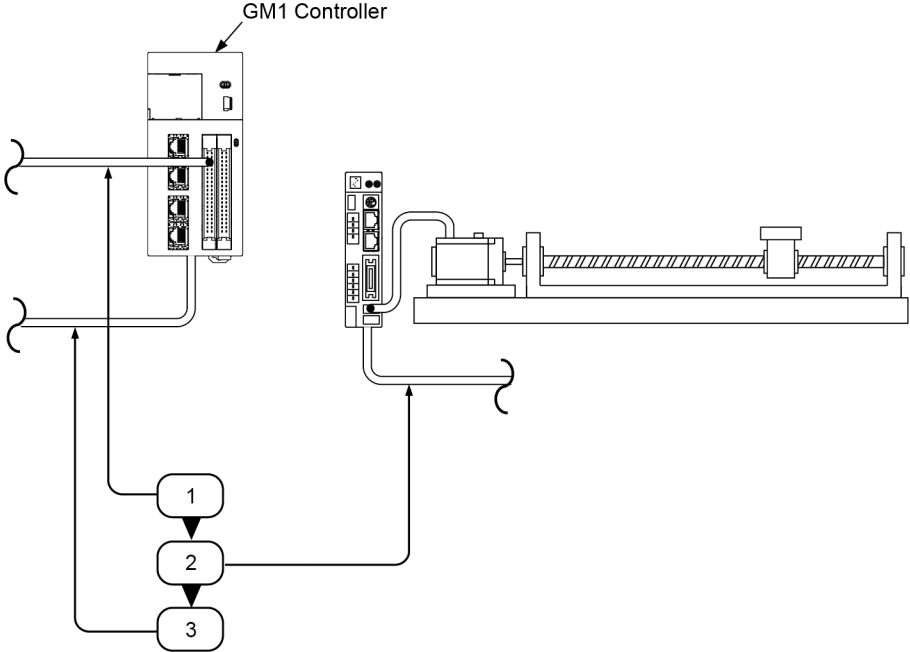

9.3 Preparation for Operation

9.3.3 Operation Mode Switching

■ Switching to the RUN mode

There are the following two methods.

- Press the operation button (▶) on the GM Programmer while the STOP LED is lit.
- Set the RUN/STOP switch on the GM1 Controller to RUN.

Info.

- The switch cannot be set to the RUN mode if an error that does not allow to continue operation has occurred or if an exceptional situation has occurred.

■ Switching to the STOP mode

There are the following two methods.

- Press the stop button (■) on the GM Programmer while the RUN LED is lit.
- Set the RUN/STOP switch on the GM1 Controller to STOP.

9.3.4 Operation Check

Checking the Network

After turning ON the power supplies, check if the operation monitor LEDs of the GM1 Controller are in the following states.

- STATUS: Lit
- LINK: Lit

i Info.

- If the "STATUS" LED is flashing, the network is not established.
- If the "LINK" LED is not lit, the "RX" (reception side) of the GM1 Controller and "TX" (transmission side) of the servo amplifier are not electrically connected normally.

9.3 Preparation for Operation

Checking Input Signals

Check the input of the over limit switch for the safety circuit connected to the servo amplifier and the input of the near home (DOG) switch.

Check whether signal inputs are properly loaded into the GM1 Controller, with each switch operated forcibly.

The input state of each switch can be checked on the monitor screen of the MINAS Series Setup Support Software "PANATERM Lite for GM".

i Info.

- If the operating direction of the motor is opposite to the position of the limits (+) and (-) after the installation of the over limit switch, check the physical connection of the limit switch.

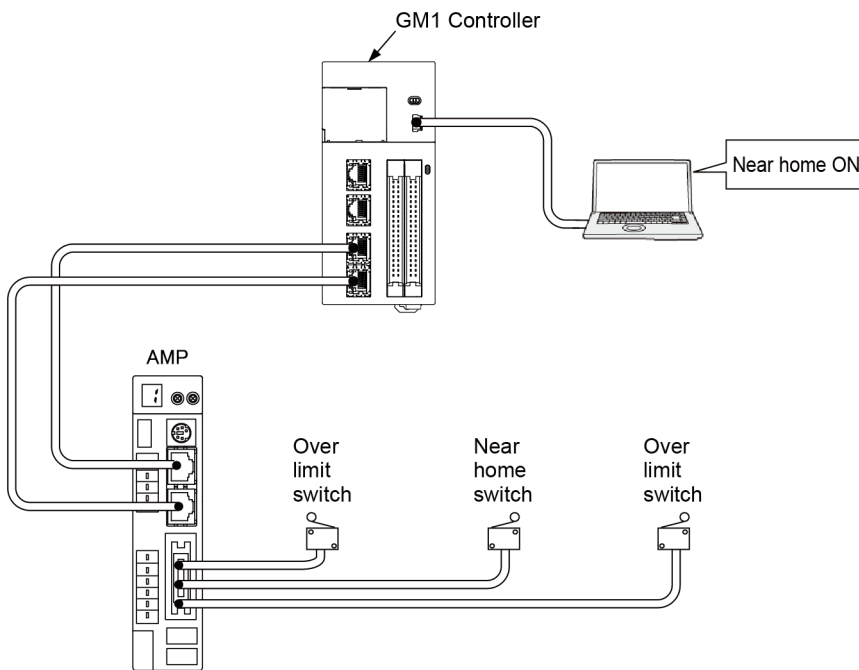

Checking Rotating and Moving Directions and Moving Distance

Check whether the rotating and moving directions of the motor and the moving distance are correct. The operations can be easily confirmed using the commissioning function of the GM Programmer without user programs.

■ Using the commissioning function

On the GM Programmer, select **Project>Online Setting Mode**.

Open the "Commissioning" screen for each axis to use the commissioning function.

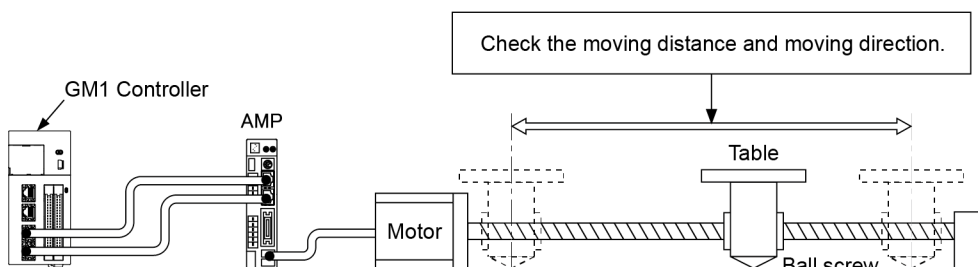

■ Checking the rotation direction

Set the rotation direction on the servo amplifier.

Check the rotation direction by executing inching operation on the Commissioning screen.

■ Checking the moving distance

Set the moving distance on the servo amplifier.

Next, set the scale on the "Scaling / Mapping" screen for each axis on the GM Programmer.

Check the moving distance by executing inching operation on the Commissioning screen.

i Info.

For details on inching operation on the Commissioning screen, refer to "[11.2 Conducting Commissioning for Servo Amplifiers](#)".

9.4 Operation up to running

9.4 Operation up to running

This section explains how to run and stop the motor.

9.4.1 Servo ON or OFF

To turn ON or OFF the servo motor, use the "MC_Power" function block.

■ Explanation of function block

- For input "Axis", specify the axis corresponding to the servo motor.

Example) In the case of SM3_Driver_EtherCAT_A6B_0, substitute "SM3_Driver_EtherCAT_A6B_0" for "Axis" of MC_Power.

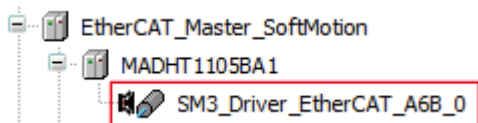

- When inputs "Enable", "bRegulatorOn", and "bDriveStart" are set to TRUE, the servo turns ON.

When input "bRegulatorOn" is set to FALSE, the servo turns OFF.

■ Program examples

The following are LD program and ST program examples that execute the "MC_Power" function block.

Setting variable "SW_Power" to TRUE turns ON the servo and setting it to FALSE turns OFF the servo.

LD program

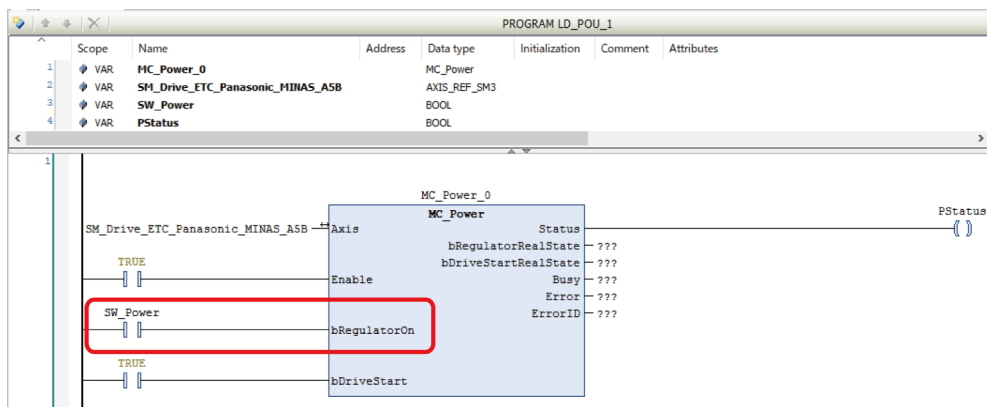

ST program

- Declaration section

```
PROGRAM ST_POU
VAR
  MC_Power_0: MC_Power;
  SW_power : BOOL := FALSE;
```

```
PStatus : BOOL := FALSE;
END_VAR
```

- **Implementation section**

```
MC_Power_0(
  Axis := Axis1 ,
  Enable := TRUE ,
  bRegulatorOn := SW_power ,
  bDriveStart := TRUE ,
  Status => PStatus ,
  bRegulatorRealState => ,
  bDriveStartRealState => ,
  Busy => ,
  Error => ,
  ErrorID =>
);
```

Info.

- When executing "MC_Power", confirm in advance that communication has been established. The communication state can be checked using the "SMC_CheckAxisCommunication" function block.

9.4.2 Commissioning

Commissioning can be conducted using GM Programmer.

To conduct commissioning, the GM1 controller must be connected in online setting mode.

After switching to Online Configuration Mode, please refer to the following.

EtherCAT:"[10.2 Conducting Commissioning for Servo Amplifiers](#)"

RTEX:"[11.2 Conducting Commissioning for Servo Amplifiers](#)"

Online Config Mode

When the online config mode is selected, the servo amplifiers are set to be connected to the GM1 Controller.

When using the online config mode, perform the setting as described in "[7.3 Communication Setting](#)" in advance.

1 2 Procedure

1. From the menu bar, select **Project>Online Config Mode**.
A confirmation message will be displayed, asking whether to remove all applications.

9.4 Operation up to running

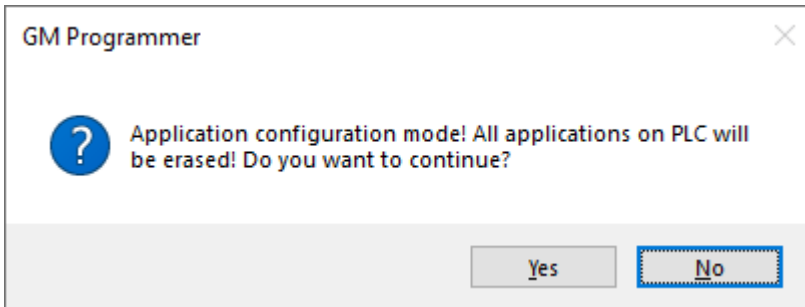

2. Click [Yes].

All applications will be removed from the GM1 controller, and the GM1 controller and servo amplifiers will be connected in online config mode.

While online config mode is in progress, "Online Config Mode" in the menu bar remains selected.

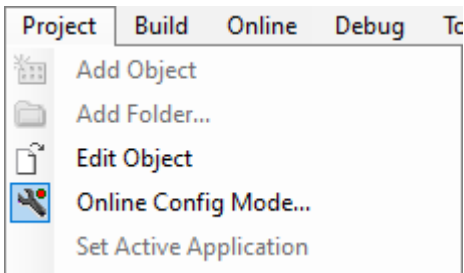

i Info.

- To cancel the online config mode, select **Project>Online Config Mode** from the menu bar again.

9.5 Single-axis Operation

This section explains single-axis operations using function blocks.

9.5.1 Overview of Single-axis Operation

In single-axis operation, it supports Home Return, Switching the Control Mode, Stop and JOG / Inching.

Single-axis Operation type	Overview	Reference
Servo ON	Turn Servo ON and make it ready for operation.	"9.4.1 Servo ON or OFF"
Home Return	Home return of the axis can be performed.	RTEX: "11.3 Home Return" EtherCAT: "10.3 Home Return"
Switching the Control Mode	Switching between position, control, and torque control can be performed.	"9.5.2 Switching the Control Mode"
Stop	Decelerates the axis to a stop.	<i>GM1 Series Reference Manual (Instruction).</i>
JOG / Inching	JOG: Moves forward or reverse at a constant speed. Inching: The axis moves forward or reverse by a specified relative distance.	

9.5.2 Switching the Control Mode

Supports position control, velocity control, and torque control as control modes.

Switching the Control Mode can be used while switching control according to the purpose.

The control mode can be switched by "SMC_SetControllerMode" of the function block.

■ Control Mode and Corresponding Function Blocks

Control mode	Value	Name	Description	Corresponding Function Blocks
SMC_torque	1	Torque control mode	Torque control is performed at the specified torque.	PMC_SetTorque, SMC_SetTorque
SMC_velocity	2	Velocity control mode	Controls the motor to move at a specified speed.	MC_MoveVelocity, MC_VelocityProfile, MC_AccelerationProfile
SMC_position	3	Position control mode (Default value)	Controls the motor to move at a specified position or distance.	MC_MoveAbsolute, MC_MoveRelative, MC_MoveAdditive, MC_MoveSuperImposed, MC_PositionProfile, SMC_MoveContinuousAbsolute, SMC_MoveContinuousRelative, MC_MoveVelocity, MC_VelocityProfile, MC_AccelerationProfile

9.5 Single-axis Operation

Info.

- For details, refer to the *GM1 Series Reference Manual (Instruction)*.

9.6 Synchronous Control

9.6.1 Overview of Synchronous Control

Synchronous control supports synchronous gear control, synchronous cam control, and CNC control.

Synchronous control method	Overview	Reference
Synchronous gear control	Enables gear position control.	<i>GM1 Series Reference Manual (Instructions Edition)</i>
Synchronous cam control	Enables synchronous cam control of the axes using a cam table created by a tool or a cam profile created by POU.	"9.7 Cam synchronous Control"
CNC control	Enables motor control by converting G-code into executable form and computing command data from the CNC program to the motor at every control cycle.	"9.8 CNC Control"

9.7 Cam synchronous Control

9.7.1 Overview of Cam Control and How to Use It

This section describes an overview of cam control and how to use cam control with GM Programmer.

Cam control is control used to synchronize the master axis and slave axis in accordance with information (a cam profile) in which the position, velocity, and acceleration of the slave axis are defined based on the phase of the master axis (positional information). In the cam profile, information about the position and velocity of the slave axis is created from a cam table, in which representative points are defined, and the phase of the master axis (positional information) through a converter.

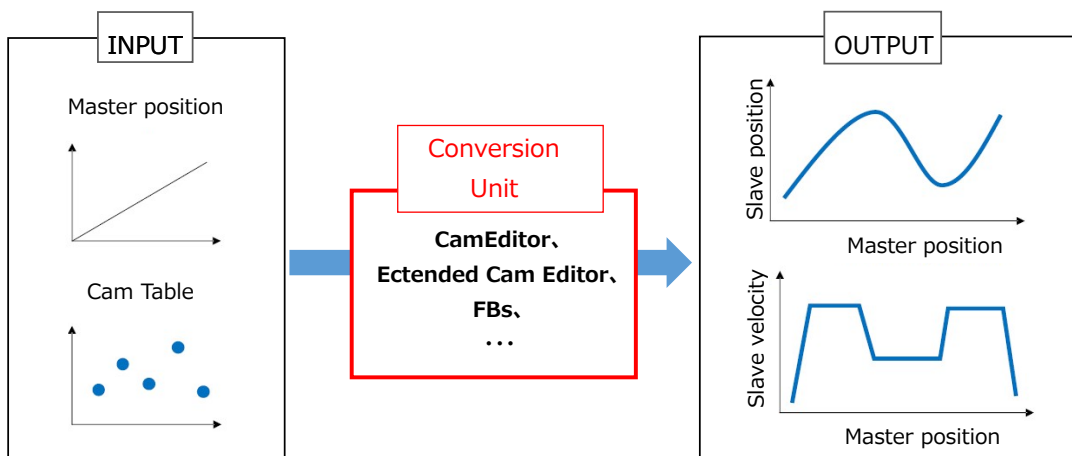

At the converter, conversion is performed largely through the following three steps to output information on slave position from information on master position.

1.2 Procedure

1. Create a cam table

Create a cam table to define representative points that are elements of a cam profile (waveform information).

Configure representative points into which an operation section are divided and specify how these representative points are connected to each other to create a cam table. With GM Programmer, you can create it by the following three types of methods.

- Cam editor
- Expansion cam editor
- Programming in POU

Cam	Cam table	Tappets	Tappet table							
	X	Y	V	A	J	Segment Type	min(Position)	max(Position)	max(Velocity)	max(Acceleration)
	0	0	0	0	0	Poly5	0	90	8.3286607113702615	1.2794742882094112
	20	90	0.25	0	0					
	60	320	0.5	0	0	Poly5	90	320	10.453561044939438	0.7820728009345812
	120	190	1	0	0	Poly5	185.35449681125637	321.626279507272	4.7219641282798934	0.28903068239542618
	180	35	1	0	0	Poly5	30.808567391206793	194.19143260879309	5.71875	0.34480641076602853
	240	180	1	0	0		35	180	3.65625	0.13631881355864166
	360	360	0	0	0	Poly5	180	360	2.4124375000000002	0.056677359476316087

```

1 PROGRAM POU
2 VAR
3   CamTable: ARRAY[0..6] OF SMC_CAM2YGA := [
4     (dx := 0, dy := 0, dv := 0, da := 0),
5     (dx := 20, dy := 90, dv := 0.25, da := 0),
6     (dx := 60, dy := 320, dv := 0.5, da := 0),
7     (dx := 120, dy := 190, dv := 1, da := 0),
8     (dx := 180, dy := 35, dv := 1, da := 0),
9     (dx := 240, dy := 180, dv := 1, da := 0),
10    (dx := 360, dy := 360, dv := 0, da := 0)]
11 END_VAR
12

```

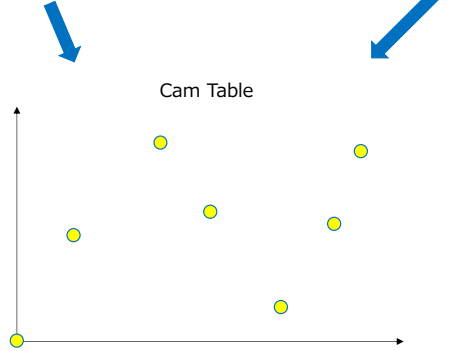

2. Convert the cam table into executable format

Read the created cam table and convert it into executable format.

First, convert the cam table into profile data in which each section between the adjacent representative points is divided by information on the master position. Next, create a structure MC_CAM_REF that includes tappet settings in addition to the profile data about position. The tappet settings are a list of data (tappet table) about points that are to be switched ON or OFF in response to the master and slave positions. The data about points includes ON/OFF operation settings aside from the positional information.

Cam tables created by the Cam editor are automatically converted into profile data and MC_CAM_REF.

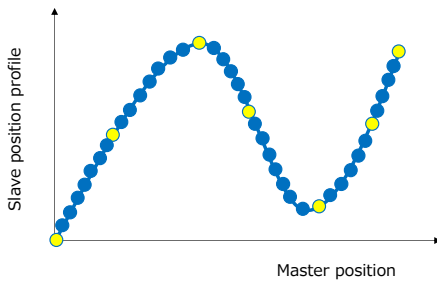

```

MC_CAM_REF
- wCamStructID WORD
- byType BYTE
- byVarType BYTE
- xStart LREAL
- xEnd LREAL
- nElements INT
- nTappets INT
- pce POINTER TO BYTE
- pt POINTER TO SMC_CAMTappet
- dwTappetActiveBits DWORD
- strCAMName STRING
- byInterpolationQuality BYTE
- byCompatibilityMode BYTE
- bChangedOnline BOOL
- bPartOfLM BOOL

```

Tappet Settings

Cam	Cam table	Tappets	Tappet table	
	Track ID	X	positive pass	negative pass
	1	90	none	switch OFF
		90	switch ON	none
		180	switch ON	none
		180	none	switch OFF
		270	switch ON	none
		270	none	switch OFF

```

1 PROGRAM POU
2 VAR
3   TappetTable: ARRAY[0..5] OF SMC_CAMTappet := [
4     (k := 90, oct := 2, sGroupID := 1, octa := 1),
5     (k := 90, oct := 0, sGroupID := 1, octa := 0),
6     (k := 180, oct := 2, sGroupID := 1, octa := 1),
7     (k := 180, oct := 0, sGroupID := 1, octa := 0),
8     (k := 270, oct := 2, sGroupID := 1, octa := 1),
9     (k := 270, oct := 0, sGroupID := 1, octa := 0)]
10 END_VAR
11

```

3. Calculate axis command position from the profile data

Read the profile data about position from the created MC_CAM_REF and compute a slave position to calculate a command position.

9.7 Cam synchronous Control

The command position is derived from information about the master position by linearly interpolating data between the divided points of the slave axis position profile. Cam synchronous control is performed by causing the slave axis to move according to the command position.

To calculate a command position with GM Programmer, you must do programming using function blocks in POU.

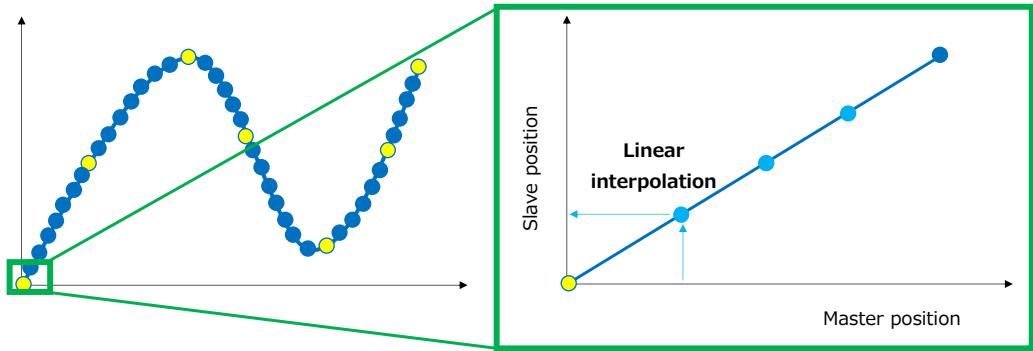

i Info.

- For the procedure for creating MC_CAM_REF using the Cam editor, refer to "[Creating MC_CAM_REF by Cam Editor](#)".
- For the procedure for creating MC_CAM_REF using the Expansion cam editor, refer to "[Creating MC_CAM_REF by Ectended Cam Editor](#)".
- Function blocks used in cam control are not just for interpolation calculation but also for acquisition of tappet switching action, axis parameter calculation, and other purposes. For details, refer to the GM1 Series Reference Manual (Instruction Edition).

9.7.2 Creating Cam Data

Creating MC_CAM_REF by Cam Editor

This section explains how to add a cam object and how to create MC_CAM_REF.

1 2 Procedure

1. Right-click the “Application” object in the navigation pane and then select **Add Object>Cam Table** from the context-sensitive menu that is displayed.

The “Add cam table” dialog box will be displayed.

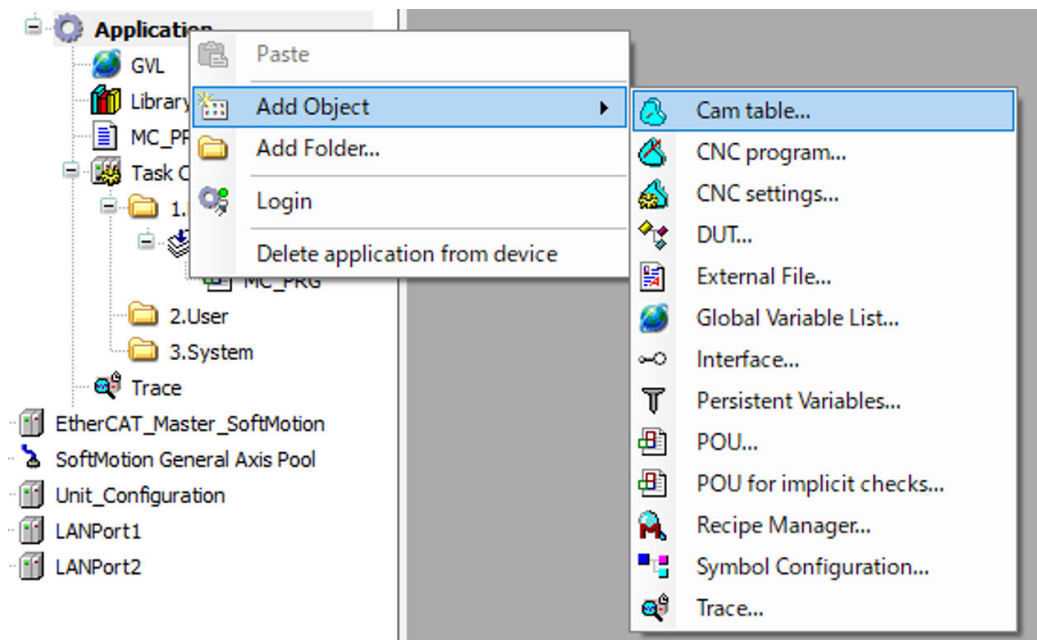

2. Enter a cam table name and then click the [Add] button.
The name specified here will be used for an entry in a function block.

9.7 Cam synchronous Control

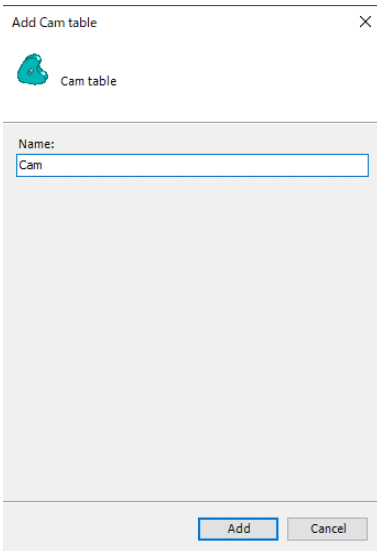

- When the cam object is added, the “Cam” tab appears. Change the default path setting if necessary.

The “Cam” tab displays the following four items one by one in a vertical direction: position, velocity, acceleration, and jerk of a slave (vertical axis) relative to the master position (horizontal axis). The “Cam Table” tab displays numerical values that represent the graphs displayed in the “Cam” tab.

- “Cam” tab

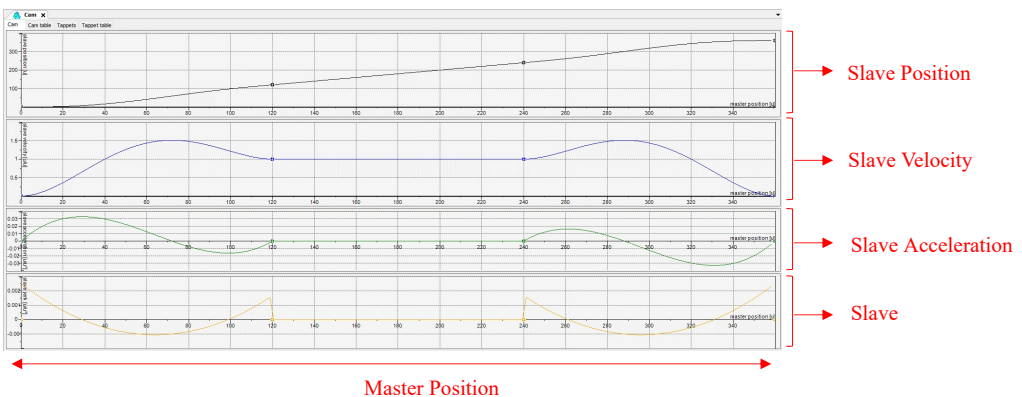

- “Cam table” tab

Cam	Cam table	X	Y	V	A	J	Segment Type	min(Position)	max(Position)	max(Velocity)	max(Acceleration)
		0	0	0	0	0	Poly5	0	120	1.5120000000000007	0.032835282941414162
		120	120	1	0	0	Poly5	120	240	1	0
		240	240	1	0	0	Poly5	240	360	1.512	0.032835282941414141
		360	360	0	0	0					

You can change the maximum and minimum values on the master axis and slave axis in the cam table. Right-click the “Cam” object in the navigator pane and then select

“Properties” from the context-sensitive menu that is displayed. In the Properties window, click the “Cam” tab and change the values.

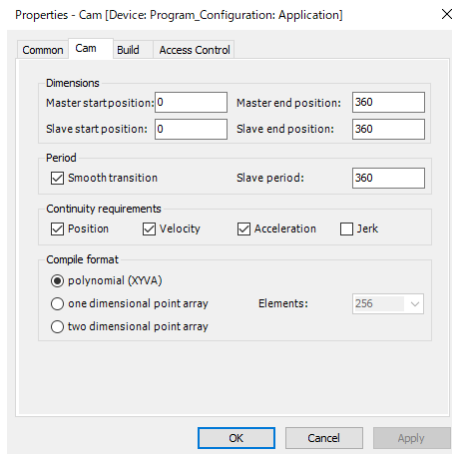

Item		Corresponding variables in MC_CAM_REF	Description
Dimensions	Master start/end position	xStart/xEnd	Defines scale values on the cam horizontal axis (master axis). A cam table can be created only within this range.
	Slave start / end position	-	Defines scale values on the cam vertical axis (slave axis). Slave position points on the Cam editor can be set only within this range. However, this does not apply to maximum and minimum values between position points.
Period	Smooth transition	-	Enabled: When a path is edited, the path is automatically adjusted such that the position, velocity, and acceleration values of the slave axis are continuous for the specified “Slave period” value. Details will be described later in step 4.
	Period	-	Specifies a period for the slave position. The specified value is reflected when the smooth transition setting is enabled.
Continuity requirements	Position, Velocity, Acceleration, Jerk	-	Continuity of parameters for which the check box is selected (whether data before and after the representative point is continuous) is checked during build.
Compile format ^(Note 1)	Polynomial (XYVA)	byType = 3	A cam table is made up of master position, slave position, slave velocity, and slave axis acceleration items.
	one dimensional point array	byType = 1	A cam table is made up of only a slave position item. (master position is

9.7 Cam synchronous Control

Item	Corresponding variables in MC_CAM_REF	Description
		divided into equal intervals by the number of elements.)
two dimensional point array	byType = 2	A cam table is made up of master position and slave position items.
Elements	-	This can be used for one dimensional and two dimensional point arrays. Specifies the number of elements that make up the array.

(Note 1) For details, refer to the GM1 Series Reference Manual (Instruction Edition).

4. To change the path on the “Cam” tab, use Toolbox.

To change the path by using a point already set, select “Select” in Toolbox and drag the point you want to change. Points can move only upward or downward. To delete a point, select the point with the “Select” tool and then press the “Del” key.

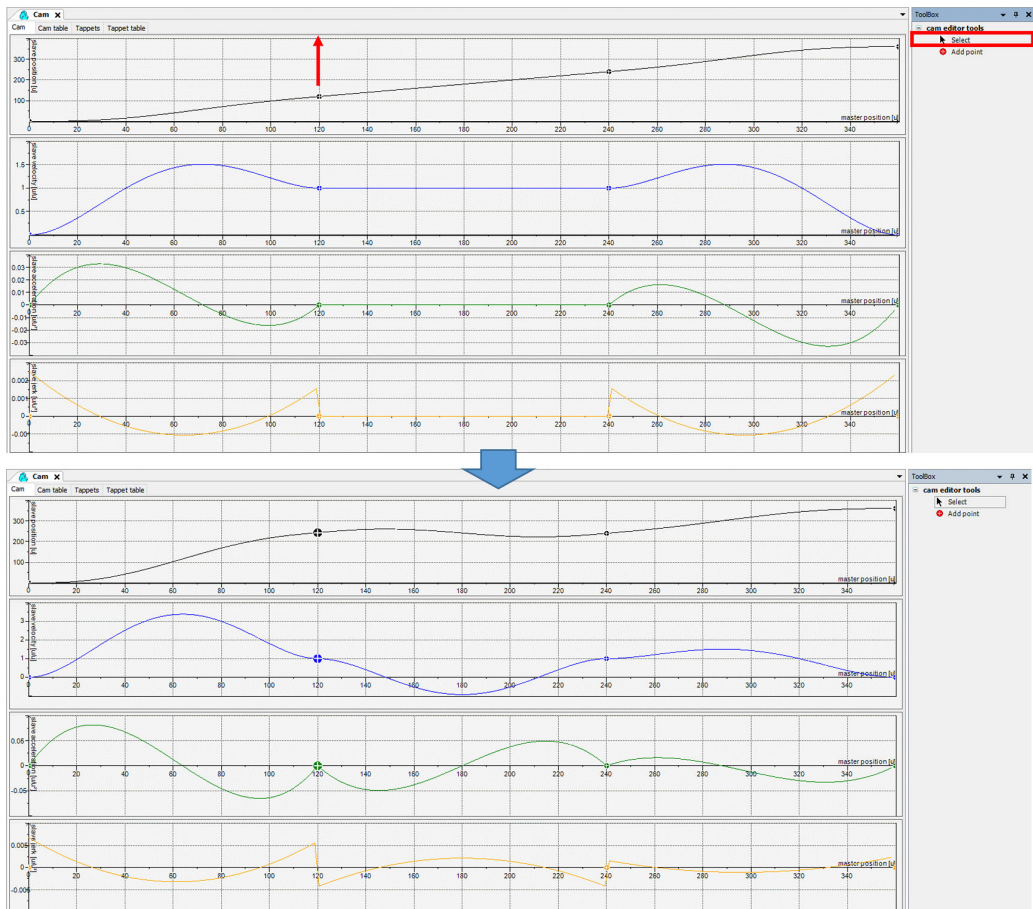

If you want change another part other than existing points, you must add a point to the path. Select “Add point” in Toolbox and then select a place on the path to which you want to add the point. The added point can be handled in the same way as points set by default.

9.7 Cam synchronous Control

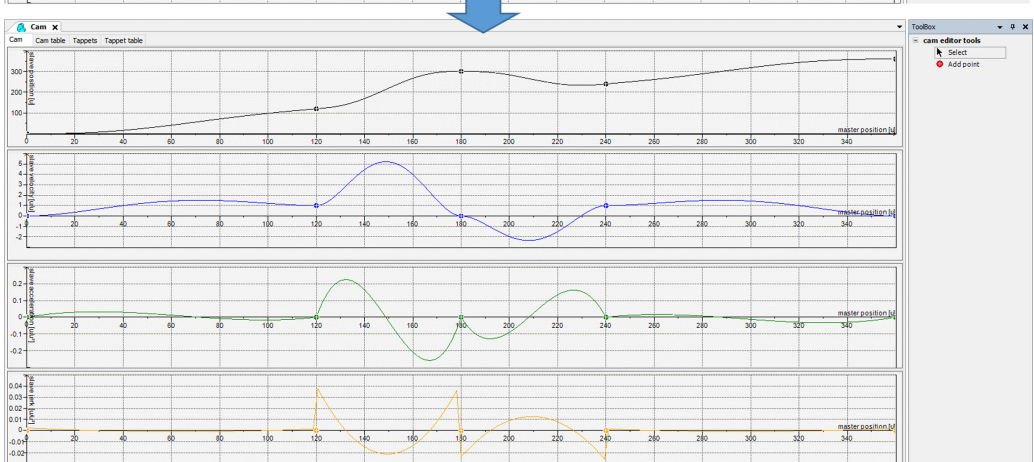
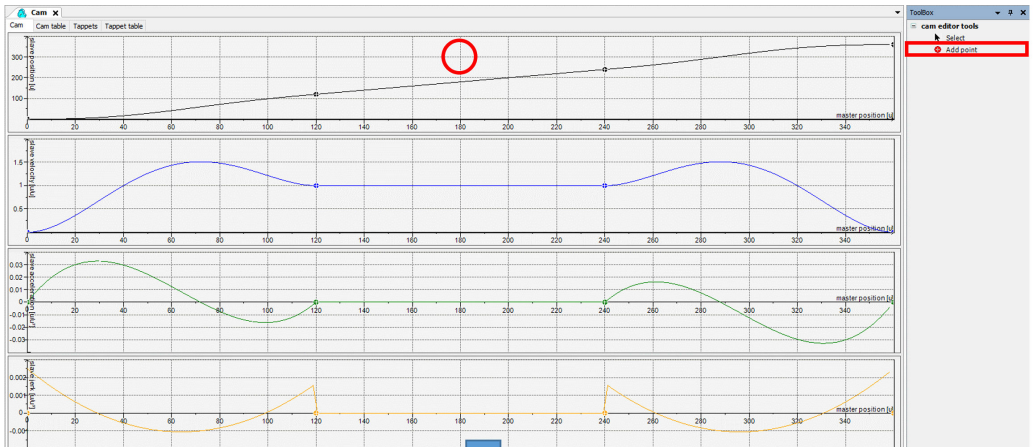



To edit the path on the “Cam table” tab, directly enter values. Entered values will also be reflected in graphs in the “Cam” tab.

Cam X											
Cam	Cam table	Tappets	Tappet table				Segment Type	min(Position)	max(Position)	max(Velocity)	max(Acceleration)
	X	Y	V	A	J						
	0	0	0	0	0		Poly5	0	120	1.5120000000000007	0.032835282941414162
	120	120	1	0	0		Poly5	120	240	1	0
	240	240	1	0	0		Poly5	240	360	1.512	0.032835282941414141
	360	360	0	0	0						

Cam X											
Cam	Cam table	Tappets	Tappet table				Segment Type	min(Position)	max(Position)	max(Velocity)	max(Acceleration)
	X	Y	V	A	J						
	0	0	0	0	0		Poly5	0	100	1.2358124999999995	0.02501458120942996
	120	100	1	0	0		Poly5	100	240	1.3125	0.00801875373874481
	240	240	1	0	0		Poly5	240	360	1.512	0.032835282941414141
	360	360	0	0	0						

9.7 Cam synchronous Control

To add a point, click the  mark at a place where you want to add it. To delete the point, click the  mark. Note that after a change is made, segment types are automatically revised to ensure continuity.

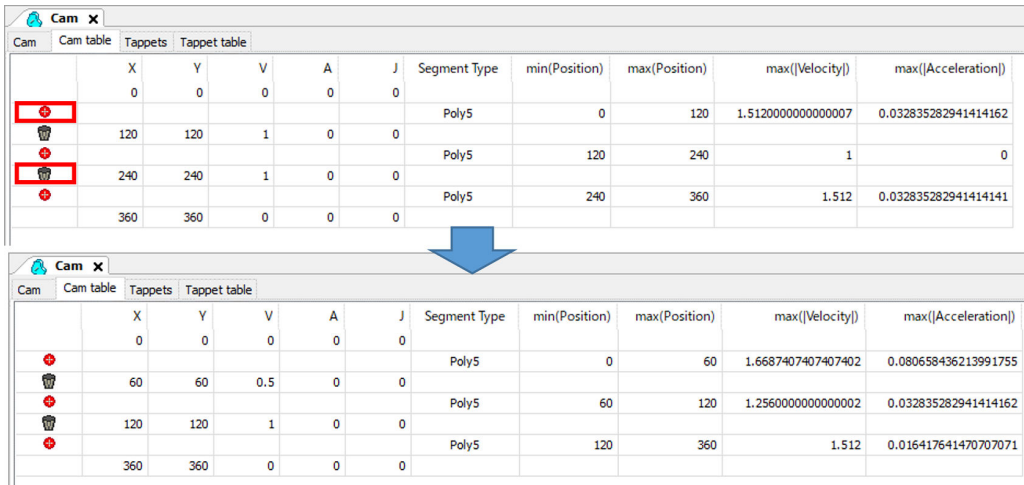

Cam	Cam table	Tappets	Tappet table	X	Y	V	A	J	Segment Type	min(Position)	max(Position)	max(Velocity)	max(Acceleration)
				0	0	0	0	0					
				120	120	1	0	0	Poly5	0	120	1.5120000000000007	0.032835282941414162
				240	240	1	0	0	Poly5	120	240	1	0
				360	360	0	0	0	Poly5	240	360	1.512	0.032835282941414141

Cam	Cam table	Tappets	Tappet table	X	Y	V	A	J	Segment Type	min(Position)	max(Position)	max(Velocity)	max(Acceleration)
				0	0	0	0	0	Poly5	0	60	1.6687407407407402	0.080658436213991755
				60	60	0.5	0	0	Poly5	60	120	1.2560000000000002	0.032835282941414162
				120	120	1	0	0	Poly5	120	360	1.512	0.016417641470707071
				360	360	0	0	0					

Item	Description
X	Sets the position of the master axis.
Y	Sets the position of the slave axis.
V	Sets the velocity of the slave axis.
A	Sets the acceleration of the slave axis.
J	Sets the jerk of the slave axis.
Segment type	Sets an interpolation format for the path between the points. <ul style="list-style-type: none"> • Poly5: Interpolates data by a fifth degree polynomial. This enables smooth connection in position and velocity. • Line: linearly interpolates slave position. The slave velocity gets constant.
min(Position)	Minimum slave position between the points is calculated.
max(Position)	Maximum slave position between the points is calculated.
max(Velocity)	Maximum slave velocity (absolute value) between the points is calculated.
max(Acceleration)	Maximum slave axis acceleration (absolute value) between the points is calculated.

Info.

- When a path is edited, the position, velocity, acceleration, and jerk are each changed accordingly irrespective of the edited parameter.
- Editable parameters differ depending on the segment type. Editable parameters are as shown in the following table.

	Segment type	
	Poly5	Line
X	Editable	
Y	Editable	
V	Editable	Not editable
A	Editable	Not editable
J	Not editable	
min(Position)	Automatic computation	
max(Position)	Automatic computation	
max(Velocity)	Automatic computation	
max(Acceleration)	Automatic computation	

• Smooth transition setting

When a cam table is edited with the “Smooth transition” setting enabled, the position, velocity, and acceleration values are each automatically changed such that the slave axis parameters are continuous at the start and end points of the path. Whether the slave axis parameters at the start and end positions of the master axis match is checked to determine continuity.

The “Slave period” setting is set to a period for the slave position. The position of the slave axis returns to 0 when the position reaches the “Slave period” setting. In other words, the position of the slave axis is offset by a constant times the “Slave period” setting in some cases.

The following is an example in which the position settings (0, 0) are changed to (0, 250).

Smooth transition = Enabled, Slave period = 360

When the point is moved from the positions (0, 0) to (0, 250) on the “Cam” tab, the path changes accordingly such that the slave position represents the same value at the start and end points on the Cam table (master position). At this time, the (X, Y) values on the “Cam table” tab are also updated to (360, 250).

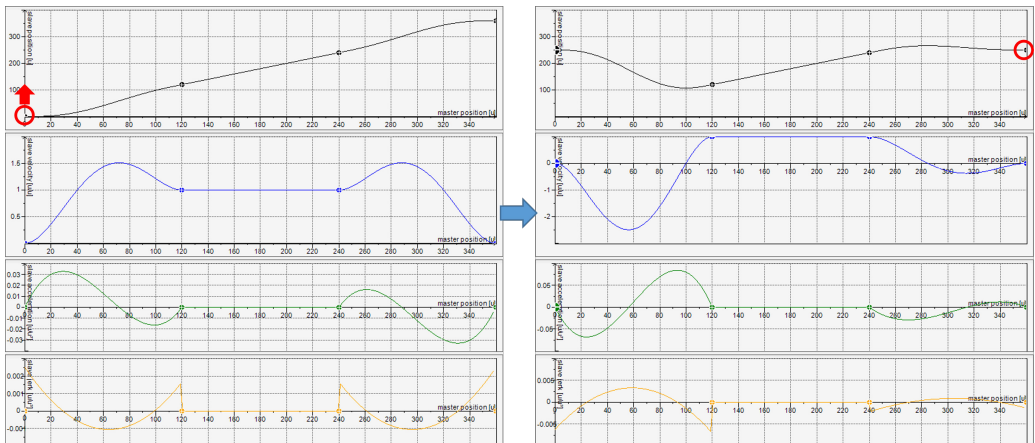

When the positions (X, Y) = (0, 0) are changed to input values (0, 250) on the “Cam table” tab, values (X, Y) = (360, 360) are changed to (360, 250) to update the slave position.

9.7 Cam synchronous Control

	X	Y	V	A	J
	0	250	0	0	0
+					
+	120	120	1	0	0
+	240	240	1	0	0
+	360	360	0	0	0

→

	X	Y	V	A	J
	0	250	0	0	0
+					
+	120	120	1	0	0
+	240	240	1	0	0
+	360	250	0	0	0

Smooth transition = Enabled, Slave period = 100

When the point is moved from the positions (0, 0) to (0, 250) on the “Cam” tab, in the same way as the case in which the Slave period is set to 360, the path and values on the “Cam table” tab are updated such that the slave position is continuous at the start and end points on the Cam table. The updated values (X, Y) = (360, 250).

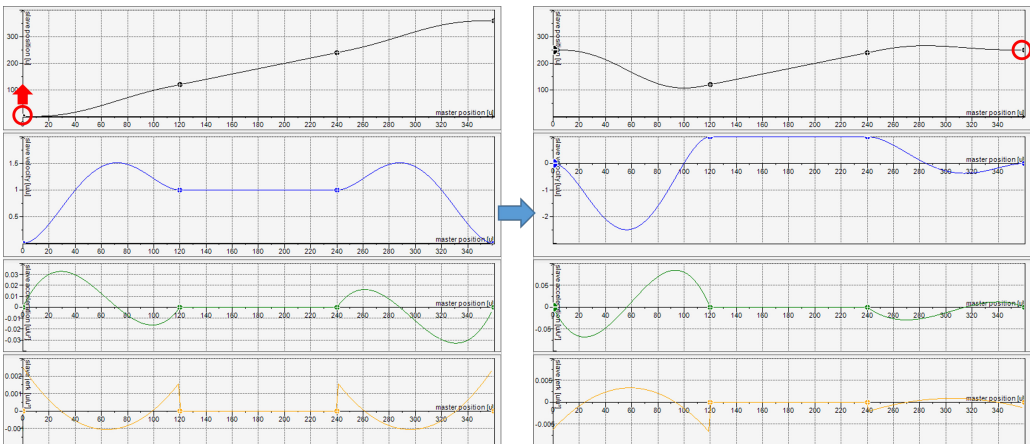

On the “Cam” tab, the slave position changes accordingly so as to represent the same value. However, on the “Cam table” tab, the slave position does not necessarily represent the same value but may differ by a constant times the “Slave period” setting.

When the positions (X, Y) = (0, 0) are changed to input values (0, 250) on the “Cam table” tab, values (X, Y) = (360, 360) are updated to (360, 350) such that the slave position is continuous. Since the Slave period is set to 100 in this case, the slave position represents $350 = 250 + 100$ (= 100 × 1 cycle of the Slave period). In other words, the slave position is considered to be moved ahead by one Slave period to a point of 250 and is determined to be continuous despite the different values.

	X	Y	V	A	J
	0	250	0	0	0
+					
+	120	120	1	0	0
+	240	240	1	0	0
+	360	360	0	0	0

→

	X	Y	V	A	J
	0	250	0	0	0
+					
+	120	120	1	0	0
+	240	240	1	0	0
+	360	350	0	0	0

5. To change tappets on the “Tappets” tab, use Toolbox.

Select “Add tappet” in Toolbox and then select a place to which you want to add a tappet with a track ID. The tappet is added to the place at which you click the mouse. If you add a tappet to a track ID with which no tappet is present, a new track ID is created.

The tappet position and switch operation can be changed using “Select” in Toolbox. To delete a tappet, select the tappet you want to delete with the “Select” tool and then press the “Del” key.

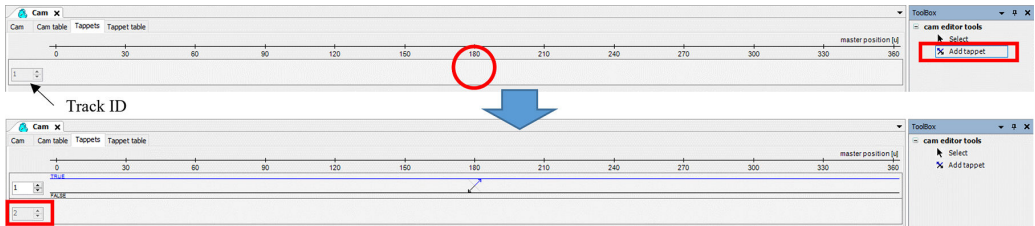

In the same way as paths, settings for tappets can be configured by entering numerical values, for example, through use of “Tappet table”.

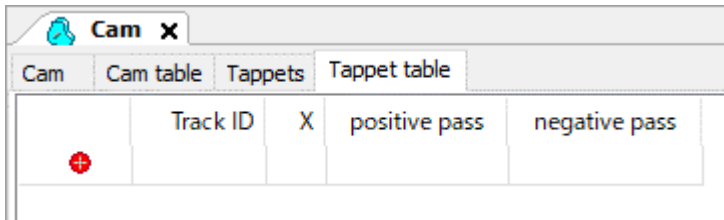











Item	Description
Track ID	Sets an ID of the tappet path. All tappets of a shared track ID refer to the same tappet switching (a variable of the BOOL type). Up to 99 track IDs can be set within a range of 1 to 99.
X	Sets the position of the tappet. Up to three tappets can be specified for a shared point X irrespective of track ID. If four or more tappets are specified, an error occurs during cam synchronous control.
Positive pass	Sets action of the tappet performed when the axis passes through the position of the tappet in positive direction.
Negative pass	Sets action of the tappet performed when the axis passes through the position of the tappet in negative direction.

The following table shows tappet switch varieties. On the “Tappets” tab, you can switch the attribute of a tappet between ON and OFF by clicking the arrow part of the tappet symbol you want to switch.

Positive pass	Negative pass	Symbol
No action	No action	
Switch to ON	No action	
Switch to OFF	No action	
No action	Switch to ON	
No action	Switch to OFF	
Switch to ON	Switch to ON	

9.7 Cam synchronous Control

Positive pass	Negative pass	Symbol
Switch to ON	Switch to OFF	
Switch to OFF	Switch to ON	
Switch to OFF	Switch to OFF	
Invert	No action	
No action	Invert	
Switch to ON	Invert	
Invert	Switch to ON	
Invert	Switch to OFF	
Switch to OFF	Invert	
Invert	Invert	

Info.

- Up to 300 tappets can be used.

Creating MC_CAM_REF by Extended Cam Editor

This section explains how to add a cam object and how to create MC_CAM_REF.

1 2 Procedure

1. Right-click the “Application” object in the navigation pane and then select **Add Object>Extended Cam Table** from the context-sensitive menu that is displayed. The “Add cam table” dialog box will be displayed.

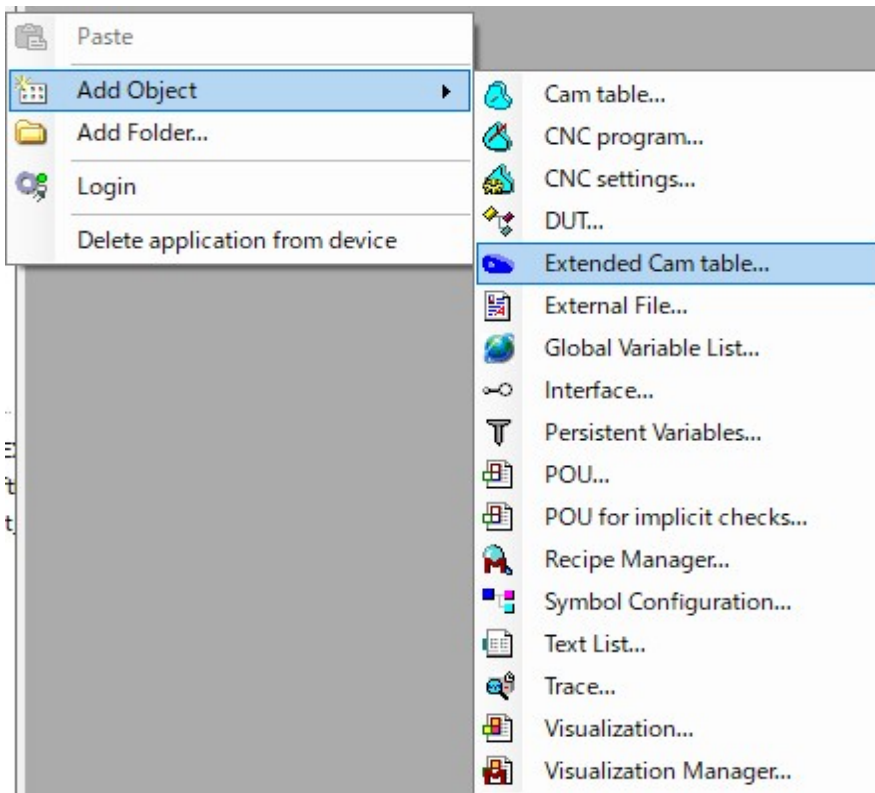

2. Enter a cam table name and then click the [Add] button.
The name specified here will be used for an entry in a function block.

9.7 Cam synchronous Control

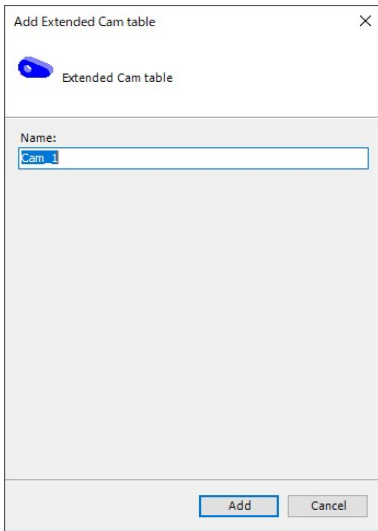

- When the cam object is added, the “Cam” tab appears. Change the default path setting if necessary. The “Cam” tab consists of a graph area and a table area.

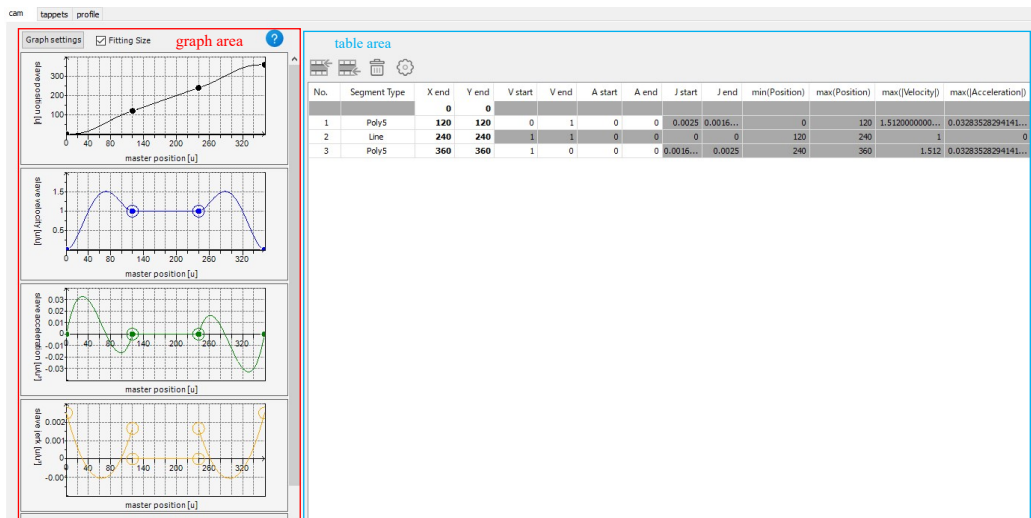

In the graph area, the following four items are displayed one by one in a vertical direction: position, velocity, acceleration, and jerk of a slave (vertical axis) relative to the master position (horizontal axis).

The [Graph setting] button is used to set the interval between graduations for the master position and also the maximum and minimum values of the slave graduations.

When the [Automatic adjustment] check box is enabled, the graph area size is automatically adjusted to match the window size.

Press the [?] button, and a dialog box that explains nodes will be displayed.

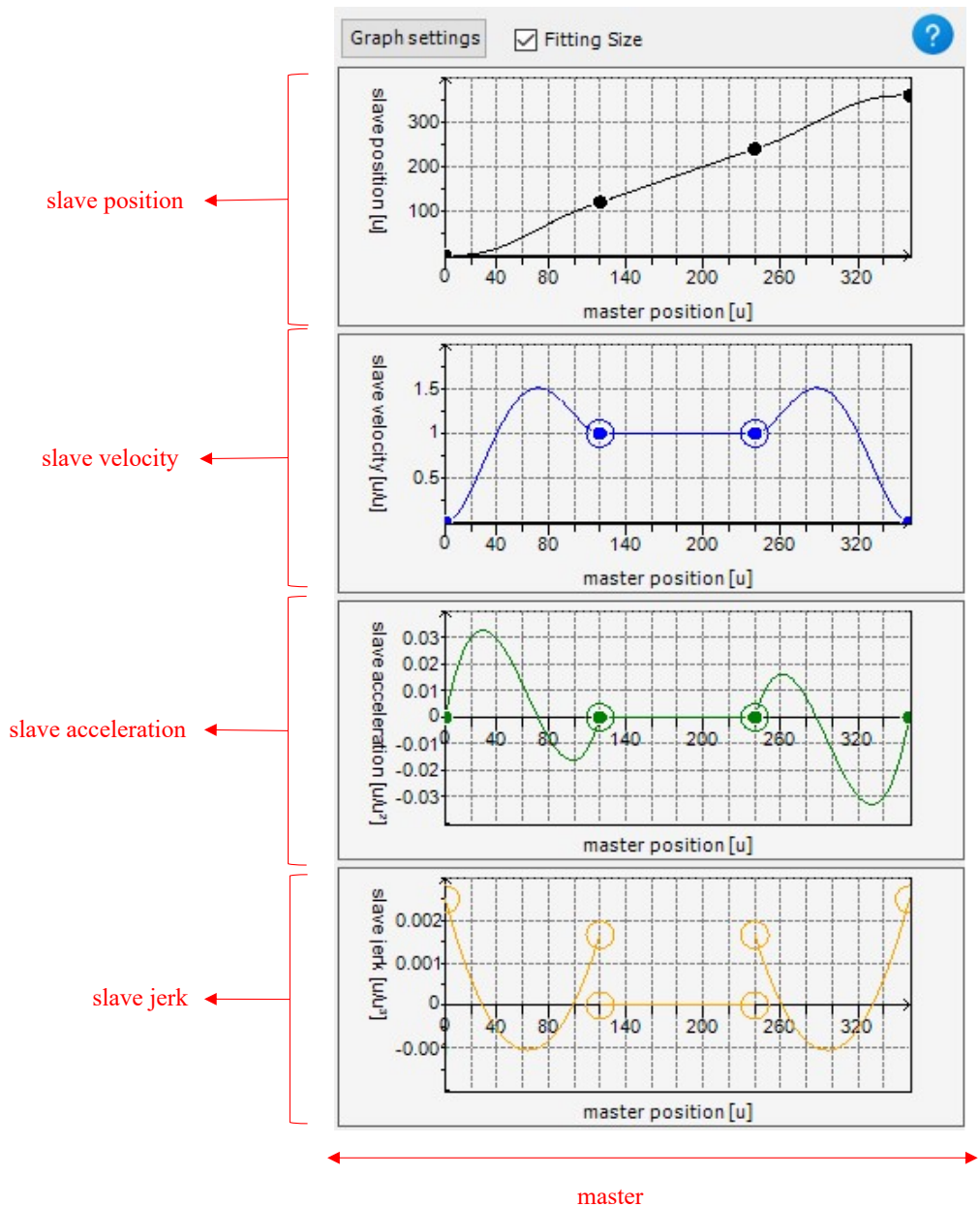

In the table area, numerical values that corresponds with graphs in the graph area are displayed.

No.	Segment Type	X end	Y end	V start	V end	A start	A end	J start	J end	min(Position)	max(Position)	max(Velocity)	max(Acceleration)
		0	0										
1	Poly5	120	120	0	1	0	0	0.0025	0.0016...	0	120	1.5120000000...	0.03283528294141...
2	Line	240	240	1	1	0	0	0	0	120	240	1	0
3	Poly5	360	360	1	0	0	0	0.0016...	0.0025	240	360	1.512	0.03283528294141...

4. [Cam Table Property Setting]

9.7 Cam synchronous Control

Right-click the “Cam” object and then select “Properties” from the context-sensitive menu that is displayed.

In the Properties window, click the “Cam” tab and change the values.

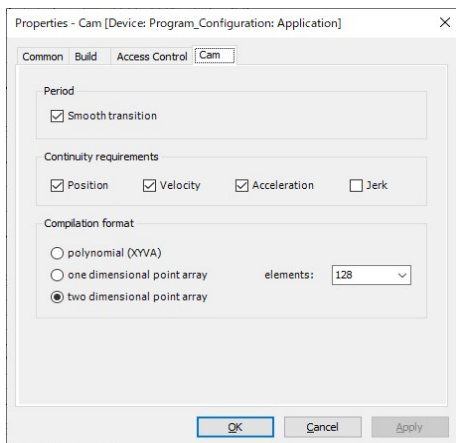

Item		Corresponding variables in MC_CAM_REF	Description
Transition	Smooth transition	-	Enabled: When a path is edited, the path is automatically adjusted such that the velocity and acceleration values of the slave axis at the start position and end position of the master axis are continuous.
Continuous condition check	Position, velocity, acceleration, and jerk	-	Continuity of parameters for which the check box is selected (whether data before and after the representative point is continuous) is checked during build.
Compile format ^(Note 1)	Polynomial (XYVA)	byType = 3	A cam table is made up of master position, slave position, slave velocity, and slave axis acceleration items. This compile format can be selected only for the segment type that can be expressed in polynomial form. Details will be described later in Section 12.3.
	One dimensional point array	byType = 1	A cam table is made up of only a slave position item. (master position is divided into equal intervals by the number of elements.)
	Two dimensional point array	byType = 2	A cam table is made up of master position and slave position items.
	Elements	-	This can be used for one dimensional and two dimensional point arrays. Specifies the number of elements that make up the array.

(Note 1) For details, refer to the GM1 Series Reference Manual (Instruction Edition).

- Smooth transition setting

When a cam graph or table is edited with the “Smooth transition” setting enabled, the path is automatically adjusted such that the velocity and acceleration values of the slave axis at the start position and end position of the master axis are continuous. Whether the slave axis parameters at the start and end positions of the master axis match is checked to determine continuity.

The following is an example in which (master axis position, slave axis velocity) settings are changed from (0, 0) to (0, 1.4). In the graph for the slave axis velocity, when the node (master axis position, slave axis velocity) is moved from (0, 0) to (0, 1.4), the path changes accordingly such that the slave velocity represents the same value at the start and end points of the master axis position. At this time, the values in the table area are also updated in conjunction with the graphs.

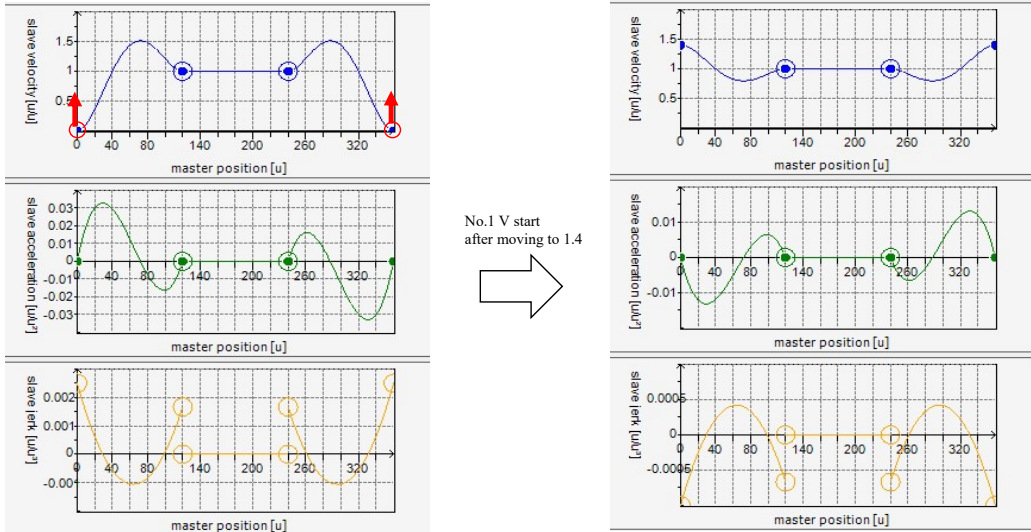





In the table area, if the start point Vstart is changed from 0 to 1.4, the end point Vend is also updated from 0 to 1.4.

No.	Segment Type	X end	Y end	V start	V end	A start	A end
		0	0				
1	Poly5	120	120	1.4	1	0	0
2	Line	240	240	1	1	0	0
3	Poly5	360	360	1	1.4	0	0

5. Moving Node on a Graph

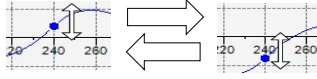
The node can be moved by operating the mouse. It cannot be moved beyond ±999,999.

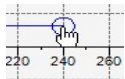
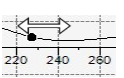
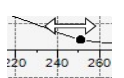
9.7 Cam synchronous Control

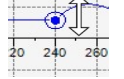
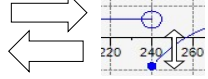
Node	Characteristic	Operation Of Dragging Nodes	<Shift>key + Operation Of Dragging Nodes
 Movable Node	The value of the slave axis can be changed	Drag Down  Drag Up	The value of the master axis can be changed. Only the slave axis position graph can be dragged left and right, but the result of the change is also reflected in the velocity, acceleration, and jerk of the slave axis.
 Fixed Node	The value of the axis cannot be changed	Can't move up or down 	Drag Right  Drag Left 
 Mixed Node	Has the Characteristic of an active node on one side and a fixed node on the other side	Drag Down(Separation)  Drag movable node up(sorption) 	

6. Addition or Deletion of Segments in the Table Area

Segments can be added to or deleted through operations in the table area.

Select a row and then click the button at the top of the table area or select an item from the menu displayed when the row is right-clicked.

“Delete” can be executed simultaneously on multiple rows.

The settings are enabled when “Floating Trapezoid” is selected as a segment type. For details, refer to ““Floating Trapezoid””.

Button

Insert Up Insert Down Delete Setting



No.	Segment Type	X end	Y end	V start
		0	0	
1	Poly5	120	120	1.4
2	Line	240	240	1
3	Poly5	360	360	1

Right-click menu

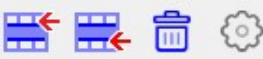

No.	Segment Type	X end	Y end	V start
		0	0	
1	Poly5	120	120	1.4
2	Line	240	240	1
3	Poly5	360	360	1

Insert Up

Insert Down

Delete

The newly added segment is in an unconfirmed state right after the addition as shown in the figure below.

Entry to items other than “Segment type”, “Xend”, and “Yend” is prohibited.

Indeterminate segment

No.	Segment Type	X end	Y end	V start	V end	A start	A end	J start	J end
		0	0						
1	Poly5	120	120	0	1	0	0	0.0025	0.0016...
2									
3	Line	240	240	1	1	0	0	0	0
4	Poly5	360	360	1	0	0	0	0.0016...	0.0025

Once you enter values in “Segment type”, “Xend”, and “Yend” for the unconfirmed segment, the segment becomes a confirmed state and the entry prohibited state is cleared.

No.	Segment Type	X end	Y end	V start	V end	A start	A end	J start	J end
		0	0						
1	Poly5	120	120	0	1	0	0	0.0025	0.0016...
2	Poly3	200	200	1	1	0	0	0	0
3	Line	240	240	1	1	0	0	0	0
4	Poly5	360	360	1	0	0	0	0.0016...	0.0025

7. Editing segments

To edit a segment, enter numerical values in the table cells with white background and then press the <Enter> key.

i Info.

- The range of numerical values that can be entered is between -999,999 and 999,999.
- When the segment is edited, the graph area is updated in conjunction with the edited contents.
- The following table shows a list of segment editing and display items.

Column name	Description
Segment type	Specify the curve type of each segment. Curve types will be described later in Section "9.7.3 Types and Setting of Cam Curves".
Xend	Indicates the master axis position at the end point of a segment. The start point of the next adjacent segment is at the same master axis position.
Yend	Indicates the slave axis position at the end point of a segment. The start point of the next adjacent segment is at the same slave axis position.
Vstart	Indicates the slave axis velocity at the start point of a segment.
Vend	Indicates the slave axis velocity at the end point of a segment.
Astart	Indicates the slave axis acceleration at the start point of a segment.
Aend	Indicates the slave axis acceleration at the end point of a segment.
Jstart	Indicates the slave axis jerk at the start point of a segment.
Jend	Indicates the slave axis jerk at the end point of a segment.
max(Position)	The maximum value of the slave axis position in the segment is displayed.
min(Position)	The minimum value of the slave axis position in the segment is displayed.
max(Velocity)	The maximum value in absolute value of the slave axis velocity in the segment is displayed.

9.7 Cam synchronous Control

Column name	Description
max({Acceleration})	The maximum value of the slave axis acceleration in the segment is displayed.

Items that can be entered vary depending on the segment type.

Details will be described later in Section "9.7.3 Types and Setting of Cam Curves".

Fine font numerical values indicate values calculated automatically and bold font numerical values indicate values manually entered.

If the borders between adjacent segments are both movable nodes, the numerical value entered in one movable node is also reflected on the other node.

If the borders between adjacent segments are mixed nodes (one is movable node and the other is fixed node), the numerical value entered in the movable node is not reflected on the fixed node.

No.	Segment Type	X end	Y end	V start	V end	A start	A end	J start	J end
		0	0						
1	Poly5	120	120	0	1	0	2	0.0525	0.1516...
2	Poly3	200	200	1	1	0	0	0	0
3	Line	240	240	1	1	0	0	0	0
4	Poly5	360	360	1	0	0	0	0.0016...	0.0025

Select a bold numerical value, press the <Delete> key, and then press the <Enter> key to confirm the deletion.

The change made to the node is reset. In the reset cell, an automatically calculated numerical value is displayed in fine font.

Note that Xend and Yend are not automatically calculated. Therefore, set them correctly.

No.	Segment Type	X end	Y end	V start	V end	A start	A end	J start	J end
		0	0						
1	Poly5	120	120	0	1	0	2	0.0525	0.1516...
2	Poly3	200	200	1	1	0	0	0	0
3	Line	240	240	1	1	0	0	0	0
4	Poly5	360	360	1	0	0	0	0.0016...	0.0025



No.1 V end
<Delete>

No.	Segment Type	X end	Y end	V start	V end	A start	A end	J start	J end
		0	0						
1	Poly5	120	120	0	0	0	2	0.0541...	0.1541...
2	Poly3	200	200	0	1	0.05	-0.025	-0.000...	-0.000...
3	Line	240	240	1	1	0	0	0	0
4	Poly5	360	360	1	0	0	0	0.0016...	0.0025

8. Tappet Settings

Since operations of the "Tappet" tab are the same as for the Cam editor, refer to ""Creating MC_CAM_REF by Cam Editor"".

With the Cam editor, tappet and tappet table are displayed under separate tabs. With the Extended Cam editor, they are displayed on the same tab.

File Import/Export Function

The file import/export function can be selected from the menu bar. When using the Cam editor, select the menu from the “Cam” menu, and when using the Ectended Cam editor, select it from the “Ectended Cam” menu.

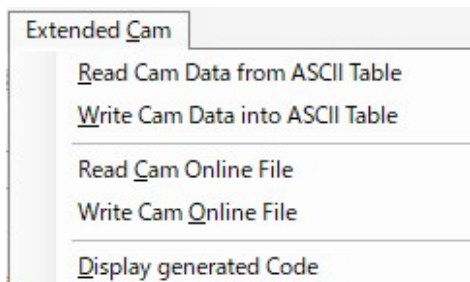

A cam table or a tappet table created by the Cam editor or Ectended Cam editor can be saved and reused by exporting (writing) and importing (reading) files.

On the cam menu, you can use the following items.

Item	Description
Reading cam data from ASCII table	Reads cam data from a text file saved in ASCII table format to create a cam table. The number of cam tables is the number of arrays saved in ASCII table format.
Writing cam data to ASCII table	Saves cam data to a text file in ASCII table format. The maximum number of arrays that can be saved is 100,000. Details will be described later. Information on tappets is not saved.
Reading cam online file	Reads cam data and tappet data from a cam file saved in binary format to create a cam table and a tappet table. A waveform condition that was saved is restored. Cam files created by SMC_WriteCAM cannot be read.
Writing cam online file	Saves cam data and tappet data at the present to a cam file in binary format. Details will be described later. Any saved cam file cannot be read by SMC_ReadCAM.
Showing generated code	This function can be used to display MC_CAM_REF program code created by the Cam editor. The code can be reused in POUs or others by copying & pasting.

9.7 Cam synchronous Control

Info.

- ASCII table format file

An ASCII table format file can be used to read or write master position (X) and slave position (Y) values of a cam table created by the Cam editor. The number of stored points that can be specified is 100,000 or less, and X, Y values of a cam table that are divided by the number of stored points at equal intervals relative to the master position are saved. When an ASCII table format file is read, a cam table is created with the number of points specified when the file was saved.

Velocity, segment type, tappet table, and property settings are not saved. Thus, even when an ASCII table format file is read, a cam table that was written cannot be perfectly reproduced. Note that with an increase in the number of stored points, Cam editor operation speed gets slower despite improved accuracy with which the waveform is reproduced from a read file.

The extension of saved files is .txt. An example of a saved ASCII table format file is shown below.

```
0; 0
      2.8346456692913384; 0.0092022399826652158
      5.6692913385826769; 0.07123944761839393
      ...
```

- Cam online file

A cam online file can be used to read or write cam tables, tappet tables, and information on each profile. By reading a cam online file, a cam table and a tappet table that were saved can be reproduced. To save a cam online file, the file can contain up to 100 cam tables (100 segments). For more than 100 cam tables (100 segments), the system does not operate properly.

Cam online files saved by the Cam editor will have extension of ".cam" and cam online files saved by Ectended Cam editor will have extension of ".gmcam". Be careful that cam online files generated by the Cam editor or Ectended Cam editor are different as shown below.

If you edit the saved Cam online file using a text editor or similar software, it may no longer be correctly loaded by the GM Programmer.

	(* .cam)	(* .gmcam)
Cam editor	R/W (Possible to read or write.)	- (Not possible to read or write.)
Ectended Cam editor	R (Possible to read only.)	R/W (Possible to read or write.)
Information to be saved	<ul style="list-style-type: none"> • Input information of the "Cam table" tab (Note that the segment type is not saved.) • Input information of the "Tappet table" tab • * Input information of the "Properties" dialog box is not saved. 	<ul style="list-style-type: none"> • Input information of the "Cam" tab • Input information of the "Tappet" tab • Input information of the "Cam" tab on the "Properties" dialog box • Input information of the "Profile definitions" tab

9.7.3 Types and Setting of Cam Curves

The following table shows the types of cam curves (segment types) that connect a specified section.

Segment type	Characteristics
Line Linear	The slave velocity stays constant. Used to set a constant velocity section.
Poly3 Cubic polynomial	Used to smoothly connect to adjacent velocity curves.
Poly5 Quintic polynomial	Used to smoothly connect to adjacent velocity or acceleration curves.
Spline 4-3-4 beginning seg. Spline 4-3-4 (Start segment)	Used to create a free curve that is continuously interpolated with splines for the position, velocity, or acceleration.
Spline 4-3-4 Spline 4-3-4 (Middle segment)	
Spline 4-3-4 end seg. Spline 4-3-4 (End segment)	
Floating Trapezoid Floating trapezoid	Used to lower the maximum value of the speed or acceleration within the curve while smoothly connecting to adjacent velocity or acceleration curves.
Rotary Knife A Rotary Knife A	Used to create a cam curve of the rotary knife whose blade edge draws an arc.

The following table shows a summary of applicable items for each segment type.

Segment type	Applicable only to the expansion cam	Specifiable slave axis parameter					Compile format		
		Yend	Vstart	Vend	Astart	Aend	Type=1	Type=2	Type=3
Line Linear	-	○	-	-	-	-	○	○	○
Poly3 Cubic polynomial	○	○	○	○	-	-	○	○	○
Poly5 Quintic polynomial	-	○	○	○	○	○	○	○	○
Spline 4-3-4 beginning seg. Spline 4-3-4 (Start segment)	○	○	○	-	○	-	○	○	○
Spline 4-3-4 Spline 4-3-4 (Middle segment)	○	○	-	-	-	-	○	○	○
Spline 4-3-4 end seg. Spline 4-3-4 (End segment)	○	○	-	○	-	○	○	○	○
Floating Trapezoid Floating trapezoid	○	○	○	○	○	○	○	○	-

9.7 Cam synchronous Control

Segment type	Applicable only to the expansion cam	Specifiable slave axis parameter					Compile format		
		Yend	Vstart	Vend	Astart	Aend	Type=1	Type=2	Type=3
Rotary Knife A ^(Note 1) Rotary Knife A	○	○	-	-	-	-	○	○	-

(Note 1) It cannot be connected to other segments. It can be used only as a single segment.

Line, Poly3, Poly5

A cam curve is generated by a single polynomial.

- Line is a first degree polynomial and keeps the velocity of the slave axis constant. Used to set a constant velocity section.
- Poly3 is a cubic polynomial and can be used to specify the velocity at both ends. Used to smoothly connect to adjacent velocity curves.
- Poly5 is a quintic polynomial and can be used to specify the velocity and acceleration at both ends. Used to smoothly connect to adjacent velocity or acceleration curves.

No.	Segment Type	X end	Y end	V start	V end	A start	A end	J start	J end
		0	0						
1	Poly5	120	120	0	1	-0.0333...	0	0.005	0.0025
2	Line	240	240	1	1	0	0	0	0
3	Poly3	360	360	1	0	0.01666...	-0.033...	-0.000...	-0.000...

9.7 Cam synchronous Control

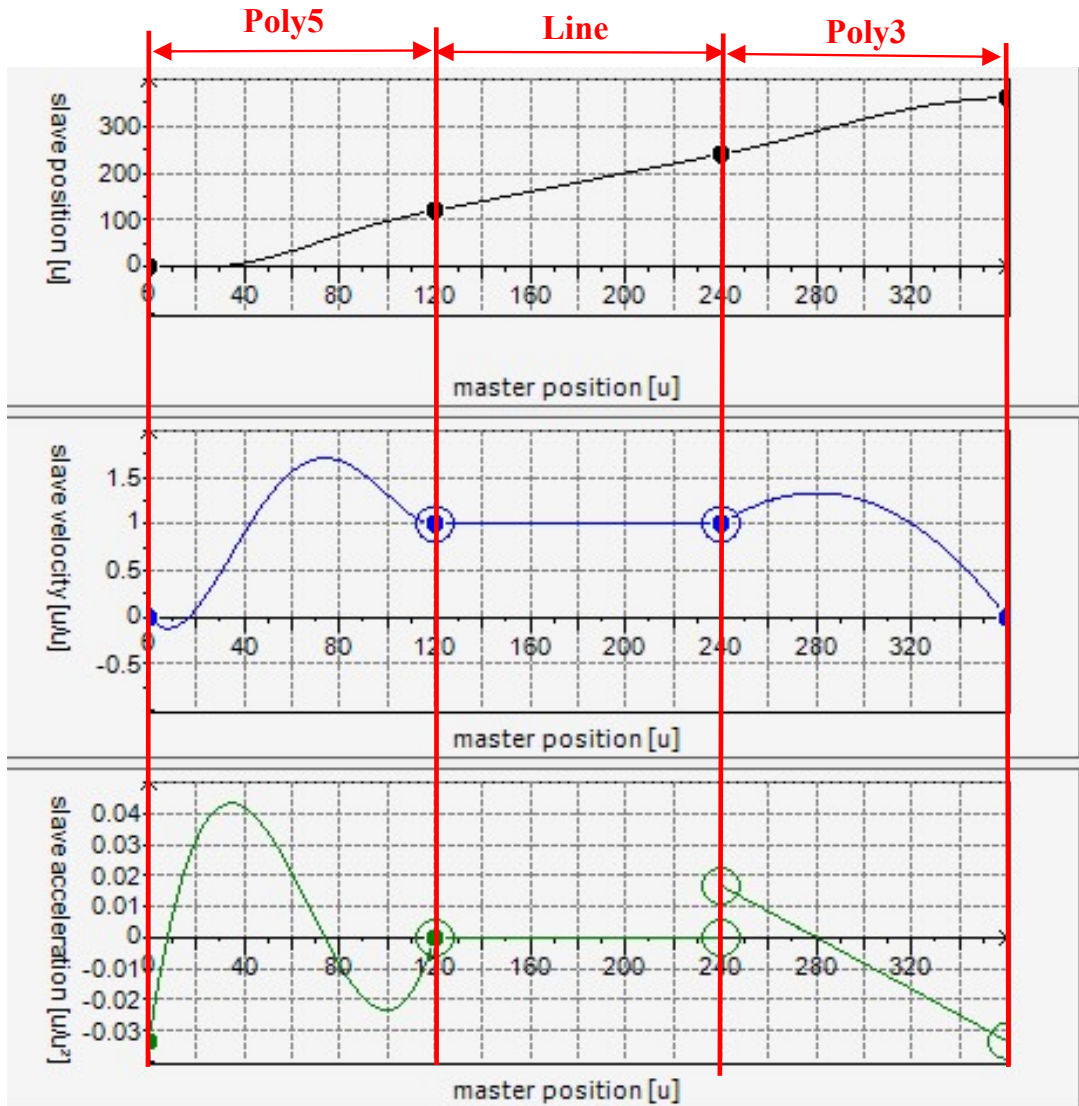

Spline 4-3-4

Used to create a free curve that is continuously interpolated with splines for the position, velocity, or acceleration.

The curve is created by connecting multiple middle segments between the start segment and the end segment.

Since a continuous curve for the velocity or acceleration can be obtained without specifying the velocity or acceleration values, free curves can be created more easily than when connecting multiple Poly5 or Poly3 segments.

Since it is possible to specify the velocity or acceleration for the starting point of the start segment and the ending point of the end segment, you can smoothly connect to other curves.

No.	Segment Type	X end	Y end	V start	V end	A start	A end	J start	J end
		0	0						
1	Spline 4-3-4 begi...	60	30	0	1.2366...	0	0.0236...	0.0012...	-0.000...
2	Spline 4-3-4	120	120	1.2366...	1.3169...	0.02366...	-0.020...	-0.000...	-0.000...
3	Spline 4-3-4	180	180	1.3169...	0.9954...	-0.0209...	0.0102...	0.0005...	0.0005...
4	Spline 4-3-4	240	240	0.9954...	0.7011...	0.01026...	-0.020...	-0.000...	-0.000...
5	Spline 4-3-4	300	280	0.7011...	1.1997...	-0.0200...	0.0366...	0.0009...	0.0009...
6	Spline 4-3-4 end...	360	360	1.1997...	1	0.03669...	-0.01	-0.002...	0.0008...

9.7 Cam synchronous Control

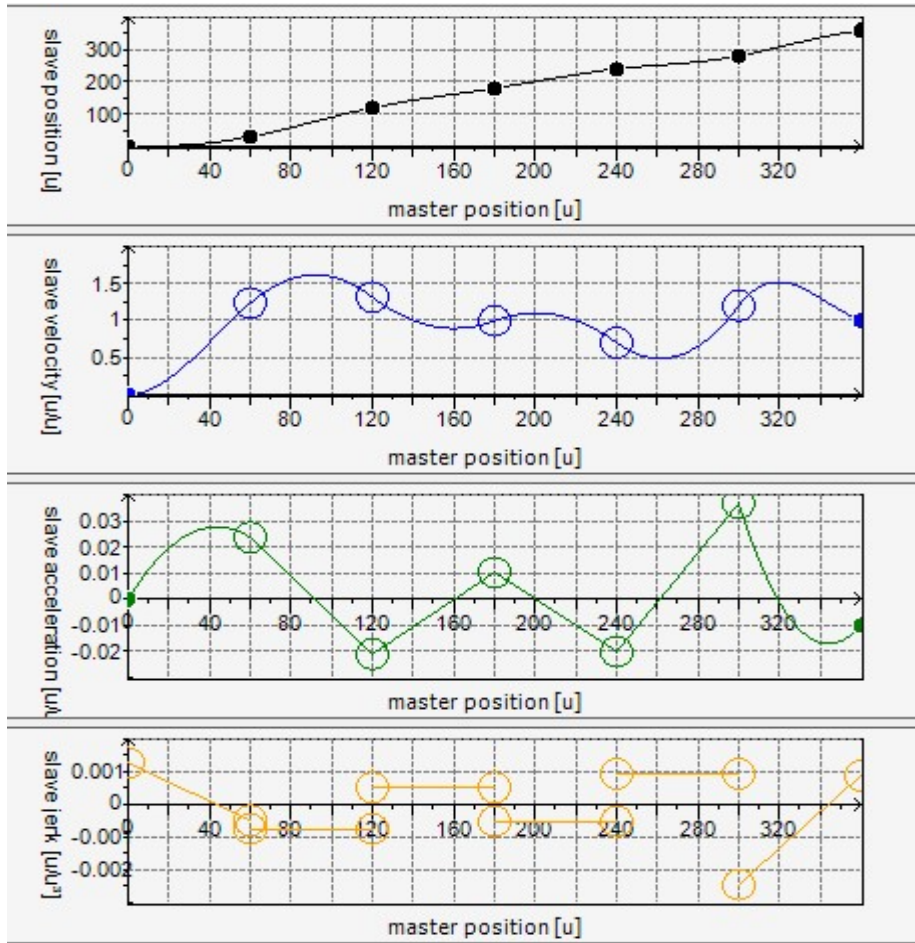

1.2 Procedure

1. If you select "Spline 4-3-4" on the dropdown list for the segment type, one start segment and one end segment are automatically generated.

No.	Segment Type	X end	Y end	V start	V end	A start	A end	J start	J end
		0	0						
1	Spline 4-3-4 begi...								
2	Spline 4-3-4 end...								

2. Enter the Xend and Yend values for the start segment and the end segment to make the segments in the defined state.

No.	Segment Type	X end	Y end	V start	V end	A start	A end	J start	J end
		0	0						
1	Spline 4-3-4 begi...	120	120	0	2	0	0	0.0008...	-0.000...
2	Spline 4-3-4 end...	360	360	2	0	0	0	-0.000...	0.0002...

3. If you add a new segment between the start segment and end segment, a middle segment is generated.

No.	Segment Type	X end	Y end	V start	V end	A start	A end	J start	J end
		0	0						
1	Spline 4-3-4 begi...	120	120	0	2	0	0	0.0008...	-0.000...
2	Spline 4-3-4								
3	Spline 4-3-4 end...	360	360	2	0	0	0	-0.000...	0.0002...

4. Enter the Xend and Yend values for the middle segment to make the segment in the defined state.

No.	Segment Type	X end	Y end	V start	V end	A start	A end	J start	J end
		0	0						
1	Spline 4-3-4 begi...	120	120	0	1.5	0	-0.025	0.0010...	-0.001...
2	Spline 4-3-4	240	240	1.5	1.5	-0.025	0.025	0.0004...	0.0004...
3	Spline 4-3-4 end...	360	360	1.5	0	0.025	0	-0.001...	0.0010...

5. In the same procedure, you can increase middle segments.

No.	Segment Type	X end	Y end	V start	V end	A start	A end	J start	J end
		0	0						
1	Spline 4-3-4 begi...	120	120	0	1.4248...	0	-0.028...	0.0010...	-0.001...
2	Spline 4-3-4	180	180	1.4248...	1.0130...	-0.0287...	0.0150...	0.0007...	0.0007...
3	Spline 4-3-4	240	240	1.0130...	0.5228...	0.01503...	-0.031...	-0.000...	-0.000...
4	Spline 4-3-4	300	280	0.5228...	1.8954...	-0.0313...	0.0771...	0.0018...	0.0018...
5	Spline 4-3-4 end...	360	360	1.8954...	0	0.07712...	0	-0.008...	0.0057...

6. The following table shows behaviors when a segment is deleted or when the segment type is changed.

Target	Deletion of segment	Change of segment type
Start segment	The start segment is deleted and the adjacent middle segment becomes a new start segment.	The change is reflected and the adjacent middle segment becomes a new start segment.
Middle segment	The selected middle segment is deleted.	Not applicable
End segment	The end segment is deleted and the adjacent middle segment becomes a new end segment.	The change is reflected and the adjacent middle segment becomes a new end segment.

Floating Trapezoid

You can specify the velocity and acceleration at both ends. In addition, you can provide a sub section where the velocity is constant or acceleration is constant within the curve.

Used to lower the maximum value of the speed or acceleration within the curve while smoothly connecting to adjacent velocity or acceleration curves.

Set the number of divisions (5 divisions/7 divisions) of sub sections or the length using the Set button at the top of the table area.

The specifications and waveform examples of the sub sections with 5 divisions and 7 divisions are shown below.

5 divisions	7 divisions
<p>< Waveform examples ></p> <p>< Specifications of each sub section ></p> <p>If we name divisions of sub sections as I, II, III, IV, and V in the order starting from the lowest master axis position, the divisions are as follows:</p> <ul style="list-style-type: none"> • I, III, and V: The slave axis acceleration makes a monotonic increase or monotonic decrease. • II and IV: The slave axis acceleration stays constant. 	<p>< Waveform examples ></p> <p>< Specifications of each sub section ></p> <p>If we name divisions of sub sections as I, II, III, IV, V, VI, and VII in the order starting from the lowest master axis position, the divisions are as follows:</p> <ul style="list-style-type: none"> • I, III, V, and VII: The slave axis acceleration makes a monotonic increase or monotonic decrease. • II and VI: The slave axis acceleration stays constant. • IV: The slave axis acceleration is zero, that is, the slave axis velocity stays constant.

12

Procedure

1. Specify "Floating Trapezoid" on the dropdown list for the segment type. When the "Floating Trapezoid" row is selected, the Set button at the top of the table area becomes active.

No.	Segment Type	X end	Y end	V start	V end	A start	A end	J start	J end
		0	0						
1	Poly5	120	120	0	1	0	0	0.0025	0.0016...
2	Floating Trapezoid	240	240	1	1	0	0	3.1329...	3.1329...
3	Poly5	360	360	1	0	0	0	0.0016...	0.0025

- Click the Set button, and the “Trapezoid Setting” dialog box will be displayed. Set the number of divisions of sub sections and the length of each sub section. In conjunction with the operation of the dialog box, the cam curve in the graph area is updated.

5 division selection

7 division selection

Dialog item	Description
① Division setting (radio button)	Select how many sub sections to create by dividing one segment. It is possible to select either 5 divisions or 7 divisions.
② Split setting	Adjust the length of the sub section according to either one of the following operations. <ul style="list-style-type: none"> • Drag the slider. • Enter a numerical value in the “Width” field. The length of the sub section is displayed in a numerical value in the “Width” field. Left-click the slider, and the “Width” fields for the two sub sections divided by the slider will become active to allow you to input numerical values.
③ Schematic diagram	A schematic diagram that shows shape specifications of the sub section is displayed. The diagram switches between 5 divisions and 7 divisions as selected.

9.7 Cam synchronous Control

Dialog item	Description
④ "OK" button	Saves the settings and then closes the dialog box.
⑤ "Cancel" button	Closes the dialog box without saving the settings.
⑥ "Apply" button	Saves the settings.

Creating Rotary Knife A

Used for cam operation where a rotary knife cuts the material moved in one direction.

A cam curve is generated so that the blade edge velocity becomes the same as the cut material velocity in the vicinity of the cutting point. The master axis position is at a position in the feed direction of the cut material and the slave axis position corresponds to the rotation angle of the rotary knife. The interval between one cutting and the next corresponds to one cycle of the cam curve.

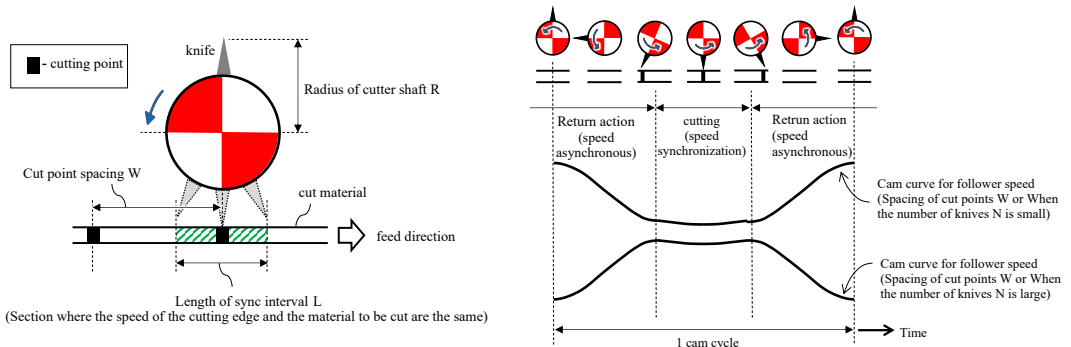

At the midpoint of the cam curve, the blade edge reaches the bottom dead center (a position where the blade cuts the material at the right angle). At the start point and end point of the cam curve, the blade edge is farthest from the bottom dead center.

1.2 Procedure

1. On the "Profile Definition" tab, enter the mechanical dimension parameters of the rotary knife to edit the waveform.

cam tappets profile

Rotary knife A

Project	Value	Unit	Setting/Value	Content
N: Number of Knives	1	-	1 to 10	Set the number of knives. The angle between each knife must be equal.
R: Radius of cutter axis	30.0	mm	1 to 500	Set the rotary cutter axis radius for from the view of its knife tips.
L: Length of synchronization	10.0	mm	$(0.001 * W < L < 0.8 * W)$ && $(L < 1.6 * W)$	Set the length of synchronous section. The knife and cut material have same velocity in the synchronous section.
W: Width between cut points	100.0	mm	1 to 10000	Set the width between cut points.

Illustration of N, R and L

Symbol	Parameter
N	Number of knives
R	Radius of cutter axis
L	Length of synchronization
W	Width between cut points

Illustration of W and L

Illustration of speed profile

9.7 Cam synchronous Control

Rotary Knife A setting parameters (mechanical dimension parameters of the rotary knife)

Setting item	Unit	Setting range	Description
N: Number of knives	-	1 to 10	Set the number of knives. The angle between knives must be equal.
R: Radius of the cutter shaft	mm	1 to 500	Set the cutter shaft radius viewed from the knife tip.
L: Length of the synchronous section	mm	$(0.001*W < L < 0.8*W)$ && $(L < 1.6*R)$	Specify the length of the synchronous section. The knife velocity becomes equal to that of the cut material in this synchronous section.
W: Interval between cut points	mm	1 to 10000	Set the interval between two cut points.

When the entered parameter value is outside the set range, [!] is displayed next to the corresponding parameter. At this time, the parameter is not reflected internally, so enter a correct value.

2. Select "Rotary Knife A" on the dropdown list for the segment type.

An entire cam curve is generated as a single segment. It cannot be combined with other segments.

No.	Segment Type	X end	Y end	V start	V end	A start	A end	J start	J end
		0	0						
1	Rotary knife A	100	100	1.5657...	1.5657...	0	-5.105...	-0.0032...	-0.003...

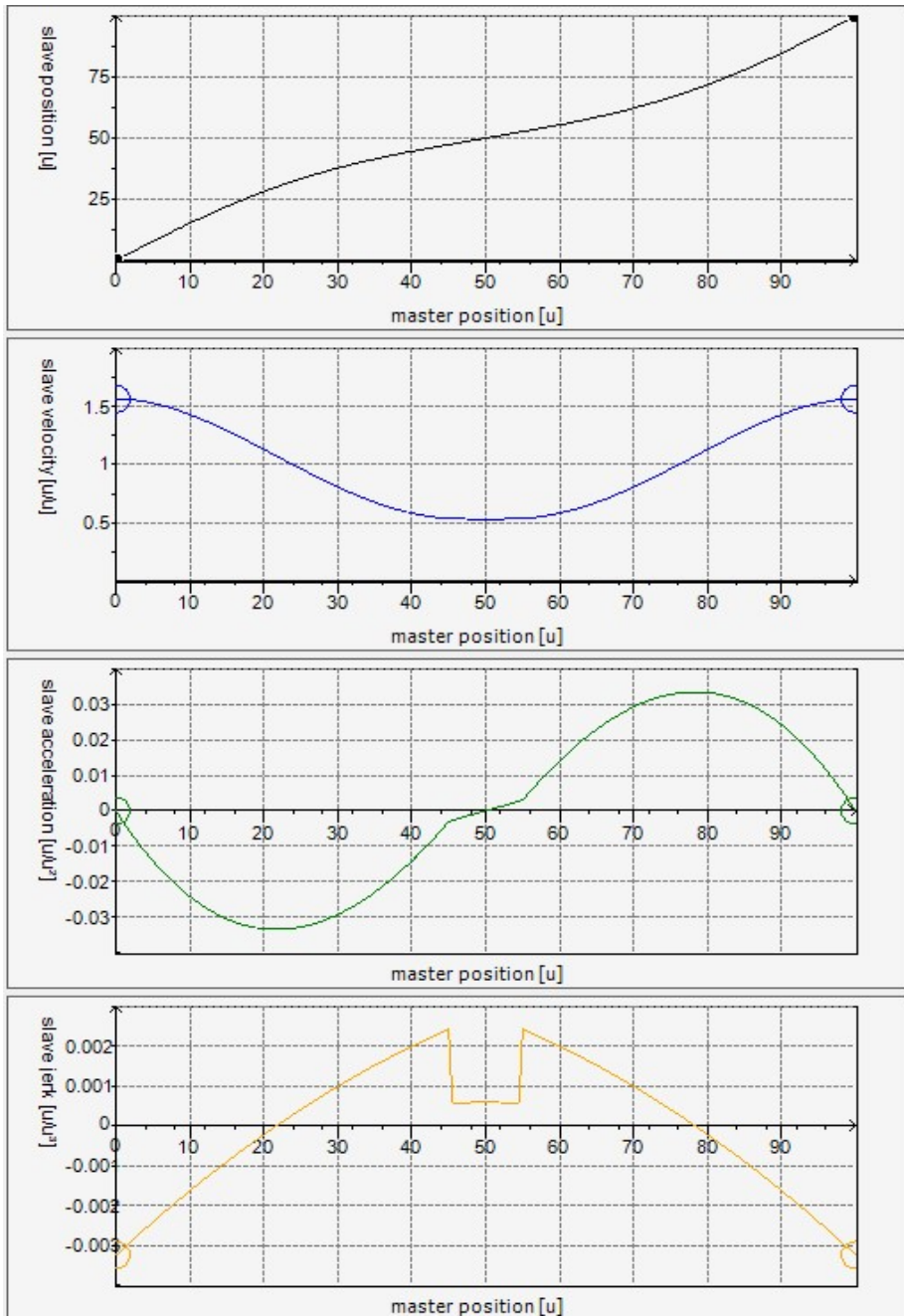

9.7.4 Cam Control (POU Programming)

With the GM1 controller, through use of function blocks, you can perform cam synchronous control of the axes using cam objects.

1 2 Procedure

1. Execute MC_CamTableSelect to specify the master axis, the slave axis, and a cam table (MC_CAM_REF) that is converted into executable format.
2. When MC_CamIn is executed, the slave axis moves in response to the master position in accordance with the cam profile and gets synchronized.
3. To release the cam synchronization, execute MC_CamOut.
4. Moreover, using auxiliary function blocks for cam synchronous control, you can monitor tappet information, check minimum/ maximum values of the slave velocity and acceleration from the cam profile before operation, and read or write cam data.

i Info.

- For details on each function block, refer to the GM1 Series Reference Manual (Instruction Edition).

9.8 CNC Control

9.8.1 Overview of CNC Control and How to Use It

You must execute the following series of processes to perform CNC control with the GM1 controller.

- Create a CNC program written in G-code using the CNC editor or other tools.
- Decode the CNC program to executable format.
- Compute command data from the decoded CNC program at every cycle of motor control to control the motor.

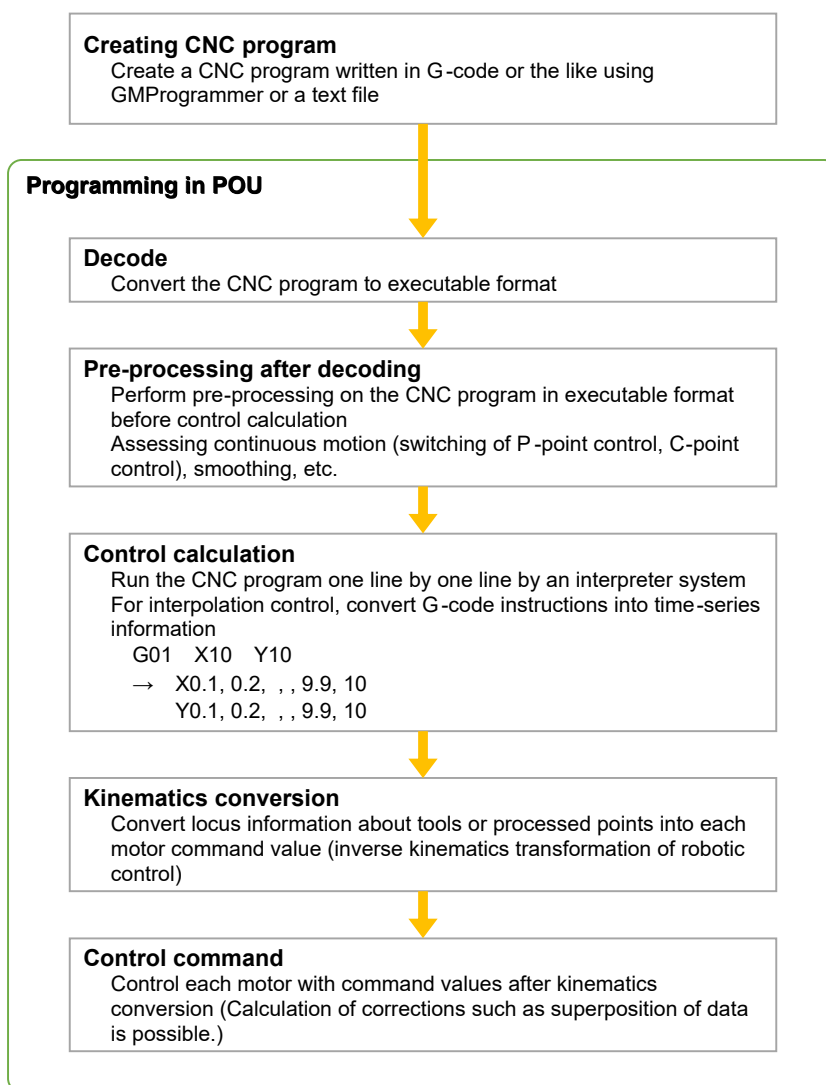

1 2 Procedure

1. Create a CNC program and decode it

A CNC program (SMC_OUTQUEUE type) written in executable format is necessary to program CNC control using GM Programmer. The CNC program in executable format can be created by any of the following three methods.

- After creating a CNC program (SMC_CNC_REF type) using the CNC editor, decoding the CNC program to that of the SMC_OUTQUEUE type by SMC_NCDecoder.
- Creating a CNC program (SMC_OUTQUEUE type) using the CNC editor. The created CNC program is converted into executable format when it is downloaded.
- Reading a CNC file (*.CNC), which is created by a text editor or CAD/CAM, via a SD card using SMC_ReadNCFile2 and decoding the CNC file to that of the SMC_OUTQUEUE type by SMC_NCInterpreter.

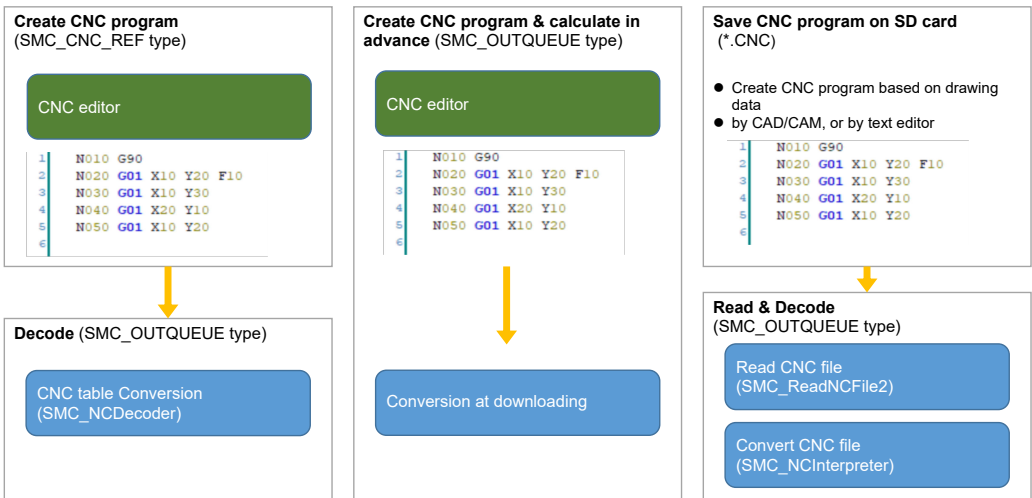

It is necessary to set a compile mode according to the method of CNC program creation. For details on how to create a CNC program using the CNC editor and set a compile mode for the CNC program, refer to "9.8.2 Creating a CNC Program".

2. Programming CNC control in POU

Program a series of the processes from decoding of the CNC program and motor control in POU.

For details about programming CNC control in POU, function blocks, and G-code, refer to the *GM1 Series Reference Manual (Instruction Edition)*.

9.8.2 Creating a CNC Program

You can create a CNC program by writing it with GM Programmer or on a text editor. The description below explains a method using GM Programmer.

Right-click the "Application" object in the navigator pane and then select **Add Object > CNC program** from the context-sensitive menu that is displayed.

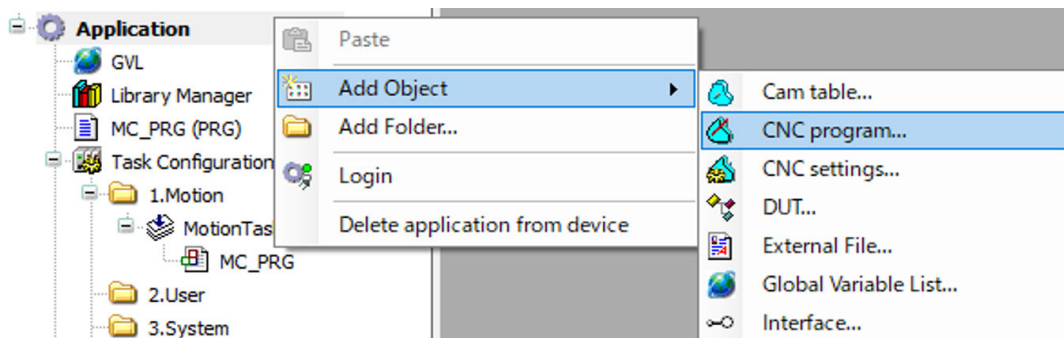

When "CNC program" is selected, the following window is displayed. Specify settings and click [Add].

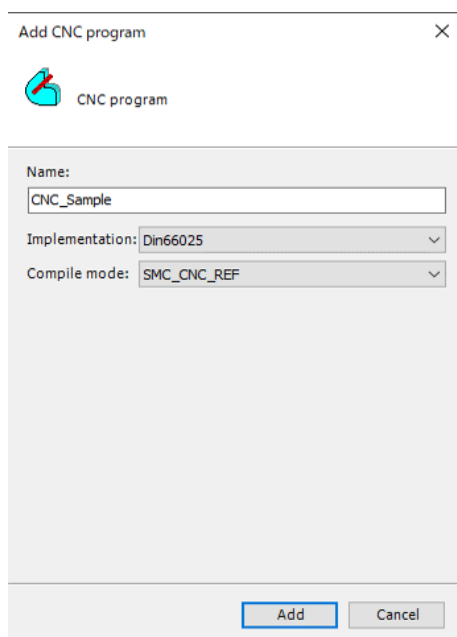

For CNC programs, three compile modes are available. You can select one at the time of creating a table.

Setting item		Description
Name	Settings	Specify a name for a CNC program to be created.
Implementation	Din66025	Your program will be written in text format. Be sure to use this setting.
	Table	Do not use.

9.8 CNC Control

Setting item		Description
Compile mode	SMC_CNC_REF	Normally, use this setting.
	SMC_OUTQUEUE	The movement speed improves due to the prior calculation method, but pre-processing cannot be performed, CNC program settings cannot be changed, and CNC programs cannot be joined together.
	File	CNC programs are generated as external reference files. Even files created by external text editors can similarly work.

When Add is clicked, CNC settings and a CNC program are created in the Device tree. The CNC program is displayed as the name registered earlier (CNC_Sample). The CNC editor and CNC graphic editor are displayed in the right pane of the GM Programmer screen.

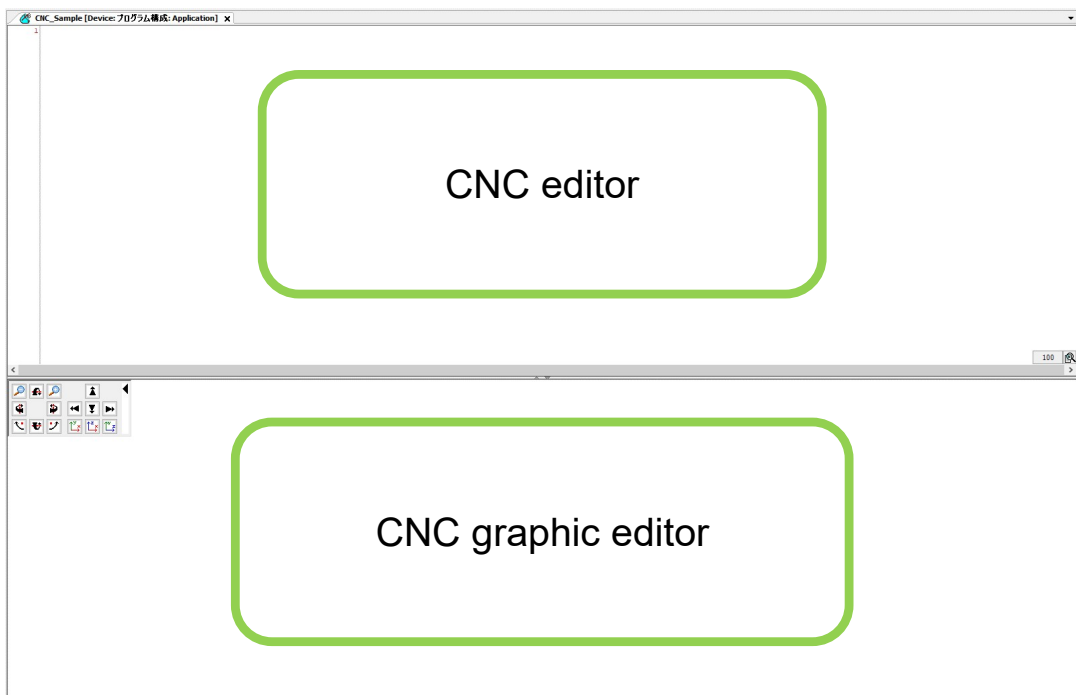

■ CNC editor

Write a CNC program.

For details on the method of writing, refer to the *GM1 Series Reference Manual (Instruction Edition)*.

■ CNC graphic editor

The movement loci coded in the CNC editor are graphically displayed in real time. You can also rotate the display and change the scale.

It is possible to make a change to the loci in the CNC graphic editor, but it should be noted that the change will also be reflected in the code in the CNC editor.

If variables are used in CNC programs, the CNC graphic editor cannot be displayed.

■ "CNC program" - "Properties"

In the Properties window for the CNC program, you can change the compile mode and configure parameter settings.

In the Device tree of GM Programmer, right-click **Application**>**CNC program**>**Properties** in this order.

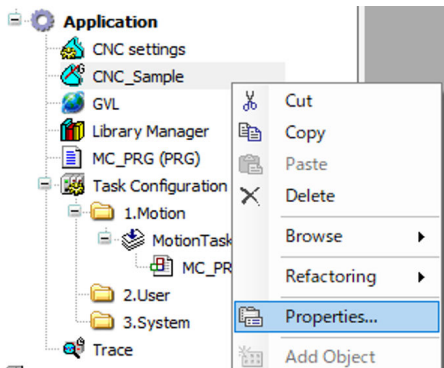

● "CNC" tab

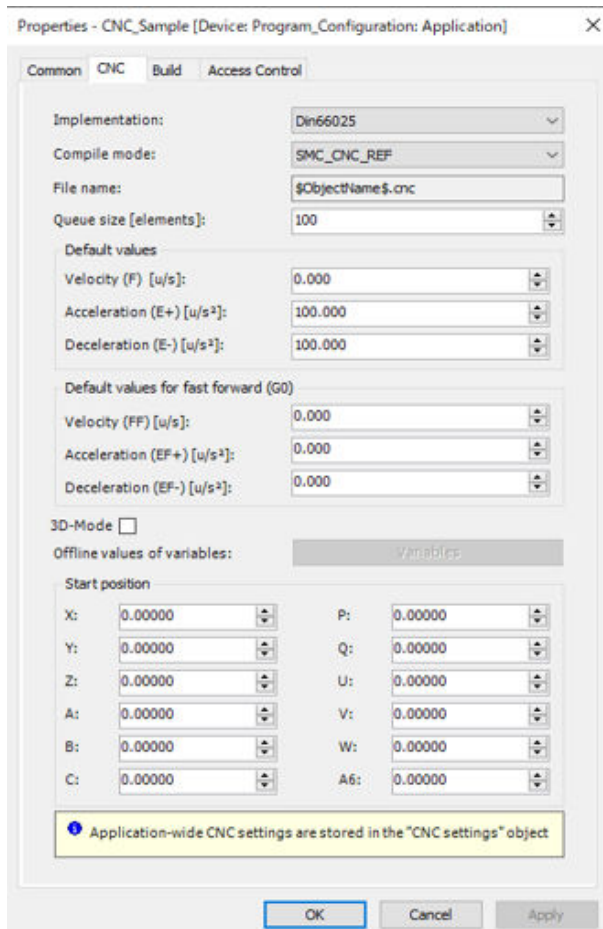

9.8 CNC Control

Setting item		Description
Implementation	Din66025	Your program will be written in text format. Be sure to use this setting.
	Table	Do not use.
Compile mode	SMC_CNC_REF	Normally, use this setting.
	SMC_OUTQUEUE	The movement speed improves due to the prior calculation method, but pre-processing cannot be performed, CNC program settings cannot be changed, and CNC programs cannot be joined together.
	File	CNC programs are generated as external reference files. Even files created by external text editors can similarly work.
File name		If the Compile mode is set to File, the name of the external reference file must be entered.
Queue size		This is the number of CNC program elements managed under SMC_OUTQUEUE at runtime. (Recommended number: 10 to 30)
Default values		Specify default values of the velocity, acceleration, and deceleration for interpolation operation. Unless velocity, acceleration, and deceleration are specified using G-code, interpolation control will be performed using these default values.
Default values for fast forward (G0)		Specify default values of the velocity, acceleration, and deceleration for interpolation operation with G0. Unless velocity, acceleration, and deceleration are specified with G0, interpolation control will be performed using these default values.
3D-Mode		XY 2-axis interpolation control is set by default. To execute XYZ 3-axis interpolation control without G16 to G19 plane specification, make this setting enabled. If the program is executed with an external file, the argument in the function block FB (SMC_ReadNCFile2) serves as the similar setting.
Start position		For the SMC_OUTQUEUE type, specify the coordinates from which interpolation control is to be started.

■ "CNC settings" - Setting window

In the "CNC settings" object added concurrently with the CNC program, you can configure path processing settings for CNC programs created under the SMC_OUTQUEUE type.

- "Path preprocessors" tab

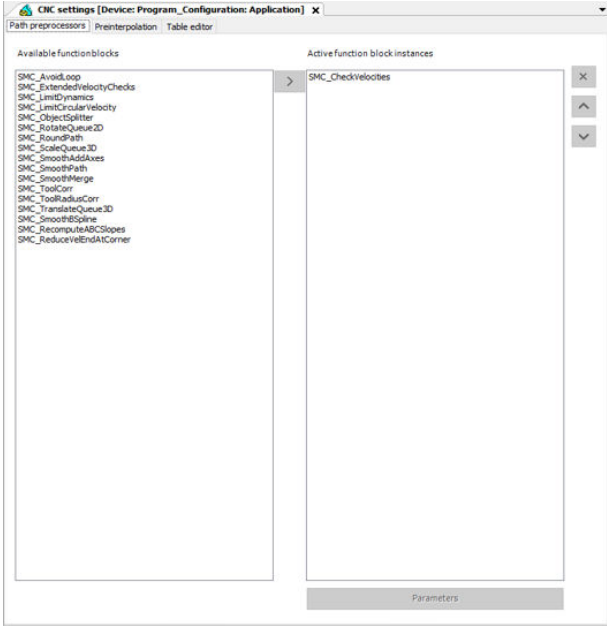

- "Preinterpolation" tab

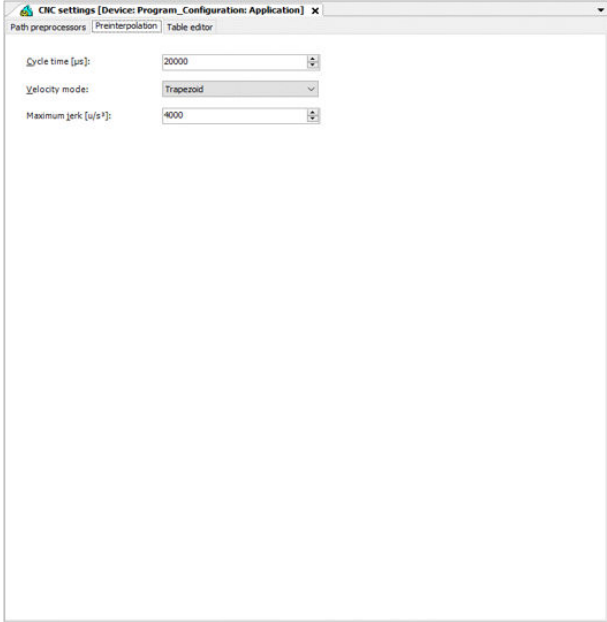

- "Table editor" tab

9.8 CNC Control

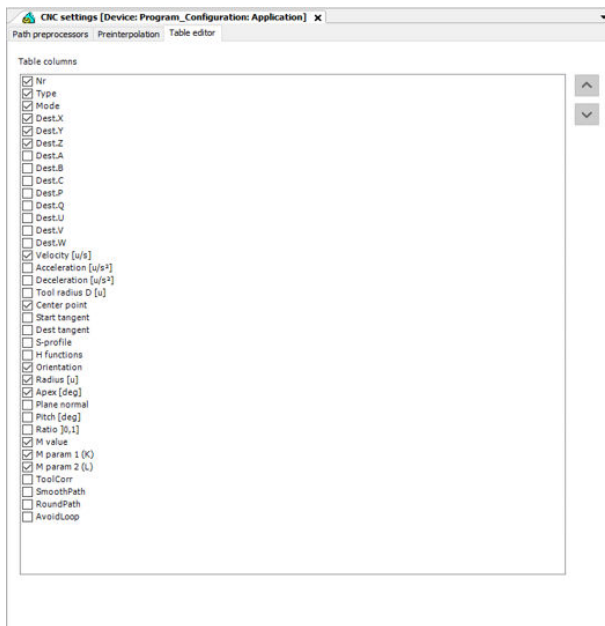

Setting item		Description
Tab name	Settings	
Path preprocessors	-	For SMC_OUTQUEUE type programs, pre-processing is required to be defined here in advance. Even for SMC_CNC_REF type programs or external files, results of pre-processing can be displayed and checked in the CNC graphic editor.
Preinterpolation	Cycle time	Specify time for MotionTask.
	Velocity mode	Specify an acceleration/deceleration profile. The setting can be changed by the argument in SMC_Interpolator when the program is executed.
	Maximum jerk	Specify the maximum jerk value for interpolation control operation. The setting can be changed by the argument in SMC_Interpolator when the program is executed.
Table editor	-	This tab is used to perform CNC in table format. Do not use.

■ CNC menu

When the CNC program editing window is opened, the menu bar displays the "CNC" menu, and you can configure settings for the following items.

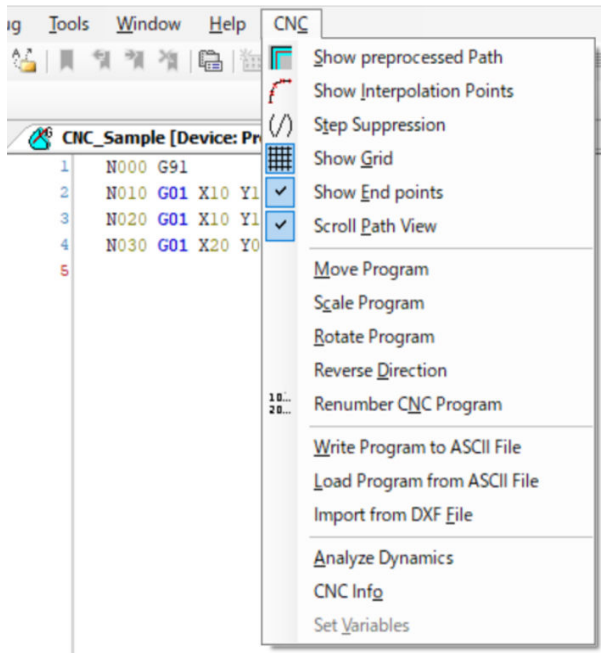

Setting items	Overview
Show preprocessed Path	Select to show or hide the path with preprocessing in the CNC graphic editor.
Show Interpolation Points	Select to show or hide interpolation points in the CNC graphic editor.
Step Suppression	Select to activate or deactivate the step suppression.
Show Grid	Select to show or hide the grid in the CNC graphic editor.
Show End Points	Select to show or hide end points in the CNC graphic editor.
Scroll Path View	If this is activated, the view of the path on a line selected in the CNC editor is automatically scrolled and zoomed such that the path is visible in the CNC graphic editor window.
Move Program	This opens the translation vector dialog box where you can enter movement amounts for the axes. This moves the CNC program along the axes by specified amounts.
Scale Program	This opens the scale program dialog box where you can enter a scaling factor and select a target axis. This scales up or down the CNC program by the specified scaling factor along the selected axis.
Rotate Program	This opens the rotation parameters dialog box where you can enter an angle of rotation and a rotation factor for each axis. This causes the CNC program to rotate about each axis by the specified angle of rotation \times rotation factor.
Reverse Direction	This sets the path elements of the CNC program in reverse order.
Renumber CNC Program	This refreshes the numbering of program lines in the CNC program. The numbers start at 0 and are incremented by 10.
Write Program to ASCII File	This opens the dialog box for saving a file. This causes the CNC program to be saved as an ASCII file.
Load Program from ASCII File	This opens the dialog box for selecting a file. This loads CNC program data from the selected ASCII file.

9.8 CNC Control

Setting items	Overview
Import from DXF File	This opens the "Import DXF File" dialog box. Import data from the DXF file saved with a CAD tool. For details, refer to "9.8.3 Import DXF File Function" .
Analyze Dynamics	A dynamical analysis of the CNC program allows you to preliminarily check how each axis moves. For details, refer to "9.8.4 Dynamical Analysis for CNC Program" .
CNC Info	Do not use.
Set Variables	Do not use.

9.8.3 Import DXF File Function

You can import DXF files created with CAD tools so that CAD drawings can be represented in the CNC program. The following explains how to import a DXF file.

1 2 Procedure

- 1. From the CNC menu, select "Import from DXF File".

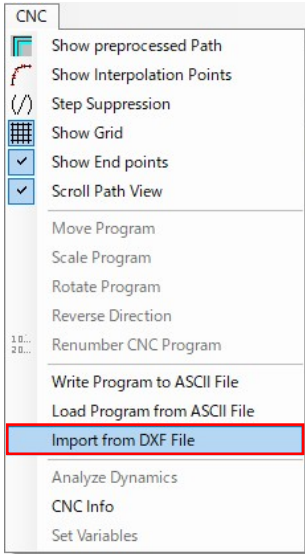

- 2. Select a DXF file to display the "Import DXF File" dialog box.

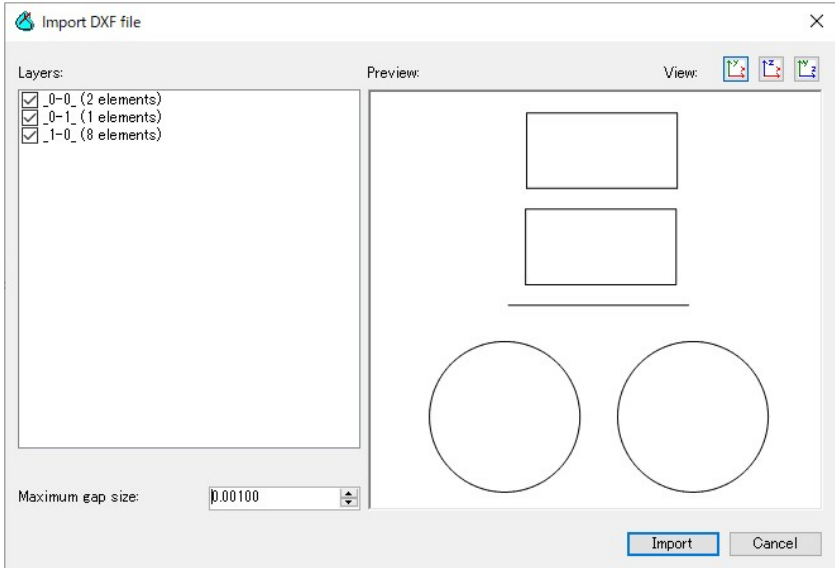

The contents of the "Import DXF File" dialog box are as follows.

9.8 CNC Control

Item	Description
Layout	All layers are listed. Checked layers will be imported.
Preview	A preview of the drawing to be imported is displayed.
Display	Select the plane to be displayed in the "Preview".
Maximum gap size	Set the correction value for the distance (gap) between two elements. The gap will be corrected according to the set correction value and converted to the CNC program. Details will be described later. Use in the default value.

3. After the settings are configured, click the [Import] button.
A confirmation dialog box will be displayed, asking if you want to execute the import.

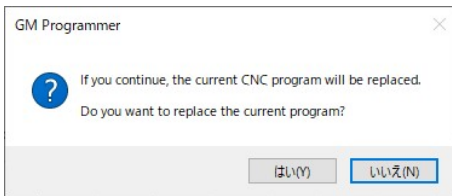

4. Click the [Yes] button.
Import will be executed and the data in the DXF file will be converted to the CNC program.
At this time, the CNC program before import will be overwritten.

i Info.

- The import function determines the G-codes to represent elements based on the DXF file data saved by the CAD tool.
For example, if the DXF file contains an element that represents a straight line such as "LINE", G01 will be used. If the file contains an element that represents a circle or arc such as "CIRCLE" or "ARC", G02/G03 will be used.
- For a connection between two elements, the import result will vary depending on the set value of "Maximum gap size".
 - If the gap is greater than the "Maximum gap size"
The two elements will be connected by G00.

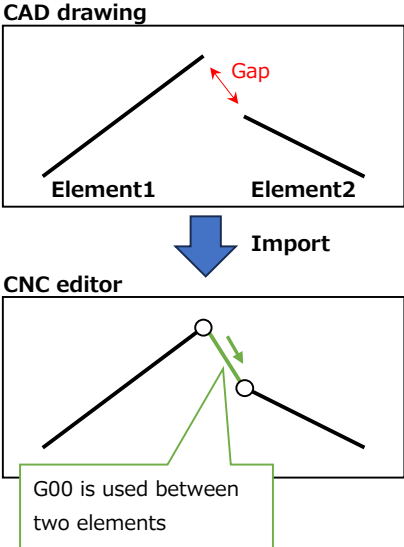

- If the gap is smaller than the "Maximum gap size"
The end point of the first element will be changed to the start point of the second element.

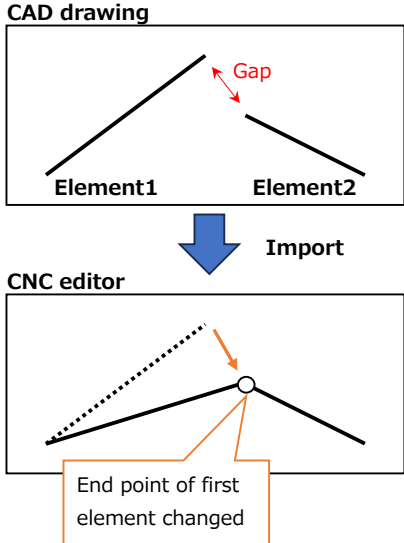

9.8 CNC Control

- Elements will be converted to the CNC program in order from the nearest element to the current position. However, figures with a single element (lines, circles, etc.) will be converted to the CNC program in priority over figures enclosed with multiple elements (squares, rounded rectangles, etc.).
- If there is a line element at the origin in the CAD, "G00" will be added to the first line, which does not affect the operation, however.
- If the "Maximum gap size" is greater than the length of the elements, the data will not be converted correctly to a CNC program.
- Do not import CNC objects for which the following items are set in the "CNC" tab of the Properties window. The data will not be imported correctly.
 - "Default values"
 - "Default values for fast forward"
 - "3D-Mode"

9.8.4 Dynamical Analysis for CNC Program

■ Preliminarily checking motion trace

A dynamical analysis of the created CNC program allows you to preliminarily check an expected motion curve of each axis.

1. In the CNC program editing window, from the menu bar, select **CNC>Analyze Dynamics**.

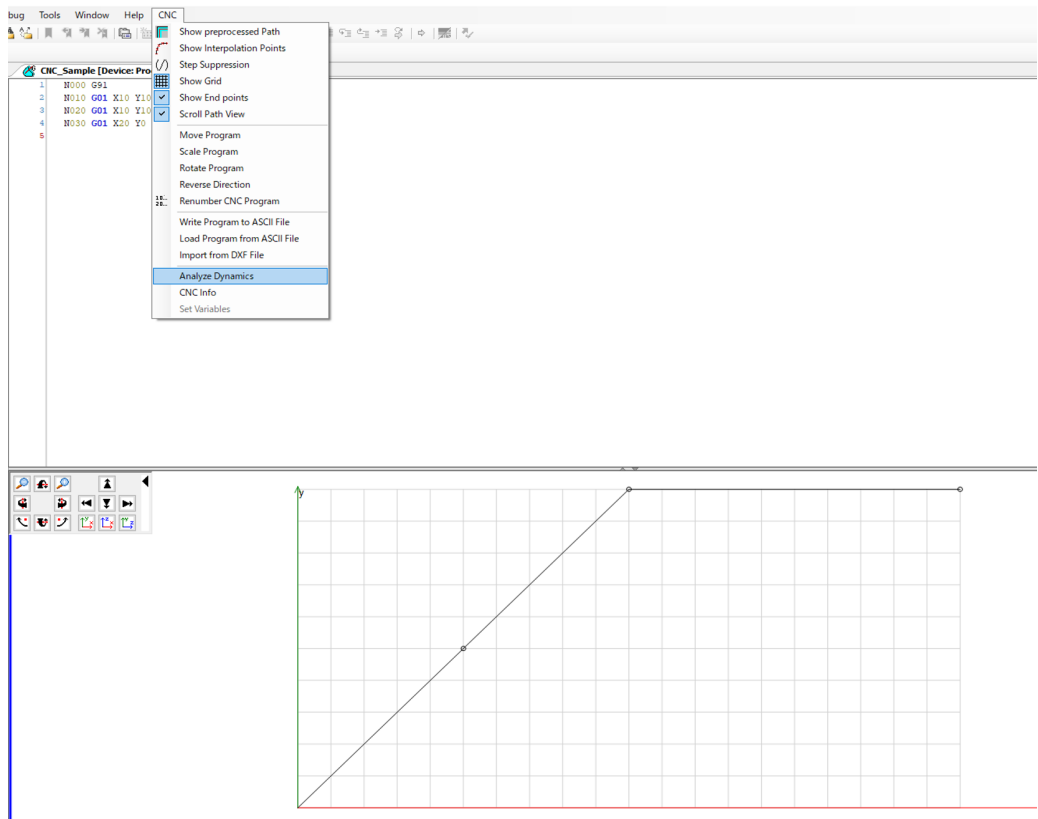

2. The "Dynamical Analysis" window will be displayed. Specify appropriate settings in the "Axis", "Cycle time", "Velocity mode", and "Maximum jerk" fields.

9.8 CNC Control

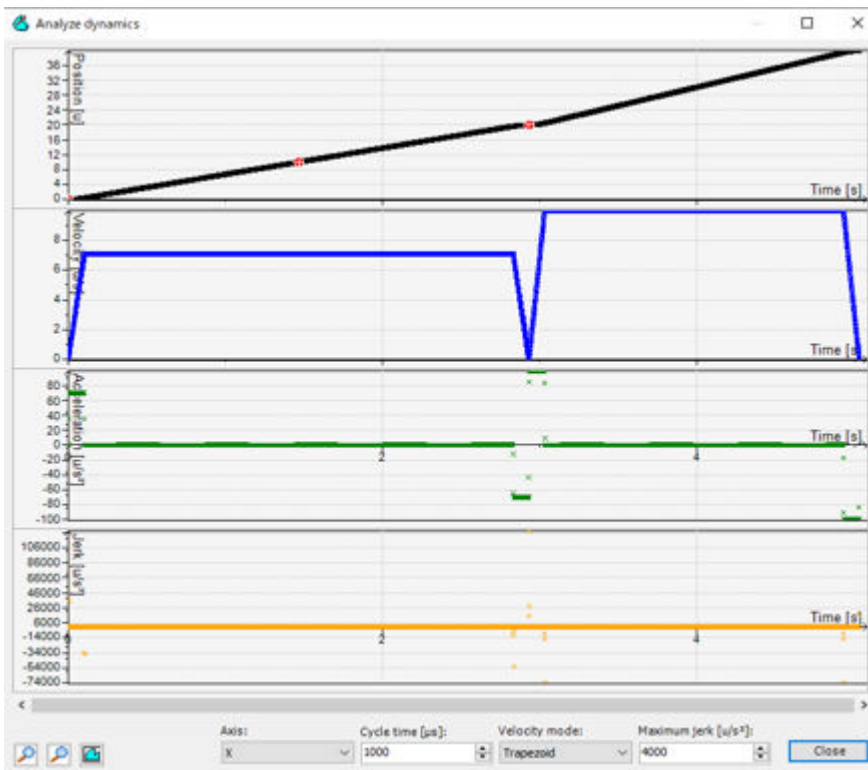

Note

- If variables are used in CNC programs, the "Dynamical Analysis" window cannot be displayed.
- If starting coordinates are specified or CNC programs are joined or repeated in POU, actual movements will differ from the results of dynamical analysis.

9.9 Motion Function Errors

9.9.1 Overview of Motion Function Errors

Motion function errors can be classified as below.

■ Function block (FB) errors

These errors occur when motion function blocks are executed. They are defined as SMC_ERROR in CODESYS.

Errors can be classified as below.

- Errors resulting in errorstop

In CODESYS, if an error that is judged to be operation non-continuable occurs, the axis state will be set to "errorstop" and control for the relevant axes will stop.

In a function block that is being executed, the "CommandAborted" flag is set to TRUE, causing the function block to terminate.

The "errorstop" state is released by executing the MC_Reset function block.

- Errors not resulting in errorstop

In CODESYS, if an error that is judged to be operation continuable (an error that can be cleared by re-executing the function block, such as a parameter error to the function block) occurs, the "Error" flag of the function block will be set to TRUE and an error code will be set in ErrorID. The error is cleared by setting the "Execute" flag in the function block to FALSE, enabling the function block to be re-executed.

■ DriveInterfaceError

Errors that occur in SM3_Drive_RTEX_Panasonic are output as DriveInterfaceError. DriveInterfaceError is an internal error.

■ Amplifier alarm

Alarms and warnings occur in servo amplifiers.

9.9 Motion Function Errors

9.9.2 Error Check Method

■ Online monitor in the axis setting window for SM3_Drive_RTEX_A6N

Status:

Communication:

Errors

Axis Error:

FB Error:

uiDriveInterfaceError:

strDriveInterfaceError:

The oldest error is displayed in the "FB error" field. This is the same error result as that output by the MC_ReadFBError function block.

* Some FB errors are not displayed (SMC_RP_REQUESTING_ERROR, etc.).

■ Device log

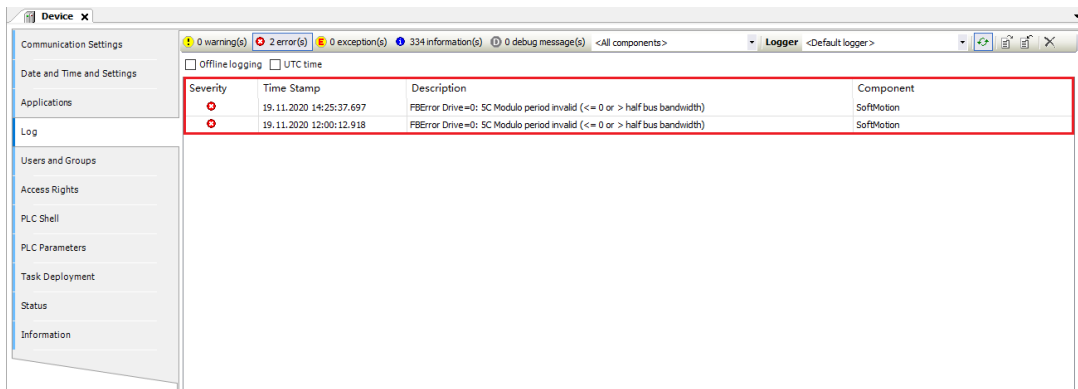

The screenshot shows the 'Device Log' window with a table of error entries. The table has four columns: Severity, Time Stamp, Description, and Component. Two error entries are listed, both with a red circle icon in the Severity column. The entries are:

Severity	Time Stamp	Description	Component
●	19.11.2020 14:25:37.697	FBError Drive=0: 5C Modulo period invalid (<= 0 or > half bus bandwidth)	SoftMotion
●	19.11.2020 12:00:12.918	FBError Drive=0: 5C Modulo period invalid (<= 0 or > half bus bandwidth)	SoftMotion

All errors that occurred in the past are displayed. This is regardless of whether "errorstop" occurred.

* Some FB errors are not displayed (SMC_RP_REQUESTING_ERROR, etc.).

■ Errors that can be output to programs

Return value to function block	When an FB error occurs, the "Error" flag is set to TRUE and the error ID of SMC_ERROR is output to ErrorID.	
MC_ReadFBError	FB errors that occurred are displayed, regardless of "errorstop". Some FB errors are not displayed (SMC_RP_REQUESTING_ERROR, etc.).	
Amplifier alarm	Whether alarms occurred	RTEX_ReadAmpState
	Alarm information acquisition	RTEX_ReadAmpAlarm

9.9.3 Clearing Errors

When errorstop occurs	Execute MC_Reset.	
When an error returns to a function block	Execute the same function block with the "Execute" flag set to FALSE.	
When an amplifier alarm occurs	RTEX	Execute RTEX_ClearAmpAlarm. * This applies to only errors that can be cleared. For errors that cannot be cleared, perform a warm reset or cold reset.
	EtherCAT	Execute SMC3_ReinitDrive

(MEMO)

10 EtherCAT Function

10.1 EtherCAT Axis Settings.....	10-2
10.1.1 Setting up the EtherCAT master	10-2
10.1.2 EtherCAT Slave Settings.....	10-7
10.1.3 Adding and Setting up Servo Amplifiers	10-14
10.1.4 Setting an Address for Each Servo Amplifier	10-19
10.2 Conducting Commissioning for Servo Amplifiers.....	10-20
10.3 Home Return.....	10-22
10.4 Functional limitations	10-23
10.4.1 Restrictions on the Combination of the GM1 Controller and Servo Amplifiers	10-23
10.4.2 Restrictions on Servo Amplifier Parameters	10-23

10.1 EtherCAT Axis Settings

10.1.1 Setting up the EtherCAT master

Set a control cycle for the GM1 Controller.

1 2 Procedure

1. Double-click the **MotionTask** object in the navigator pane.

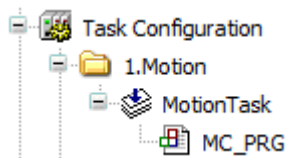

The "MotionTask" editor will open in the main pane.

2. Set a control cycle.

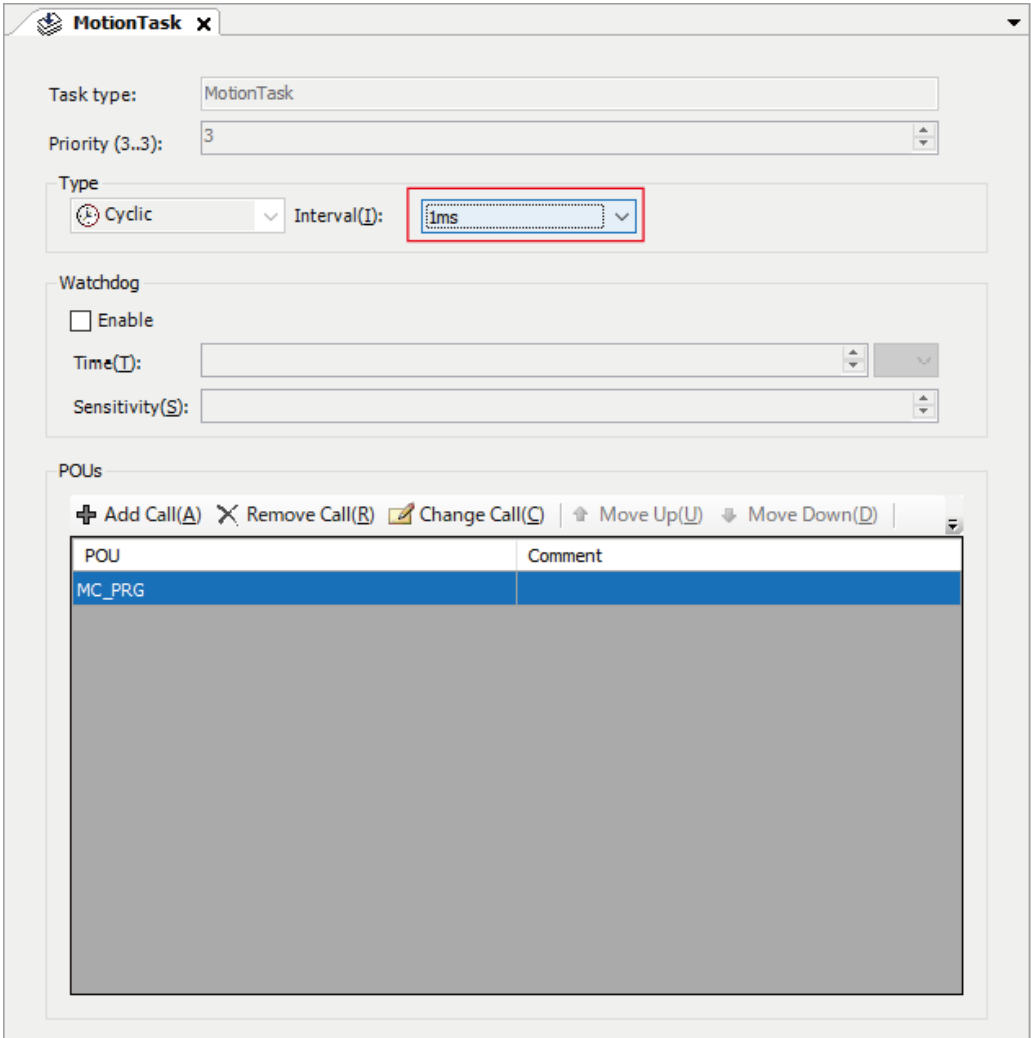

10.1 EtherCAT Axis Settings

EtherCAT_Master_SoftMotion

■ Overview

The EtherCAT master must be configured as described below.

This section explains various tabs and settings of EtherCAT_Master_SoftMotion editor.

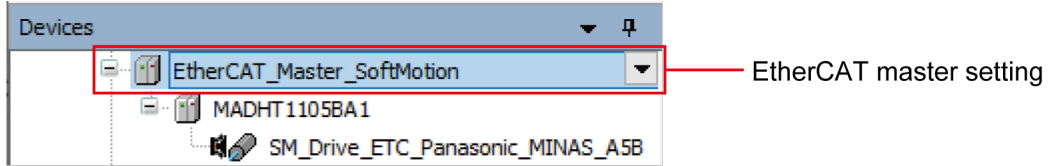

Set EtherCAT Master parameters on the General window.

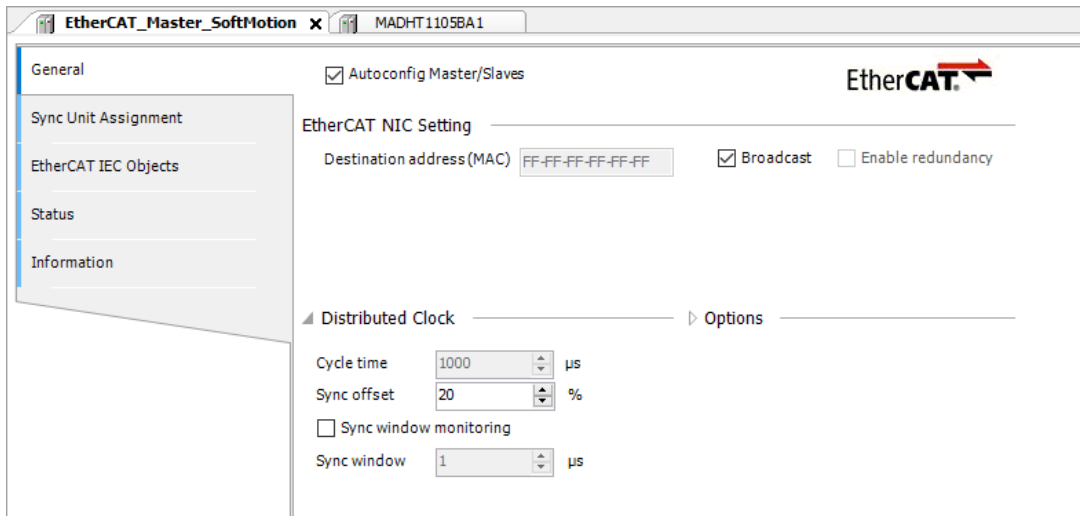

List of parameters

Name		Description
Automatic Master / Slave Configuration		When this parameter is enabled, it automatically performs configuration of the master and slave. When this parameter is disabled, all configuration settings for the master and slave must be made manually. Since configuration settings require expertise, it is recommended to set to automatic settings.
EtherCAT NIC Setting	Storage location address (MAC)	Specifies the destination address.
	Broadcast	When this setting is enabled, a broadcast address (FF-FF-FF-FF-FF-FF) is set in the storage location address (destination). When this setting is disabled, set a multicast address in the storage location address (destination).
Distributed Clock	Cycle Time	Sets the EtherCAT communication cycle. The MotionTask cycle is set.
	Synchronous Offset	Sets the delay time between the DC reference time of the EtherCAT slave and the EtherCAT task (PLC's cycle start time).

Name		Description
	Synchronous Window Monitoring	When this setting is enabled, it monitors slave synchronization.
	Synchronous Window	Sets the synchronous window monitoring time When all slave's synchronizations occur within the set time, xSyncInWindow (IoDrvEtherCAT) turns to TRUE.
Options	Use LRW instead of LWR / LRD.	When this setting is enabled, the LRW command (read/write) is used. When this setting is disabled, the LRD command (read) and LWR command (write) are used as separate commands.
	Enable message for every task.	When this setting is enabled, the PDO mapped variables are updated at the point of use of the POU. When this setting is disabled, the PDO mapped variables are updated by a MotionTask.
	Autostart slave.	When a communication breakdown occurs, automatically the master attempts to restart the slave immediately.
Master Configuration		It can be set only when Automatic Master / Slave Configuration is disabled.
	Image In Address	Sets the first logical address of the first slave used for PDO input data.
	Image Out Address	Sets the first logical address of the first slave used for PDO output data.

■ Sync Unit Assignment

In Sync Unit Assignment, multiple slaves can be grouped together and managed as a Sync Unit.

For example, one slave within a Sync Unit becomes unknown, the rest of the slaves in the Sync Unit are displayed as unknown. Since other Sync Units not affected remain operable, the unknown group can be promptly corrected using the device diagnostics.

The screenshot shows the 'EtherCAT_Master_SoftMotion' application window. On the left is a navigation pane with 'Sync Unit Assignment' selected. The main area contains a table with two columns: 'Device name' and 'Sync Unit'. The table lists two entries: 'MADHT110SBA1' and 'MADHT110SBA1 1', both assigned to the 'default' Sync Unit. Below the table are two buttons: '+ Add Sync Unit' and 'X Delete'. Red arrows point from text boxes to these elements:

- An arrow points to the 'Sync Unit' column header with the text: "Selects the Sync Unit group. (Default value: \"Default\") The Sync Unit group can be added by clicking the Add button at the bottom of the list."
- An arrow points to the table content with the text: "Displays the names of slaves inserted in EtherCAT_Master_SoftMotion in the Device tree."
- An arrow points to the '+ Add Sync Unit' button with the text: "Enter a Sync Unit name in the text field and click the +Add button to create a new one."
- An arrow points to the 'Delete' button with the text: "Deletes the selected Sync Unit. The Sync Unit to be deleted with slaves assigned as a group is reassigned to the default group."

10.1 EtherCAT Axis Settings

■ Status tab

Diagnostic messages of the EtherCAT_Master_SoftMotion device are displayed. They can be checked with the program using the "GetStatistics" method of "IoDevEtherCAT".

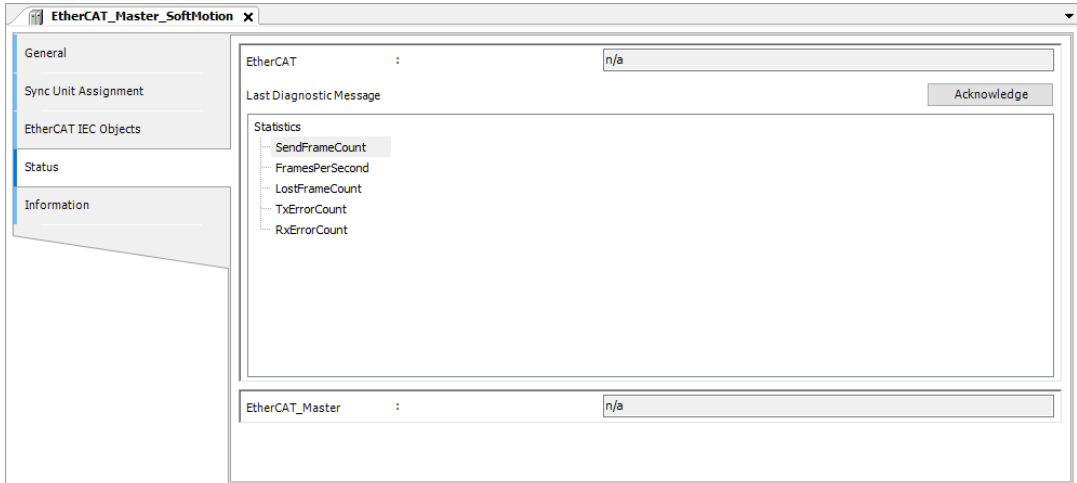

Item	Description
SendFrameCount	The number of EtherCAT send frames is displayed.
FramesPerSecond	The number of send frames per second is displayed.
LostFrameCount ^(Note 1)	The number of frame losses is displayed.
TxErrorCount	The number of send errors is counted.
RxErrorCount	The number of receive errors is counted.

(Note 1) Check the following when the number of frame losses is other than 0.

- Influence of noise
- Connection status with slaves
- Program load

10.1.2 EtherCAT Slave Settings

EtherCAT Slave Settings

■ **Overview**

The EtherCAT slave must be configured as described below. The description below explains how to set the servo amplifier (A5B: MADHT1105BA1) manufactured by Panasonic.

Set EtherCAT slave parameters on the General window. In the Sync Unit cycle, the cycle set in MotionTask is set.

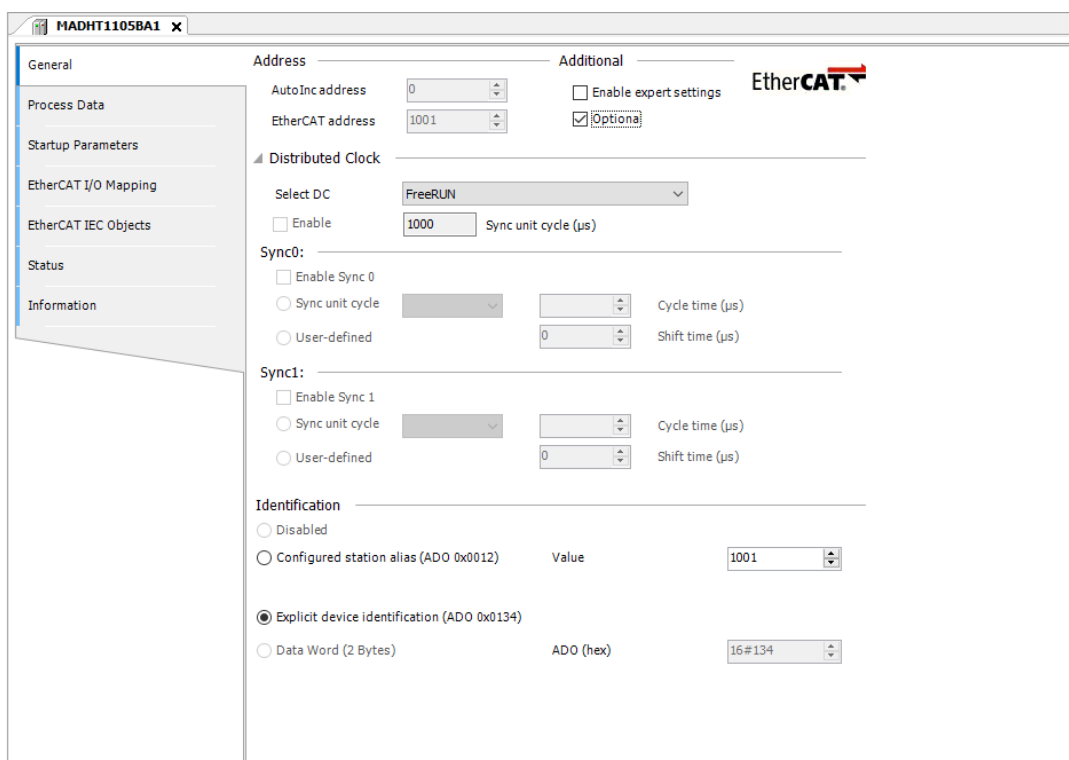

List of parameters

Name	Description
Address	It can be set only when "Automatic Master / Slave Configuration" is disabled in EtherCAT master setting.
	AutoInc address
	EtherCAT address
Add	Enable expert settings
	When this setting is enabled, expert setting can be made. Since expert settings are not required for standard applications, it is recommended to disable the settings.

10.1 EtherCAT Axis Settings

Name		Description
	Option	<p>When this setting is enabled, the slave is defined as an option. As a result, an error message is not generated even when a device is not found in the bus system. When this setting is enabled, assign a unique ID in the setting for the identification section.</p> <ul style="list-style-type: none"> Requirements for use <ul style="list-style-type: none"> The "Automatic Master / Slave Configuration".parameter on the "General" tab of EtherCAT_Master_SoftMotion editor is enabled. The EtherCAT slave supports this function.
Distributed Clock	DC selection	<p>Sets the synchronization method between the master and the slave.</p> <p>Example:</p> <ul style="list-style-type: none"> FreeRUN: Non-synchronize with master's cycle time. DC Sync0: Based on the time of the 1st axis, synchronize time information of other slaves.
Identification	Disable	Slave identification is not checked.
	Configured station alias value	Sets the address stored in the slave device EEPROM.
	Explicit device identification	Sets a device identification number for hardware such as a DIP switch of the slave device.
	Data word (2 bytes)	A 2-byte identification number is saved. (MINAS: Not supported)

■ Process data

PDO (Process Data Object) is data that is updated between the master and the slave for every EtherCAT communication cycle. The configuration of the PDO varies depending on the slave. Select an appropriate one for each axis control method. The selected PDO mapping is reflected on the "EtherCAT I/O mapping" and can be used in the program.

Select

The screenshot shows the configuration interface for MADHT1105BA1. On the left is a sidebar with categories: General, Process Data, Startup Parameters, EtherCAT I/O Mapping, EtherCAT IEC Objects, Status, and Information. The main area is split into two tables: 'Select the Outputs' and 'Select the Inputs'. Both tables have columns for Name, Type, and Index. In the 'Select the Outputs' table, the entry '16#1600 Receive PDO mapping 1' is checked. In the 'Select the Inputs' table, the entry '16#1A00 Transmit PDO mapping' is checked. A red arrow labeled 'Select' points from the word 'Select' above to the '16#1A00 Transmit PDO mapping' entry.

Select the Outputs			
Name	Type	Index	
<input checked="" type="checkbox"/> 16#1600 Receive PDO mapping 1			
Controlword	UINT	16#6040:00	
Modes of operation	SINT	16#6060:00	
Target position	DINT	16#607A:00	
Touch probe function	UINT	16#60B8:00	
<input type="checkbox"/> 16#1601 Receive PDO mapping 2			
Controlword	UINT	16#6040:00	
Modes of operation	SINT	16#6060:00	
Target torque	DINT	16#6071:00	
Target position	DINT	16#607A:00	
Max motor speed	UDINT	16#6080:00	
Touch probe function	UINT	16#60B8:00	
Target velocity	DINT	16#60FF:00	
<input type="checkbox"/> 16#1602 Receive PDO mapping 3			
Controlword	UINT	16#6040:00	
Modes of operation	SINT	16#6060:00	
Max torque	UINT	16#6072:00	
Target position	DINT	16#607A:00	
Touch probe function	UINT	16#60B8:00	
Target velocity	DINT	16#60FF:00	
<input type="checkbox"/> 16#1603 Receive PDO mapping 4			
Controlword	UINT	16#6040:00	
Modes of operation	SINT	16#6060:00	
Target torque	DINT	16#6071:00	
Max torque	UINT	16#6072:00	
Target position	DINT	16#607A:00	
Max motor speed	UDINT	16#6080:00	
Touch probe function	UINT	16#60B8:00	
Target velocity	DINT	16#60FF:00	

Select the Inputs			
Name	Type	Index	
<input checked="" type="checkbox"/> 16#1A00 Transmit PDO mapping			
Error code	UINT	16#603F:00	
Statusword	UINT	16#6041:00	
Modes of operation display	SINT	16#6061:00	
Position actual value	DINT	16#6064:00	
Touch probe status	UINT	16#60B9:00	
Touch probe pos1 pos value	DINT	16#60BA:00	
Following error actual value	DINT	16#60F4:00	
Digital inputs	UDINT	16#60FD:00	
<input type="checkbox"/> 16#1A01 Transmit PDO mapping			
Error code	UINT	16#603F:00	
Statusword	UINT	16#6041:00	
Modes of operation display	SINT	16#6061:00	
Position actual value	DINT	16#6064:00	
Velocity actual value	DINT	16#606C:00	
Torque actual value	INT	16#6077:00	
Touch probe status	UINT	16#60B9:00	
Touch probe pos1 pos value	DINT	16#60BA:00	
Digital inputs	UDINT	16#60FD:00	
<input type="checkbox"/> 16#1A02 Transmit PDO mapping			
Error code	UINT	16#603F:00	
Statusword	UINT	16#6041:00	
Modes of operation display	SINT	16#6061:00	
Position actual value	DINT	16#6064:00	
Velocity actual value	DINT	16#606C:00	
Torque actual value	INT	16#6077:00	
Touch probe status	UINT	16#60B9:00	
Touch probe pos1 pos value	DINT	16#60BA:00	
Digital inputs	UDINT	16#60FD:00	
<input type="checkbox"/> 16#1A03 Transmit PDO mapping			
Error code	UINT	16#603F:00	
Statusword	UINT	16#6041:00	
Modes of operation display	SINT	16#6061:00	
Position actual value	DINT	16#6064:00	
Velocity actual value	DINT	16#606C:00	
Torque actual value	INT	16#6077:00	
Touch probe status	UINT	16#60B9:00	
Touch probe pos1 pos value	DINT	16#60BA:00	
Digital inputs	UDINT	16#60FD:00	

10.1 EtherCAT Axis Settings

■ Startup parameter

Using the SDO (Service Data Object), slave parameters can be set at the start of RUN.

1. Click "Add".

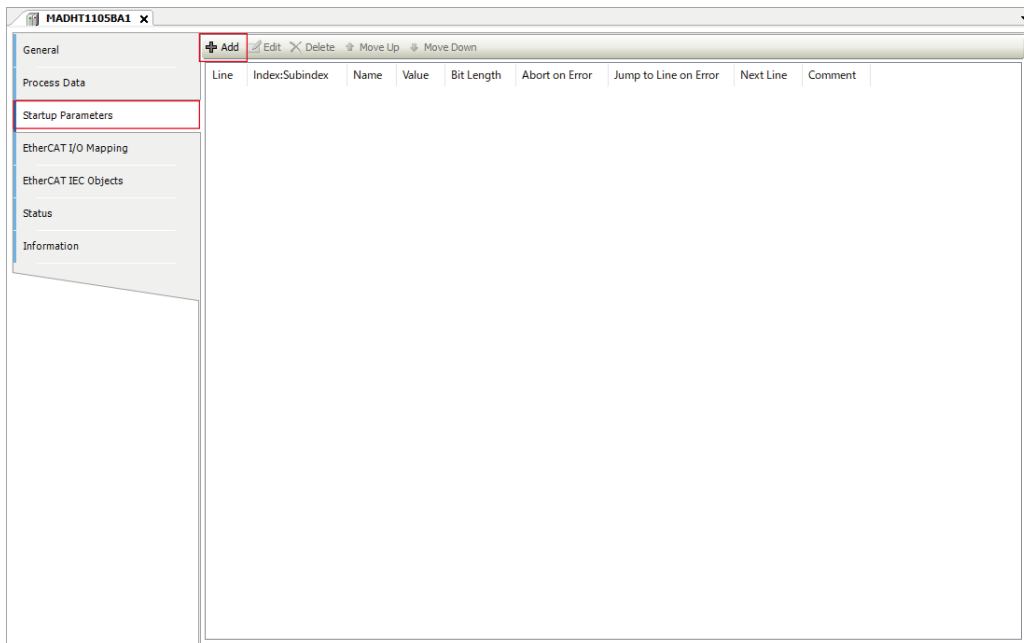

2. Enter object information to be changed.

The following explanation is provided for an example where "Acceleration time setting" is changed.

- Name: Any name
- Index 16#: 3312
- Sub-index 16#: 0
- Bit length: 16
- Value: 100

Select Item from Object Directory

Index:S...	Name	Flags	Type	Default
------------	------	-------	------	---------

Name Acceleration time setup

Index: 16# 3312 Bit length 16

SubIndex: 16# 0 Value 100

Byte array

OK

Cancel

3. Click the [OK] button.

10.1 EtherCAT Axis Settings

Select Item from Object Directory

Index:S...	Name	Flags	Type	Default

Name: Acceleration time setup

Index: 16# 3312 Bit length: 16

SubIndex: 16# 0 Value: 100

Byte array

OK

Cancel

The data will be displayed as follows.

Line	Index:Subindex	Name	Value	Bit Length	Abort on Error	Jump to Line on Error	Next Line	Comment
1	16#3312:16#00	Acceleration time setup	100	16	<input type="checkbox"/>	<input type="checkbox"/>	0	

■ Online

When set to online, the status of the ESM (EtherCAT State Machine) can be changed and displayed, firmware files can be written or read, and configuration information can be written or read to EEPROM.

- Requirements for use
 - "Enable expert settings" on the "General" tab is enabled.
 - You are already logged in to the controller.

Note

- Writing a wrong file or incorrect configuration information may cause the slave to operate in an abnormal manner. Be careful when using the online mode.

■ CoE online tab

Set values can be written or read from the ESI file or the object dictionary of the slave device.

- Requirements for use
 - "Enable expert settings" on the "General" tab is enabled.

- You are already logged in to the controller.

The screenshot shows the 'MADHT1105BA1' controller interface. On the left is a navigation menu with categories: General, Expert Process Data, Process Data, Startup Parameters, Online, CoE Online, DiagHistory, EtherCAT I/O Mapping, EtherCAT IEC Objects, Status, and Information. The main area is titled 'Read Objects' and includes controls for 'Auto update' (checkbox), 'Offline from ESI file' (radio), and 'Online from device' (radio, selected). Below these is a table of object data.

Index:Subindex	Name	Flags	Type	Value
16#1000:16#00	Device type	RO	UDINT	131474
16#1001:16#00	Error register	RO	USINT	0
16#1008:16#00	Manufacturer device name	RO	STRING	'MADHT1105BA1'
16#1009:16#00	Manufacturer hardware version	RO	STRING	'V1.00'
16#100A:16#00	Manufacturer software version	RO	STRING	'V1.00'
16#1010:16#00	Store parameters	RO	USINT	1
16#1018:16#00	Identity object	RO	USINT	4
16#10F3:16#00	Diagnosis history	RO	USINT	19
16#1600:16#00	Receive PDO mapping 1	RW	USINT	4
16#1601:16#00	Receive PDO mapping 2	RW	USINT	7
16#1602:16#00	Receive PDO mapping 3	RW	USINT	6
16#1603:16#00	Receive PDO mapping 4	RW	USINT	8
16#1A00:16#00	Transmit PDO mapping 1	RW	USINT	8
16#1A01:16#00	Transmit PDO mapping 2	RW	USINT	9
16#1A02:16#00	Transmit PDO mapping 3	RW	USINT	9
16#1A03:16#00	Transmit PDO mapping 4	RW	USINT	9
16#1C00:16#00	Sync manager communication type	RO	USINT	4
16#1C12:16#00	Sync manager channel 2	RW	USINT	1
16#1C13:16#00	Sync manager channel 3	RW	USINT	1
16#1C32:16#00	Sync manager 2 synchronization	RO	USINT	32
16#1C33:16#00	Sync manager 3 synchronization	RO	USINT	32
16#3000:16#00	For manufacturer's use	RW	INT	0
16#3001:16#00	Control mode setup	RW	INT	0
16#3002:16#00	Real-time auto-gain tuning setup	RW	INT	0
16#3003:16#00	Real-time auto-tuning machine stiffness setup	RW	INT	25
16#3004:16#00	Inertia ratio	RW	INT	13
16#3008:16#00	For manufacturer's use	RW	DINT	0
16#3009:16#00	For manufacturer's use	RW	DINT	1

10.1 EtherCAT Axis Settings

10.1.3 Adding and Setting up Servo Amplifiers

This section explains how to add device objects for servo amplifiers to a project and set them up.

The description below explains how to add device objects for A5B servo amplifiers to a project and how to set them up.

1 2 Procedure

1. Right-click the **EtherCAT_Master_SoftMotion** object in the navigator pane and then select **Device addition** from the context-sensitive menu that is displayed.

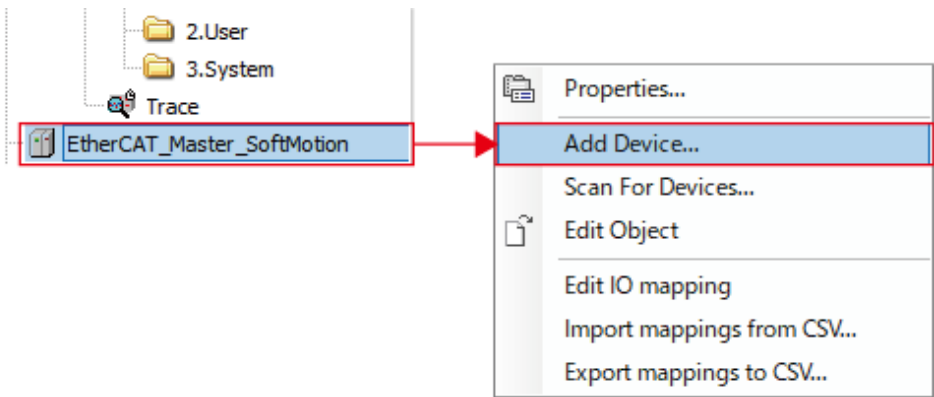

The "Add Device" dialog box will be displayed.

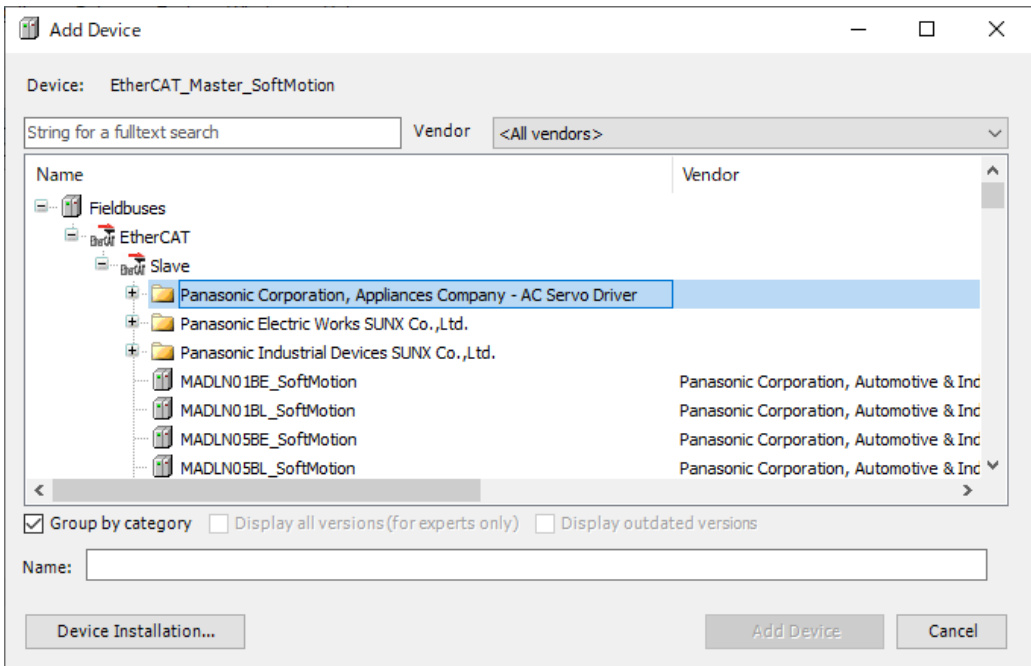

2. Select a device object for the servo amplifier.

The selected device object of the servo amplifier will be added.

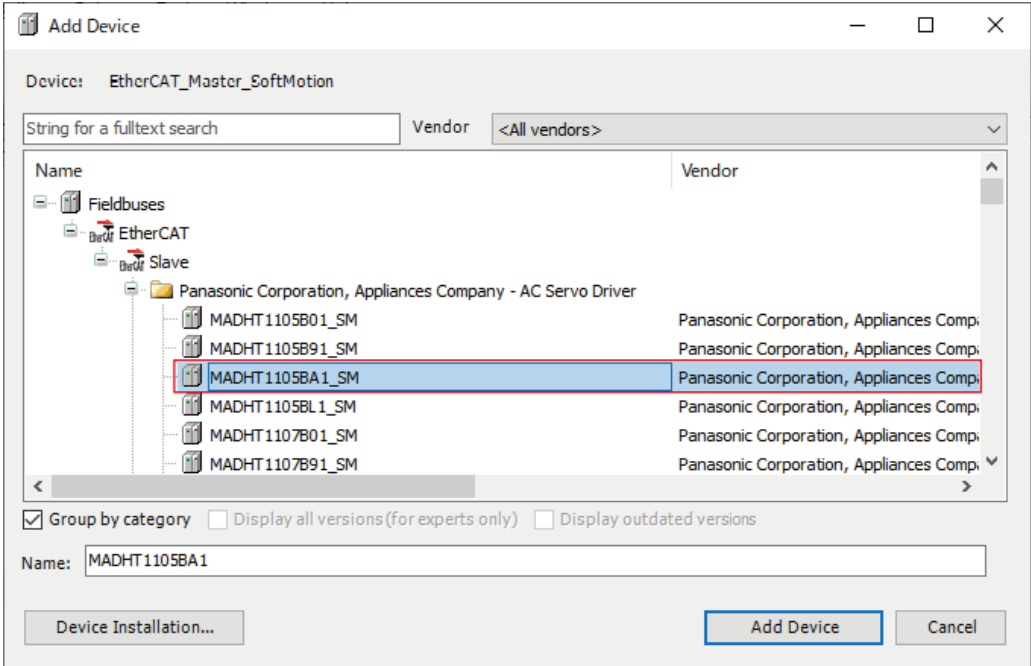

- 3. Click the [Add Device] button.
The selected device object of the servo amplifier will be added to the navigator pane.

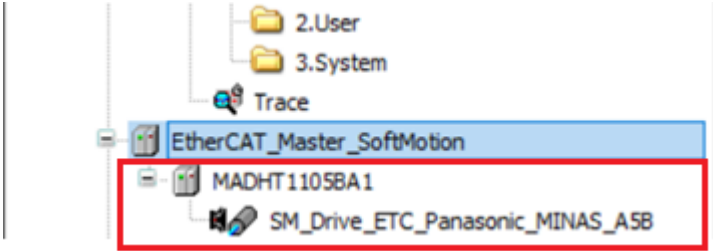

Click the [Cancel] button to close the “Select Device” dialog box.

- 4. Double-click the added object.
The setting pane will be displayed in the main pane.

10.1 EtherCAT Axis Settings

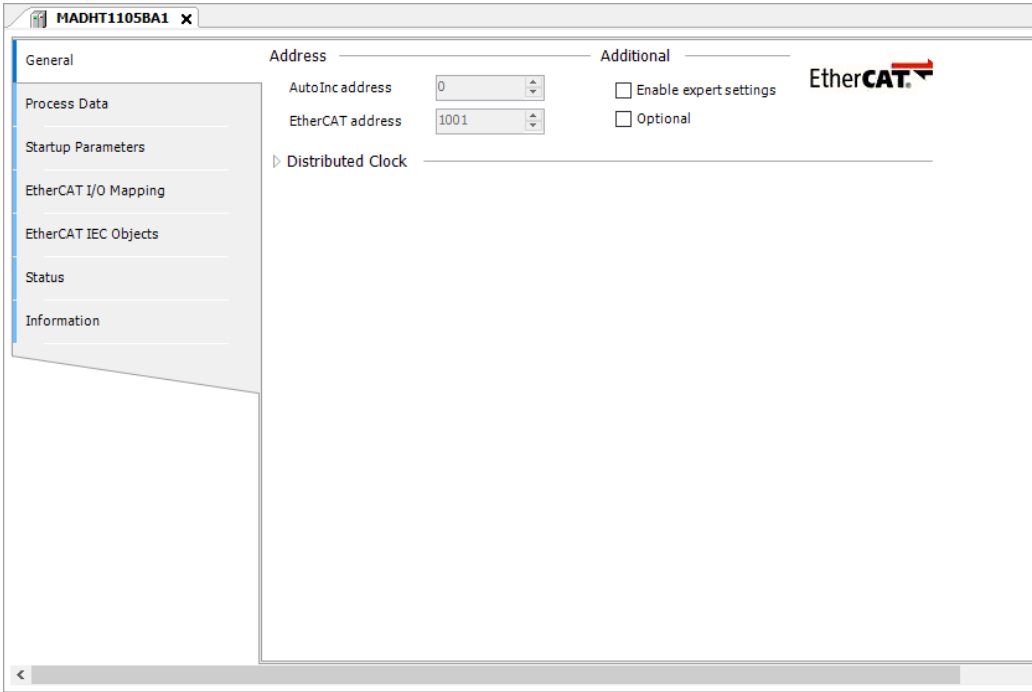

i Info.

- To remove a device object that has been added, select the device object in the navigation pane and press the <Delete> key.

5. Enable the “Enable expert setting” item.

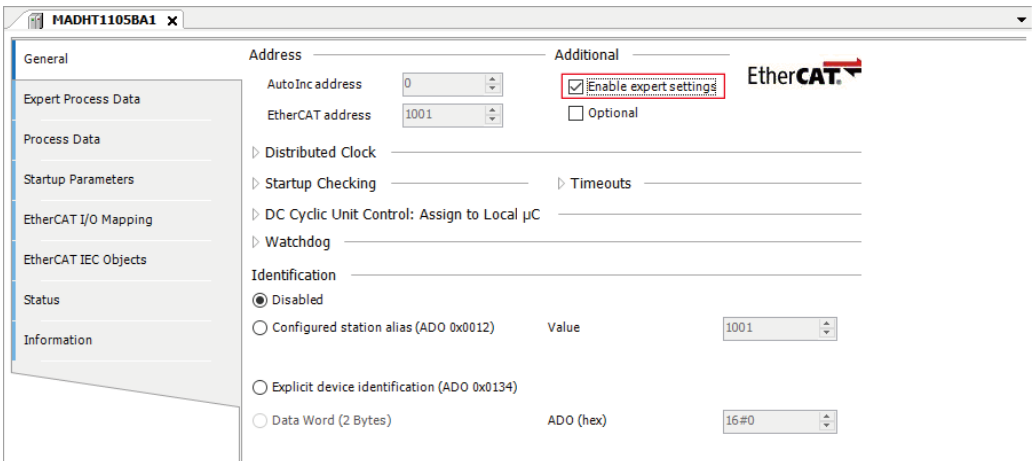

6. Set “Station alias”.

Depending on the setting of Pr7.41 as the initial setup for the servo amplifier, the method for setting “Station alias” is different.

- When Pr.7.41 is set to 0

Select the "Configured station alias" option and enter the setting of the rotary switch on the front panel of the servo amplifier and the setting of Pr7.40 into the input field.

Example) Set value of the rotary switch on the front panel of the servo amplifier: 8, set value of Pr7.40: 1

The higher 8 bits are 1 and lower 8 bits are 8. Therefore, input 264 in the input field.

Station alias	
Higher 8 bits	Lower 8 bits
Set value of 3740h	Set value of the rotary switch

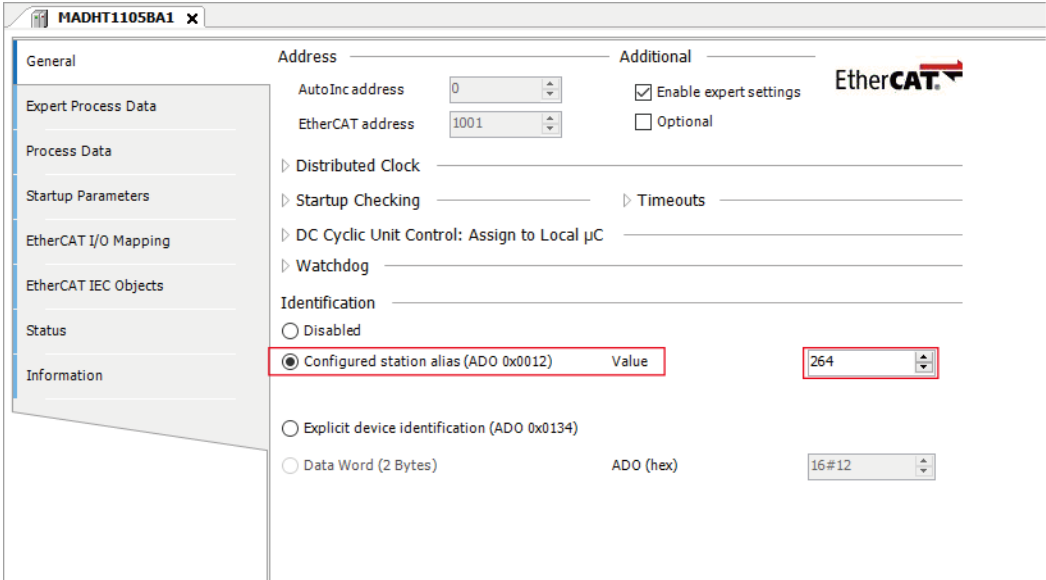

- When Pr.7.41 is set to 1
Select the "Disable" option.
The numerical value displayed in "EtherCAT address" is set as the station alias value.

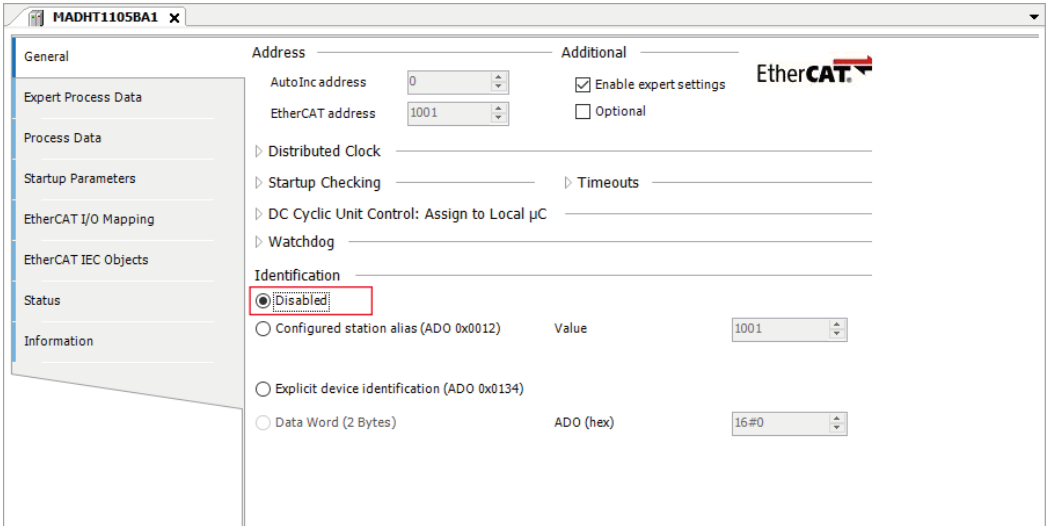

10.1 EtherCAT Axis Settings

Info.

- You can also set any desired value after logging in by selecting the configured station alias value.

Enter any desired value in the input field and click the [Write to EEPROM] button.

<input checked="" type="radio"/> Configured station alias (ADO 0x0012)	Value	<input type="text" value="2"/>
<input type="button" value="Write to EEPROM"/>	Actual address	<input type="text"/>

When you log in again after restarting the servo amplifier, the value entered in the input field is set as the station alias value.

Select the configured station alias value and log in for the first time, and the device name of the servo amplifier in the navigation pane will be grayed out due to a mismatch of the station alias value.



10.1.4 Setting an Address for Each Servo Amplifier

The following are the address setting methods prescribed by EtherCAT.

- Reading the Value of Rotary Switch
- Reading the Value of SII Area

Reading the Value of Rotary Switch

Addresses are set using the value of the rotary switch on each servo amplifier.

This setting method is explained using MINAS-A5B as an example.

By setting the Pr7.41 parameter to 0, the value of the rotary switch on the front panel can be used as an address.

In this case, the value of the rotary switch and the value of Pr7.40 are combined and used as an address.

Station alias	
High-order 8 bits	Low-order 8 bits
3740H setting	Rotary switch setting

Reading the Value of SII Area

Addresses are set using the value of the SII area (0004h) in each servo amplifier.

This setting method is explained using MINAS-A5B as an example.

By setting the Pr7.41 parameter to 1, the value of the SII area (0004h) can be used as an address.

The value of the SII area (0004h) can be set using the EtherCAT slave device object of GM Programmer.

The following figure illustrates the correlation between the settings in GM Programmer and the wiring of each servo amplifier when addresses are set using the value of the SII area.

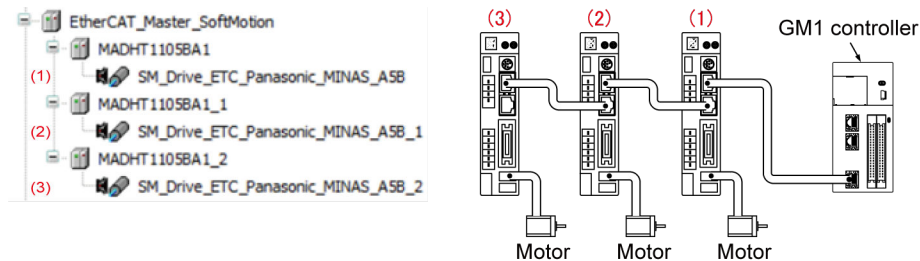

10.2 Conducting Commissioning for Servo Amplifiers

10.2 Conducting Commissioning for Servo Amplifiers

While in online config mode, you can conduct commissioning for servo amplifiers.

There is no need to create a program for commissioning.

The following is an example of commissioning using the A5B-series servo amplifiers.

1 2 Procedure

1. Double-click the servo amplifier object in the navigator pane.

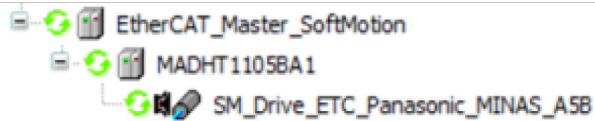

The "EtherCAT Axis Setting" dialog box will be displayed.

2. Click the "Commissioning" tab.
The Commissioning pane will be displayed.

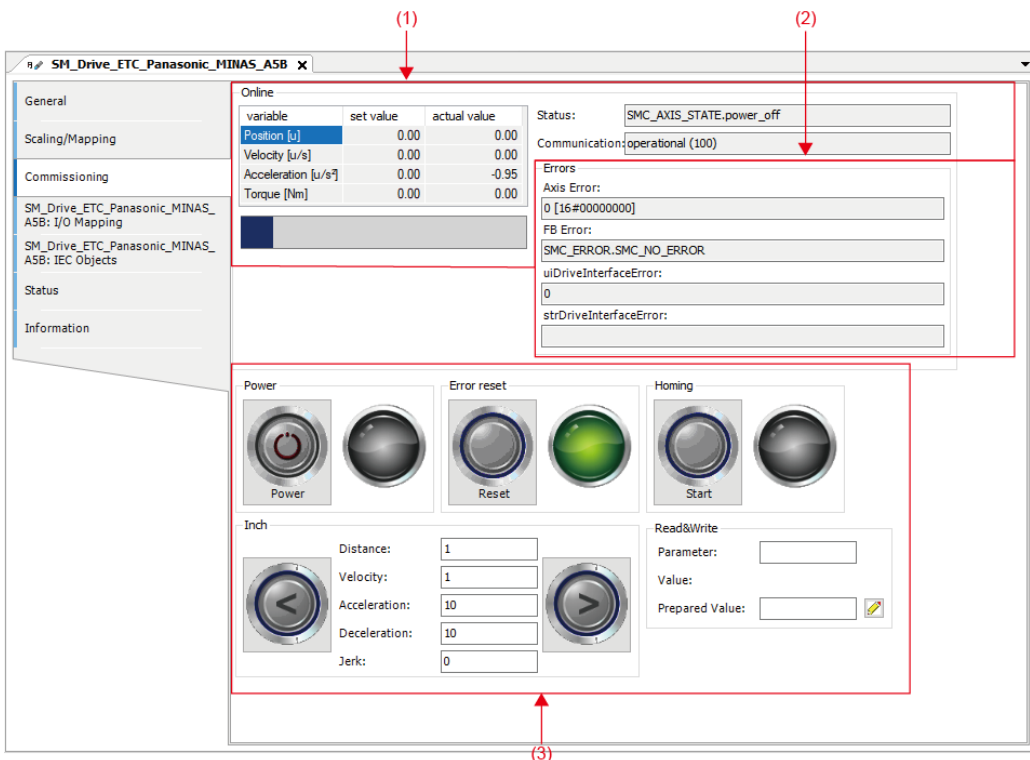

No.	Group	Description
(1)	Status	Displays the running status of the servo amplifiers during commissioning.
(2)	Error	Displays errors that occurred during commissioning. Allows the user to clear errors.

No.	Group	Description
(3)	Operation	Allows the user to set commissioning parameters. Allows the user to execute commissioning.

3. Click an appropriate button in the Operation group to start commissioning.
Clicking an icon starts the corresponding commissioning.
To change home return parameters, use the "Program" tab.

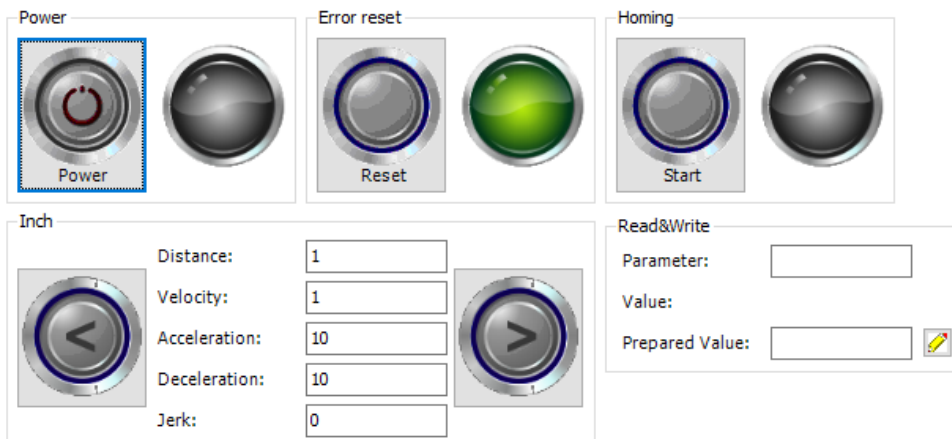

4. For the servo amplifier status during commissioning, check the "Status" and "Error" groups.
 - 4-1 To clear errors that are displayed, click the [Reset] button in the "Operation" group.
Clicking the [Reset] button clears all errors.
5. From the menu bar, select **Project>Online Config Mode**.
Online config mode will be canceled and commissioning will be terminated.

This completes commissioning for servo amplifiers.

i Info.

- Even if communication with the servo amplifier is disrupted during "Inching" or "Home Return" operation, the servo amplifier will continue commissioning operation.
- If online config mode is canceled, commissioning will be terminated. To cancel the online config mode, select **Project>Online Config Mode** from the menu bar again.

10.3 Home Return

Home return is an operation that returns the motor to its home position.
Home return can be achieved by executing the "MC_Home" function block.

Info.

- Home Return, refer to the Manuals of each manufacturer.
- MC_Home, refer to the *GM1 Series Reference Manual (Instruction)*.

10.4 Functional limitations

10.4.1 Restrictions on the Combination of the GM1 Controller and Servo Amplifiers

As for the combination of the GM1 Controller and each MINAS series, confirm the following restrictions.

Combination of the GM1 Controller and servo amplifiers

Connectable servo amplifier		Description
A5B	A6B	
•	•	A5B and A6B can be connected to the same network.

Note

- When using servo amplifiers in combination with the GM1 Controller, use the ones with the latest software version.

■ Setting ranges of movement amount and speed

The input range of the movement amount or speed specified in the GM1 Controller may differ from the upper and lower setting limits of the servo amplifier.

i Info.

- The respective control cycles supported by the GM1 Controller and servo amplifiers A5B and A6B are shown below.
 - GM1 Controller: 500 μ s to 4 ms (control cycle)
 - Servo amplifier A5B: 500 μ s to 4 ms (control cycle)
 - Servo amplifier A6B: 500 μ s to 4 ms (control cycle)

10.4.2 Restrictions on Servo Amplifier Parameters

Some parameters of servo amplifiers affect the operation of the GM1 Controller. Use the following parameter.

No.	Name	Settings	Factory default setting
Pr5.04	Over-travel inhibit input setup	Use set value 1. (Recommended)	1 ^(Note 1)

(Note 1) We recommend that the set value not be changed due to the characteristics of the GM1 and MINAS.

(MEMO)

11 RTEX Function

11.1	Setting up the RTEX axis	11-2
11.1.1	Setting up the RTEX master.....	11-2
11.1.2	Adding and Setting up Servo Amplifiers.....	11-3
11.1.3	Setting an Address for Each Servo Amplifier	11-6
11.2	Conducting Commissioning for Servo Amplifiers	11-7
11.3	Home Return	11-11
11.3.1	Types of home return	11-11
11.3.2	DOG method 1 [Edge detection of near home switch + Home position (Z phase) based on front edge]	11-13
11.3.3	DOG method 2 (Edge detection of near home switch).....	11-14
11.3.4	DOG method 3 [Edge detection of near home switch + Home position (Z phase) based on rear edge].....	11-15
11.3.5	Limit method 1 [Edge detection of limit switch + Home position (Z phase) based on front edge].....	11-16
11.3.6	Limit method 2 (Edge detection of limit switch).....	11-17
11.3.7	Home position method [Edge detection of home position (Z phase)].....	11-17
11.3.8	Stop-on-contact method 1	11-18
11.3.9	Stop-on-contact method 2 [Stop-on-contact detection + Home position (Z phase) based on front edge]	11-18
11.3.10	Data set method.....	11-19
11.3.11	High-speed home return.....	11-19
11.3.12	Settings and operations of home return	11-19
11.4	Functional limitations.....	11-21
11.4.1	Restrictions on the Combination of the GM1 Controller and Servo Amplifiers	11-21
11.4.2	Restrictions on Servo Amplifier Parameters.....	11-21

11.1 Setting up the RTEX axis

11.1 Setting up the RTEX axis

11.1.1 Setting up the RTEX master

Set the communication / control cycle for RTEX.

1 2 Procedure

1. Double-click "RTEX_Master".

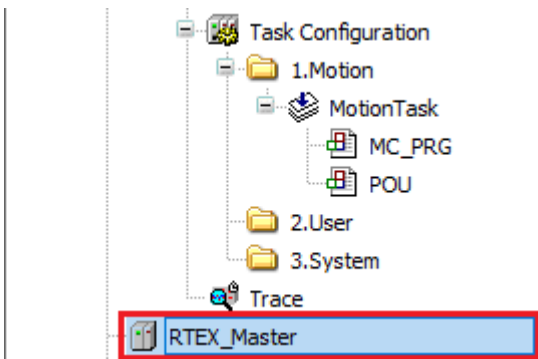

The RTEX_Master editor will open.

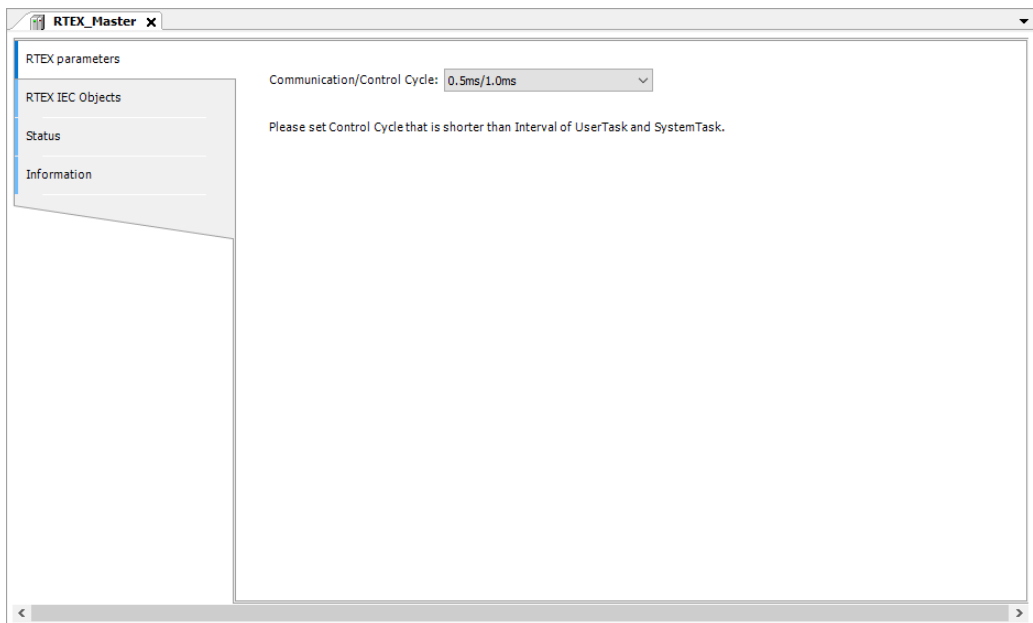

2. Set the communication / control cycle.

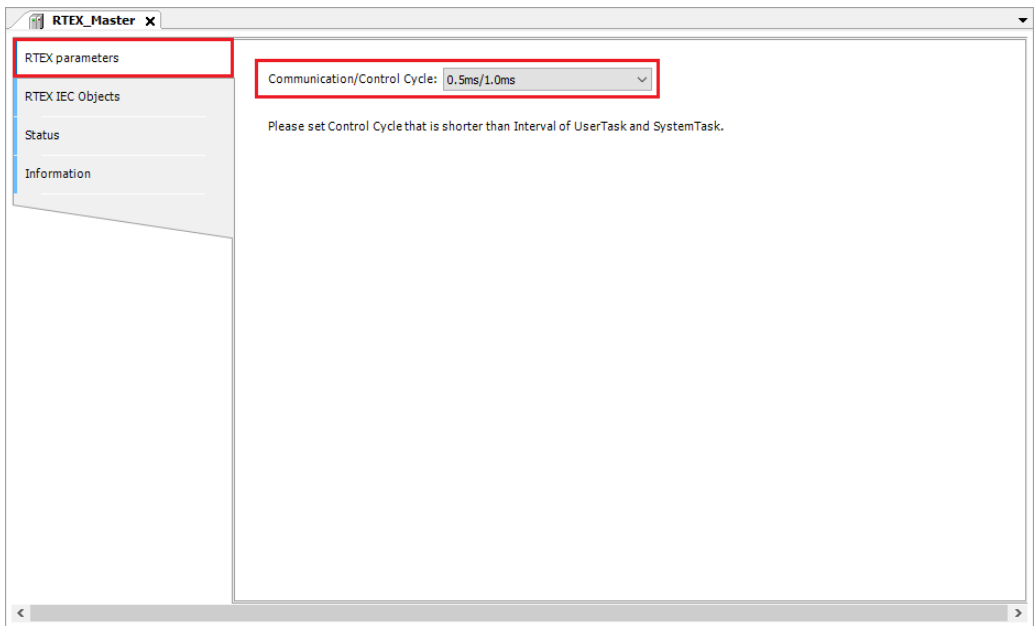

11.1.2 Adding and Setting up Servo Amplifiers

Add device objects for servo amplifiers to a project and set them up.

The description below explains how to add device objects for A6N servo amplifiers to a project and how to set them up.

1.2 Procedure

1. Right-click the [RTEX_Master] object in the navigator pane and then select "Device Management" from the context-sensitive menu that is displayed.

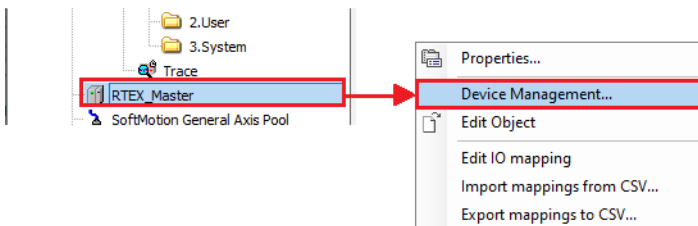

The "Device Management" dialog box will be displayed.

11.1 Setting up the RTEX axis

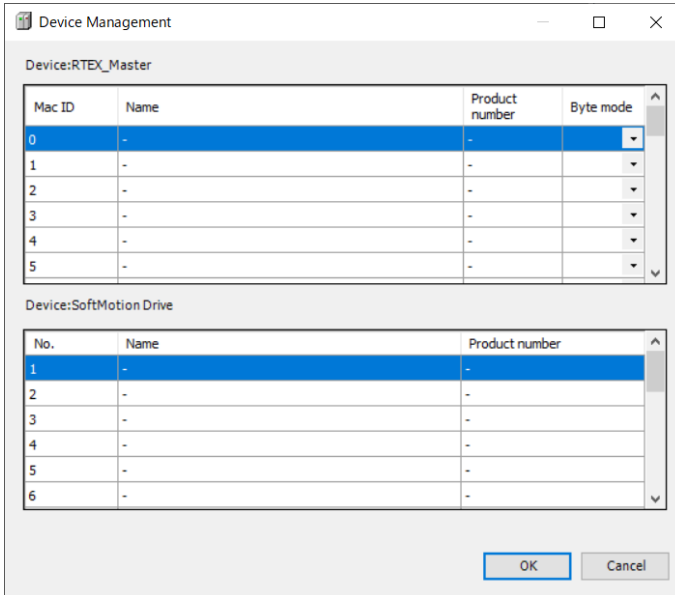

2. Double-click the MAC ID row in the "Device: RTEX_Master" table.

Info.

- For the MAC ID, double-click the same No. as the No. set using the address switch of the servo amplifier.

The "Select Device" dialog box will be displayed.

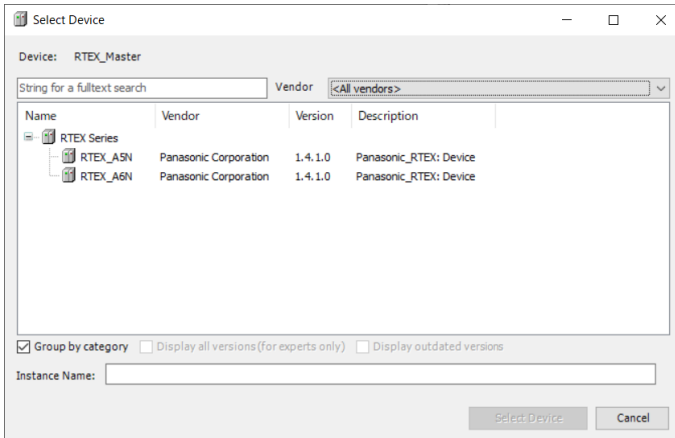

3. Select a device object for the servo amplifier.
The selected device object of the servo amplifier will be added.

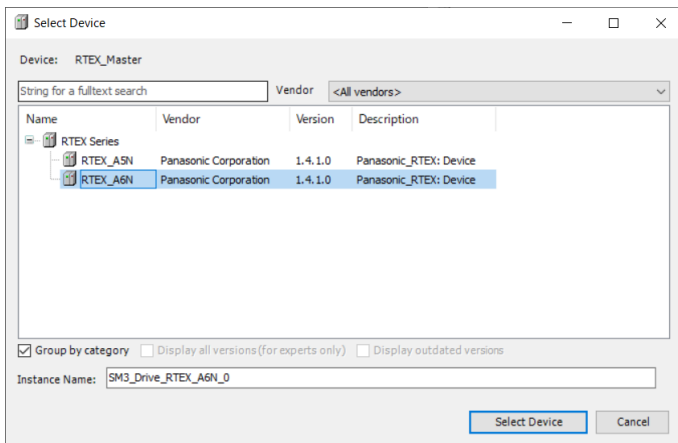

4. Click the [Select Device] button.

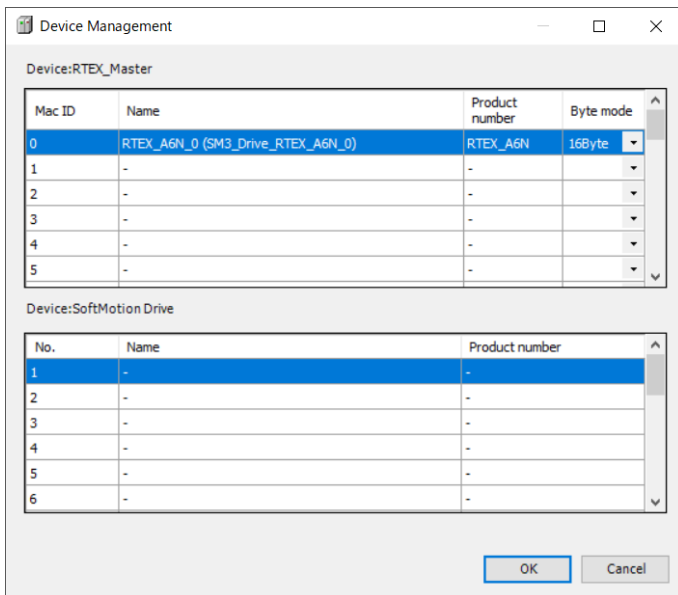

i Info.

- Match the "bite mode" to the byte mode setting of the servo amplifier.
- A servo amplifier set to 16 bytes in "byte mode" is counted as 1 block, and a servo amplifier set to 32 bytes is counted as 2 blocks. You can add devices up to a total of 32 blocks.

5. Click the [OK] button.

The selected device object of the servo amplifier will be added to the navigator pane.

11.1 Setting up the RTEX axis

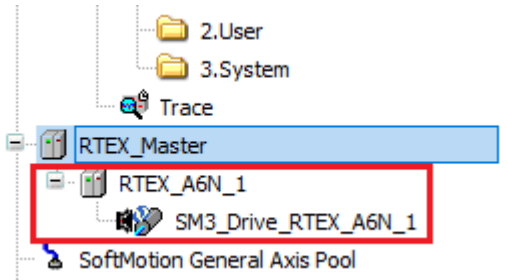

6. Double-click the added object.

The setting pane will be displayed in the main pane. Specify settings related to servo amplifier A6N.

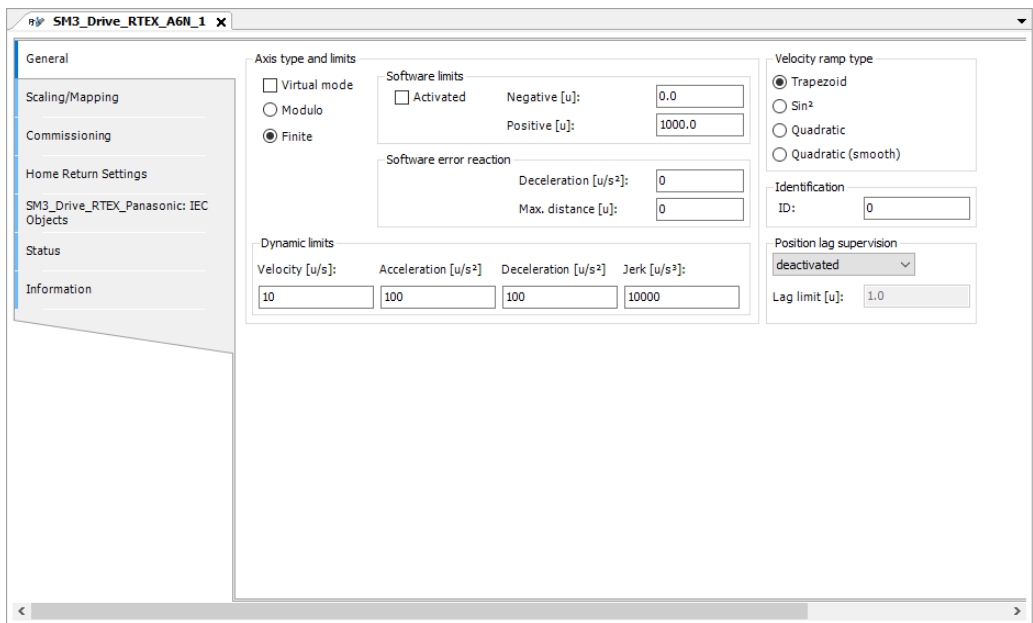

i Info.

- To remove a device object that has been added, select the device object in the navigator pane and press the "Delete" key.

11.1.3 Setting an Address for Each Servo Amplifier

Set the MAC ID using the address switch of the servo amplifier.

The order of connections on the network is not related to the MAC ID.

i Info.

- For details on how to set station numbers for servo amplifiers, refer to the instruction manual of each servo amplifier.

11.2 Conducting Commissioning for Servo Amplifiers

While in the online config mode, you can conduct commissioning for servo amplifiers.

There is no need to create a program for commissioning.

The following is an example of commissioning using the A6N-series servo amplifiers.

1 2 Procedure

1. Double-click the servo amplifier object in the navigator pane.

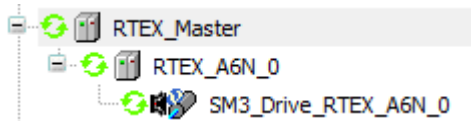

The "RTEX Axis Setting" dialog box will be displayed.

2. Click the "Commissioning" tab.
The Commissioning screen will be displayed.

11.2 Conducting Commissioning for Servo Amplifiers

Drive

Power

ON

OFF

Homing

Forced stop

Stop

Deceleration(I):

10

↑

↓

[u/s²]

Inching

Foward(+)

Backward(-)

Distance:

1

↑

↓

[u]

Velocity:

1

↑

↓

[u/s]

Acceleration:

10

↑

↓

[u/s²]

Deceleration:

10

↑

↓

[u/s²]

Jerk:

0

↑

↓

[u/s³]

*The operation of home return method follows the parameters set on the "Home return setting" tab.

Status

Item	Set Value	Actual Value
Position [u]	0.00	0.00
Velocity [u/s]	0.00	0.00
Acceleration [u/s ²]	0.00	0.00
Torque [%]	-	0.00

Servo ON/OFF:

Off

Communication Status:

initialization of base communication (10)

Error

Clear

All Clear

Error Type	Error Content
Axis error	● No error
Driver error	● No error
RTEX error	
+ FBError	● No error

Group	Description
Drive	Allows the user to set commissioning parameters. Allows the user to execute commissioning.
Status	Displays the running status of the servo amplifiers during commissioning.
Error	Displays errors that occurred during commissioning. Allows the user to clear errors.

- 3.** Click an appropriate button in the Operation group to start commissioning. Clicking an icon starts the corresponding commissioning procedure. To change home return parameters, use the "Home Return Settings" tab.

11.2 Conducting Commissioning for Servo Amplifiers

Drive

Power

ON

OFF

Homing

Forced stop

Stop

Deceleration(T):

[u/s²]

Inching

Forward(+)

Backward(-)

Distance: [u]

Velocity: [u/s]

Acceleration: [u/s²]

Deceleration: [u/s²]

Jerk: [u/s³]

*The operation of home return method follows the parameters set on the "Home return setting" tab.

4. For the servo amplifier and RTEX statuses during commissioning, check the "Status" and "Error" groups.

4-1 To erase errors that are displayed, click the [Clear] button or [All Clear] button in the "Error" group.

- Pressing the [Clear] button will erase axis errors, drive errors, RTEX errors, and FB errors [0].
- Pressing the [All Clear] button will erase axis errors, drive errors, RTEX errors, and FB errors [0] to [5].

Status

Item	Set Value	Actual Value
Position [u]	0.00	0.00
Velocity [u/s]	0.00	0.00
Acceleration [u/s ²]	0.00	0.00
Torque [%]	-	0.00

Servo ON/OFF:

Communication Status:

Error

Clear

All Clear

Error Type	Error Content
Axis error	● No error
Driver error	● No error
RTEX error	● No error
+ FBError	● No error

If the display of FB errors is collapsed, the number of FB errors will be displayed as "0" in the "Error Content" column.

5. From the menu bar, select **Project>Online Config Mode**.

If online config mode is canceled, commissioning will be terminated.

This completes commissioning for servo amplifiers.

11.2 Conducting Commissioning for Servo Amplifiers

Info.

- If you display another window during commissioning, "Stop" will be executed.
- Even if communication with the servo amplifier is disrupted during "Inching" or "Home Return" operation, the servo amplifier will continue commissioning operation.
- If online config mode is canceled, commissioning will be terminated. To cancel the online config mode, select **Project>Online Config Mode** from the menu bar again.

11.3 Home Return

Home return is an operation that returns the motor to its home position.

The GM1 controller supports various home return methods.

Home return can be achieved by setting a desired method in GM Programmer and then executing function block "PMC_Home".

11.3.1 Types of home return

Home return is a function that moves the axis to the preset reference position (home position) and set the coordinates of the position to 0.

If an incremental encoder is used for the servomotor, the home return methods shown in the table below can be selected.

i Info.

- The GM1 controller also supports home return using an absolute encoder. When implementing home return using an absolute encoder, use MINAS V1.24 or later.

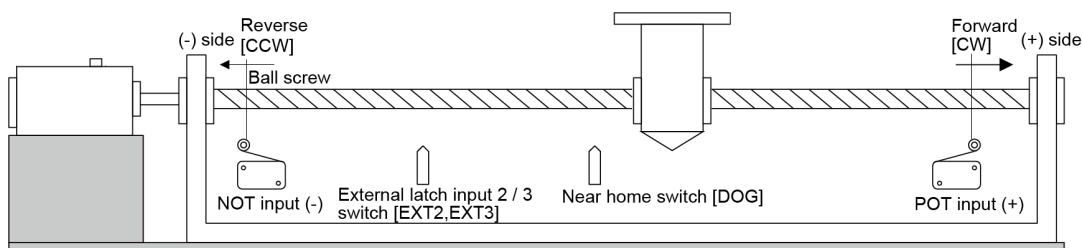

Settings and operations of home return	Behavior overview
DOG method 1	After the rising edge (front edge) of the near home switch (DOG) is detected, the rising edge of the first home position (Z phase) is detected and the motor stops. The stopping position is set as the home position. (Note 1)
DOG method 2	The rising edge of the near home switch (DOG) is detected and the motor stops. The stopping position is set as the home position.
DOG method 3	After the falling edge (rear edge) of the near home switch (DOG) is detected, the rising edge of the first home position (Z phase) in the home return direction is detected and the motor stops. The stopping position is set as the home position. (Note 1)
Limit method 1	After the rising edge of the limit switch on the opposite side of the home return direction is detected, the rotation of the motor is reversed. Then, the rising edge of the first home position (Z phase) is detected and the motor stops. The stopping position is set as the home position. (Note 1)
Limit method 2	The rising edge of the limit switch in the home return direction is detected and the motor stops. The stopping position is set as the home position.
Home return method	The axis moves from the current value toward the direction of home return. Then, the rising edge of the first home position (Z phase) is detected and the motor stops. The stopping position is set as the home position. (Note 1)

11.3 Home Return

Settings and operations of home return	Behavior overview
Stop-on-contact method 1	The axis is stopped by a mechanical stopping mechanism such as a stopper. Then, when the torque value exceeding the specified value continues for a certain period of time, the motor stops. The stopping position is set as the home position.
Stop-on-contact method 2	After the axis is stopped by a mechanical stopping mechanism such as a stopper, the rotation of the motor is reversed. Then, the rising edge of the first home position (Z phase) is detected and the motor stops. The stopping position is set as the home position. (Note 1)
Data set method	The current value is set as the home position.
High-speed home return method	The axis moves to point 0, which is the commanded position.

(Note 1) For E2, external latch input 2 (EXT2) is used instead of the home position (Phase Z). For E3, external latch input 3 (EXT3) is used instead of the home position (Phase Z).

11.3.2 DOG method 1 [Edge detection of near home switch + Home position (Z phase) based on front edge]

After the rising edge (front edge) of the near home switch (DOG) is detected, the rising edge of the first home position (Z phase) is detected and the motor stops. The stopping position is set as the home position.

The reference home position can be selected from the three types shown in the following table.

Type	Reference home position
DOG method 1	Edge detection of near home switch + Home position (Z phase) based on front edge
DOG method 1 (E2)	Edge detection of near home switch + External latch input 2 (EXT2) based on front edge
DOG method 1 (E3)	Edge detection of near home switch + External latch input 3 (EXT3) based on front edge

(Note 1) If the home position (Z phase) is ON at the time of startup, it will not be regarded as a home position (Z phase). Searches for a near home switch (DOG) will be started.

(Note 2) The reference home position differs according to the selected home return type. (Z-phase, EXT2, EXT3)

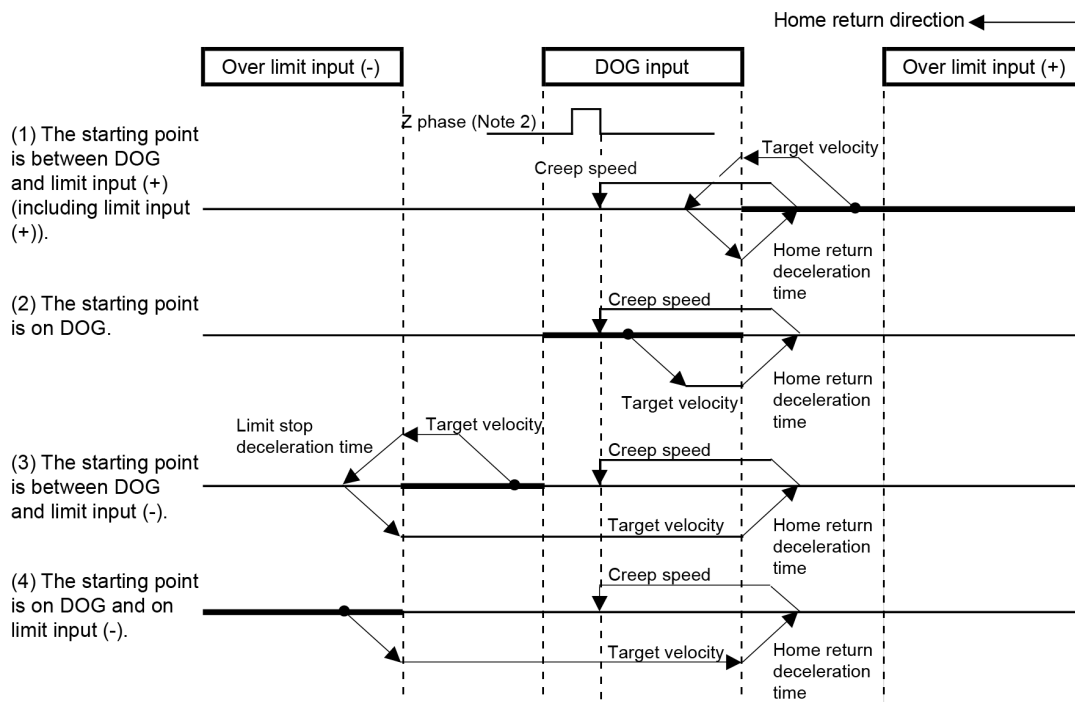

11.3 Home Return

11.3.3 DOG method 2 (Edge detection of near home switch)

The rising edge of the near home switch (DOG) is detected and the motor stops. The stopping position is set as the home position.

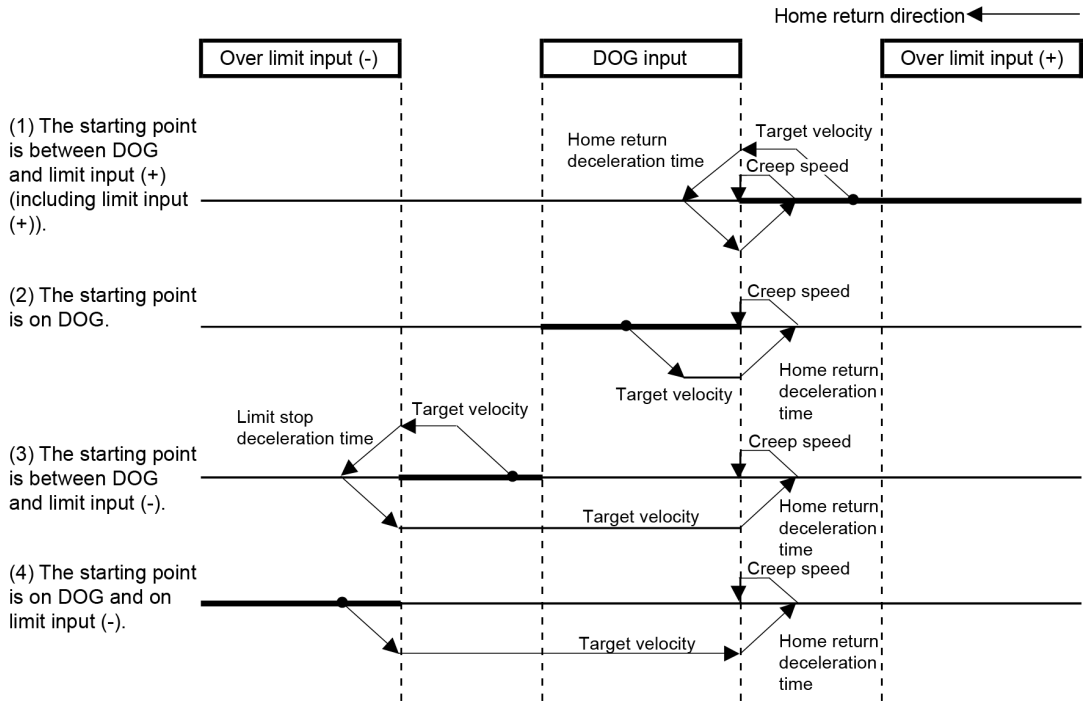

11.3.4 DOG method 3 [Edge detection of near home switch + Home position (Z phase) based on rear edge]

After the falling edge (rear edge) of the near home switch (DOG) is detected, the rising edge of the first home position (Z phase) in the home return direction is detected and the motor stops. The stopping position is set as the home position.

The reference home position can be selected from the three types shown in the following table.

Type	Reference home position
DOG method 3	Edge detection of near home switch + Home position (Z phase) based on rear edge
DOG method 3 (E2)	Edge detection of near home switch + External latch input 2 (EXT2) based on rear edge
DOG method 3 (E3)	Edge detection of near home switch + External latch input 3 (EXT3) based on rear edge

(Note 1) If the home position (Z phase) is ON at the time of startup, it will not be regarded as a home position (Z phase). Searches for a near home switch (DOG) will be started.

(Note 2) The reference home position differs according to the selected home return type. (Z-phase, EXT2, EXT3)

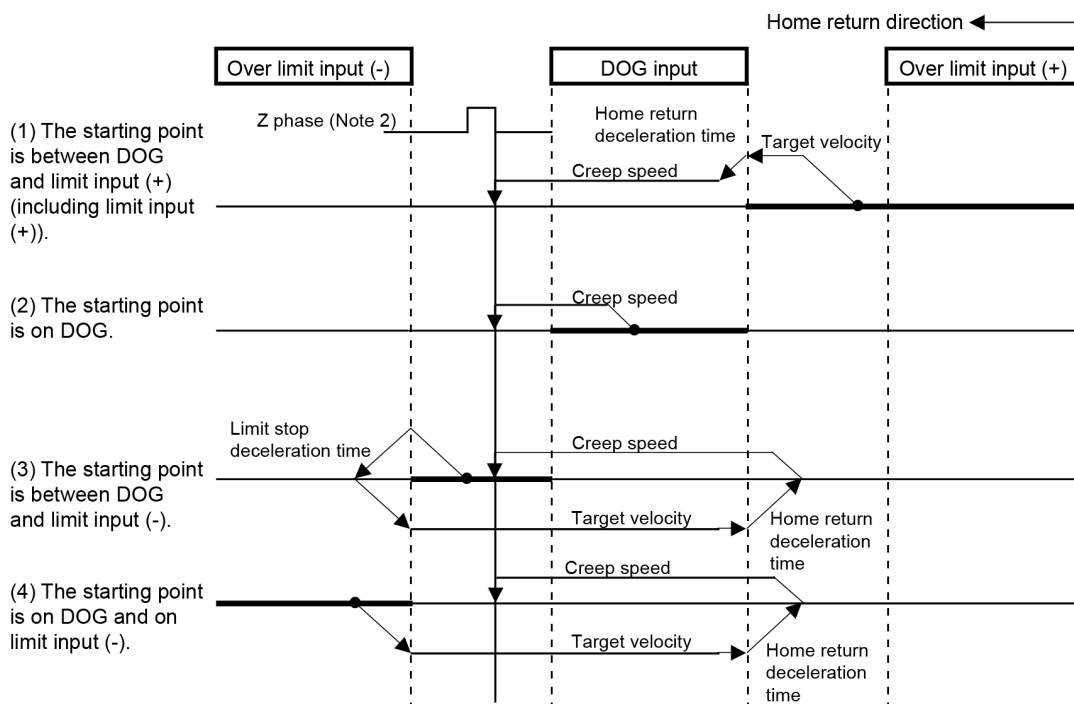

11.3 Home Return

11.3.5 Limit method 1 [Edge detection of limit switch + Home position (Z phase) based on front edge]

After the rising edge of the limit switch on the opposite side of the home return direction is detected, the rotation of the motor is reversed. Then, the rising edge of the first home position (Z phase) is detected and the motor stops. The stopping position is set as the home position. The reference home position can be selected from the three types shown in the following table.

Type	Reference home position
Limit method 1	Edge detection of limit switch + Home position (Z phase) based on front edge
Limit method 1 (E2)	Edge detection of limit switch + External latch input 2 (EXT2) based on front edge
Limit method 1 (E3)	Edge detection of limit switch + External latch input 3 (EXT3) based on front edge

(Note 1) If the home position (Z phase) is ON at the time of startup, it will not be regarded as a home position (Z phase). Searches for a limit switch will be started.

(Note 2) The reference home position differs according to the selected home return type. (Z-phase, EXT2, EXT3)

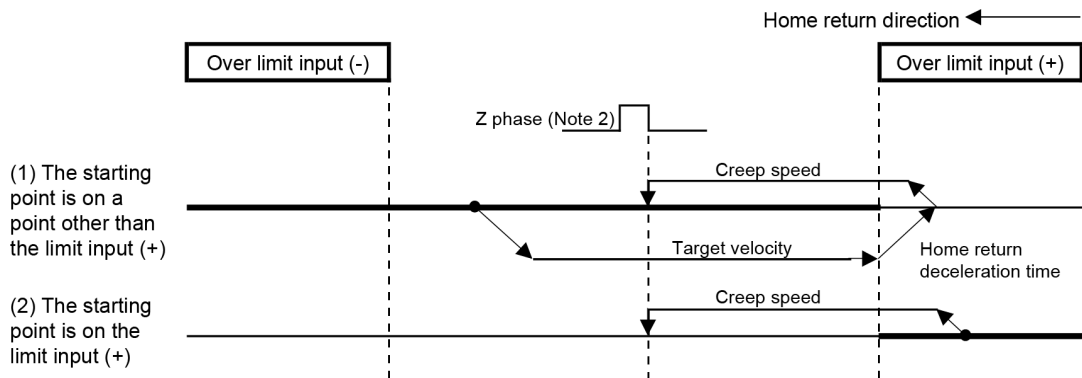

11.3.6 Limit method 2 (Edge detection of limit switch)

The rising edge of the limit switch in the home return direction is detected and the motor stops. The stopping position is set as the home position.

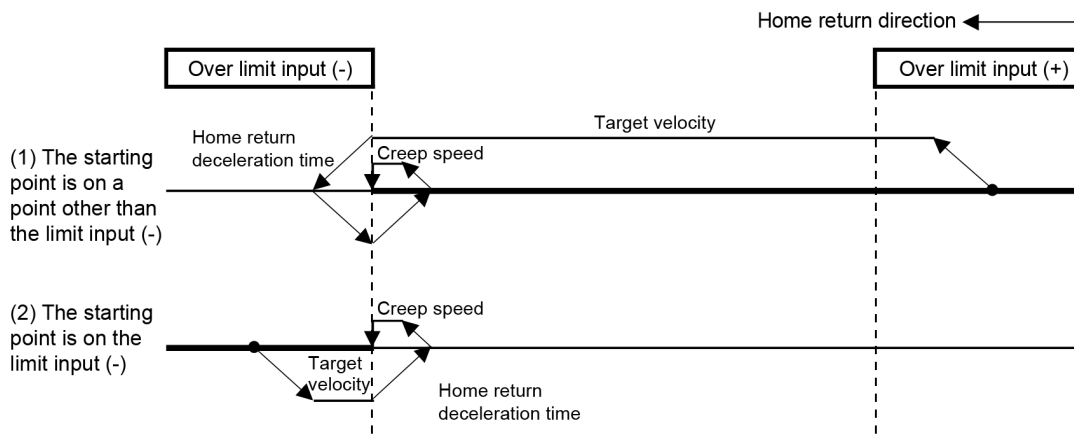

11.3.7 Home position method [Edge detection of home position (Z phase)]

The axis moves from the current value toward the direction of home return. Then, the rising edge of the first home position (Z phase) is detected and the motor stops. The stopping position is set as the home position.

The reference home position can be selected from the three types shown in the following table.

Type	Reference home position
Z-phase method 1	Edge detection of home position (Z phase)
EXT2 method	Edge detection of external latch input 2 (EXT2)
EXT3 method	Edge detection of external latch input 3 (EXT3)

(Note 1) The reference home position differs according to the selected home return type. (Z-phase, EXT2, EXT3)

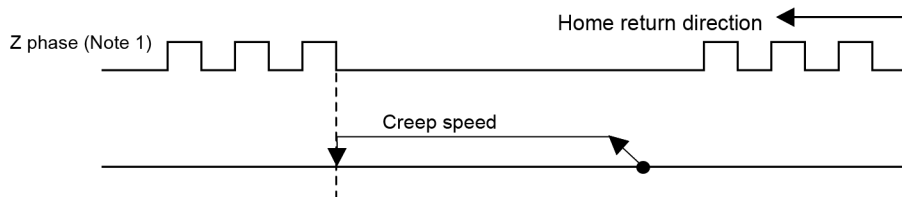

11.3 Home Return

11.3.8 Stop-on-contact method 1

The axis is stopped by a mechanical stopping mechanism such as a stopper. Then, when the torque value exceeding the specified value continues for a certain period of time, the motor stops. The stopping position is set as the home position.

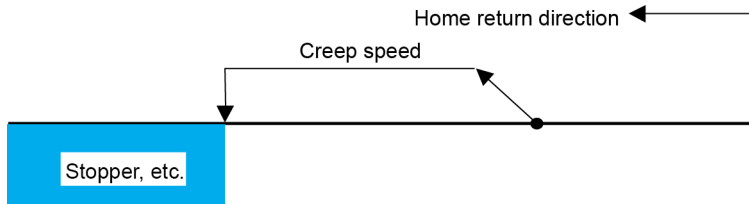

11.3.9 Stop-on-contact method 2 [Stop-on-contact detection + Home position (Z phase) based on front edge]

After the axis is stopped by a mechanical stopping mechanism such as a stopper, the rotation of the motor is reversed. Then, the rising edge of the first home position (Z phase) is detected and the motor stops. The stopping position is set as the home position.

The reference home position can be selected from the three types shown in the following table.

Type	Reference home position
Stop-on-contact method 2	Stop-on-contact detection + Home position (Z phase) based on front edge
Stop-on-contact method 2 (E2)	Stop-on-contact detection + External latch input 2 (EXT2) based on front edge
Stop-on-contact method 2 (E3)	Stop-on-contact detection + External latch input 3 (EXT3) based on front edge

(Note 1) If the home position (Z phase) is ON at the time of startup, it will not be regarded as a home position (Z phase). Searches for a limit switch will be started.

(Note 2) The reference home position differs according to the selected home return type. (Z-phase, EXT2, EXT3)

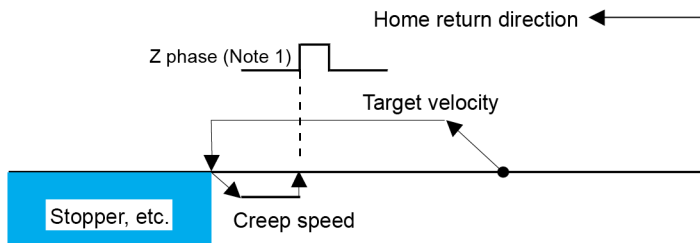

11.3.10 Data set method

The current position is set as the home position.

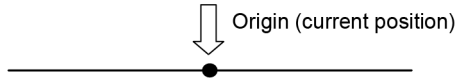

11.3.11 High-speed home return

Executing high-speed home return enables the axis to move to the home position (position 0) of the coordinate system for the absolute encoder.

The behavior is similar to that of positioning. After home return is complete, the deviation counter is not cleared.

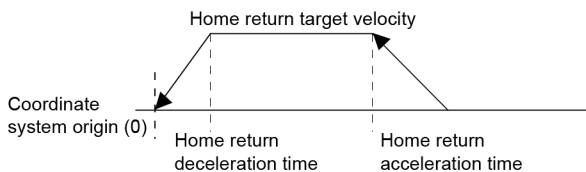

11.3.12 Settings and operations of home return

■ Settings in GM Programmer

To use the home return function, specify various settings in "Home Return Settings" in axis settings.

Specify the following settings according to the home return function to be used.

GM Programmer	Value / Type	Default
Home return method	0: DOG1 1: DOG2 2: DOG3	0: DOG1

11.3 Home Return

GM Programmer	Value / Type	Default
	3: Limit method 1 4: Limit method 2 5: Home return method 6: Stop-on-contact method 1 7: Stop-on-contact method 2 8: Data setting method 10: High-speed home return method	
Target speed	0 or more / LREAL	0
Creep speed	0 or more / LREAL	0
Acceleration	0 or more / LREAL	0
Deceleration	0 or more / LREAL	0
Jerk	0 or more / LREAL	0
Home return direction	1: positive -1: negative	-1: negative
Trigger	17: Z phase 26: EXT2 28: EXT3	17: Z phase
Contact time	TIME	0
Torque threshold	0 or more / LREAL	0

Home return is performed by executing PMC_Home in POU.

For details, refer to *GM1 Series Reference Manual (Instruction Edition)*.

Info.

- To stop an error that occurs in FB processing within PMC_HOME, set error stop conditions in "Software error reaction" on the "General" tab on the "RTEX Axis Setting" dialog box.
- The deceleration to be applied when stopping an error that occurs in FB processing within PMC_Home can be set in "Software error reaction" on the "General" tab on the "SM3_Drive_RTEX_A6N Setting" dialog box.

For the software error reaction, refer to ["General Settings"](#).

11.4 Functional limitations

11.4.1 Restrictions on the Combination of the GM1 Controller and Servo Amplifiers

As for the combination of the GM1 Controller and each MINAS series, confirm the following restrictions.

Combination of the GM1 Controller and servo amplifiers

Connectable servo amplifier		Description
A5N	A6N	
•	•	A5N and A6N can be connected to the same network.

Note

- When using servo amplifiers in combination with the GM1 Controller, use the ones with the latest software version.

Setting ranges of movement amount and speed

The input range of the movement amount or speed specified in the GM1 Controller may differ from the upper and lower setting limits of the servo amplifier.

Info.

- The input range of the movement amount or speed specified in the GM1 Controller may differ from the upper and lower setting limits of the servo amplifier.
 - RTEX-compatible GM1 Controller: Communication cycle: 500 μ s to 2 ms, Command update cycle: 500 μ s to 4ms
 - Servo amplifier A5N: Communication cycle: 500 μ s to 1 ms, Command update cycle: 500 μ s to 1 ms
 - Servo amplifier A6N: Communication cycle: 500 μ s to 2 ms, Command update cycle: 500 μ s to 4 ms

11.4.2 Restrictions on Servo Amplifier Parameters

Some parameters for servo amplifiers on the A5N/A6N side affect the behaviors of the RTEX-compatible GM1 Controller. Use the following parameters.

No.	Name	Description	Standard factory default setting
Pr5.04	Over-travel inhibit input setup	Use setting value "1 (Disable the over-travel inhibit input)". (Mandatory)	1 ^(Note 1)
Pr7.22	RTEX function extended setup 1	With a setting of 0 (16-byte mode), the maximum connection is 32 axes. With setting 1 (32-byte mode), the maximum number of connections is 16 axes.	0 ^(Note 2)

11.4 Functional limitations

No.	Name	Description	Standard factory default setting
		(Default setting value: 0)	
Pr7.23	RTEX function extended setup 2	<p>Use setting value "18". (Mandatory) This parameter sets each function in bits.</p> <p>bit 0: Allow parameter values to be written via RTEX communication 0: Allow, 1: Disallow</p> <p>bit 1: Set a sub-number for alarm code 0: Fixed at 0, 1: Enable sub-number</p> <p>bit 2: Set RTEX status response conditions when "Over-travel inhibit input setup" is disabled (Pr5.04 = 1) 0: Enable status, 1: Fixed at 0</p> <p>bit 3: Set RTEX status bit assignment for POT and NOT 0: POT corresponds to bit 1 and NOT corresponds to bit 0, 1: NOT corresponds to bit 1 and POT corresponds to bit 0 0: POT corresponds to bit 1 and NOT corresponds to bit 0, 1: NOT corresponds to bit 1 and POT corresponds to bit 0</p> <p>bit 4: Set display mode for "COM" LED 0: Mode 1, 1: Mode 2</p> <p>bit 5: Set non-cyclic command start mode 0: When a change from base command occurs 1: When command code or command argument changes</p> <p>bit 6: Set RTEX status logic for POT and NOT 0: Do not reverse, 1: Reverse</p> <p>bit 7: Set RTEX status logic for PSL and NSL 0: Do not reverse, 1: Reverse</p> <p>bit 8: Select RTEX status from In_Progress / AC_OFF 0: In_Progress, 1: AC_OFF (It is linked to the setting in bit 15.)</p> <p>bit 9: Select whether to return a command error when a command for motion toward the direction of over-travel prohibition is received after deceleration stop is executed by "Over-travel inhibit input setup" 0: Do not return a command error 1: Return a command error</p> <p>(Bit 10 to bit 13 are not used.) Fix to "0".</p> <p>bit 14: Set position deviation [command unit] output 0: Internal commanded position (after filtering) [command unit] - Actual position [command unit] 1: Internal commanded position (before filtering) [command unit] - Actual position [command unit]</p> <p>Bit 15: Select extended RTEX status from In_Progress / AC_OFF / Pr7.112 settings 0: Follow the setting of Pr7.23 bit 8 (In_Progress / AC_OFF)</p>	18(Note 2)

No.	Name	Description	Standard factory default setting
		1: Follow the setting of Pr7.112.	
Pr7.25	RTEX speed unit setup	Use setting value "1 (command unit/s)". (Mandatory)	0 ^(Note 2)

(Note 1) We recommend that the set value should not be changed judging from the characteristics of the GM1 and MINAS.

(Note 2) Do not change the set value. If the set value is changed, the GM1 Controller will make an error stop.

(MEMO)

12 Unit Function

12.1 Overview of Unit Control	12-2
12.2 Setting up the GM1 units	12-3
12.2.1 IO Parameters for Unit Control	12-5
12.2.2 I/O Mapping for Unit Control	12-6
12.2.3 General-purpose I/O	12-7
12.2.4 PWM Output	12-12
12.2.5 High-speed Counter Function	12-23
12.3 Expansion unit settings	12-73
12.3.1 Adding Expansion Units	12-73
12.3.2 Settings of I/O Unit	12-76
12.3.3 Analog I/O Unit	12-79
12.3.4 Pulse Output Unit	12-79
12.3.5 Serial Communication Unit	12-79

12.1 Overview of Unit Control

12.1 Overview of Unit Control

Unit control provides control for the controller functions (I/O, PWM, and counter) and expansion units.

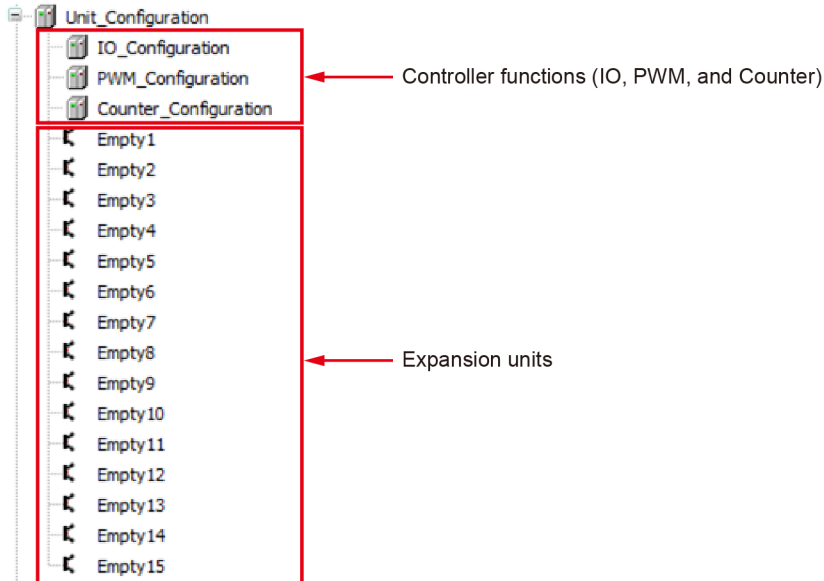

12.2 Setting up the GM1 units

This section explains how to set up general-purpose I/O, PWM output, and high-speed counter for the GM1 Controller.

The object of each unit is shown below.

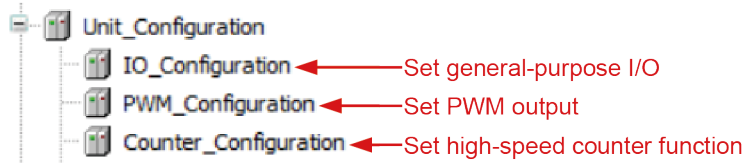

Info.

- For details on general-purpose I/O, refer to "12.2.3 General-purpose I/O".
- For details on PWM output, refer to "12.2.4 PWM Output".
- For details on the high-speed counter function, refer to "12.2.5 High-speed Counter Function".

For example, use the following procedure to set up a high-speed counter.

1 2 Procedure

1. In the navigator pane, double-click the [Counter_Configuration] object. The high-speed counter setting window will be displayed.

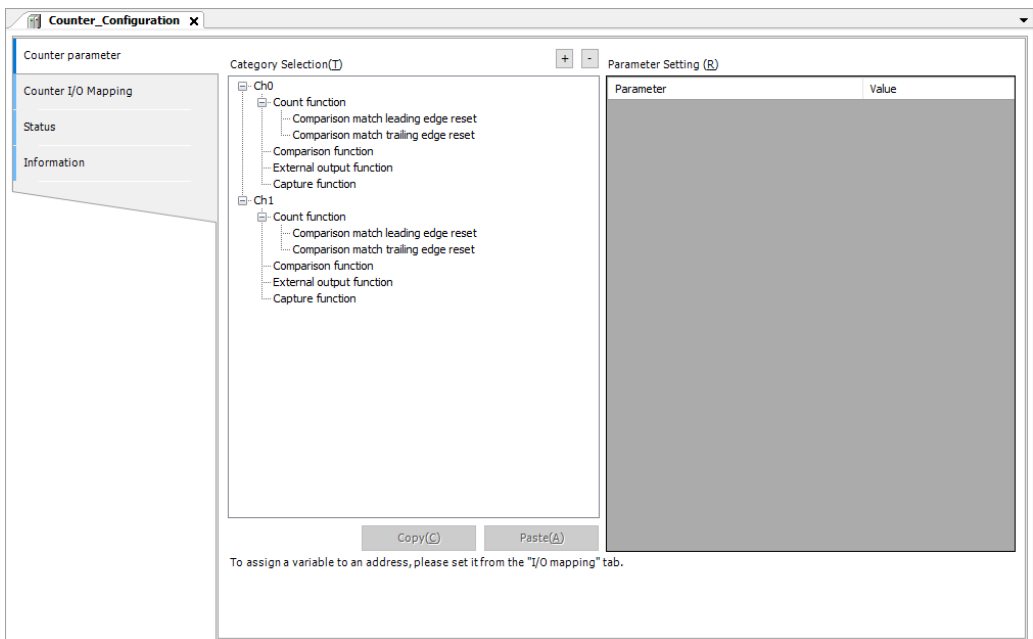

2. Set up parameters for the high-speed counter. Select the category of a channel to be set up in the "Category Selection" section and enter values in the "Parameter Settings" section.

12.2 Setting up the GM1 units

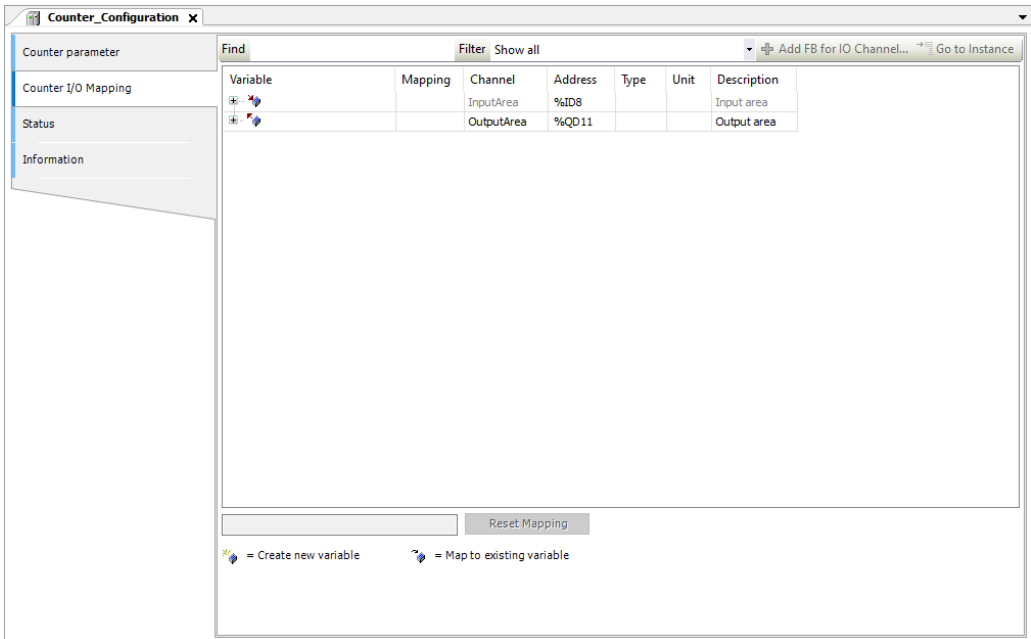

3. Select the "Counter I/O Mapping" tab and set the correspondence (mapping) between the channel and variable in the mapping setting pane.

Click the "Variable" column corresponding to the channel to be used by the program and enter a variable name.

Clicking the mark in the "Mapping" column allows you to change the type of mapping.

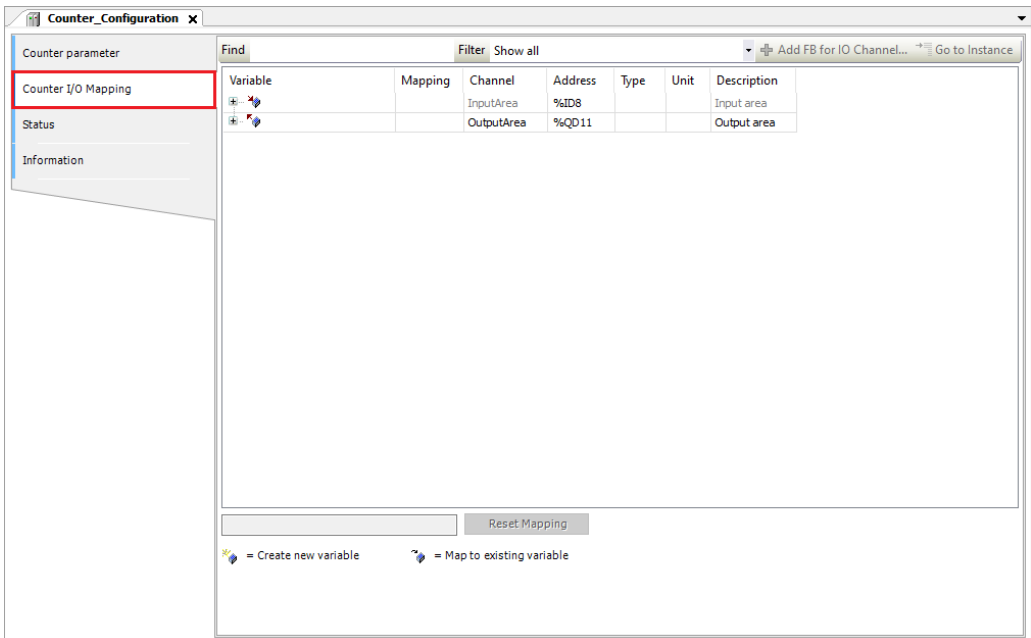

i Info.

- You can copy the parameter set in a channel. To do so, select a channel (CH0 or CH1) in the "Category Selection" column and click the [Copy] button. Next, select another channel and click the [Paste] button.

12.2.1 IO Parameters for Unit Control

The parameter window is used to set up parameters for the controller functions (I/O, PWM, and counter) and each expansion unit.

This section explains parameter settings, using IO_Configuration as an example.

In the navigator pane, double-click the "IO_Configuration" object. The "IO_Configuration" pane will be displayed.

In the "IO_Configuration" pane, click the "IO Parameters" tab. The parameter settings sub-pane will be displayed. Change the settings according to your need.

Select the IO Parameters tab

The screenshot shows the 'IO_Configuration' window with the 'IO parameter' tab selected. The 'Parameter Settings' sub-pane is visible, containing the following sections:

- General-Purpose input time constant**
 - Input time constant: None
- Input port configuration**

X0	IO(Ch0_In00)
X1	IO(Ch0_In01)
X2	IO(Ch0_In02)
X3	IO(Ch0_In03)
- Output port configuration** (highlighted as 'Setting item')

Y0	IO(Ch0_Out00)
Y1	IO(Ch0_Out01)
Y2	IO(Ch0_Out02)
Y3	IO(Ch0_Out03)
Y4	IO(Ch0_Out04)
Y5	IO(Ch0_Out05)
Y6	IO(Ch0_Out06)
Y7	IO(Ch0_Out07)
- X0**
 - IO(Ch0_In00), Counter(Ch0_Control0)

At the bottom, a note states: "To assign a variable to an address, please set it from the "/>

12.2 Setting up the GM1 units

12.2.2 I/O Mapping for Unit Control

The I/O mapping window is used to allocate variables to I/O mapping for the controller functions (I/O, PWM, and counter) and each expansion unit.

This section explains I/O mapping, using IO_Configuration as an example.

Click the "I/O Mapping" tab in the Device pane. The I/O mapping pane will be displayed.

Register variables directly from the variable or I/O mapping window declared in the Application object.

Select the I/O Mapping tab

Variable	Mapping	Channel	Address	Type	Unit	Description
		InputArea	%IW8			Input area
		Ch0_In	%IW8	WORD		Ch0_In
		Ch0_In00	%IX16.0	BOOL		Ch0_In00
		Ch0_In01	%IX16.1	BOOL		Ch0_In01
		Ch0_In02	%IX16.2	BOOL		Ch0_In02
		Ch0_In03	%IX16.3	BOOL		Ch0_In03
		Ch0_In04	%IX16.4	BOOL		Ch0_In04
		Ch0_In05	%IX16.5	BOOL		Ch0_In05
		Ch0_In06	%IX16.6	BOOL		Ch0_In06
		Ch0_In07	%IX16.7	BOOL		Ch0_In07
		Ch0_In08	%IX17.0	BOOL		Ch0_In08
		Ch0_In09	%IX17.1	BOOL		Ch0_In09
		Ch0_In10	%IX17.2	BOOL		Ch0_In10
		Ch0_In11	%IX17.3	BOOL		Ch0_In11
		Ch0_In12	%IX17.4	BOOL		Ch0_In12
		Ch0_In13	%IX17.5	BOOL		Ch0_In13
		Ch0_In14	%IX17.6	BOOL		Ch0_In14
		Ch0_In15	%IX17.7	BOOL		Ch0_In15
		OutputArea	%QW6			Output area
		Ch0_Out	%QW6	WORD		Ch0_Out
		Ch0_Out00	%QX12.0	BOOL		Ch0_Out00
		Ch0_Out01	%QX12.1	BOOL		Ch0_Out01
		Ch0_Out02	%QX12.2	BOOL		Ch0_Out02
		Ch0_Out03	%QX12.3	BOOL		Ch0_Out03
		Ch0_Out04	%QX12.4	BOOL		Ch0_Out04
		Ch0_Out05	%QX12.5	BOOL		Ch0_Out05
		Ch0_Out06	%QX12.6	BOOL		Ch0_Out06
		Ch0_Out07	%QX12.7	BOOL		Ch0_Out07
		Ch0_Out08	%QX13.0	BOOL		Ch0_Out08
		Ch0_Out09	%QX13.1	BOOL		Ch0_Out09
		Ch0_Out10	%QX13.2	BOOL		Ch0_Out10
		Ch0_Out11	%QX13.3	BOOL		Ch0_Out11
		Ch0_Out12	%QX13.4	BOOL		Ch0_Out12
		Ch0_Out13	%QX13.5	BOOL		Ch0_Out13
		Ch0_Out14	%QX13.6	BOOL		Ch0_Out14
		Ch0_Out15	%QX13.7	BOOL		Ch0_Out15

12.2.3 General-purpose I/O

Overview of General-purpose I/O Function

The general-purpose I/O function allows use of up to 16 input points and 16 output points.

* However, the general-purpose I/O function shares some ports with the high-speed counter function and PWM output function. Therefore, use IO parameter settings to select functions to be used.

■ **Specification overview**

Item	Specifications	Remarks
Number of input ports	Max. 16 points	X0 to X3 are shared with the counter function. Use IO parameter settings to select functions to be used.
Number of output ports	Max. 16 points	Y0 to Y3 are shared with the counter function and Y4 to Y7 are shared with the PWM output function. Use IO parameter settings to select functions to be used.
Input port number	X0 to X15	
Output port number	Y0 to Y15	

Setting Parameters with GM Programmer

1 2 Procedure

1. In the navigator pane, double-click the "IO_Configuration" object. The general-purpose IO setting pane will be displayed.

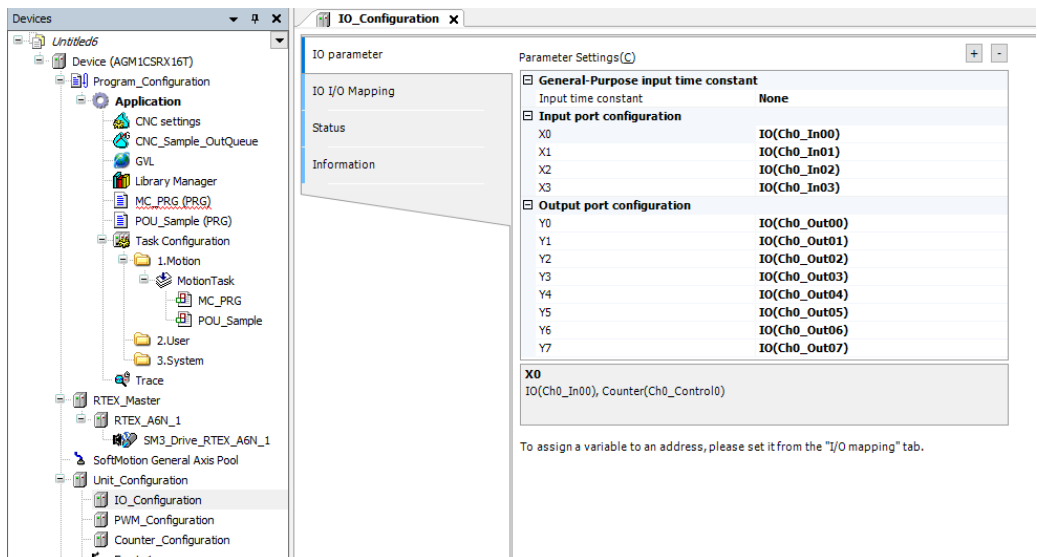

12.2 Setting up the GM1 units

2. Set up general-purpose IO parameters.

Select an IO parameter to be changed and then select a desired item from the drop-down list.

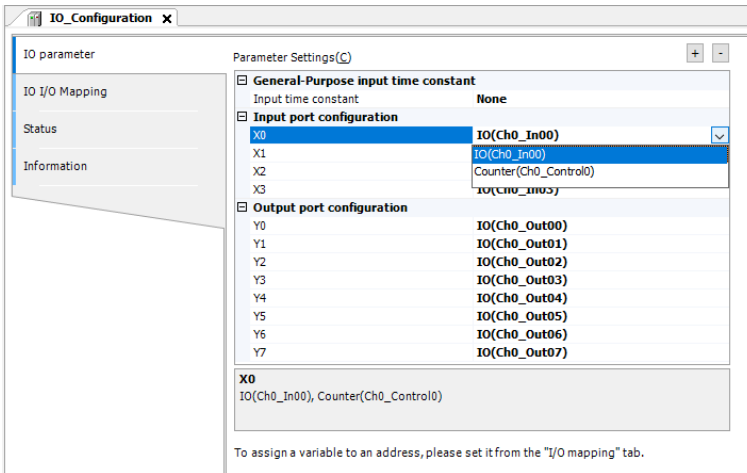

3. Select the "I/O Mapping" tab and set the correspondence (mapping) between the channel and variable in the mapping setting pane.

Click the "Variable" column corresponding to the channel to be used by the program and enter a variable name.

Clicking the mark in the "Mapping" column allows you to change the type of mapping.

The screenshot shows the 'IO_Configuration' window with the 'I/O Mapping' tab selected. The table below lists the mapping between channels and variables.

Variable	Mapping	Channel	Address	Type	Unit	Description
		InputArea	%IW8			Input area
		Ch0_In	%IW8	WORD		Ch0_In
		OutputArea	%QW6			Output area
		Ch0_Out	%QW6	WORD		Ch0_Out
		Ch0_Out0	%QX12.0	BOOL		Ch0_Out00
		Ch0_Out1	%QX12.1	BOOL		Ch0_Out01
		Ch0_Out2	%QX12.2	BOOL		Ch0_Out02
		Ch0_Out3	%QX12.3	BOOL		Ch0_Out03
		Ch0_Out4	%QX12.4	BOOL		Ch0_Out04

i Info.

- You can copy the variable name set in the Channel column.

Select a channel (CH0 or CH1) in the "Category Selection" column, right-click, and then select [Copy] from the context-sensitive menu that is displayed. Next, select another channel, right-click, and then select [Paste] from the context-sensitive menu that is displayed.

Setting Items of IO_Configuration Parameters

■ IO parameters

Setting item	Setting item	Settings	Default value	Description
General-purpose input time constant	Input time constant	None 0.1 ms 0.5 ms 1 ms 5 ms 10 ms 20 ms 70 ms	None	Input time constant
Input function setting	X0	IO(Ch0_In00) Counter(Ch0_Control0)	IO(Ch0_In00)	Select X0
	X1	IO(Ch0_In01) Counter(Ch0_Control1)	IO(Ch0_In01)	Select X1
	X2	IO(Ch0_In02) Counter(Ch1_Control0)	IO(Ch0_In02)	Select X2
	X3	IO(Ch0_In03) Counter(Ch1_Control1)	IO(Ch0_In03)	Select X3
Output function setting	Y0	IO(Ch0_Out00) Counter(Ch0_ExternalOutput0)	IO(Ch0_Out00)	Select Y0
	Y1	IO(Ch0_Out01) Counter(Ch0_ExternalOutput1)	IO(Ch0_Out01)	Select Y1
	Y2	IO(Ch0_Out02) Counter(Ch1_ExternalOutput0)	IO(Ch0_Out02)	Select Y2
	Y3	IO(Ch0_Out03) Counter(Ch1_ExternalOutput1)	IO(Ch0_Out03)	Select Y3
	Y4	IO(Ch0_Out04) PWM(Ch0_PWM_Output)	IO(Ch0_Out04)	Select Y4
	Y5	IO(Ch0_Out05) PWM(Ch1_PWM_Output)	IO(Ch0_Out05)	Select Y5
	Y6	IO(Ch0_Out06) PWM(Ch2_PWM_Output)	IO(Ch0_Out06)	Select Y6
	Y7	IO(Ch0_Out07) PWM(Ch3_PWM_Output)	IO(Ch0_Out07)	Select Y07

12.2 Setting up the GM1 units

I/O Mapping for General-purpose I/O

Channel	Type	Description	Remarks
Ch0_In	WORD	Ch0_In	
Ch0_Out	WORD	Ch0_Out	

■ Ch0_In

Channel	Type	Description	Remarks
Ch0_In00	BOOL	Ch0_In00	
Ch0_In01	BOOL	Ch0_In01	
Ch0_In02	BOOL	Ch0_In02	
Ch0_In03	BOOL	Ch0_In03	
Ch0_In04	BOOL	Ch0_In04	
Ch0_In05	BOOL	Ch0_In05	
Ch0_In06	BOOL	Ch0_In06	
Ch0_In07	BOOL	Ch0_In07	
Ch0_In08	BOOL	Ch0_In08	
Ch0_In09	BOOL	Ch0_In09	
Ch0_In10	BOOL	Ch0_In10	
Ch0_In11	BOOL	Ch0_In11	
Ch0_In12	BOOL	Ch0_In12	
Ch0_In13	BOOL	Ch0_In13	
Ch0_In14	BOOL	Ch0_In14	
Ch0_In15	BOOL	Ch0_In15	

■ Ch0_Out

Channel	Type	Description	Remarks
Ch0_Out00	BOOL	Ch0_Out00	
Ch0_Out01	BOOL	Ch0_Out01	
Ch0_Out02	BOOL	Ch0_Out02	
Ch0_Out03	BOOL	Ch0_Out03	
Ch0_Out04	BOOL	Ch0_Out04	
Ch0_Out05	BOOL	Ch0_Out05	
Ch0_Out06	BOOL	Ch0_Out06	
Ch0_Out07	BOOL	Ch0_Out07	
Ch0_Out08	BOOL	Ch0_Out08	
Ch0_Out09	BOOL	Ch0_Out09	
Ch0_Out10	BOOL	Ch0_Out10	
Ch0_Out11	BOOL	Ch0_Out11	

12.2 Setting up the GM1 units

Channel	Type	Description	Remarks
Ch0_Out12	BOOL	Ch0_Out12	
Ch0_Out13	BOOL	Ch0_Out13	
Ch0_Out14	BOOL	Ch0_Out14	
Ch0_Out15	BOOL	Ch0_Out15	

12.2 Setting up the GM1 units

12.2.4 PWM Output

Overview of PWM Output

The PWM output function enables up to 100 kHz of PWM output to be obtained within a range of 0% to 100%.

■ Outline of specifications

Item	Specifications	Remarks
Number of output channels	Max. 4 channels	
Output port number	Y4 to Y7	
Output frequency	1 Hz to 100 kHz (Settable by 1 Hz) ^(Note 1)	
Output duty ratio	0% to 100% (Settable by 0.1%)	
Control input	Enable request or start request	

(Note 1) This specification applies when push-pull is set and output current is 0.1 A. It varies according to loads.

Setting Output Ports with GM Programmer

You can set output ports for PWM output via **IO_Configuration>Edit Object** in GM Programmer.

1 2 Procedure

1. From "Device view" in the navigator pane, double-click "IO_Configuration".

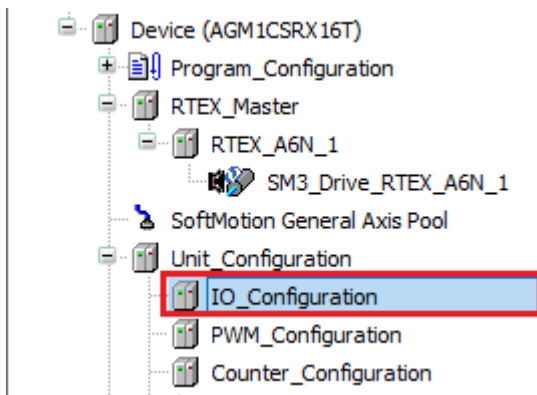

2. Click the "IO parameter" tab.

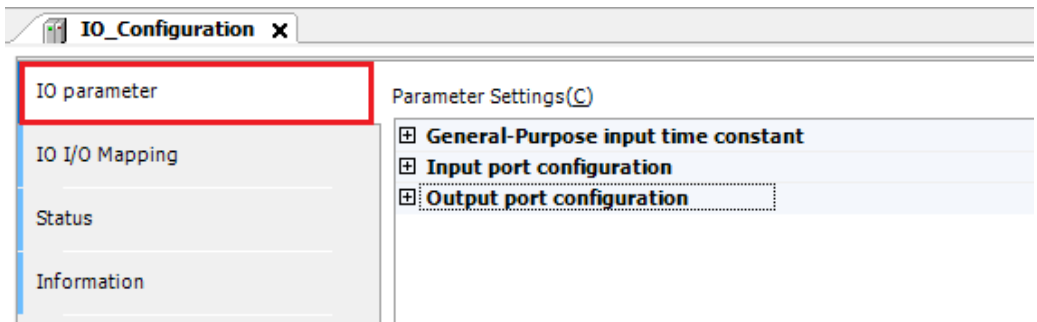

3. If necessary, change Y4 to Y7 in "Output port configuration" to PWM(Ch0_PWM_Output) to PWM(Ch3_PWM_Output), respectively.

Parameter Settings(C)

+ General-Purpose input time constant	
+ Input port configuration	
- Output port configuration	
Y0	IO(Ch0_Out00)
Y1	IO(Ch0_Out01)
Y2	IO(Ch0_Out02)
Y3	IO(Ch0_Out03)
Y4	PWM(Ch0_PWM_Output)
Y5	PWM(Ch1_PWM_Output)
Y6	PWM(Ch2_PWM_Output)
Y7	PWM(Ch3_PWM_Output)

12.2 Setting up the GM1 units

I/O Mapping for PWM Output

The high-speed counter function is controlled by user programs.

■ InputArea (input area)

Channel	Type	Description	Remarks
PwmStatusRegister	WORD	Input area	-

■ PwmStatusRegister (PWM status register)

Channel	Type	Description	Remarks
Ch*_PwmStatus	BOOL	Ch* PWM output status	Indicates the PWM output state. FALSE: OFF TRUE: ON

■ OutputArea (output area)

Channel	Type	Description	Remarks
PwmRequestRegister	WORD	PWM request register	-
Ch*_FrequestValue	UDINT	Ch* frequency set value	Unit: Hz (0 to 100,000 Hz)
Ch* DutyValue	UINT	Ch* duty ratio set value	Unit: 0.1% (0 to 100.0%)

■ PwmRequestRegister (PWM request register)

Channel	Type	Description	Remarks
Ch*_PwmStartRequest	BOOL	Ch* start request	PWM output is started at the rising edge.
Ch*_PwmEnableRequest	BOOL	Ch* enable request	FALSE: Disables PWM output TRUE: Enables PWM output

Data Update Timing (Output Frequency)

The data update timing for output frequency during PWM output is described below.

■ Data update at the rising edge of start request bit

In this mode, the frequency value to be changed is written to the frequency set value and updated with data at the point in time when the start request bit is switched from OFF to ON. The frequency value changed in this timing is reflected at the falling edge of the pulse that is being output.

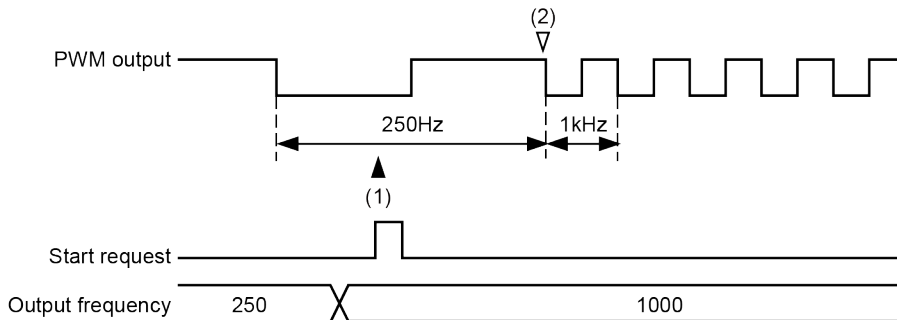

No.	Name	Description
(1)	Data update timing	Indicates the timing in which the frequency set value is reflected
(2)	Output update timing	Indicates the timing in which the changed frequency is reflected as actual output

12.2 Setting up the GM1 units

Data Update Timing (Duty Ratio)

The data update timing for duty ratios during PWM output is described below.

■ Data update at the rising edge of start request bit

In this mode, the duty ratio to be changed is written to the duty ratio set value and updated with data at the point in time when the start request bit is switched from OFF to ON. The duty ratio changed in this timing is reflected at the falling edge of the pulse that is being output.

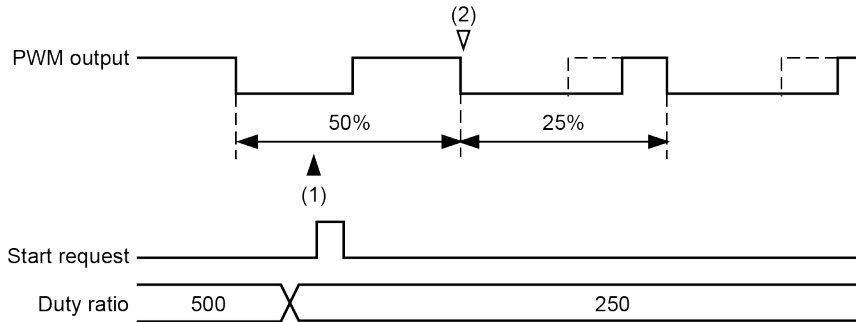

No.	Name	Description
(1)	Data update timing	Indicates the timing in which the duty ratio set value is reflected
(2)	Output update timing	Indicates the timing in which the changed duty ratio is reflected as actual output

PWM Output Setting Example

■ Overview

PWM output is performed. It is controlled by the switch input (X0 or X1) connected to the GM1 controller. If the start request bit is turned ON when the enable request bit is ON, PWM output will be started.

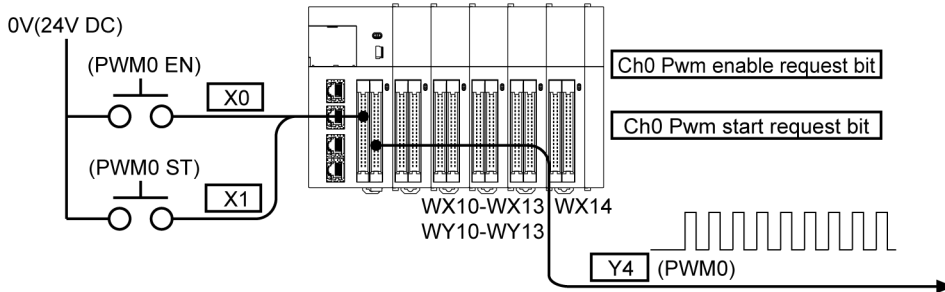

■ Settings in GM Programmer

For example, to set PWM output for Y4, use the procedure in ["Setting Output Ports with GM Programmer"](#) to configure settings as shown below.

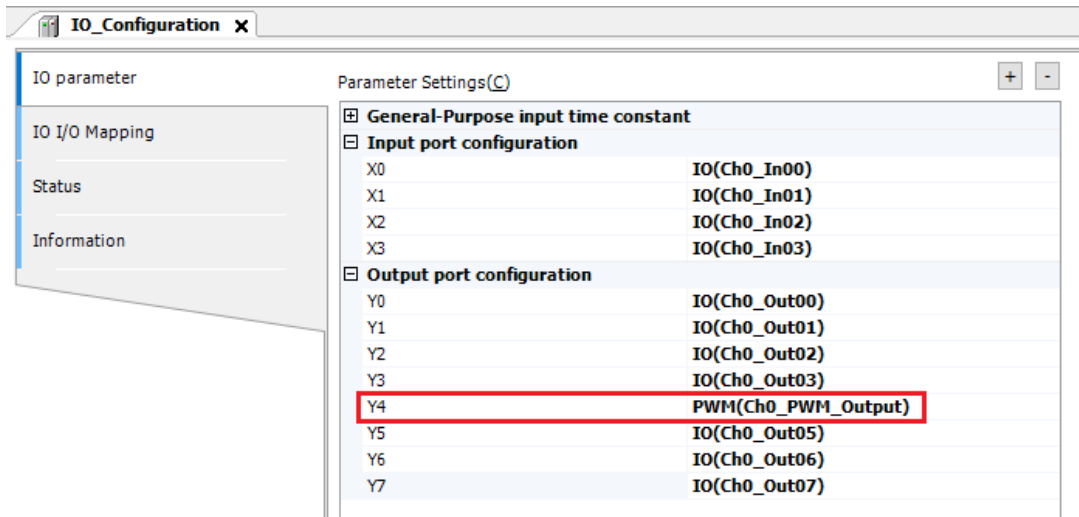

Next, perform I/O mapping for variables created in POU.

1. From "Device view" in the navigator pane, double-click "PWM_Configuration".

12.2 Setting up the GM1 units

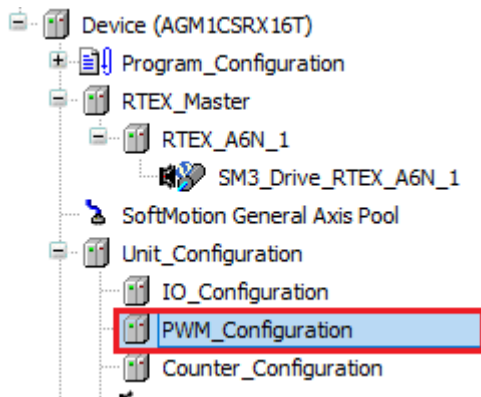

The "PWM_Configuration" window will be displayed.

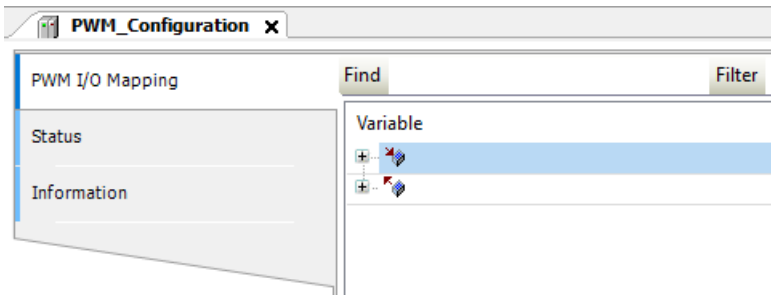

2. In the "PWM_Configuration" window, click the "PWM I/O Mapping" tab.

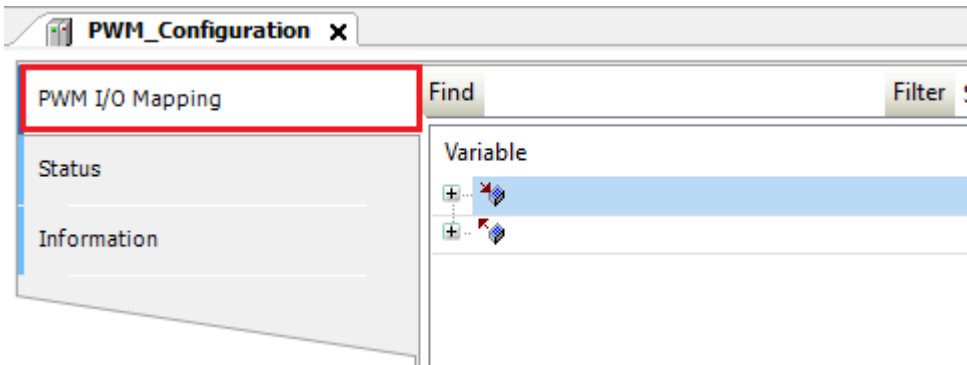

3. In this example, variables with the same name as the channel name are mapped to the channels required for PWM Ch0 (the name of sample POU is created as "PWM").

Variable	Mapping	Channel	Address	Type	Unit	Description
		InputArea	%IW10	WORD		Input area
		PwmStatusRegister	%IW10	WORD		PwmStatusRegister
Application.PWM.Ch0_PWMState		Ch0_PwmStatus	%IX20.0	BOOL		Ch0 Pwm status
		Ch1_PwmStatus	%IX20.1	BOOL		Ch1 Pwm status
		Ch2_PwmStatus	%IX20.2	BOOL		Ch2 Pwm status
		Ch3_PwmStatus	%IX20.3	BOOL		Ch3 Pwm status
		OutputArea	%QD4	WORD		Output area
		PwmRequestRegister	%QW8	WORD		Pwm request register
Application.PWM.Ch0_PWMStartRequest		Ch0_PwmStartRequest	%QX16.0	BOOL		Ch0 Pwm start request
		Ch1_PwmStartRequest	%QX16.1	BOOL		Ch1 Pwm start request
		Ch2_PwmStartRequest	%QX16.2	BOOL		Ch2 Pwm start request
		Ch3_PwmStartRequest	%QX16.3	BOOL		Ch3 Pwm start request
Application.PWM.Ch0_PWMEnableRequest		Ch0_PwmEnableRequest	%QX16.4	BOOL		Ch0 Pwm enable request
		Ch1_PwmEnableRequest	%QX16.5	BOOL		Ch1 Pwm enable request
		Ch2_PwmEnableRequest	%QX16.6	BOOL		Ch2 Pwm enable request
		Ch3_PwmEnableRequest	%QX16.7	BOOL		Ch3 Pwm enable request
Application.PWM.Ch0_FreqestValue		Ch0_FrequencyValue	%QD5	UDINT		Ch0 frequency set
		Ch1_FrequencyValue	%QD6	UDINT		Ch1 frequency set
		Ch2_FrequencyValue	%QD7	UDINT		Ch2 frequency set
		Ch3_FrequencyValue	%QD8	UDINT		Ch3 frequency set
Application.PWM.Ch0_DutyValue		Ch0_DutyValue	%QW18	UINT		Ch0 duty set
		Ch1_DutyValue	%QW19	UINT		Ch1 duty set
		Ch2_DutyValue	%QW20	UINT		Ch2 duty set
		Ch3_DutyValue	%QW21	UINT		Ch3 duty set

- From Device view in the navigator pane, double-click "IO_Configuration".

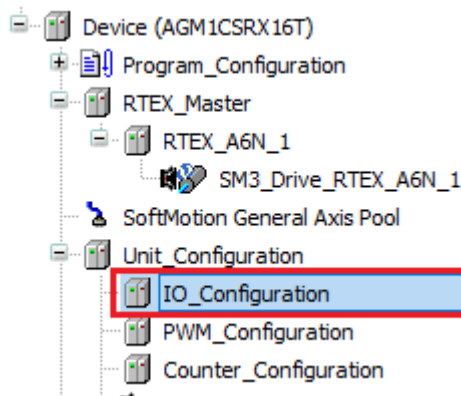

The "IO_Configuration" window will be displayed.

IO parameter	Find	Filter	Show all
IO I/O Mapping	Variable	Mapping	Channel Address Type
Status			InputArea %IW8 WORD
Information			Ch0_In %IW8 WORD
	Application.PWM.IO_X0	Ch0_In00	%IX16.0 BOOL
	Application.PWM.IO_X0	Ch0_In01	%IX16.1 BOOL
		Ch0_In02	%IX16.2 BOOL
		Ch0_In03	%IX16.3 BOOL
		Ch0_In04	%IX16.4 BOOL

- Click the "IO I/O Mapping" tab.

12.2 Setting up the GM1 units

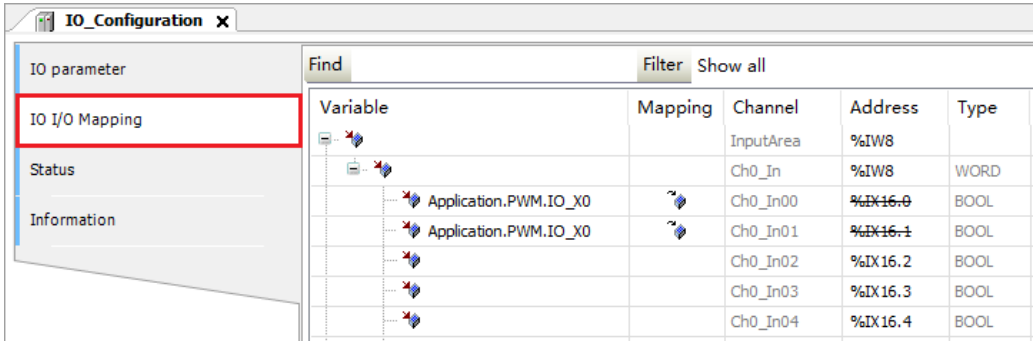

IO Configuration x

IO parameter

IO I/O Mapping

Status

Information

Find Filter Show all

Variable	Mapping	Channel	Address	Type
		InputArea	%IW8	
		Ch0_In	%IW8	WORD
Application.PWM.IO_X0		Ch0_In00	%IX16.0	BOOL
Application.PWM.IO_X0		Ch0_In01	%IX16.1	BOOL
		Ch0_In02	%IX16.2	BOOL
		Ch0_In03	%IX16.3	BOOL
		Ch0_In04	%IX16.4	BOOL

6. Variables will be mapped.

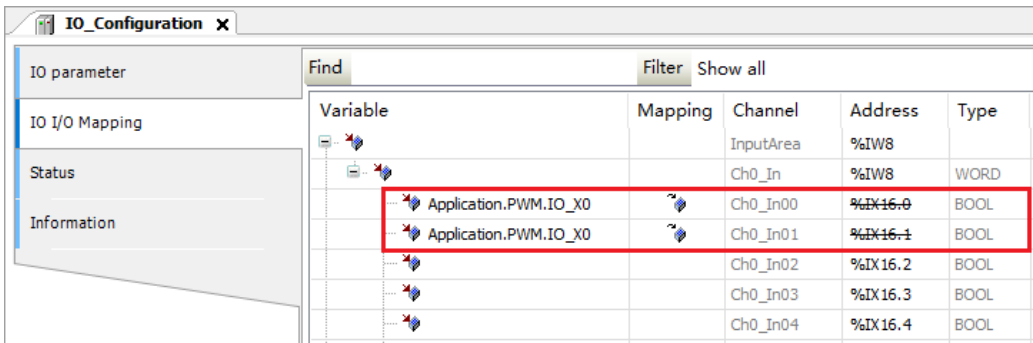

IO Configuration x

IO parameter

IO I/O Mapping

Status

Information

Find Filter Show all

Variable	Mapping	Channel	Address	Type
		InputArea	%IW8	
		Ch0_In	%IW8	WORD
Application.PWM.IO_X0		Ch0_In00	%IX16.0	BOOL
Application.PWM.IO_X0		Ch0_In01	%IX16.1	BOOL
		Ch0_In02	%IX16.2	BOOL
		Ch0_In03	%IX16.3	BOOL
		Ch0_In04	%IX16.4	BOOL

■ **Timing chart**

If the rising edge of the start request bit is detected when the enable request bit is ON, Y4 will start PWM output. When the enable request bit is set to OFF, PWM output stops.

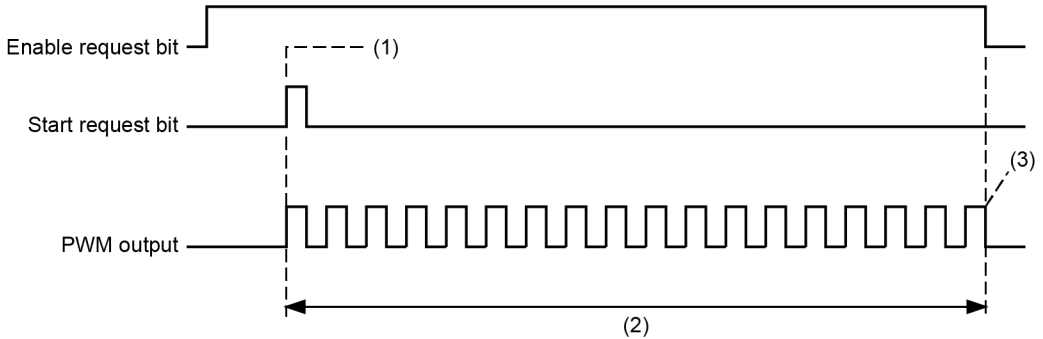

No.	Description
(1)	If the rising edge of the start request bit is detected when the enable request bit is ON, PWM output will be started.
(2)	PWM output is performed with a duty ratio of 50% and at a frequency of 100 Hz.
(3)	When the enable request bit turns OFF, PWM output stops.

■ **Sample program**

The following are LD program and ST program examples for sample POU (PWM).
 The state of X0 is output to the Ch0 Enable Request bit.
 Ch0 frequency and Ch0 duty ratio are set at the rising edge of X0.
 The state of X1 is output to the Ch0 Start Request bit.

LD program

```

1  PROGRAM PWM
2  VAR
3  // IO I/O Mapping variable
4  IO_X0          : BOOL;           // Enable Request
5  IO_X1          : BOOL;           // Start Request
6  // PWM I/O Mapping variable
7  Ch0_PwmStatus  : BOOL;           // Ch0 PWM Output Status
8  Ch0_FrequestValue : UDINT;       // Ch0 Frequency Setting Value
9  Ch0_DutyValue   : UINT;          // Ch0 Duty Ratio Ret Value
10 Ch0_PwmStartRequest : BOOL;      // Ch0 Start Request
11 Ch0_PwmEnableRequest : BOOL;     // Ch0 Enable Request
12
13 X0_TRIG        : R_TRIG;         // X0 Rise Detection
14 END_VAR
15

```

The ladder logic diagram consists of two rungs. Rung 1 starts with a normally open contact for IO_X0, which is connected to the Ch0_PwmEnableRequest output. In parallel with this contact is the Q output of an R_TRIG block. The R_TRIG block's CLK input is connected to X0_TRIG. The EN input of the R_TRIG block is connected to the Q output of a MOVE block. The MOVE block has two outputs: one set to 100 connected to Ch0_FrequestValue, and another set to 500 connected to Ch0_DutyValue. Rung 2 starts with a normally open contact for IO_X1, which is connected to the Ch0_PwmStartRequest output.

12.2 Setting up the GM1 units

ST program

```
1 PROGRAM PWM
2 VAR
3     // IO I/O Mapping variable
4     IO_X0           : BOOL;           // Enable Request
5     IO_X1           : BOOL;           // Start Request
6     // PWM I/O Mapping variable
7     Ch0_PwmStatus   : BOOL;           // Ch0 PWM Output Status
8     Ch0_FrequestValue : UDINT;        // Ch0 Frequency Setting Value
9     Ch0_DutyValue    : UINT;          // Ch0 Duty Ratio Ret Value
10    Ch0_PwmStartRequest : BOOL;        // Ch0 Start Request
11    Ch0_PwmEnableRequest : BOOL;       // Ch0 Enable Request
12
13    X0_TRIG          : R_TRIG;         // X0 Rise Detection
14 END_VAR
15
16 Ch0_PwmEnableRequest := IO_X0;        // Output X0 status to Ch0 enable request
17
18 X0_TRIG( CLK:=IO_X0 );
19 IF X0_TRIG.Q = TRUE THEN              // X0 rise detection
20     Ch0_FrequestValue := 100;         // Set frequency to 100HZ
21     Ch0_DutyValue := 500;            // Duty ratio set to 50%
22 END_IF
23
24 Ch0_PwmStartRequest := IO_X1;         // Output X1 status to Ch0 start request
```

12.2.5 High-speed Counter Function

Overview of High-speed Counter Function

- **Two 4-MHz, signed 32-bit high-speed counters are provided**
 - High-speed counting of input signals is available for up to the maximum frequency 4 MHz (or 16 MHz for 2-phase input 4 multiple). Two-phase input (phase differential input), individual input, or direction identification input can be selected according to the input device such as encoders or sensors.
- **24 VDC, 12 VDC, and 5 VDC inputs and line driver input are supported**
 - The count input circuit supports both open collector output and line driver output (differential output: equivalent to AM26LS31).
- **Ring counter or linear counter can be selected**
 - Both the ring counter and linear counter are supported. Both types can use the Z-phase of an encoder as count reset timing.
- **Internal clock counting is possible**
 - Internal clocks can be selected as count input signals. High-accuracy time measurements can be made with a maximum resolution of 0.25 μ s. Selectable internal clocks are 0.25 μ s (4 MHz), 1 μ s (1 MHz), 10 μ s (100 kHz), and 100 μ s (10 kHz).
- **Capture function and sampling capture function are provided**
 - It is possible to store the count value at the moment of the occurrence of a trigger assigned to a capture flag. Count values can be checked, independently of I/O refresh.
 - The capture function executes capturing at the rising and falling edges of a capture flag. The sampling capture function executes capturing at every sampling time according to the input of a capture flag.
- **Various counter operations can be selected**
 1. Enable count operation
 2. Reset count operation
 3. Preset count operation
 4. Enable reset count operation
 5. Enable preset count operation
- **Band comparison function and target value match comparison function are provided**
 - The band comparison function allows up to 16 pairs of upper and lower limits to be set for each counter. Up to 16 comparison match flags can be turned ON or OFF for each comparison condition.
 - The target value match comparison function allows up to 16 target values to be set for each counter. Target values can be set or reset individually according to the direction of counting (incrementation or decrementation) when the count value reaches the target value or when

12.2 Setting up the GM1 units

up to 16 comparison match flags for each comparison condition match their respective target values.

- For each counter, up to two comparison match flags and external output signals can be linked with each counter.

■ ON hold time setting (for band comparison function only)

- The ON state of external output signals is retained for the set time (1 to 1,000 ms).

■ Input time constant (noise filter)

- Input time constants can be set as input signals (A-phase, B-phase, and Z-phase) and control signals for each counter.

Setting Parameters with GM Programmer

You can set parameters for the high-speed counter via Counter_Configuration in GM Programmer.

1 2 Procedure

1. From "Device view" in the navigator pane, double-click "Counter_Configuration".

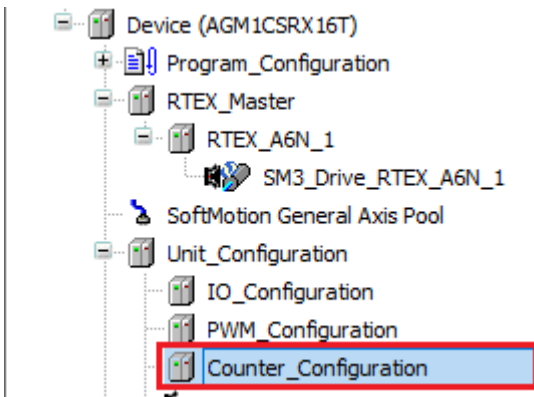

The "Counter_Configuration" setting window will be displayed.

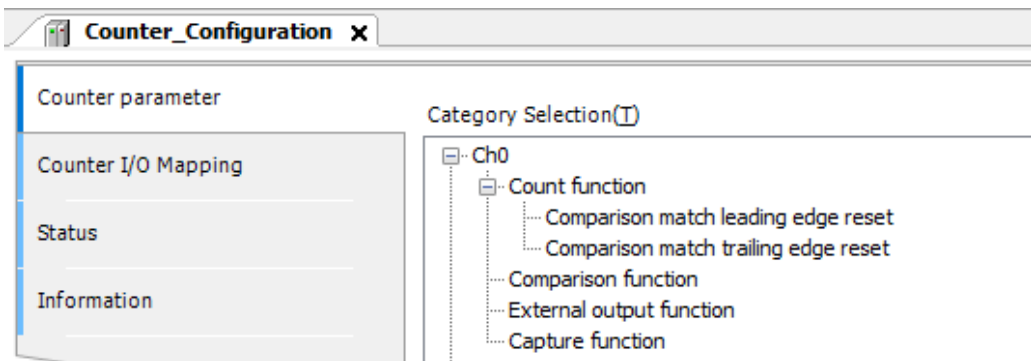

2. In the "Counter_Configuration" window, click the "Counter parameter" tab.

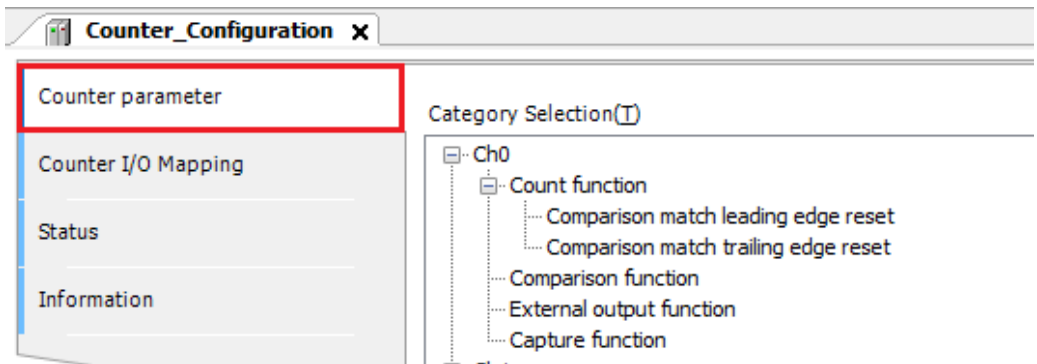

3. Set up parameters of each function for each counter.

Counter function

The screenshot shows the 'Parameter Setting (R)' window for the 'Counter function'. On the left, the 'Category Selection(T)' pane has 'Ch0' expanded to 'Count function', which is highlighted in red. The main area is a table with the following parameters and values:

Parameter	Value
Counter type	Linear counter
Enable/Disable overflow/underflow	Disable
Counter upper limit	2,147,483,647
Counter lower limit	-2,147,483,648
Specify count direction	Count in normal direction
Select count input	Count signal
Count method	2-phase input 1 multiple
Input Z signal function setting	Not used
Control 0 signal function setting	Not used
Control 1 signal function setting	Not used
Default value	0
Input A signal/Input B signal input time constant	2.0us(100kHz)
Input Z signal input time constant	2.0us(100kHz)
Control signal input time constant	2.0ms

Comparison match leading edge reset / Comparison match trailing edge reset

The screenshot shows the 'Parameter Setting (R)' window for the 'Comparison match leading edge reset' function. On the left, the 'Category Selection(T)' pane has 'Ch0' expanded to 'Count function', which is further expanded to 'Comparison match leading edge reset', highlighted in red. The main area is a table with the following parameters and values:

Parameter	Value
Comparison match 0 flag	Not reset
Comparison match 1 flag	Not reset
Comparison match 2 flag	Not reset
Comparison match 3 flag	Not reset
Comparison match 4 flag	Not reset
Comparison match 5 flag	Not reset
Comparison match 6 flag	Not reset
Comparison match 7 flag	Not reset
Comparison match 8 flag	Not reset
Comparison match 9 flag	Not reset
Comparison match 10 flag	Not reset
Comparison match 11 flag	Not reset
Comparison match 12 flag	Not reset
Comparison match 13 flag	Not reset
Comparison match 14 flag	Not reset
Comparison match 15 flag	Not reset

12.2 Setting up the GM1 units

Comparison function (band comparison)

Category Selection(T) + - Parameter Setting (R)

Parameter	Value
Select comparison function	Band comparison
Select comparison input	Count value
Set number of comparison data	16

Comparison function (band comparison) comparison data

Category Selection(T) + - Parameter Setting (R)

Parameter	Value
Lower limit	0
Upper limit	0

Set patterns for comparison function (band comparison) comparison data

Category Selection(T) + - Parameter Setting (R)

Parameter	Value
Comparison match 0 flag	OFF
Comparison match 1 flag	OFF
Comparison match 2 flag	OFF
Comparison match 3 flag	OFF
Comparison match 4 flag	OFF
Comparison match 5 flag	OFF
Comparison match 6 flag	OFF
Comparison match 7 flag	OFF
Comparison match 8 flag	OFF
Comparison match 9 flag	OFF
Comparison match 10 flag	OFF
Comparison match 11 flag	OFF
Comparison match 12 flag	OFF
Comparison match 13 flag	OFF
Comparison match 14 flag	OFF
Comparison match 15 flag	OFF

Comparison function (target value match comparison)

Category Selection(T) + - Parameter Setting (R)

Parameter	Value
Select comparison function	Target value match comparison
Select comparison input	Count value
Set number of comparison data	16

Comparison function (target value match comparison) comparison data

Category Selection(T) + - Parameter Setting (R)

Parameter	Value
Target Value	0

Set/reset patterns for comparison function (target value match comparison) comparison data

Category Selection (T)

- Ch0
 - Count function
 - Comparison match leading edge reset
 - Comparison match trailing edge reset
 - Comparison function
 - Comparison data 0
 - Addition set pattern**
 - Addition reset pattern
 - Subtraction set pattern
 - Subtraction reset pattern
 - Comparison data 1
 - Comparison data 2
 - Comparison data 3
 - Comparison data 4
 - Comparison data 5
 - Comparison data 6
 - Comparison data 7
 - Comparison data 8
 - Comparison data 9
 - Comparison data 10
 - Comparison data 11
 - Comparison data 12
 - Comparison data 13

Parameter Setting (R)

Parameter	Value
Comparison match 0 flag	No change
Comparison match 1 flag	No change
Comparison match 2 flag	No change
Comparison match 3 flag	No change
Comparison match 4 flag	No change
Comparison match 5 flag	No change
Comparison match 6 flag	No change
Comparison match 7 flag	No change
Comparison match 8 flag	No change
Comparison match 9 flag	No change
Comparison match 10 flag	No change
Comparison match 11 flag	No change
Comparison match 12 flag	No change
Comparison match 13 flag	No change
Comparison match 14 flag	No change
Comparison match 15 flag	No change

External output function

Category Selection (T)

- Ch0
 - Count function
 - Comparison match leading edge reset
 - Comparison match trailing edge reset
 - Comparison function
 - External output function**
 - Capture function

Parameter Setting (R)

Parameter	Value
External output 0 signal setting	Not output
External output 0 signal ON hold delay	0
External output 1 signal setting	Not output
External output 1 signal ON hold delay	0

Capture function

Category Selection (T)

- Ch0
 - Count function
 - Comparison match leading edge reset
 - Comparison match trailing edge reset
 - Comparison function
 - External output function
 - Capture function**

Parameter Setting (R)

Parameter	Value
Capture 0 setting	Not use capture 0 function
Capture 1 setting	Not use capture 1 function
Capture function operation setting	Continuous operation
Sampling time	1

i Info.

- You can copy the parameter set in a counter. To do so, select a channel (Ch0 or Ch1) in the "Category Selection" column and click the [Copy] button. Next, select another counter and click the [Paste] button.
- For details on each parameter, refer to "Counter Parameter Setting Items".

Counter Parameter Setting Items

■ Count function (Settable for each counter)

Setting item	Settings	Default value
Counter type	Linear counter / Ring counter	Linear counter
Enable/Disable overflow/underflow	Disable / Enable	Disable
Counter upper limit	-2,147,483,647 to 2,147,483,647	2,147,483,647

12.2 Setting up the GM1 units

Setting item	Settings	Default value
Counter lower limit	-2,147,483,648 to 2,147,483,646	-2,147,483,648
Specify count direction	Count in normal direction / Count in reverse direction	Count in normal direction
Select count input	Count signal Internal clock 0.25 μ s (4 MHz) Internal clock 1.00 μ s (1 MHz) Internal clock 10 μ s (100 kHz) Internal clock 100 μ s (10 kHz)	Count signal
Count method	2-phase input 1 multiple / 2-phase input 2 multiple / 2-phase input 4 multiple / Individual input 1 multiple / Individual input 2 multiple / Direction detection input 1 multiple / Direction detection input 2 multiple	2-phase input 1 multiple
Input Z signal function setting	Not used Reset operation at rising edge Reset operation at falling edge Positive logic reset operation Negative logic reset operation Preset operation at rising edge Preset operation at falling edge Positive logic preset operation Negative logic preset operation	Not used
Control 0 signal function setting	Not used Positive logic enable operation Negative logic enable operation Positive logic enable operation, reset operation at rising edge Negative logic enable operation and reset operation at falling edge Positive logic enable operation and preset operation at rising edge Negative logic enable operation and preset operation at falling edge	Not used
Control 1 signal function setting	Not used Positive logic enable operation Negative logic enable operation	Not used
Default value	Overwrites the count value with the default value when the power is turned ON	0
Input A signal/Input B signal input time constant	No input time constant / 0.1 μ s (2 MHz) / 0.2 μ s (1 MHz) / 0.5 μ s (500 kHz) / 1.0 μ s (250 kHz) / 2.0 μ s (100 kHz) / 10.0 μ s (10 kHz)	2.0 μ s (100 kHz)
Input Z signal input time constant	No input time constant / 0.1 μ s (2 MHz) / 0.2 μ s (1 MHz) / 0.5 μ s (500 kHz) / 1.0 μ s (250 kHz) / 2.0 μ s (100 kHz) / 10.0 μ s (10 kHz)	
Control signal input time constant	No input time constant / 2 μ s / 5 μ s / 10 μ s / 20 μ s / 50 μ s / 100 μ s / 500 μ s / 1.0 ms / 2.0 ms / 5.0 ms / 10.0 ms	2.0 ms

(Note 1) The control 0 signal and control 1 signal cannot be assigned to the capture function if they are assigned to the enable operation.

Setting item	Settings	Default value
Comparison match leading edge reset / Comparison match trailing edge reset	Selects a comparison match flag that resets the count value at the rising edge or falling edge. Not reset / Reset	Not reset

■ Comparison function (Settable for each counter)

Setting item	Settings	Default value
Select comparison function	Not use / Band comparison / Target value match comparison	Not use
Select comparison input	Count value	Count value
Set number of comparison data	Sets the number of data items to be compared Setting range: 1 to 16	16

If you select "Band comparison" or "Target value match comparison" for "Select comparison function", set parameters for each comparison data item.

Setting item	Settings	Default value
Comparison data 0 to Comparison data 15 (for band comparison)	Specifies the lower and upper limits for each comparison data (Note 1) Setting range: -2,147,483,648 to 2,147,483,647	0
	Specifies the state of the comparison match flag when the current value falls within the specified band ON / OFF	OFF
Comparison data 0 to Comparison data 15 (for target value match comparison)	Specifies target values for each comparison data Setting range: -2,147,483,648 to 2,147,483,647	0
	Comparison match flags to be set or reset can be selected for each status (incrementation or decrementation) of comparison data that has reached the target value. <ul style="list-style-type: none"> ● Addition set pattern: Set / No change ● Addition reset pattern: Reset / No change ● Subtraction set pattern: Set / No change ● Subtraction reset pattern: Reset / No change 	No change

(Note 1) Lower and upper limits can be set within the range between the lower and upper limits for the counter.
For linear counters, set each limit so that the lower limit is less than the upper limit. For ring counters, lower and upper limits can be set in any range.

■ External output function (Settable for each counter)

Setting item	Settings	Default value
External output 0 signal setting	Not output / Output	Not output
External output 0 signal ON hold time	Setting range: 0 to 1,000 (ms)	0 ms
External output 1 signal setting	Not output / Output	Not output
External output 1 signal ON hold delay	Setting range: 0 to 1,000 (ms)	0 ms

12.2 Setting up the GM1 units

(Note 1) "ON hold time" is enabled only when the band comparison function is used.

■ Capture function (Settable for each counter)

Setting item	Settings	Default value
Capture 0 setting	Not use capture 0 function Capture function at rising edge of control 0 signal Capture function at falling edge of control 0 signal Capture function at rising edge of control 1 signal Capture function at falling edge of control 1 signal Control 0 signal positive logic sampling capture function Control 0 signal negative logic sampling capture function Control 1 signal positive logic sampling capture function Control 1 signal negative logic sampling capture function Output relay (Y relay) sampling capture function	Not use capture 0 function
Capture 1 setting	Not use capture 1 function Capture function at rising edge of control 0 signal Capture function at falling edge of control 0 signal Capture function at rising edge of control 1 signal Capture function at falling edge of control 1 signal	Not use capture 1 function
Capture function operation setting	One operation / Continuous operation	Continuous operation
Sampling time (ms)	1 to 65,535	1

(Note 1) If any value related to the sampling capture function is selected for "Capture 0 setting", "Capture 1 setting" will be disabled.

I/O Mapping for High-speed Counter Output

The high-speed counter function is controlled by user programs.

■ InputArea (input area)

Channel	Type	Description	Remarks
Ch*_StatusRegister	WORD	Ch* status register	-
Ch*_ComparisonMatchRegister	WORD	Ch* comparison match flag	-
Ch*_CountValue	DINT	Ch* count value	-
Ch*_Capture0Value	DINT	Ch* capture 0 value	-
Ch*_Capture1Value	DINT	Ch* capture 1 value	-
Ch*_CaptureDifferenceValue	DINT	Ch* capture differential value	Stores the value (Capture 1 value - Capture 0 value)

■ Ch*_StatusRegister (Ch* status register)

Channel	Type	Description	Remarks
Ch*_OperationReadyStatus	BOOL	Ch* operation ready status	Indicates whether the count function is ready to run. 0: Getting ready, 1: Ready
CH*_CountEnableStatus	BOOL	Ch* count enable status	Indicates whether count operation is in progress. 0: Stopped, 1: Operation in progress
Ch*_CountDirectionStatus	BOOL	Ch* count direction status	Indicates the direction of counting. 0: Reverse rotation (decrementation direction), 1: Forward rotation (incrementation direction)
Ch*_Capture0Status	BOOL	Ch* capture 0 status	Indicates that the count value is stored as capture 0 value at the rising edge or falling edge of the control signal, whichever is enabled.
Ch*_Capture1Status	BOOL	Ch* capture 1 status	Indicates that the count value is stored as capture 1 value at the rising edge or falling edge of the control signal, whichever is enabled.
Ch*_ExternalOutput0Status	BOOL	Ch* external output 0 status	Indicates the output status of external output 0 signal. 0: Output OFF, 1: Output ON
Ch*_ExternalOutput1Status	BOOL	Ch* external output 1 status	Indicates the output status of external output 1 signal. 0: Output OFF, 1: Output ON
Ch*_InputAStatus	BOOL	Ch* input A status	Indicates the input status of input A signal. 0: Output OFF, 1: Output ON
Ch*_InputBStatus	BOOL	Ch* input B status	Indicates the input status of input B signal. 0: Output OFF, 1: Output ON
Ch*_InputZStatus	BOOL	Ch* input Z status	Indicates the input status of input Z signal. 0: Output OFF, 1: Output ON
Ch*_Control0Status	BOOL	Ch* control 0 status	Indicates the input status of control 0 signal. 0: Output OFF, 1: Output ON
Ch*_Control1Status	BOOL	Ch* control 1 status	Indicates the input status of control 1 signal. 0: Output OFF, 1: Output ON

■ Ch*_ComparisonMatchRegister (Ch* comparison match flag)

Channel	Type	Description	Remarks
Ch*_ComparisonMatch0Status to Ch*_ComparisonMatch15Status	BOOL	Ch* comparison match 0 flag to Ch* comparison match 15 flag	Outputs the result of the band comparison function or target value match function. 0: Unmatched, 1: Matched

12.2 Setting up the GM1 units

■ OutputArea (output area)

Channel	Type	Description	Remarks
Ch*_RequestRegister	WORD	Ch* request register	-
Ch*_TemporaryPresetValue	DINT	Ch* temporary preset value	Stores the value to replace the preset value. -2,147,483,648 to 2,147,483,647
Ch*_TemporaryCurrentValue	DINT	Ch* temporary current value	Stores the value to replace the count value. -2,147,483,648 to 2,147,483,647

■ Ch*_RequestRegister (Ch* request register)

Channel	Type	Description	Validity condition	Remarks
Ch*_OperationReadyRequest	BOOL	Ch* operation ready request	Level	Specifies whether to enable operation preparation for the count function. 0: Disable, 1: Enable
Ch*_CountEnableRequest	BOOL	Ch* count enable request	Level	Specifies whether to enable count operation. 0: Disable, 1: Enable
Ch*_ResetRequest	BOOL	Ch* reset request	ON edge	Specifies whether to reset the count value. 0: Do not reset 1: Reset
Ch*_PresetRequest	BOOL	Ch* preset request	ON edge	Specifies whether to change the count value to a preset value. 0: Do not change, 1: Change
Ch*_ResetEnableRequest	BOOL	Ch* reset enable request	Level	Capture function: Specifies whether to enable reset count operation for the input Z signal or comparison match flag. 0: Disable, 1: Enable Sampling capture function Specifies whether to enable reset count operation. 0: Disable, 1: Enable
Ch*_CurrentValueChangeRequest	BOOL	Ch* current value change request	ON edge	Specifies whether to change the count value to a temporarily current value. 0: Do not change, 1: Change
Ch*_PresetValueChangeRequest	BOOL	Ch* preset value change request	ON edge	Specifies whether to change the preset value to a temporarily preset value. 0: Do not change, 1: Change
Ch*_CaptureEnableRequest	BOOL	Ch* capture enable request (Note 1)	Level	Capture function: Specifies whether to enable the capture function. 0: Disable, 1: Enable

Channel	Type	Description	Validity condition	Remarks
				Sampling capture function Used as a capture flag.
Ch*_ExternalOutput0ForcedONRequest	BOOL	Ch* external output 0 forced ON request	Level	Relay to forcibly turn on the external output 0 signal
Ch*_ExternalOutput0ForcedOFFRequest	BOOL	Ch* external output 0 forced OFF request	Level	Relay to forcibly turn off the external output 0 signal
Ch*_ExternalOutput1ForcedONRequest	BOOL	Ch* external output 1 forced ON request	Level	Relay to forcibly turn on the external output 1 signal
Ch*_ExternalOutput1ForcedOFFRequest	BOOL	Ch* external output 1 forced OFF request	Level	Relay to forcibly turn off the external output 1 signal
Ch*_ErrorClearRequest	BOOL	Ch* error clearing request	ON edge	Specifies whether to clear the error. 0: Do not clear, 1: Clear

(Note 1) The behavior of the "Ch* capture enable request" bit differs according to the function to be used.

12.2 Setting up the GM1 units

Operation Ready Request

■ Operation ready request program

To enable the settings of the high-speed counter function, you must configure parameter settings with GM Programmer and issue an operation ready request.

Ensure that the following operation ready request is issued before the high-speed counter is used.

Example: A program to request preparation for CH0 operation of the high-speed counter function

First, perform I/O mapping for variables created in POU.

From "Device view" in the navigator pane, double-click "Counter_Configuration" and select the "Counter I/O Mapping" tab.

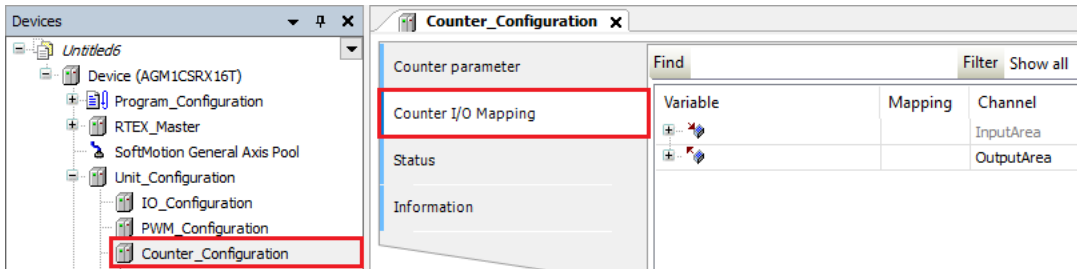

In this example, variables are mapped to the channel used for high-speed counter Ch0 (the name of sample POU is created as "Counter").

Variable	Mapping	Channel	Address	Type	Unit	Description
		InputArea	%ID8			Input area
		Ch0_StatusRegister	%IW16	WORD		Ch0 Status register
Application.Counter.bCh0_OperationReadyStatus		Ch0_OperationReadyStatus	%IX32.0	BOOL		Ch0 Operation ready status
		Ch0_CountEnableStatus	%IX32.1	BOOL		Ch0 Count enable status

Variable	Mapping	Channel	Address	Type	Unit	Description
		InputArea	%ID8			Input area
		OutputArea	%QD11			Output area
		Ch0_RequestRegister	%QW22	WORD		Ch0 Request register
Application.Counter.bCh0_OperationReadyRequest		Ch0_OperationReadyRequest	%QX44.0	BOOL		Ch0 Operation ready request
		Ch0_CountEnableRequest	%QX44.1	BOOL		Ch0 Count enable request

The following are LD program and ST program examples for sample POU (Counter).

When the "OperationReadyRequest" flag is set to TRUE, operation preparation is started.

LD program

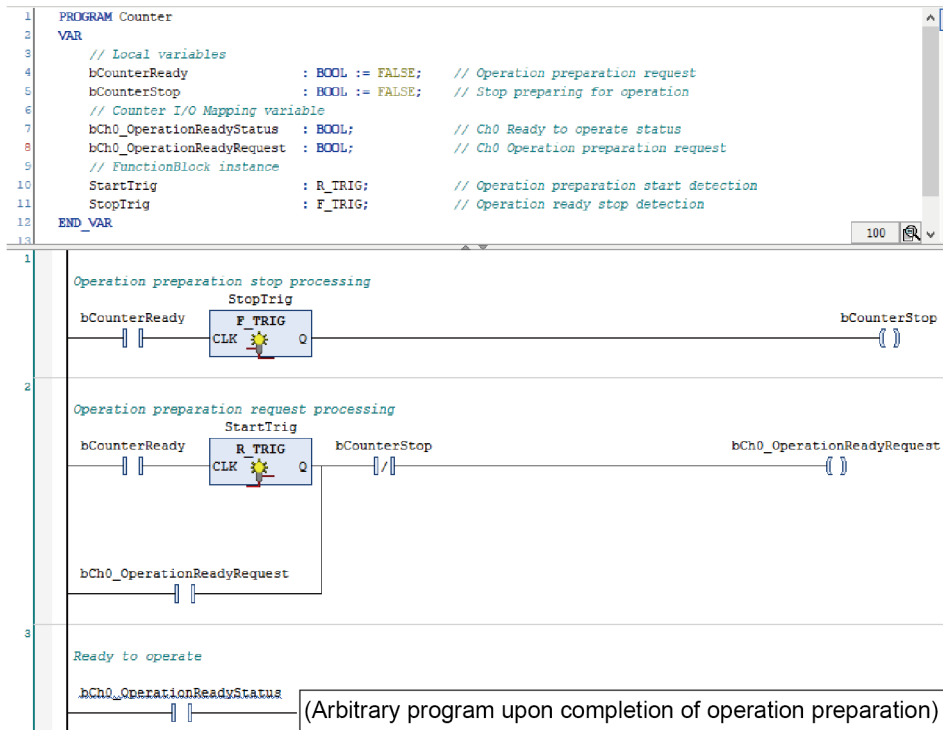

ST program

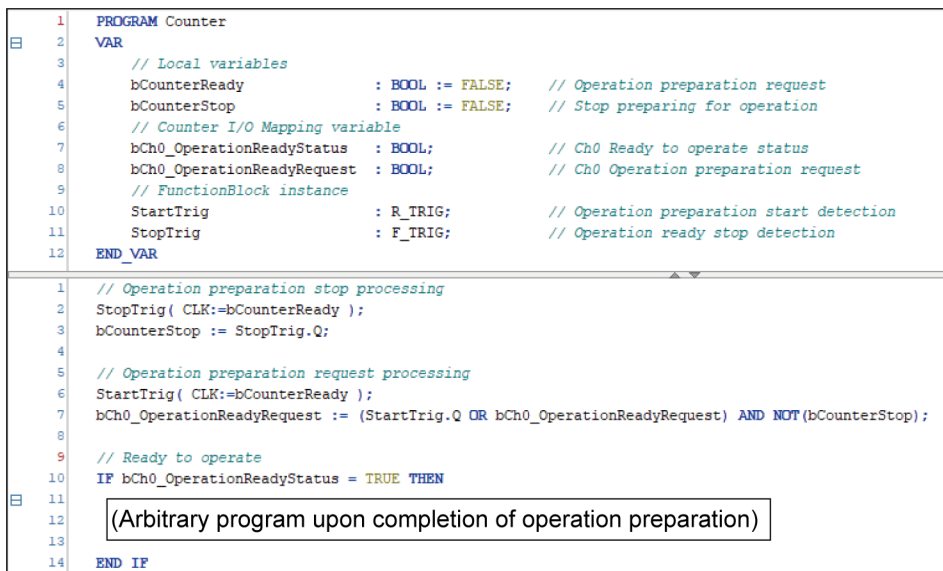

- Downloading IO parameters

The IO parameters of the high-speed counter function are downloaded to the GM1 controller together with user programs.

12.2 Setting up the GM1 units

When an operation ready request is issued in RUN mode and the operation ready status bit turns ON, each function of the high-speed counter function is enabled.

■ Behaviors when operation ready request program is executed

When the operation ready request program is executed and each behavior set in the GM1 controller becomes executable, the operation ready status bit turns ON.

Behaviors of operation ready request bit

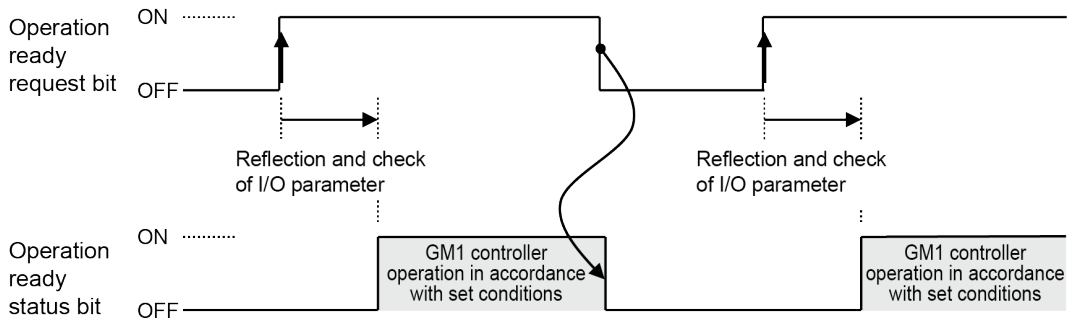

(Note 1) Ensure that the operation ready request bit remains ON when the high-speed counter is used.

i Info.

- If the default value or preset value is out of range, the operation ready status bit will not turn ON.

Count Function

■ Setup procedure

1. From "Device view" in the navigator pane, double-click "Couter_Configuration".
2. Click the "Counter parameter" tab.
3. For each channel, select the count function and set up each parameter.

i Info.

- For details on how to set up parameters, refer to "[Setting Parameters with GM Programmer](#)".

■ Counter upper limit and Counter lower limit

Set the upper limit and lower limit values for each counter.

Counter upper limit: Any value between -2,147,483,647 and 2,147,483,647 can be set (Default value: 2,147,483,647)

Counter lower limit: Any value between -2,147,483,648 and 2,147,483,646 can be set (Default value: -2,147,483,648)

■ Specify count direction

Set the rotational direction of count input.

Count in normal direction: Counts in the direction stated in the manual

Count in reverse direction: Counts in the direction reverse to the one stated in the manual

■ Counter type

The counter behavior differs according to the type of the counter as below.

Difference in behavior between counter types

Item	Linear counter	Ring counter
Behavior image		

12.2 Setting up the GM1 units

Behavior example of linear counter

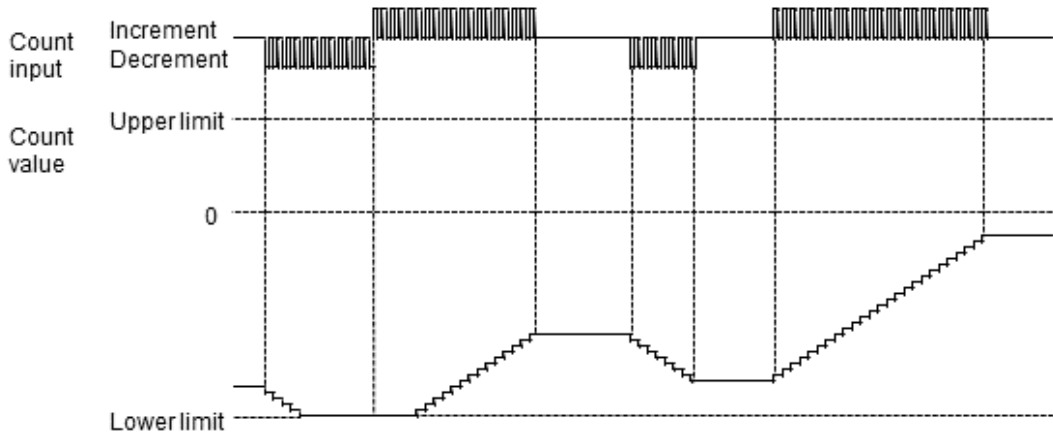

Behavior example of ring counter

- If the count is decremented from the lower limit, the counter will roll over the count and continue a decremental count from the upper limit.
- If the count is incremented from the upper limit, the counter will roll over the count and continue an incremental count from the lower limit.

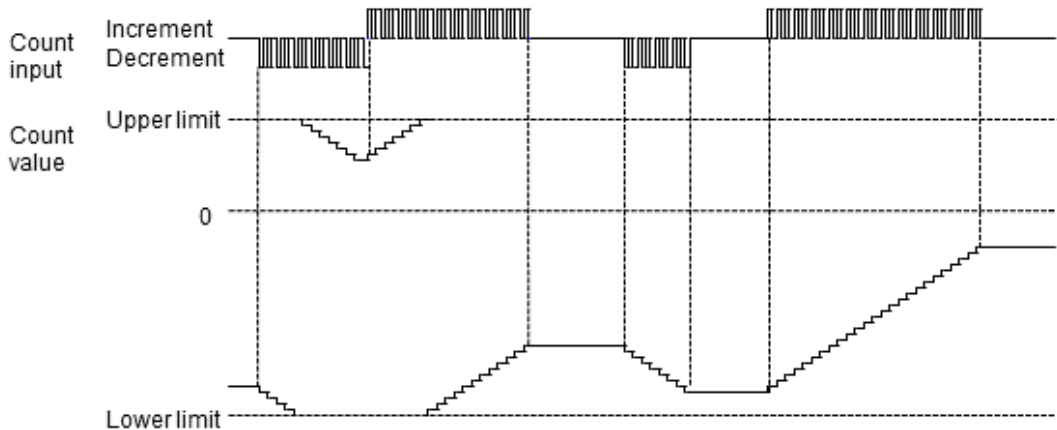

■ Enable / Displable overflow/underflow (for linear counters only)

Set the counter behavior to be performed when the count value reaches the specified upper limit or lower limit.

Disable: Continues counting within the countable range for the system (-2,147,483,648 to 2,147,483,647) even if the specified upper limit or lower limit is reached.

■ Select count input

- To import input signals from external devices, select "Count input".
- To measure the frequencies of external input signals or time based on the internal clock, select "Internal clock".
- For internal clocks, you can select from 0.25 μ s (4 MHz), 1.00 μ s (1 MHz), 10 μ s (100 kHz), and 100 μ s (10 kHz).

■ **Count method**

- You can select from the three types shown in the table below according to the input device to be connected.
- The count behavior changes according to the settings of a multiplication factor, as described on the following pages.

Count method

Method	Connection	Count
2-phase (Phase difference)		<p>For 2-phase input, the input A signal and input B signal of each counter are connected to phase A and phase B, respectively, in the encoder.</p> <p>The count direction depends on the phase difference between phases A and B. When phase A is ahead of phase B by 90 degrees in terms of the electrical angle, the count value is incremented. When phase A is behind phase B by 90 degrees in terms of the electrical angle, the count value is decremented.</p>
Individual		<p>For individual input, the counter is incremented when the level of the input A signal rises or falls, and decremented when the level of the input B signal rises or falls.</p>
Direction detection		<p>For direction detection input, the count signal is connected to the input A signal. The count direction is controlled by the direction signal level of the input B signal.</p> <p>When the input B signal is OFF, the counter is incremented when the level of the input A signal rises or falls. When the input B signal is ON, the counter is decremented.</p>

Count operation of 2-phase input (Phase difference input)

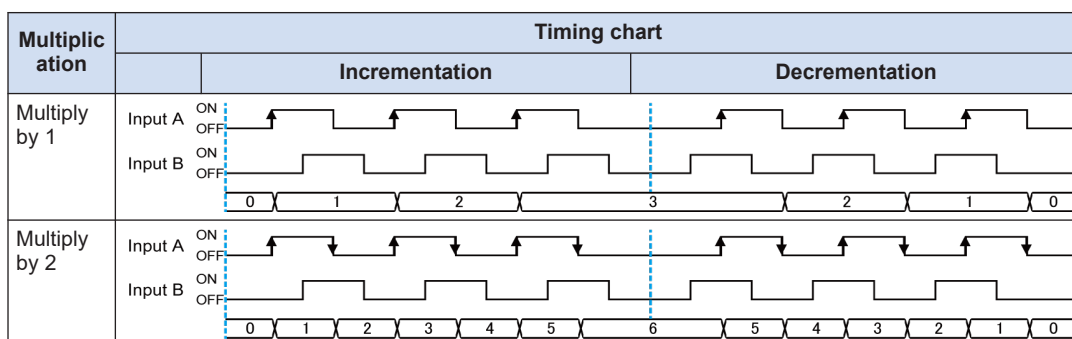

12.2 Setting up the GM1 units

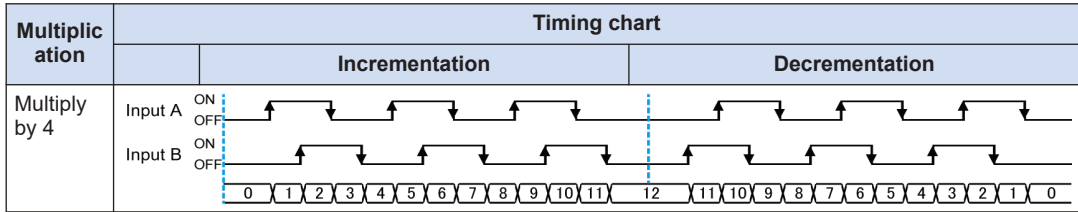

Count operation of individual input

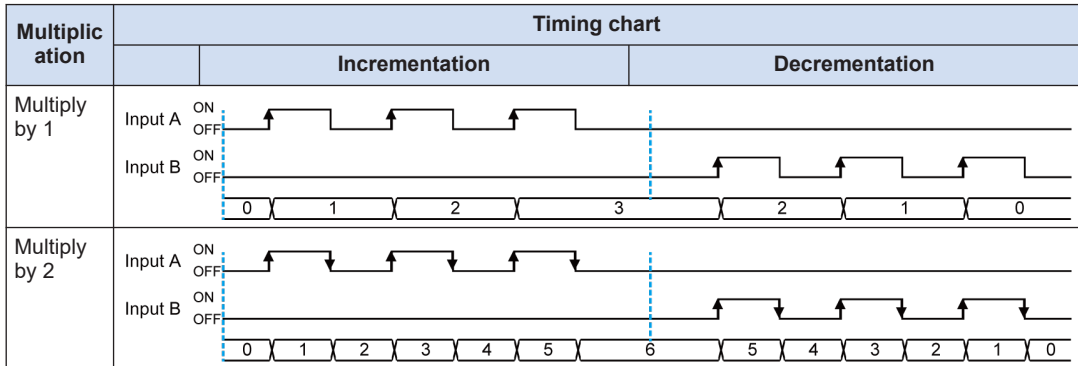

Count operation of direction detection input

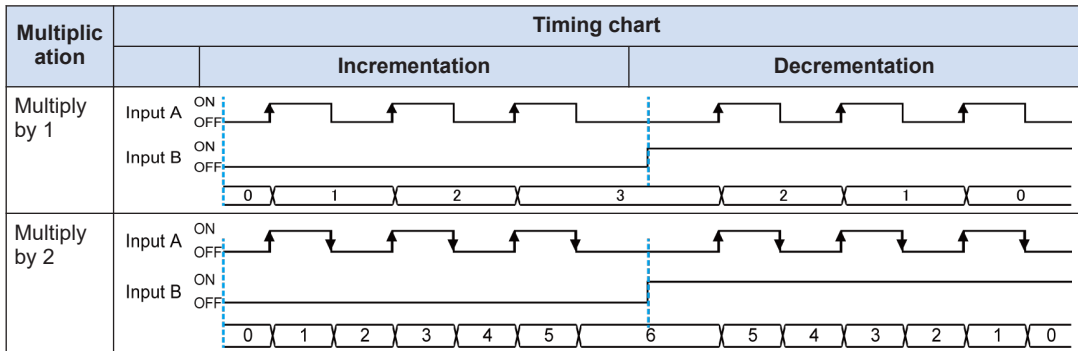

■ Input time constant

Input time constants can be set for input signals (phases A, B, and Z) and control signals.



Input signal name	Settings
Input A signal, input B signal (The same time constant for both signals)	No input time constant / 0.1 μ s (2 MHz) / 0.2 μ s (1 MHz) / 0.5 μ s (500 kHz) / 1.0 μ s (250 kHz) / 2.0 μ s (100 kHz) / 10.0 μ s (10 kHz)
Input Z signal	No input time constant / 0.1 μ s (2 MHz) / 0.2 μ s (1 MHz) / 0.5 μ s (500 kHz) / 1.0 μ s (250 kHz) / 2.0 μ s (100 kHz) / 10.0 μ s (10 kHz)
Control signal	No input time constant / 2 μ s / 5 μ s / 10 μ s / 20 μ s / 50 μ s / 100 μ s / 500 μ s / 1.0 ms / 2.0 ms / 5.0 ms / 10.0 ms

■ Types of count operation

Enable count operation

- Enable count operation is used by allocating the enable function to the control flag. Count operation is performed while the control flag is enabled.
- Enable count operation can be set using the methods shown in the following table.

Types of control flag (enable processing)

Signal	Setting method using the Counter_Configuration parameters	Enable condition	
		ON - OFF 	ON - OFF 
Count enable request bit	- (No need to set)	•	
Control 0 signal	Setting the enable operation conditions by setting up the control 0 signal function	•	•
Control 1 signal	Setting the enable operation conditions by setting up the control 1 signal function	•	•

(Note 1) If you set the control 0 signal or control 1 signal as the enable operation condition, do not use the count enable request bit.

Count enable operation example

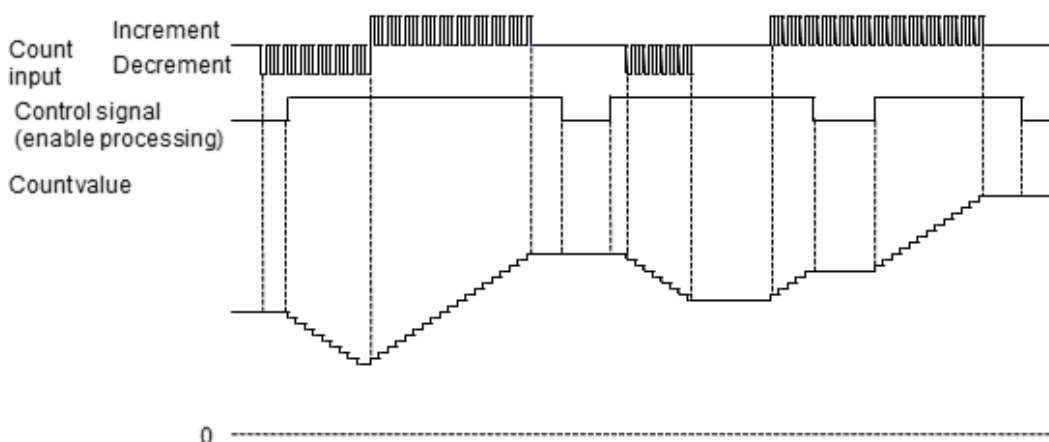





12.2 Setting up the GM1 units

■ Reset count operation

- Reset count operation is used by allocating the reset function to the control flag.
- The count value is reset to 0 according to the change (rising, falling, positive logic, or negative logic) of the control flag.
- Reset count operation can be set using the methods shown in the following table.

Types of control flag (reset processing)

Signal	Setting method using the Counter_Configuration parameters	Reset condition			
		ON - OFF 	ON - OFF 	ON - OFF 	ON - OFF 
Reset request bit	- (No need to set)	•			
Input Z signal	Setting the reset operation conditions by setting up the input Z signal function	•	•	•	•
Comparison match status bit	Setting the "Comparison match rising edge reset" or "Comparison match falling edge reset" function to "Reset"	•	•		

(Note 1) If you set the control 0 signal or control 1 signal as the enable operation condition, the count enable request bit will be disabled.

i Info.

- To use the input Z signal and comparison match flag as reset signals, turn ON the reset enable request bit through user programs.

■ **Preset count operation**

- Preset count operation is used by allocating the preset function to the control flag.
- Preset count operation rewrites the count value as the preset value according to the change (rising, falling, positive logic, or negative logic) of the control flag.
- Preset count operation can also be used to start counter operation from the preset value.
- Preset count operation can be set using the methods shown in the following table.

Types of control flag (preset processing)

Signal	Setting method using the Counter_Configuration parameters	Preset condition			
		ON - OFF ↑	ON - OFF ↓	ON - OFF	ON - OFF
Preset request bit	- (No need to set)	•			
Input Z signal	Setting the preset operation conditions by setting up the input Z signal function	•	•	•	•

i Info.

- To set a preset value, you must use a user program to set a temporary preset value and turn ON the preset value change request bit.

Reset (preset) count operation example

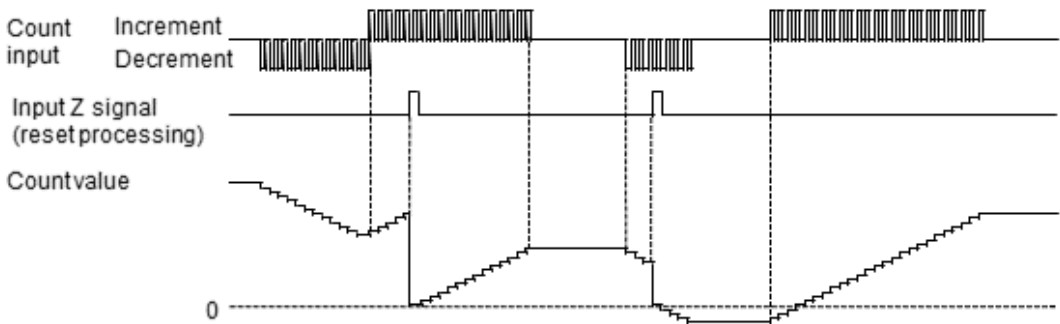





12.2 Setting up the GM1 units

■ Enable reset count operation

- Enable reset count operation is used by allocating the enable function and reset function to the control flag.
- The count value is reset to zero when the counter becomes enabled due to the change of the control flag (enable reset processing).





Types of control flag (enable reset processing)

Signal	Setting method using the Counter_Configuration parameters	Reset condition		Enable condition	
					
Control 0 signal	Setting the following conditions by setting up the control 0 signal function Positive logic enable operation and reset operation at rising edge Negative logic enable operation and reset operation at falling edge	•	•	•	•

■ Enable preset count operation

- Enable preset count operation is used by allocating the enable function and preset function to the control flag.
- The count value is set as a preset value when the counter becomes enabled due to the change of the control flag (enable preset processing).

Types of control flag (enable preset processing)

Signal	Setting method using the Counter_Configuration parameters	Preset condition		Enable condition	
					
Control 0 signal	Setting the following conditions by setting up the control 0 signal function Positive logic enable operation and preset operation at rising edge Negative logic enable operation and preset operation at falling edge	•	•	•	•

Positive logic enable operation and reset (preset) operation at rising edge

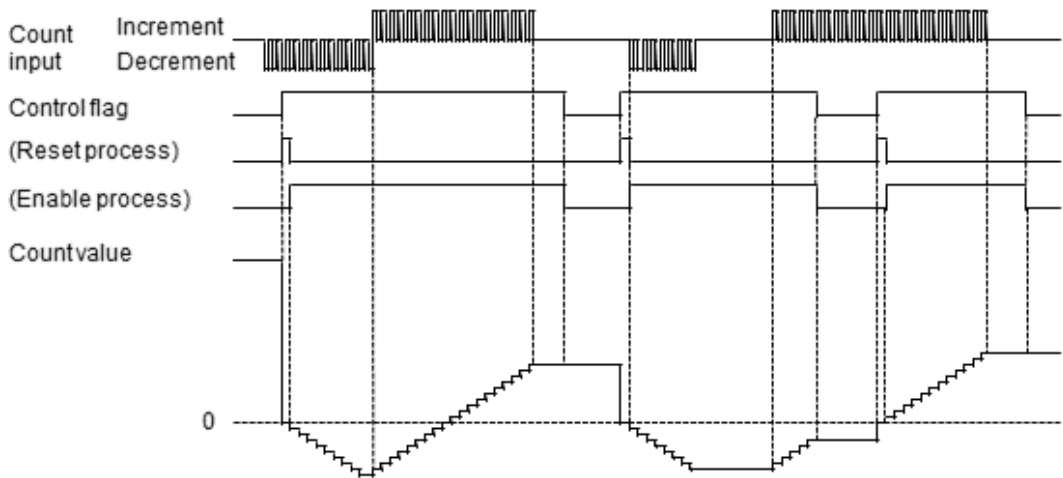

Negative logic enable operation and reset (preset) operation at falling edge

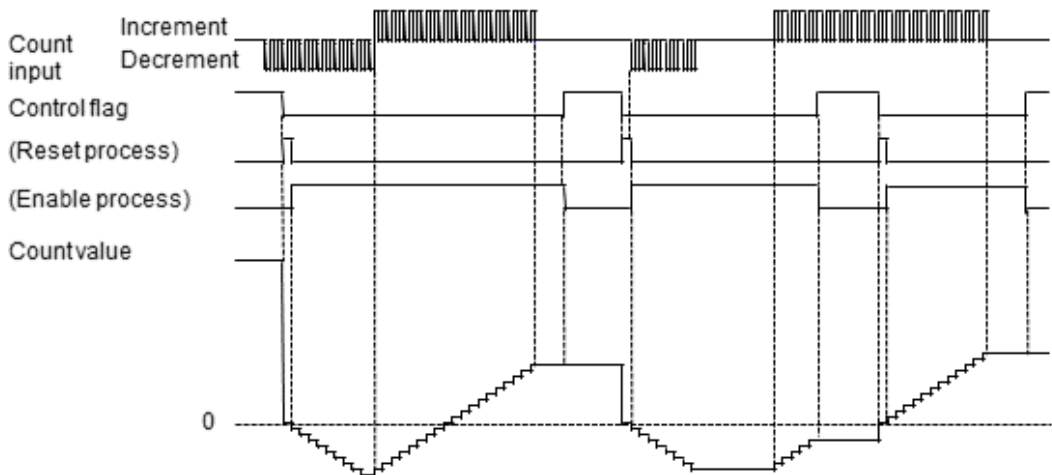

■ **Reading the count value or changing the current count value or preset value**

- To read and write channel data, variables are mapped to channels in the same way as in "Operation Ready Request". In this example, variables are mapped to channels used for reading the count value of Counter Ch0 and changing the current count value and preset value.

Variable	Mapping	Channel	Address	Type	Unit	Description
		InputArea	%ID8			Input area
		Ch0_StatusRegister	%IW16	WORD		Ch0 Status register
		Ch0_ComparisonMatchRegister	%IW17	WORD		Ch0 Comparison match register
Application.Counter2.dCh0_CountValue		Ch0_CountValue	%ID10	DINT		Ch0 Count value
Application.Counter3.dCh0_Capture0Value		Ch0_Capture0Value	%ID11	DINT		Ch0 Capture 0 value

12.2 Setting up the GM1 units

Variable	Mapping	Channel	Address	Type	Unit	Description
		InputArea	%I08			Input area
		OutputArea	%Q011			Output area
		Ch0_RequestRegister	%Q022	WORD		Ch0 Request register
Application.Counter.bCh0_OperationReadyRequest		Ch0_OperationReadyRequest	%Q044.0	BOOL		Ch0 Operation ready request
		Ch0_CountEnableRequest	%Q044.1	BOOL		Ch0 Count enable request
		Ch0_ResetRequest	%Q044.2	BOOL		Ch0 Reset request
		Ch0_PresetRequest	%Q044.3	BOOL		Ch0 Preset request
		Ch0_ResetEnableRequest	%Q044.4	BOOL		Ch0 Reset enable request
Application.Counter2.bCh0_CurrentValueChangeRequest		Ch0_CurrentValueChangeRequest	%Q044.5	BOOL		Ch0 Current value change request
Application.Counter2.bCh0_PresetValueChangeRequest		Ch0_PresetValueChangeRequest	%Q044.6	BOOL		Ch0 Preset value change request
		Ch0_CaptureEnableRequest	%Q044.7	BOOL		Ch0 Capture enable request
		Ch0_ExternalOutput0ForcedONRequest	%Q045.1	BOOL		Ch0 External output 0 forced ON request
		Ch0_ExternalOutput0ForcedOFFRequest	%Q045.2	BOOL		Ch0 External output 0 forced OFF request
		Ch0_ExternalOutput1ForcedONRequest	%Q045.3	BOOL		Ch0 External output 1 forced ON request
		Ch0_ExternalOutput1ForcedOFFRequest	%Q045.4	BOOL		Ch0 External output 1 forced OFF request
		Ch0_ErrorClearRequest	%Q045.7	BOOL		Ch0 Error clear request
Application.Counter2.dCh0_TemporaryPresetValue		Ch0_TemporaryPresetValue	%Q046	DINT		Ch0 Temporary preset value
Application.Counter2.dCh0_TemporaryCurrentValue		Ch0_TemporaryCurrentValue	%Q047	DINT		Ch0 Temporary current value

- The following are LD program and ST program examples for sample POU (Counter2).
 - In this example, count values are read for each scan.
 - When the current value change start bit is set to TRUE, the current value of Ch0 is set to 1000000.
 - When the start preset bit is set to TRUE, the preset value of Ch0 is set to 500000.

LD program

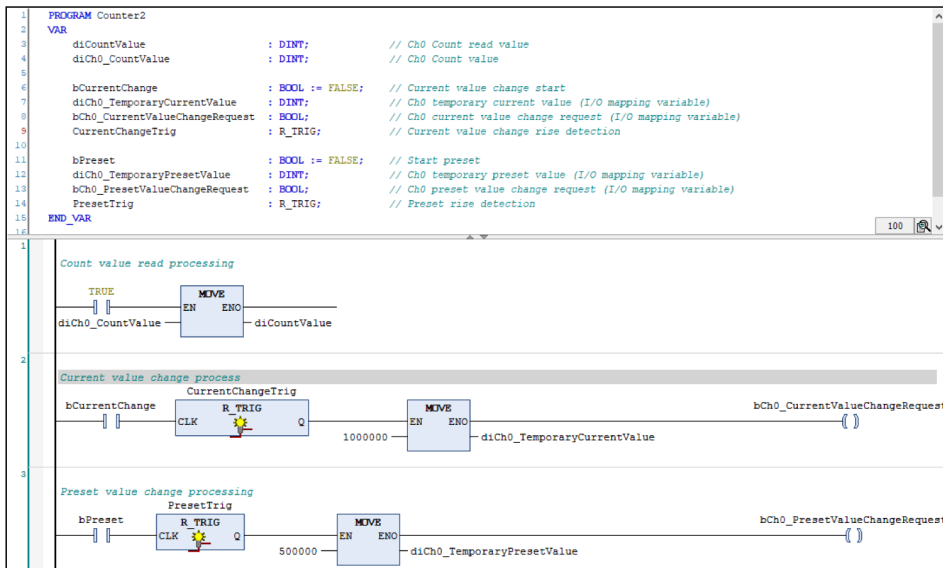

ST program

```

1  PROGRAM Counter2
2  VAR
3      diCountValue           : DINT;           // Ch0 Count read value
4      diCh0_CountValue      : DINT;           // Ch0 Count value
5
6      bCurrentChange        : BOOL := FALSE;  // Current value change start
7      diCh0_TemporaryCurrentValue : DINT;     // Ch0 temporary current value (I/O mapping variable)
8      bCh0_CurrentValueChangeRequest : BOOL;  // Ch0 current value change request (I/O mapping variable)
9      CurrentChangeTrig     : R_TRIG;        // Current value change rise detection
10
11     bPreset                : BOOL := FALSE;  // Start preset
12     diCh0_TemporaryPresetValue : DINT;     // Ch0 temporary preset value (I/O mapping variable)
13     bCh0_PresetValueChangeRequest : BOOL;  // Ch0 preset value change request (I/O mapping variable)
14     PresetTrig            : R_TRIG;        // Preset rise detection
15 END_VAR
16
17 // Count value read processing
18 diCountValue := diCh0_CountValue;
19
20 // Current value change process
21 CurrentChangeTrig( CLK:=bCurrentChange );
22 IF CurrentChangeTrig.Q = TRUE THEN
23     diCh0_TemporaryCurrentValue := 1000000;
24 END_IF
25 bCh0_CurrentValueChangeRequest := CurrentChangeTrig.Q;
26
27 // Preset value change processing
28 PresetTrig( CLK:=bPreset );
29 IF PresetTrig.Q = TRUE THEN
30     diCh0_TemporaryPresetValue := 500000;
31 END_IF
32 bCh0_PresetValueChangeRequest := PresetTrig.Q;

```

■ Count value when the power is turned on

- When the power is turned on, the count value is "0".

■ Changing the current count value

- The current count value can be changed to any value as necessary.
- Set a value in the temporary current value channel and turn ON the current value change request bit.

Info.

- Count values cannot be written directly to the count value channel (Ch*_CountValue).

12.2 Setting up the GM1 units

■ Changing the preset value

- The preset value can be changed to any value as necessary.
- Set a value in the temporary preset value channel and turn ON the preset value change request bit.

Info.

- Preset values that are set cannot be read by programs.

Comparison Function

■ Setup procedure

1. From "Device view" in the navigator pane, double-click "Counter_Configuration".
2. Click the "Counter parameter" tab.
3. For each counter, select the comparison function and set up each parameter.

Info.

- For details on how to set up parameters, refer to "[Setting Parameters with GM Programmer](#)".

■ Types of comparison function

This function compares the current value of the high-speed counter with a preset target value and, when these values match, it reflects the value in the comparison match flag.

- There are target value match comparison and band comparison.
- A total of 16 comparison data items can be set.
- Comparison results can be output externally.
- Comparison methods can be selected for each counter.

Comparison match function specifications

Item	Specifications
Set number of comparison data	Up to 16 data items for each counter (Comparison data 0 to comparison data 15)
Comparison match flag	Up to 16 flags for each counter (Comparison match 0 flag to comparison match 15 flag) Behaviors of 16 comparison match flags can be set for a single comparison data item.
Select comparison function	Target value match comparison Sets or resets the comparison match flag when the elapsed value matches the target value.
	Band comparison Turns ON or OFF the comparison match flag when the elapsed value falls within the range between the lower and upper limits that are set.
External output function	Up to two flags for each counter Comparison match 0 flag or comparison match 1 flag can be allocated to external output.
	ON hold time can be set only when the band comparison function is used. ON hold time: 0 to 1,000 ms

Info.

- Only the comparison match 0 flag or comparison match 1 flag can be set as the external output function.
- By default, the external output 0 and external output 1 signals are set to "Not output". When necessary, change the setting in the Counter_Configuration parameter window.
- There is no need to arrange comparison data items in ascending or descending order.

12.2 Setting up the GM1 units

■ Target value match comparison and band comparison

The main differences are as below.

Main differences in characteristics

Item	Target value match comparison	Band comparison
Setting of comparison value data	Comparison value data is specified as a target value.	Comparison value data is specified as a band (lower and upper limits).
Setting for comparison value data match	<p>One of the following four options is specified as the comparison match flag behavior to be performed when the target value is reached.</p> <p>"Addition set pattern": Sets the flag when the current value and comparison value match at the time of incrementation</p> <p>"Addition reset pattern": Resets the flag when the current value and comparison value match at the time of incrementation</p> <p>"Subtraction set pattern": Sets the flag when the current value and comparison value match at the time of decrementation</p> <p>"Subtraction reset pattern": Resets the flag when the current value and comparison value match at the time of decrementation</p>	ON or OFF is specified as the behavior of the comparison match flag when the current value falls within the specified band.
Behavior when comparison value data matches	The behavior that is performed when the current value matches the same comparison value data may differ between incremental count and decremental count, depending on the settings.	The behavior that is performed when the current value matches the same comparison value data is the same for incremental count and decremental count.
External output signal ON hold time	Cannot be set	ON hold time: 0 to 1,000 ms

■ Parameter settings for target value match comparison

Parameter setting procedure

1. Click **Counter parameter>Counter (Ch0 or Ch1)>Comparison function**, change the "Select comparison function" parameter to "Target value match comparison", and execute "Set number of comparison data".
2. Click **Counter parameter>Counter (Ch0 or Ch1)>Comparison function>Comparison data** and specify target values for each comparison data item.
3. Select "Addition set pattern", "Addition reset pattern", "Subtraction set pattern", and "Subtraction reset pattern" separately and set ""No change", "Set output", or "Reset output"" for each comparison match flag.
4. Configure these settings for each comparison data item.

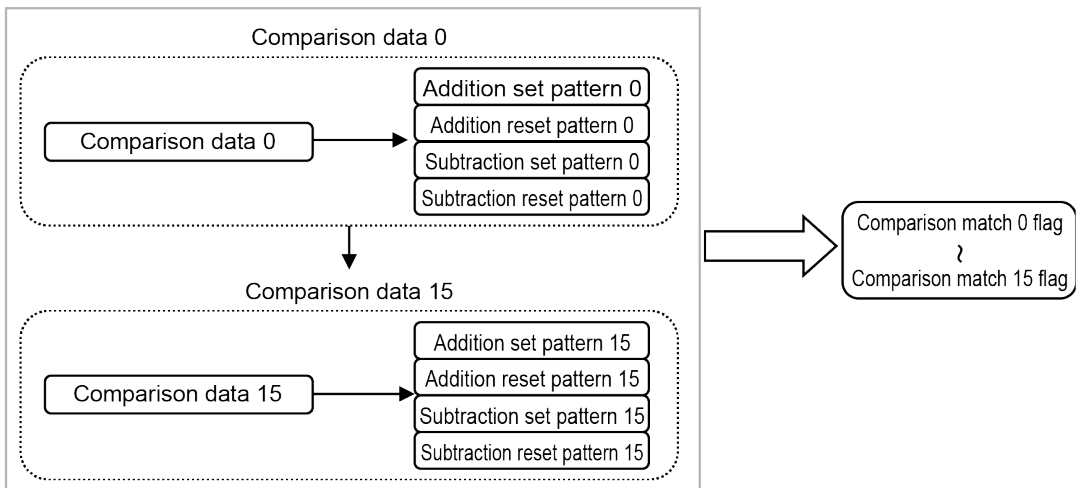

i Info.

- Settings can be configured individually according to the count direction (incremental or decremental direction) at the time of comparison data match.
- A total of 16 comparison match flags can be set separately for "Addition set pattern", "Addition reset pattern", "Subtraction set pattern", and "Subtraction reset pattern".
- For details on how to set up parameters, refer to ["Setting Parameters with GM Programmer"](#).

12.2 Setting up the GM1 units

■ Setting example for target value match function

Output setting example

Comparison data	Target value	Output setting	Comparison match 0 flag	Comparison match 1 flag	Comparison match 2 flag	Comparison match 3 flag
0	+500	Addition set pattern		○		
		Addition reset pattern	○			
		Subtraction set pattern				
		Subtraction reset pattern		○	○	○
1	+1,250	Addition set pattern			○	
		Addition reset pattern		○		○
		Subtraction set pattern				
		Subtraction reset pattern				
2	+2,500	Addition set pattern				○
		Addition reset pattern				
		Subtraction set pattern		○		○
		Subtraction reset pattern				
3	+3,750	Addition set pattern		○		
		Addition reset pattern			○	
		Subtraction set pattern				
		Subtraction reset pattern				○
4	+5,000	Addition set pattern				
		Addition reset pattern				○
		Subtraction set pattern			○	○
		Subtraction reset pattern	○	○		
5	+6,250	Addition set pattern			○	
		Addition reset pattern				
		Subtraction set pattern				
		Subtraction reset pattern				○
6	+7,500	Addition set pattern	○			○
		Addition reset pattern		○		
		Subtraction set pattern	○	○		
		Subtraction reset pattern				
7	+8,750	Addition set pattern				
		Addition reset pattern			○	
		Subtraction set pattern				○
		Subtraction reset pattern				

i Info.

- The behavior of the comparison match flag that is performed when the count value reaches the target value can be changed separately for incrementation and decrementation.
- If the contents of comparison data 0 to 15 are duplicated and reset conditions are different, comparison data is prioritized in the following order.
(High) 0 > 1 > 2 > 3 > 4 > 5 > 6 > 7 > 8 > 9 > 10 > 11 > 12 > 13 > 14 > 15 (Low)

Behavior of comparison match flag during incremental count

When the current value matches the comparison data, the comparison match flag behaves according to the setting of "Addition set pattern" or "Addition reset pattern".

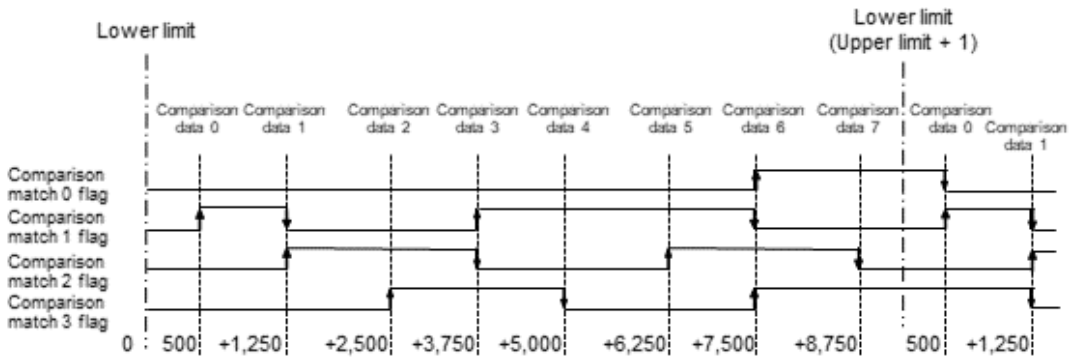

Behavior of comparison match flag during decrementation count

When the current value matches the comparison data, the comparison match flag behaves according to the setting of "Subtraction set pattern" or "Subtraction reset pattern".

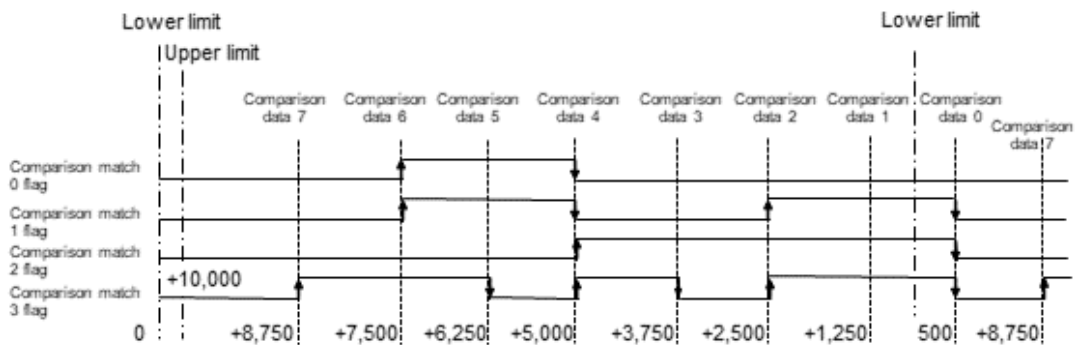

i Info.

- For ring counters, comparison data can be set in an area including the lower and upper limits where count values are rolled over.

12.2 Setting up the GM1 units

■ Parameter settings for band comparison

Parameter setting procedure

1. Click **Counter parameter>Counter (Ch0 or Ch1)>Comparison function**, change the "Select comparison function" parameter to "Band comparison", and execute "Set number of comparison data".
2. Click **Counter parameters>Counter (Ch0 or Ch1)>Comparison function>Comparison data** and specify upper and lower limits for each comparison data item.
3. Set whether to turn ON or OFF the comparison match flag when the count value exists in the zone (between the upper and lower limits).
4. Configure these settings for each comparison data item.

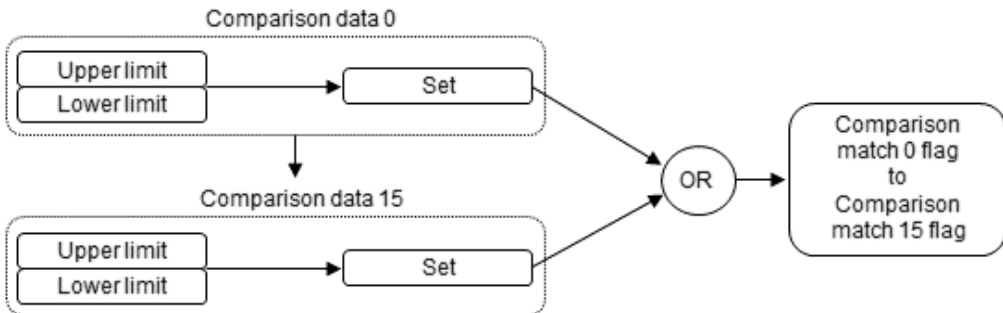

i Info.

- A total of 16 comparison match flags can be set separately for each comparison data item.
- Multiple comparison data items can be set for the same band.
- For details on how to set up parameters, refer to "[Setting Parameters with GM Programmer](#)".

■ Setting example for band comparison

Output setting example

Comparison data	Band comparison value		Output setting	Comparison match 0 flag	Comparison match 1 flag	Comparison match 2 flag	Comparison match 3 flag
	Lower limit	Upper limit					
0	+1,250	2,500	Set	ON	OFF	OFF	OFF
1	+3,750	+5,000	Set	OFF	ON	OFF	ON
2	+3,750	+7,500	Set	OFF	OFF	OFF	ON
3	+6,250	+7,500	Set	ON	ON	ON	ON
4	+8,750	+500	Set	OFF	OFF	ON	OFF

Behavior of comparison match flag during band comparison

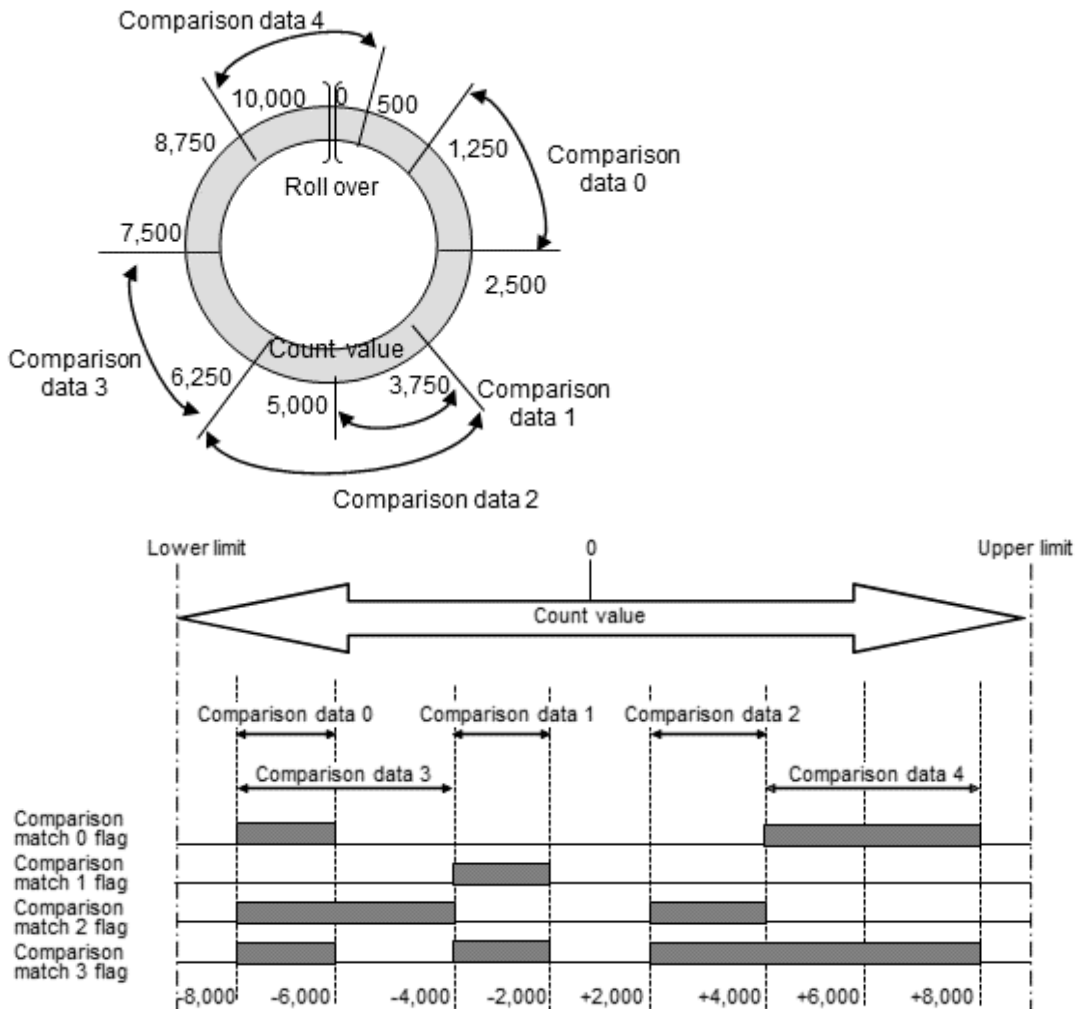

12.2 Setting up the GM1 units

Info.

- For ring counters, comparison data can be set in an area including the lower and upper limits where count values are rolled over.

■ **Parameter settings for external output function**

- The comparison match 0 flag and comparison match 1 flag can be output externally using parameter settings.
- The Counter_Configuration parameter window is used to allocate the comparison match 0 flag and comparison match 1 flag to the external output function.

Info.

- For details on how to set up parameters, refer to "[Setting Parameters with GM Programmer](#)".

External Output Function

■ Overview of external output function

The comparison match 0 flag and comparison match 1 flag can be output externally using parameter settings.

Setup procedure

1. From "Device view" in the navigator pane, double-click "Counter_Configuration".
2. Click the "Counter parameter" tab.
3. For each counter, select "External output function" and set up each parameter.

Counter_Configuration parameter setting example

Category Selection(T)

- Ch0
 - Count function
 - Comparison match leading edge reset
 - Comparison match trailing edge reset
 - Comparison function
 - External output function
 - Capture function
- Ch1
 - Count function
 - Comparison function
 - External output function
 - Capture function

Parameter Setting (R)

Parameter	Value
External output 0 signal setting	Output
External output 0 signal ON hold delay	0
External output 1 signal setting	Not output
External output 1 signal ON hold delay	0

■ ON hold time (for band comparison only)

When the band comparison function is used, ON hold time can be set as an output signal.

Differences in behavior between settings

ON hold time	Timing chart for comparison match flag and external output signal
0	
1 to 1,000 ms	

■ Forced output function

- If the Ch* external output 0* forced ON / OFF request bit is used, the external output 0 signal and external output 1 signal can be turned ON or OFF through user programs.

12.2 Setting up the GM1 units

- The forced output function can be used to check wiring and for other purposes.

Capture Function

■ Setup procedure

1. From "Device view" in the navigator pane, double-click "Counter_Configuration".
2. Click the "Counter parameter" tab.
3. For each counter, select "Capture function" and set up each parameter.

i Info.

- For details on how to set up parameters, refer to "Setting Parameters with GM Programmer".

■ Types of capture function

Capture function

- The count value at the point in time when the input signal from an external device changes is stored in the capture 0 value or capture 1 value register.

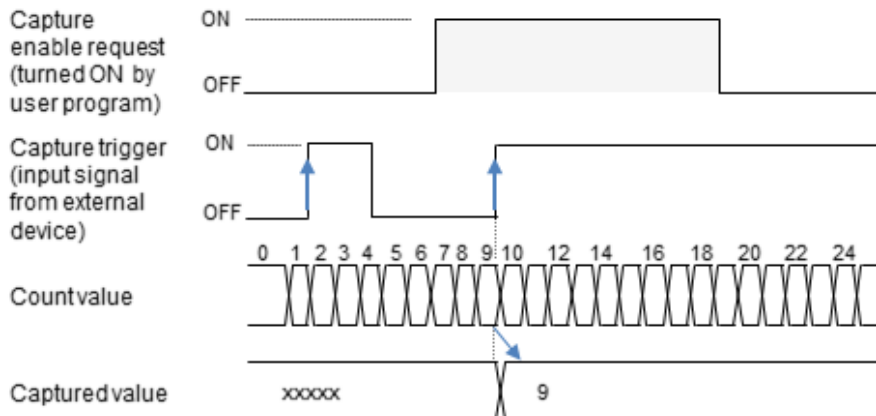

Sampling capture function

- The count value when the specified sampling time elapses after the input signal from an external device changes is stored in the capture 0 value and capture 1 value registers.
- The count value equivalent to the sampling time can be monitored by reading the capture differential value.

12.2 Setting up the GM1 units

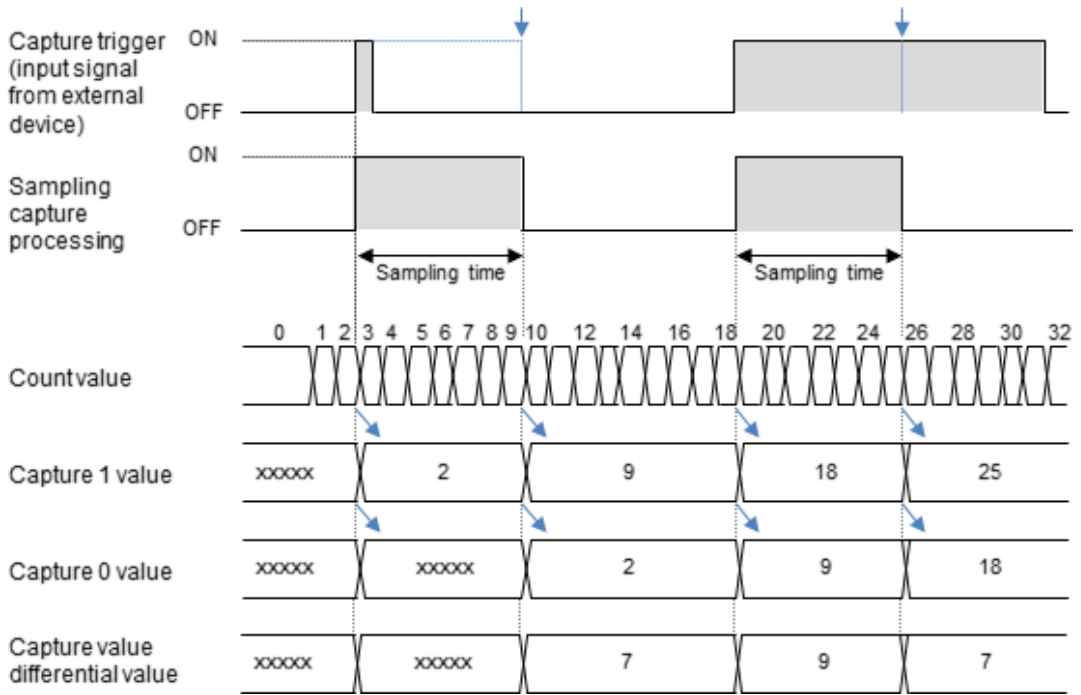

■ Comparison between capture function and sampling capture function

Available conditions differ between the functions.

Comparison between both functions

Item	Capture function	Sampling capture function	
Number of points that can be used	Max. 2 points	Max. 1 point	
	The capture function cannot be used when the sampling capture function is used.		
Registers used	Capture 0 value: 1 register (2 words) Capture 1 value: 1 register (2 words) These registers can be used individually.	Capture 0 value: 1 register (2 words) Capture 1 value: 1 register (2 words) These registers are used simultaneously.	
	Capture differential value: 1 register (2 words)		
Enable condition	The capture function is enabled while the capture enable request bit is ON.	Always enabled	
Capture flags	The Counter_Configuration parameter window is used to allocate capture flags.		
	Control 0 signal	Used as a trigger for capture 0 or capture 1.	Used as a trigger for the sampling capture function
	Control 1 signal	Used as a trigger for capture 0 or capture 1.	Not use
	Validity condition	Activated when either of the following conditions is met. At rising edge of control 0 / 1signal At falling edge of control 0 / 1signal By allocating one of the control signals to the same capture number, the capture function can be allocated as the rising or falling edge of the signal.	Activated when either of the following conditions is met. Control 0 signal (positive logic) Control 0 signal (negative logic) Capture enable request bit (positive logic)
Clearing the capture * status bit	The capture * status bit is cleared automatically each time I/O refresh occurs.		

12.2 Setting up the GM1 units

■ One operation

- When the capture enable request bit enables the capture function, capture is executed when the first capture flag becomes enabled.
- The behaviors differ according to the validity condition (rising edge or falling edge) of the capture flag to be enabled, as below.

When "rising edge" is specified as the capture trigger condition

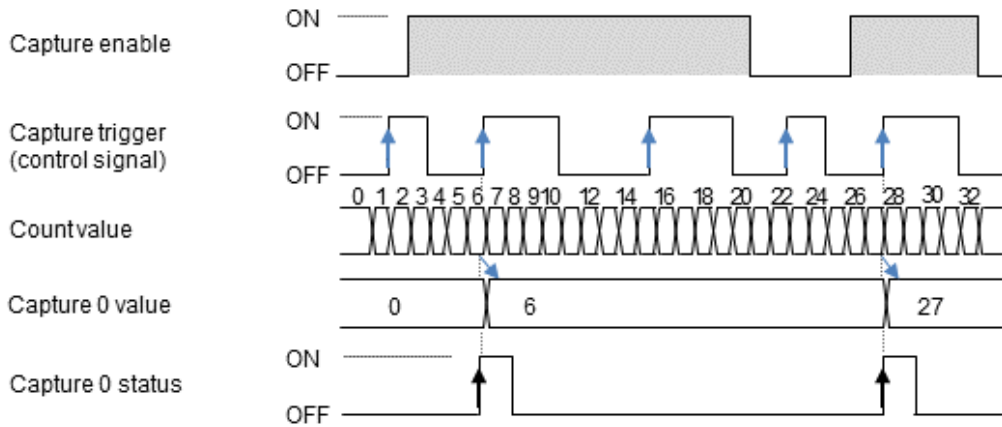

When "falling edge" is specified as the capture trigger condition

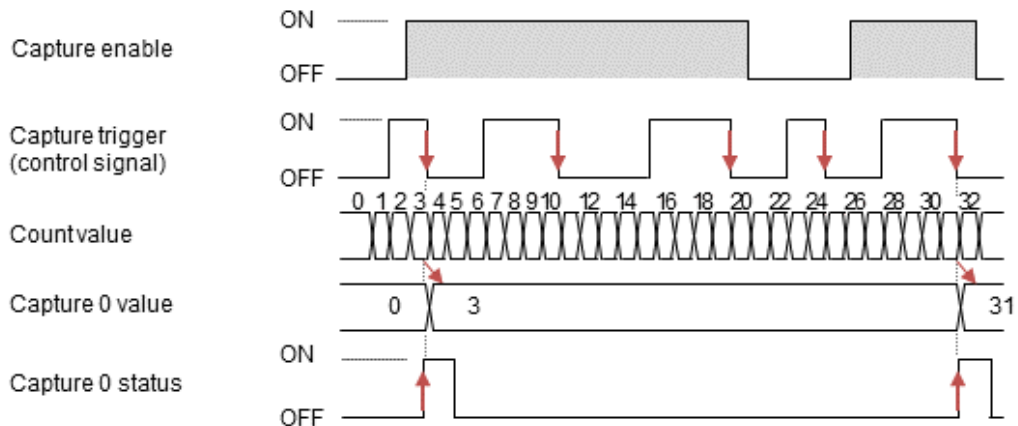

When "rising edge" and "falling edge" of the same signal are specified as the capture trigger conditions

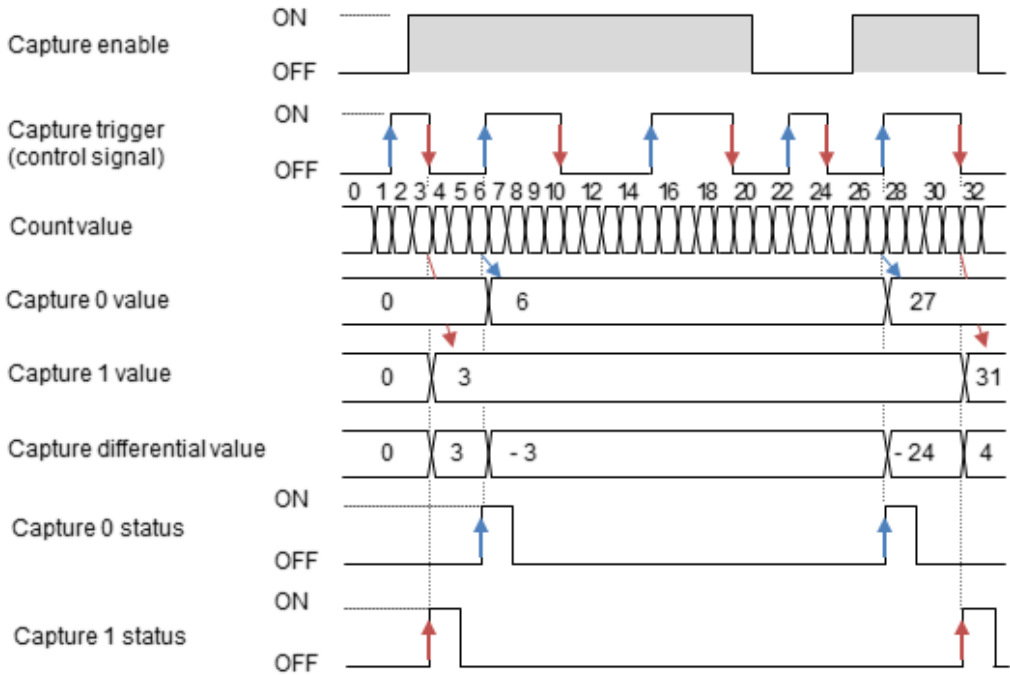

i Info.

- The sign of the capture differential value changes according to the sequence of the capture enable request bit and capture flag.

12.2 Setting up the GM1 units

■ Continuous operation

- When the capture enable request bit enables the capture function, capture is executed every time a capture flag becomes enabled.
- The behaviors differ according to the validity condition (rising edge or falling edge) of the capture flag to be enabled, as below.

When "rising edge" is specified as the capture trigger condition

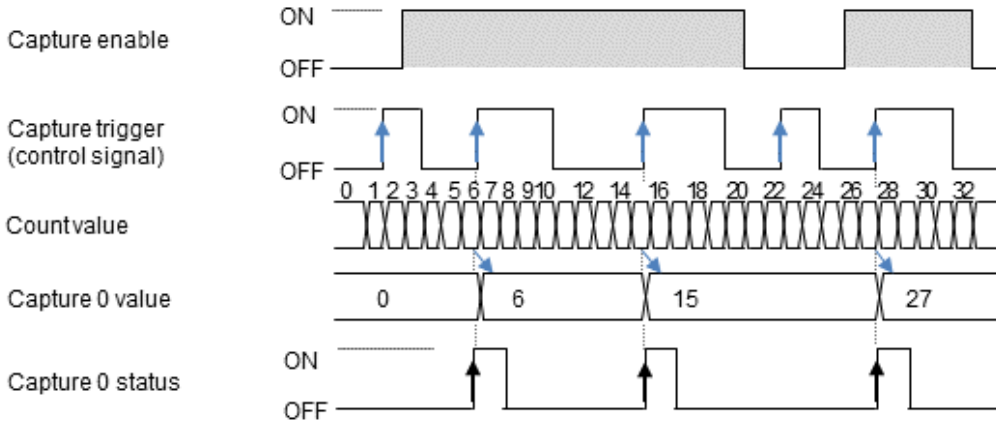

When "falling edge" is specified as the capture trigger condition

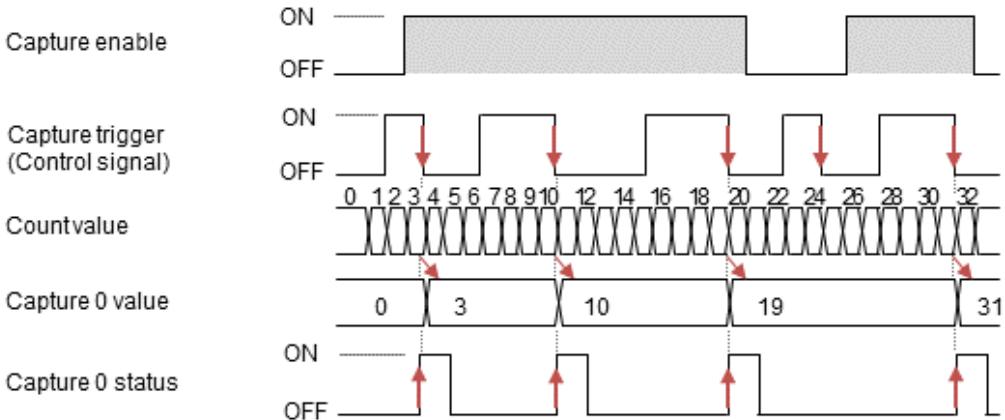

When "rising edge" and "falling edge" of the same signal are specified as the capture trigger conditions

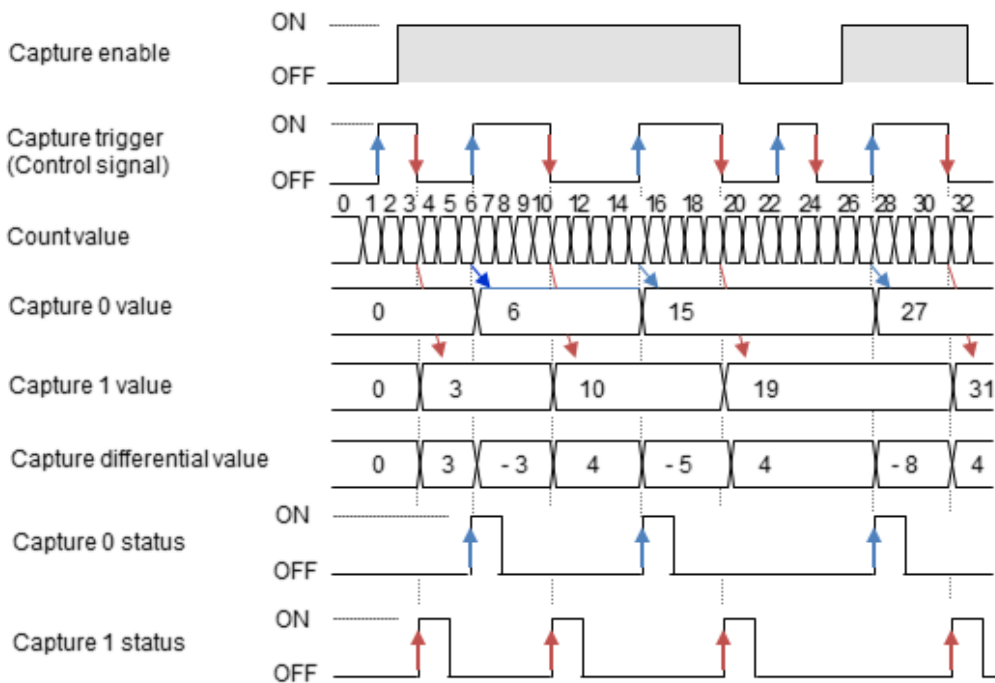

i Info.

- The sign of the capture differential value changes according to the sequence of the capture enable request bit and capture flag.
- For continuous operation, capture 0 value, capture 1 value, and capture differential value are overwritten each time a capture operation is completed.

12.2 Setting up the GM1 units

■ Sampling capture function (one operation)

- When the specified sampling time elapses after the capture flag turns ON or OFF, the count value is stored in the capture 0 value and capture 1 value registers and the differential value is stored in the capture differential value register.
- The sampling capture function is always executable when the control 0 signal is allocated to the sampling capture function.
- The trigger condition that starts sampling capture can be selected from control 0 signal (positive logic), control 1 signal (negative logic), and capture enable request bit (positive logic).
- For one operation, the capture 1 status bit is activated. Note that the capture 0 status bit is not activated.

Timing chart

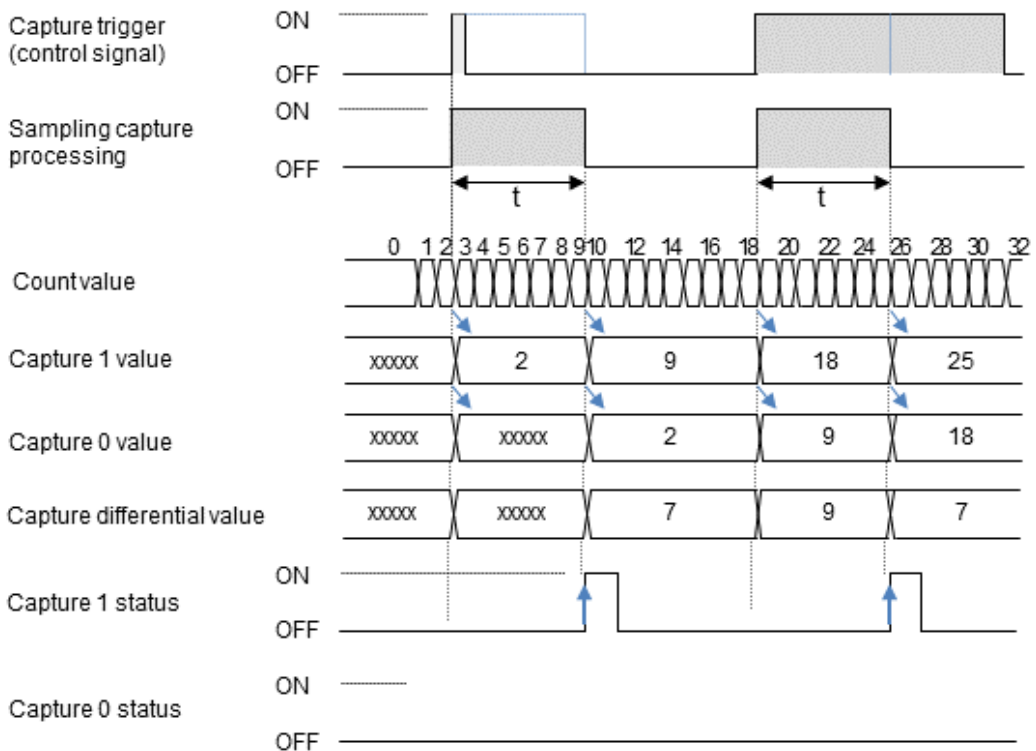

■ **Sampling capture function (continuous operation)**

- Each time the specified sampling time elapses after the capture flag turns ON or OFF, successively, the count value is stored in the capture 0 value and capture 1 value registers and the differential value is stored in the capture differential value register.
- The sampling capture function is always executable when the control 0 signal is allocated to the sampling capture function.
- The trigger condition that starts sampling capture can be selected from control 0 signal (positive logic), control 0 signal (negative logic), and capture enable request bit (positive logic).
- For continuous operation, the capture 0 status bit is activated. Note that the capture 1 status bit is not activated.

Timing chart

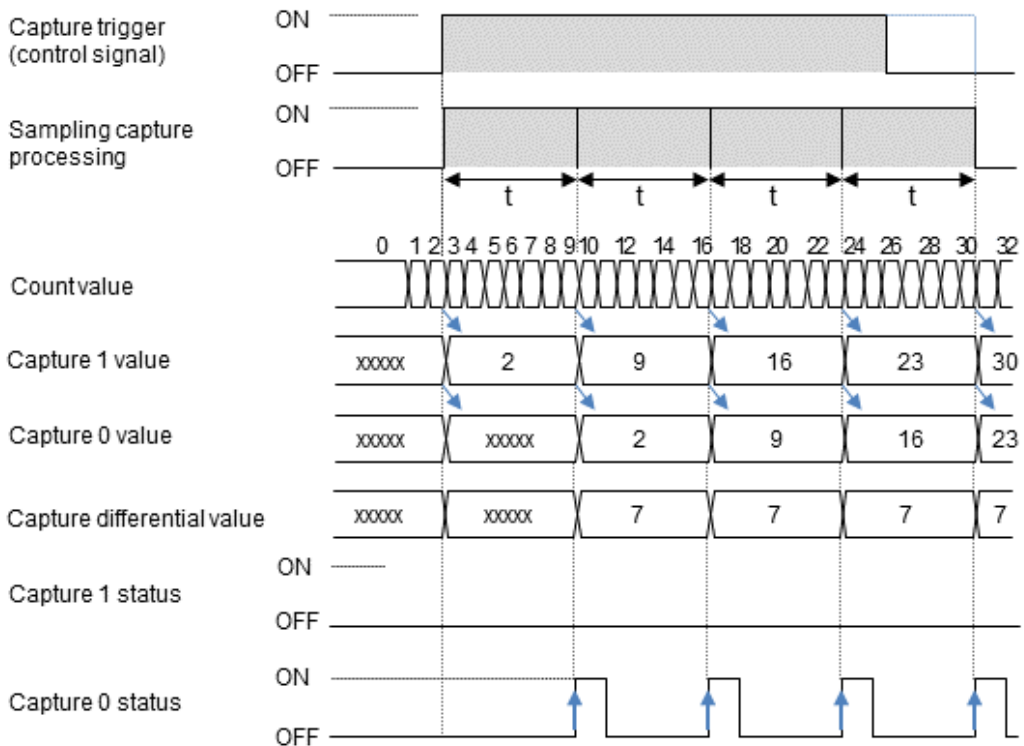

12.2 Setting up the GM1 units

■ Reading captured data

Areas where captured data is stored

- The latest captured data is stored in the capture 0 value and capture 1 value registers.
- Captured data is stored as signed 32-bit data (-2,147,483,648 to 2,147,483,647).

Sample program

To read and write channel data, variables are mapped to channels in the same way as in "12.6.5 Operation Ready Request". In this example, variables are mapped to the channel used for reading captured data for Counter Ch0 (the name of sample POU is created as "Counter3").

Variable	Mapping	Channel	Address	Type	Unit	Description
		InputArea	%ID8			Input area
		Ch0_StatusRegister	%IW16	WORD		Ch0 Status register
Application.Counter.bCh0_OperationReadRequest		Ch0_OperationReadyStatus	%IX32.0	BOOL		Ch0 Operation ready status
		Ch0_CountEnableStatus	%IX32.1	BOOL		Ch0 Count enable status
		Ch0_CountDirectionStatus	%IX32.2	BOOL		Ch0 Count direction status
Application.Counter3.bCh0_Capture0Status		Ch0_Capture0Status	%IX32.4	BOOL		Ch0 Capture 0 status
		Ch0_Capture1Status	%IX32.5	BOOL		Ch0 Capture 1 status
		Ch0_ExternalOutput0Status	%IX32.6	BOOL		Ch0 External output 0 status
		Ch0_ExternalOutput1Status	%IX32.7	BOOL		Ch0 External output 1 status
		Ch0_InputAStatus	%IX33.0	BOOL		Ch0 Input A status
		Ch0_InputBStatus	%IX33.1	BOOL		Ch0 Input B status
		Ch0_InputZStatus	%IX33.2	BOOL		Ch0 Input Z status
		Ch0_Control0Status	%IX33.3	BOOL		Ch0 Control 0 status
		Ch0_Control1Status	%IX33.4	BOOL		Ch0 Control 1 status
		Ch0_ComparisonMatchRegister	%IW17	WORD		Ch0 Comparison match register
Application.Counter2.dCh0_CountValue		Ch0_CountValue	%ID10	DINT		Ch0 Count value
Application.Counter3.dCh0_Capture0Value		Ch0_Capture0Value	%ID11	DINT		Ch0 Capture 0 value
		Ch0_Capture1Value	%ID12	DINT		Ch0 Capture 1 value

LD program

```

1  PROGRAM Counter3
2  VAR
3      // Local variables
4      diCaptureValue      : DINT;      // Capture value read variable
5      // Counter I/O mapping variables
6      bCh0_Capture0Status : BOOL;      // Ch0 capture0 status
7      diCh0_Capture0Value : DINT;      // Ch0 capture0 value
8  END_VAR

```

1

Capture 0 status is ON and read the capture value

```

graph LR
    bCh0_Capture0Status[bCh0_Capture0Status] --> MOVE[MOVE]
    diCh0_Capture0Value[diCh0_Capture0Value] --> MOVE
    MOVE --> diCaptureValue[diCaptureValue]

```

ST program

```
1 PROGRAM Counter3
2 VAR
3     // Local variables
4     diCaptureValue      : DINT;    // Capture value read variable
5     // Counter I/O mapping variables
6     bCh0_Capture0Status : BOOL;    // Ch0 capture0 status
7     diCh0_Capture0Value : DINT;    // Ch0 capture0 value
8 END_VAR
9
10 // Capture 0 status is ON and read the capture value
11 IF bCh0_Capture0Status = TRUE THEN
12     diCaptureValue := diCh0_Capture0Value;
13 END_IF
```

12.2 Setting up the GM1 units

Behaviors and read operations of capture * status bits

Basic behaviors

- When capture is completed, it is reflected in the capture * status bit for each I/O refresh.
- For the capture function, the capture * status bit is reset when the capture enable request bit turns ON.

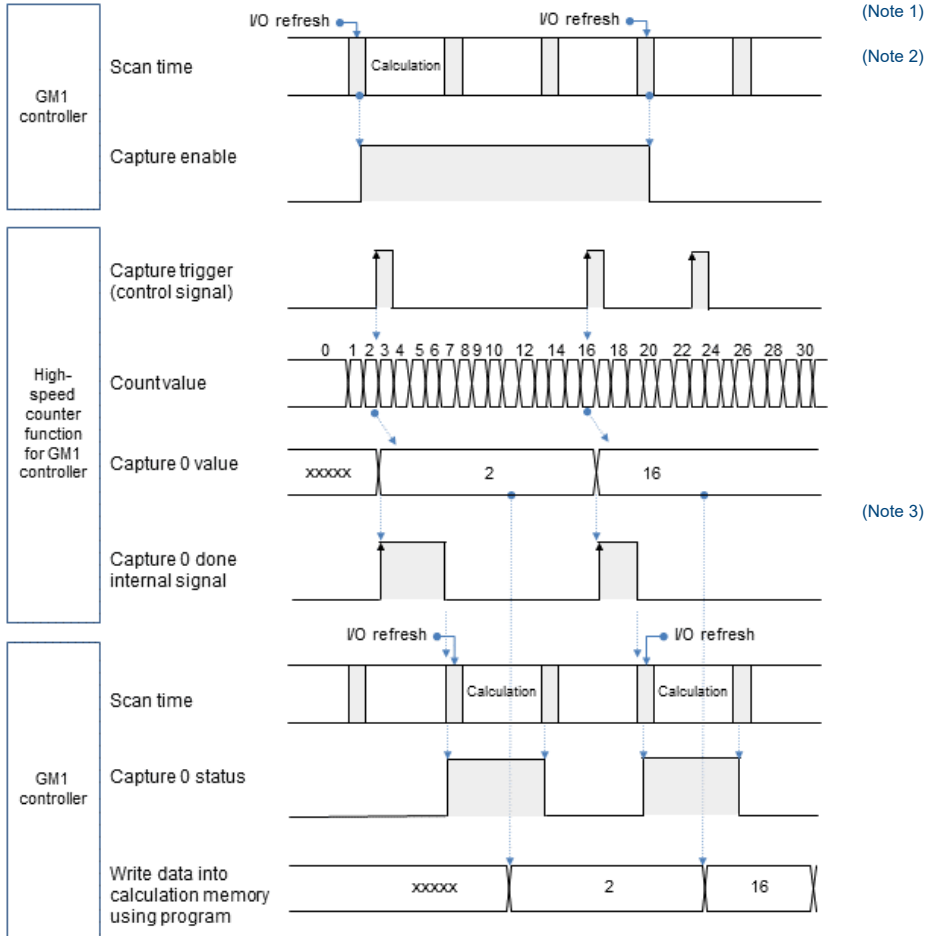

(Note 1) The capture enable request bit is turned ON by a user program.

(Note 2) Each time a capture flag turns ON, a capture operation is performed asynchronously with user program execution. The capture completion internal flag used by the system is reset each time an I/O refresh is performed.

(Note 3) Capture * status bits are reflected each time an I/O refresh is performed. Capture * status bits are used to read capture 0 value, capture 1 value, and capture differential value as arbitrary variables through user programs. These values are read at the time of relevant calculation processing.

Processing when capture trigger input occurs frequently

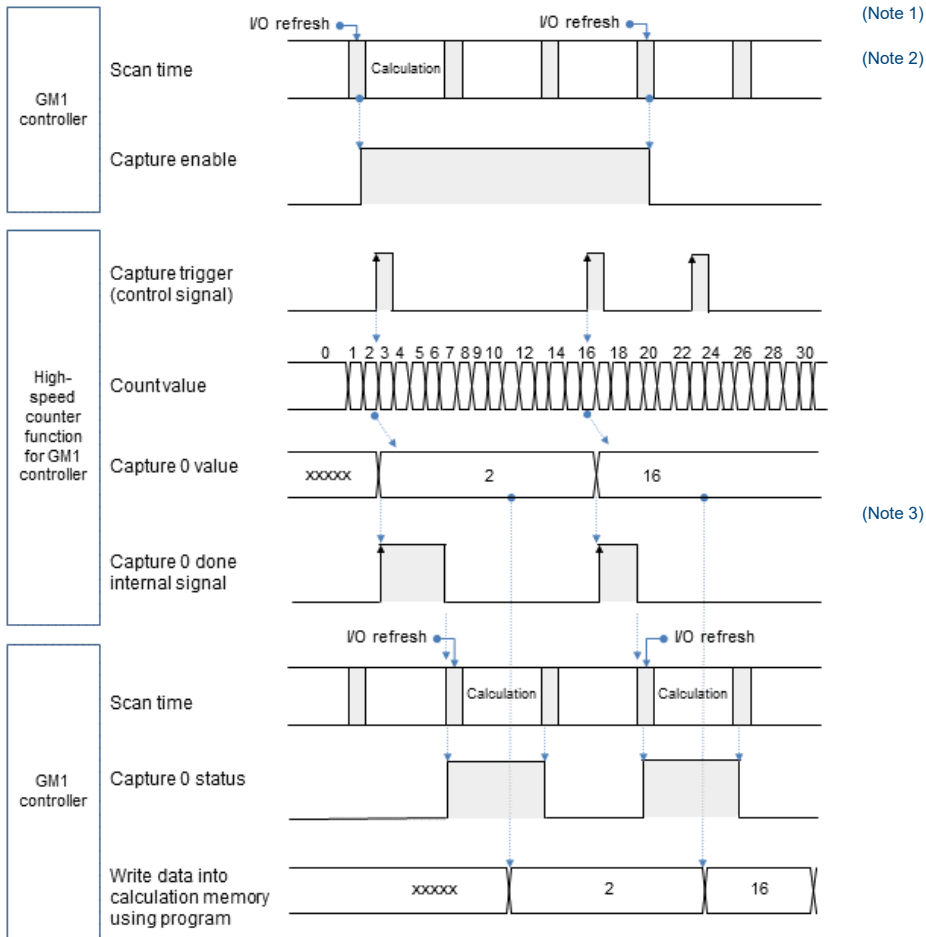

- (Note 1) The capture enable request bit is turned ON by a user program.
- (Note 2) Each time a capture flag turns ON, a capture operation is performed asynchronously with user program execution. The capture completion internal flag used by the system is reset each time an I/O refresh is performed.
- (Note 3) Capture * status bits are reflected each time an I/O refresh is performed. If multiple capture operations are performed continuously, the capture 0 completion status bit or capture 1 completion status bit will remain ON.

Info.

- If control signals used as capture triggers are input frequently, the capture 0 completion status bit or capture 1 completion status bit will remain ON. Take care when reading multiple captured data items.

12.2 Setting up the GM1 units

Unit Error

Overflow and underflow errors with the counter unit are operation stop errors.

To continue the operating status when an error occurs, change the value of PLC parameter "A unit error occurred" to "Continue operation".

12 Procedure

1. From "Device view" in the navigator pane, double-click the "Device" object.
2. Click the "PLC Parameters" tab in the Device window.
3. Change the value of "A unit error occurred" to "Continue operation".

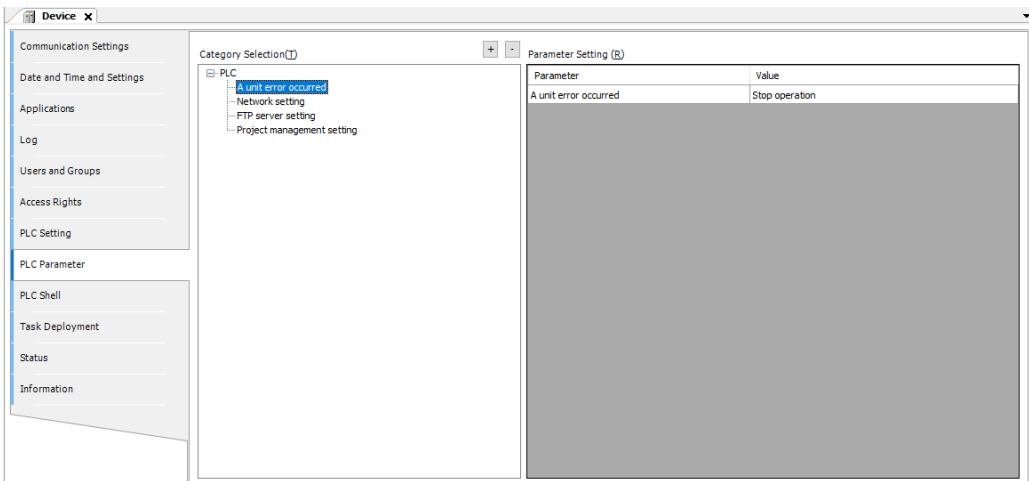

12.3 Expansion unit settings

12.3.1 Adding Expansion Units

This section explains how to add device objects for expansion units to a project and set them up.

For example, use the following procedure to add a digital input unit (product number: AGM1X64D2) to Empty1.

1 2 Procedure

1. Right-click the [Empty1] object in the navigator pane and then select "Unit Management" from the context-sensitive menu that is displayed.

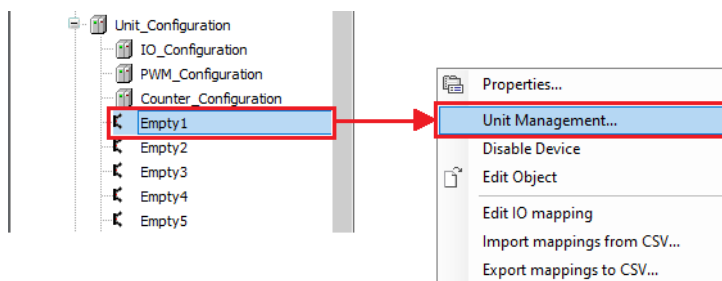

The "Unit Management" dialog box will be displayed.

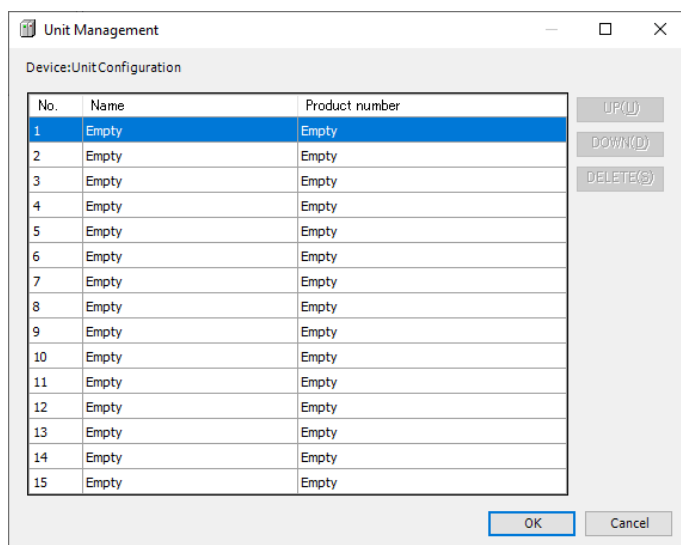

2. Double-click the first row in the "Device: Unit Configuration" table. The "Select Device" dialog box will be displayed.

12.3 Expansion unit settings

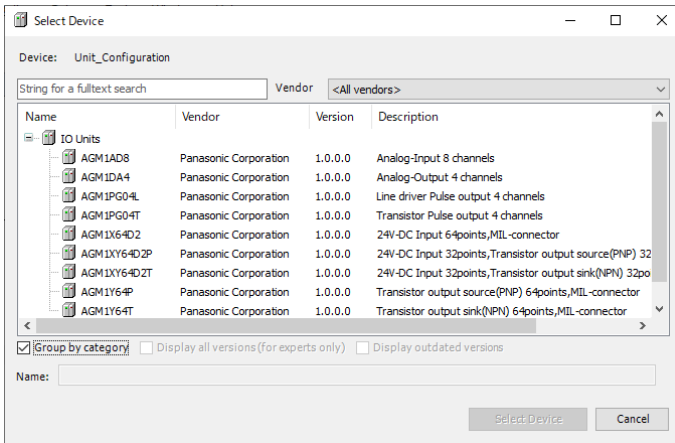

3. Select a device object for the expansion unit to be added.

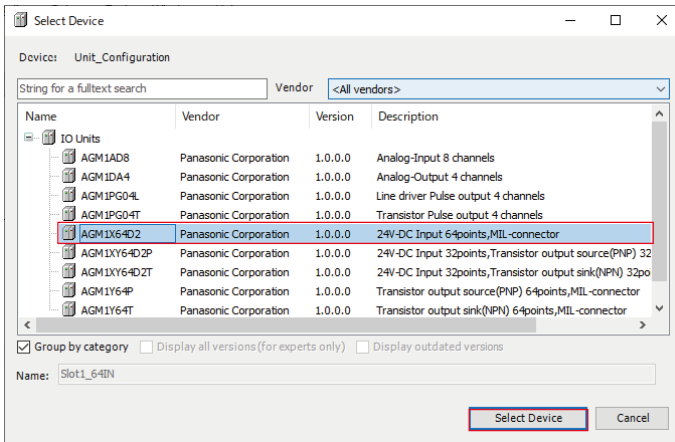

4. Click the [Select Device] button.
The selected device object of the expansion unit will be added.

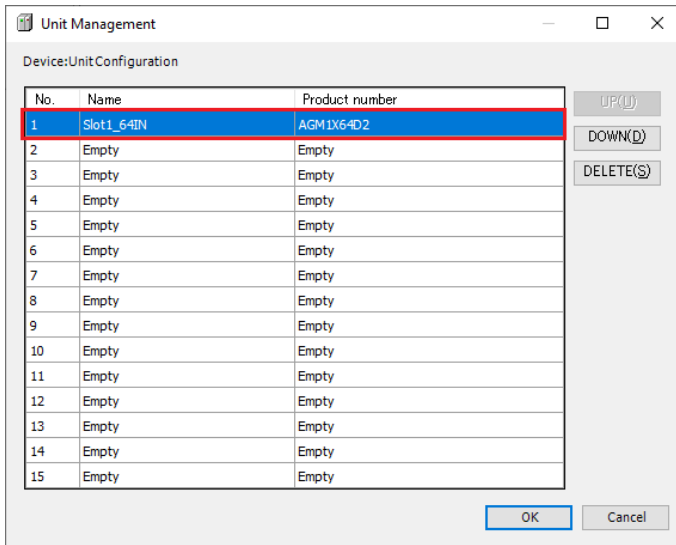

5. Click the [OK] button.

The selected device object of the expansion unit will be added to the navigator pane.

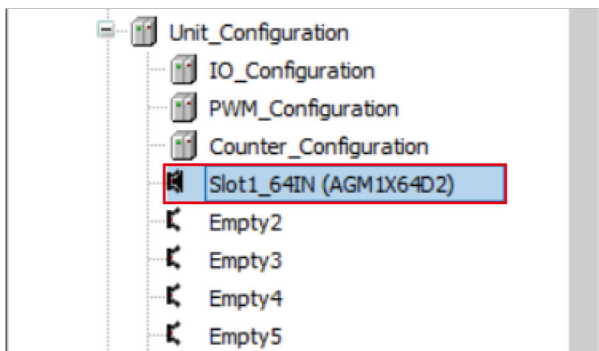

6. Double-click the added object.

The setting pane will be displayed in the main pane. Specify settings related to the expansion unit.

12.3 Expansion unit settings

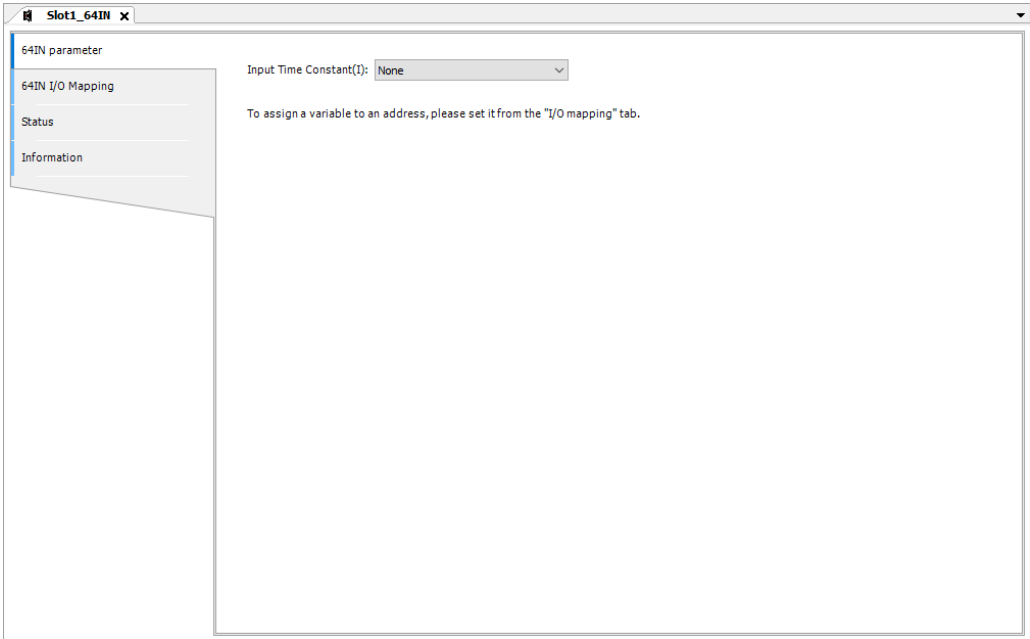

i Info.

- To remove the device object of an expansion unit that has been added, select the expansion unit to be removed in the "Unit Management" dialog box and press the "Delete" key or click the [Delete] button.

12.3.2 Settings of I/O Unit

Expansion I/O units are classified into 64-point input, 64-point output, and 32-point I/O units. This section explains 32-point I/O units as an example.

Setting Parameters with GM Programmer

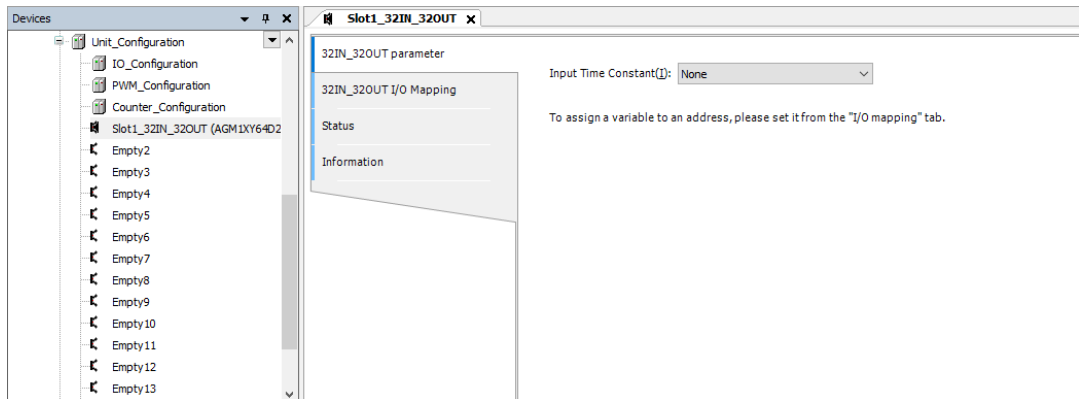

Parameter Settings

■ Parameter

Setting item	Settings	Default value	Description
Input time constant	None 0.1 ms 0.5 ms 1 ms 5 ms 10 ms 20 ms 70 ms	None	Input time constant

■ Accuracy of time constant

There is an error in the time constant to be set, so please check in advance before selecting the setting value. The precision of each time constant is shown in the table below.

Set value	Accuracy	
	Min.	Max.
No time constant setting	-	-
0.1ms	0.1ms	0.2ms
0.5ms	0.3ms	0.7ms
1ms	0.7ms	1.3ms
5ms	3.0ms	5.2ms
10ms	6.0ms	10.4ms
20ms	12.1ms	20.7ms
70ms	48.6ms	82.8ms

I/O Mapping for I/O Unit

Channel	Type	Description	Remarks
Ch0_In	WORD	Ch0_In	
Ch1_In	WORD	Ch1_In	
Ch0_Out	WORD	Ch0_Out	
Ch1_Out	WORD	Ch1_Out	

■ Ch*_In

* represents 0 or 1.

Channel	Type	Description	Remarks
Ch*_In00	BOOL	Ch*_In00	
Ch*_In01	BOOL	Ch*_In01	

12.3 Expansion unit settings

Channel	Type	Description	Remarks
Ch*_In02	BOOL	Ch*_In02	
Ch*_In03	BOOL	Ch*_In03	
Ch*_In04	BOOL	Ch*_In04	
Ch*_In05	BOOL	Ch*_In05	
Ch*_In06	BOOL	Ch*_In06	
Ch*_In07	BOOL	Ch*_In07	
Ch*_In08	BOOL	Ch*_In08	
Ch*_In09	BOOL	Ch*_In09	
Ch*_In10	BOOL	Ch*_In10	
Ch*_In11	BOOL	Ch*_In11	
Ch*_In12	BOOL	Ch*_In12	
Ch*_In13	BOOL	Ch*_In13	
Ch*_In14	BOOL	Ch*_In14	
Ch*_In15	BOOL	Ch*_In15	

■ Ch*_Out

* represents 0 or 1.

Channel	Type	Description	Remarks
Ch*_Out00	BOOL	Ch*_Out00	
Ch*_Out01	BOOL	Ch*_Out01	
Ch*_Out02	BOOL	Ch*_Out02	
Ch*_Out03	BOOL	Ch*_Out03	
Ch*_Out04	BOOL	Ch*_Out04	
Ch*_Out05	BOOL	Ch*_Out05	
Ch*_Out06	BOOL	Ch*_Out06	
Ch*_Out07	BOOL	Ch*_Out07	
Ch*_Out08	BOOL	Ch*_Out08	
Ch*_Out09	BOOL	Ch*_Out09	
Ch*_Out10	BOOL	Ch*_Out10	
Ch*_Out11	BOOL	Ch*_Out11	
Ch*_Out12	BOOL	Ch*_Out12	
Ch*_Out13	BOOL	Ch*_Out13	
Ch*_Out14	BOOL	Ch*_Out14	
Ch*_Out15	BOOL	Ch*_Out15	

12.3.3 Analog I/O Unit

The analog I/O unit receives various analog values (i.e., voltage, current, and temperature values) from laser analog sensors and pressure sensors and converts them internally into digital values.

Info.

- For details, refer to the *GM1 Series Reference Manual (Analog I/O Unit Edition)*.

12.3.4 Pulse Output Unit

The pulse output unit can be combined with a stepping motor or servo motor to achieve position control.

Info.

- For details, refer to the *GM1 Series Reference Manual (Pulse Output Unit Edition)*.

12.3.5 Serial Communication Unit

The serial communication unit communicates with display units, etc. via serial communication (RS-232C, RS-422, or RS-485).

Info.

- For details, refer to the *GM1 Series Reference Manual (Serial Communication Unit Edition)*.

(MEMO)

13 Communication Function

13.1 Overview of Communication Function	13-3
13.1.1 Adding a Protocol to Be Used for the LAN Port	13-3
13.1.2 Adding Serial Communication Devices	13-8
13.1.3 List of Devices	13-10
13.2 General-purpose Communication	13-11
13.2.1 General-purpose Communication (Ethernet)	13-11
13.2.2 General-purpose Communication (Serial)	13-12
13.3 MODBUS	13-13
13.3.1 What is Modbus TCP?	13-13
13.3.2 Modbus-TCP Master Communication	13-13
13.3.3 Modbus-TCP Slave Communication	13-18
13.3.4 Modbus-RTU Master Communication	13-21
13.3.5 Modbus-RTU Slave Communication	13-29
13.4 EtherNet/IP	13-33
13.4.1 What is EtherNet/IP?	13-33
13.4.2 Cyclic Communication Function	13-33
13.4.3 EtherNet/IP Scanner Function	13-33
13.4.4 Setting up the EtherNet/IP Scanner Function	13-34
13.4.5 EtherNet/IP Scanner Operation	13-41
13.4.6 EtherNet/IP Adapter Function	13-44
13.4.7 Setting up the EtherNet/IP Adapter Function	13-44
13.4.8 EtherNet/IP Adapter Operation	13-50
13.5 Communicating with Display Units	13-51
13.5.1 Symbol Configuration	13-51
13.6 OPC UA Server	13-55
13.6.1 What is OPC UA?	13-55
13.6.2 OPC UA Server Settings	13-55
13.6.3 OPC UA Server Specifications	13-56
13.6.4 Security Settings	13-57
13.7 FTP Server Function	13-58
13.7.1 Overview of FTP Server Function	13-58
13.7.2 Setup Procedure	13-58
13.7.3 List of Setting Items	13-59
13.7.4 FTP Server Standards	13-60
13.7.5 SSL/TLS Certificate Settings	13-61
13.8 MQTT Client	13-63
13.8.1 What is MQTT?	13-63
13.8.2 MQTT Client Specifications	13-64

13 Communication Function

13.9 DNS client.....	13-67
13.9.1 What is DNS?	13-67
13.10 NTP client	13-68
13.10.1 What is NTP?	13-68

13.1 Overview of Communication Function

The GM1 controller allows general-purpose communication and various protocols with external devices via COM and LAN ports.

The following table shows the functions supported by each port.

Port	Supported protocol	Maximum number of connections	
COM port	General-purpose communication	1 port	
	MODBUS-RTU(Master/Slave)		
LAN port 1/ port 2	General-purpose communication	16 connections in total	
	Communication with the display (CodesysV3)		
	OPC UA (Server)		2 connections in total
	FTP (Server)		3 connections in total
	MQTT Client		3 connections in total
	MODBUS-TCP(Master/Slave)		port 1 : 16 connections in total port 2 : 32 connections in total
LAN port2	EtherNet/IP(Scanner/Adapter)		

i Info.

- The IP address of the LAN port and FTP server setting can be changed using the "PLC Parameters" tab in the Device setting window.
For details, refer to ["4.3 Setting up the GM1 Controller"](#) and ["13.7.3 List of Setting Items"](#) .
- LAN port 2 has a limit on the total number of MODBUS-TCP and EtherNet / IP connections.

13.1.1 Adding a Protocol to Be Used for the LAN Port

This section explains how to add an object of the protocol to be used for the LAN port to a project and set it up.

For example, use the following procedure to add an object of Modbus TCP to LANPort1 and set it up.

1 2 Procedure

1. Right-click the [LANPort1] object in the navigator pane and then select "Add Device" from the context-sensitive menu that is displayed.

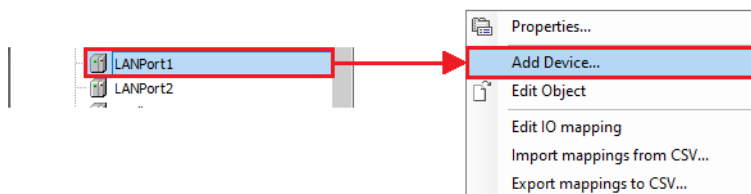

The "Add Device" dialog box will be displayed.

13.1 Overview of Communication Function

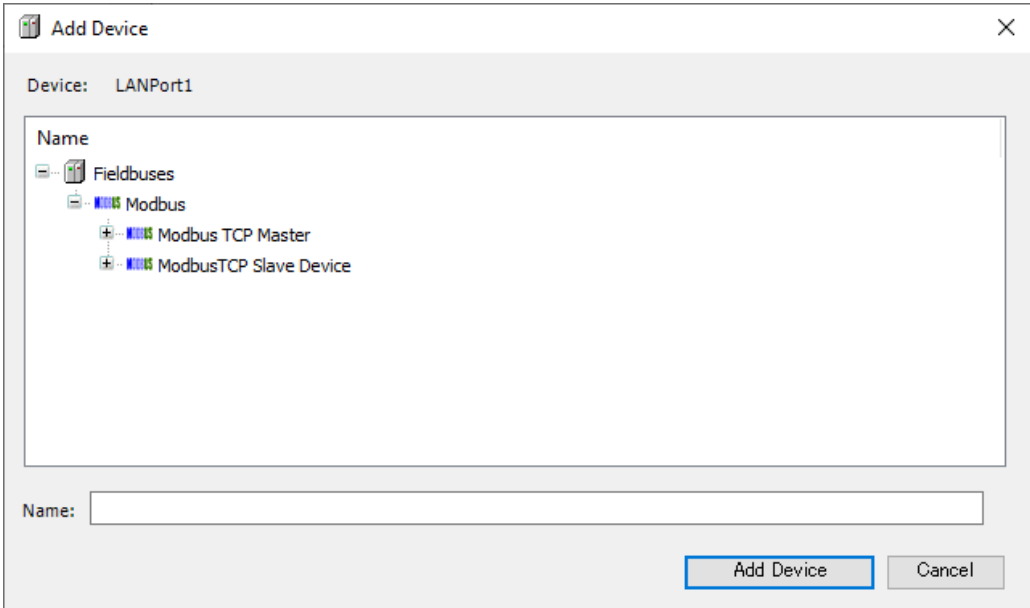

2. Select device "Modbus TCP Master".

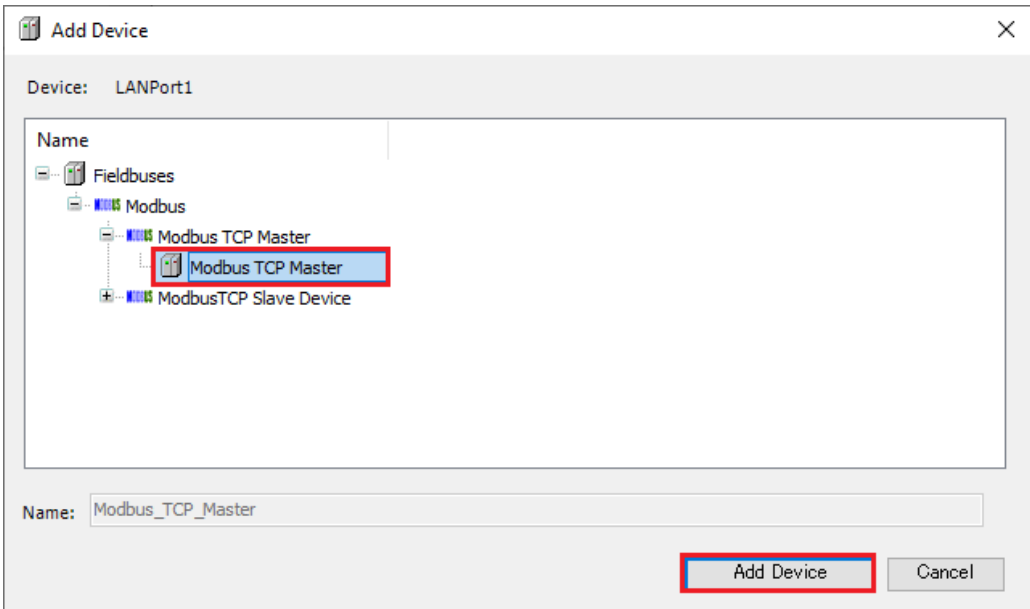

3. Click the [Add Device] button.
Object [Modbus_TCP_Master] will be added to the navigator pane.

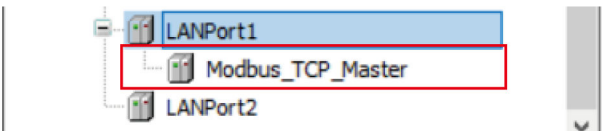

Then, add object [ModbusTCP_Slave_Device] below object [Modbus_TCP_Master].

4. Right-click the [LANPort1] object and then select "Add Device" from the context-sensitive menu that is displayed.

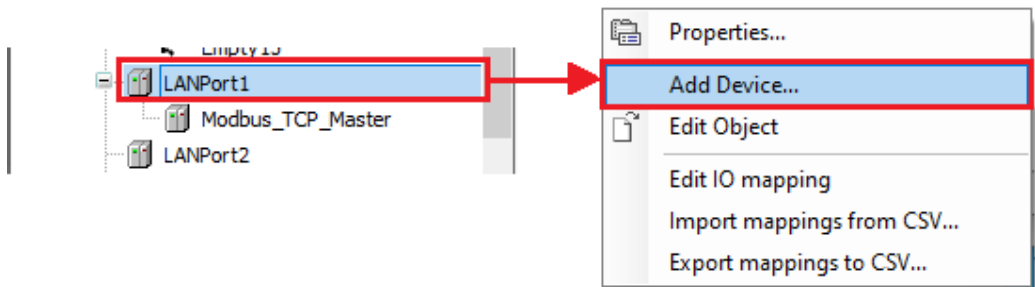

The "Add Device" dialog box will be displayed.

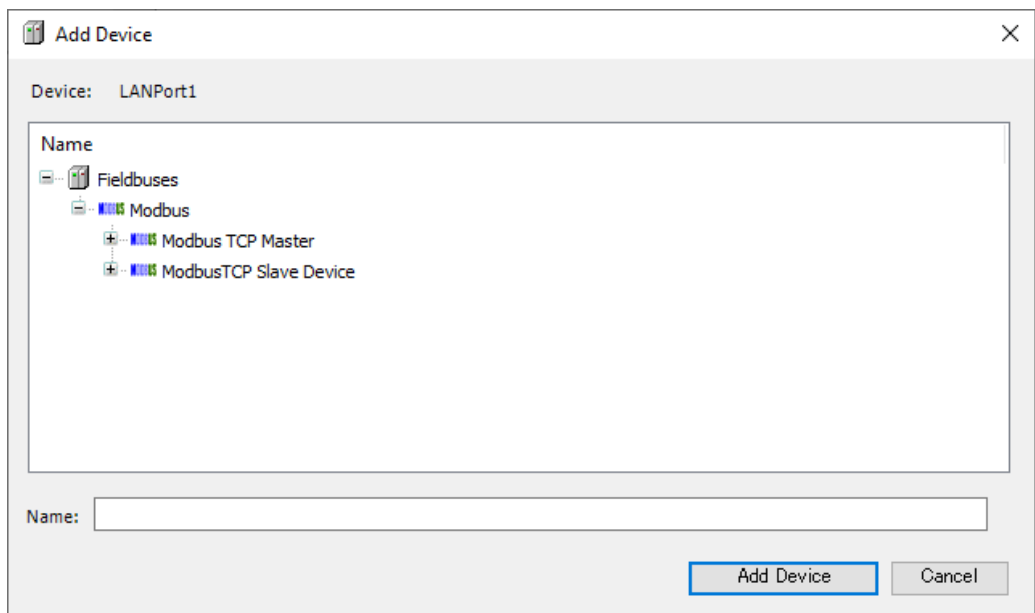

5. Select device "Modbus TCP Slave Device".

13.1 Overview of Communication Function

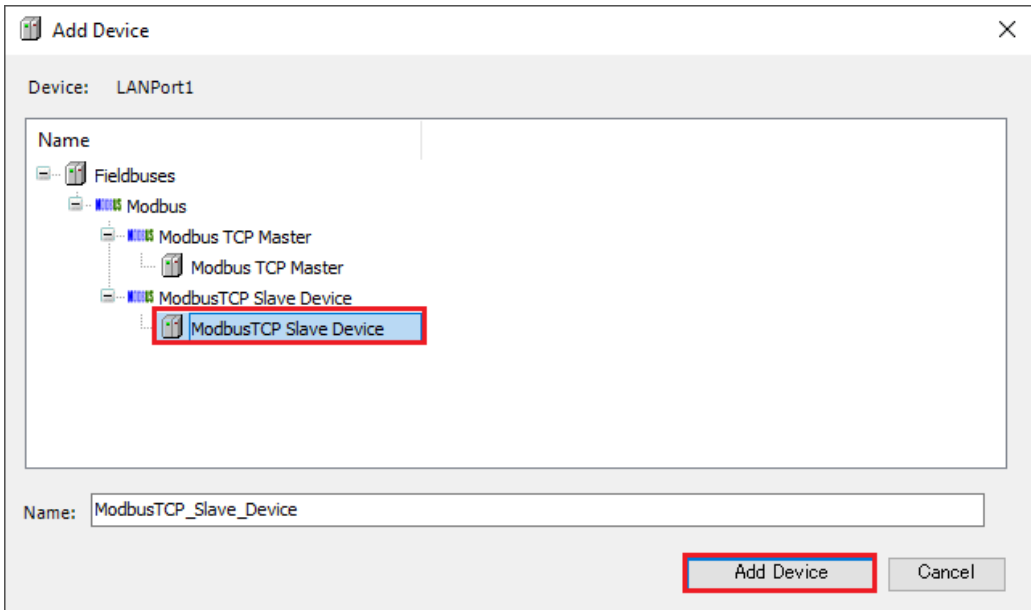

6. Click the [Add Device] button.
The [ModbusTCP_Slave_Device] object will be added.

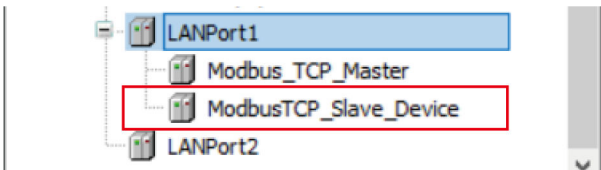

7. Double-click the added object.
The setting pane will be displayed in the main pane. Specify settings related to Modbus TCP.

The screenshot shows a software window titled "ModbusTCP_Slave_Device" with a sidebar on the left and a main configuration area on the right. The sidebar contains a tree view with the following items: "General", "Modbus TCP Slave Device I/O Mapping", "Modbus TCP Slave Device IEC Objects", "Modbus TCP Slave Device Parameters", "Information", and "Status". The "General" item is selected. The main area is divided into two sections: "Configured Parameters" and "Data Model".

Configured Parameters

- Watchdog: 500 (ms)
- Slave port: 502
- Unit ID: [Empty]
- Holding registers: 10 (%IW) Writeable
- Input registers: 10 (%QW)

Data Model

StartAddresses

- Coils: 0
- Discrete inputs: 0
- Holding register: 0
- Input register: 0

Holding- and input register data areas overlay

i Info.

- To remove a device that has been added, select the device in the navigator pane and press the "Delete" key.

13.1 Overview of Communication Function

13.1.2 Adding Serial Communication Devices

1 2 Procedure

1. Right-click the "Device" object in the navigator pane and then select "Add Device" from the context-sensitive menu that is displayed.

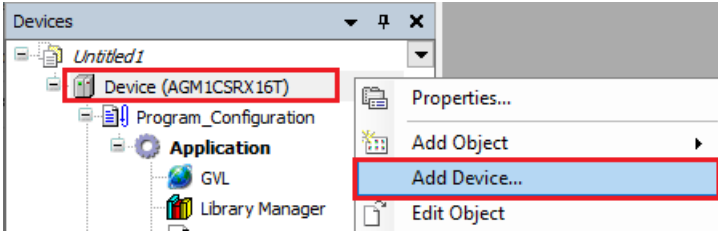

The "Add Device" dialog box will be displayed.

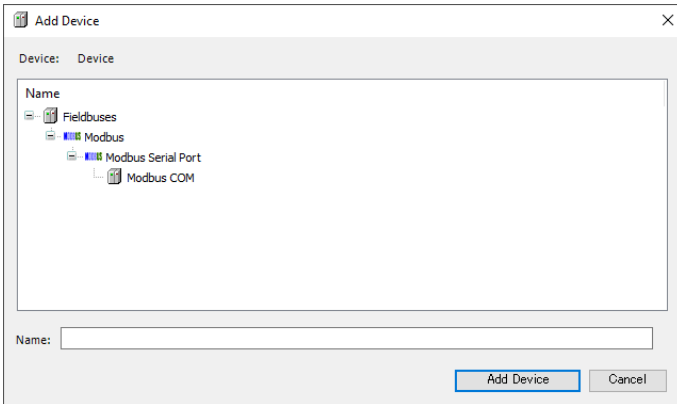

2. Select "Modbus COM".

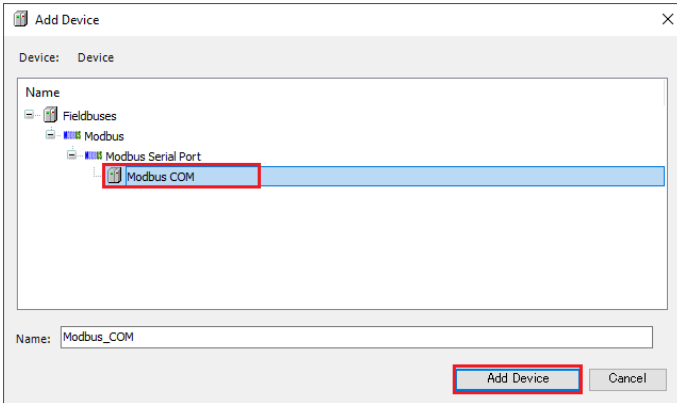

3. Click the [Add Device] button.
The selected "Modbus_COM" object will be added to the navigator pane.



4. Right-click the "Modbus_COM" object and then select "Add Device" from the context-sensitive menu that is displayed.

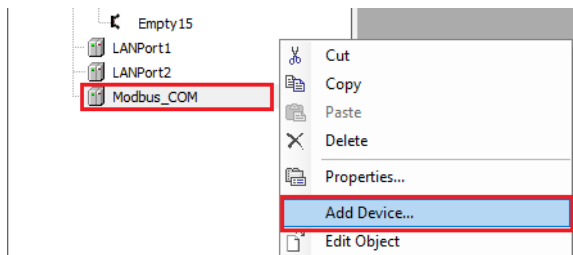

The "Add Device" dialog box will be displayed.

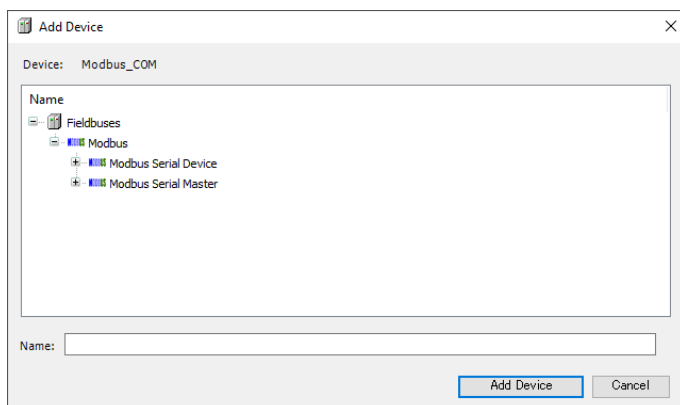

5. Select "Modbus_Serial_Device".

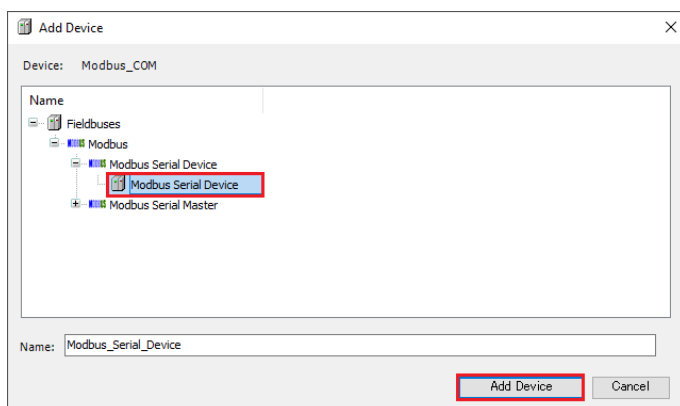

6. Click the [Add Device] button.
The selected "Modbus_Serial_Device" object will be added to the navigator pane.

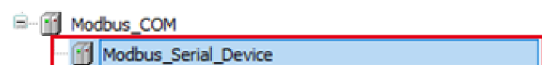

13.1 Overview of Communication Function

For details on how to set up, refer to "13.3 MODBUS".

13.1.3 List of Devices

Check the following list for devices that can be added.

Addition source	Added device
Device	Modbus COM
RTEX_Master	RTEX_A5N RTEX_A6N
EtherCAT_Master_SoftMotion	Various EtherCAT slaves can be selected.
SoftMotion General Axis Pool	SM_FreeEncoder SM_Drive_Virtual
Unit_Configuration or Empty1 to Empty15	AGM1X64D2 AGM1Y64T AGM1Y64P AGM1XY64D2T AGM1XY64D2P AGM1AD8 AGM1DA4 AGM1PG04T AGM1PG04L AGM1NSCS2 AGM1NSCM2 AGM1NSCS1M1
LAN Port1	Modbus TCP Master ModbusTCP Slave Drive
LAN Port2	Modbus TCP Master ModbusTCP Slave Drive EtherNet/IP Scanner EtherNet/IP Adapter
Modbus TCP Master	Modbus TCP Slave
EtherNet/IP Scanner	Remote adapter for each device can be selected
EtherNet/IP Adapter	EtherNet/IP Module
Modbus COM	Modbus Serial Device Modbus Master, COM Port
Modbus Master, COM Port	Modbus Slave COM Port

13.2 General-purpose Communication

13.2.1 General-purpose Communication (Ethernet)

This section explains how to use the CAA_NetBaseServices, in the following order.

1 2 Procedure

1. Double-click "Library Manager" in the Navigator window

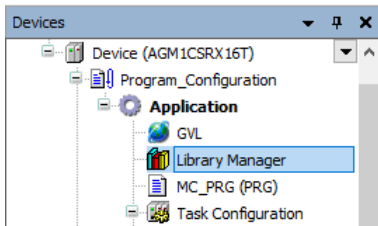

2. Check that the following CAA_NetBaseServices library is registered in Library_Manager.

The screenshot shows the 'Library Manager' window with a table of registered libraries. The 'CAA NetBaseSrv' library is highlighted in blue. The table has three columns: Name, Namespace, and Effective version.

Name	Namespace	Effective version
3SLicense = 3SLicense, 3.5.14.0 (3S - Smart Software Solutions GmbH)	_3S_LICENSE	3.5.14.0
BreakpointLogging = Breakpoint Logging Functions, 3.5.5.0 (3S - Smart Software Solutions GmbH)	BPLog	3.5.5.0
CAA File = CAA File, 3.5.15.0 (CAA Technical Workgroup)	FILE	3.5.15.0
CAA NetBaseSrv = CAA Net Base Services, 3.5.15.0 (CAA Technical Workgroup)	NBS	3.5.15.0
CAA SerialCom = CAA SerialCom, 3.5.15.0 (CAA Technical Workgroup)	COM	3.5.15.0
IoDrvEthernet = IoDrvEthernet, 3.5.15.0 (3S - Smart Software Solutions GmbH)	IoDrvEthernet	3.5.15.0
IoDrvRTEX = IoDrvRTEX, 0.6.8.2 (Panasonic Corporation)	IoDrvRTEX	0.6.8.2

For reference programs, please refer to the *GM1 Series Reference Manual (Instruction)*..

13.2 General-purpose Communication

13.2.2 General-purpose Communication (Serial)

This section explains how to use the CAA SerialCom, in the following order.

1 2 Procedure

1. Double-click "Library Manager" in the Navigator window

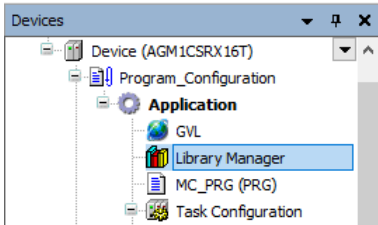

2. Check that the following CAA SerialCom library is registered in Library_Manager.

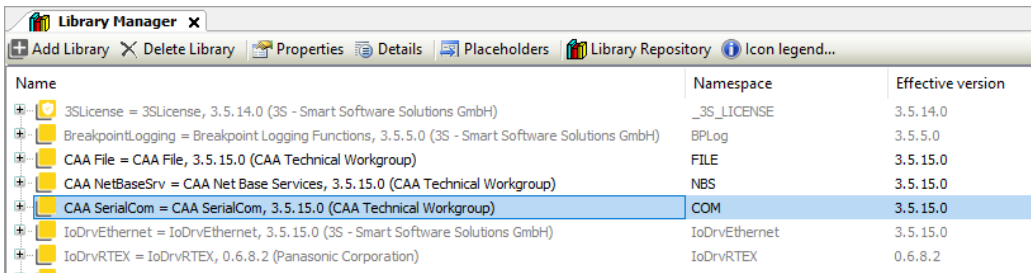
A screenshot of the 'Library Manager' window. It displays a table of registered libraries. The 'CAA SerialCom' library is highlighted in blue. The table has three columns: 'Name', 'Namespace', and 'Effective version'.

Name	Namespace	Effective version
3SLicense = 3SLicense, 3.5.14.0 (3S - Smart Software Solutions GmbH)	_3S_LICENSE	3.5.14.0
BreakpointLogging = Breakpoint Logging Functions, 3.5.5.0 (3S - Smart Software Solutions GmbH)	BPLog	3.5.5.0
CAA File = CAA File, 3.5.15.0 (CAA Technical Workgroup)	FILE	3.5.15.0
CAA NetBaseSrv = CAA Net Base Services, 3.5.15.0 (CAA Technical Workgroup)	NBS	3.5.15.0
CAA SerialCom = CAA SerialCom, 3.5.15.0 (CAA Technical Workgroup)	COM	3.5.15.0
IoDrvEthernet = IoDrvEthernet, 3.5.15.0 (3S - Smart Software Solutions GmbH)	IoDrvEthernet	3.5.15.0
IoDrvRTEX = IoDrvRTEX, 0.6.8.2 (Panasonic Corporation)	IoDrvRTEX	0.6.8.2

For reference programs, please refer to the *GM1 Series Reference Manual (Instruction)*.

13.3 MODBUS

13.3.1 What is Modbus TCP?

The GM1 controller can communicate with HMI and controllers via the Modbus protocol. Master communication or slave communication can be performed by adding a master or slave device for Modbus to the project file.

13.3.2 Modbus-TCP Master Communication

The Modbus-TCP master function can be used to send commands to slave devices in the following two ways.

1) When device object settings are used

- Transmission method based on slave initialization
- Transmission method
 - Cyclic
 - Rising edge
 - Application (ModbusChannel function block)

2) When device object settings are not used

- A method by which a user program (ModbusRequest function block) generates and sends commands

i Info.

- For details on how to use ModbusRequest, refer to the *GM1 Series Reference Manual (Instruction)*.

The method in 1) is explained below.

1 2 Procedure

1. Right-click the "LANPort1" object in the navigator pane and then select Add Device from the context-sensitive menu that is displayed.

The "Add Device" dialog box will be displayed.

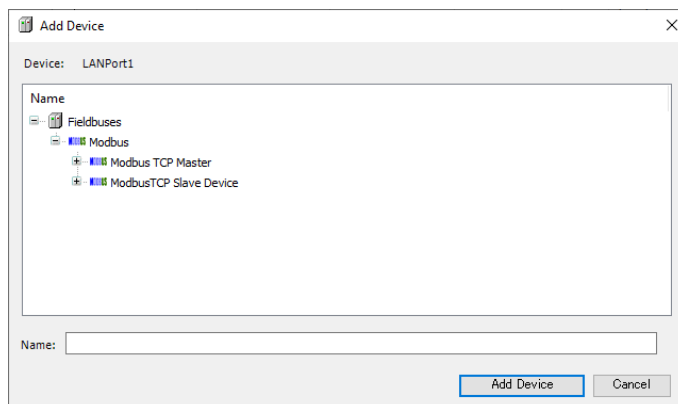

13.3 MODBUS

2. Select "Modbus TCP Master" under "Modbus" and click the [Add Device] button. "Modbus_TCP_Master" will be added to the "LANPort1" object.

Example: When master communication is performed via LAN port1

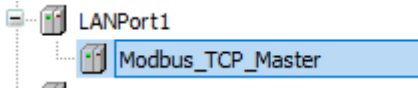

3. Right-click the "Modbus_TCP_Master" object in the navigator pane and then select Add Device from the context-sensitive menu that is displayed. The "Add Device" dialog box will be displayed.

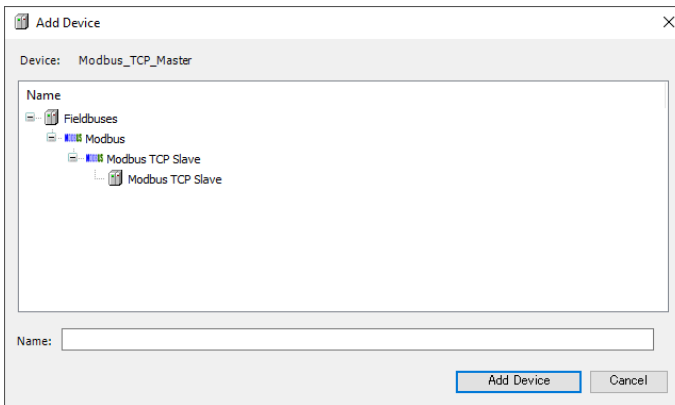

4. Select "Modbus TCP Slave" under "Modbus TCP Slave" and click the [Add Device] button. "Modbus_TCP_Slave" will be added to the "Modbus_TCP_Master" object.

Example: When master communication is performed via LAN port1

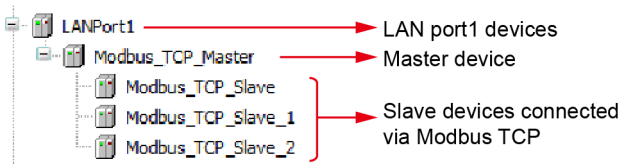

5. Open the device (AGM1CSR16T1) of the GM1 controller, select the "'PLC' Parameters" tab, and set the IP address of LAN port1.

The 'Device' parameters window is shown with the 'PLC Parameters' tab selected. The table below represents the data visible in the window.

Parameter	Type	Value	Default Value	Unit	Description
A unit error occurred	Enumeration of BYTE	Stop operation	Stop operation		Please select the operation when a unit error occurred.
Network setting					Network setting
LAN port1					LAN port1 network settings
IP Address	STRING	'192.168.1.5'	'192.168.1.5'		Specify the ip address for LAN port1.
Subnet Mask	STRING	'255.255.255.0'	'255.255.255.0'		Specify the subnet mask for LAN port1.
Default Gateway	STRING	'192.168.1.1'	'192.168.1.1'		Specify the default gateway for LAN port1.
LAN port2					LAN port2 network settings
IP Address	STRING	'192.168.2.5'	'192.168.2.5'		Specify the ip address for LAN port2.
Subnet Mask	STRING	'255.255.255.0'	'255.255.255.0'		Specify the subnet mask for LAN port2.
Default Gateway	STRING	'0.0.0.0'	'0.0.0.0'		Specify the default gateway for LAN port2.

6. Double-click "Modbus_TCP_Slave" in the navigator pane. The "Modbus_TCP_Slave" object will be displayed.

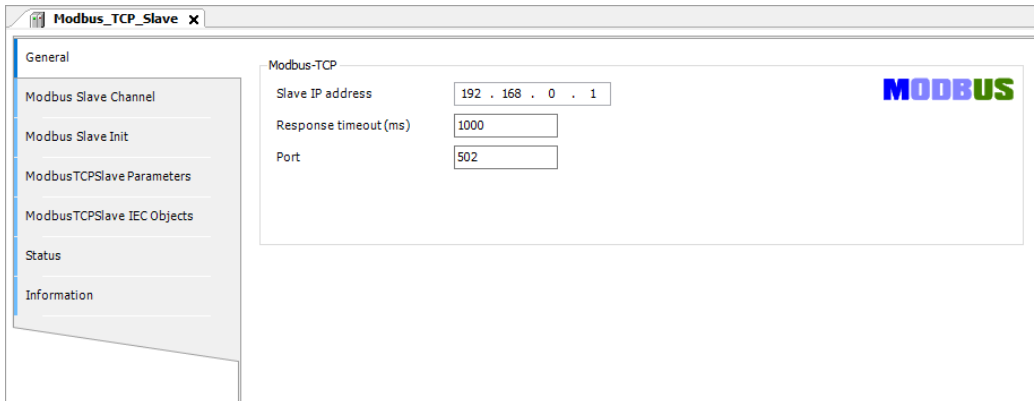

7. Select the "Modbus Slave Channel" tab.

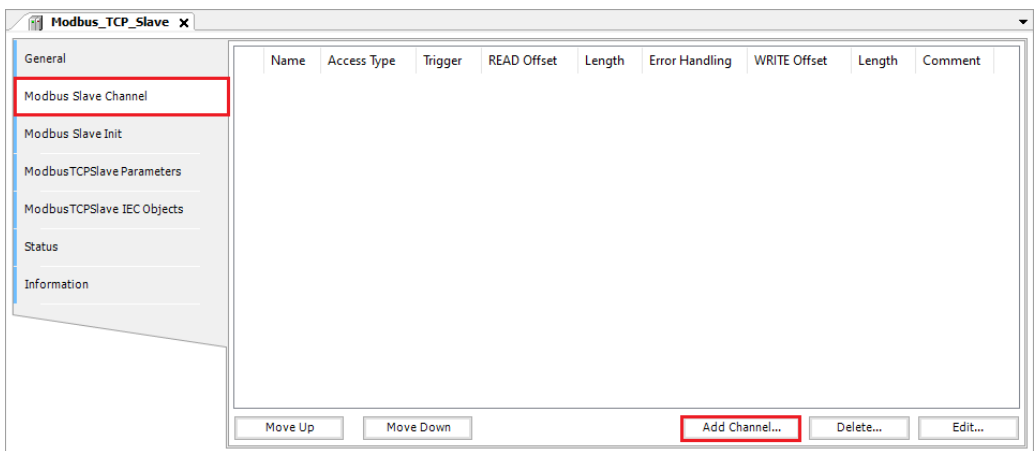

8. Click the [Add Channel] button.
The "Modbus Channel" dialog box will be displayed.
Enter information for channels to be used. Up to 100 channels can be set.

13.3 MODBUS

The screenshot shows the 'ModbusChannel' configuration window. It is divided into three main sections: 'Channel', 'READ Register', and 'WRITE Register'.
 - **Channel section:** Name is 'Channel 0', Access type is 'Read Holding Registers (Function Code 3)', Trigger is 'Cyclic', Cycle time (ms) is '100', and there is an empty Comment field.
 - **READ Register section:** Offset is '0x0000', Length is '1', and Error handling is 'Keep last Value'.
 - **WRITE Register section:** Offset is '0x0000' and Length is '1'.
 At the bottom right, there are 'OK' and 'Cancel' buttons.

Access type:

Select an access type (function code) and change the value of the READ or WRITE register parameter according to the selected access type.

Function code	Access type	Description
1	Read Coils	Reads from coils
2	Read Discrete Inputs	Reads from discrete inputs
3	Read Holding Registers	Reads from holding registers
4	Read Input Registers	Reads from input registers
5	Write Single Coil	Writes to single coil
6	Write Single Register	Writes to single register
15	Write Multiple Coils	Writes to multiple coils
16	Write Multiple Registers	Writes to multiple registers
23	Read / Write Multiple Registers	Reads from or writes to multiple registers

Trigger:

Select conditions for command transmission.

Access type	Description
Cyclic	Commands are sent periodically. Enter a transmission interval in the Cycle time field.
Rising edge	Commands are sent at the rising edge of a Boolean trigger variable. The trigger variable area is defined in the I/O Mapping tab.
Application	Commands are sent using the ModbusChannel function block in a user program.

READ register settings

Item	Description
Offset	Specifies the starting address from which read operation is to be started.
Length	Specifies the number of registers to be read from. The value of the parameter depends on the function code.
Error handling	Defines data that identifies communication errors. <ul style="list-style-type: none">• "Keep last value": Holds the last value that is read• "Set to ZERO": Sets 0

WRITE register settings

Item	Description
Offset	Specifies the starting address from which write operation is to be started. For SP15, do not specify offset "65535".
Length	Specifies the number of registers to be written to. The value of the parameter depends on the function code.

This completes the device object settings for the method for sending commands based on slave initialization and the method for sending commands based on channel settings.

13.3.3 Modbus-TCP Slave Communication

This section explains how to use the Modbus-TCP slave function. The slave function is used by setting up the device object.

1 2 Procedure

1. Right-click the "LANPort1" object in the navigator pane and then select Add Device from the context-sensitive menu that is displayed. The "Add Device" dialog box will be displayed.

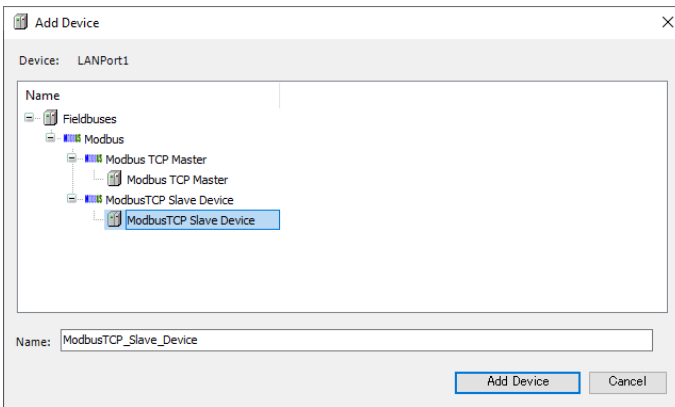

2. Select "ModbusTCP Slave Device" under "ModbusTCP Slave Device" and click the [Add Device] button. The "ModbusTCP_Slave_Device" object will be added to the "LANPort1" object.



3. Double-click "ModbusTCP_Slave_Device" in the navigator pane. The "LANPort1" object will be displayed. Select the "General" tab and set appropriate values for each item.

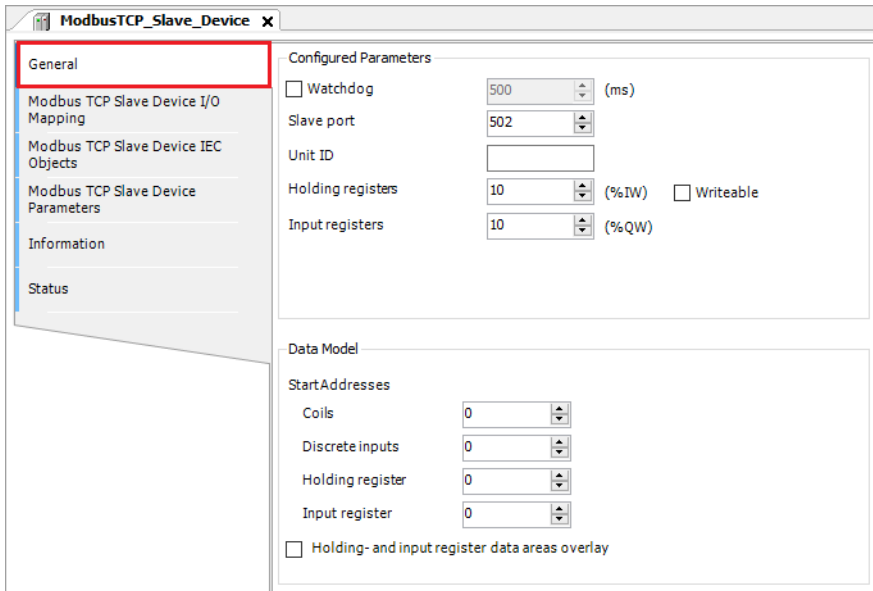

Item	Description
Watchdog	If no valid command is received from the master during the preset time period, the holding register (%IW) will be set to zero. Settable value: 500 to 200000
Slave port	Port number used by the slave (local unit) Settable value: 1 to 65535
Unit ID	A station number is set. Settable value: 1 to 247
Holding registers (%IW)	The number of holding registers is set. Buffer size of holding register: 1 to 4096
Input registers (%QW)	The number of input registers is set. Buffer size of input register: 1 to 4096

4. Select the "Modbus TCP Slave Device I/O Mapping" tab. You can allocate variables to holding registers and input registers.

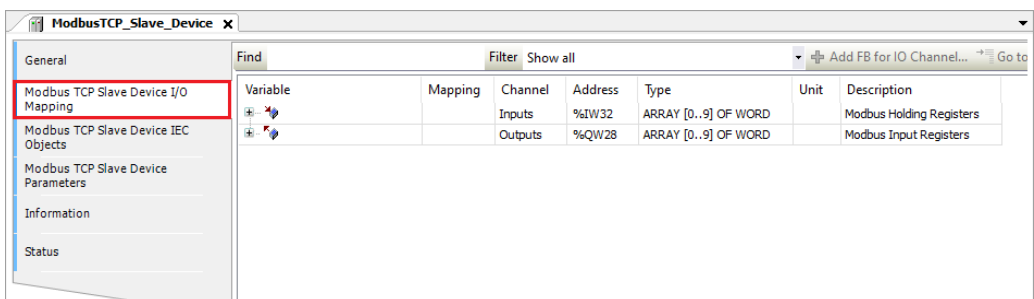

13.3 MODBUS

Registers correspond to each access type (function code)

Function code	Access type	Register	
		When the check box is not selected ^(Note 1)	When the check box is selected ^(Note 1)
1	Read Coils	Holding register	Input register
2	Read Discrete Inputs	Input register	Input register
3	Read Holding Registers	Holding register	Input register
4	Read Input Registers	Input register	Input register
5	Write Single Coil	Holding register	Holding register
6	Write Single Register	Holding register	Holding register
15	Write Multiple Coils	Holding register	Holding register
16	Write Multiple Registers	Holding register	Holding register
23	Read / Write Multiple Registers	Holding register (Read/Write)	Input register (Read) Holding register (Write)

(Note 1) The register to be used is changed according to whether the "Holding register data area overlay and input register data area overlay" check box is selected.

13.3.4 Modbus-RTU Master Communication

The Modbus-RTU master function can be used to send commands to slave devices in the following two ways.

- 1) When device object channel settings are used
 - Transmission method based on slave initialization
 - Transmission method based on channel settings
 - Cyclic
 - Rising edge
 - Application (ModbusChannel function block)
 - 2) When device object channel settings are not used (Note 1)
 - A method by which a user program (ModbusRequest function block) generates and sends commands
- (Note 1) Device object registration is required.

The method in 1) is explained below.

1 2 Procedure

1. Right-click the "Device" object in the navigator pane and then select Add Device from the context-sensitive menu that is displayed.

The "Add Device" dialog box will be displayed.

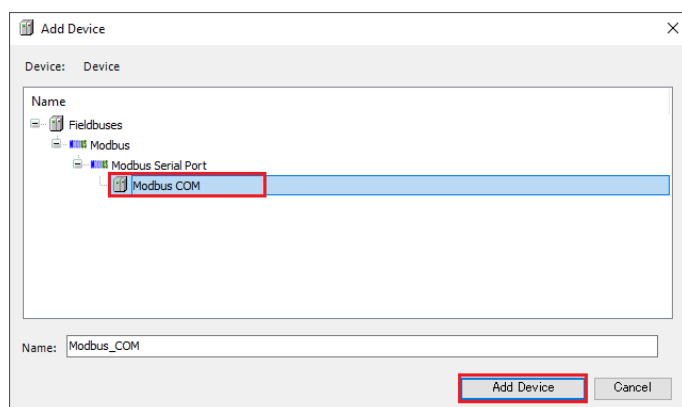

2. Select "Modbus COM" under "Modbus Serial Port" and click the [Add Device] button. The "Modbus_COM" object will be added to the "Device" object.

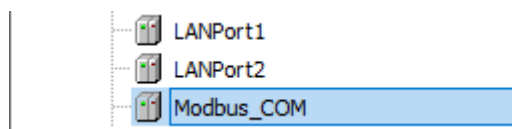

3. Right-click the "Modbus_COM" object in the navigator pane and then select Add Device from the context-sensitive menu that is displayed. The "Add Device" dialog box will be displayed.

13.3 MODBUS

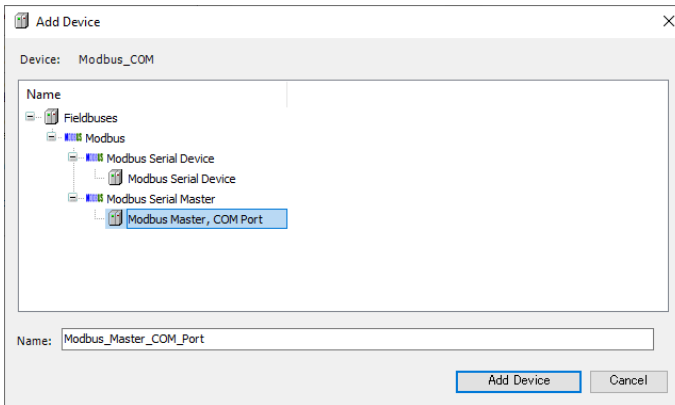

4. Select "Modbus Master, COM Port" under "Modbus Serial Master" and click the [Add Device] button.
The "Modbus_Master_COM_Port" object will be added below the "Modbus_COM" object.

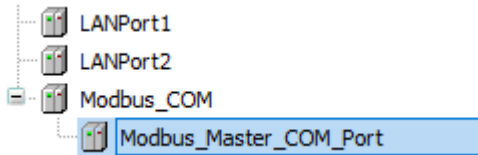

5. Right-click the "Modbus_Master_COM_Port" object in the navigator pane and then select Add Device from the context-sensitive menu that is displayed.
The "Add Device" dialog box will be displayed.

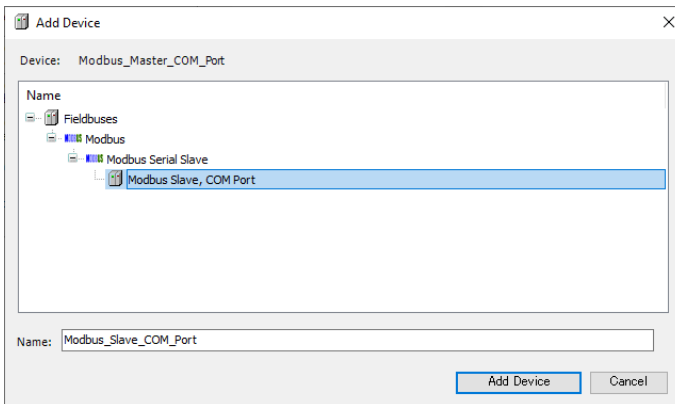

6. Select "Modbus Slave, COM Port" under "Modbus Serial Slave" and click the [Add Device] button.
The "Modbus_Slave_COM_Port" object will be added below the "Modbus_Master_COM_Port" object.

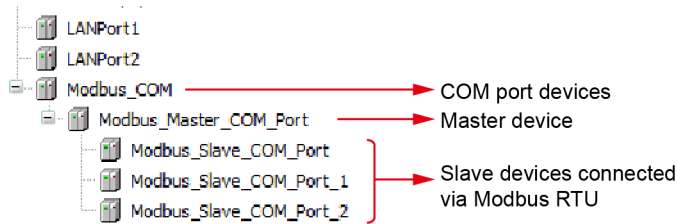

- Double-click "Modbus_COM" in the navigator pane. "Modbus_COM" object will be displayed. Select the "General" tab and set appropriate values for each item.

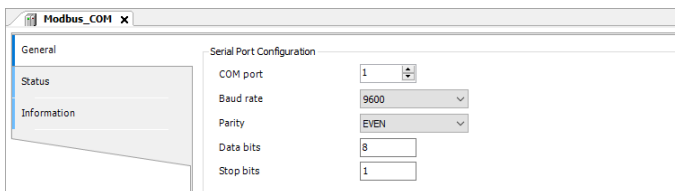

Item	Description
COM port	Settable value: 1 to 99 The COM port of the GM1 controller is fixed at 1.
Baud rate	Can be selected from 9600, 19200, 38400, 57600, and 115200
Parity	Can be selected from EVEN, ODD, and NONE
Data bits	Data bit length between start bit and stop bit Settable value: 7 bits and 8 bits (Settable: 0 to 255) The default value of Modbus is 8 bits.
Stop bit	Settable value: 1 bit and 2 bits The default value of Modbus is 1 bit.

- Double-click "Modbus Master, COM Port" in the navigator pane. The "Modbus_Master_COM_Port" object will be displayed. Select the "General" tab and set appropriate values for each item.

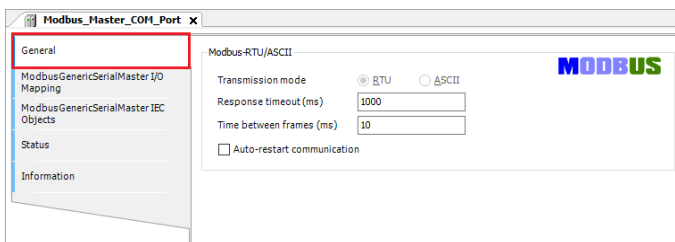

Item	Description
Transmission mode	RTU: Binary transmission ASCII: ASCII code transmission (Not supported)
Response timeout [ms] [0..65535]	Waiting time for response from slave * If a response timeout period is set in the slave device, the settings in the slave device will take effect.

13.3 MODBUS

Item	Description
Time between frames [ms] [0..65535]	Time period during which master transmission is paused from when the last response is received until the next command is sent.
Auto-restart communication	When the check box is selected: After a communication error occurs, the communication status is automatically checked. When the communication is restored, reconnection is performed. When the check box is not selected: After a communication error occurs, reconnection is not performed.

"ModbusGenericSerialMaster I/O Mapping" tab: Select a bus cycle task that performs Modbus communication.

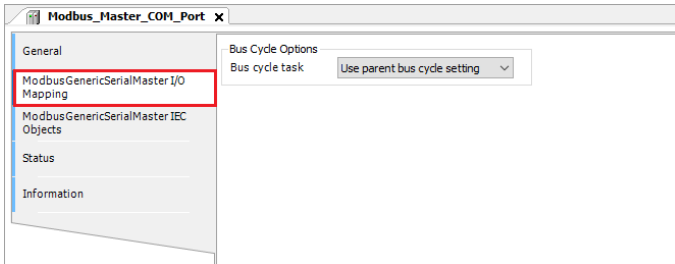

- Double-click "Modbus Slave, COM Port" in the navigator pane. The "Modbus_Slave_COM_Port" object will be displayed. Select the "General" tab and set appropriate values for each item.

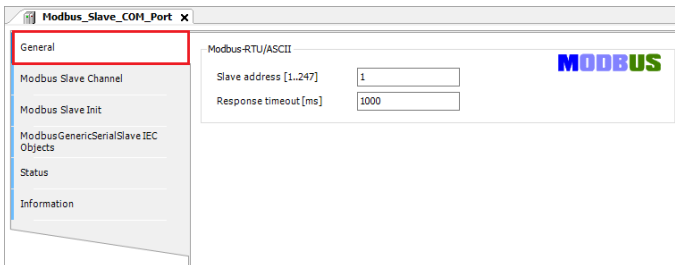

Item	Description
Slave address [1..247]	Specifies the address (station number) of the slave device.
Response timeout (ms) [2..65535]	Waiting time for response from slave * The response timeout value for the master device is overwritten.

- Select the "Modbus Slave Channel" tab.

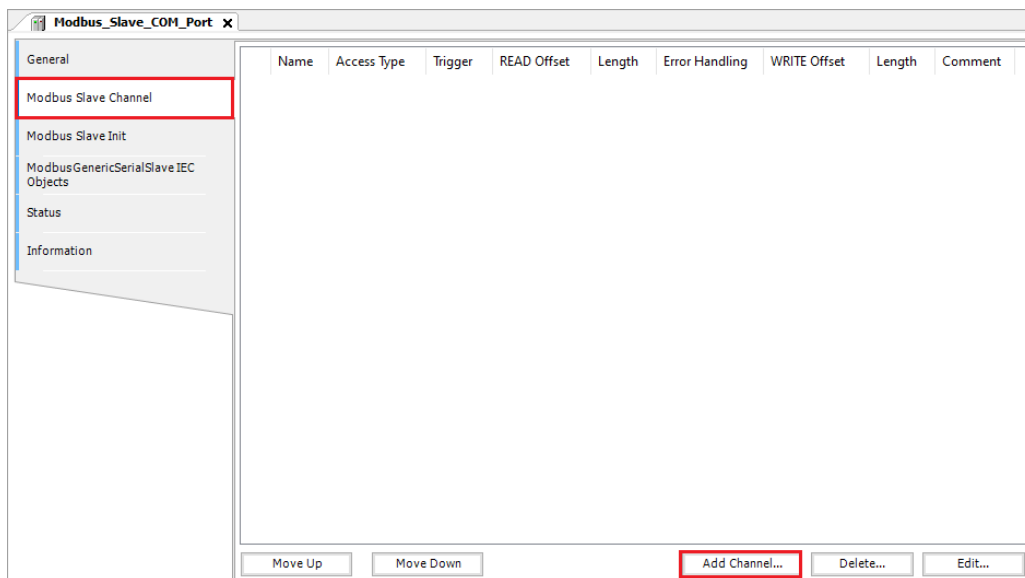

11. Click the [Add Channel] button.

The "Modbus Channel" dialog box will be displayed.

Enter information for channels to be used. Up to 100 channels can be set.

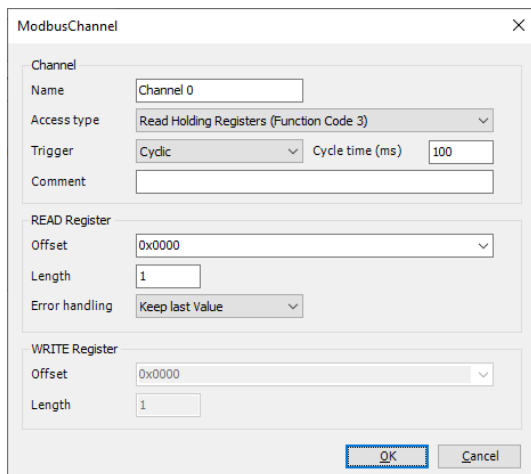

Access type :

Select an access type (function code) and change the value of the READ or WRITE register parameter according to the selected access type.

Function code	Access type	Description
1	Read Coils	Reads from coils
2	Read Discrete Inputs	Reads from discrete inputs
3	Read Holding Registers	Reads from holding registers
4	Read Input Registers	Reads from input registers
5	Write Single Coil	Writes to single coil

13.3 MODBUS

Function code	Access type	Description
6	Write Single Register	Writes to single register
15	Write Multiple Coils	Writes to multiple coils
16	Write Multiple Registers	Writes to multiple registers
23	Read/Write Multiple Registers	Reads from or writes to multiple registers

Trigger :

Select conditions for command transmission.

Access type	Description
Cyclic	Commands are sent periodically. Enter a transmission interval in the Cycle time field.
Rising edge	Commands are sent at the rising edge of a Boolean trigger variable. The trigger variable area is defined in the I/O Mapping tab.
Application	Commands are sent using the ModbusChannel function block in a user program.

READ register settings

Item	Description
Offset	Specifies the starting address from which read operation is to be started. For SP15, do not specify offset "65535".
Length	Specifies the number of registers to be read from. The value of the parameter depends on the function code.
Error handling	Defines data that identifies communication errors. <ul style="list-style-type: none">• "Keep last value": Holds the last value that is read• "Set to ZERO": Sets 0

WRITE register settings

Item	Description
Offset	Specifies the starting address from which write operation is to be started.
Length	Specifies the number of registers to be written to. The value of the parameter depends on the function code.

12. Select the "Initialize Modbus Slave" tab.

Slave devices can be initialized.

Slave initialization is executed once when a slave is activated at the time of startup or RUN mode. Click the [New] button and enter information for channels to be used. Up to 20 commands can be added for each device.

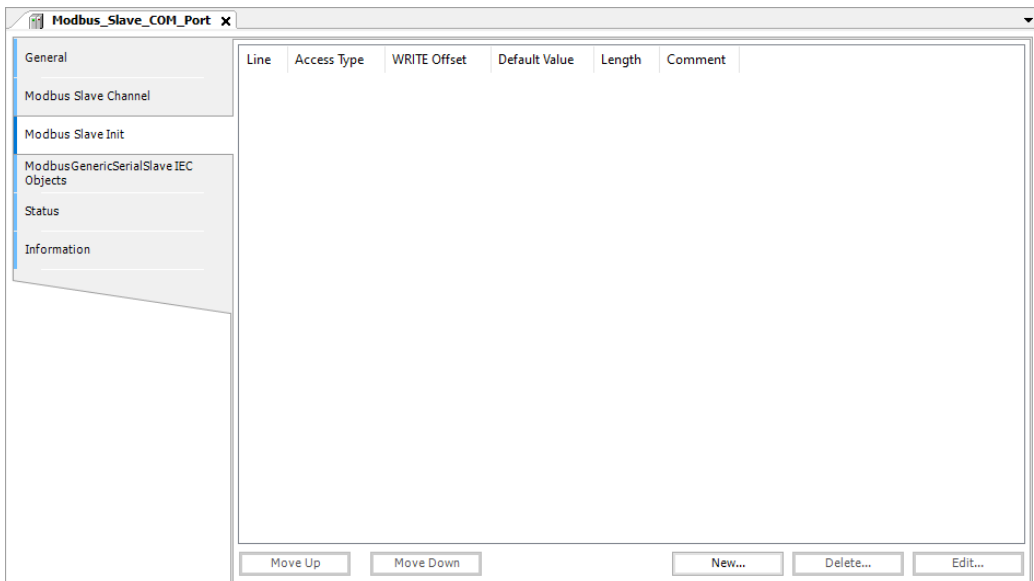

List of access types (function codes)

Code	Access type	Description
5	Write Single Coil	Writes to single coil
6	Write Single Register	Writes to single register
15	Write Multiple Coils	Writes to multiple coils
16	Write Multiple Registers	Writes to multiple registers

13. Select the "ModbusGenericSerialSlave I/O Mapping" tab.

Read areas, write areas, and trigger variable areas are defined according to the channel information created in Step 10. Allocate variables as necessary.

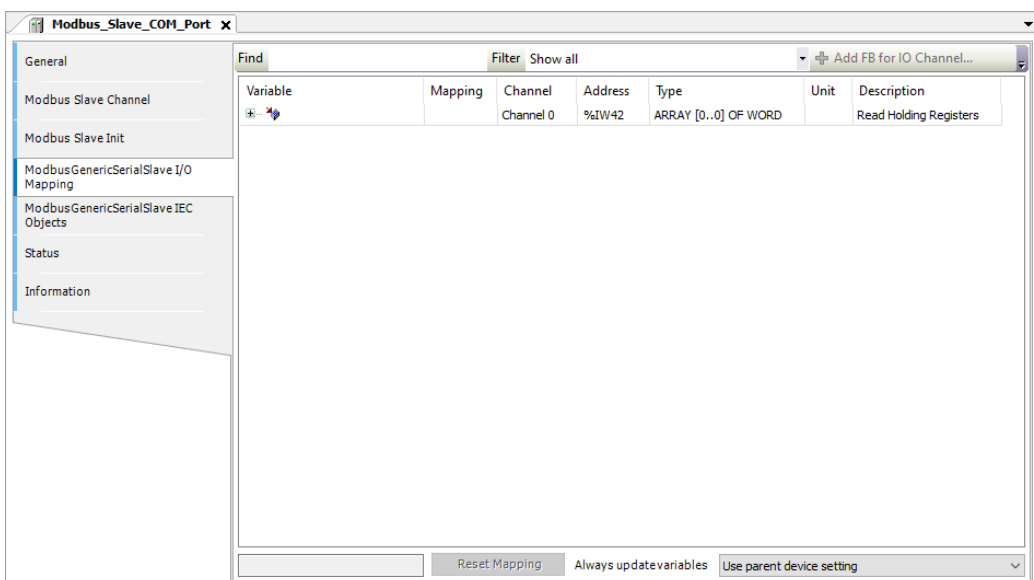

13.3 MODBUS

Update settings for I/O variables

Reset Mapping Always update variables Use parent device setting

= Create new variable = Map to existing variable

Item	Description
Use parent device settings	Updates I/O variables according to the parent device settings
Enable 1 (Bus cycle task if not used by any tasks)	Updates I/O variables in the bus cycle if not used by any other task
Enable 2 (Always use bus cycle task)	Updates all I/O variables in each cycle of the bus cycle task

This completes the device object settings for the method for sending commands based on slave initialization and the method for sending commands based on channel settings.

The following is an example of creating an LD program that sends commands when a trigger is set as an "application" in channel settings.

The ModbusChannel function block is used for command transmission. The slave device added to the navigator pane is specified in the slave operand, and the index of the channel that has been added to the "Modbus Slave Channel" tab and that is used to send commands is specified in the iChannelIndex command.

Modbus_Slave_COM_Port x

Name	Access Type	Trigger	READ Offset	Length	Error Handling	WRITE Offset
0 Channel 0	Read Holding Registers (Function Code 03)	Rising edge	16#0000	1	Keep last Value	
1 Channel 1	Write Single Register (Function Code 06)	Application				16#0000
2 Channel 2	Read/Write Multiple Registers (Function Code 23)	Cyclic, t#100ms	16#0000	1	Keep last Value	16#0000

Slave device name (points to Modbus_Slave_COM_Port)
Channel index (points to 1)

LD Program: ModbusChannel_0 block with inputs: sSlave, xExecute, xAbort, iChannelIndex.

13.3.5 Modbus-RTU Slave Communication

This section explains how to use the Modbus-RTU slave function. The slave function is used by setting up the device object.

1 2 Procedure

1. Right-click the "Device" object in the navigator pane and then select Add Device from the context-sensitive menu that is displayed. The "Add Device" dialog box will be displayed.

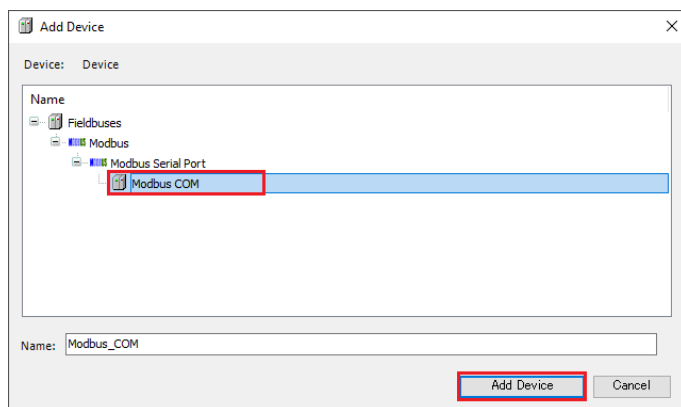

2. Select "Modbus COM" under "Modbus Serial Port" and click the [Add Device] button. The "Modbus_COM" object will be added to the "Device" object.

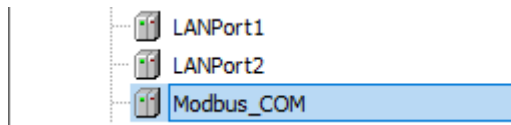

3. Right-click the "Modbus_COM" object in the navigator pane and then select Add Device from the context-sensitive menu that is displayed. The "Add Device" dialog box will be displayed.

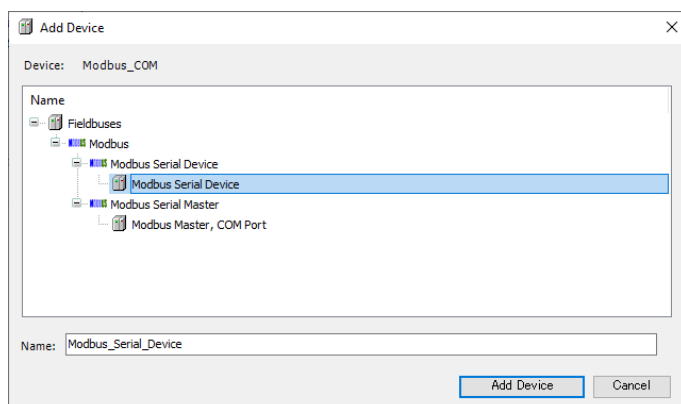

13.3 MODBUS

4. Select "Modbus Serial Device" under "Modbus Serial Device" and click the [Add Device] button.

The "Modbus_Serial_Device" object will be added below the "Modbus COM" object.

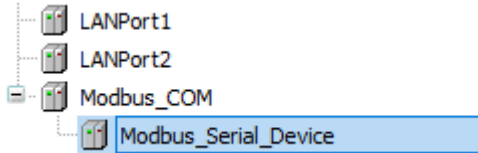

5. Double-click "Modbus_COM" in the navigator pane.

The "Modbus_COM" object will be displayed.

Select the "General" tab and set appropriate values for each item.

Item	Description
COM port	Settable value: 1 to 99 The COM port of the GM1 controller is fixed at 1.
Baud rate	Can be selected from 9600, 19200, 38400, 57600, and 115200
Parity	Can be selected from EVEN, ODD, and NONE
Data bits	Data bit length between start bit and stop bit Settable value: 7 bits and 8 bits (Settable: 0 to 255) The default value of Modbus is 8 bits.
Stop bit	Settable value: 1 bit and 2 bits The default value of Modbus is 1 bit.

6. Double-click "Modbus_Serial_Device" in the navigator pane.

The "Modbus_Serial_Device" object will be displayed.

Select the "General" tab and set appropriate values for each item.

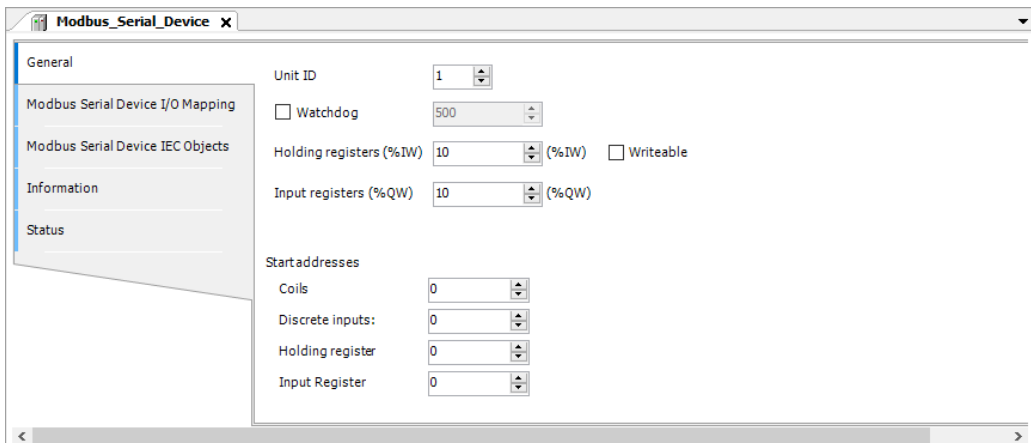

Item	Description
Watchdog	If no valid command is received from the master during the preset time period, the holding register (%IW) will be set to zero. Settable value: 500 to 200000
Unit ID	A station number is set. Settable value: 1 to 247
Holding registers (%IW)	The number of holding registers is set. Buffer size of holding register: 1 to 500
Input registers (%QW)	The number of input registers is set. Buffer size of input register: 1 to 500

7. Select the "Modbus Serial Device I/O Mapping" tab.
You can allocate variables to holding registers and input registers.

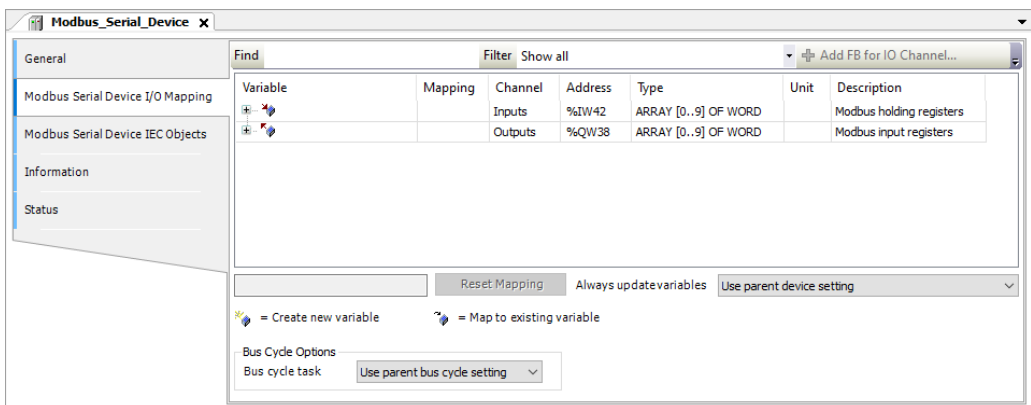

Registers correspond to each access type (function code)

Function code	Access type	Description
1	Read Coils	Holding register
2	Read Discrete Inputs	Input register
3	Read Holding Registers	Holding register

13.3 MODBUS

Function code	Access type	Description
4	Read Input Registers	Input register
5	Write Single Coil	Holding register
6	Write Single Register	Holding register
15	Write Multiple Coils	Holding register
16	Write Multiple Registers	Holding register
23	Read/Write Multiple Registers	Holding register (Read/Write)

13.4 EtherNet/IP

13.4.1 What is EtherNet/IP?

EtherNet/IP (Ethernet Industrial Protocol) is an industrial multi-vendor real-time Ethernet system that executes a communication protocol for controlling the Common Industrial Protocol (CIP) in the application layer implemented over standard Ethernet.

For details on CIP, refer to ODVA documentation.

13.4.2 Cyclic Communication Function

After the scanner device connects to an adapter device and a connection is established, the cyclic communication function allows them to send data mutually at the requested packet interval (RPI).

- Scanner device: Controllers such as PLC
- Adapter device: Robot controllers, encoders, I/O devices, etc.

The EtherNet/IP function of the GM1 controller consists of the scanner function and adapter function.

Supplementary note: About GM1 controllers used as adapter devices

- Adapter devices are classified into the following two types: Adapter devices connected under the control of the GM1 controller used as a scanner device and adapter devices that are the GM1 controller itself. To avoid confusion, the following two different terms are used in this manual.
 - Local adapter
Adapter device that is the GM1 controller itself
 - Remote adapter
Adapter device connected to the GM1 controller used as a scanner

13.4.3 EtherNet/IP Scanner Function

The EtherNet/IP scanner function allows the GM1 controller to communicate with EtherNet/IP adapter devices.

Communication settings for an adapter device to be connected can be configured by loading the EDS file of the adapter device. Multiple adapter devices can be connected to a scanner device.

13.4.4 Setting up the EtherNet/IP Scanner Function

This section explains how to set up the EtherNet/IP scanner function.

Adding devices

Add an EtherNet/IP scanner device and remote adapter device to the Device tree, as described below.

1 2 Procedure

1. Add an EtherNet/IP scanner device.

1-1 Right-click the "LANPort2" object in the navigator pane and then select "Add Device" from the context-sensitive menu that is displayed.

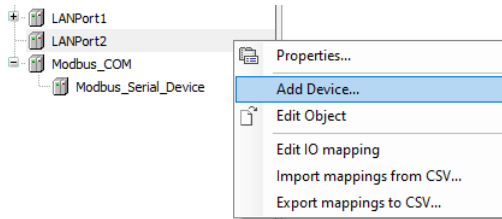

The "Add Device" dialog box will be displayed.

1-2 Select "EtherNet_IP_Scanner" and click the [Add Device] button.

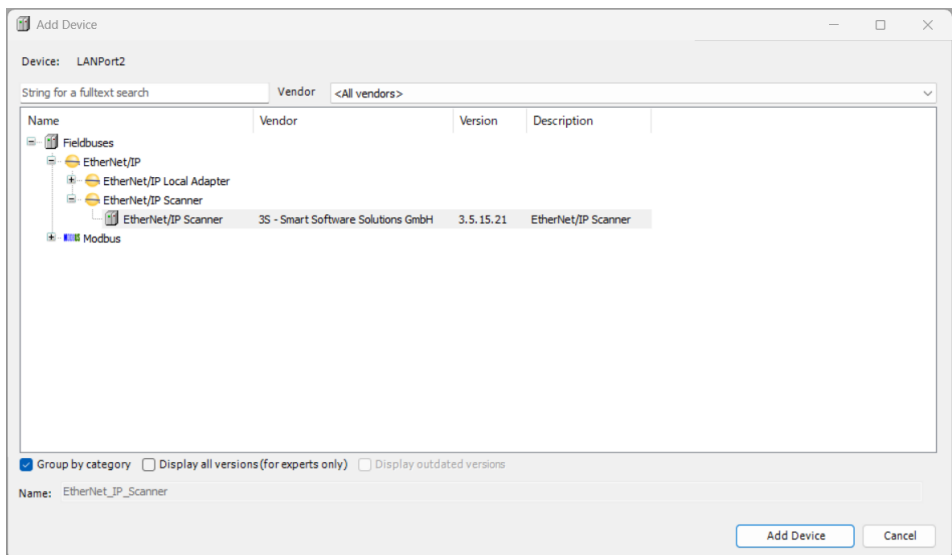
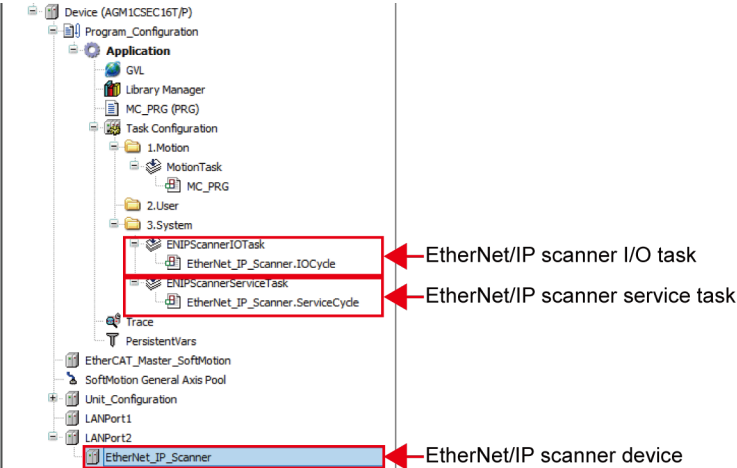

Image of added device and tasks

After an EtherNet/IP scanner device has been added, a device and tasks are added to the Device tree, as shown below.



2. Add a remote adapter device.

2-1 Right-click the "EtherNet/IP scanner device" object added in "Step 1" and select "Add Device" from the context-sensitive menu that is displayed.

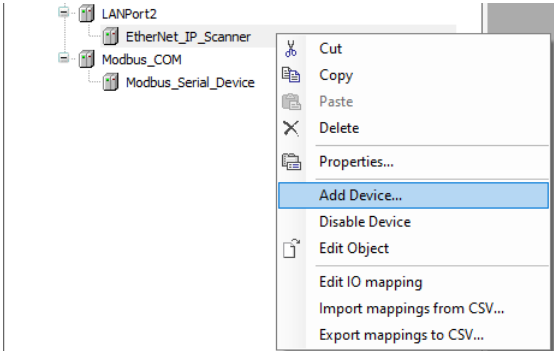

The "Add Device" dialog box will be displayed.

2-2 Select a remote adapter device to be added and click the [Add Device] button.

13.4 EtherNet/IP

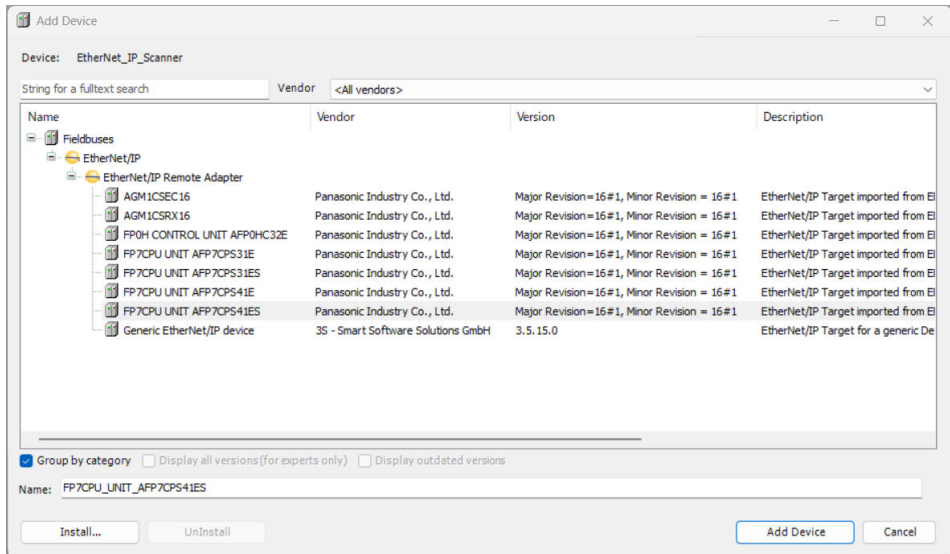

A new remote adapter device can also be added by selecting an EDS file. Click the [Install Device] button and select a desired EDS file.

Device tree after devices are added

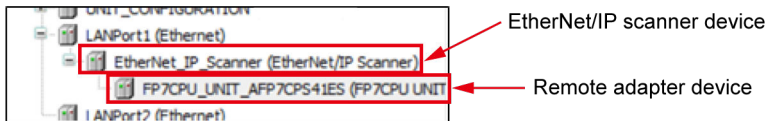

Setting up an EtherNet/IP scanner device

Set up an EtherNet/IP scanner device as below.

1.2 Procedure

1. Double-click "EtherNet_IP_Scanner" in the navigator pane.
2. In the "General" tab, select the "Auto-reestablish connections" check box.
When the check box is not selected: The device is stopped in the event of a communication error.
When the check box is selected: The device is reconnected automatically in the event of a communication error.

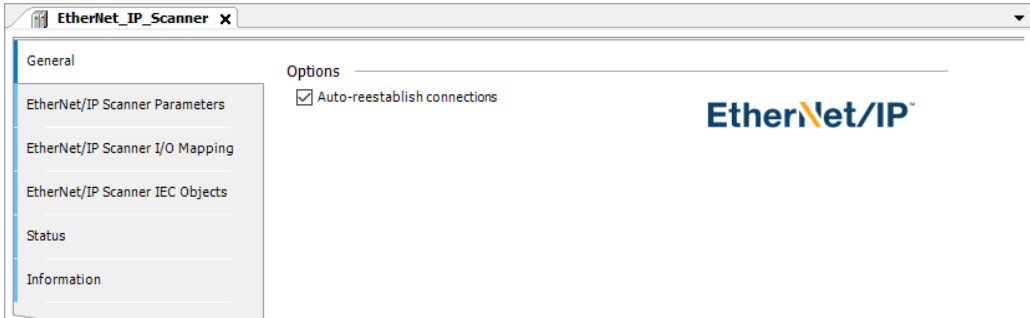

Setting up a remote adapter device

Set up a remote adapter device, as below.

Setting items for remote adapter devices differ according to the EDS file. The following procedure is explained, using Panasonic "AFP7CPS31E" as an example.

1 2 Procedure

1. Double-click "FP7CPU_UNIT_AFP7CPS31E" in the navigator pane.
2. In the "General" tab, set an IP address and items to be checked at the time of connection.

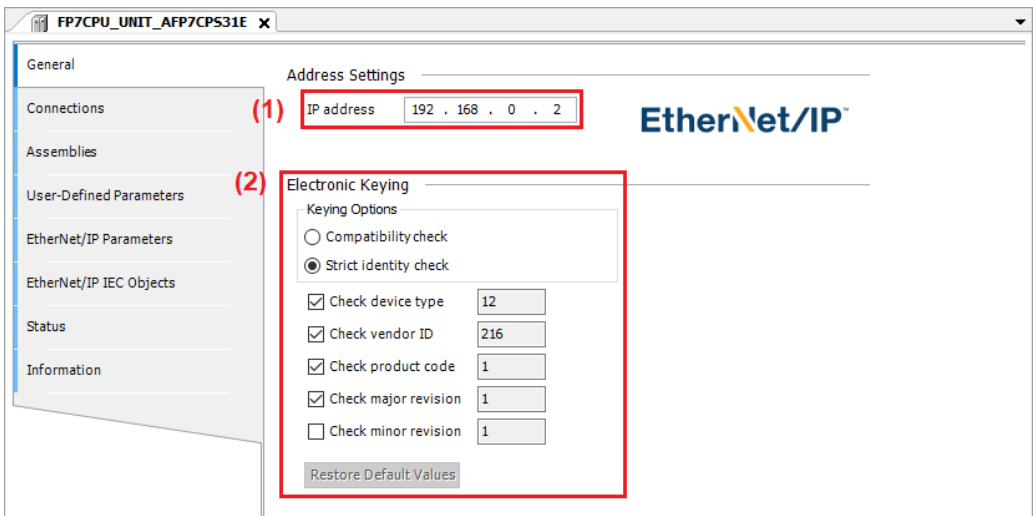

- (1) IP address
Set the IP address of the adapter device.
- (2) Electronic Keying
Select items to be checked at the time of connection.
 - Compatibility check
The adapter device executes its own compatibility check.
In this case, the user can select only the "Check device type" check box.
 - Strict identity check
The user specifies check items individually.
Normally, it is OK to use the default values.

3. Set a connection point.

3-1 In the "Connection" tab, click the [Add Connection] button.

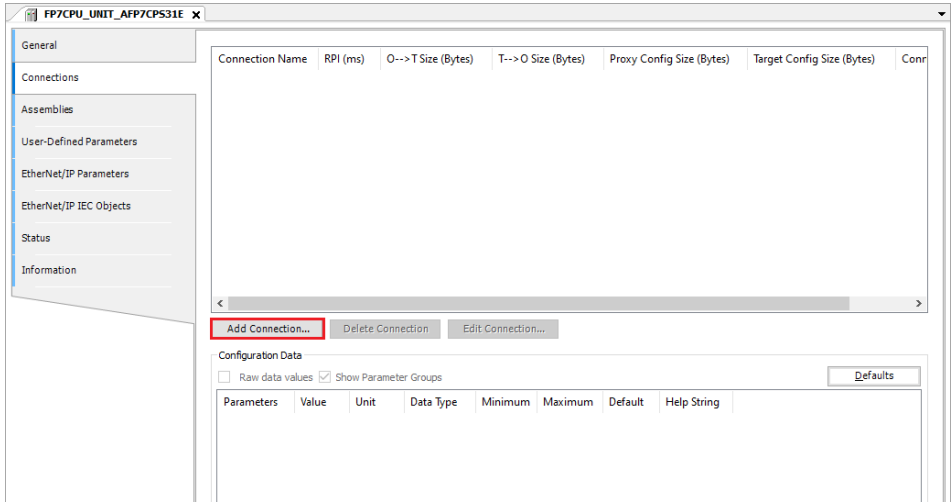

The "New Connection" window will be displayed.

3-2 Set up parameters required for connection.

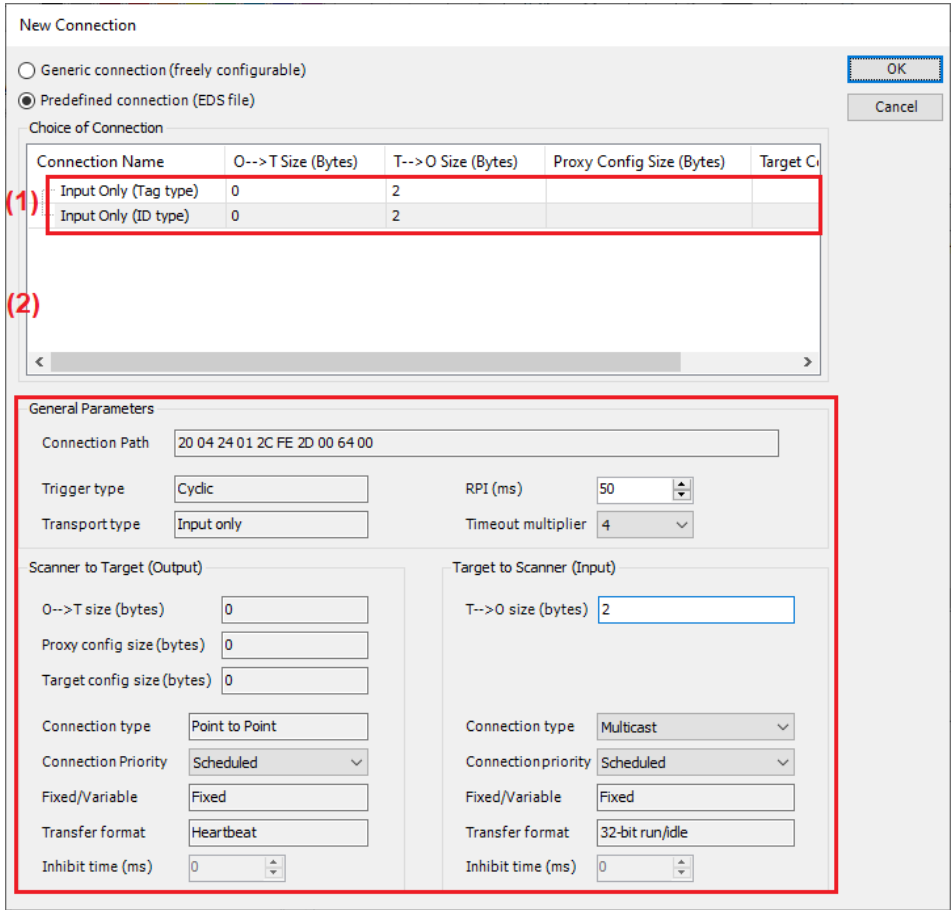

- (1) This section displays the connection points that are supported by the adapter device according to the EDS file.
Select a connection point to be used.
Example: Select "Input Only (ID type)".
- (2) The parameters in the "General parameters" section differ according to the selected connection point.
Example: Set "RPI" to 10 (ms) and "T→O size" to 16 (bytes).

Info.

- For tag connection, uppercase English letters cannot be used for tag names.

4. In the "Assemblies" tab, set up a data configuration.

If "T→O size" in the "General parameters" section is set to 16 bytes, the default data configuration will be as shown below.

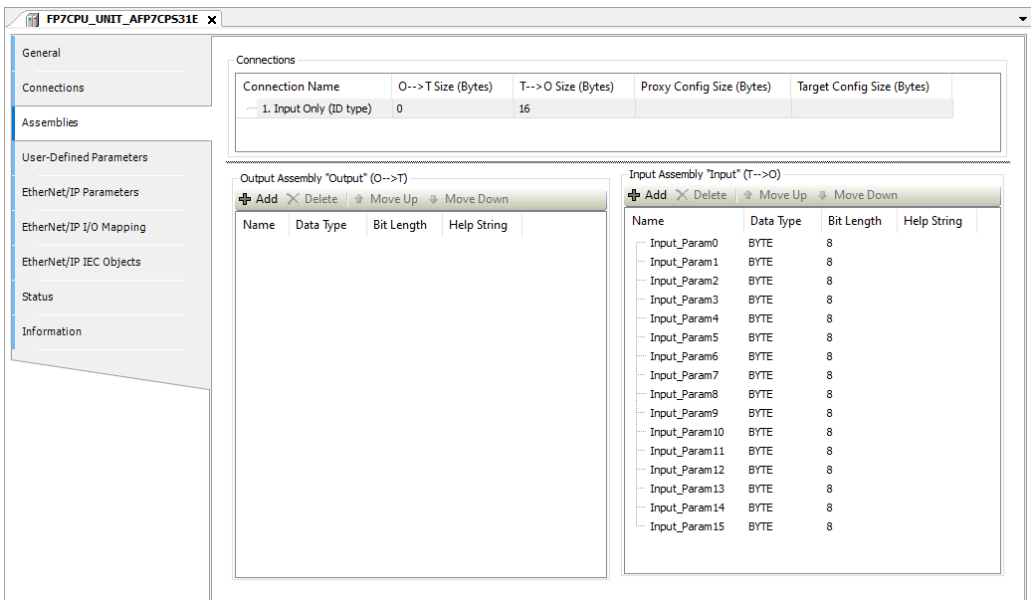

The screenshot shows the 'FP7CPU_UNIT_AFP7CPS31E' window with the 'Assemblies' tab selected. The 'Connections' table is as follows:

Connection Name	O-->T Size (Bytes)	T-->O Size (Bytes)	Proxy Config Size (Bytes)	Target Config Size (Bytes)
1. Input Only (ID type)	0	16		

Below the connections table, two assembly configuration tables are visible:

Output Assembly "Output" (O-->T)

Name	Data Type	Bit Length	Help String

Input Assembly "Input" (T-->O)

Name	Data Type	Bit Length	Help String
Input_Param0	BYTE	8	
Input_Param1	BYTE	8	
Input_Param2	BYTE	8	
Input_Param3	BYTE	8	
Input_Param4	BYTE	8	
Input_Param5	BYTE	8	
Input_Param6	BYTE	8	
Input_Param7	BYTE	8	
Input_Param8	BYTE	8	
Input_Param9	BYTE	8	
Input_Param10	BYTE	8	
Input_Param11	BYTE	8	
Input_Param12	BYTE	8	
Input_Param13	BYTE	8	
Input_Param14	BYTE	8	
Input_Param15	BYTE	8	

To change the data structure, click a relevant data type and select a desired data type.

In the following example, the BYTE type (16-byte data structure) is changed to the WORD type (4-word data structure) and the DWORD type (2-word data structure).

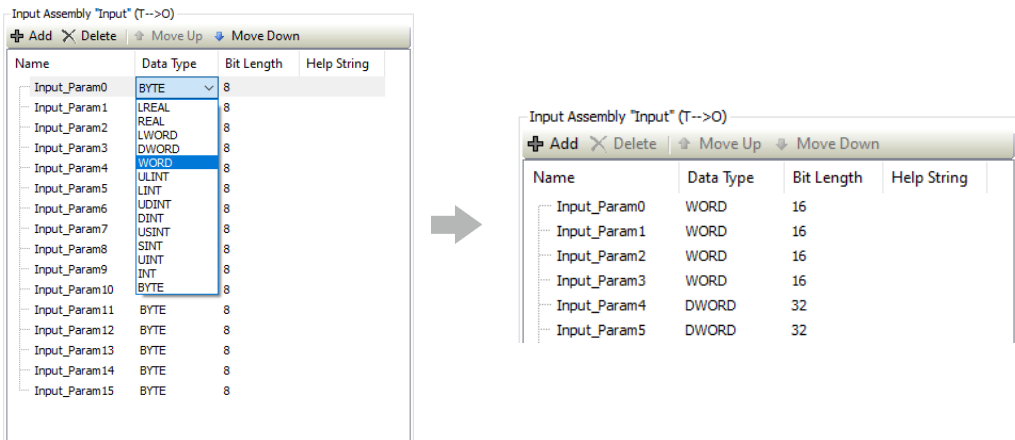

5. In the "EtherNet/IP I/O Mapping" tab, map data to variables in the application POU, as below.

- 5-1 In the POU, create variables to which data is to be mapped.

```

FP7CPU_UNIT_AFF7CPS4IES PLC_PRG x
PROGRAM PLC_PRG
1
2
3
4 VAR
5   wToData : ARRAY [1..4] OF WORD;
6   dwToData : ARRAY [1..2] OF DWORD;
7
8 END_VAR

```

- 5-2 Map I/O data to each variable that has been created.

Variable	Mapping	Channel	Address	Type	Unit	Description
Application.PLC_RPG.wToData[1]		Input_Param0	%IW32	WORD		
Application.PLC_RPG.wToData[2]		Input_Param1	%IW33	WORD		
Application.PLC_RPG.wToData[3]		Input_Param2	%IW34	WORD		
Application.PLC_RPG.wToData[4]		Input_Param3	%IW35	WORD		
Application.PLC_RPG.dwToData[1]		Input_Param4	%ID48	DWORD		
Application.PLC_RPG.dwToData[2]		Input_Param5	%ID49	DWORD		
Input_Param6			%IB80	BYTE		
Input_Param7			%IB81	BYTE		

13.4.5 EtherNet/IP Scanner Operation

When a project in which EtherNet/IP scanner settings have been configured is downloaded to the GM1 controller and then an adapter is connected, cyclic communication is started, regardless of whether the GM1 controller is set to RUN or STOP mode.

When the GM1 controller is set to STOP mode, the remote adapter is placed in "Adapter in IDLE state" and displayed as Δ in the Device tree.

13.4 EtherNet/IP

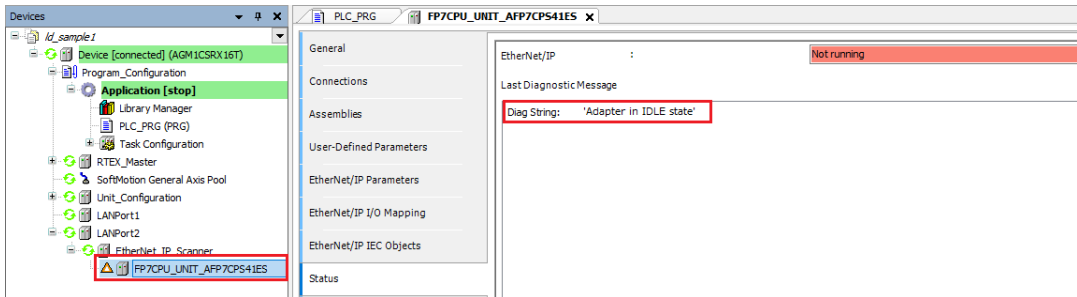

When the GM1 controller is set to RUN mode, the remote adapter is placed in "Adapter running" and displayed as O in the Device tree.

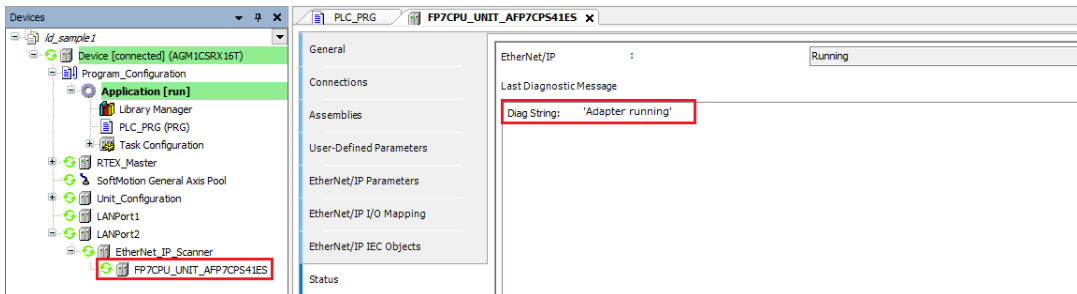

To perform a status check or reset using a program, use I/O of the remote adapter device. The following is an example of adapter operation using device I/O.

- Declaration section

```
PROGRAM PLC_PRG
VAR
    eState :
        IoDrvEtherNetIP.AdapterState; // Remote adapter status
    xDiagnosticAvailable : BOOL; // TRUE if there is diagnostic information
    sDiagString : STRING; // Diagnostic string
    xAcknowledge : BOOL := FALSE; // Approve diagnostic information
    xReset : BOOL := FALSE; // Remote adapter reset
END_VAR
```

- Implementation section

```
eState := FP7CPU_UNIT_AFP7CPS41ES.eState;
xDiagnosticAvailable := FP7CPU_UNIT_AFP7CPS41ES.xDiagnosticAvailable;
sDiagString := FP7CPU_UNIT_AFP7CPS41ES.sDiagString;
FP7CPU_UNIT_AFP7CPS41ES.xAcknowledge := xAcknowledge;
FP7CPU_UNIT_AFP7CPS41ES.xReset := xReset;
```

The current state of the remote adapter is stored in eState.

Exmpl	When line is connected	RUNNING
e	normally:	ENCAPSULATION_CONFIG
	When line is disconnected:	

If an error occurs, xDiagnosticAvailable will be set to TRUE and a message will be found in sDiagString.

If xAcknowledge is set to TRUE, xDiagnosticAvailable will return to FALSE.

If xReset is set to TRUE, the line will be closed temporarily and then reconnected.
(To reset all remote adapters simultaneously, use xReset of the EtherNet/IP scanner device.)

13.4 EtherNet/IP

13.4.6 EtherNet/IP Adapter Function

The EtherNet/IP adapter function allows the GM1 controller to communicate with EtherNet/IP scanner devices.

13.4.7 Setting up the EtherNet/IP Adapter Function

This section explains how to set up the EtherNet/IP adapter function.

Adding devices

Add a local adapter device and module device to the Device tree, as described below.

1 2 Procedure

1. Add a local adapter device.

A local adapter device serves as a connection point to which the scanner device connects.

1-1 Right-click the "LANPort2" object in the navigator pane and then select "Add Device" from the context-sensitive menu that is displayed.

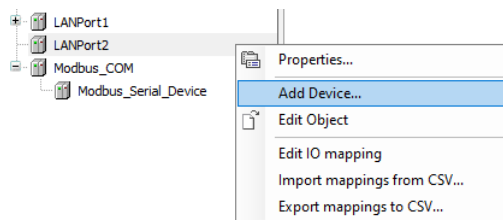

The "Add Device" dialog box will be displayed.

1-2 Select "EtherNet_IP_Adapter" and click the [Add Device] button.

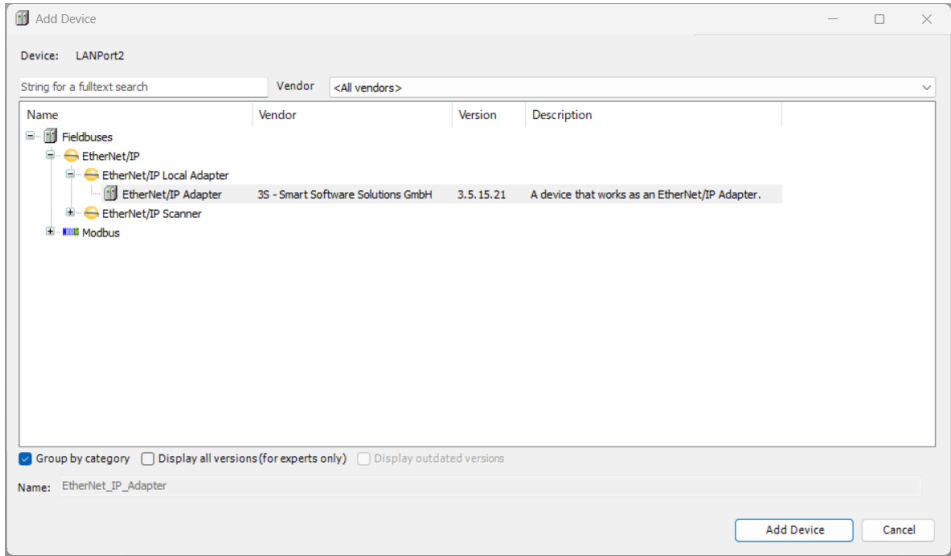
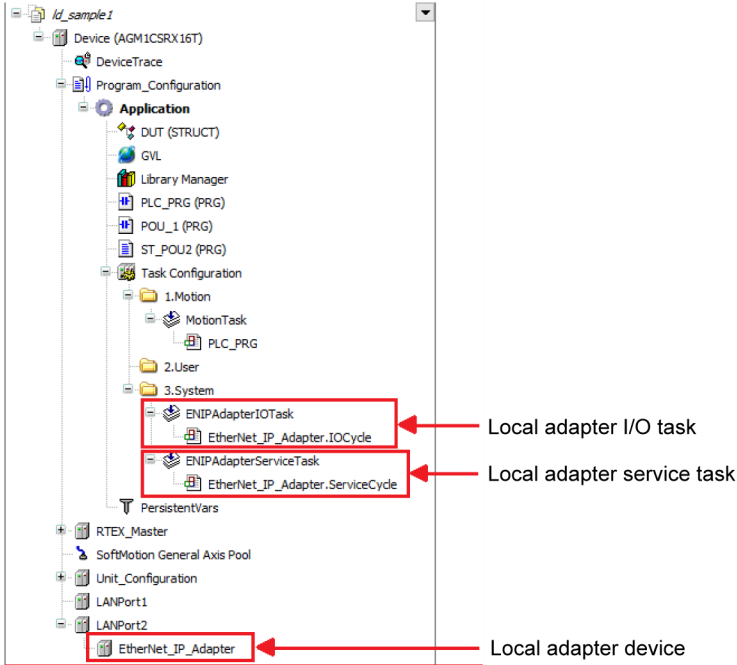

Image of added device and tasks

After a local adapter device has been added, a device and tasks are added to the Device tree, as shown below.



2. Add a module device.

A module device defines data to be transferred via cyclic communication.

- 2-1** Right-click the "Local adapter device" object added in "Step 1" and select "Add Device" from the context-sensitive menu that is displayed.

13.4 EtherNet/IP

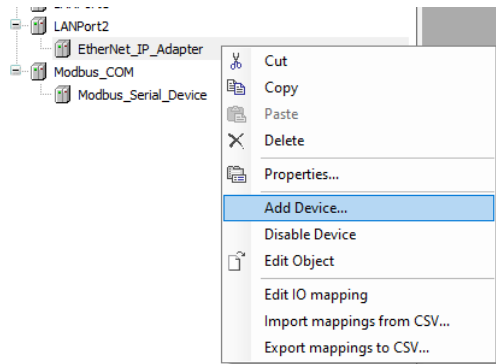

The "Add Device" dialog box will be displayed.

- 2-2** Select the "EtherNet/IP Module" object to be added and click the [Add Device] button.

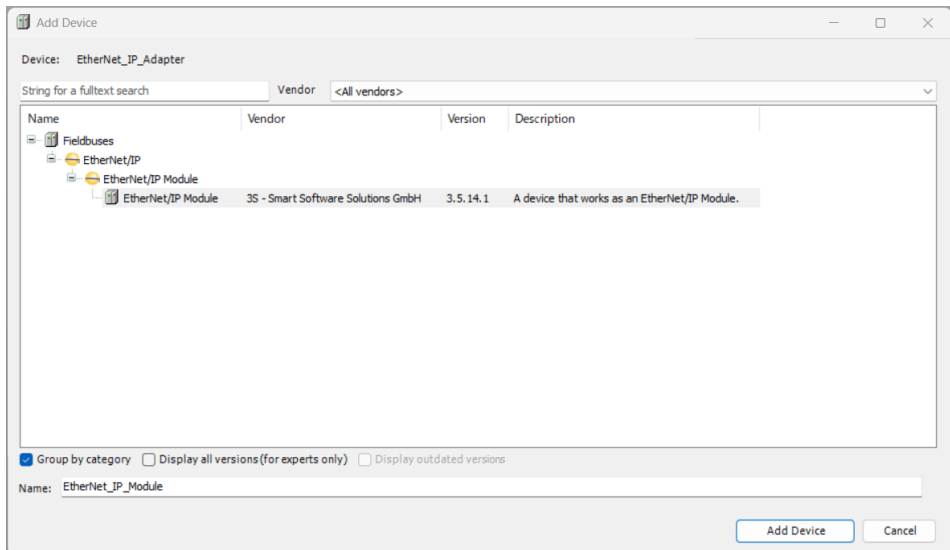
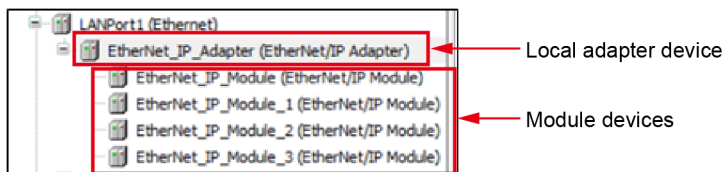

Image of added devices

Multiple module devices can be added within a local adapter device.

The following is an example of four module devices added to a local adapter device.



Settings of local adapter device

Check the settings of the local adapter device.

1 2 Procedure

1. Double-click "EtherNet_IP_Adapter" in the navigator pane.
2. In the "General" tab, check the settings of the local adapter device.

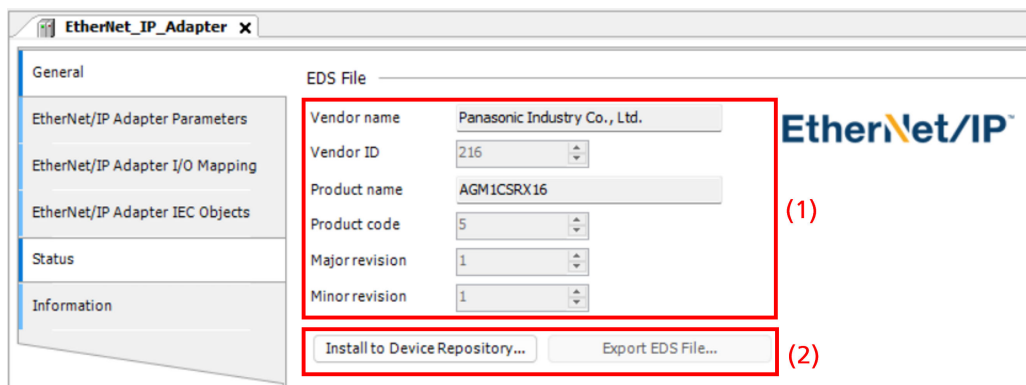

- (1) The settings of the local adapter device are shown below. However, the settings cannot be changed.
 - Vendor name: Panasonic Industry Co., Ltd.
 - Vendor ID: 216
 - Product name: AGM1CSRX16
 - Product code: 5
 - Major revision: 1
 - Minor revision: 1
- (2) For the following items, the settings cannot be changed.
 - Install to Device Repository
The remote adapter device specified here is registered as a device in CODESYS.
 - Export EDS File
The EDS file specified here is output.
For scanner device settings, use the EDS file provided by Panasonic ("panasonicgm1csrx16_0005_0101.eds").

Setting up a module device

Set up a module device, as below.

1 2 Procedure

1. Double-click "EtherNet_IP_Module" in the navigator pane.
2. In the "General" tab, set module information.

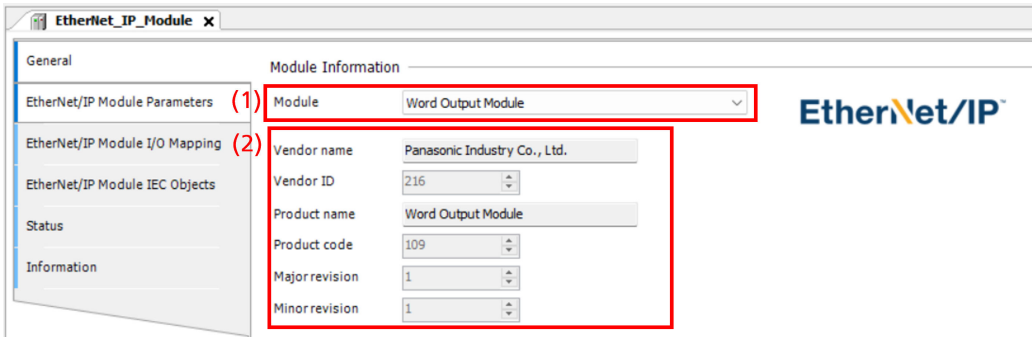

2-1 (1) Select a desired module type from the following 10 types.

Module type	Size	Direction
Byte Input	1 byte	O→T
Byte Output	1 byte	T→O
Word Input	1 word (2 bytes)	O→T
Word Output	1 word (2 bytes)	T→O
DWord Input	1 double-word (4 bytes)	O→T
DWord Output	1 double-word (4 bytes)	T→O
Real Input	1 single-precision real number (4 bytes)	O→T
Real Output	1 single-precision real number (4 bytes)	T→O
Big Input	505 bytes	O→T
Big Output	509 bytes	T→O

By generating multiple module devices and setting module types, data structure can be created within cyclic data.

Example) T→O data: 8 bytes, O→T data: 6 bytes

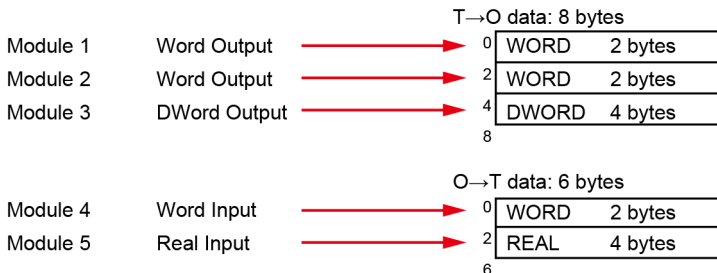

Note

- The maximum data length within a single connection point is as follows:
O→T data: 505 bytes
T→O data: 509 bytes

2-2 There is no need to set all items in (2), as values cannot be entered.

3. In the "EtherNet/IP Module I/O Mapping" tab, map data to variables in the application POU, as below.

3-1 In the POU, create variables to which data is to be mapped.

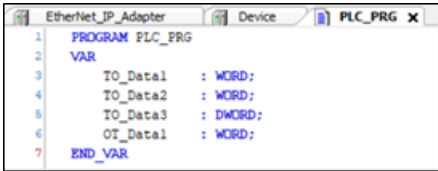

```
1 PROGRAM PLC_PRG
2 VAR
3     TO_Data1 : WORD;
4     TO_Data2 : WORD;
5     TO_Data3 : DWORD;
6     OT_Data1 : WORD;
7 END_VAR
```

3-2 Map I/O data to each variable that has been created. Double-click the section indicated by (1) and select a variable to which I/O data is to be mapped.

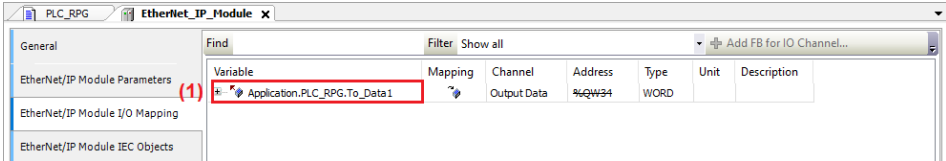

The screenshot shows the "EtherNet/IP Module I/O Mapping" configuration window. The left sidebar has "EtherNet/IP Module I/O Mapping" selected, with a red circle and the number "1" next to it. The main area contains a table with the following data:

Variable	Mapping	Channel	Address	Type	Unit	Description
Application.PLC_RPG.To_Data1	Output Data	%QW34		WORD		

13.4.8 EtherNet/IP Adapter Operation

When a project in which EtherNet/IP adapter settings have been configured is downloaded to the GM1 controller and then RUN mode is invoked, the adapter device responds to a ForwardOpen packet from the scanner device and cyclic communication is started.

The following shows the respective states of the local adapter device and module devices during normal operation.

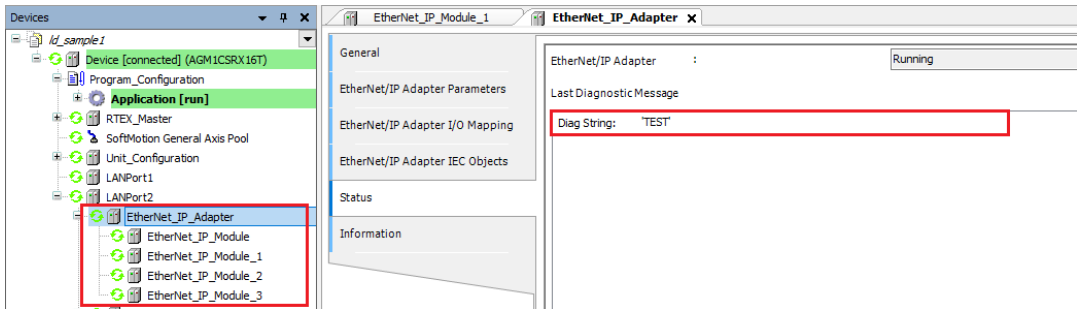

The local adapter device and module devices are displayed with "O" symbol in the Device tree and the status of the local adapter device is displayed as "Adapter running".

The local adapter device can be connected from multiple scanner devices.

Note

- ExclusiveOwner connection (using O→T data) is allowed for only one scanner device. This is to prevent the same variable from being overwritten with input data from multiple scanner devices.

13.5 Communicating with Display Units

Variables that communicate with the display can be set in the GM Programmer's symbol configuration.

When code generation is executed in the set project, the symbol definition XML file (.xml) is generated in the same folder as the project file (.project), so you can import it into the display and share the variable definition.

13.5.1 Symbol Configuration

This section describes the symbol configuration function.

With this function, a symbol configuration object can be added and used.

You can set variables communicating with the display unit as well as variables open to the OPC UA server.

■ Creating symbol configuration object

1. Right-click the [Application] object in the navigation pane and select **Add Object > Symbol Configuration** from the context-sensitive menu that is displayed.

The "Add Symbol Configuration" dialog box will be displayed.

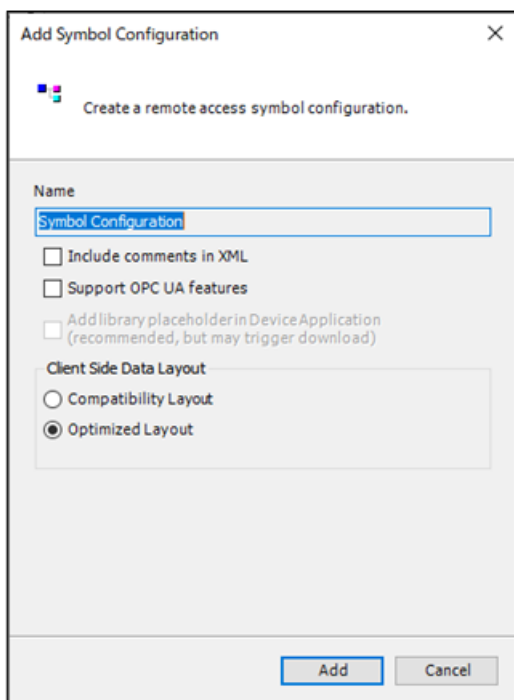

2. Enter a name, select check boxes for necessary items, and click the [Add] button. A symbol configuration object will be added under the [Application] object.

13.5 Communicating with Display Units

List of setting items

Item	Description
Include comments in XML	Includes comments on variables in an XML file when the symbol configuration is exported to the XML file.
Support OPC UA features	Enables the symbol configuration OPC UA Server function.
Client Side Data Layout	Specifies a method for generating a client side data layout.
Compatibility Layout	Generates a data layout compatible with older version. Do not use this setting because of possible trouble occurrence.
Optimized Layout	Use this setting.

■ Editing symbol configuration

1. Double-click the [Symbol Configuration] object in the navigator pane. The setting pane will be displayed in the main pane.

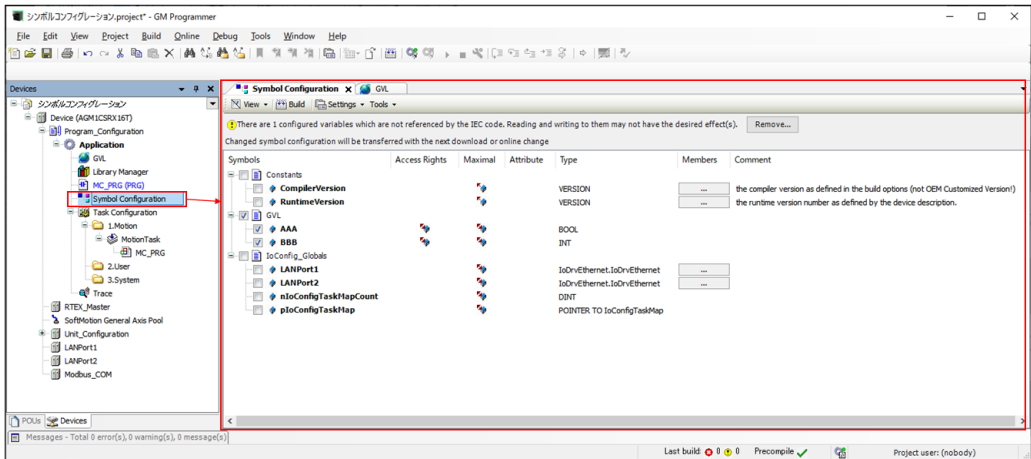

Press [Build] to display the declared variables list in the window.



In the setting pane, the symbols (variables) table and menu bar for editing are displayed.

● Symbols table

Symbols	Access Rights	Maximal	Attribute	Type	Members	Comment
Constants						
CompilerVersion				VERSION	...	the compiler version as defined in the build options (not OEM Customized Version!)
RuntimeVersion				VERSION	...	the runtime version number as defined by the device description.
GVL						
AAA				BOOL		
BBB				INT		
IoConfig_globals						
LANPort1				IoDrvEthernet.IoDrvEthernet	...	
LANPort2				IoDrvEthernet.IoDrvEthernet	...	
nIoConfigTaskMapCount				DINT	...	
pioConfigTaskMap				POINTER TO IoConfigTaskMap	...	

The symbols table shows the following components:



Item name	Description
Symbols	Displays a list of variables. If the check boxes are selected, values can be read or written from display units and OPC UA devices.

Item name	Description
Access Rights	<p>If a symbol in the [Access Rights] column is clicked, the right of access to the symbol can be changed.</p> <p>Access right icons</p> <p> Read only</p> <p> Write only</p> <p> Read / Write</p> <p>With these rights, functions, function blocks, methods, and programs can be accessed.</p>
Maximal	Maximum access rights.
Attribute	For symbols set by Attribute 'symbol' pragma, set access rights are displayed.
Type	Displays the data type of the symbol.
Members	<p>A elision mark button is displayed only for structure-type symbols.</p> <p>By clicking the elision mark button, you can set the access right member by member in the structure.</p> <p>Note: This selection is applied to all instances of this data type for which the symbol is exported.</p> <p>Note: If members in the structure cannot be selected, an asterisk is displayed at the member check box, indicating that all the members that can be read or written will be exported.</p>
Comment	Displays a description of the symbol.

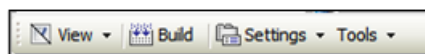
- Menu bar



The menu bar displays the following menus:

Item name	Description	
View	When the following items used in the symbol configuration are clicked, symbol display is filtered.	
	<p>Project, not yet configured</p> <p> Symbols that are not added to the symbol configuration but are provided in projects.</p>	
	<p>Library, not yet configured</p> <p> Symbols that are not added to the symbol configuration but are provided in libraries.</p>	
	<p>Symbols exported on attribute</p> <p> Symbols set by Attribute 'symbol' pragma.</p>	
Build	<p>This item is used to compile a project.</p> <p>Note: Build needs to be executed to display variables in the symbol table.</p>	
Settings	Support OPC UA features	Enables the symbol configuration OPC UA function.
	Include comments in XML	Includes comments on variables in an XML file when the symbol configuration is exported to the XML file.
	Include node flags in XML	Includes namespace node flags in an XML file when the symbol configuration is exported to the XML file.

13.5 Communicating with Display Units

Item name		Description
	Include comments and attributes	<p>About comments and attributes, you can set details of the symbol configuration and contents required to be included in the XML file.</p> <p>XML symbol file contents can be configured to include "namespace node flag", "comment", and "attribute".</p> <p>Do not use this setting for symbol table contents because the OPC UA function does not support it.</p>
	Configure sync with IEC task	<p>You can set a function with which to access variables in sync with an IEC task.</p> <p>Do not use.</p>
	Compatibility Layout	<p>Generates a data layout compatible with older version.</p> <p>Do not use this setting because of possible trouble occurrence.</p>
	Optimized Layout	<p>Generates a data layout independent of the internal layout.</p> <p>Use this setting.</p>
	Use empty namespace by default	Do not use.
	Enable direct I/O access	Do not use.
	Enable symbol set	<p>Enables symbol set configuration.</p> <p>In the "Symbol Permissions" tab of the device editor, set the device users who have access to the configured symbol set.</p>
Tools	Save XML schema file	Saves a symbol file in XSD format to use it in external programs.

13.6 OPC UA Server

13.6.1 What is OPC UA?

OPC Unified Architecture (OPC UA) is an interoperability standard for the secure and reliable exchange of data in the industrial automation field and other industries.

Abstracting PLC specific protocols (such as Modbus) into a standardized interface, OPC UA is platform-independent and ensures the seamless flow of information among many devices.

As a result, users with HMI (display unit) or SCADA systems can build systems that interface with and seamlessly interact with devices via OPC.

13.6.2 OPC UA Server Settings

1 2 Procedure

1. With reference to section "[13.5.1 Symbol Configuration](#)", select variables to be opened.
2. Select the "Support OPC UA features" check box to enable the server function.
3. After downloading the project to the GM1 controller, turn the controller OFF and then ON to get the OPC UA Server function enabled.

Note

- Variables that are opened are used in common with settings used for communication with the display unit.
- Please use the number of items that can be monitored at one time within the range of "[13.6.3 OPC UA Server Specifications](#)".

13.6 OPC UA Server

13.6.3 OPC UA Server Specifications

OPC UA server specifications with the GM1 controller are described below:

Item	Details
Available ports	Both LAN ports 1 and 2
Supported Profiles	Micro Embed Device Server Profile
Server URL	Port 1: opc.tcp://192.168.1.5:4840 (default) Port 2: opc.tcp://192.168.2.5:4840 (default) * IP addresses depend on settings
Maximum number of sessions	2
Number of all monitored items on server	1000 Monitoring interval: Minimum 300 ms Client notification interval: Minimum 500 ms
Variable types not permitted to be opened to server	<ul style="list-style-type: none"> • Real number (LREAL: permitted, REAL: not permitted) • Character string (WSTRING: permitted, STRING: not permitted) • Time (only DATE_AND_TIME(DT): permitted, others: not permitted) • Constant (const), Interface, Properties • Union, Pointer
Limit on the number of variable name characters	<ul style="list-style-type: none"> • Up to 255 characters • Half-width characters (alphanumeric characters, symbols)
Security settings	Security mode: <ul style="list-style-type: none"> • None: Neither signature nor encryption required • Sign: Only signature required • Sign & Encrypt: Both signature and encryption required Security policy: <ul style="list-style-type: none"> • Basic256 Sha256
Certificates	Classified as below (Each 32 units can be registered) <ul style="list-style-type: none"> • Own Certificates: own certificates • Trusted Certificates: certificates that are trusted • UnTrusted Certificates: certificates that are not trusted • Quarantined Certificates: certificates that are quarantined
User authentication	<ul style="list-style-type: none"> • Username&Password (user name and password) • Anonymous (anonymous user) * Do not use anonymous user from a security perspective

13.6.4 Security Settings

You can set security settings for secure communication with the OPC UA server

1 2 Procedure

1. Perform a network scan and connect to the GM1 controller.
2. Click the display security screen of menu bar **View>Security Screen**.
3. Click the  button to display the certificate information in the device.

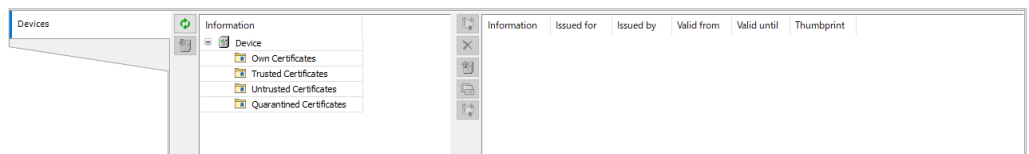

4. Select "Device" to display the certificate status.

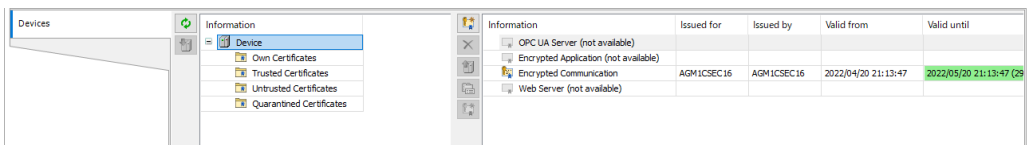

5. Select "OPC UA Server" and click the  button on the certificate icon.
6. The screen for setting the length and validity period of the certificate key will be displayed. Set it and click the "OK" button.

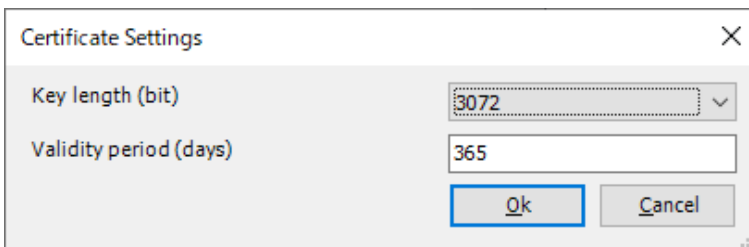

7. Once the OPC UA Server certificate has been created, it becomes active.

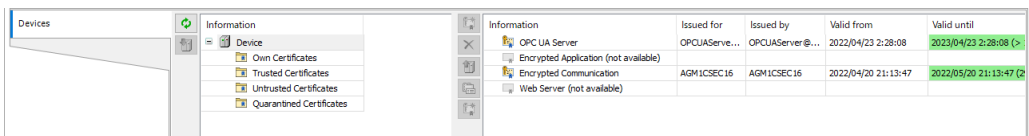

13.7 FTP Server Function

13.7 FTP Server Function

13.7.1 Overview of FTP Server Function

The FTP server function allows the FTP client to read files from the SD card mounted on the GM1 controller and write files into the SD card.

13.7.2 Setup Procedure

1 2 Procedure

1. Double-click the [Device] object in the navigator pane to display the Device setting window.
2. Click the "PLC parameters" tab in the Device setting window.
3. Click "FTP server settings" in the "Category selection".
4. When the "Use FTP server" setting is changed to "Valid" in "Parameter settings", the settings in items take effect. For the contents of setting items, refer to "13.7.3 List of Setting Items".

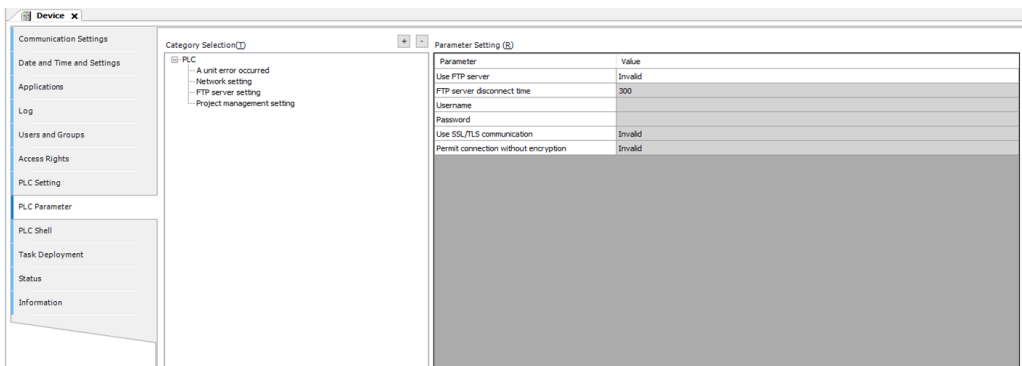

i Info.

- The FTP server function is supported by the unit firmware Ver. 1.3 or later.
- Up to three FTP clients can be connected at the same time.

13.7.3 List of Setting Items

List of setting Items (FTP server)

Setting item	Default	Description
Use FTP server	Not use	Select whether to use the FTP server function.
FTP server disconnection time	300	Setting unit: 1 (second) Setting range: 300 to 4,294,967,295 Enter an inactive communication monitoring time for FTP connection. When the time for which the FTP server is in an inactive communication state has exceeded the specified time, the server is automatically disconnected.
User name	—	Enter a user name for logging in to the FTP server. Number of characters: 4 to 32 Allowed characters: lowercase and uppercase alphabetic characters, numerals, and an underscore (_)
Password	—	Enter a password for logging in to the FTP server. Number of characters: 8 to 32 Allowed characters: lowercase and uppercase alphabetic characters, numerals, and symbols (space (SP), !, #, \$, %, &, (,), *, +, -, ., /, :, ;, <, =, >, ?, @, [,], ^, _ , {, , }, ~) Combine three different types out of lowercase and uppercase alphabetic characters, numerals, and symbols.
Use SSL/TLS communication	Not use	Set whether to use SSL/TLS communication (Explicit mode) under encrypted connection. Only SSL/TLS version TLS1.2 can be used.
Permit connection without encryption	Not permit	Select whether to allow communication even under insecure state by configuring settings without encryption or to allow only secure communication using the SSL/TLS (encryption). This item is operative only when "Use SSL/TLS communication" is set to "Valid". If set to "Valid", match the SSL/TLS (encryption) communication setting on the FTP client side to the setting on this side.

Info.

- If you forget your password, you cannot log in to the GM1 controller. In this case, execute device reset from the GM1 controller.
(For details, refer to the "8.8.3 Executing Device Reset from GM1 Controller")
- The root directory of the FTP server is the root directory of the SD card on the GM1 Controller.

13.7 FTP Server Function

13.7.4 FTP Server Standards

The FTP server provides FTPS functions according to the following SSL/TLS specifications.

Item	Description
Protocol	TLS1.2
Cipher suite	<p>Available cipher suites differ depending on the cipher system of the certificate used.</p> <p>"When RSA certificate is used"</p> <ul style="list-style-type: none">• TLS_ECDHE_RSA_WITH_AES_128_GCM_SHA256• TLS_RSA_WITH_AES_128_GCM_SHA256• TLS_ECDHE_RSA_WITH_AES_128_CBC_SHA256• TLS_ECDHE_RSA_WITH_AES_256_CBC_SHA• TLS_RSA_WITH_AES_256_CBC_SHA256• TLS_RSA_WITH_AES_128_CBC_SHA256• TLS_RSA_WITH_AES_256_CBC_SHA <p>"When ECDSA certificate is used"</p> <ul style="list-style-type: none">• TLS_ECDHE_ECDSA_WITH_AES_128_GCM_SHA256• TLS_ECDHE_ECDSA_WITH_AES_128_CBC_SHA256• TLS_ECDHE_ECDSA_WITH_AES_256_CBC_SHA <p>* The suites are listed in order of precedence. * Key length: ECDHE/ECDSA = 256bit, RSA = 2048bit * The RSA certificate is built in by default.</p>
Server certificate	<p>The server certificate is a default certificate, which is used when the user certificate is not set, or is a user certificate, which is used when the user certificate is set.</p> <p>Default certificate: A 2048-bit self-signed RSA certificate that is set by factory default. User certificate: A certificate set by the user.</p> <p>* This can be set as either a RSA certificate or ECDSA certificate.</p>
Connection method	<p>Explicit connection.</p> <p>* Implicit connection is not supported.</p>

Info.

- For the method of writing a user certificate, refer to "[13.7.5 SSL/TLS Certificate Settings](#)".
- A desired certificate / secret key can be set for use in the SSL/TLS communication. * When this is not set, the default certificate is used.
- Do not perform the following operations while the operation mode is in RUN mode. Please change to STOP mode and execute.
 - Insert the SD card with "Use FTP server" enabled.
 - Registering and deleting certificates with "[13.7.5 SSL/TLS Certificate Settings](#)".

13.7.5 SSL/TLS Certificate Settings

Set this when using an SSL/TLS certificate / secret key prepared by the user for the SSL/TLS communication of the FTP server function.

* When this is not set, the default self-signed certificate / secret key is used.

Perform the procedure in "7.3 Communication Setting" in advance to connect GM Programmer to the GM1 controller.

1 2 Procedure

- From the menu bar, select **Online>SSL/TLS Certificate Management**.
The "SSL/TLS Certificate Management" screen is displayed.

- Select "Register" under "Operation type".
Select "Delete" to delete the certificate and follow the following step 5.
- Press the [Refer (1)] button and select a certificate file.

Certificate designation file

Item	Description
Extension	pem, cer, crt
File format	ASN.1 (Base64)
Data size	8,192 bytes or less

- Press the [Refer (2)] button and select the secret key file that corresponds to the certificate selected in step 3.

Secret key designation file

Item	Description
Extension	pem, key
File format	ASN.1 (Base64)
Data size	8,192 bytes or less

- Press the [Execute] button.
The designated certificate / secret key is transferred to the GM1 controller and an attempt is made to restart the FTP server. When the FTP server is successfully restarted, the

13.7 FTP Server Function

transferred certificate / secret key is reflected. The same reflection timing applies when the certificate is deleted.

i Info.

- Checking user certificate storage status
The storage status of the user certificate can be checked by the SYS_GetFTPCertState function. For details, refer to the *GM1 Series Reference Manual (Instruction Edition)*.
- The user certificate is not transferred when a project is downloaded.

13.8 MQTT Client

13.8.1 What is MQTT?

MQTT stands for Message Queuing Telemetry Transport. It is a simple and lightweight publish/subscribe messaging protocol.

This protocol allows asynchronous many-to-many communication by a mechanism called “topic” designed to identify messages. Messages are sent and received through an intermediary called a broker server, and thus MQTT enables a device to communicate with another device on the opposite side without being conscious of the opposite device. In addition, since the intermediary is responsible for most of message management, the number of connected client devices can be readily increased. Another feature is that client devices can be freely connected to and disconnected from the broker server. Generally, the amount of information necessary for exchange is small, and this helps to reduce the burden on CPUs and power consumption.

Because of these features, MQTT is widely adopted for IoT applications and is a protocol effective in a system for control among a large number of devices, as well as data logging, traceability, and other communication with a host system.

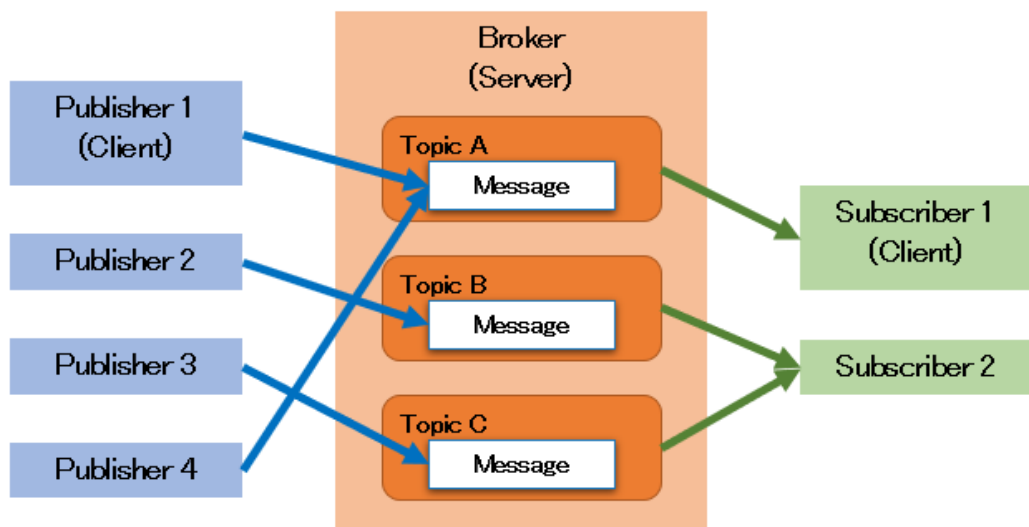

13.8 MQTT Client

13.8.2 MQTT Client Specifications

MQTT client specifications with the GM1 controller are described below.

- MQTT Client Specifications

Item	Details
Usable port	LAN ports 1, 2
MQTT protocol version	Version 3.1.1 Version 5.0
Data size	Max. 6000 bytes per packet (payload part Max. 4096 Bytes) (Note 1)
Topic	Topic name : Max.1024 characters Topic level : Max.10
Communication constraints	Max. 20 publishes/subscribes per connection Max. 3 connections
Supported QoS	<ul style="list-style-type: none"> • QoS0 (publish at most once) • QoS1 (publish at least once) • QoS2 (publish exactly once)

(Note 1) This applies to the MQTT protocol packet size out of the total packet.

- List of supported functions

Type	Function	Overview	MQTT Version	
			3.1.1	5.0
Connect ion	KeepAlive	Specifies an interval during which connection closing is judged	○	○
	Will Message	Specifies a message that is sent when connection is closed	○	○
	Will Retain	Specifies if the Will Message is to be retained	○	○
	Will QoS	Specifies the QoS level for the Will Message	○	○
	Clean Session	Specifies a session used for connection with the broker server	○	○
	User authentication	Connection using a user name and password	○	○
	Client ID	Specifies a client identifier	○	○
	Ping Interval	Specifies an interval at which a ping request (existence check) is sent	○	○
	TLS connection	Connection encrypted by TLS	×	×
	WebSocket connection	Connection using WebSocket	×	×
	Reason Code	An output value of the detailed result of an operation	×	○
	Session Expiry Interval	Specifies how long to retain the session after a disconnect	×	○
	Enhanced authentication	Using other forms of authentication	×	×

Type	Function	Overview	MQTT Version	
			3.1.1	5.0
	Request Problem Information	Specifies the way an operation result is received	x	o
	Request Response Information	Requests the server to return Response Information (runs on request/response format)	x	x
	Receive Maximum	Specifies the number of messages that the client can process concurrently	x	o
	Topic Alias Maximum	Specifies the number of Topic Aliases that the client can receive	x	x
	Maximum Packet Size	Specifies a Maximum Packet Size value	x	o
	Payload Format Indicator	Specifies a format for the Will Message	x	o
	Message Expiry Interval	Specifies an interval for the expiry of the message	x	o
	Content Type	Specifies a type of the content of the Will Message	x	x
	Response Topic	The topic name for a response message (runs on request/response format)	x	o
	Correlation Data	Specifies correlation data (runs on request/response format)	x	o
	Will Delay Interval	Specifies a delay that occurs before the Will Message is sent	x	o
	User Property	User-defined properties	x	o
Publish	Re Delivery	Specifies the re-delivery flag (DUP Flag)	o	o
	Retain	Specifies a message store setting	o	o
	Payload Format Indicator	Specifies a format for the message	x	o
	Message Expiry Interval	Specifies an interval for the expiry of the message	x	o
	Content Type	Specifies a type of the content of the message	x	x
	Response Topic	The topic name for a response message (runs on request/response format)	x	o
	Correlation Data	Specifies correlation data (runs on request/response format)	x	o
	Subscription ID	The identifier of the subscription (for the broker)	x	x
	Topic Alias	Specifies a Topic Alias value	x	o
User Property	User-defined properties	x	o	
Subscribe	Subscription ID	Specifies the identifier of the subscription	x	o
	Correlation Data	Reception of correlation data (runs on request/response format)	x	o
	No Local Option	The setting of reception of messages from the same client	x	o
	Retain As Published	The setting of the Retain flag in a forwarded message	x	x

13.8 MQTT Client

Type	Function	Overview	MQTT Version	
			3.1.1	5.0
	RetainHandling	Setting of whether or not to receive retained messages at the time of subscribing	x	o
	User Property	User-defined properties	x	o

13.9 DNS client

13.9.1 What is DNS?

DNS stands for the Domain Name System and refers to a system that manages a mapping between the name of a domain or a host on the network and its IP address. A DNS server has information about mappings between domain names and IP addresses. In response to a query containing a “host name” as a key from a DNS client, the DNS server sends back a corresponding “IP address”.

The GM1 controller can obtain an IP address corresponding to a domain name from a DNS server through an FB of a DNS client.

13.10 NTP client

13.10 NTP client

13.10.1 What is NTP?

NTP stands for the Network Time Protocol and is a communication protocol used to synchronize time between systems in a server/client model. A mechanism for time synchronization operates by allowing an NTP client to send a query about time to a NTP server and obtain a response. Handled time information is defined as the number of seconds that have elapsed since 00:00:00 UTC on January 1 in 1970, and the NTP mechanism allows the synchronization of time in units of milliseconds.

The GM1 controller supports the Simple Network Time Protocol (SNTP), a simplified version of NTP. The GM1 controller can obtain time information from an SNTP server through an FB of SNTP client communication.

14 Management Function

14.1 Security Function	14-2
14.1.1 User Management	14-3
14.1.2 Encryption	14-16
14.1.3 Write-protection	14-24
14.2 Interface Function	14-26
14.2.1 Setting up an Interface Object	14-26
14.2.2 Implementing in New Function Block	14-29
14.2.3 Implementing in Existing Function Block	14-31
14.2.4 Extending the Interface	14-35
14.3 SD Card Access Function	14-37
14.3.1 Overview of SD Card Access Function	14-37
14.3.2 File Manipulations Using the CAA File Library	14-38
14.4 External File Functions	14-39
14.4.1 Setting up an External File Object	14-39
14.5 Recipe Manager Functions	14-41
14.5.1 Setting the Recipe Manager	14-41
14.5.2 Setting the Recipe Definition	14-44
14.5.3 Recipe Operation Using the GM Programmer	14-46
14.5.4 Recipe operation using instructions in the POU	14-49
14.5.5 Saving and restoring persistent variables	14-53
14.6 Project Management Function	14-56
14.6.1 What is Project Management Function?	14-56
14.6.2 Backup (Operation by the controller)	14-58
14.6.3 Restore (Operation by the controller)	14-59
14.6.4 Backup and Restoration (Function Blocks)	14-60
14.7 Firmware Version Upgrade Function	14-61
14.7.1 Checking Unit Configuration	14-61
14.7.2 Unit Version Upgrade	14-62
14.8 Servo Amplifier / Motor Operation Function (PANATERM Lite for GM)	14-64
14.8.1 Starting PANATERM Lite for GM	14-64

14.1 Security Function

14.1 Security Function

GM Programmer is equipped with a security function that can implement user management (project user management and device user management) and encrypt project files. This section explains security-related functions such as user management and project encryption, and the procedures for operating each security function.



- Each user ID and their corresponding password must be different character strings.
- Password strength must be sufficiently high. Do not use any passwords that can be easily guessed.
- Accounts must be managed properly and must not be shared unnecessarily.



- Use this controller in a secure network environment.
- Use encryption functions properly to protect information assets.
- Use the device user management function to perform authentication protection for the controller during operation.
- After logging in with the initial password, be sure to change the password.
- Implement password management to prevent passwords from being forgotten. If the password is forgotten, device reset must be performed on the controller.
- Implement password management to prevent passwords from being leaked to third parties.

Item	Description	Reference page
User management	Allows execution permissions for operations (such as executing menu commands and adding, editing, and deleting objects) to be assigned to each group in which users are registered. User management also enables logins to be permitted by assigning permission for login to the device to each user and entering passwords.	"P.14-3"
Encryption / signature	Provides password-based encryption for project files and encrypts connections between the GM1 controller and the PC.	"P.14-16"
Write-protection	Provides write-protection for project files and prevents project files from being modified unintentionally by mistake.	"P.14-24"

14.1.1 User Management

Project user management allows execution permissions for operations (such as executing menu commands and adding, editing, and deleting objects) to be assigned to each group in which users are registered. Logon must be performed by a user of a privileged group.

Device user management also enables logins to be permitted by assigning permission for login to the device to each user and entering passwords.

Project User Management

When a new project is created, Owner users, Owner group, and Everyone group are already registered.

Owner users belong to Owner group and can execute all operations.

All users including Owner users are automatically registered in Everyone group.

Group	User	Remarks
Owner	Owner	Users can execute all operations. For Owner users, the password field is left blank.
Everyone	Owner	All users are registered automatically.

Creating a New User and Group

In the following example, a group (group name: GroupA) and a user belonging to the group (user name: Fred) are newly created and privileges are set so that users belonging to GroupA can access POU object "POU_1".

1 2 Procedure

1. From the menu bar, select **Project>Project Settings**.

The "Project Settings" dialog box will be displayed.

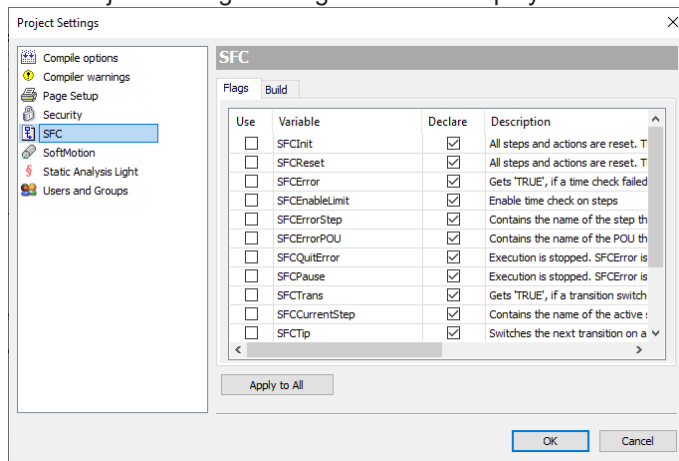

2. In the "Project Settings" dialog box, select the "Users and Groups" category.

14.1 Security Function

The "Users and Groups" setting pane will be displayed.

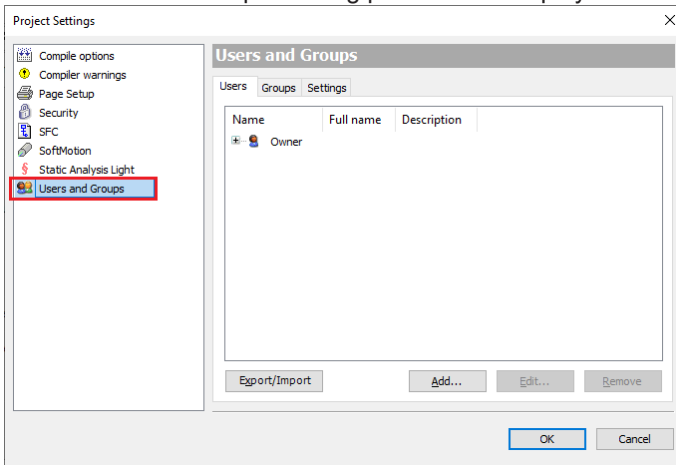

3. Click the [Add] button.

The "Add User" dialog box will be displayed.

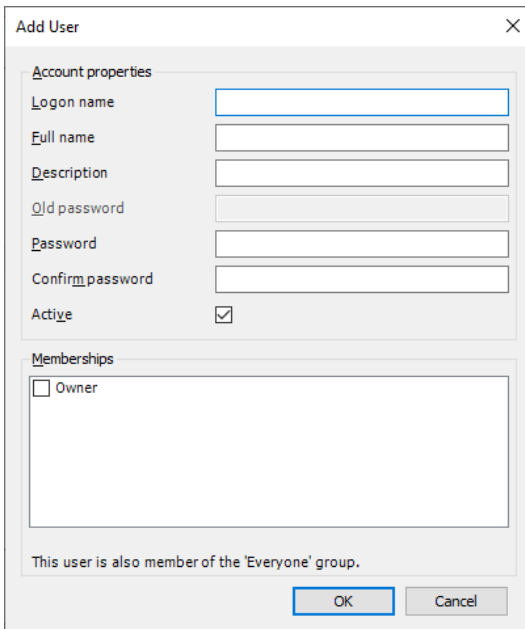

4. Enter information for a new user to be added.

Enter information about a new user (Fred) to be added.

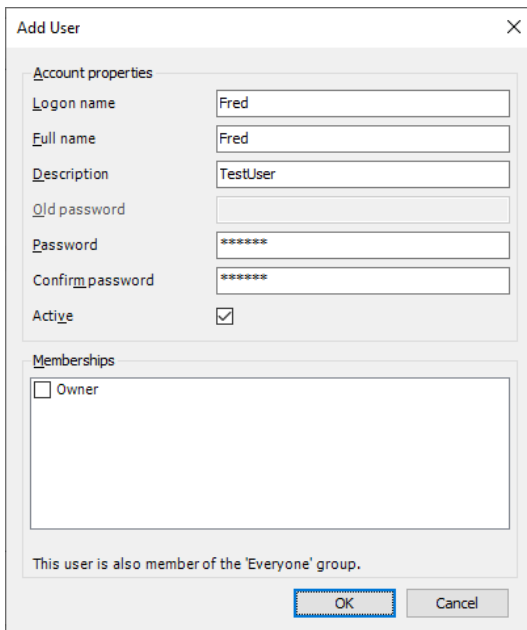

Add User

Account properties

Logon name: Fred

Full name: Fred

Description: TestUser

Old password:

Password: *****

Confirm password: *****

Active:

Memberships

Owner

This user is also member of the 'Everyone' group.

OK Cancel

5. Click the [OK] button.
The "Logon" dialog box will be displayed. To add a new user, you must log in as an Owner user.
6. In the "User name" field, enter "Owner".
The default password for "Owner" is not set in the Password field.
The "Password" field must be left blank.

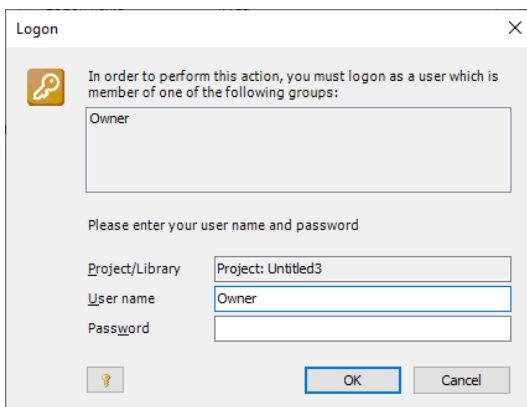

Logon

In order to perform this action, you must logon as a user which is member of one of the following groups:

Owner

Please enter your user name and password

Project/Library: Project: Untitled3

User name: Owner

Password:

OK Cancel

7. Click the [OK] button.
Login by the Owner user will be completed and new user "Fred" will be added to the "Users" tab pane.

14.1 Security Function

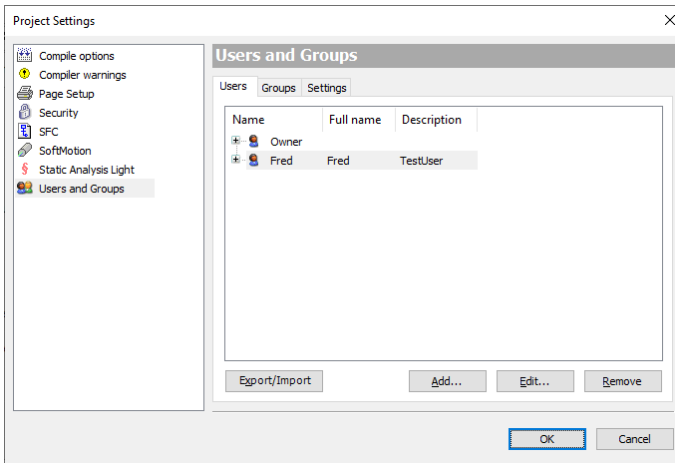

The name ("Owner") of the user who logged on is displayed in the status field.

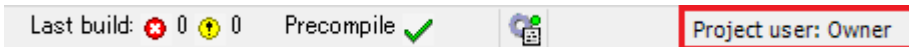

8. Select the "Groups" tab and click the [Add] button.
The "Add Group" dialog box will be displayed.
9. Enter information for a new group to be added.
Enter information about a new group (GroupA) to be added.
In the "Members" section, specify a member that belongs to the group. Select the new user added in step "Step 4".

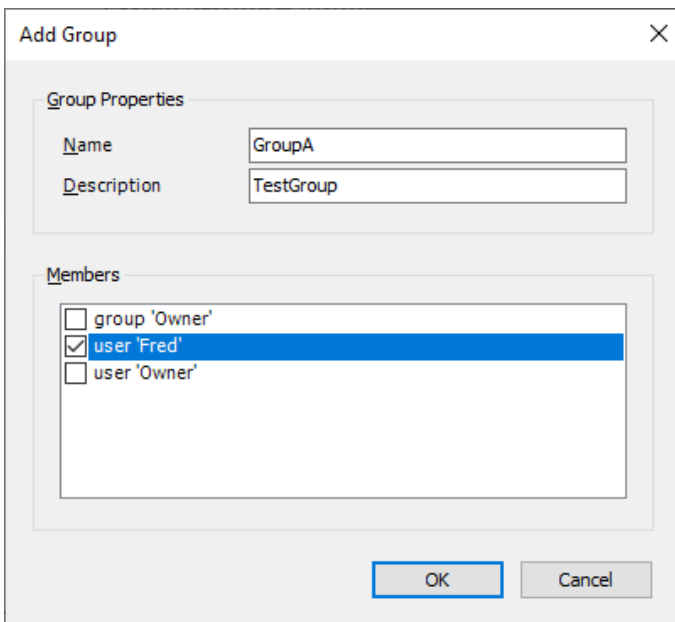

10. Click the [OK] button.
The new group (GroupA) will be added to the "Groups" tab pane.
User "Fred" is registered in GroupA as a member

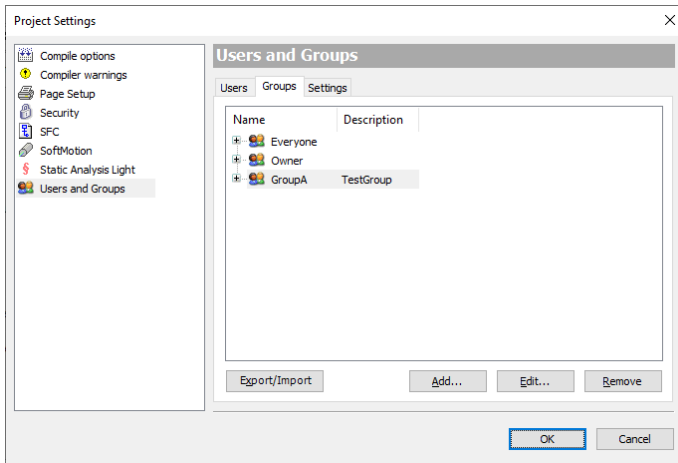

11. Click the [OK] button.

The "Project Settings" dialog box will be closed.

This completes the procedure for registering user "Fred" in group "GroupA".

After the procedure is complete, the following groups and users exist in the project.

Group	User	Remarks
Owner	Owner	Group whose users can execute all operations
Everyone	Owner, Fred	Group in which all users are registered automatically
GroupA	Fred	Newly added group

i Info.

- User and group information can be exported in XML format. Click the [Export/Import] button in the "Users and Groups" setting pane and select the "Export users and groups" menu item. ".users" files can be exported.

By selecting the "Import User and Group" menu item, you can import ".users" files.

14.1 Security Function

Setting Operation Privileges

In the following example, privileges are set so that users belonging to GroupA can display a POU object (object name: POU_1).

Before performing the following procedure, add a POU object (object name: POU_1) to the project.

1 2 Procedure

1. From the menu bar, select **Project>User Management>Permissions**. The "Permissions" dialog box will be displayed.

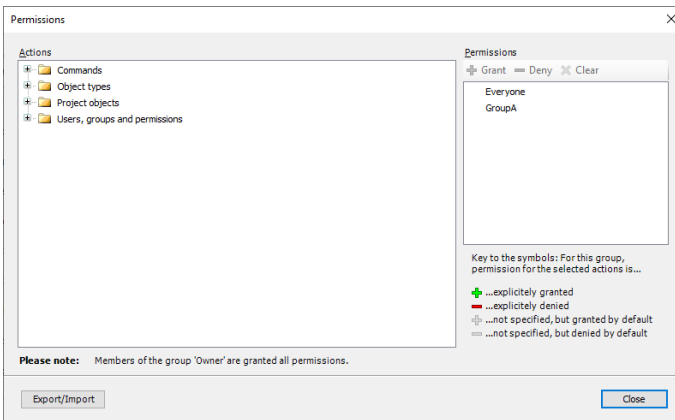

2. In the "Action" pane, select the operation to be permitted. Select **Project Object>View>Device>Program Configuration>Application>POU_1**.

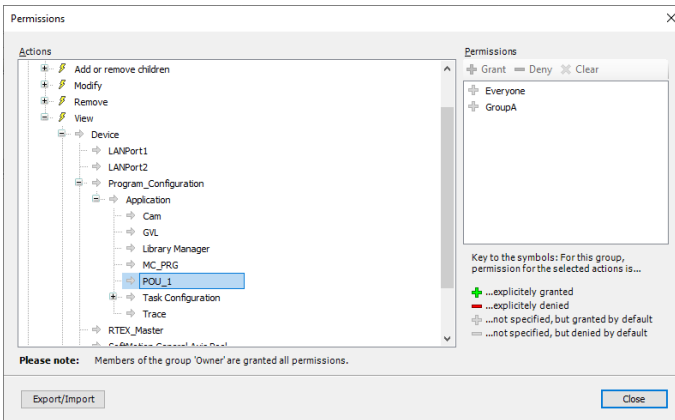

3. In the "Permissions" pane, set privileges to be assigned.
Select "Everyone" and click **Deny** . "Reject" will be set.
Select "GroupA" and click **Grant** . "Approve" will be set.
This enables only the users of group "GroupA" to display the object.

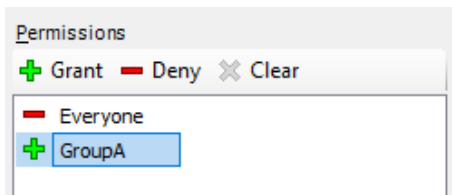

If the "Logon" dialog box is displayed, enter "Owner" in the "User name" field and leave the "Password" field blank before performing a logon.

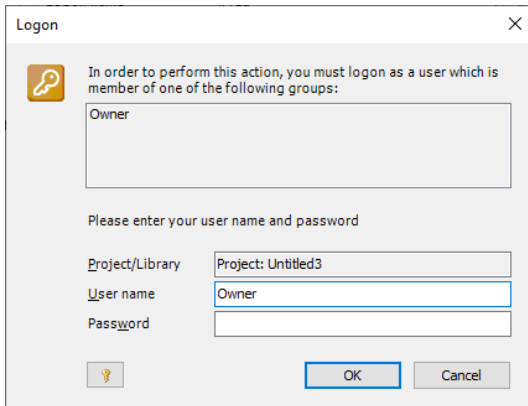

4. Click the [Close] button.
The "Permissions" dialog box will be closed.

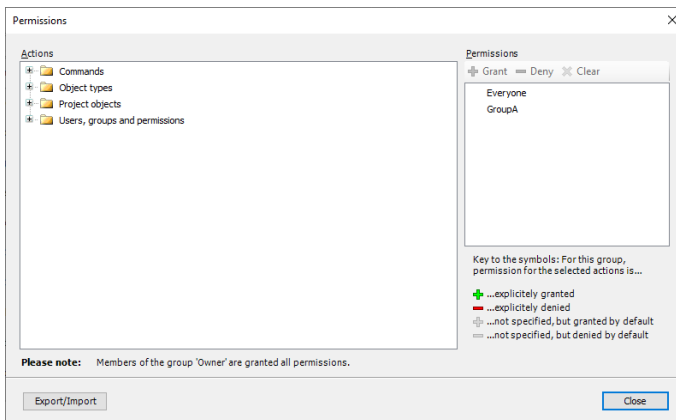

i Info.

- Settings of operation privileges can be exported in XML format. In the "Permissions" dialog box, click the [Export/Import] button and then select the "Export All Permissions" menu item or "Export selected permissions" menu item ".perms" files can be exported.
By selecting the "Import Permission" menu item, you can import ".perms" files.

14.1 Security Function

Performing Operation with Privileges Set

In the following example, an object (POU object: POU_1) is displayed.

Before performing the following procedure, check the status field to see that there is no user who is currently logged on the project.

If there are any users who are currently logged on the project, execute logoff by selecting **Project>User Management>User Logoff**.

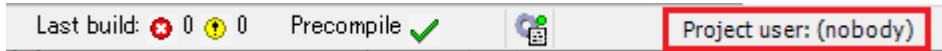

1 2 Procedure

1. Double-click the POU_1 object in the navigator pane.
The "Logon" dialog box will be displayed with object display operations restricted.

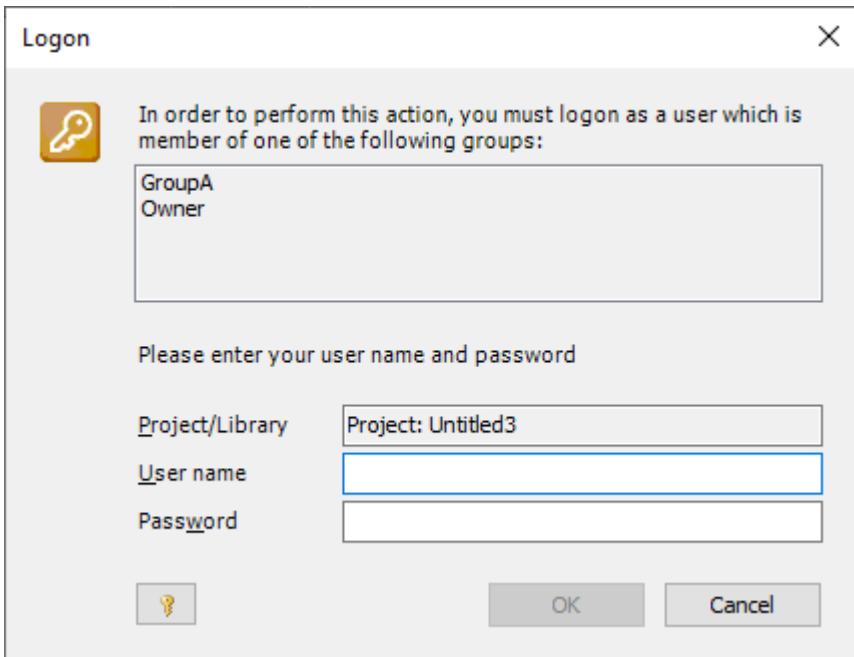

2. Enter appropriate values in the "User name" field and "Password" field, and click the [OK] button.
Enter the user name and password of the user added in "Creating a New User and Group".
Logon will be completed and the POU_1 object will be displayed.
The user name of the user who logged on is displayed on the status field.

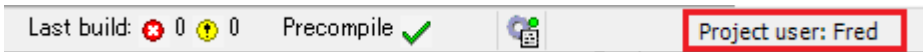

Device User Management

Device user management registers device users and allows only the authorized device users to log in to the device.

A user with user name "Administrator" and password "Administrator" is registered as a device user beforehand.

When you log in as an Administrator user for the first time, you must set any password.

1 2 Procedure

1. Connect the PC where GM Programmer is installed and the GM1 controller.
For details, refer to "7.5 Connecting to the GM1 Controller".
Double-click the [Device] object in the navigator pane.

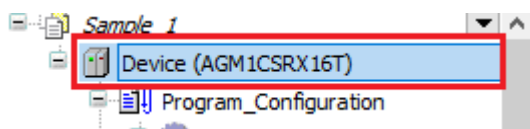

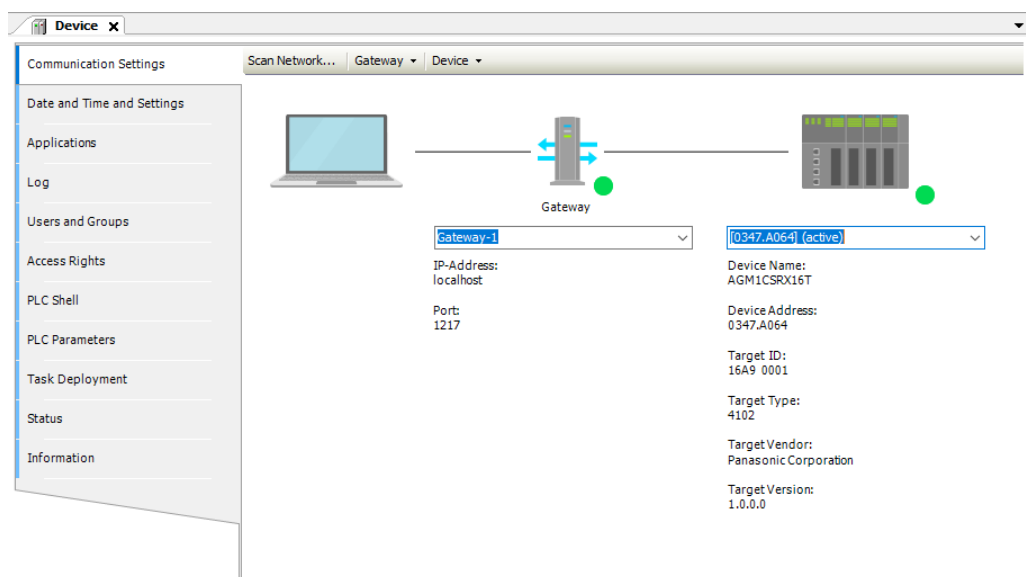

The Device setting window will be displayed.

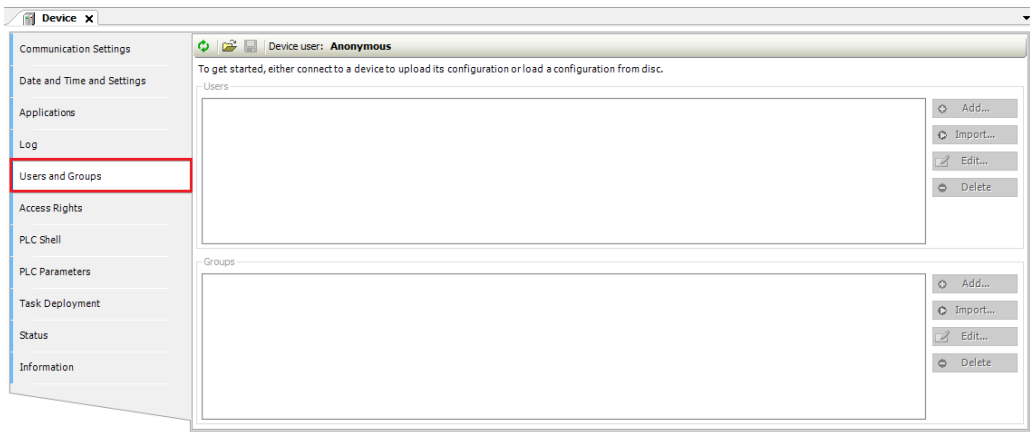

2. Click the "Users and Groups" tab.
The "Users and Groups" pane will be displayed.

14.1 Security Function



3. Click the  icon (Synchronization).
A confirmation dialog box will be displayed.

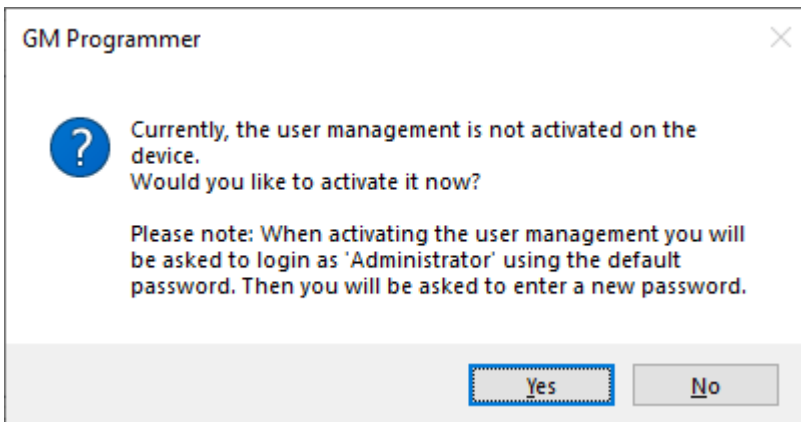

4. Click the [Yes] button.
The "Device User Logon" dialog box will be displayed.
5. Enter "user name" and "password".
Enter Administrator in the "User name" field and Administrator in the "Password" field.

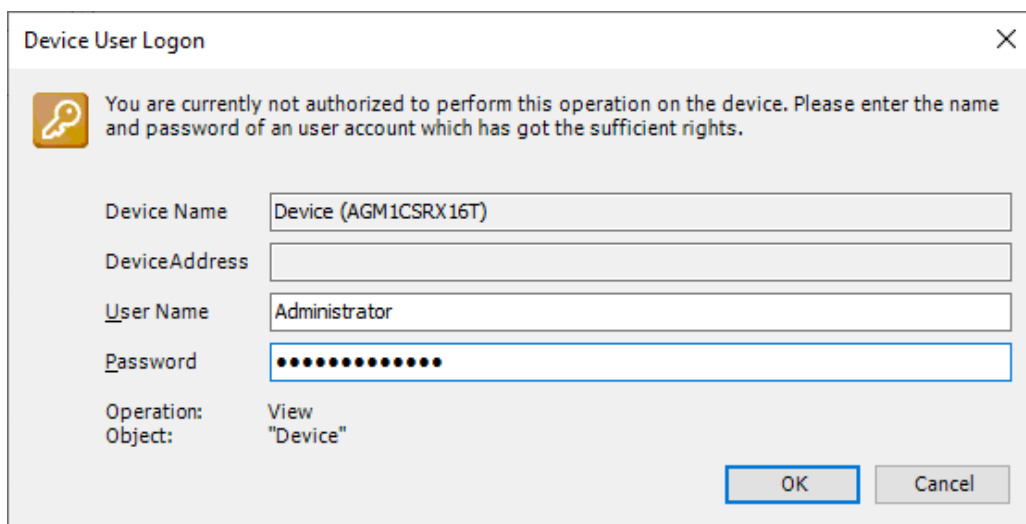

The "Device User Logon" dialog box contains the following fields and information:

- Message:** You are currently not authorized to perform this operation on the device. Please enter the name and password of a user account which has got the sufficient rights.
- Device Name:** Device (AGM1CSRX16T)
- DeviceAddress:** (Empty)
- User Name:** Administrator
- Password:** (Masked with 10 dots)
- Operation:** View
- Object:** "Device"
- Buttons:** OK, Cancel

- Click the [OK] button.
The "Password expired, please enter a new one" dialog box will be displayed.
- Enter any password.
To set a password for the Administrator user, enter any password.
If you forget your password, you cannot log in to the device.

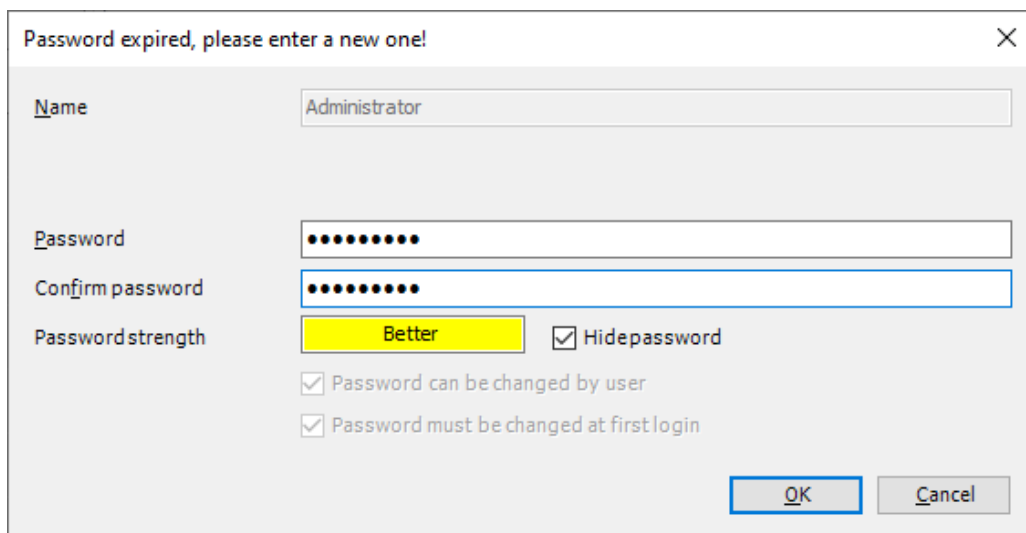

The "Password expired, please enter a new one!" dialog box contains the following fields and options:

- Name:** Administrator
- Password:** (Masked with 10 dots)
- Confirm password:** (Masked with 10 dots)
- Password strength:** Better (highlighted in yellow)
- Hide password:**
- Options:**
 - Password can be changed by user
 - Password must be changed at first login
- Buttons:** OK, Cancel

- Click the [OK] button.
The password will be set for the Administrator user and you will be logged in as an Administrator user.

14.1 Security Function

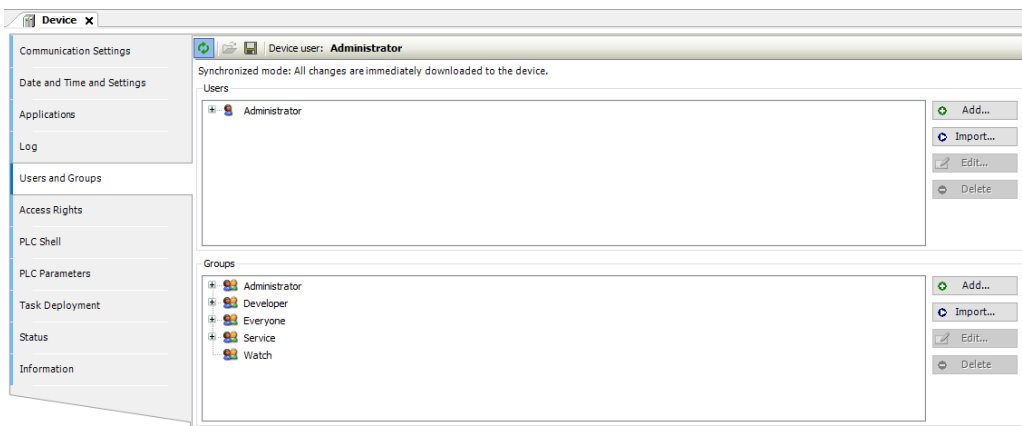

9. From the menu that is displayed, select **Online>Login**.
You can log in to the device as an Administrator user account.



Info.

- To log off logged-in users, from the menu bar, select **Online>Security>Logoff Current Device User**.
- You can add or remove device users or change their passwords by using the "Users and Groups" pane.

To add device users:

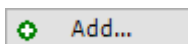



To remove device users:

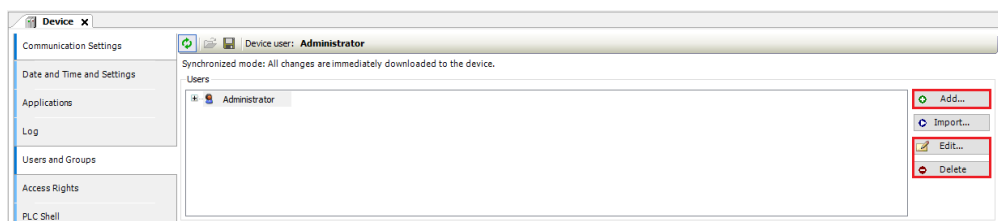
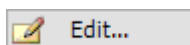

To change device user passwords:

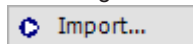

- Users registered by project user management can be imported as device users. Clicking the  button displays the "Import Users" dialog box. Select a user to be imported and click the [OK] button. In this case, passwords managed by project user management will not be imported. In the "Users and Groups" pane, click the [Edit] button and set a password for the user that has been imported.
- Device user management information can be exported.
In the "Users and Groups" pane, click the  icon (Export to Disk). XML format files (".dum" files) can be saved.
To import ".dum" files that have been exported, click the  icon (Import from Disk).
- Device user management information can be initialized by resetting the device.
- If you forget your password, you cannot log in to the GM1 controller. In this case, reset the GM1 controller. For details on how to reset the GM1 controller, refer to the *GM1 Series User's Manual (Hardware)*.

14.1 Security Function

14.1.2 Encryption

This section explains how to encrypt project files.

Encrypting Project Files

Project files can be encrypted using passwords. If a password is set, the password must be entered when a project file is opened.

1 2 Procedure

1. From the menu bar, select **Project>Project Settings**.
The "Project Settings" dialog box will be displayed.
2. In the "Project Settings" dialog box, select the "Security" category.
The "Security" pane will be displayed.

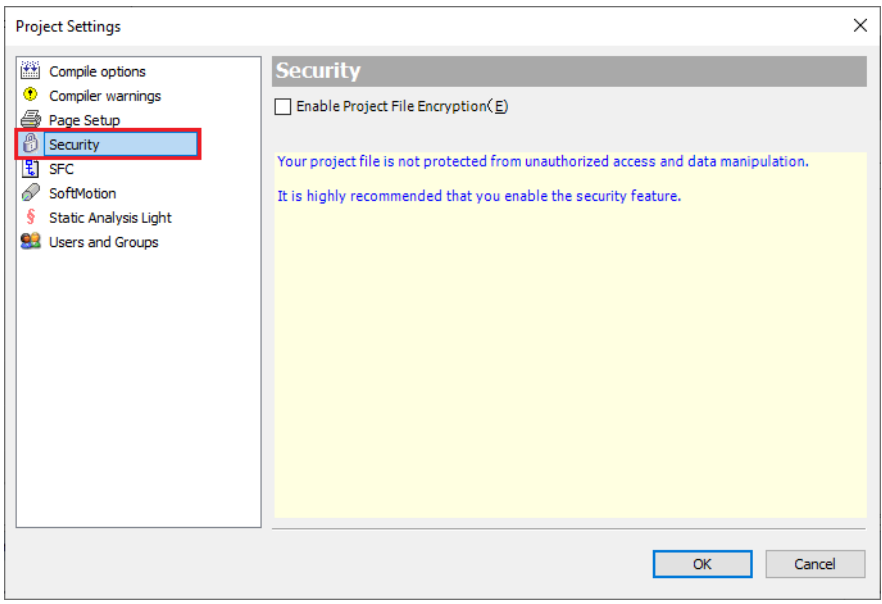

3. Select the "Enable Project File Encryption" check box, select the Password option, and then enter a password.

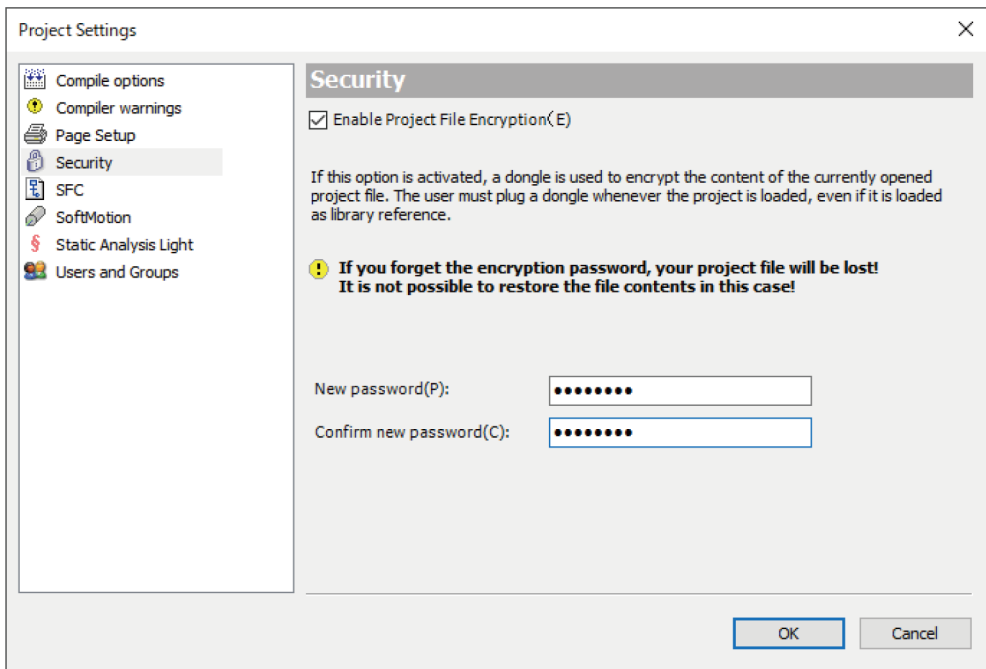

4. Click the [OK] button.

The specified password will be set for project files.

This completes the password setting procedure.

When an attempt is made to open a project file, a window is displayed, asking the user to enter a password. In this situation, enter the specified password.

Encrypting the Communication Path: Encrypting Communications Using the Certificate Possessed by the GM1 Controller

Communications between GM Programmer and the GM1 controller can be encrypted using certificates.

This section explains how to encrypt communications by using the certificate possessed by the GM1 controller as a trusted certificate.

1.2 Procedure

1. Double-click the [Device] object in the navigator pane.

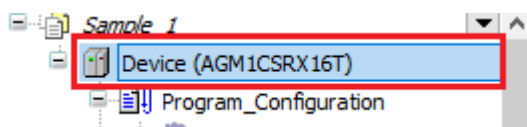

The Device setting window will be displayed.
Open the "Communication Settings" tab.

14.1 Security Function

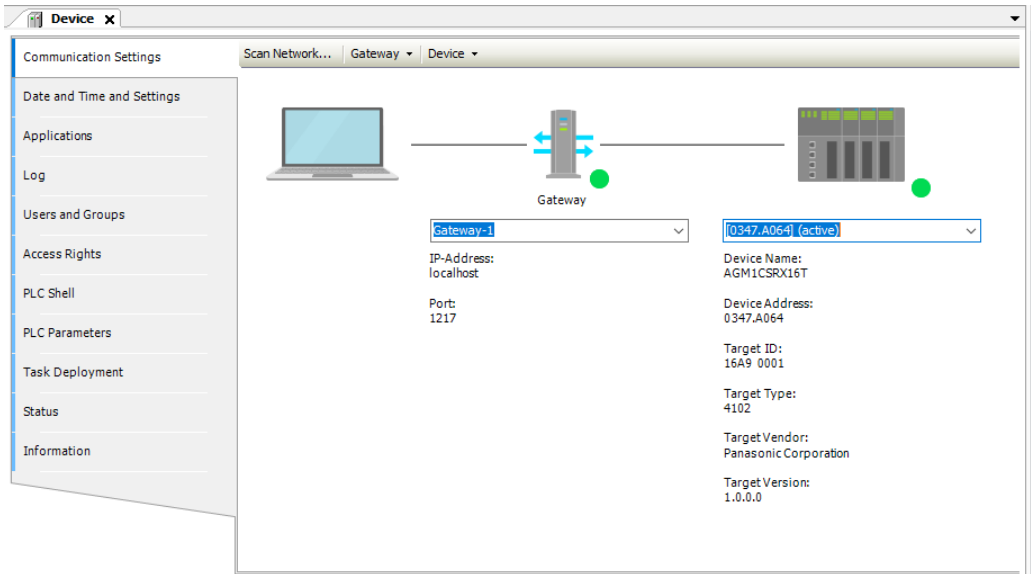

2. In the Device menu, select "Encrypted Communication".

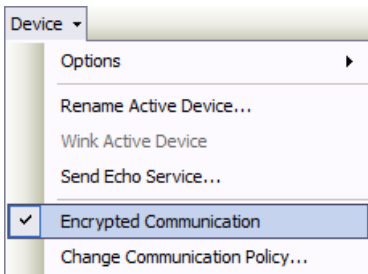

If "Encrypted Communication" is selected, the connection lines between the integrated development environment, gateway, and controller will be displayed in yellow.

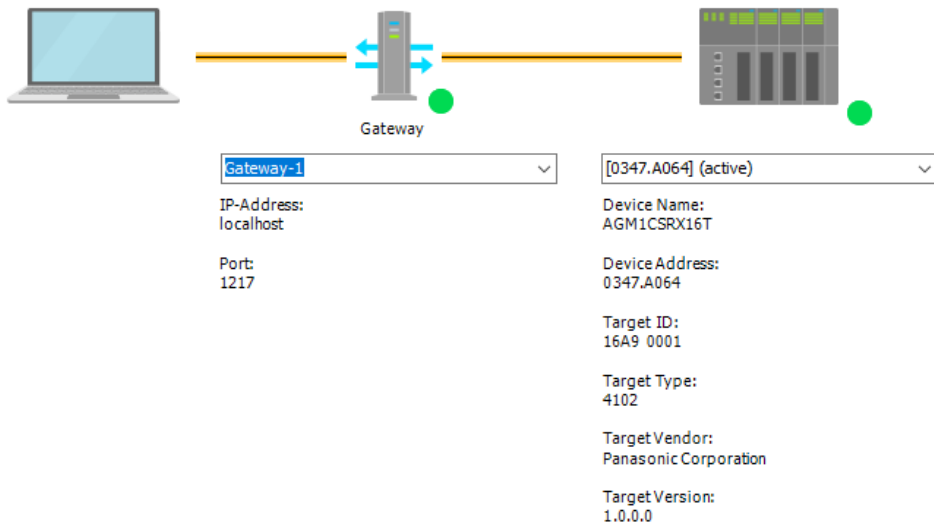

- Click the Network Scan menu.
The "Select Device" dialog box will be displayed.

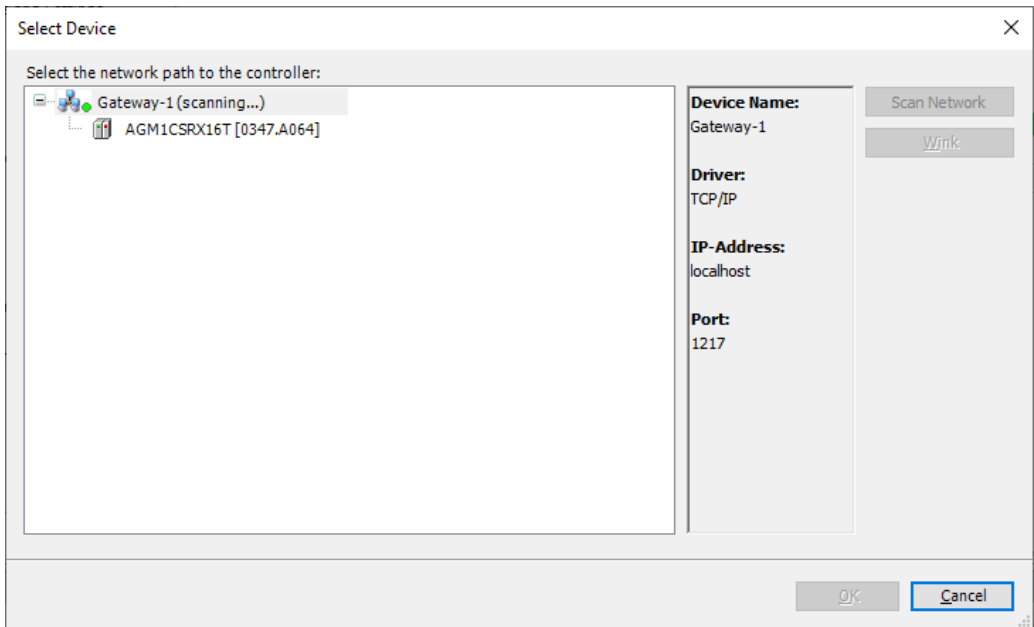

- Select the connected GM1 controller and click the [OK] button.
A message window will be displayed, indicating that the certificate of the GM1 controller is not certified with a trusted signature for encrypted communication.
- If the [OK] button is clicked, communications can be encrypted by installing the certificate indicated by the message in local store "Controller Certificates" on the PC to use it as a trusted certificate.
You can check the registered controller certificate in certmgr.msc in the C:\Windows\System32 folder.

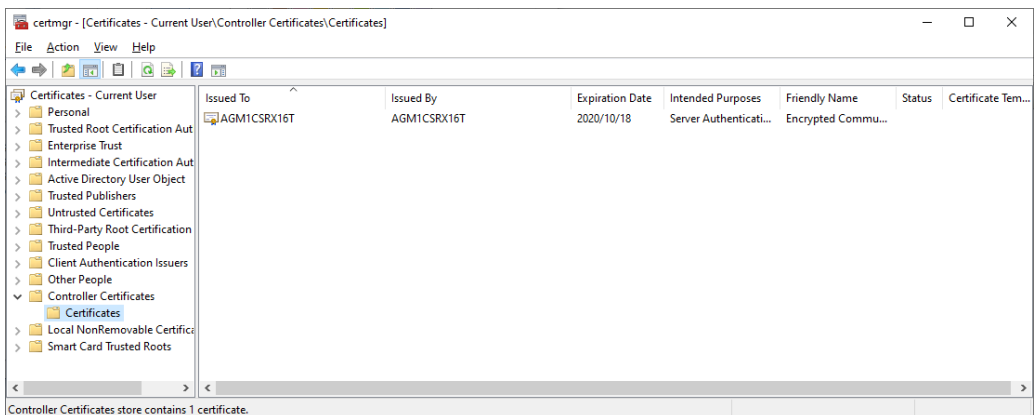

When the certificate of the GM1 controller is used as a trusted certificate, the validity period of the certificate is 30 days.

14.1 Security Function

i Info.

- If the certificate has already expired, the message window shown in step 4 above will be displayed, indicating that the certificate has expired.
By clicking the [OK] button, you can extend the validity period of the certificate.

Encrypting the Communication Path: Encrypting Communications Using a Created Certificate

Communications between GM Programmer and the GM1 controller can be encrypted using certificates.

This section explains how to create a trusted certificate for the GM1 controller and encrypt communications using the created certificate.

1 2 Procedure

1. Open the device editor and select the "PLC Shell" tab.

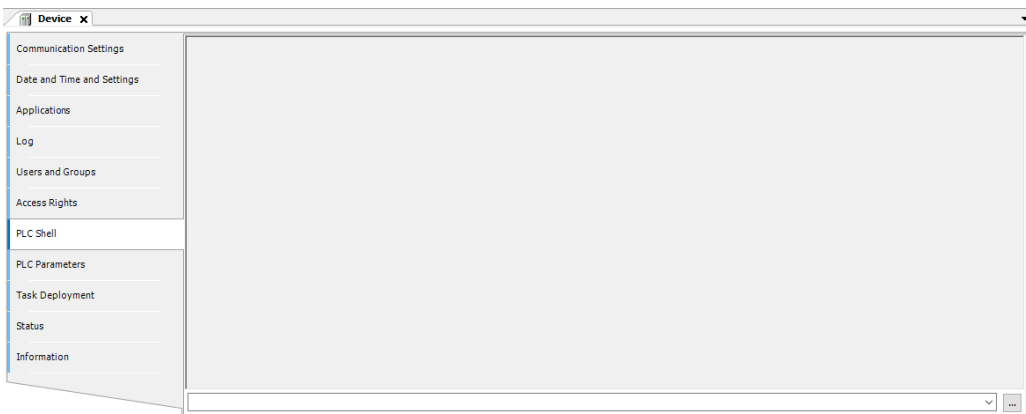

2. Enter the "cert-getapplist" command in the input field.
All certificates that are used will be displayed.

```
cert-getapplist
```

Nr.	ComponentName Thumbprint	CommonName	CertAvailable	DateNotBefore	DateNotAft
0	CmpWebServer	buildroot	FALSE	--	--
1	CmpSecureChannel e8e28f5bc7517f2885bd5d57e052ff961bf7d853	AGM1CSRX16T1_Test	TRUE	2019-4-7T0:8:2.0	2019-5-7T0:8:2.0
2	CmpApp	AGM1CSRX16T1_Test	FALSE	--	--

3. Enter the "cert-genselfsigned 1" command in the input field.
Create a certificate for ComponentName "CmpSecureChannel".

```
cert-genselfsigned 1  
Generate selfsigned certificate with given index (1). Check logger to see when finished.
```

4. Open the "Log" tab of the device editor and click the [Update Information] button.
Check whether a certificate has been created.

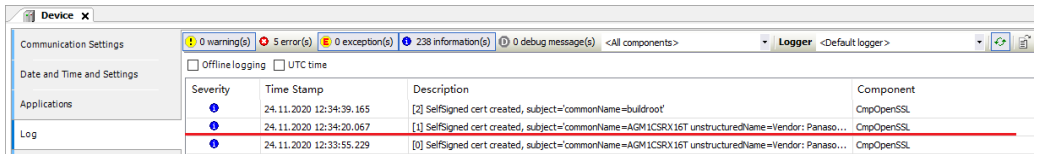

- In the device editor, open the "PLC Shell" tab and enter the "cert-getapplist" command in the input field.
Check whether a certificate has been created for ComponentName "CmpSecureChannel".

```
cert-getapplist
```

Nr.	ComponentName Thumbprint	CommonName	CertAvailable	DateNotBefore	DateNotAfter
0	CmpWebServer	buildroot	FALSE	--	--
1	CmpSecureChannel e8e78074837da953e41b594b82d88ae6bcf9bc9bad	AGM1CSRX16T1_Test	TRUE	2019-4-7T0:43:37.0	2020-4-6T0:43:37.0
2	CmpApp	AGM1CSRX16T1_Test	FALSE	--	--

- Open the device editor and select the "Communication Settings" tab.

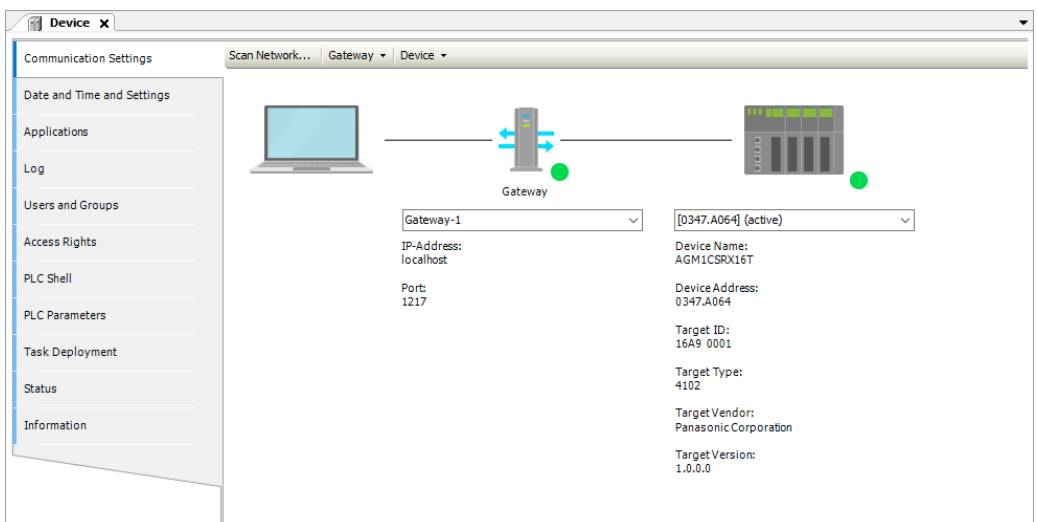

- In the Device menu, select "Encrypted Communication".

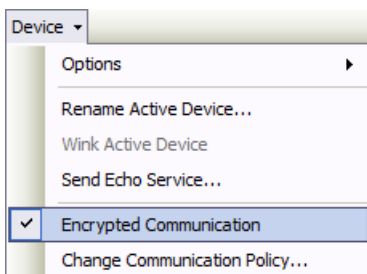

If "Encrypted Communication" is selected, the connection lines between the integrated development environment, gateway, and controller will be displayed in yellow.

14.1 Security Function

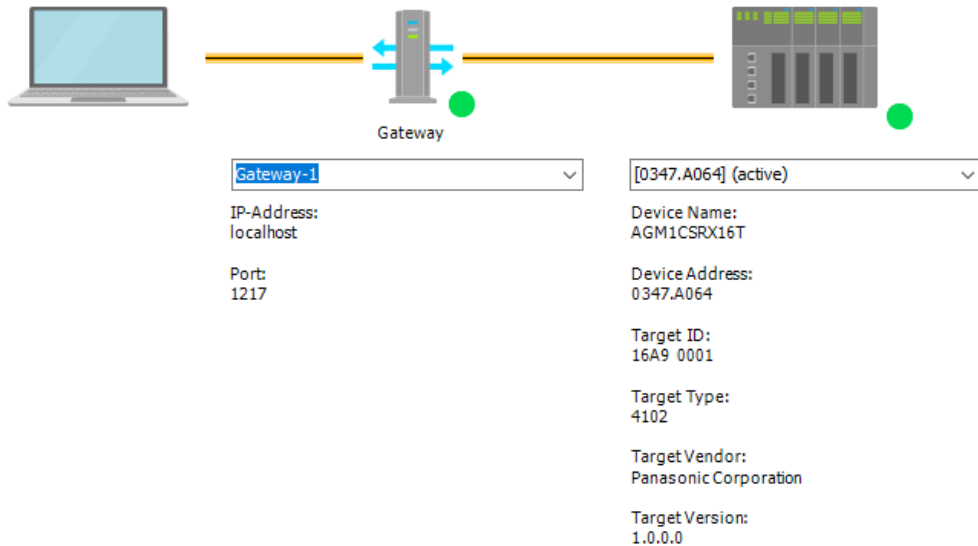

8. Click the Network Scan menu.
The "Select Device" dialog box will be displayed.

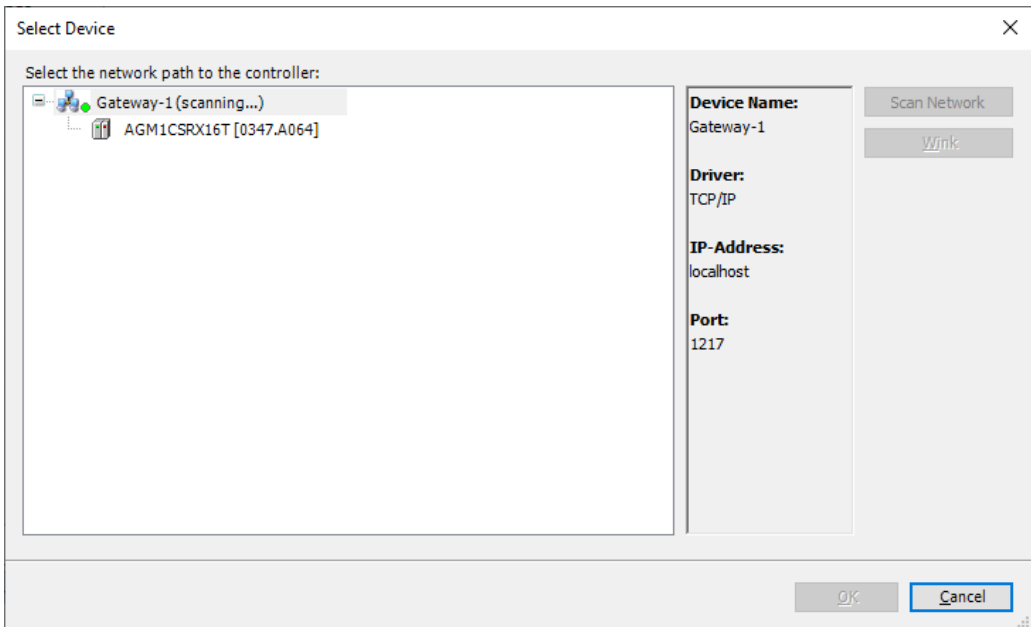

9. Select the connected GM1 controller and click the [OK] button.
A message window will be displayed, indicating that the certificate of the GM1 controller is not certified with a trusted signature for encrypted communication.

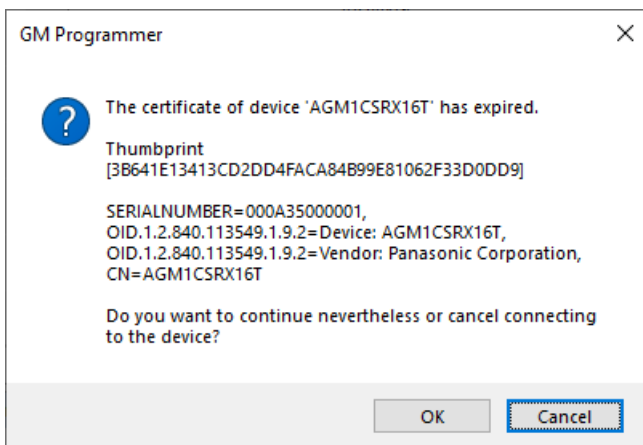

10. If the [OK] button is clicked, communications can be encrypted by installing the certificate indicated by the message in local store "Controller Certificates" on the PC to use it as a trusted certificate.

You can check the registered controller certificate in certmgr.msc in the C:\Windows\System32 folder.

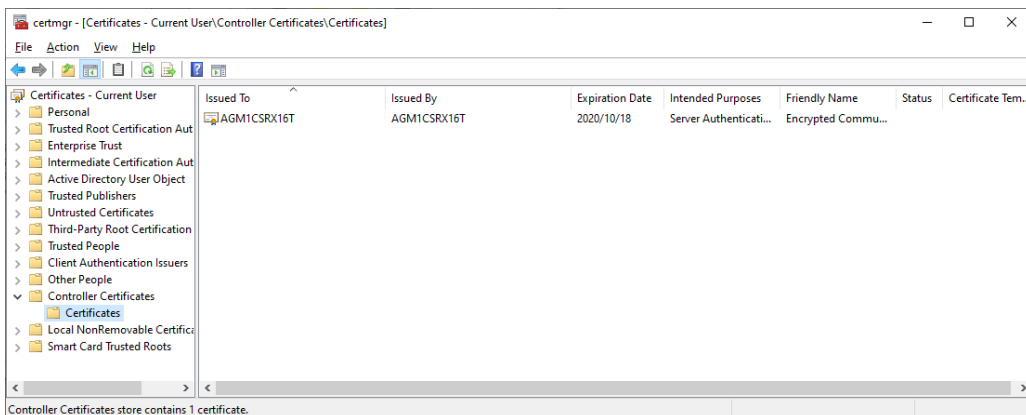

When the created certificate is used as a trusted certificate, the validity period of the certificate is 360 days.

14.1 Security Function

14.1.3 Write-protection

This section explains how to implement write-protection for project files to prevent project files from being modified unintentionally by mistake.

Opening Files in Read-only Mode

Open a project file in read-only mode.

When selecting a project file to be opened, select the "Open in Read-only Mode" check box.



If a file is opened in read-only mode, it cannot be saved.

To save a project file, select "Project file cannot be saved. Click for options" on the menu bar and select an appropriate menu item that is displayed.

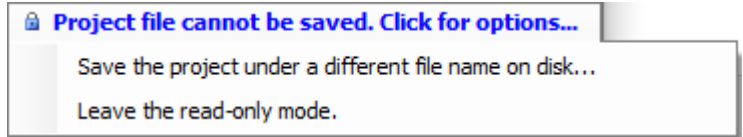

Item	Description
Save the project under a different file name on disk...	Allows the user to rename and save the project file as a writable file.
Leave the read-only mode	Leaves the project file open in read-only mode.

Setting the "Released" Flag

Set a "released" flag in project information in a project file.

If a "released" flag is set in a project file, changes made in the file cannot be saved.

From the menu bar, select **Project>Project Information**, and open the "Summary" tab window and then select the "Released" check box.

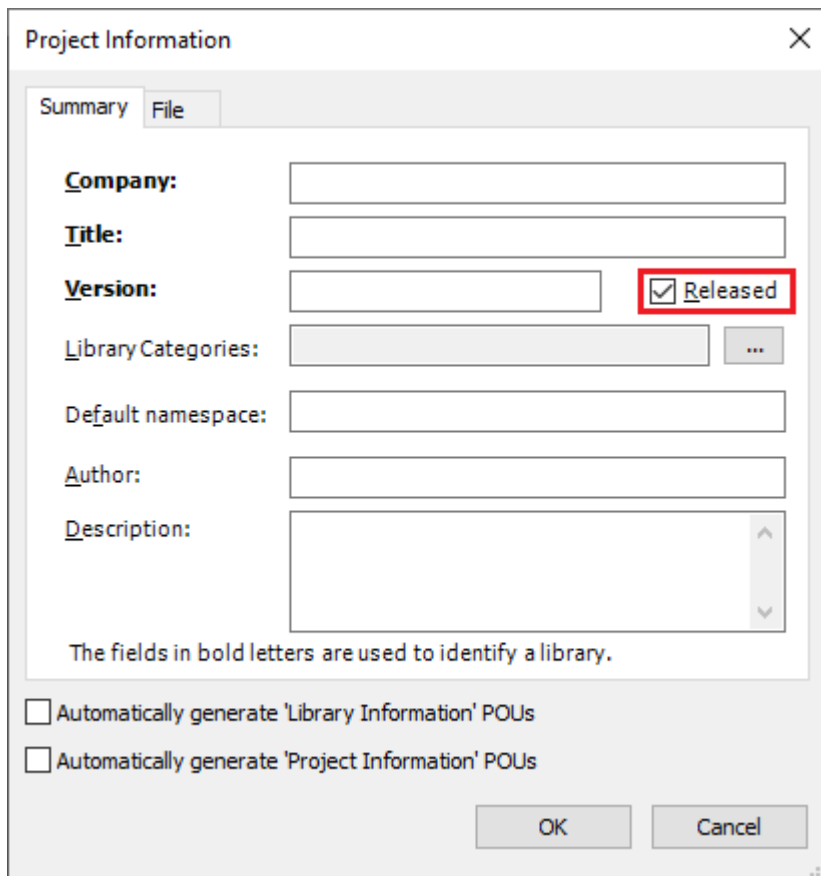

The screenshot shows the "Project Information" dialog box with the "Summary" tab selected. The "Released" checkbox is checked and highlighted with a red box. The fields "Company:", "Title:", "Version:", and "Description:" are in bold letters, indicating they are used to identify a library. The "Library Categories:" field has a dropdown menu with a "..." button. The "Default namespace:" and "Author:" fields are empty. The "Description:" field is a text area with a scroll bar. At the bottom, there are two unchecked checkboxes: "Automatically generate 'Library Information' POU's" and "Automatically generate 'Project Information' POU's". The "OK" and "Cancel" buttons are at the bottom right.

To save a project file in which the "Released" flag is set, select "Project file cannot be saved. Click for options" on the menu bar and select a menu item that is displayed.

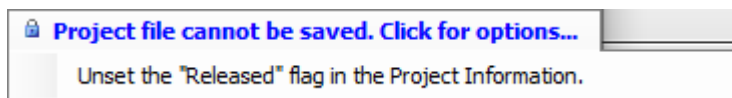

14.2 Interface Function

The interface object defines common methods and properties that are used between different function blocks in the same way.

The interface object is one of the means of implementing object-oriented programming.

The interface object contains only method and property declarations but does not contain implementation.

14.2.1 Setting up an Interface Object

This section explains how to add an interface object.

1 2 Procedure

1. Right-click the "Application" object in the navigator pane and then select **Add Object>Interface** from the context-sensitive menu that is displayed.

The "Add Interface" dialog box will be displayed.

The screenshot shows the "Add Interface" dialog box. It has a title bar with the text "Add Interface" and a close button (X). Below the title bar, there is a key icon and the text "Create a new interface". The dialog is divided into sections. The first section is labeled "Name" and contains a text input field with the text "ITF". The second section is labeled "Inheritance" and contains a checkbox labeled "Extends" and an empty text input field with a dropdown arrow. At the bottom of the dialog, there are two buttons: "Add" and "Cancel".

2. Enter a name and click the [Add] button.
An interface object will be added.
If the "Extends" check box is selected, the interface entered in the input field can be inherited and extended.

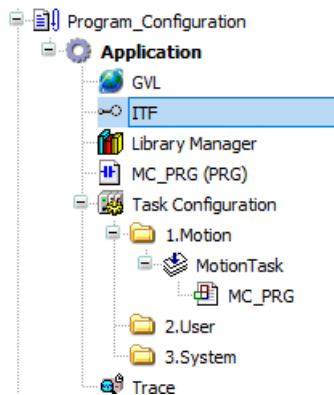

- Right-click the "ITF" object added to the navigator pane and then select **Add Object>Interface property** or **method** from the context-sensitive menu that is displayed. The "Add Interface property" dialog box or "Add Interface method" dialog box will be displayed.

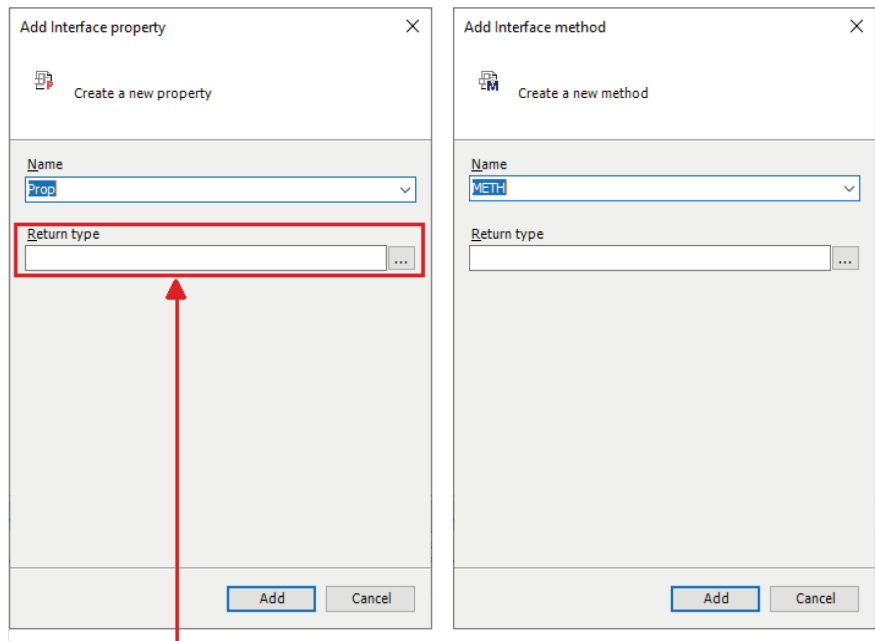

* For interface properties, the data type of return values must be entered.

- Enter a name and click the [Add] button. For interface properties, be sure to enter a value in the "Return type" field. "Prop" or "METH" object will be added under the "ITF" object.

14.2 Interface Function

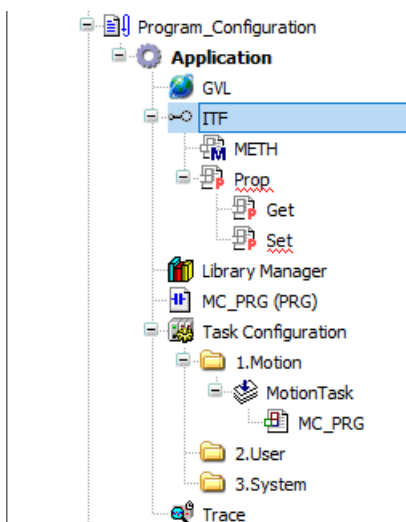

5. The added "METH" and "Prop" objects are used to define methods and properties, respectively.

This completes the procedure for creating an interface object.

14.2.2 Implementing in New Function Block

This section explains how to implement an interface in a new function block to be created.

1 2 Procedure

1. Right-click the "Application" object in the navigator pane and then select **Add Object>POU** from the context-sensitive menu that is displayed.
The "Add POU" dialog box will be displayed.

The screenshot shows the "Add POU" dialog box. The "Name" field contains "SAMPLE_FB". Under the "Type" section, the "Function block" radio button is selected. The "Implements" checkbox is checked, and the text "ITF" is entered in the field next to it. The "Access specifier" is set to a dropdown menu, and the "Method implementation language" is set to "Structured Text (ST)". The "Function" section is unselected. At the bottom, there are "Add" and "Cancel" buttons.

2. Enter a name. In the Type section, select the Function block option, select the "Implements" check box, and enter an interface to be implemented. Click the [Add] button.
A function block with the interface implemented will be added under the "Application" object.

14.2 Interface Function

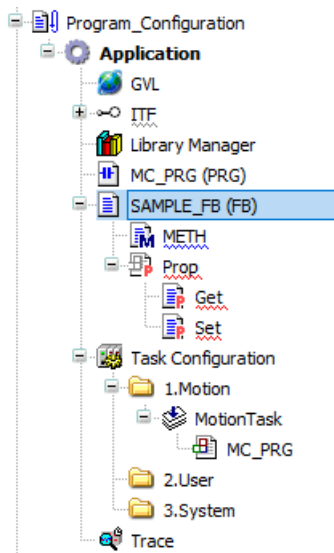

3. Open the respective editors for the added "METH" and "Prop" objects, and implement internal processing for the methods and properties.

Note

- If methods and properties are added under the "interface" object later, they will not be automatically added to the function block with the interface implemented. Therefore, if they need to be added, perform the procedure starting from "Step 3" 3 in "14.2.3 Implementing in Existing Function Block".

14.2.3 Implementing in Existing Function Block

This section explains how to implement an interface in an existing function block.

1 2 Procedure

1. Open the editor of the existing function block from the navigator pane.

Character string format

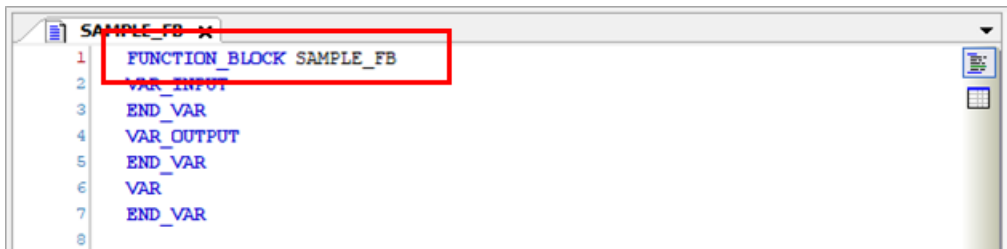
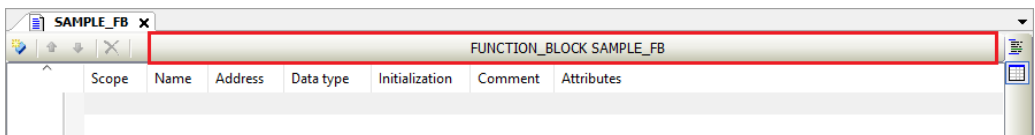

Table format



2. For character string format, add "IMPLEMENTS <interface name>" to the declaration header section. For table format, open the "Edit Declaration Header" dialog box, enter an interface name in the "IMPLEMENTS" field, and click the [OK] button.

Character string format

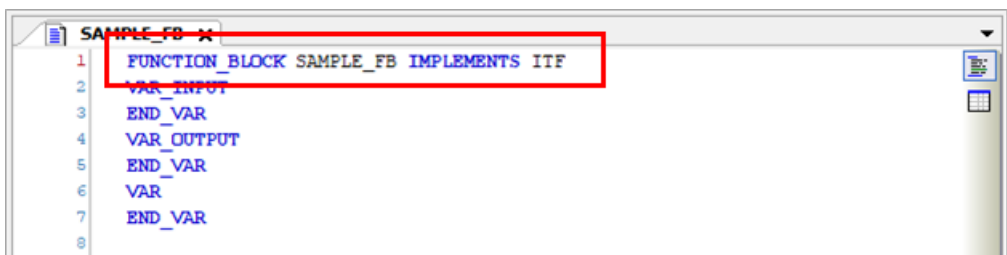
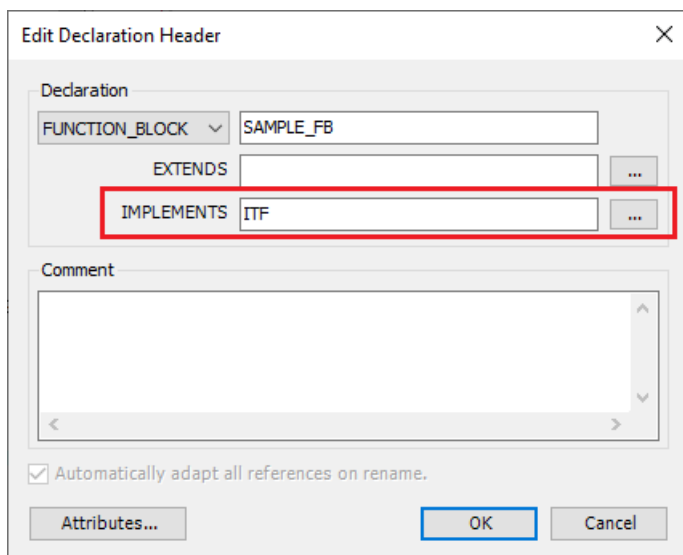
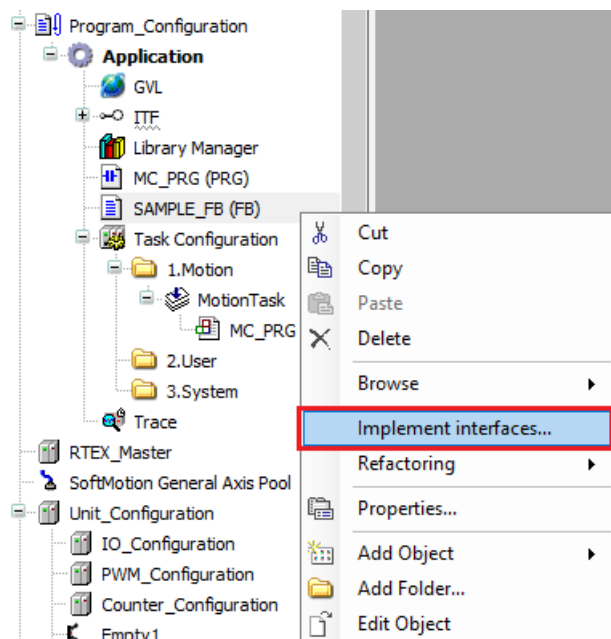
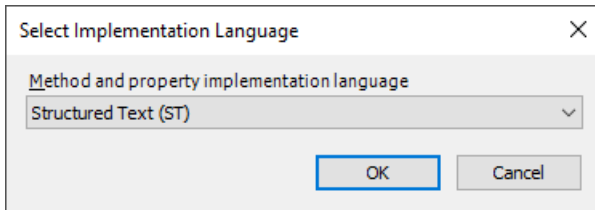

Table format



3. Right-click the existing function block in the navigator pane and select "Implement Interfaces" from the context-sensitive menu that is displayed. The "Select implementation language" dialog box will be displayed.





4. Select a desired programming language and click the [OK] button. The method and property objects will be added under the function block object.

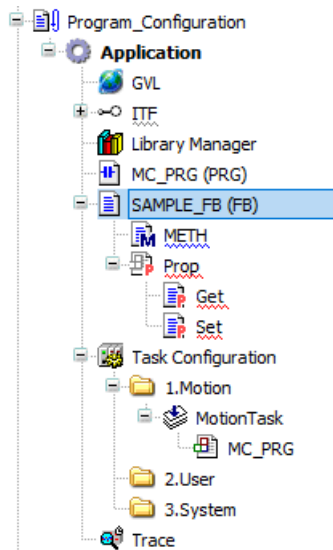

5. Open the respective editors for the added "METH" and "Prop" objects, and implement internal processing for the methods and properties.

Note

- If methods and properties are added under the "interface" object later, they will not be automatically added to the function block with the interface implemented. Therefore, if they need to be added, perform the procedure starting from Step "Step 3".

14.2 Interface Function

Info.

- When methods and properties are implemented, warning messages are automatically implemented. Therefore, when compilation is executed, the following warning messages are displayed.

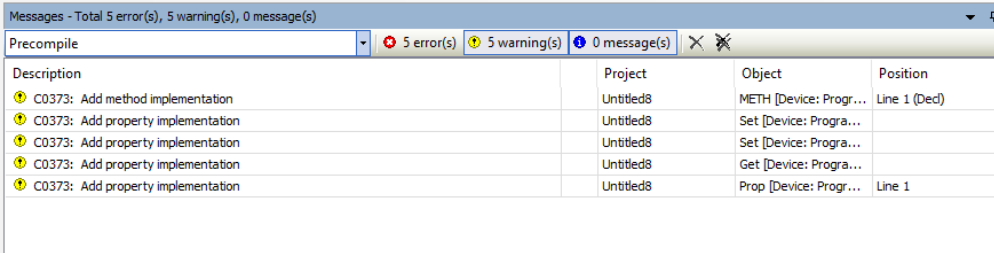

The screenshot shows a 'Messages' window with a title bar indicating '5 error(s)', '5 warning(s)', and '0 message(s)'. The window is set to 'Precompile' mode. It contains a table with the following data:

Description	Project	Object	Position
⚠ C0373: Add method implementation	Untitled8	METH [Device: Progr...	Line 1 (Ded)
⚠ C0373: Add property implementation	Untitled8	Set [Device: Progra...	
⚠ C0373: Add property implementation	Untitled8	Set [Device: Progra...	
⚠ C0373: Add property implementation	Untitled8	Get [Device: Progra...	
⚠ C0373: Add property implementation	Untitled8	Prop [Device: Progr...	Line 1

These warning messages do not indicate any problems. However, to prevent particular warning messages from being displayed, from the menu bar, select **Project>Project Settings** and then clear the check boxes of the target warning messages in the Compiler Warnings pane.

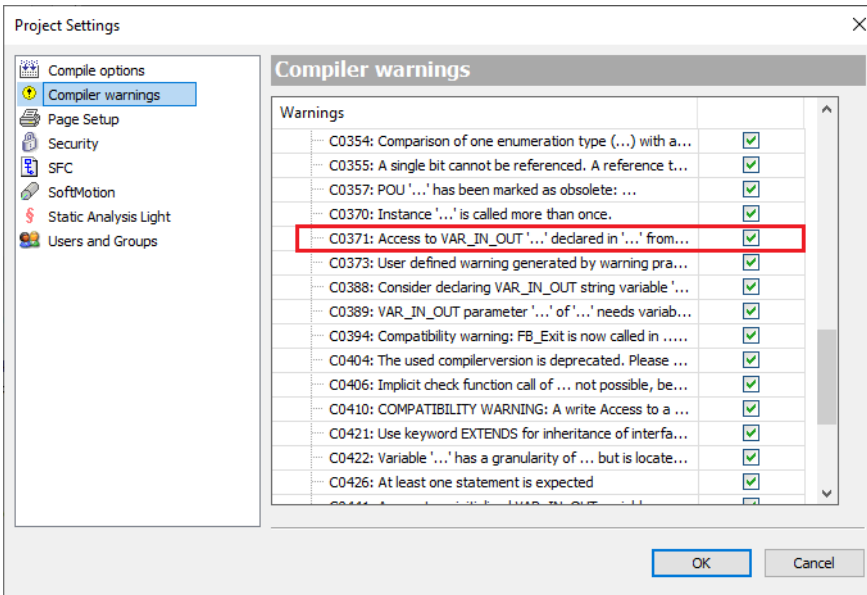

14.2.4 Extending the Interface

Existing interfaces can be inherited and extended.

This section explains how to extend existing interface "ITFBase" and create new interface "ITFExtend".

In this example, when interface "ITFBase" exists, create a new interface as below.

1 2 Procedure

1. Right-click the "Application" object in the navigator pane and then select **Add Object>Interface** from the context-sensitive menu that is displayed.

The "Add Interface" dialog box will be displayed.

The screenshot shows the "Add Interface" dialog box. The "Name" field is filled with "ITFExtend". In the "Inheritance" section, the "Extends" checkbox is checked, and the text field next to it contains "ITFBase". The "Add" button is highlighted in blue.

2. In the "Add Interface" dialog box, select the "Extends" check box and enter an interface to be inherited.

Interface "ITFExtend" will be created.

14.2 Interface Function

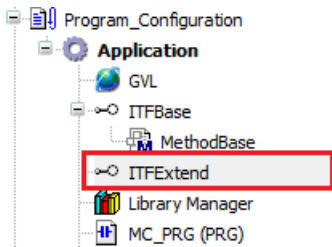

3. Right-click the "ITFExtend" object added to the navigator pane and then select **Add Object>Interface property** or **method** from the context-sensitive menu that is displayed in order to add a property or method for the "ITFExtend" object.
4. Right-click the "Application" object in the navigator pane and then select **Add Object>POU** from the context-sensitive menu that is displayed.
The "Add POU" dialog box will be displayed.

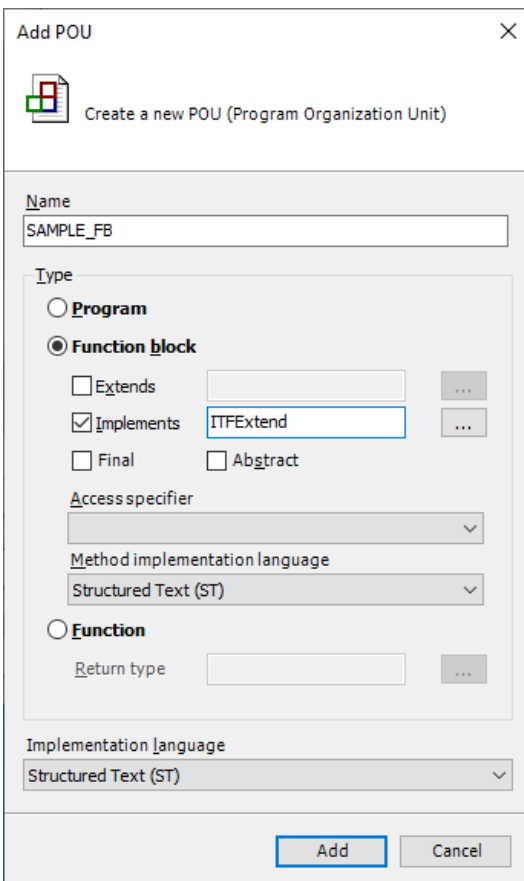

Add POU

Create a new POU (Program Organization Unit)

Name
SAMPLE_FB

Type

Program

Function block

Extends

Implements ITFExtend

Final Abstract

Access specifier

Method implementation language
Structured Text (ST)

Function

Return type

Implementation language
Structured Text (ST)

Add Cancel

5. Enter a name. In the Type section, select the Function block option, select the "Implement" check box, and enter "ITFExtend". Click the [Add] button.
A function block with properties and methods for both interfaces "ITFExtend" and "ITFBase" will be added under the "Application" object.

14.3 SD Card Access Function

14.3.1 Overview of SD Card Access Function

The GM1 controller allows directories and files to be written to and read from the SD card via the CAA File library.

■ Preparation for SD card access

1. Before starting operation using the CAA File library, always use the following function of the Panasonic_GM_System library to check whether the SD card can be accessed.
 - a) `SYS_GetSDAccessRdy`: Reads the mount state of the SD card
 - TRUE: SD card is accessible. An SD card has been inserted.
 - FALSE: SD card is inaccessible. No SD card has been inserted.
2. Considering situations such as removal of the SD card during operation, use the following function to check whether the SD card cover is open or closed.
 - a) `SYS_GetSDCoverState`: Reads the open / closed state of the SD card slot cover
 - TRUE: The SD card slot cover is closed.
 - FALSE: The SD card slot cover is open.

When the SD card slot cover is open, the SD card can be removed safely by stopping processing such as writing or reading directories or files using the CAA File library.

The screenshot shows a software development environment window titled 'MC_PRG x'. Below the title bar, there is a header 'Device.Application.MC_PRG'. A table displays variable declarations:

Expression	Type	Value	Prepared value	Address	Comment
bMount	BOOL	FALSE			
bCover	BOOL	TRUE			

Below the table, two lines of code are visible:

```

1  bMount FALSE :=SYS_GetSDAccessRdy();
2  bCover TRUE :=SYS_GetSDCoverState():RETURN

```

14.3 SD Card Access Function

14.3.2 File Manipulations Using the CAA File Library

This section explains how to use the CAA File, in the following order.

1 2 Procedure

1. Double-click "Library Manager" in the Navigator window

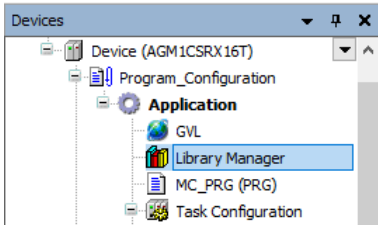

2. Check that the following CAA File library is registered in Library_Manager.

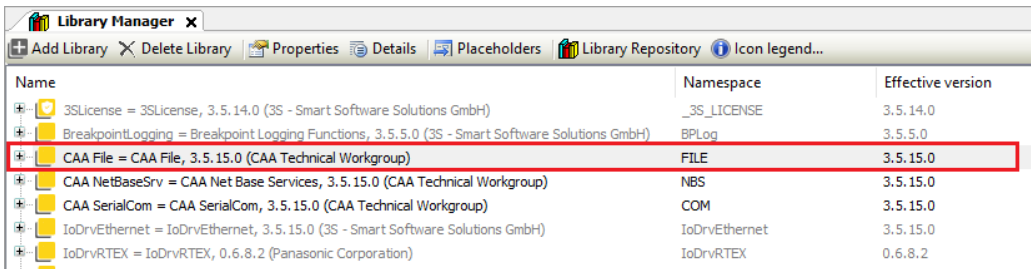
A screenshot of the 'Library Manager' window. It displays a table of registered libraries. The table has three columns: Name, Namespace, and Effective version. The row for 'CAA File = CAA File, 3.5.15.0 (CAA Technical Workgroup)' is highlighted with a red border.

Name	Namespace	Effective version
3SLicense = 3SLicense, 3.5.14.0 (3S - Smart Software Solutions GmbH)	_3S_LICENSE	3.5.14.0
BreakpointLogging = Breakpoint Logging Functions, 3.5.5.0 (3S - Smart Software Solutions GmbH)	BPLog	3.5.5.0
CAA File = CAA File, 3.5.15.0 (CAA Technical Workgroup)	FILE	3.5.15.0
CAA NetBaseSrv = CAA Net Base Services, 3.5.15.0 (CAA Technical Workgroup)	NBS	3.5.15.0
CAA SerialCom = CAA SerialCom, 3.5.15.0 (CAA Technical Workgroup)	COM	3.5.15.0
IoDrvEthernet = IoDrvEthernet, 3.5.15.0 (3S - Smart Software Solutions GmbH)	IoDrvEthernet	3.5.15.0
IoDrvRTEX = IoDrvRTEX, 0.6.8.2 (Panasonic Corporation)	IoDrvRTEX	0.6.8.2

For reference programs, please refer to the *GM1 Series Reference Manual (Instruction)*.

14.4 External File Functions

The external file object allows text files, image files, and other files to be saved in the project.

14.4.1 Setting up an External File Object

This section explains how to add an external file object.

1 2 Procedure

1. Right-click the "Application" object in the navigator pane and then select **Add Object>External File** from the context-sensitive menu that is displayed. The "Add External File" dialog box will be displayed.

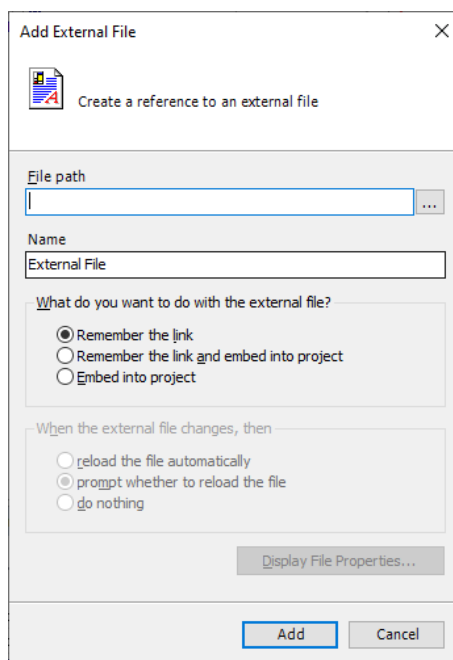

2. In the File path field, specify a file to be registered. In the Name field, enter the name of the file.

In the "What do you want to do with the external file?" section, select an appropriate option as the method for registering the external file in the project.

If you select the "Remember the link and embed into project" option in the "What do you want to do with the external file?" section, select an appropriate option in the "When the external file changes, then" section to specify settings for update processing to be performed when the external file is changed.

"What do you want to do with the external file?":

"Remember the link"

Stores only the path to the file in the project.

If the file does not exist at the link destination, it cannot be used in the project.

14.4 External File Functions

"Remember the link and embed into project"

Saves a copy of the file and a link to the file to the project at the same time.

As long as the file exists at the link destination, the setting of the "When the external file changes, then" section applies.

If the file does not exist, a version of the file that is stored in the project will be used.

"Embed into project"

Saves a copy of the file to the project.

"When the external file changes, then":

"reload the file automatically"

Updates a copy of an external file in the project when the corresponding external file is changed.

"prompt whether to reload the file"

Opens a dialog box, asking whether to update a copy of an external file in the project, when the corresponding external file is changed.

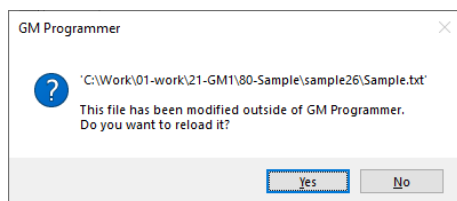

"do nothing"

Does not update a copy of an external file in the project even if the corresponding external file is changed.

3. Click the [Add] button.

The external file will be added under the "Application" object.

i Info.

- When the added external file is opened in GM Programmer, a copy of the file is temporarily created in the following folder:
C:\Users\\AppData\Local\Temp
- Files added as "external file" objects cannot be accessed from programs such as POU.

14.5 Recipe Manager Functions

With the Recipe Manager, you can add recipes and also switch and control the recipe data.

14.5.1 Setting the Recipe Manager

This section explains how to add and set Recipe Manager objects.

1 2 Procedure

1. Right-click the “Application” object in the navigation pane and select **Add Object >Recipe Manager** from the context-sensitive menu that is displayed.
The “Add Recipe Manager” dialog box will be displayed.

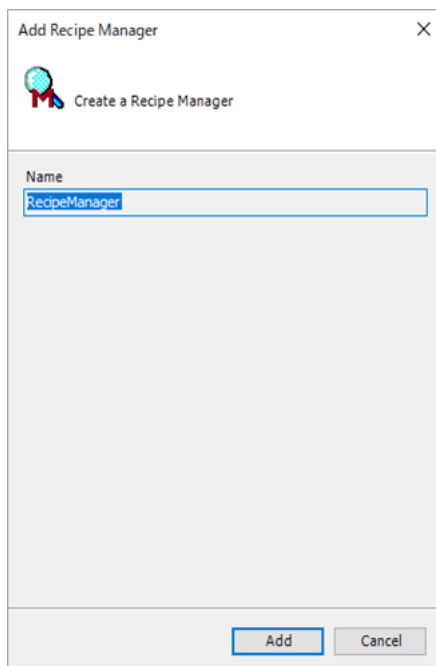

2. Click the [Add] button.
3. The Recipe Manager setting window will be displayed.
The default settings can be used as is. You can also make settings if necessary.
■Storage
It is displayed when you select **Recipe Manager >Storage** tab.

14.5 Recipe Manager Functions

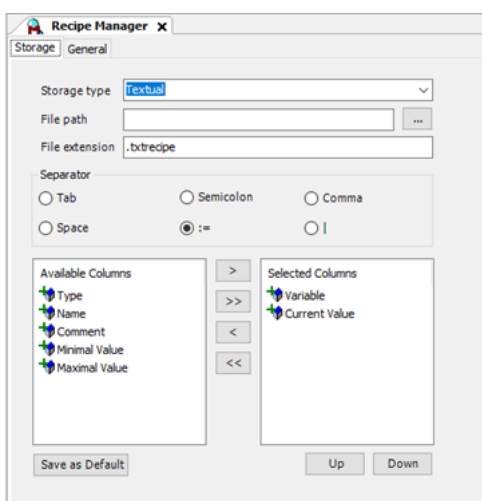

Setting items		Overview
Storage type	Textual	The recipe file is written in text format.
	Binary	The recipe file is written in binary format. Please do not use this setting.
File path		Set the path where you want to save the recipe file. The path that can be specified is under the root directory of the SD card. Examples Recipe ^(Note 1)
File extension		Specify the extension of the recipe file. Possible to set a desired name with up to 10 characters.
Separator	Tab/Semicolon/ Comma/Space/ ":=" / " "	Specify the delimiter within the recipe file. If you do not set the same settings as when saving, it will not be loaded correctly. Ex. Description in the recipe file when ":=" is selected AAA:=1 (Variable := Current Value) BBB:=12 (Variable := Current Value)
Available Columns	Variable Current Value Type Name	It is a list of information that can be described in the recipe file. The information registered in this list is not saved in the recipe file.
Selected digits ^(Note 2) ^(Note 3) ^(Note 4)	Comment Minimal Value Maximal Value	Specifies the information and the order in which it is stored in the recipe file. It will not be loaded correctly unless the settings are the same as when saving. The "Current Value" is always registered.
Save as Default		Please do not use this.

(Note 1) Enter backslash "\" at end of folder.

(Note 2) "Selected Columns" must need "Variable" and "Current Value".

(Note 3) When loading a recipe from the Recipe Manager menu, all items written to the recipe file in the "Selected Columns" setting are loaded into the recipe definition.

(Note 4) When using "Minimal Value" and "Maximal Value", be sure to register both in the "Selected Columns".

■ General

It is displayed when you select **Recipe Manager >General** tab.

For details, refer to the GM1 Series Reference Manual Instruction Edition.

Setting items		Overview
Recipe Management in the PLC		"Save Recipe" setting, "Load Recipe" setting, and instructions by POU are possible.
Save Recipe	Save recipe changes to recipe files automatically	Each recipe set in the recipe definition is automatically saved in the recipe file when you log in to the GM1.
Load Recipe	Load only by exact match of variable list	The recipe value is loaded only if the recipe file contains all the variables in the variable list of the recipe definition and they are listed in the same order as the "Selected Columns".
	Load matching variables by variablename	Only variables with the same name in the recipe file and the recipe definition will be loaded with the recipe value.
Write Recipe	Limit the variable to min/max when recipe value is out of range	When writing the recipe value to the "Current Value", if the value is outside the range of "Minimal Value" / "Maximal Value", the minimal value or maximal value is written.
	Do not write to a variable when the recipe value is out of the min/max range	When writing the recipe value to the "Current Value", if the value is outside the range of the "Minimal Value" / "Maximal Value", the value is not written and the "Current Value" is retained.
Read Recipe	Check recipe for changes	A file check is performed when the ReadAndSaveRecipe method is called. It also enables the

14.5 Recipe Manager Functions

Setting items		Overview
		RecipeManCommands.prvCompareRecipe method. (Note 5)

(Note 1) For details, refer to the GM1 Series Reference Manual (Instruction).

14.5.2 Setting the Recipe Definition

1 2 Procedure

1. Right-click the “Recipe Manager” object and in the navigation pane and select **Add Object>Recipe Definition** from the context-sensitive menu that is displayed.

The “Add Recipe Definition” dialog box will be displayed.

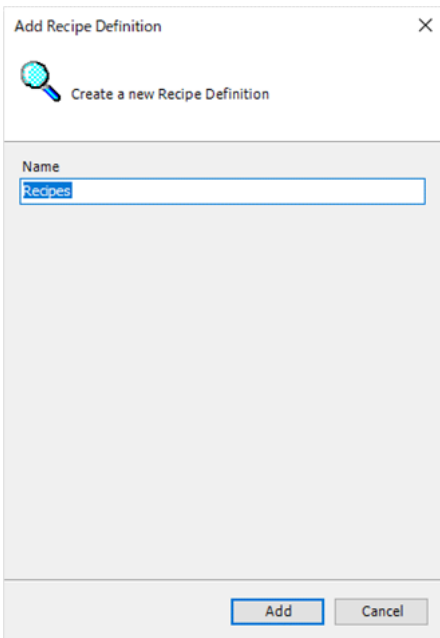

2. Enter a recipe definition name and click the [Add] button.
Possible to set a desired name with up to 35 characters.
3. Move the cursor to below the variable, enter a variable name you want to add to the recipe definition.

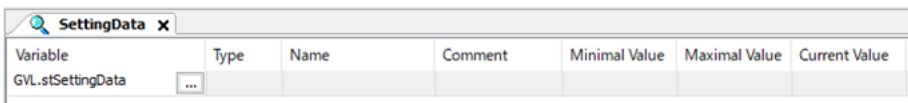

Variable	Type	Name	Comment	Minimal Value	Maximal Value	Current Value
GVL.stSettingData	...					

If you enter an array or structure, a list of developed variables is automatically registered.

However, since it takes time for the development if the number of elements is large, implement this only after saving the project in advance.

Variable	Type	Name	Comment	Minimal Value	Maximal Value	Current Value
GVL.stSettingData.int_val[0]	INT					
GVL.stSettingData.int_val[1]	INT					
GVL.stSettingData.int_val[2]	INT					
GVL.stSettingData.int_val[3]	INT					
GVL.stSettingData.int_val[4]	INT					
GVL.stSettingData.int_val[5]	INT					
GVL.stSettingData.int_val[6]	INT					
GVL.stSettingData.int_val[7]	INT					
GVL.stSettingData.int_val[8]	INT					
GVL.stSettingData.int_val[9]	INT					
GVL.stSettingData.real_val[0]	REAL					
GVL.stSettingData.real_val[1]	REAL					
GVL.stSettingData.real_val[2]	REAL					
GVL.stSettingData.real_val[3]	REAL					
GVL.stSettingData.real_val[4]	REAL					
GVL.stSettingData.real_val[5]	REAL					
GVL.stSettingData.real_val[6]	REAL					
GVL.stSettingData.real_val[7]	REAL					
GVL.stSettingData.real_val[8]	REAL					
GVL.stSettingData.real_val[9]	REAL					

Setting items	Overview
Variable	The variable names registered in the recipe definition are displayed. To add a new variable, double-click the blank field at the bottom and specify the name of the variable you want to register. You can enter variables using the Input Assistant from the [...] button.
Type	The variable type name is displayed. It is automatically entered when the variable is registered.
Name	You can write the name of each variable separately from "Variable".
Comment	You can optionally include additional information about the variable.
Minimal Value / Maximal Value	Specify the minimum and maximum values used in " 14.5.1 Setting the Recipe Manager ". When using, be sure to set all variables for possible variables. If there is an unconfigured variable, it will not function correctly.
Current Value	The current variable value is displayed.

14.5 Recipe Manager Functions

14.5.3 Recipe Operation Using the GM Programmer

12 Procedure

1. After setting the recipe definition in "14.5.2 Setting the Recipe Definition", log in to the GM1 unit and download the settings.
2. In the login state, the current value of the variable registered is displayed in the current value.
3. In the login state, move the cursor to the recipe definition and select "Add New Recipe". The "New Recipe" dialog box will be displayed.

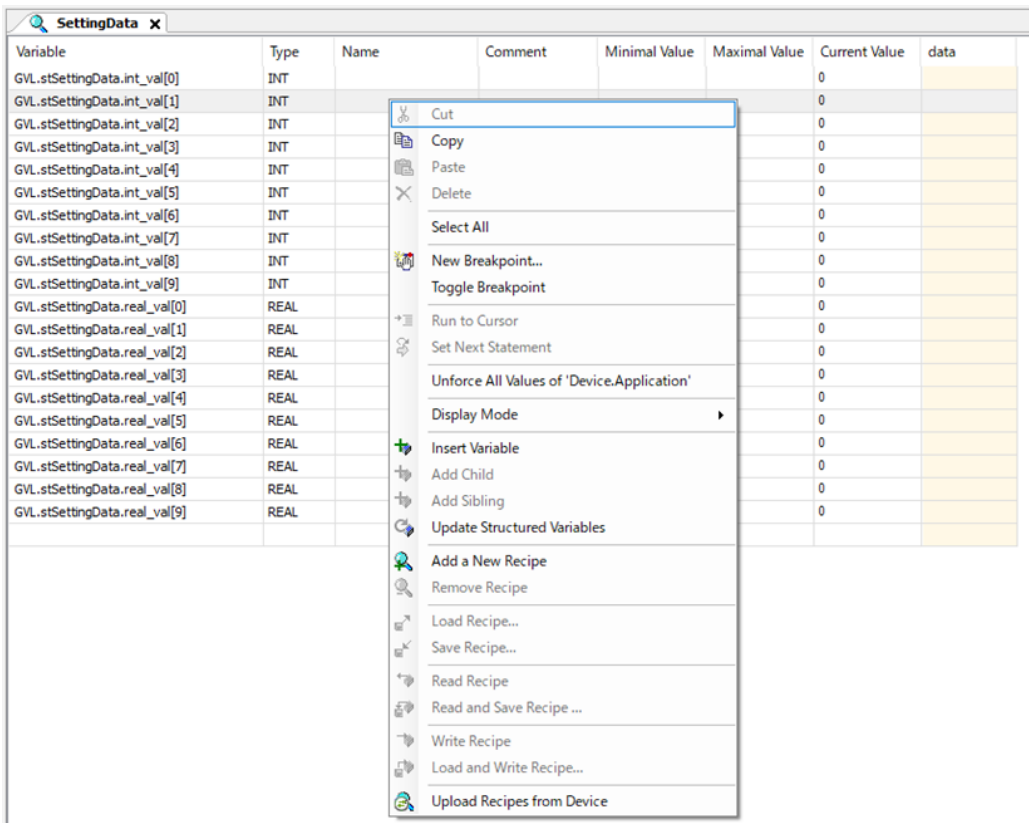

4. Enter a name for the new recipe and select [OK] to add the recipe as show in the above figure.

Possible to set a desired name with up to 35 characters.

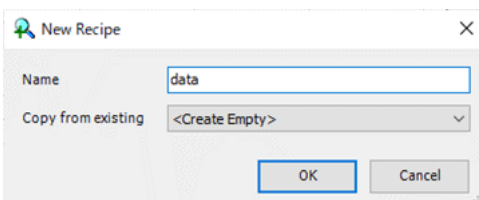

5. Move the cursor to the added recipe and right-click to switch and control the recipe data.

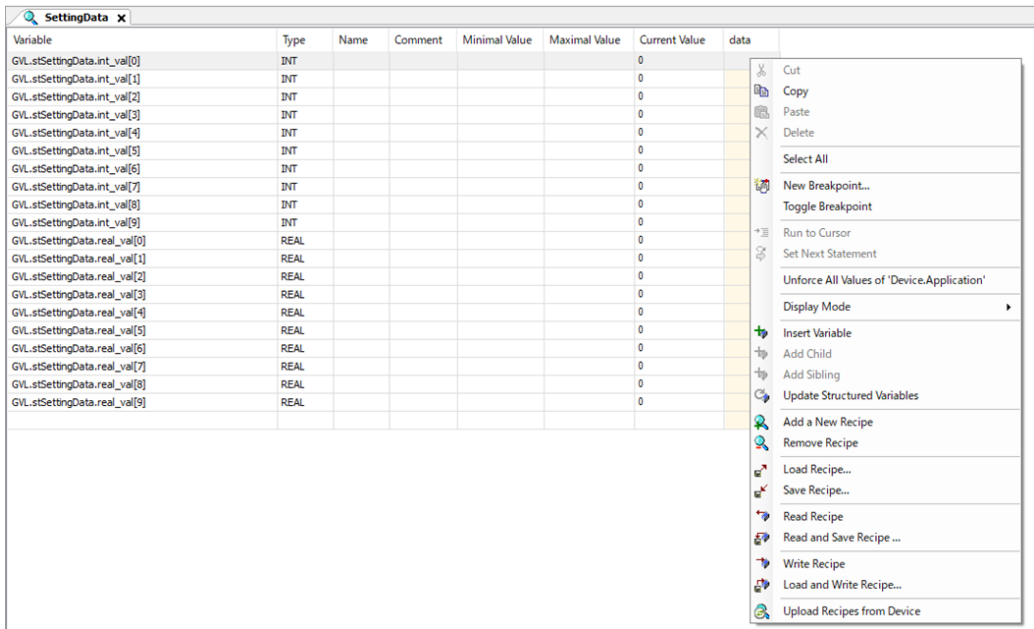

Info.

- The following operations can be performed using the GM Programmer. Items that can be operated are different depending on whether the mode is offline or online. GM Programmer

Item	Offline	Online	Function
Insert Variable	<input type="radio"/>	<input type="radio"/>	Inserts a new variable in the recipe definition.
Add Child	<input type="radio"/>		You can add a child array that can be used in the structured view and that has not been registered in the recipe definition.
Add Sibling	<input type="radio"/>		You can add a brother array that can be used in the structured view and that has not been registered in the recipe definition.
Update Structured variable	<input type="radio"/>	<input type="radio"/>	If there are any items that are not registered in structure, they are reflected on the variable list.
Add a New Recipe	<input type="radio"/>	<input type="radio"/>	Adds a new recipe to the recipe definition.
Remove Recipe	<input type="radio"/>	<input type="radio"/>	Deletes the selected recipe.
Load Recipe	<input type="radio"/>	<input type="radio"/>	Loads the recipe file in the operating PC and write to the selected recipe.
Save Recipe ^(Note 1)	<input type="radio"/>	<input type="radio"/>	Saves the selected recipe in the operating PC as a recipe file.
Read Recipe		<input type="radio"/>	Reads the current value to the recipe data.
Read and Save Recipe		<input type="radio"/>	Reads the current value to the recipe (within the tool) and saves the recipe file in the operating PC.
Write Recipe		<input type="radio"/>	Writes the current value to the recipe data.

14.5 Recipe Manager Functions

Item	Offline	Online	Function
Load and Write Recipe		<input type="radio"/>	Loads data from the recipe file to the recipe (within the tool) and write it in the current value.
Upload Recipes from device		<input type="radio"/>	Reads the recipe within the controller device and reflects it on the recipe within the tool.
Display mode (Decimal/Hexadecimal)		<input type="radio"/>	-

(Note 1) This function cannot be used because REAL data of 7 or more digits and LREAL data of 16 or more digits may not be saved correctly.

- Switch to list view/structured view

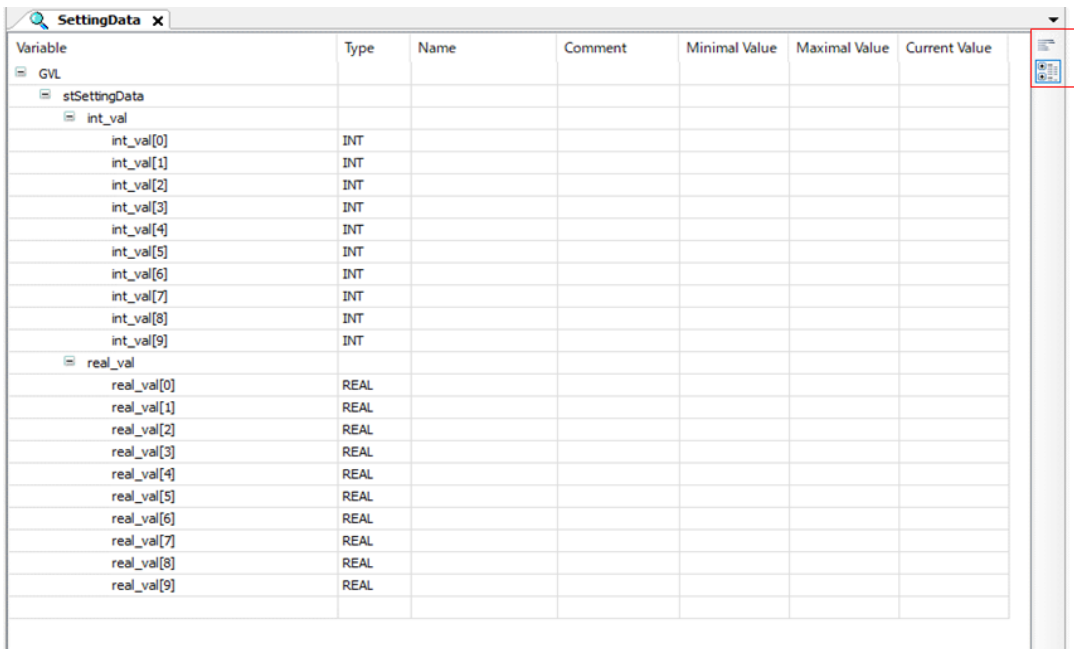

- When you update the structure or global variable list registered in the recipe definition, you can use the "Update Structured Variables" function to update the variable list in the recipe definition.

The following describes how to update a recipe definition when you declare a new variable for a global variable.

* The same operation is performed when the structure is changed or the variable deleted from the declaration is deleted from the recipe definition.

1. Add add_variables to the global variable.

```
{attribute 'qualified_only'}
VAR_GLOBAL
    variables : ARRAY [0..4] OF INT;
    add_variables : ARRAY [0..1] OF LREAL;
END_VAR
```

2. From the Recipe Definition menu, select "Update Structured Variables" and a window appears. Items are displayed in black only if there is a variable that can be added or removed.

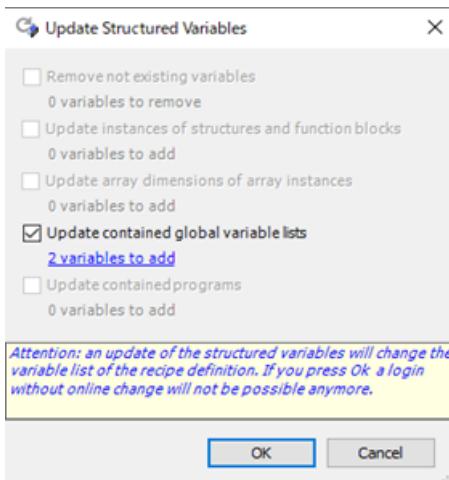

3. Select “2 variables to add” to see the list of variables that will be added to the recipe definition in the update.
All variables in the list are subject to the update and cannot be selected individually.

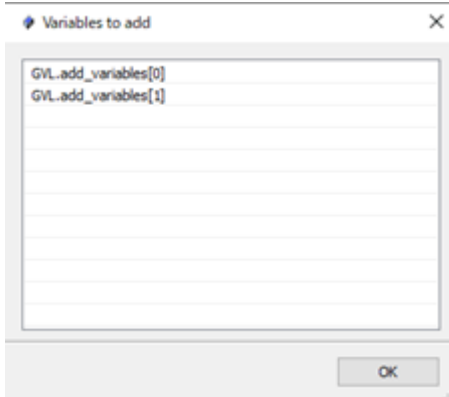

4. Variables are automatically added to the recipe definition by pressing [OK].

Variable	Type	Name	Comment	Minimal Value	Maximal Value	Current Value
GVL.variables[0]	INT					
GVL.variables[1]	INT					
GVL.variables[2]	INT					
GVL.variables[3]	INT					
GVL.variables[4]	INT					
GVL.add_variables[0]	LREAL					
GVL.add_variables[1]	LREAL					

14.5.4 Recipe operation using instructions in the POU

It is also possible to operate a recipe from the recipe method described in the POU without operating the Recipe Manager. For details of each method, refer to the GM1 Series Reference Manual (Instruction Edition).

14.5 Recipe Manager Functions

■Recipe Manager recommended settings

The following are the recommended settings for the Recipe Manager when using instructions in the POU to perform recipe operations.

For details on the effect of changing and executing the settings, refer to the Instructions section.

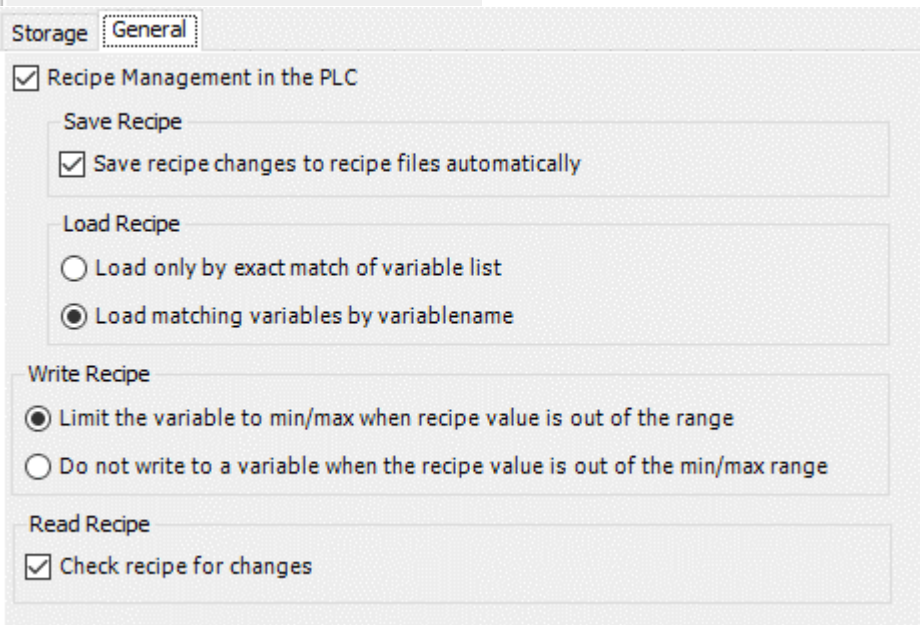
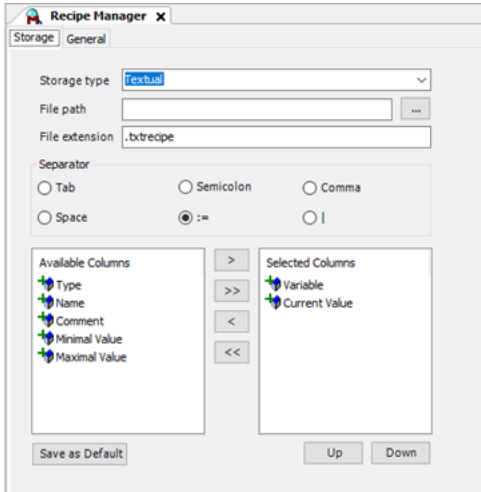

■Recipe command description example

Example 1 Create a new recipe.

Declaration section

```
PROGRAM sample
VAR
  //FB Instance
  RecipeManCommands_0 : RecipeManCommands;
  //Variable
```



```

ERR : BOOL;//ErrorFlag
iRecipeCnt : INT;//Number of recipe
GetRcpNames: DWORD;//Return Value of GetRecipeNames
CreateRcp : DWORD;//Return Value of CreateRecipe
RECIPE_DATA_DEF : STRING := 'Recipes';//Name of Recipe Difinition
RECIPE_NAME : STRING := 'Rcp01';//New Recipe Name
RecipeNames : ARRAY[0..9] OF STRING;//List of getting Recipe
i : INT := 0;//FOR loop counter
iSequence : INT;//SquenceNo.
END_VAR

```

Implement section

```

CASE Process OF
  1:
    //Get the number of recipe files in the SD card
    iRecipeCnt := RecipeManCommands_0.GetRecipeCount(RECIPE_DATA_DEF);
    iSequence := 2;

  2:
    //Get the recipe name if there are recipe files
    IF iRecipeCnt <> 0 THEN
      GetRcpNames:=RecipeManCommands_0.GetRecipeNames(
        RECIPE_DATA_DEF, ADR(RecipeNames), iRecipeCnt, 0);
      iSequence := 3;
    ELSE
      iSequence := 4;
    END_IF

  3:
    //Check if the recipe name is the same as the existing recipe
    FOR i := 0 TO 9 DO
      IF RecipeNames[i] = RECIPE_NAME THEN
        ERR := TRUE;
        RETURN;
      END_IF
    END_FOR
    iSequence := 4;

  4:
    //Create the new recipe
    IF NOT ERR THEN
      CreateRcp := RecipeManCommands_0.CreateRecipe(
        RECIPE_DATA_DEF, RECIPE_NAME);
      iSequence := 0;
    END_IF
END_CASE

```

Example 2 Read the recipe value from the recipe file and write it in the "Current Value"

Declaration section

```

PROGRAM sample
VAR
  //FB Instance
  RecipeManCommands_0 : RecipeManCommands;

```

14.5 Recipe Manager Functions

```
//Variable
ERR                : BOOL;//ErrorFlag
iRecipeCnt        : INT;//Number of recipe
GetRcpNames       : DWORD;//Return Value of GetRecipeNames
LoadFromAndWtRcp  : DWORD;//Return Value of LoadFromAndWriteRecipe
RECIPE_DATA_DEF   : STRING := 'Recipes';//Name of Recipe Difinitio
n
RECIPE_NAME       : STRING := 'Rcp01';//Reading Recipe Name
RECIPE_FILENAME   : STRING;//Reading Recipe file Name
EXTENTION         : STRING := '.txtrecipe';//Extention
RecipeNames       : ARRAY[0..9] OF STRING;//List of getting Recipe
i                 : INT := 0;//FOR loop counter
iSequence         : INT;//SquenceNo.
END_VAR
```

Implement section

```
CASE Process OF
1:
    //Get the number of recipe files in the SD card

    iRecipeCnt := RecipeManCommands_0.GetRecipeCount(RECIPE_DATA_DEF);
    iSequence := 2;

2:
    //Get the recipe name if there are recipe files
    IF iRecipeCnt <> 0 THEN
        GetRcpNames:=RecipeManCommands_0.GetRecipeNames(
            RECIPE_DATA_DEF, ADR(RecipeNames), iRecipeCnt, 0);
        iSequence := 3;
    ELSE
        ERR := TRUE;
    END_IF

3:
    //Check if the recipe name is the same as the existing recipe
    FOR i := 0 TO 9 DO
        IF RecipeNames[i] = RECIPE_NAME THEN
            iSequence := 4;
            EXIT;
        END_IF
    END_FOR
    IF iSequence = 3 THEN
        ERR := TRUE;
    END_IF

4:
    //Read the recipe file and Write the recipe value to current variabl
    e value.
    RECIPE_FILENAME := CONCAT(CONCAT(CONCAT(RECIPE_NAME, '.'),
        RECIPE_DATA_DEF),EXTENTION);
    IF NOT ERR THEN
        LoadFromAndWtRcp := RecipeManCommands_0.LoadFromAndWriteRecipe(
            RECIPE_DATA_DEF, RECIPE_NAME, RECIPE_FILENAME);
    END_IF
    iSequence := 0;
```

END_CASE

14.5.5 Saving and restoring persistent variables

You can save and restore data by automatically creating recipe definitions and recipes from persistent variable lists. If you update a variable that has been registered as a persistent variable, the data held by the persistent variable will be cleared when you download it.

1 2 Procedure

1. After setting the recipe definition in "14.5.2 Setting the Recipe Definition", log in to the GM1 unit and download the settings.
2. While logged in, place the cursor on a variable in the persistent variable list, right-click, and select [Save Current Value to Recipe] from the menu that appears.

Device.Application.PersistentVars					
Expression	Type	Value	Prepared value	Address	Comment
TestParameters_INT	ARRAY [0..19] OF INT				
TestParameters_INT[0]	INT	0			
TestParameters_INT[1]	INT	1			
TestParameters_INT[2]	INT	2			
TestParameters_INT[3]	INT	3			
TestParameters_INT[4]	INT	4			
TestParameters_INT[5]	INT	5			
TestParameters_INT[6]	INT	6			
TestParameters_INT[7]	INT	7			
TestParameters_INT[8]	INT	8			
TestParameters_INT[9]	INT	9			
TestParameters_INT[10]	INT	10			
TestParameters_INT[11]	INT	11			
TestParameters_INT[12]	INT	12			
TestParameters_INT[13]	INT	13			
TestParameters_INT[14]	INT	14			
TestParameters_INT[15]	INT	15			
TestParameters_INT[16]	INT	16			
TestParameters_INT[17]	INT	17			
TestParameters_INT[18]	INT	18			
TestParameters_INT[19]	INT	19			
TestBOOL	BOOL	FALSE			
TestName	STRING	'Default'			

3. Recipe Definition PersistentVariables is created and all variables in the persistent variable list are set.
Also, the recipe "PersVars" is created from the current values.

14.5 Recipe Manager Functions

PersistentVariables x							
Changed recipe definition configuration will be transferred with the next download or online change							
Variable	Type	Name	Comment	Minimal Value	Maximal Value	Current Value	PersVars
PersistentVars.TestParameters_INT[0]	INT					0	0
PersistentVars.TestParameters_INT[1]	INT					1	1
PersistentVars.TestParameters_INT[2]	INT					2	2
PersistentVars.TestParameters_INT[3]	INT					3	3
PersistentVars.TestParameters_INT[4]	INT					4	4
PersistentVars.TestParameters_INT[5]	INT					5	5
PersistentVars.TestParameters_INT[6]	INT					6	6
PersistentVars.TestParameters_INT[7]	INT					7	7
PersistentVars.TestParameters_INT[8]	INT					8	8
PersistentVars.TestParameters_INT[9]	INT					9	9
PersistentVars.TestParameters_INT[10]	INT					10	10
PersistentVars.TestParameters_INT[11]	INT					11	11
PersistentVars.TestParameters_INT[12]	INT					12	12
PersistentVars.TestParameters_INT[13]	INT					13	13
PersistentVars.TestParameters_INT[14]	INT					14	14
PersistentVars.TestParameters_INT[15]	INT					15	15
PersistentVars.TestParameters_INT[16]	INT					16	16
PersistentVars.TestParameters_INT[17]	INT					17	17
PersistentVars.TestParameters_INT[18]	INT					18	18
PersistentVars.TestParameters_INT[19]	INT					19	19
PersistentVars.TestBOOL	BOOL					FALSE	FALSE
PersistentVars.TestName	STRING					'Default'	'Default'

4. If you place the cursor on a variable in the Persistent Variables list, right-click, and select [Restore Values from Recipe] from the menu that appears, the values currently set for Recipe PersVars are reflected in the Persistent Variables list.

14.5 Recipe Manager Functions

Changed recipe definition configuration will be transferred with the next download or online change

Variable	Type	Name	Comment	Minimal Value	Maximal Value	Current Value	PersVars
PersistentVars.TestParameters_INT[0]	INT			0	0	0	
PersistentVars.TestParameters_INT[1]	INT			1	1	1	
PersistentVars.TestParameters_INT[2]	INT			2	2	2	
PersistentVars.TestParameters_INT[3]	INT			3	3	3	
PersistentVars.TestParameters_INT[4]	INT			4	4	4	
PersistentVars.TestParameters_INT[5]	INT			5	5	5	
PersistentVars.TestParameters_INT[6]	INT			6	6	6	
PersistentVars.TestParameters_INT[7]	INT			7	7	7	
PersistentVars.TestParameters_INT[8]	INT			8	8	8	
PersistentVars.TestParameters_INT[9]	INT			9	9	9	
PersistentVars.TestParameters_INT[10]	INT			10	10	10	
PersistentVars.TestParameters_INT[11]	INT			11	11	11	
PersistentVars.TestParameters_INT[12]	INT			12	12	12	
PersistentVars.TestParameters_INT[13]	INT			13	13	13	
PersistentVars.TestParameters_INT[14]	INT			14	14	14	
PersistentVars.TestParameters_INT[15]	INT			15	15	15	
PersistentVars.TestParameters_INT[16]	INT			16	16	16	
PersistentVars.TestParameters_INT[17]	INT			17	17	17	
PersistentVars.TestParameters_INT[18]	INT			18	18	18	
PersistentVars.TestParameters_INT[19]	INT			19	19	19	
PersistentVars.TestBOOL	BOOL					FALSE	
PersistentVars.TestName	STRING					Default	Default

Device: Application: PersistentVars

Expression	Type	Value	Prepared value	Address	Comment
TestParameters_INT	ARRAY [0..19] OF INT				
TestParameters_INT[0]	INT	0			
TestParameters_INT[1]	INT	1			
TestParameters_INT[2]	INT	2			
TestParameters_INT[3]	INT	3			
TestParameters_INT[4]	INT	4			
TestParameters_INT[5]	INT	5			
TestParameters_INT[6]	INT	6			
TestParameters_INT[7]	INT	7			
TestParameters_INT[8]	INT	8			
TestParameters_INT[9]	INT	9			
TestParameters_INT[10]	INT	10			
TestParameters_INT[11]	INT	11			
TestParameters_INT[12]	INT	12			
TestParameters_INT[13]	INT	13			
TestParameters_INT[14]	INT	14			
TestParameters_INT[15]	INT	15			
TestParameters_INT[16]	INT	16			
TestParameters_INT[17]	INT	17			
TestParameters_INT[18]	INT	18			
TestParameters_INT[19]	INT	19			
TestBOOL	BOOL	FALSE			
TestName	STRING	Default			



Changed recipe definition configuration will be transferred with the next download or online change

Variable	Type	Name	Comment	Minimal Value	Maximal Value	Current Value	PersVars
PersistentVars.TestParameters_INT[0]	INT			0	0	0	
PersistentVars.TestParameters_INT[1]	INT			1	1	1	
PersistentVars.TestParameters_INT[2]	INT			2	2	2	
PersistentVars.TestParameters_INT[3]	INT			3	3	3	
PersistentVars.TestParameters_INT[4]	INT			4	4	4	
PersistentVars.TestParameters_INT[5]	INT			5	5	5	
PersistentVars.TestParameters_INT[6]	INT			6	6	6	
PersistentVars.TestParameters_INT[7]	INT			7	7	7	
PersistentVars.TestParameters_INT[8]	INT			8	8	8	
PersistentVars.TestParameters_INT[9]	INT			9	9	9	
PersistentVars.TestParameters_INT[10]	INT			10	10	10	
PersistentVars.TestParameters_INT[11]	INT			11	11	11	
PersistentVars.TestParameters_INT[12]	INT			12	12	12	
PersistentVars.TestParameters_INT[13]	INT			13	13	13	
PersistentVars.TestParameters_INT[14]	INT			14	14	14	
PersistentVars.TestParameters_INT[15]	INT			15	15	15	
PersistentVars.TestParameters_INT[16]	INT			16	16	16	
PersistentVars.TestParameters_INT[17]	INT			17	17	17	
PersistentVars.TestParameters_INT[18]	INT			18	18	18	
PersistentVars.TestParameters_INT[19]	INT			19	19	19	
PersistentVars.TestBOOL	BOOL					FALSE	
PersistentVars.TestName	STRING					Default	Default

Device: Application: PersistentVars

Expression	Type	Value	Prepared value	Address	Comment
TestParameters_INT	ARRAY [0..19] OF INT				
TestParameters_INT[0]	INT	0			
TestParameters_INT[1]	INT	1			
TestParameters_INT[2]	INT	2			
TestParameters_INT[3]	INT	3			
TestParameters_INT[4]	INT	4			
TestParameters_INT[5]	INT	5			
TestParameters_INT[6]	INT	6			
TestParameters_INT[7]	INT	7			
TestParameters_INT[8]	INT	8			
TestParameters_INT[9]	INT	9			
TestParameters_INT[10]	INT	10			
TestParameters_INT[11]	INT	11			
TestParameters_INT[12]	INT	12			
TestParameters_INT[13]	INT	13			
TestParameters_INT[14]	INT	14			
TestParameters_INT[15]	INT	15			
TestParameters_INT[16]	INT	16			
TestParameters_INT[17]	INT	17			
TestParameters_INT[18]	INT	18			
TestParameters_INT[19]	INT	19			
TestBOOL	BOOL	FALSE			
TestName	STRING	Default			

Info.

- When the recipe definition "PersistentVariables" was created, it was not downloaded into the GM1 itself.
To use the Recipe Manager function block or to automatically create a recipe file on the SD card, log out, log back in to the GM1 unit, and download the project.
- The function to restore values from a recipe is not limited to the persistent variable list, but covers all set values of the recipe "PersVars".
An error occurs if there is no recipe "PersVars" in the recipe definition "PersistentVariables".

14.6 Project Management Function

14.6 Project Management Function

14.6.1 What is Project Management Function?

The backup and restore functions for data of each type in the GM1 controller are called project management functions.

■ Backup function

This is a function used to collectively save data of every type in the GM1 controller to an SD memory card. File data to be saved is called a backup file. This function can be executed by any of two methods: operation by the controller and a function block in a program.

■ Restore function

This is a function used to transfer a backup file in an SD memory card to the GM1 controller. Data of every type in the GM1 controller will be replaced by a backup file. This function can be executed by any of two methods: operation by the controller and a function block in a program.

■ Backup file and restoration configuration file

When the backup function is performed, a backup file and a restoration configuration file are created in a predetermined directory on the SD memory card. These files have roles as shown below.

File name	Description	Backup	Restore
Backup file AUTOEXEC.GM1	Data of every type in the GM1 controller is stored in this file.	Creation	Reference
Restoration configuration file AUTOEXEC.INI	This file is used to specify data subject to restoration. This is text data and thus is editable.	Creation	Reference

■ Each type of settings data subject to backup and restoration

Target data	Backup	Restore
Source file	○	○
External file	○	Selectable ^(Note 1)
Bootstrap application	○	○
RETAIN variable	○	Selectable ^(Note 1)
Network setting	○	Selectable ^(Note 1)
Time zone	○	Selectable ^(Note 1)
Account (device user)	○	○
Certificates	×	×

(Note 1) Whether or not to specify it for a target of restoration can be selected.

■ Method for writing specifications in restoration configuration file

The restoration configuration file is a text file used to specify each type of settings data for a target of restoration when data is restored. The following is an example of specifications written in a restoration configuration file.

```
[AUTOEXEC_OPTION]
    Application_File=yes
    External_File=no
    Retain_File=no
    Network_File=no
    Timezone_File=no
```

Method for specifying each type of settings data

Writing	Description
Application_File	Source file, bootstrap application, and account (device user)
External_File	External file
Retain_File	RETAIN variable
Network_File	Network setting
Timezone_File	Time zone

Method for specifying data for a target of restoration.

Writing	Description
yes	Specify it for a target of restoration
no	Not specify it for a target of restoration

i Info.

- Application_File cannot be excluded from the target of restoration. If it is excluded from the target of restoration, an error occurs.
- In writing, do not use spaces around the equals "=" sign. If there is any single- or double-width space around the equals "=" sign, the type of data is regarded as (no), being excluded from the target of restoration.

14.6 Project Management Function

14.6.2 Backup (Operation by the controller)

This is a function used to collectively save every type of settings data in the GM1 controller to an SD memory card by operating the controller.

To enable this function, open the PLC parameter screen and change project backup of project management setting from "Invalid"→ "Valid". (Refer to "4.3 Setting up the GM1 Controller" for PLC parameter screens)

1 2 Procedure

1. Set the mode switch to STOP.
2. Turn OFF the power to the GM1 controller.
3. Create "AUTO" folder in the root directory of the SD card and empty the folder.
4. Open the cover and insert the SD card into the slot.
5. With the cover left open, turn ON the power to the GM1 controller.
6. When the backup process starts, the STOP lamp starts flashing.
7. When the process is completed normally, the STOP lamp is lit and the ERROR is unlit. If an error occurs, the STOP lamp goes off and the ERROR lamp blinks.
8. Close the cover, set the mode switch to RUN, and turn the controller OFF and then ON, so that the controller returns to the original state.

i Info.

- If there is no "AUTO" empty folder, the bag-up process will not start.
- After the backup process is completed, "AUTOEXEC.GM1" project data and the "AUTOEXEC.INI" configuration file are created in the "AUTO" folder.
- If the "AUTOEXEC.INI" configuration file is already contained in the "AUTO" folder at the time of starting the backup process, the configuration file will remain unchanged.

14.6.3 Restore (Operation by the controller)

This is a function used to transfer a backup file in an SD memory card to the GM1 Controller by operating the controller.

To enable this function, open the PLC parameter screen, select project management setting, and change the project backup and project restore setting from "Invalid"→ "Valid". (Refer to "4.3 Setting up the GM1 Controller" for PLC parameter screens)

1 2 Procedure

1. Set the mode switch to STOP.
2. Turn OFF the power to the GM1 controller.
3. Confirm that the project data "AUTOEXEC.GM1" and the setting file "AUTOEXEC.INI" generated by the backup process are contained in the "AUTO" folder in the SD card.
4. To edit targets to be restored, configure settings by editing the "AUTOEXEC.INI" configuration file.
5. Open the cover and insert the SD card into the slot.
6. With the cover left open, turn ON the power to the GM1 controller.
7. When the restore process starts, the STOP lamp will start blinking.
8. When the process is completed normally, the STOP lamp is lit and the ERROR is unlit. If an error occurs, the STOP lamp goes off and the ERROR lamp blinks.
9. Close the cover, set the mode switch to RUN, and turn the controller OFF and then ON, so that the controller switches to the restored project.

i Info.

- Application_File in the "AUTOEXEC.INI" restoration configuration file cannot be excluded from the target of restoration. If it is excluded from the target of restoration, an error occurs.

14.6 Project Management Function

14.6.4 Backup and Restoration (Function Blocks)

You can back up or restore data from a program using function blocks. In combination with the FTP server function, a maintenance function can be implemented by remotely upgrading versions and regularly backing up data. The function block types are as shown below.

Item	Description
SYS_PRJBackup	This function block is used to collectively save every type of settings data in the GM1 controller to an SD memory card.
SYS_PRJRestore	This function block is used to transfer a backup file in an SD memory card to the GM1 Controller.
SYS_GetPRJRestoreResult	This function block is used to check results of execution of SYS_PRJRestore.

Info.

- For details on the function blocks, refer to the Instruction Edition.

14.7 Firmware Version Upgrade Function

14.7.1 Checking Unit Configuration

You can check the product numbers and current firmware versions of the GM1 controller and expansion units connected to the controller.

1 2 Procedure

1. From the menu bar, select **Online>Unit configuration confirmation**.
The "Select Device" dialog box appears to show a GM1 controller that you can connect.
2. "Unit configuration confirmation" The "Unit configuration confirmation" dialog box appears and displays the product numbers and current versions of the GM1 controller and expansion units connected to the controller.
3. Click the [OK] button.
The "Unit configuration confirmation" dialog box will be closed.

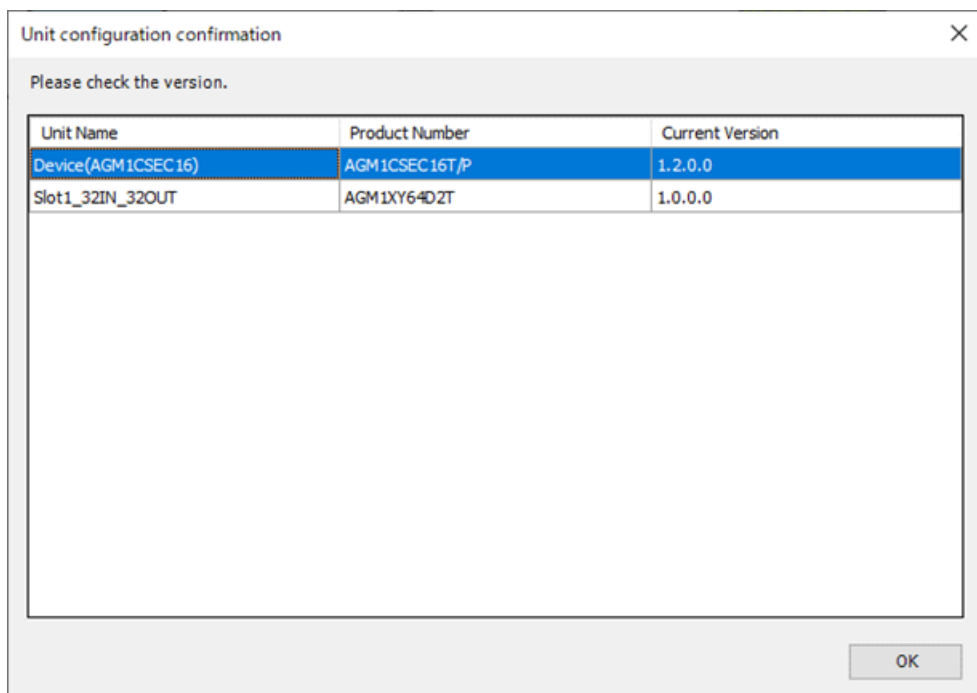

Note

- The configuration of units can also be confirmed by selecting "Basic Operations" on the start page and Unit "Configuration Confirmation".

14.7 Firmware Version Upgrade Function

14.7.2 Unit Version Upgrade

You can upgrade the firmware versions of the GM1 controller and expansion units connected to the controller. The versions of the expansion units as well as the GM1 controller can be upgraded by batch.

1.2 Procedure

1. From the menu bar, select **Online>Unit Version Upgrade**.
The "Select Device" dialog box appears to show a GM1 controller that you can connect.
2. Select Device of the GM1 controller and click the [OK] button.
3. "Unit Version Upgrade" The "Unit Version Upgrade" dialog box appears and displays current firmware versions in the Current Version column.
Latest versions are displayed by default in the Update Version column.

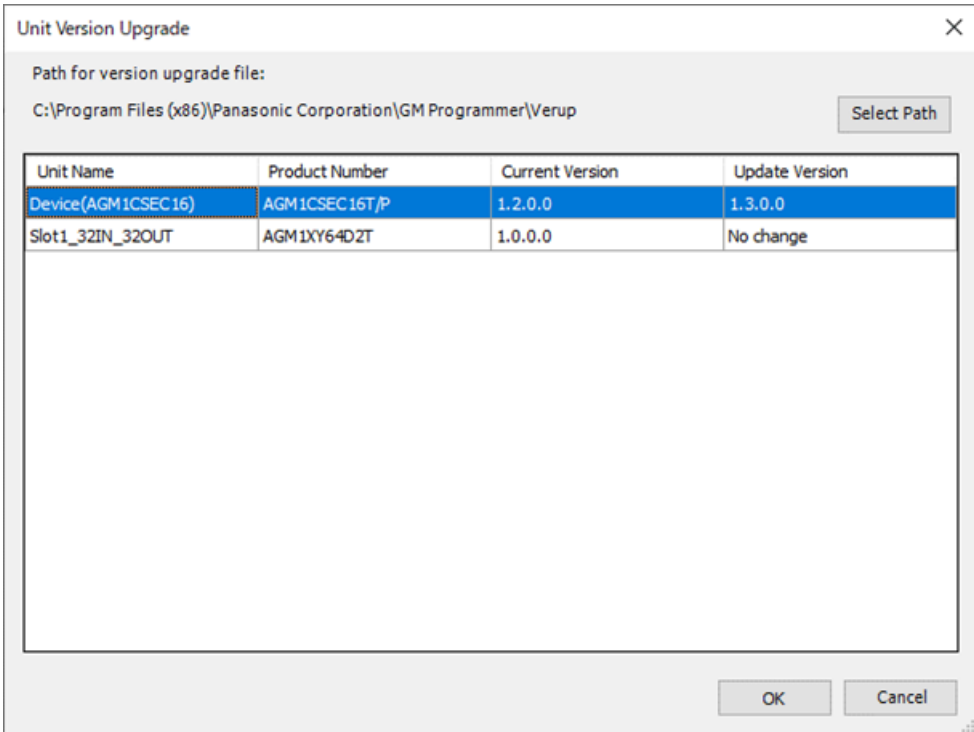

4. Select the version in the Update Version column.
To change to a version other than the latest version, select the desired version.
If the version is not to be upgraded, select "Not change".
5. Set the RUN/STOP switch on the GM1 Controller to STOP.
6. Click the [OK] button.
A confirmation dialog box will be displayed. Proceed with version upgrading by following the prompts in the dialog box.

After the version upgrading is completed, the "Version Upgrade Result" dialog box appears and displays upgrade results.

Check that every result is "Success" in the Result column.

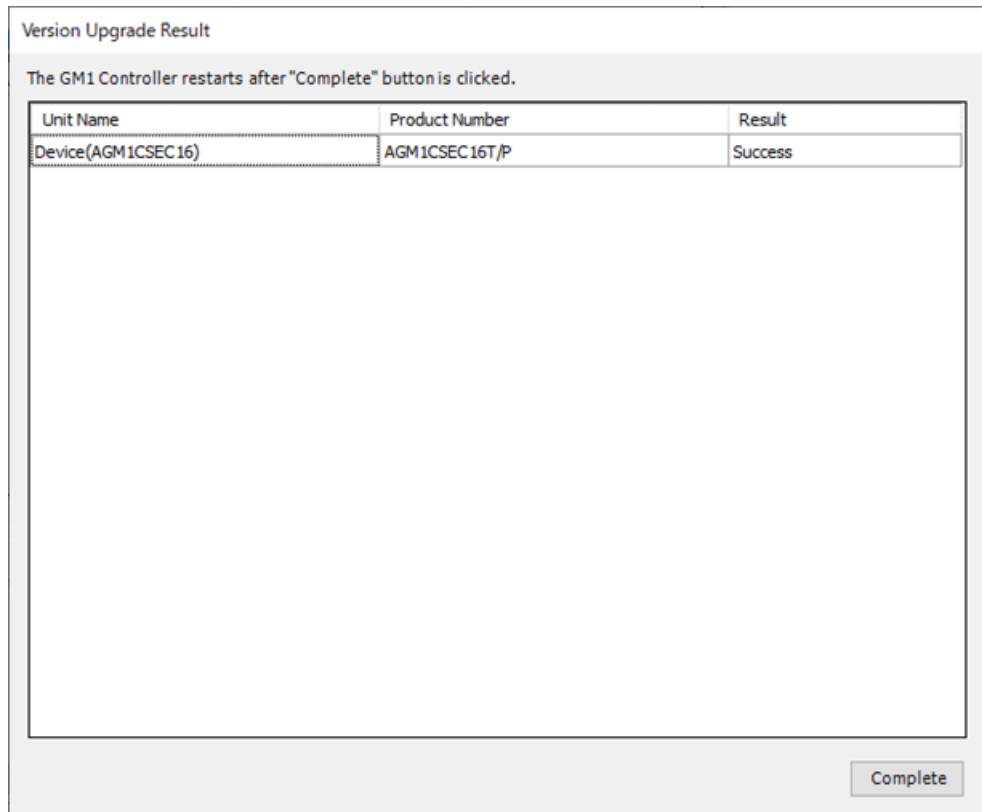

7. Click the [Complete] button.

Restart of the GM1 controller will start automatically. When the restart ends, the version upgrading is completed.

i Info.

- When the firmware version of the GM1 controller is upgraded, Reset Origin is executed.
- The designation of the path for the version upgrade file can be changed. Click the "Select Path" button and specify a folder where the version upgrade file (.hex) is saved.
- The versions of units can also be upgraded by selecting Basic Operations on the start page and Unit Version Upgrade.

14.8 Servo Amplifier / Motor Operation Function (PANATERM Lite for GM)

14.8 Servo Amplifier / Motor Operation Function (PANATERM Lite for GM)

You can start PANATERM Lite for GM, which allows you to check the settings of servo amplifiers, the operating states of servo amplifiers and motors, and the error status of servo amplifiers via the GM1 controller.

For details, refer to "[15 Overview of PANATERM Lite for GM](#)".

14.8.1 Starting PANATERM Lite for GM

This section explains how to start PANATERM Lite for GM from GM Programmer.

1 Procedure

1. From the menu bar, select **Tools>PANATERM Lite for GM**. PANATERM Lite for GM will be started.

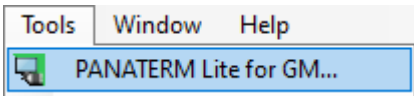

15 Overview of PANATERM Lite for GM

15.1 System Requirements.....	15-3
15.1.1 Operating Environment of PANATERM Lite for GM.....	15-3
15.2 Installation and Uninstallation	15-4
15.2.1 Installing PANATERM Lite for GM.....	15-4
15.2.2 Uninstalling PANATERM Lite for GM	15-4
15.3 Connecting with servo amplifier	15-5
15.3.1 Connecting the Servo Amplifier and PC	15-5
15.3.2 Disconnecting the Servo Amplifier from the PC.....	15-5
15.4 Basic Operations.....	15-6
15.4.1 How to Start	15-6
15.4.2 How to Exit.....	15-10
15.5 Component Names	15-11
15.5.1 Menu Bar	15-12
15.5.2 Toolbar	15-13
15.5.3 Navigation Pane.....	15-13
15.5.4 Main Pane.....	15-14
15.5.5 Status Field	15-14
15.6 Window Operations.....	15-15
15.6.1 Moving the Pane Location	15-15
15.6.2 Switching the Tab of the Main Pane.....	15-16
15.7 Connection settings Servo Amplifier to the GM1 Controller	15-18
15.7.1 Selecting the Device to Connect.....	15-18
15.8 Parameter Window	15-26
15.8.1 Configuration of Parameters Window	15-26
15.8.2 Setting Parameters	15-28
15.8.3 Writing Parameters to Servo Amplifier	15-29
15.8.4 Copying Parameters	15-31
15.8.5 Switching the Input Format of Parameter Values.....	15-32
15.8.6 Setting I/O Pin Assignment	15-34
15.9 Object Window	15-36
15.9.1 Configuration of Object Window	15-36
15.9.2 Setting Objects.....	15-39
15.9.3 Writing Objects to Servo Amplifier	15-40
15.10 Monitor Window	15-42
15.10.1 Configuration of Monitor Window	15-42
15.10.2 Checking the Monitor Window	15-44

15 Overview of PANATERM Lite for GM

15.11 Alarm Window	15-45
15.11.1 Configuration of Alarm Window	15-45
15.11.2 Checking Alarms	15-48
15.12 Other Functions	15-50
15.12.1 Language Setting Function	15-50
15.12.2 Version Display Function	15-51
15.13 Troubleshooting	15-52
15.13.1 Troubleshooting for Servo Amplifiers and Motors	15-52

15.1 System Requirements

15.1.1 Operating Environment of PANATERM Lite for GM

Programming software

Product name	Applicable language
PANATERM Lite for GM	Japanese / English / Chinese

(Note 1) When GM Programmer is installed, MINAS setup support software "PANATERM Lite for GM" is installed at the same time.

Software operating environment

Item	Description
OS	Microsoft(R) Windows(R) 10: 32bit / 64bit
PC	PC with the following software installed: <ul style="list-style-type: none"> ● Microsoft.NET Framework 4.6.1 or later ● Microsoft Visual C++ 2010 SP1 Redistributable Package (x86) ● Microsoft Visual C++ 2010 SP1 Redistributable Package (x64) ● Microsoft Visual C++ 2013 Redistributable Package (x86) ● Microsoft Visual C++ 2013 Redistributable Package (x64) ● Microsoft Visual C++ 2015 Update 3 Redistributable Package (x86) ● Microsoft Visual C++ 2015 Update 3 Redistributable Package (x64)
HDD	At least 4 GB of free space
Memory	At least 8 GB
Communication port	LAN port (for Ethernet connection) USB 2.0 port (for USB connection)

15.2 Installation and Uninstallation

15.2 Installation and Uninstallation

15.2.1 Installing PANATERM Lite for GM

When GM Programmer is installed, PANATERM Lite for GM is also installed at the same time.

15.2.2 Uninstalling PANATERM Lite for GM

When GM Programmer is uninstalled, PANATERM Lite for GM is also uninstalled at the same time.

15.3 Connecting with servo amplifier

15.3.1 Connecting the Servo Amplifier and PC

Use a USB cable to connect the servo amplifier and a PC on which PANTERM Lite for GM has been installed.

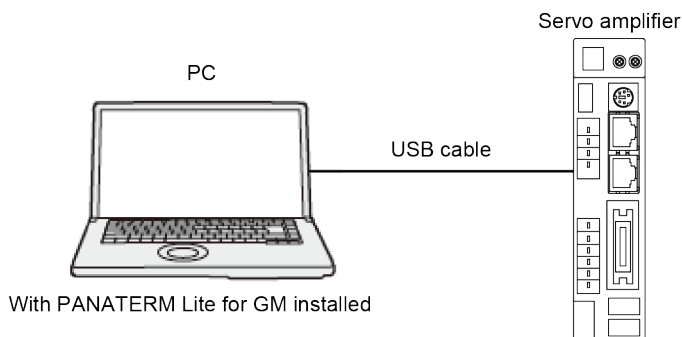

i Info.

- When the GM Programmer is installed, the USB driver is also installed at the same time.

15.3.2 Disconnecting the Servo Amplifier from the PC

Disconnect the USB cable connecting the PC and the servo amplifier.

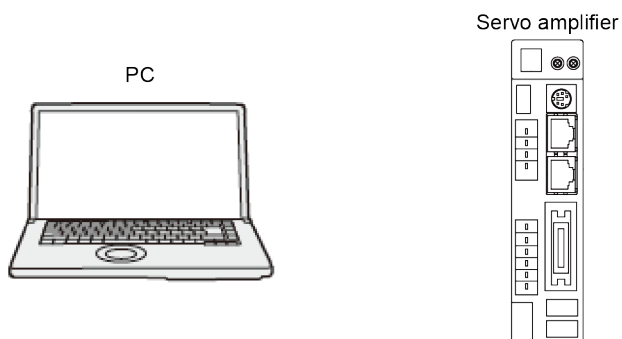

15.4 Basic Operations

15.4 Basic Operations

This section explains how to start and exit PANATERM Lite for GM.

15.4.1 How to Start

1 2 Procedure

1. Click the [Start] button in the Windows task bar and select **Panasonic Corporation>PANATERM Lite for GM**.
2. The "Connect" dialog box will be displayed.
Select a communication setting option and click [OK].

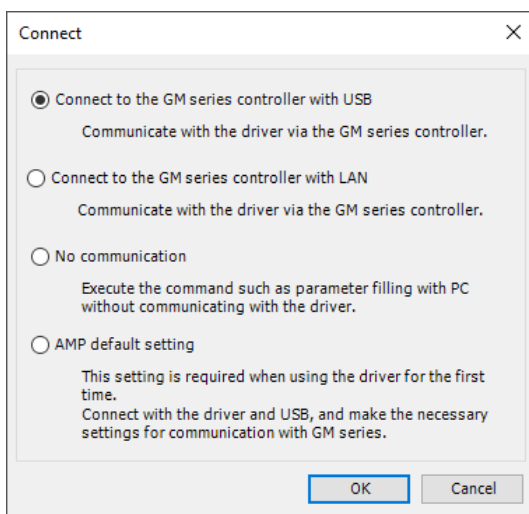

3. The "Series Setting" dialog box will be displayed.

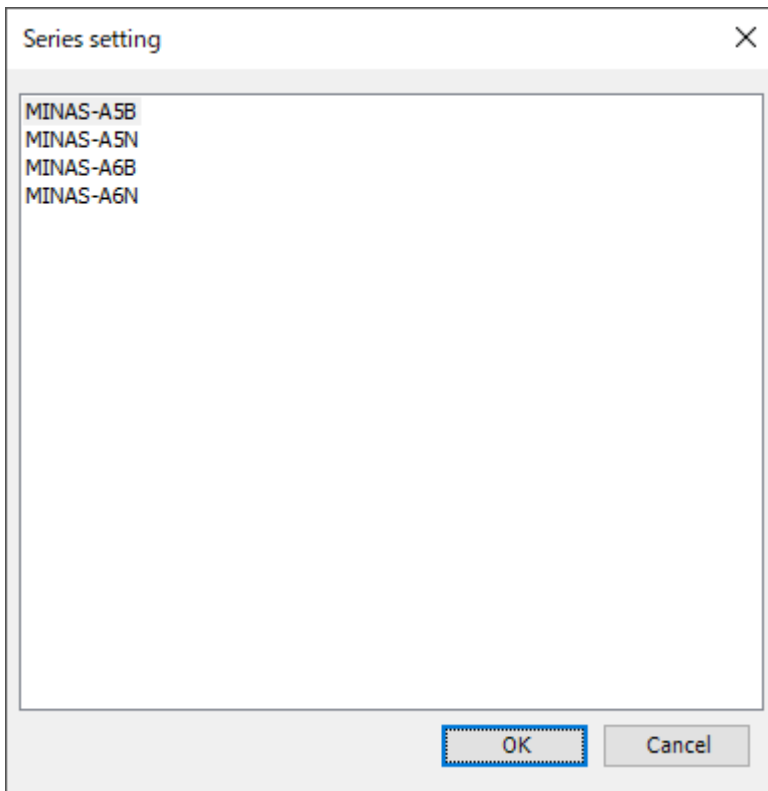

15.4 Basic Operations

Note

When the "Selection of Aircraft Types" dialog box is displayed, select a model and click the "OK" button.

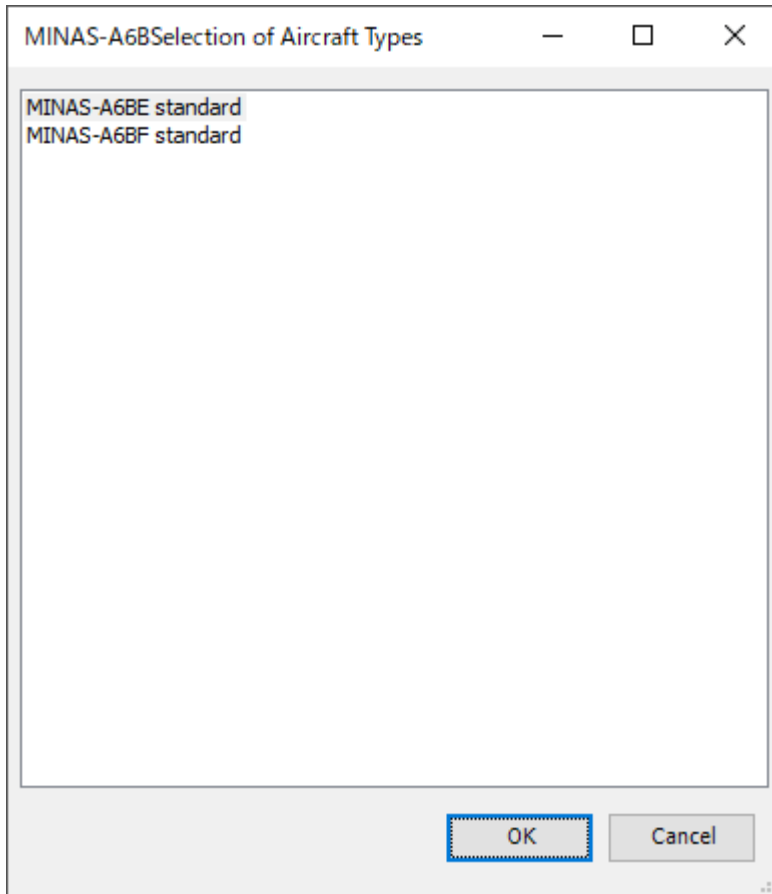

4. PANATERM Lite for GM will be started.

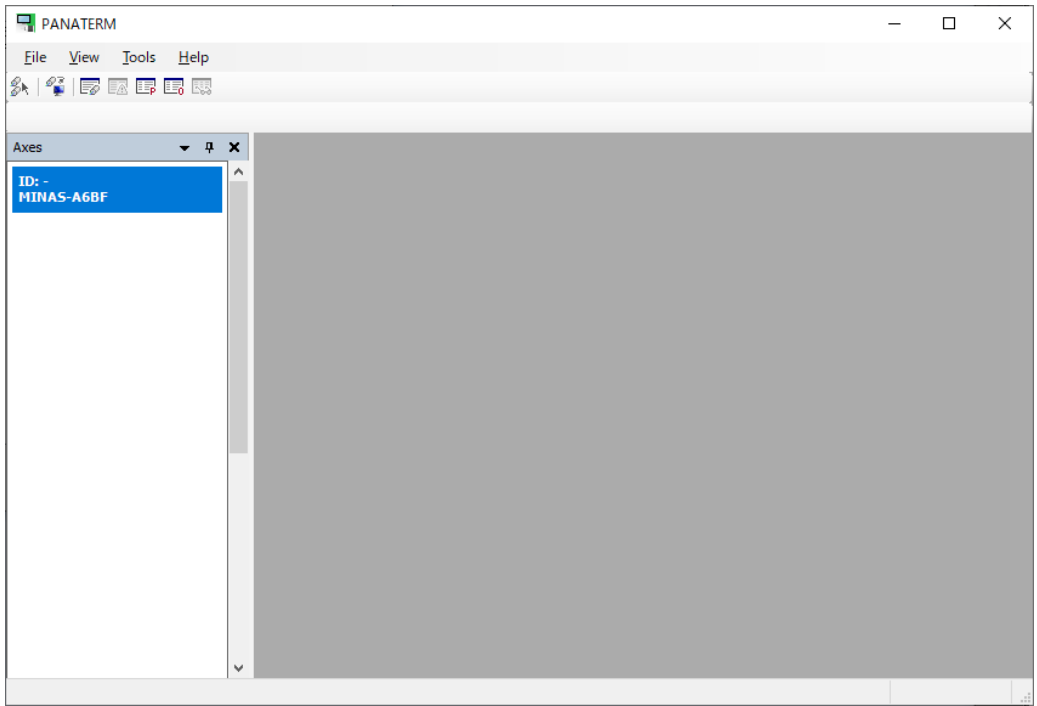

15.4 Basic Operations

15.4.2 How to Exit



- Note that all information will be lost if you close the program without saving settings, collected data, or other information.

12

Procedure

1. From the menu bar, select **File>Exit**.
PANATERM Lite for GM will be closed.



Info.

- You can also close PANATERM Lite for GM by clicking the [×] button on the title bar.

15.5 Component Names

This section explains the components and displays of PANATERM Lite for GM.

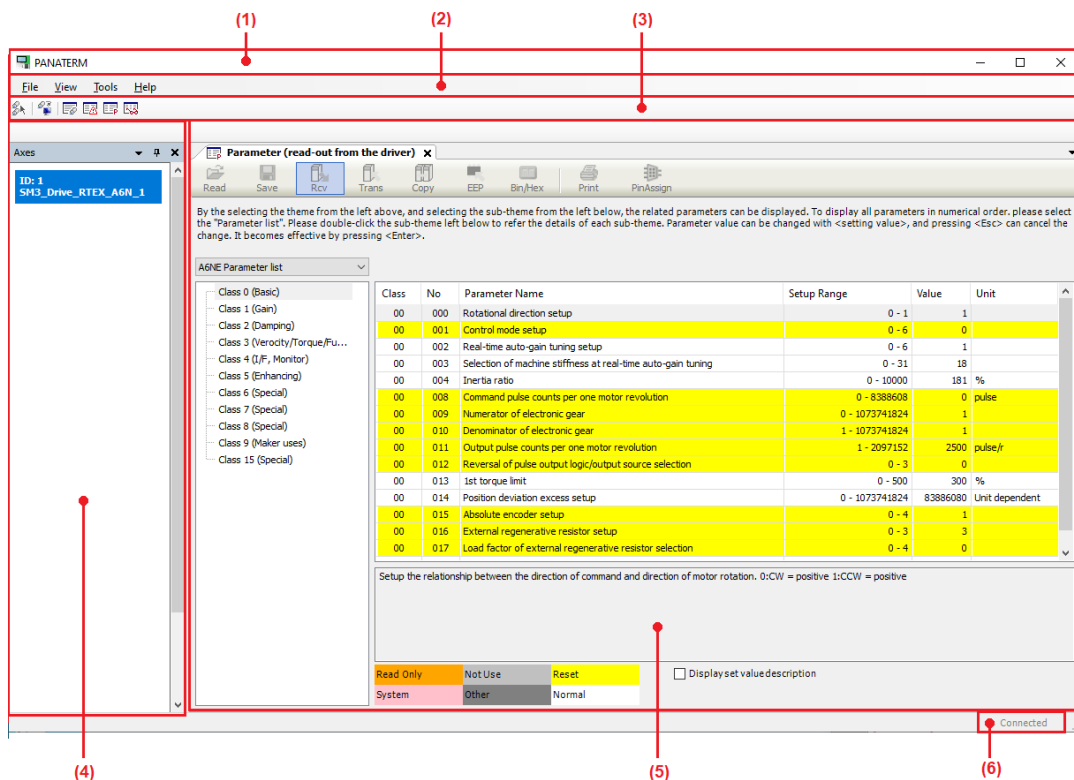

No.	Name	Description
(1)	Title bar	The title bar displays the project file name, [minimize] button, [maximize] button, and [close] button.
(2)	Menu bar	The menu bar displays the menu commands for each purpose in list format.
(3)	Toolbar	The toolbar displays each command as an icon.
(4)	Navigator pane	This pane displays a list of axes.
(5)	Main pane	This pane displays the Parameter window, Monitor window, Alarm window, and other windows. The window can be switched by selecting a desired tab.
(6)	Status field	This field displays the status of connection to the GM1 controller.

15.5 Component Names

15.5.1 Menu Bar

The menu bar displays the following menus:

File **V**iew **T**ools **H**elp

File

Item	Function
Settings	Used to set up an amplifier with the amplifier connected or with a model selected. Select Model: Select an amplifier to be connected. Connect Amplifier: Select either the connection via PC or the direct connection for connecting the GM1 controller and the amplifier order to set up an amplifier.
Exit	Closes PANATERM Lite for GM

View

Item	Function
Axes	Displays a list of axes
Parameter	Displays the Parameter window
Monitor	Displays the Monitor window
Alarm	Displays the Alarm window

Tools

Item	Function
English	Switches the display language of GM Programmer to English
日本語	Switches the display language of GM Programmer to Japanese
中文(簡体)旧版	Switches the display language of GM Programmer to Chinese

Help

Item	Function
About	Displays version information
PANATERM Lite for GM Help	Displays the manual

15.5.2 Toolbar

The toolbar displays the following icons:



Name	Icon	Function
Select the drive series		Sets up an amplifier with the amplifier unconnected
Opens the connect dialog		Select either the connection via PC or the direct connection for connecting the GM1 controller and the amplifier order to set up an amplifier.
Opens the Axis view		Displays a list of axes
Opens the Alarm view		Displays the Alarm view
Opens the Parameter view		Displays the Parameter view
Opens the Monitor view		Displays the Monitor view

15.5.3 Navigation Pane

The navigation pane displays the following tree:

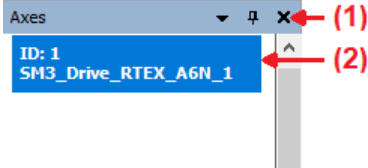

No.	Name	Icon	Function
(1)	Auto Hide		Always shows the navigation pane.
			Minimizes and hides the navigation pane.
	Close		Closes the navigation pane.
(2)	Axes		Displays a list of axes downloaded to the GM1 controller

15.5 Component Names

15.5.4 Main Pane

The main pane displays the following sub-panes:

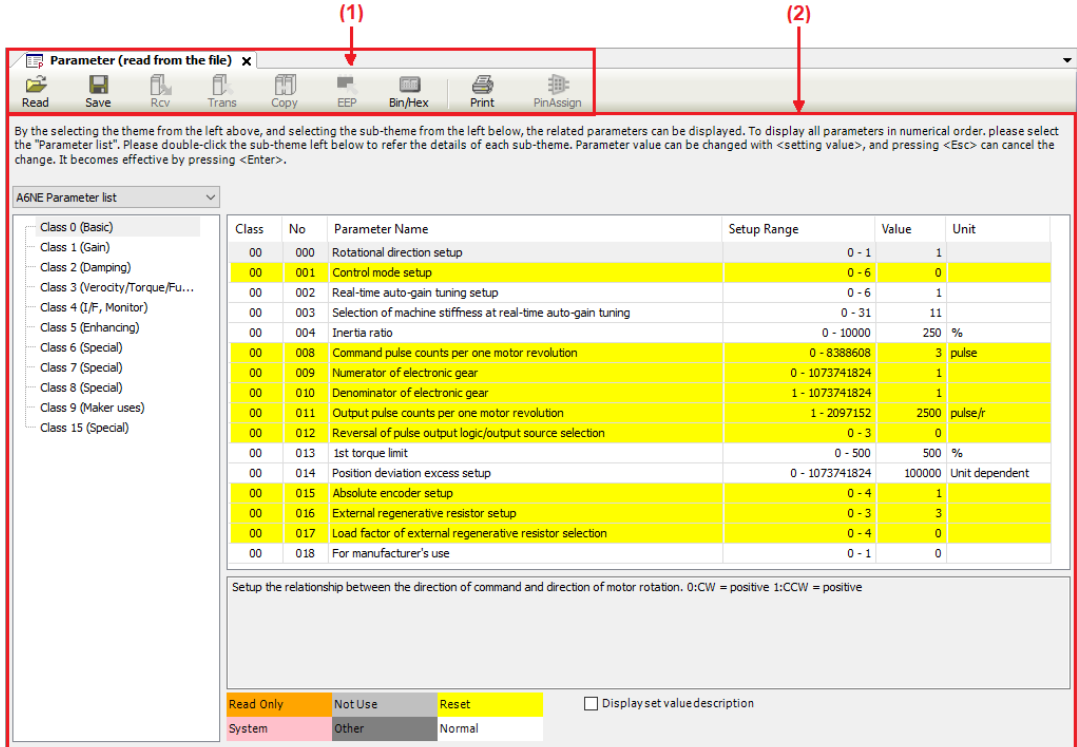

No.	Name	Description
(1)	Toolbar	In each window, the toolbar displays commands as icons.
(2)	Main view	The main view displays the Parameter window, Alarm window, Monitor window, and other windows.

15.5.5 Status Field

The status field displays the current communication status.

Display	Description
	Indicates that there is no communication with the GM1 controller.
	Indicates that there are communications with the GM1 controller.

15.6 Window Operations

This section explains common window operations for PANATERM Lite for GM.

15.6.1 Moving the Pane Location

You can freely change the layout of each pane of PANATERM Lite for GM.

Example: Moving the navigator pane from the left edge to the right edge of the window

1 2 Procedure

1. Click the title bar of the navigator pane and then drag it to the main pane. The navigator pane will stay in a floating state and arrows indicating movable directions will be displayed.

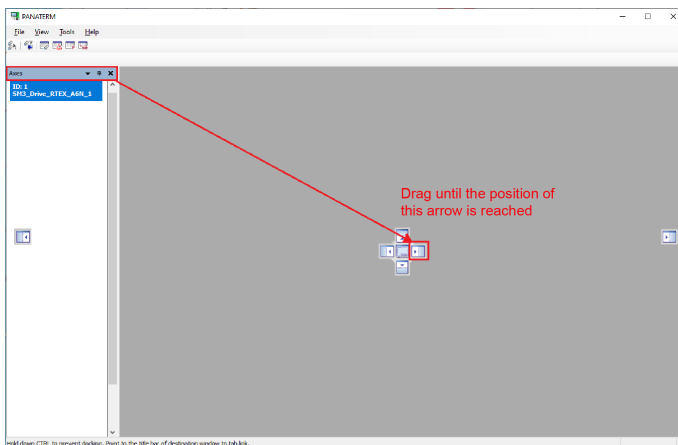

2. Drag the navigator pane in the direction in which you want to move it. The relocation destination will be displayed in light blue.

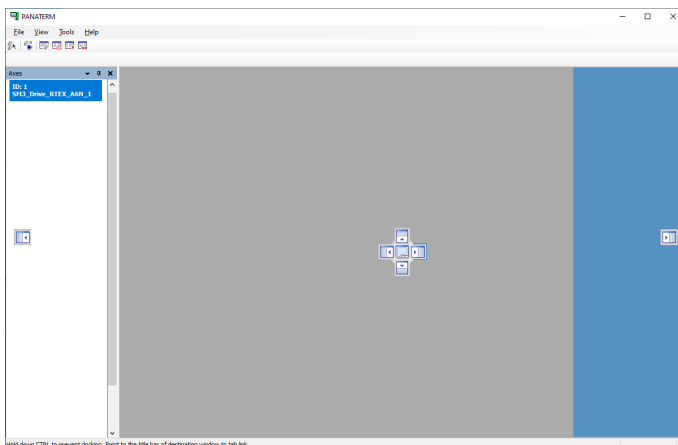

3. Release the left mouse button.

15.6 Window Operations

The navigator pane will be docked into the existing pane and the relocation will be completed.



15.6.2 Switching the Tab of the Main Pane

You can switch the tab of the main pane.

1 Procedure

1. Press the <Ctrl> key + <Tab> key simultaneously.
The window for switching the tab of the main pane will be displayed.

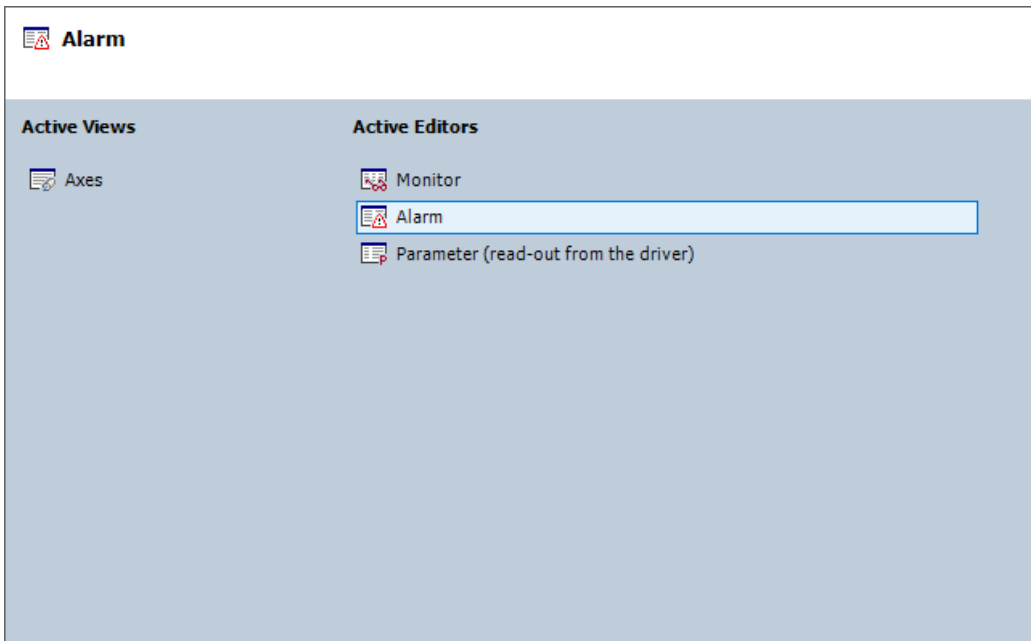

2. While holding down the <Ctrl> key, press the <Tab> key until the desired tab is selected.
3. Release the <Ctrl> key.
The window corresponding to the selected tab will be displayed.

15.7 Connection settings Servo Amplifier to the GM1 Controller

15.7 Connection settings Servo Amplifier to the GM1 Controller

This section explains how to set up MINAS series servo amplifiers connected to the GM1 Controller.

For other devices, refer to their instruction manuals when setting up them.

The PC communicates with the servo amplifier connected to the GM1 Controller.

Connect the PC and GM1 Controller with an Ethernet cable or USB cable. With the GM1 Controller and servo amplifier connected with a Cat5e shielded cable, set up the servo amplifier.



- Perform this setup work only after the connection between the GM1 Controller and the servo amplifier has been established.

15.7.1 Selecting the Device to Connect

After you start PANATERM Lite for GM or when you select **File>Settings>Connect Amplifier**, a dialog box for selecting the device to be connected will be displayed.

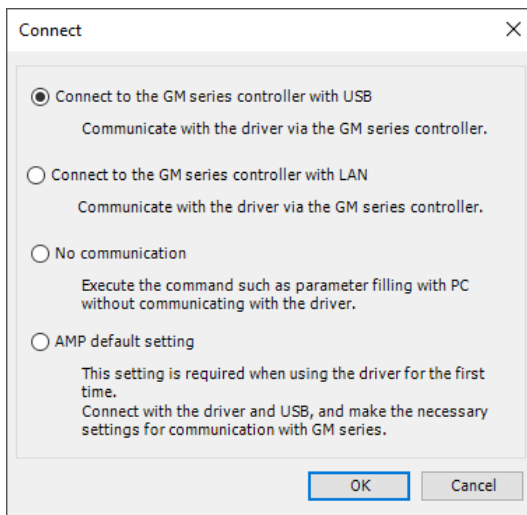

The following options will be displayed.

- Connect to the GM series controller with USB
- Connect to the GM series controller with LAN
- No communication
- AMP default setting

The following section describes operations when each option is selected.



When you use the servo amplifier for the first time after it was purchased, you must establish a communication between the GM1 Controller and the servo amplifier. Connect the PC and the servo amplifier with a USB cable and execute "Configure amplifier communication settings".

Then, with the servo amplifier and GM1 Controller connected, set up the servo amplifier.

If Connected with USB Cables

If connected with USB cables, use the following procedure.

1 2 Procedure

1. Start PANATERM Lite for GM.
The "Connect" dialog box will be displayed.

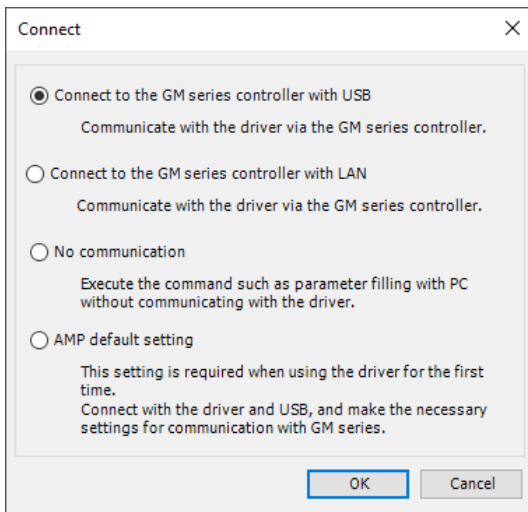

2. Select "Connect to the GM series controller with USB" and click the [OK] button.
The "Add USB Port" dialog box will be displayed.

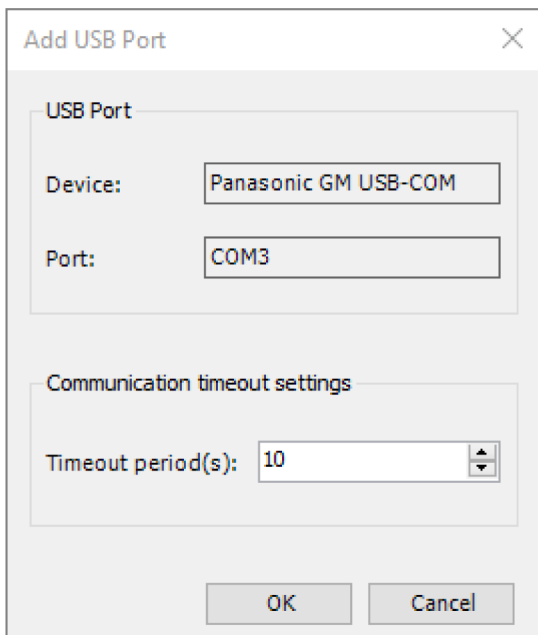

15.7 Connection settings Servo Amplifier to the GM1 Controller

3. Change the timeout period and click the [OK] button.

A message window will be displayed, asking whether to add a USB port and restart the Gateway.

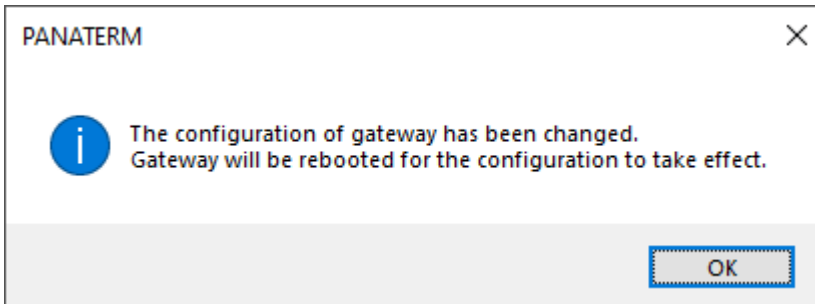

4. Click the [OK] button.
The "Select Device" dialog box will be displayed.

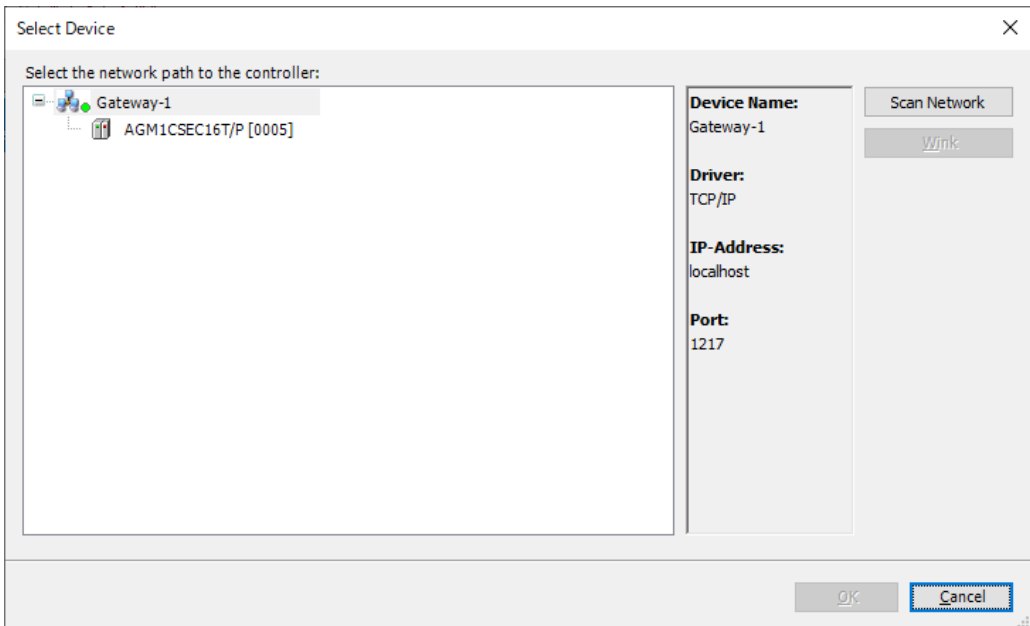

5. Click the [Search Network] button, select the GM1 Controller, and click the [OK] button.
The main pane will be displayed.

15.7 Connection settings Servo Amplifier to the GM1 Controller

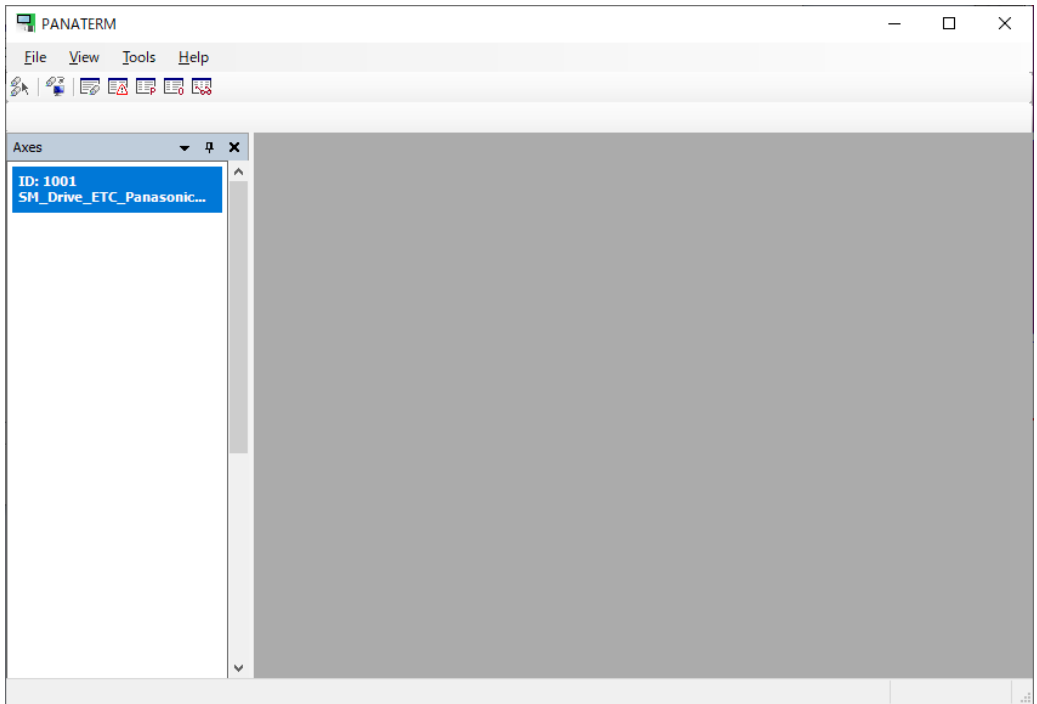

15.7 Connection settings Servo Amplifier to the GM1 Controller

If Connected with Ethernet Cables

If connected with Ethernet cables, use the following procedure.

1 2 Procedure

1. Start PANATERM Lite for GM.
The "Connect" dialog box will be displayed.

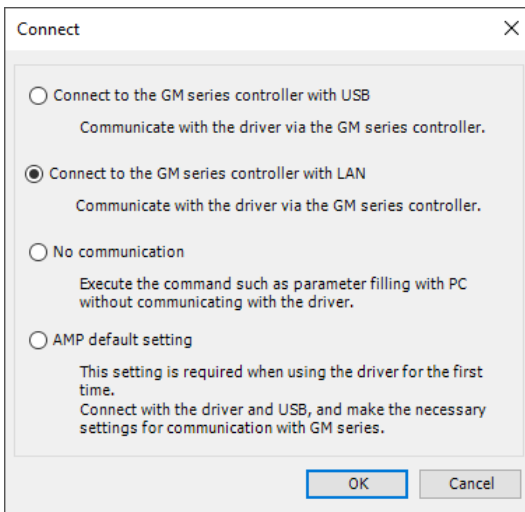

2. Select "Connect to the GM series controller with LAN" and click the [OK] button.
The "Communication timeout settings" dialog box will be displayed.

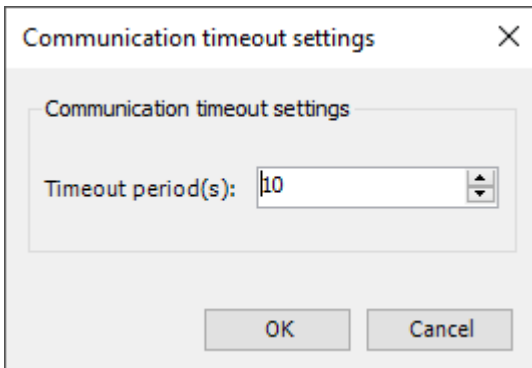

3. Change the timeout period and click the [OK] button.
The "Select Device" dialog box will be displayed.

15.7 Connection settings Servo Amplifier to the GM1 Controller

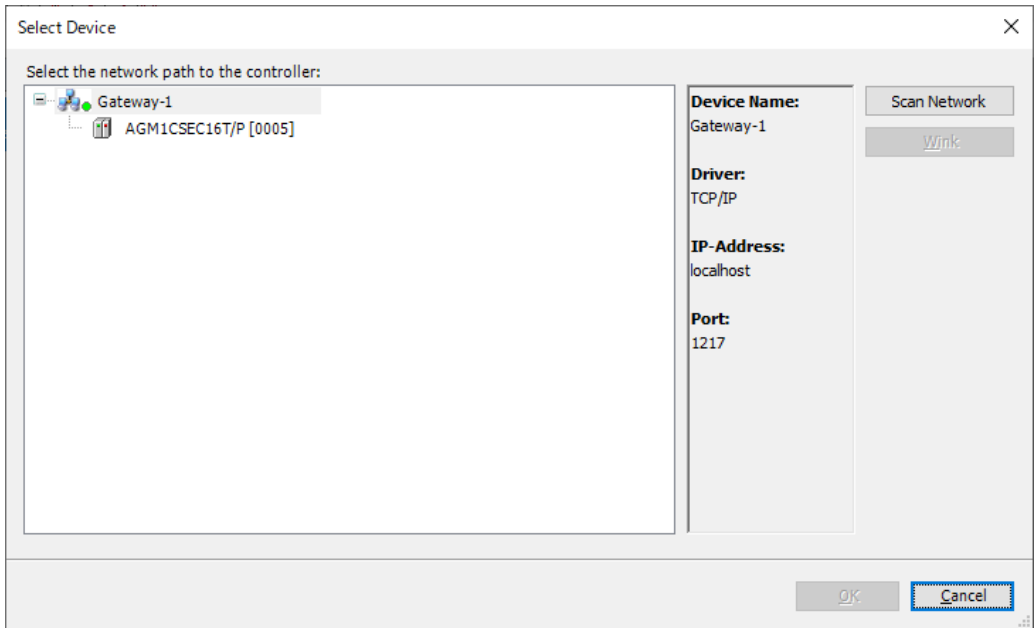

4. Click the [Search Network] button, select the GM1 Controller, and click the [OK] button. The main pane will be displayed.

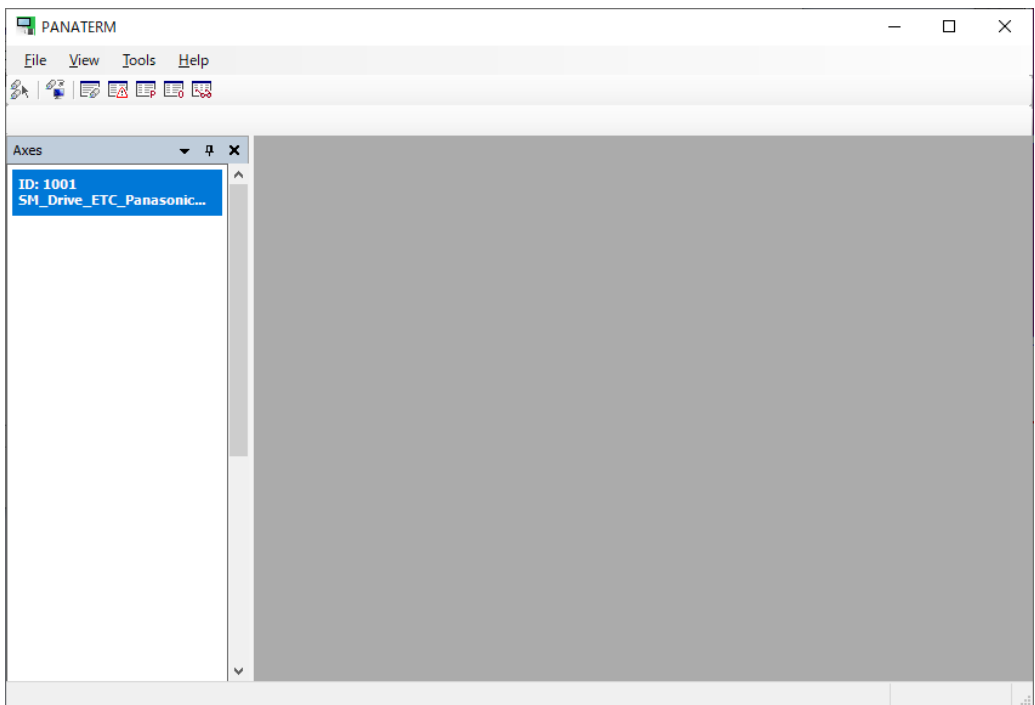

15.7 Connection settings Servo Amplifier to the GM1 Controller

Editing Settings without Connecting to the GM1 Controller

You can freely edit parameters and other data saved in files without connecting to the GM1 Controller. The edited contents are not written to the servo amplifier.

1 2 Procedure

1. Start PANATERM Lite for GM.
The "Connect" dialog box will be displayed.

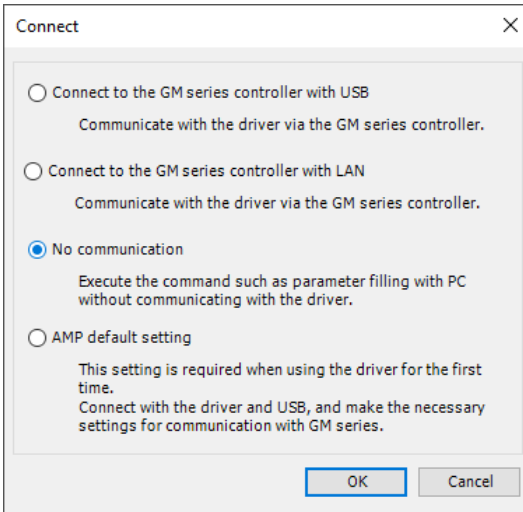

2. Select "No communication" and click the [OK] button.
The "Select Series" dialog box will be displayed.

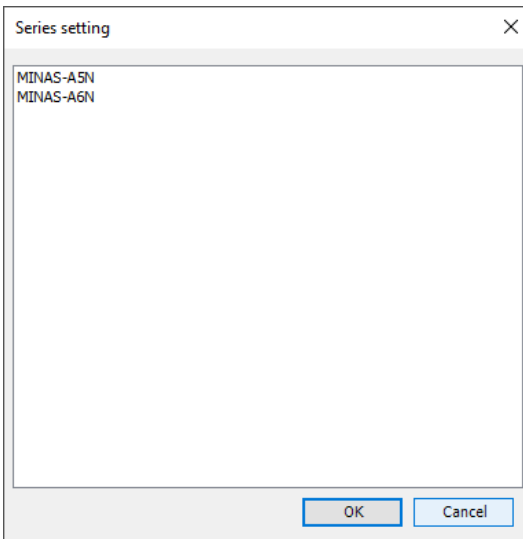

3. Select a servo amplifier to be connected and click the [OK] button.
The main pane will be displayed.

Note

When the "Selection of Aircraft Types" dialog box is displayed, select a model and click the "OK" button.

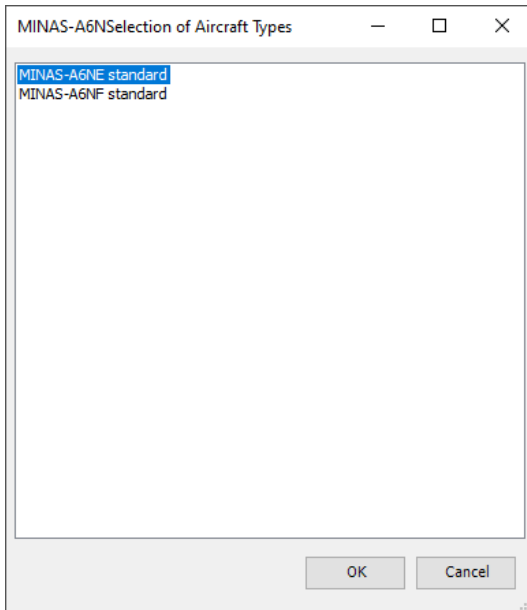

Configure amplifier communication settings

For details on the connection method using the amplifier's communication settings, refer to the following.

RTEX: ["9.2.1 RTEX parameter settings for servo amplifier"](#)

EtherCAT: ["9.2.2 EtherCAT parameter settings for servo amplifier"](#)

15.8 Parameter Window



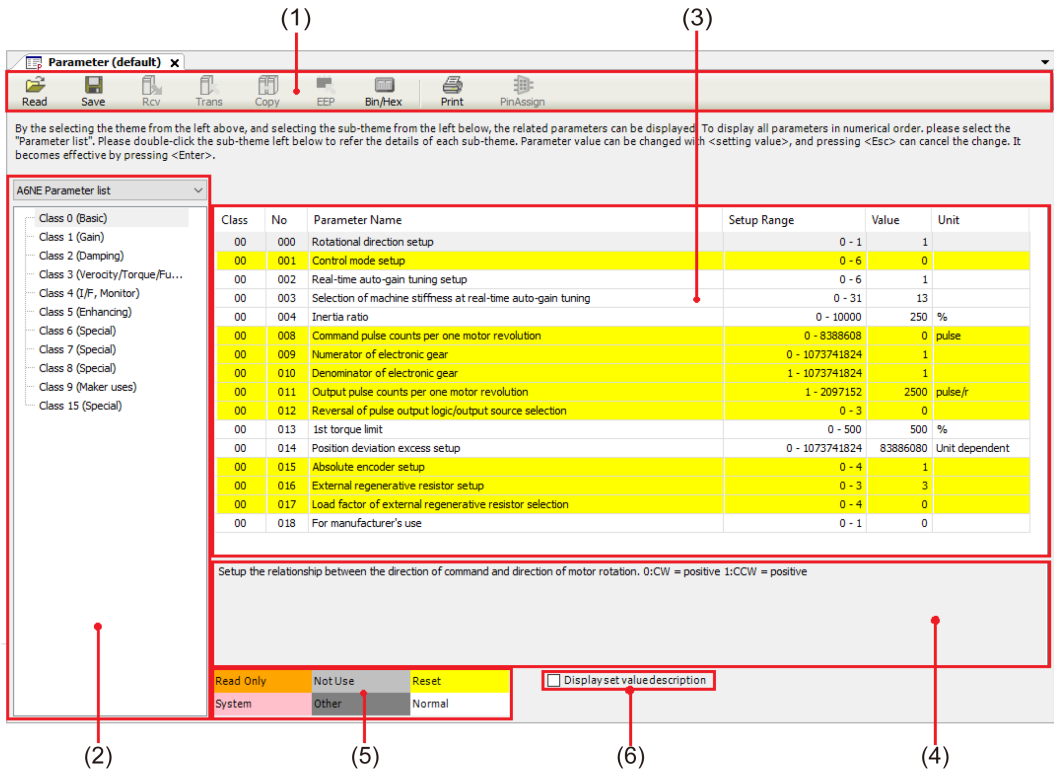

15.8 Parameter Window

The Parameter window allows the user to check and rewrite the values of servo amplifier parameters, save them to parameter files, and perform parameter-related operations.

15.8.1 Configuration of Parameters Window

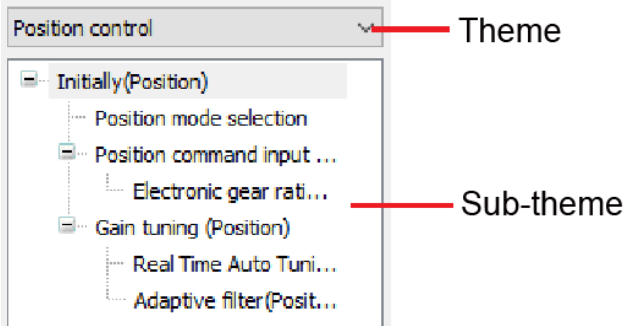

No.	Name	Function															
(1)	Toolbar	<p>The toolbar consists of basic operation commands related to parameters, such as save and read.</p> <table border="1"> <thead> <tr> <th>Icon</th> <th>Name</th> <th>Function</th> </tr> </thead> <tbody> <tr> <td></td> <td>Read</td> <td>Reads parameters from file ".prm5"</td> </tr> <tr> <td></td> <td>Save</td> <td>Writes parameters to file ".prm5"</td> </tr> <tr> <td></td> <td>Rcv</td> <td>Receives parameters from the servo amplifier.</td> </tr> <tr> <td></td> <td>Trans</td> <td>Transmits parameters to the servo amplifier.</td> </tr> </tbody> </table>	Icon	Name	Function		Read	Reads parameters from file ".prm5"		Save	Writes parameters to file ".prm5"		Rcv	Receives parameters from the servo amplifier.		Trans	Transmits parameters to the servo amplifier.
Icon	Name	Function															
	Read	Reads parameters from file ".prm5"															
	Save	Writes parameters to file ".prm5"															
	Rcv	Receives parameters from the servo amplifier.															
	Trans	Transmits parameters to the servo amplifier.															

No.	Name	Function																
		Icon	Name	Function														
			Copy	Copies the parameters of a servo amplifier to servo amplifiers for other axes.														
			EEP	Writes parameters to EEPROM of the servo amplifier.														
			Bin / Hex	Inputs the selected settings in binary or hexadecimal format.														
			Print	Prints parameters.														
			Pin assignment setting	Sets I/O pin assignment.														
(2)	Theme selection pane	<p>After a theme is selected, if a parameter category is selected from a sub-theme, related parameters will be displayed in the parameter setting area.</p>  <p>For details on each parameter, refer to the instruction manual and other technical references for the servo amplifier.</p>																
(3)	Parameter setting area	<p>Allows the user to set or edit parameters.</p> <table border="1"> <thead> <tr> <th>Name</th> <th>Function</th> </tr> </thead> <tbody> <tr> <td>Class</td> <td>Displays parameter categories</td> </tr> <tr> <td>No.</td> <td>Displays parameter numbers</td> </tr> <tr> <td>Parameter Name</td> <td>Displays parameter names</td> </tr> <tr> <td>Setup Range</td> <td>Displays the maximum and minimum allowable values of parameter settings</td> </tr> <tr> <td>Value</td> <td>Displays parameter values. Values can be changed. For parameters provided with a ▼ button beside the set value, a desired value can be selected from the combo box. After selecting a value from the combo box, press the <Enter> key. For parameters without a ▼ button beside the set value, either directly enter a value using <numerical> keys or click "▲" "▼" to edit the value by increasing or decreasing it. To set a value, press the <Enter> key. To return a value to its original value, press the <Esc> key.</td> </tr> <tr> <td>Unit</td> <td>Displays the unit of parameter settings.</td> </tr> </tbody> </table>			Name	Function	Class	Displays parameter categories	No.	Displays parameter numbers	Parameter Name	Displays parameter names	Setup Range	Displays the maximum and minimum allowable values of parameter settings	Value	Displays parameter values. Values can be changed. For parameters provided with a ▼ button beside the set value, a desired value can be selected from the combo box. After selecting a value from the combo box, press the <Enter> key. For parameters without a ▼ button beside the set value, either directly enter a value using <numerical> keys or click "▲" "▼" to edit the value by increasing or decreasing it. To set a value, press the <Enter> key. To return a value to its original value, press the <Esc> key.	Unit	Displays the unit of parameter settings.
Name	Function																	
Class	Displays parameter categories																	
No.	Displays parameter numbers																	
Parameter Name	Displays parameter names																	
Setup Range	Displays the maximum and minimum allowable values of parameter settings																	
Value	Displays parameter values. Values can be changed. For parameters provided with a ▼ button beside the set value, a desired value can be selected from the combo box. After selecting a value from the combo box, press the <Enter> key. For parameters without a ▼ button beside the set value, either directly enter a value using <numerical> keys or click "▲" "▼" to edit the value by increasing or decreasing it. To set a value, press the <Enter> key. To return a value to its original value, press the <Esc> key.																	
Unit	Displays the unit of parameter settings.																	

15.8 Parameter Window

No.	Name	Function
(4)	Text display area	Displays a description related to the selected parameter.
(5)	Parameter attribute description area	Displays a description of parameter attributes. The background color of each parameter in the parameter setting area represents an attribute.
(6)	"Display-set value description" check box	Selecting the check box displays combo boxes and decimal points in the "Value" column of the parameter setting area. To display parameter set values in an easy-to-understand manner, select the check box.

15.8.2 Setting Parameters

1 2 Procedure

1. From the menu bar on the main pane, select **Display>Parameter**. Alternatively, on the toolbar, click the "Open the Parameter view" icon.

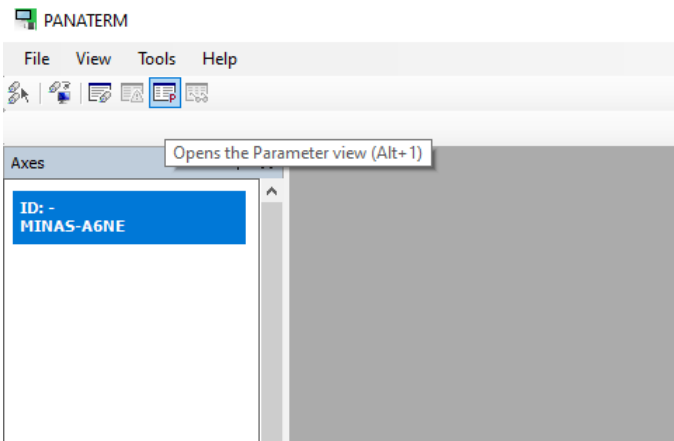

The "Selection of parameter to be read" dialog box will be displayed.

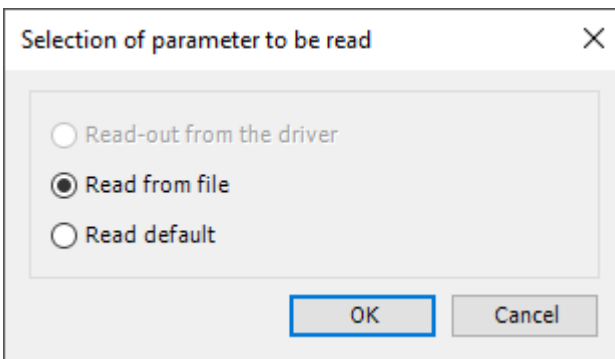

Read-out from the driver

Communicates with the connected servo amplifier and reads the parameter settings from the servo amplifier. If this mode is selected, parameter values will be reflected in the servo amplifier as soon as they are changed.

Read from file

Read the parameter file (".prm5") that was edited previously. If communication is performed with the servo amplifier, parameter values will be reflected in the servo amplifier as soon as they are changed.

Read default

Reads the standard default settings of the servo amplifier that were saved during installation. If communication is performed with the servo amplifier, parameter values will be reflected in the servo amplifier as soon as they are changed.

2. Select one of the three options above and click the [OK] button.

The Parameter window will be displayed.

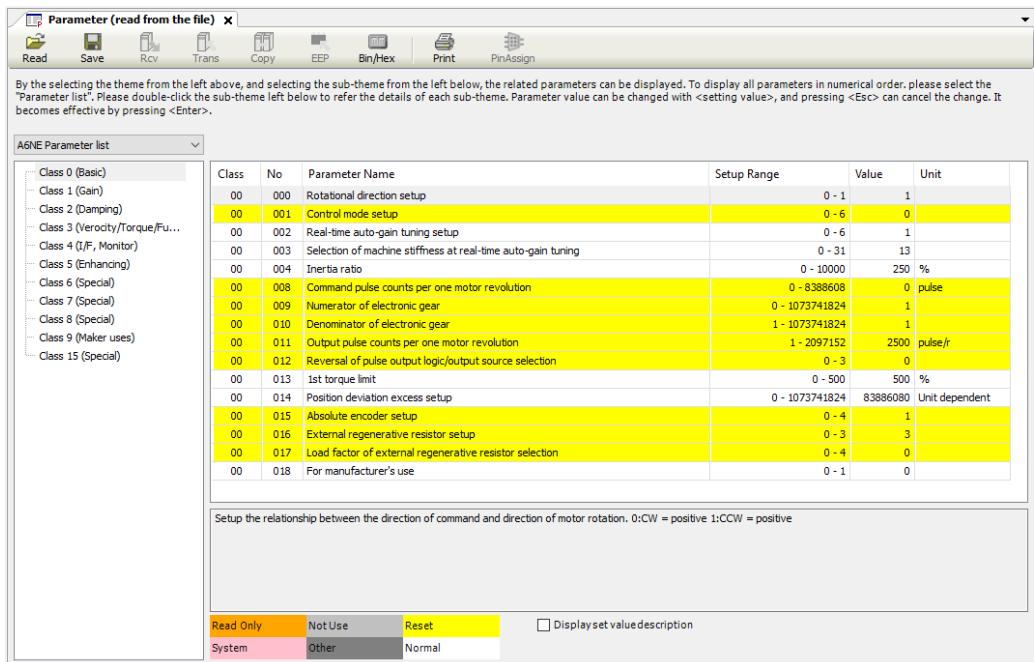

3. After changing the parameter settings, click the [EEP] button to write the parameter settings to the EEPROM of the servo amplifier.

4. Click the [x] button on the Parameter window to close the Parameter window.

15.8.3 Writing Parameters to Servo Amplifier

By connecting the PC and a servo amplifier, the parameters set with PANATERM Lite for GM can be written directly to the servo amplifier.

1 2 Procedure

1. Click "Trans" on the toolbar.

The parameters will be sent from PANATERM Lite for GM to the servo amplifier.

15.8 Parameter Window

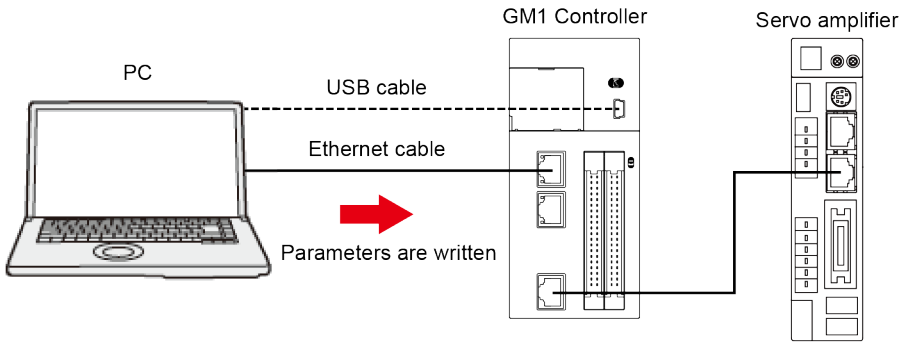
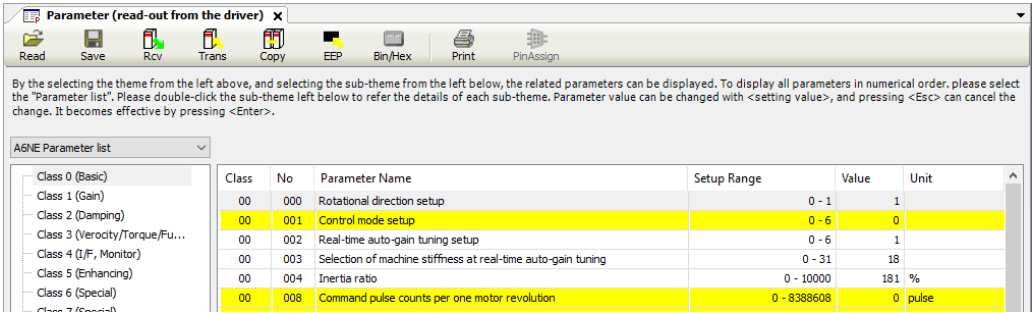

i Info.

- If you have changed parameters on a yellow background, click "EEP" on the toolbar to restart the servo amplifier.

15.8.4 Copying Parameters

Copies the parameters of a servo amplifier to servo amplifiers for other axes.
It is not possible to copy from A6N type to A5N type or from A5N type to A6N type.

1 2 Procedure

1. Click the "Copy" icon on the toolbar.
The Copy Parameter window will be displayed.

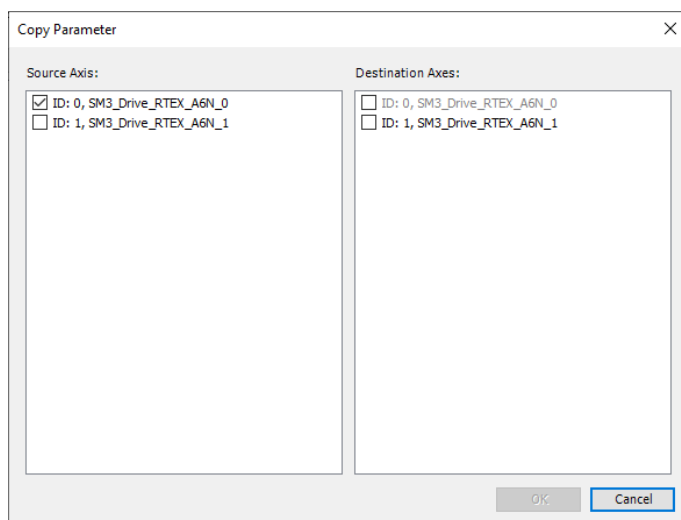

2. In the "Copy source" area, select an axis from which parameters are to be copied.
3. In the "Copy destination" area, select an axis to which parameters are to be copied.

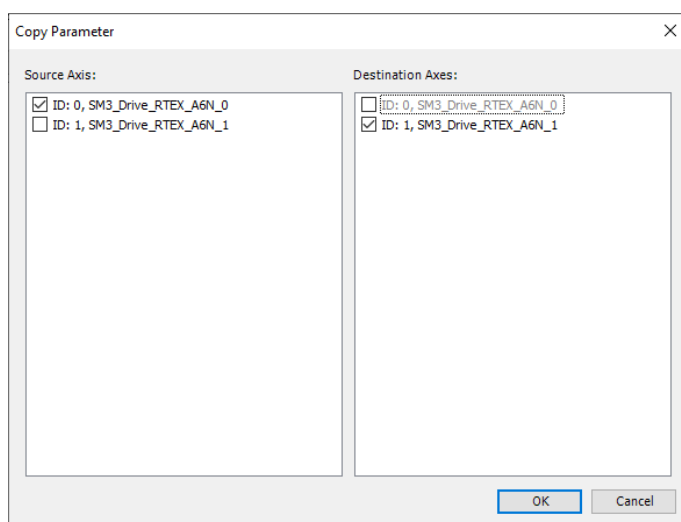

4. Click the [OK] button.

15.8 Parameter Window

5. The Parameter window for the copy destination axis will be displayed.
6. Click the "Trans" icon on the toolbar.
The parameters will be written to the servo amplifier.
7. Click the [EEP] icon on the toolbar.
The parameters will be written to the EEPROM of the servo amplifier.

15.8.5 Switching the Input Format of Parameter Values

Selected parameter values can be entered in binary or hexadecimal format.

1 2 Procedure

1. Click the "Bin / Hex" icon on the toolbar.
The Binary / Hexadecimal Input window will be displayed.

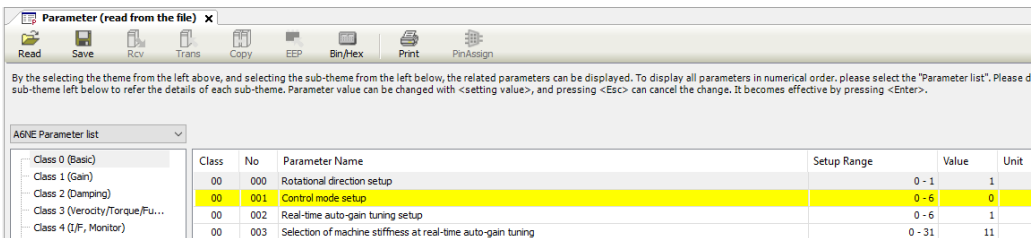

2. To enter parameter values in hexadecimal format, enter a value and then press the <Enter> key. To enter parameter values in binary format, click the button corresponding to each bit to switch between "0" and "1".

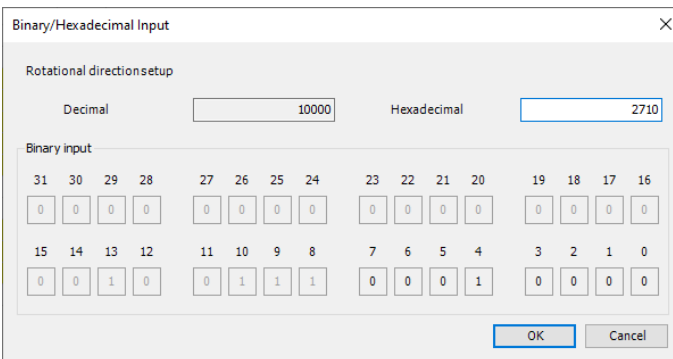

Note: If the input exceeds the parameter range, "!" mark is displayed on the right side of the hexadecimal display section. Move the mouse cursor over the "!" mark to display the input range.

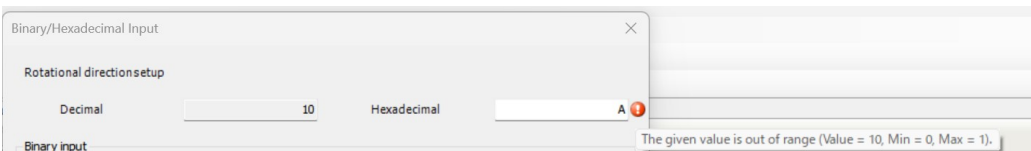

3. After the above input operation is complete, click the [OK] button.

15.8 Parameter Window

15.8.6 Setting I/O Pin Assignment

I/O pin assignment can be set.

The assignment can be set for the input and output related parameter "Class 4 (I/F, monitor)".

1.2 Procedure

1. Click the "Pin assignment " icon on the toolbar.
The pin assignment setting input window will be displayed.

The 'Pin Assign' dialog box is divided into two sections: 'Input' and 'Output'. Each section contains a table with columns for Pin-No., Position/Full-closed control, Velocity control, and Torque control.

Pin-No.	Position/Full-closed control	Velocity control	Torque control
05(SI1)	SI-MON5_ConnectA	SI-MON5_ConnectA	SI-MON5_ConnectA
07(SI2)	POT_ConnectB	POT_ConnectB	POT_ConnectB
08(SI3)	NOT_ConnectB	NOT_ConnectB	NOT_ConnectB
09(SI4)	SI-MON1_ConnectA	SI-MON1_ConnectA	SI-MON1_ConnectA
10(SI5)	HOME_ConnectA	HOME_ConnectA	HOME_ConnectA
11(SI6)	EXT2_ConnectA	EXT2_ConnectA	EXT2_ConnectA
12(SI7)	EXT3_ConnectA	EXT3_ConnectA	EXT3_ConnectA
13(SI8)	SI-MON4_ConnectA	SI-MON4_ConnectA	SI-MON4_ConnectA

Pin-No.	Position/Full-closed control	Velocity control	Torque control
01/02(SO1)	BRK-OFF	BRK-OFF	BRK-OFF
25/26(SO2)	EX-OUT1	EX-OUT1	EX-OUT1
03/04(SO3)	ALM	ALM	ALM

Buttons: OK, Cancel

2. Double-click the row of the pin number to be set.
The function selection window will be displayed.

The 'Input function select' dialog box allows selecting functions for Position/Full-closed control, Velocity control, and Torque control. Each control type has radio buttons for 'A-Connect' (selected) and 'B-Connect'. Below is a table of available functions.

Position/Full-closed	Velocity control	Torque control
Invalid	Invalid	Invalid
POT	POT	POT
NOT	NOT	NOT
EX-SON	EX-SON	EX-SON
-	-	-
-	-	-
-	-	-
-	-	-
-	-	-

Buttons: OK, Cancel

3. Select a function to be assigned to the pin for each control mode and a contact method (only when an input function is selected).
4. In the function selection window, click the [OK] button.
The display will be returned to the pin assignment setting input window.
5. Click the [OK] button.
A confirmation window will be displayed, asking whether to write to the servo amplifier.

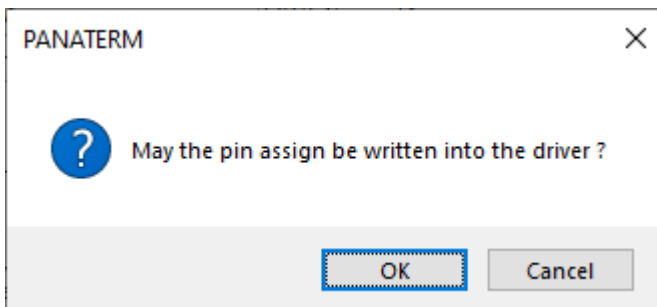

Click the [OK] button to write the parameter settings to the EEPROM of the servo amplifier. Click the [Cancel] button to close the window without writing the parameter settings to the EEPROM of the servo amplifier.

Note: Pin assignment settings do not take effect until the servo amplifier is restarted.

15.9 Object Window

15.9 Object Window

Troubleshooting can be performed more easily by displaying and editing the list of objects on the amplifier side without using a host device.





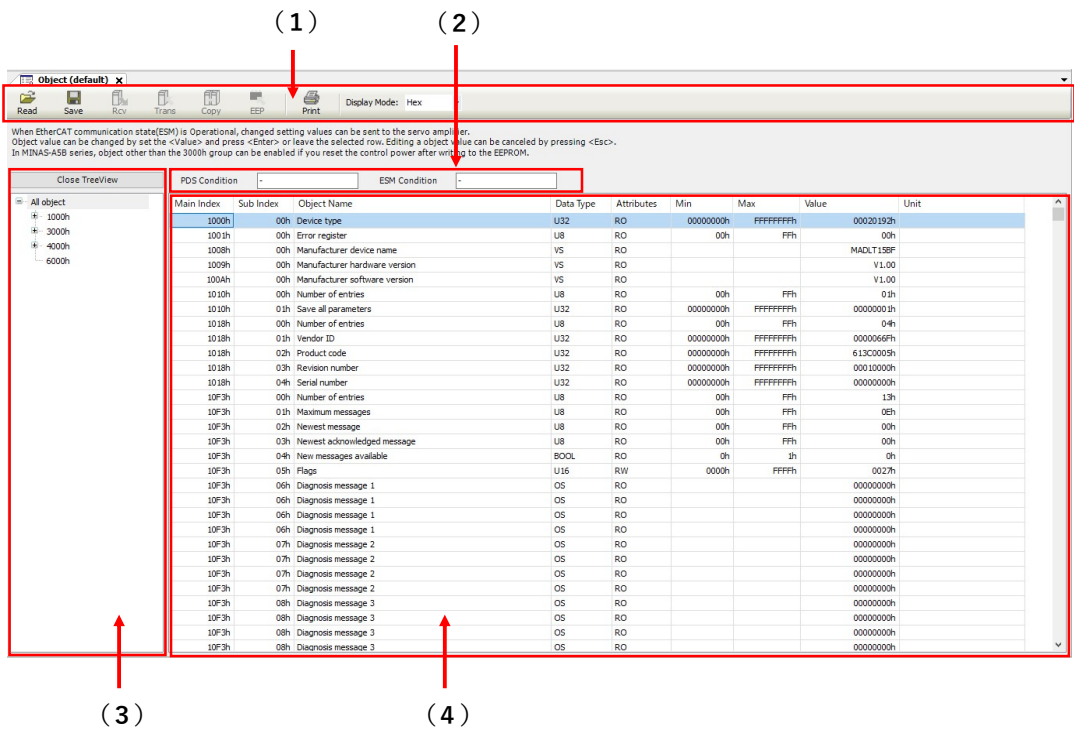

i Info.

- Object Window is for EtherCAT connection only.
- Some objects affect the behaviors of servo amplifiers or motors. Therefore, before changing the objects, carefully read the instruction manual and other technical references for the servo amplifier and pay careful attention when changing them.

15.9.1 Configuration of Object Window

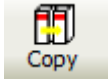

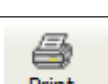
No.	Name	Function									
(1)	Toolbar	The toolbar consists of basic operation commands related to objects, such as save and read.									
		<table border="1"> <thead> <tr> <th>Icon</th> <th>Name</th> <th>Function</th> </tr> </thead> <tbody> <tr> <td></td> <td>Read</td> <td>Reads objects from the file ".obj5".</td> </tr> <tr> <td></td> <td>Save</td> <td>Writes objects to the file ".obj5".</td> </tr> </tbody> </table>	Icon	Name	Function		Read	Reads objects from the file ".obj5".		Save	Writes objects to the file ".obj5".
		Icon	Name	Function							
	Read	Reads objects from the file ".obj5".									
	Save	Writes objects to the file ".obj5".									

No.	Name	Function		
			Rcv	Receives objects from the servo amplifier.
			Trans	Transmits objects to the servo amplifier. If you turn OFF the power supply to the servo amplifier without writing to EEPROM, the object will be reverted back to the value before the change was made.
			Copy	Copies the objects of a servo amplifier to servo amplifiers for other axes.
			EEP	Writes objects to EEPROM of the servo amplifier. Do not turn OFF the power supply to the servo amplifier and the PC while data is being written to EEPROM. If the power supply is cut off while data is being written, the data content is not warranted.
			Print	Prints objects.
			Display mode	Changes the numerical display of the object being displayed. Hex: Displayed in hexadecimal number and "h" is placed at the end of the number. Dec: Displayed in decimal number and a sign is set. Bin: Displayed in binary number and "b" is placed at the end of the number. The values in the Min-Max column are displayed in hexadecimal number.
(2)	Condition monitor	<p>PDS Condition Displays the PDS condition on the servo amplifier side. It varies depending on the object value of 6041h-00h.</p> <p>ESM Condition Displays the condition that indicates whether the object can be rewritten on the servo amplifier side. Rewriting is possible when "Operational" is displayed.</p>		
(3)	Object tree	<p>When a node is selected from the object tree, related objects are displayed in the object setting field. Operate Close TreeView or Open TreeView to hide or display the object tree. Select "All object" to display all objects.</p> <p>When a parent node is selected, all child node objects under the selected node are displayed.</p> <p>When a child node is selected, objects of the selected node are displayed.</p> <p>For details of each object, refer to the instruction manual and other technical references for the servo amplifier.</p>		

15.9 Object Window

No.	Name	Function	
(4)	Object setting field	Allows the user to edit and set an object.	
		Name	Function
		Main Index	Displays the Main Index of an object.
		Main Index	Displays the Sub Index of an object.
		Object Name	Displays the name of an object.
		Data Type	Displays the data type of an object. I8: Integer 8 type I16: Integer 16 type I32: Integer 32 type U8: Unsigned 8 type U16: Unsigned 16 type U32: Unsigned 32 type Bool: Boolean type OS: Octet String type VS: Visible String type
		Attributes	Displays the attributes of an object. RO: Read-only attribute, exclusively for reading. RW: Read/write attribute, possible to read or write.
		Min	Displays the setting range of an object.
		Max	The setting range is not displayed for an object whose Data Type is "OS" or "VS".
		Value	Displays the value of an object. The value can be changed if the object attribute is "RW" and the set value is a numerical value. Note that there are input restrictions for each Display mode setting. The following values can be input. Hex: 0 to 9, A to F (After editing, ""h"" is automatically placed at the end of the number.) Dec: 0 to 9 and minus sign "-" Bin: 0 and 1 (""b"" is automatically placed at the end of the number.) After changing the value, press the <ENTER> key or click the [Trans] button. To return a value to its original value press the <ESC> key.
Unit	Displays the unit of an object set value.		

15.9.2 Setting Objects

1 2 Procedure

1. From the menu bar on the main pane, select **View>Object**. Alternatively, on the toolbar, click the "Open the Object view" icon.

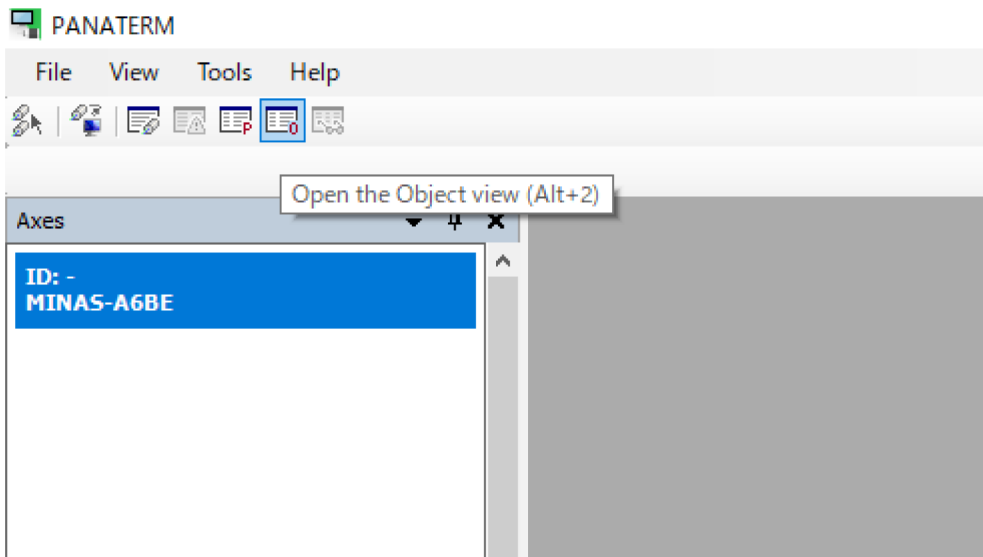

The "Selection of objects to be read" dialog box will be displayed.

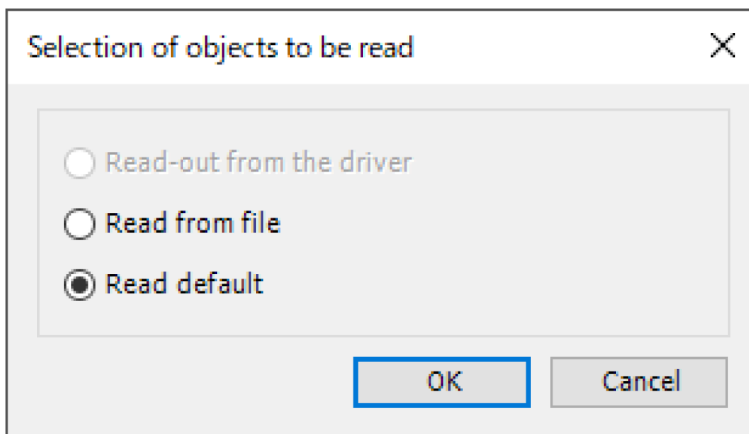

Read-out from the amplifier.

Communicates with the connected servo amplifier and reads objects set in the servo amplifier.

If this mode is selected, object values will be reflected in the servo amplifier as soon as they are changed.

15.9 Object Window

Read from file

Reads the parameter file ("obj5") that was edited previously. If communication is performed with the servo amplifier, object values will be reflected in the servo amplifier as soon as they are changed.

Read default

Reads the standard default settings of the servo amplifier that were saved during installation.

If communication is performed with the servo amplifier, object values will be reflected in the servo amplifier as soon as they are changed.

2. Select one of the three options above for reading the object settings and click the [OK] button.

The Object window will be displayed.

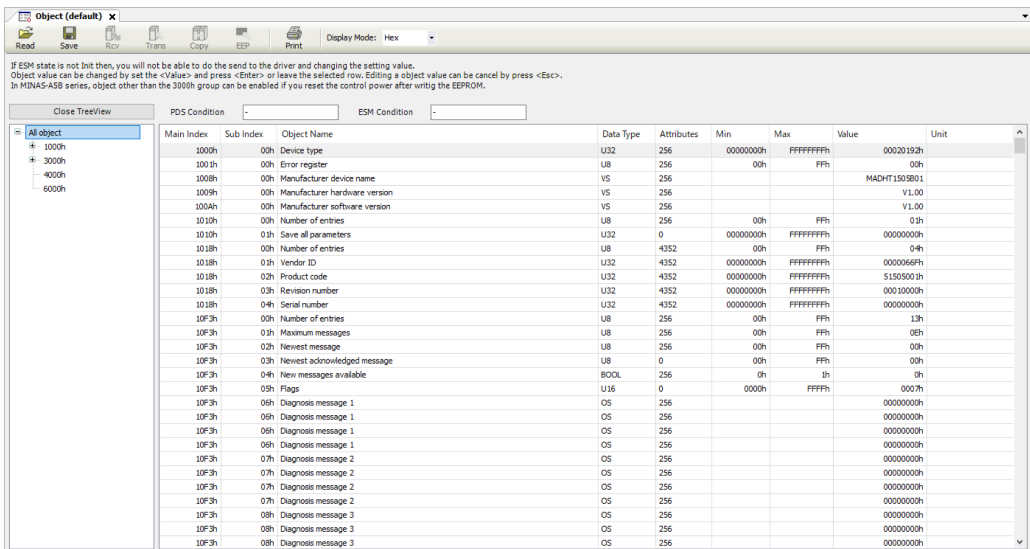

3. After changing the object settings, click the [EEP] button to write the object settings to the EEPROM of the servo amplifier.

4. Click the [x] button on the Object window to close the Object window.

15.9.3 Writing Objects to Servo Amplifier

By connecting the PC and a servo amplifier, the objects set with PANATERM Lite for GM can be written directly to the servo amplifier.

1.2 Procedure

1. Click [Trans] on the toolbar.

The objects will be sent from PANATERM Lite for GM to the servo amplifier.

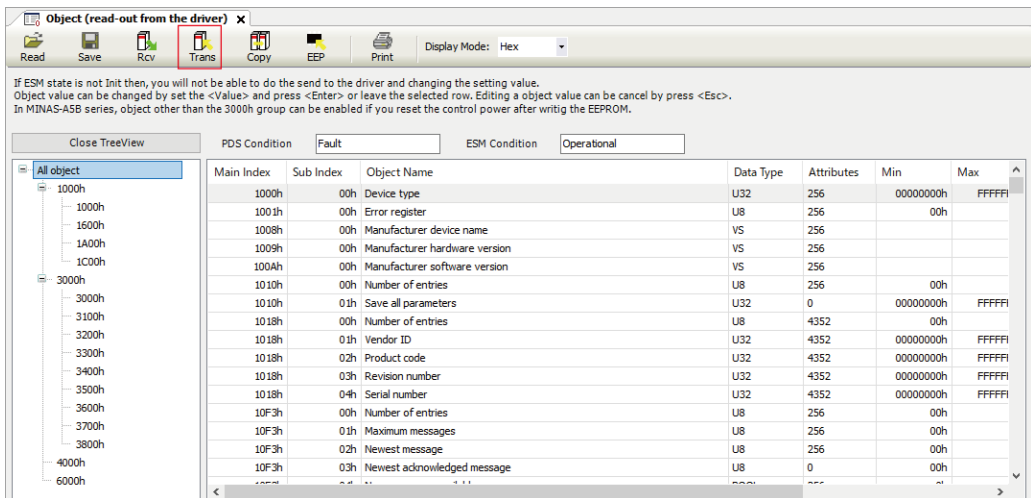

2. Click the [EEP] button to write the objects to the EEPROM of the servo amplifier.

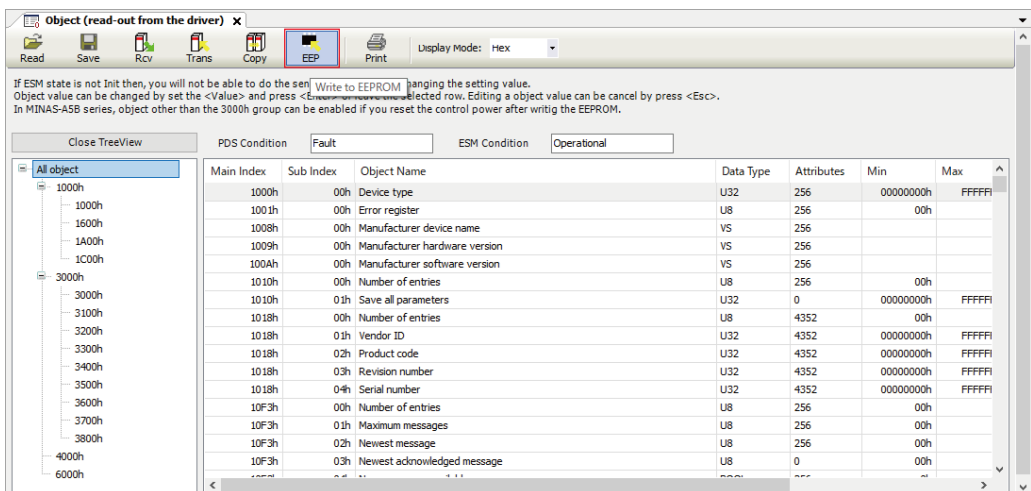

15.10 Monitor Window



15.10 Monitor Window

The Monitor window displays the operating states of servo amplifiers and motors, I/O signals, internal statuses, and other information and also allows the user to check them.

15.10.1 Configuration of Monitor Window

The screenshot shows the Monitor window interface for a servo amplifier. The window title is "Parameter (read-out from the driver) Monitor X". The main content area is titled "Control Mode: Position control". It is divided into several sections:

- (1) Toolbar:** Located at the top left, containing a "Print" icon.
- (2) Amplifier Model and Serial Number:** A header box displaying "MADLT01NF 17100005".
- (3) Output Signal Status Monitor:** A section with two tabs: "Physical Output" and "Logical Output". The "Physical Output" tab is active, showing a table of output signals with their status (Red for ON, Pink for OFF).
- (4) Input Signal Status Monitor:** A table showing input signals and their status (Red for ON, Pink for OFF).
- (5) Internal State:** A table showing internal parameters like Command position deviation, Actual speed, Torque command, Load ratio, and Power supply Voltage.
- (6) Pulse Count Total:** A table showing Command position and Encoder pulse total.
- (7) Encoder / External scale:** A table showing Single-revolution data and Multi-turn data.

NO.	Name	Description				
(1)	Toolbar	The toolbar consists of basic operation commands related to parameters.				
		<table border="1"> <thead> <tr> <th>Icon</th> <th>Name</th> <th>Function</th> </tr> </thead> <tbody> <tr> <td></td> <td>Print</td> <td>Prints the contents of the Monitor window.</td> </tr> </tbody> </table>	Icon	Name	Function	
Icon	Name	Function				
	Print	Prints the contents of the Monitor window.				
(2)	Amplifier model name and serial number	Displays the model name and serial number of the servo amplifier.				
(3)	Output signal status monitor	<p>Displays the status of each output signal. The tab can be switched between "Physical Output" and "Logical Output".</p> <p>Physical Output – Displays the status of output signals from the servo amplifier.</p> <p>Red: Indicates that output transistor is ON</p> <p>Pink: Indicates that output transistor is OFF</p>				

NO.	Name	Description												
		Logical Output – Displays the status of signals within the servo amplifier. Red: Indicates that signal status is active Pink: Indicates that signal status is inactive												
(4)	Input signal status monitor	Displays the status of input signals. The tab can be switched between "Physical Input" and "Logical Input". Physical Input – Displays the status of input signals to the servo amplifier. Red: Indicates that COM- is connected Pink: Indicates that signal status is open Logical Input – Displays the status of signals within the servo amplifier. Red: Indicates that signal status is active Pink: Indicates that signal status is inactive												
(5)	Internal status monitor	Displays the internal status of the servo amplifier. <table border="1" data-bbox="528 681 1249 996"> <thead> <tr> <th>Name</th> <th>Function</th> </tr> </thead> <tbody> <tr> <td>Commanded position deviation</td> <td>Displays the position deviation of a command unit.</td> </tr> <tr> <td>Actual speed</td> <td>Displays the monitor speed</td> </tr> <tr> <td>Torque command</td> <td>Displays the torque command.</td> </tr> <tr> <td>Load factor</td> <td>Displays the ratio relative to the rated load. Adjust the operation pattern so that 100% is not exceeded.</td> </tr> <tr> <td>Power supply voltage value</td> <td>Displays the voltage (voltage between the P and N terminals) of power supply to the servo amplifier.</td> </tr> </tbody> </table>	Name	Function	Commanded position deviation	Displays the position deviation of a command unit.	Actual speed	Displays the monitor speed	Torque command	Displays the torque command.	Load factor	Displays the ratio relative to the rated load. Adjust the operation pattern so that 100% is not exceeded.	Power supply voltage value	Displays the voltage (voltage between the P and N terminals) of power supply to the servo amplifier.
Name	Function													
Commanded position deviation	Displays the position deviation of a command unit.													
Actual speed	Displays the monitor speed													
Torque command	Displays the torque command.													
Load factor	Displays the ratio relative to the rated load. Adjust the operation pattern so that 100% is not exceeded.													
Power supply voltage value	Displays the voltage (voltage between the P and N terminals) of power supply to the servo amplifier.													
(6)	Pulse sum monitor	Displays the sum of command and encoder pulses received by the servo amplifier.												
(7)	Encoder information monitor	Displays encoder information. <table border="1" data-bbox="528 1114 1249 1242"> <tbody> <tr> <td>Single-turn data</td> <td>Displays an absolute position when the motor makes no more than a single turn.</td> </tr> <tr> <td>Multi-turn data</td> <td>Displays how many turns the motor made after "Clear" operation.</td> </tr> </tbody> </table> <p>Clicking "Clear Multi-turn" resets the multi-turn data stored in the encoder to "0" and clears all encoder errors.</p> <p>Note: Before using "Clear Multi-turn", check the precautions on use. To clear encoder errors, you may need to restart the servo amplifier.</p>	Single-turn data	Displays an absolute position when the motor makes no more than a single turn.	Multi-turn data	Displays how many turns the motor made after "Clear" operation.								
Single-turn data	Displays an absolute position when the motor makes no more than a single turn.													
Multi-turn data	Displays how many turns the motor made after "Clear" operation.													

(Note 1) Because Ethernet communication is used to transfer data between the servo amplifier and PC, there is a difference or delay between the value displayed on the screen and the actual value of the servo amplifier.

(Note 2) When the polarity is "+", symbol "+" is not displayed.

(Note 3) The monitor function is not a measuring instrument. Use the values displayed in the Monitor window as a guide.

(Note 4) If the servo amplifier outputs "Error 40.0 Error protection from absolute system failure" or "Error 42.0 Error protection from absolute overspeed", execute "Clear Multi-turn". Unless the absolute encoder is reset, the alarm cannot be cleared.

15.10 Monitor Window

15.10.2 Checking the Monitor Window

1.2 Procedure

1. From the menu bar on the main pane, select **Display>Monitor**. Alternatively, on the toolbar, click the "Open the Monitor view" icon.



The Monitor window will be displayed.

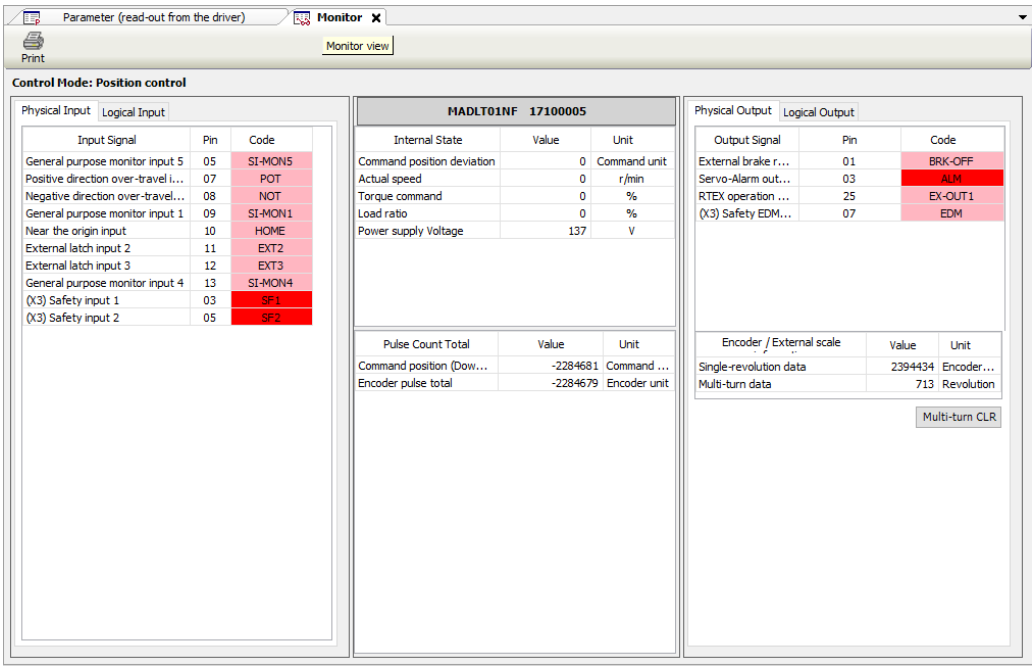

2. Check each item.
Check the input signal state, output signal state, and the internal status of the servo amplifier.
3. Click the [x] button on the Monitor window.
The Monitor window will be closed.

15.11 Alarm Window

If the front panel of the servo amplifier is blinking, such as when the motor is not working, you can check the alarm status. Please note that the alarm cannot be cleared.

15.11.1 Configuration of Alarm Window

Display of the current errors and warnings (only during communication with servo amplifier)

The screenshot shows the 'Alarm' window interface. At the top, there are three callouts: (1) points to the 'Clear' button (red triangle icon), (2) points to the 'Error CD' field in the 'Now Happened Error' table, and (3) points to the 'Cause' field in the 'Cause' table. Below the error table is a table with columns 'Name', 'Value', and 'Unit'. At the bottom, there are two more callouts: (4) points to the 'Warning Function' field in the 'Now Happened Warning' table, and (5) points to the 'Warning Code' field in the same table. On the right side, there is a 'Warning Cause' table with columns 'Warning Cause' and 'Treatment', with callout (6) pointing to the 'Warning Cause' field.

Protection Function	Error CD
Normal	0.0

Name	Value	Unit

Cause	Treatment
Normal	Normal

Warning Function	Warning Code
Normal	00

Warning Cause	Treatment
Normal	Normal

15.11 Alarm Window

Display of error histories

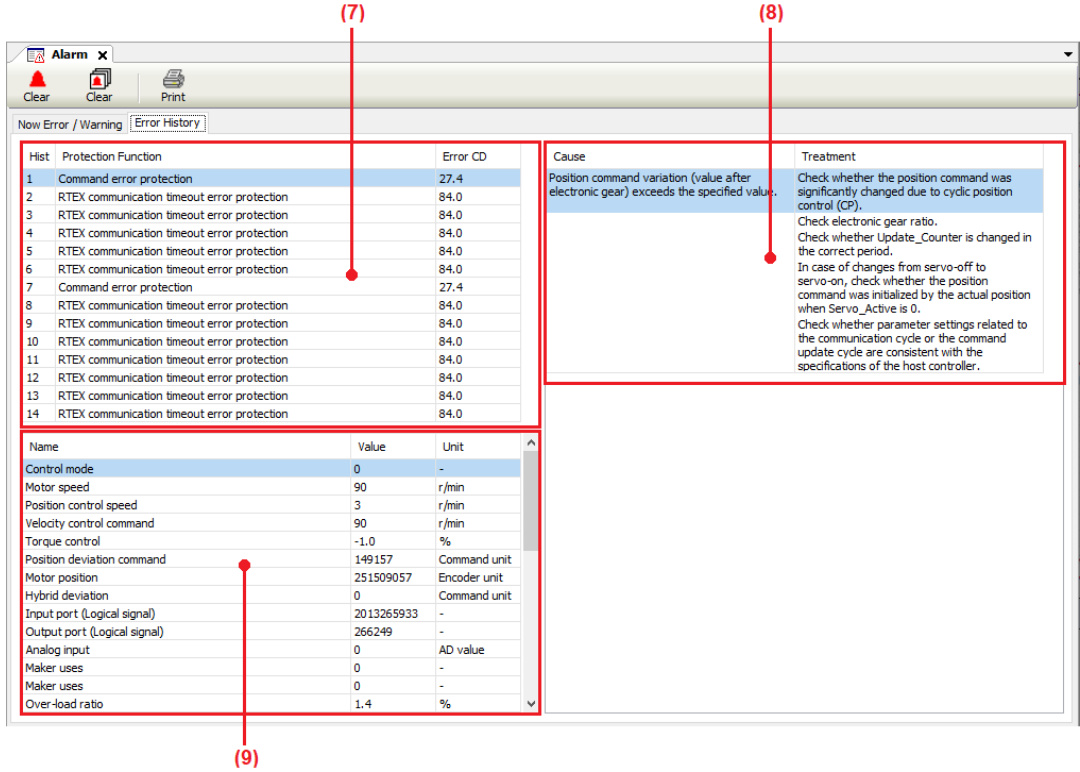

No.	Name	Description												
(1)	Toolbar	<table border="1"> <thead> <tr> <th>Icon</th> <th>Name</th> <th>Function</th> </tr> </thead> <tbody> <tr> <td></td> <td>Clear</td> <td>Allows the user to clear the current alarm history. If you click this button after eliminating the cause of the alarm, the current alarm will be cleared and normal operation will be performed. However, you cannot clear any alarms that cannot be cleared by alarm clear input signals of servo amplifiers. In such a case, turn off the servo amplifier, eliminate the cause of the alarm, and then turn the power on again.</td> </tr> <tr> <td></td> <td>Clear</td> <td>Allows the user to clear error histories.</td> </tr> <tr> <td></td> <td>Print</td> <td>Prints error-related information.</td> </tr> </tbody> </table>	Icon	Name	Function		Clear	Allows the user to clear the current alarm history. If you click this button after eliminating the cause of the alarm, the current alarm will be cleared and normal operation will be performed. However, you cannot clear any alarms that cannot be cleared by alarm clear input signals of servo amplifiers. In such a case, turn off the servo amplifier, eliminate the cause of the alarm, and then turn the power on again.		Clear	Allows the user to clear error histories.		Print	Prints error-related information.
		Icon	Name	Function										
			Clear	Allows the user to clear the current alarm history. If you click this button after eliminating the cause of the alarm, the current alarm will be cleared and normal operation will be performed. However, you cannot clear any alarms that cannot be cleared by alarm clear input signals of servo amplifiers. In such a case, turn off the servo amplifier, eliminate the cause of the alarm, and then turn the power on again.										
	Clear	Allows the user to clear error histories.												
	Print	Prints error-related information.												
(2)	Current error display area	Displays the alarm numbers and names of all errors that are currently occurring. The alarm displayed on the top of the list is the alarm displayed on the front panel of the servo amplifier.												

No.	Name	Description
(3)	Error cause / treatment display area	Displays the cause and treatment of the selected error.
(4)	Motor internal status display area	Displays the motor internal status in the event of an alarm.
(5)	Current warning display area	Displays the warning numbers and names of all warnings that are currently occurring.
(6)	Warning cause / treatment display area	Displays the cause and treatment of the selected warning.
(7)	Error history display area	Displays the order of error histories, alarm numbers, and error names.
(8)	Error cause / treatment display area	Displays the cause and treatment of the selected error.
(9)	Motor internal status display area	Displays the motor internal status in the event of an alarm.

- (Note 1) Some alarms cause tripping as errors but are not recorded in error histories. For alarms that are not recorded in error histories, refer to the instruction manual of the servo amplifier.
- (Note 2) Up to 14 error histories are stored. When more than 14 errors occur, error histories are erased in chronological order (the oldest error history is erased first).
- (Note 3) Up to three histories of motor internal status in the event of an alarm are stored. If an alarm occurs immediately after the power is turned on, motor internal status may not be captured normally.

15.11.2 Checking Alarms

1.2 Procedure

1. From the menu bar on the main pane, select **Display>Alarm**. On the toolbar of the main pane, click the "Open the Alarm view" icon.

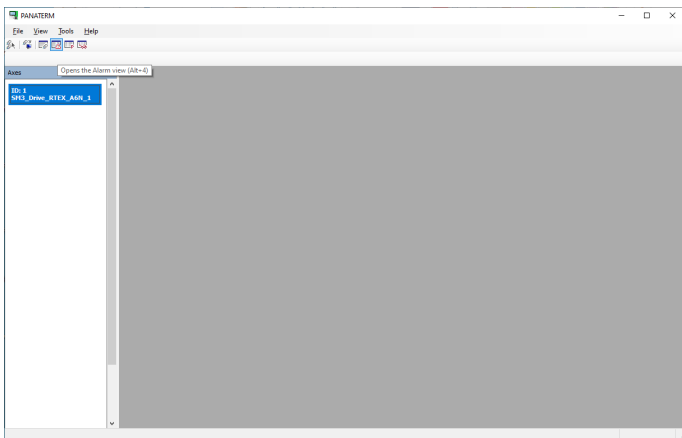

The Alarm window will be displayed.

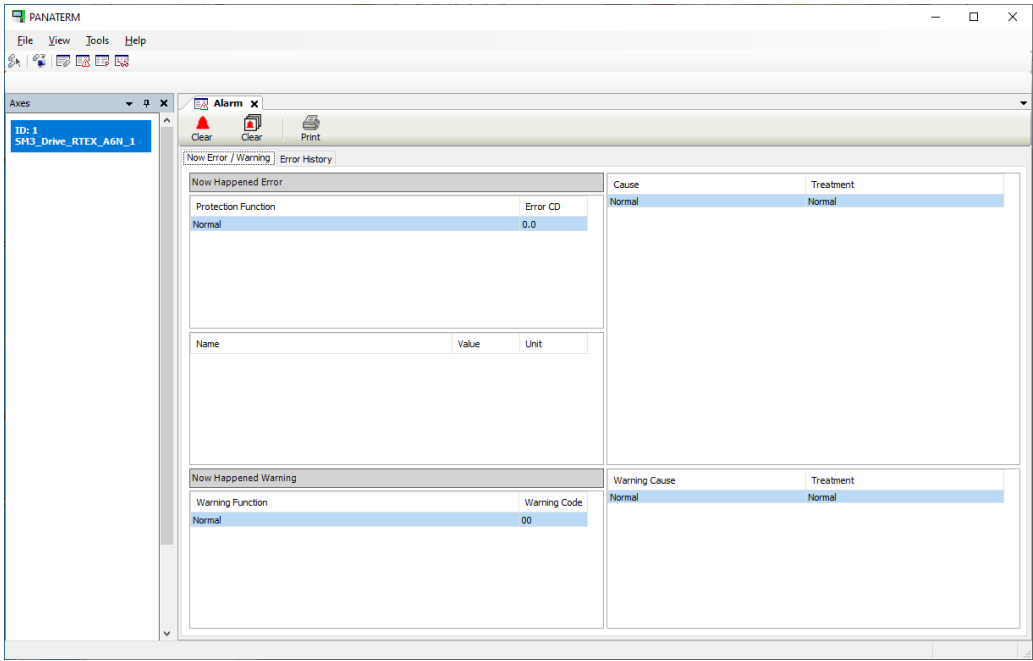

2. Check for any errors that are currently occurring. Click the current "Now Error / Warning" tab and check for any errors that are currently occurring.
3. Check for any errors that occurred in the past.

Click the "Error History" tab and check for any errors that occurred in the past.

4. Click the [×] button on the Alarm window.
The Alarm window will be closed.

15.12 Other Functions

15.12.1 Language Setting Function

This function allows the user to set the display language of PANATERM Lite for GM. The default setting is the same language as the one set in GM Programmer.

1 2 Procedure

1. Select a language from the menu bar tool.
The language set in PANATERM Lite for GM will be switched.

i Info.

- The display language setting of PANATERM Lite for GM is linked with that of the GM Programmer.

15.12.2 Version Display Function

This function allows the user to check the version, license, and other information for PANATERM Lite for GM.

1 2 Procedure

1. From the menu bar, select **Help>Version Info**.



2. Click a desired button at the bottom of the window.

Button	Description
Version Info	Displays information about the plug-ins that have been applied and the operating system of the PC that is used.
License Info	Displays license information for the software used by PANATERM Lite for GM.

15.13 Troubleshooting

15.13 Troubleshooting

15.13.1 Troubleshooting for Servo Amplifiers and Motors

This section explains how to resolve problems.

I Cannot Set up

Symptom	Action method
I cannot set up	<ul style="list-style-type: none">• Refer to the chapter related to the system configuration that you need, and check that the PC in which you install the software satisfies the necessary conditions. In particular, note that all the necessary service packs for the operating system must have been applied.• The installer may have been damaged due to download failure. Clear the browser cache and then download again.

I Cannot Communicate

Symptom	Solution
After PANATERM Lite for GM is started, the servo amplifier is not recognized in the window for connecting to the servo amplifier.	<ul style="list-style-type: none">• Check that the power to the control circuit of the servo amplifier is turned on.• Check the USB communication cable for loose connections or breakage or check whether a correct cable is used.• Check whether the USB port on the PC is functioning normally. (Refer to the instruction manual of the PC.)• Check whether the USB driver is installed correctly.
After PANATERM Lite for GM is started, the GM1 controller is not recognized in the window for connecting to the GM1 controller.	<ul style="list-style-type: none">• Check that the power to the GM1 controller is turned on.• Check the USB communication cable or Ethernet cable for loose connections or breakage or check whether a correct cable is used.• Check whether the USB port on the PC is functioning normally. (Refer to the instruction manual of the PC.)• Check whether the LAN adapter on the PC is functioning normally. (Refer to the instruction manual of the PC.)• Check whether the USB driver is installed correctly.• Check whether Gateway is running.

I Cannot Print

Symptom	Action method
I cannot print	<ul style="list-style-type: none">• Check whether the printer is connected correctly. Check that the printer driver is operating normally, by printing a test page, for example.• You may be unable to print any comment that consists of too many characters in a single line. Split such a comment into

Symptom	Action method
	multiple lines so that the number of characters per line falls within the printable range.

I Cannot Set up Axes

Symptom	Solution
The number of servo amplifiers connected does not match the number of servo amplifiers checked by performing a search.	<ul style="list-style-type: none"> Check whether the axis name (ID) of the servo amplifier connected to the PC is 0, the respective axis names (IDs) of other servo amplifiers are 1 to 15, and there are any duplicate axis names (IDs). Check the communication cable for loose connections or breakage or check whether a correct cable is used.

PANATERM Lite for GM Does Not Behave Normally

Symptom	Solution
PANATERM Lite for GM responds or acts slowly	<ul style="list-style-type: none"> Close any windows that are not used. All windows communicate with the servo amplifier in certain cycles even if they are hidden under other windows. If USB devices other than servo amplifiers are connected, reduce USB communication load by pausing their operations or taking some other action.
The window does not open or icons appear garbled	<ul style="list-style-type: none"> The PC is running out of memory. Temporarily close PANATERM Lite for GM and other applications that are not used. Alternatively, turn the PC off and then on, and start PANATERM Lite for GM again.
PANATERM Lite for GM does not respond	<ul style="list-style-type: none"> Press the <Ctrl> key + <Alt> key + <Delete> key simultaneously to invoke the window for forcibly terminating programs, and terminate PANATERM Lite for GM.
PANATERM Lite for GM suddenly terminates	<ul style="list-style-type: none"> Start PANATERM Lite for GM again.
PANATERM Lite for GM does not start	<ul style="list-style-type: none"> Microsoft .NET Framework Ver. 4.6.1 may have failed to be installed. Refer to the website of Microsoft and install Microsoft .NET Framework Ver. 4.6.1 directly on the PC that you use. After installing Microsoft .NET Framework Ver. 4.6.1, run the PANATERM Lite for GM installer again.

The Parameter Window Does Not Behave Normally

Symptom	Solution
The changed parameter value returns to its original value	<ul style="list-style-type: none"> After changing the parameter value, press the <Enter> key or click the [Trans] button. If you move to another parameter or make changes in the window without performing either of these operations, any change to the parameter value will be canceled. When the values read from a file are displayed in the window, changed parameter values are not sent to the servo amplifier. To send changed parameter values to the servo amplifier, click the [Trans] button.

The Monitor Window Does Not Behave Normally

Symptom	Solution
Monitor display does not change	<ul style="list-style-type: none"> There is a possibility that communication with the servo amplifier has been disrupted and the PC is in an offline state. Check the connection status of the servo amplifier.

The Alarm Window Does Not Behave Normally

Symptom	Action method
Error histories are not displayed	<ul style="list-style-type: none"> If no error has occurred before or error histories have been cleared, error histories are not displayed. Supplementary information about errors is displayed only when the most recent, the second most recent, or the third most recent error history is selected. Select an error history number again. Errors that are not recorded in error histories are not displayed in error histories even if they occur.

Unusual Operation during RTEX Motion Control

Acquiring values on the monitor window and writing or reading on the parameter window cannot be executed simultaneously with the following function blocks.

RTEX_Reset、PMC_Home、PMC_ReadLatchPosition、PMC_StopLatchPosition

MADLT01NF 17080002		
Internal State	Value	Unit
Command position deviation	<Read monitor data failed>	Command unit
Actual speed	<Read monitor data failed>	Command unit/s
Torque command	<Read monitor data failed>	%
Load ratio	<Read monitor data failed>	%
Power supply Voltage	<Read monitor data failed>	V
Pulse Count Total		
	Value	Unit
Command position (Downstream of filter)	<Read monitor data failed>	Command unit
Encoder pulse total	<Read monitor data failed>	Encoder unit

By selecting the theme from the left above, and selecting the sub-theme from the left below, the related parameters can be displayed. To display all parameters in numerical order, please select the "Parameter list", with <Value>, and pressing <Esc> can cancel the change. It becomes effective by pressing <Enter>.

ASNF Parameter list

Class	No	Parameter Name	Setup Range	Value	Unit
00	000	Rotational direction setup	0 - 1	<Execute command failed.>	
00	001	Control mode setup	0 - 6	<Execute command failed.>	
00	002	Real-time auto-gain tuning setup	0 - 6	<Execute command failed.>	
00	003	Selection of machine stiffness at real-time auto-gain tuning	0 - 31	<Execute command failed.>	
00	004	Inertia ratio	0 - 10000	<Execute command failed.>	%
00	008	Command pulse counts per one motor revolution	0 - 8388608	<Execute command failed.>	pulse
00	009	Numerator of electronic gear	0 - 1073741824	<Execute command failed.>	
00	010	Denominator of electronic gear	1 - 1073741824	<Execute command failed.>	
00	011	Output pulse counts per one motor revolution	1 - 2097152	<Execute command failed.>	pulse/r
00	012	Reversal of pulse output logic/output source selection	0 - 3	<Execute command failed.>	
00	013	1st torque limit	0 - 500	<Execute command failed.>	%
00	014	Position deviation excess setup	0 - 1073741824	<Execute command failed.>	Unit dependent
00	015	Absolute encoder setup	0 - 4	<Execute command failed.>	
00	016	External regenerative resistor setup	0 - 3	<Execute command failed.>	
00	017	Load factor of external regenerative resistor selection	0 - 4	<Execute command failed.>	
00	018	For manufacturer's use	0 - 1	<Execute command failed.>	

(MEMO)

Appendix Warranty / Cautions for Proper Use

Warranty	App-2
Warranty Period	App-2
Warranty Scope	App-2
Cautions for Proper Use	App-3

Warranty

Warranty Period

The warranty period of the Product shall be 12 months from the ex-factory date or 18 months from the date of manufacturing unless otherwise specified between both parties.

Warranty Scope

Panasonic warrants the replacement of the defected parts of the Product or repair of them when the defects of the Product occur during the Warranty Period, and when the defects are under Panasonic responsibility. This Warranty only covers the Product itself and does not cover any damage to your company and the third party incurred by the Product, such as damage that is induced by an object machined or produced using the Product or by the defects of the Product. This Warranty shall be exempted in the following cases,

1. Defects resulting from misuse and/or repair or modification by the customer.
2. Defects resulting from drop of the Product or damage during transportation.
3. Defects resulting from improper usage of the Product beyond the Specifications.
4. Defects resulting from fire, earthquake, lightening, flood, damage from salt, abnormal voltage or other Act of God, or other disaster.
5. Defects resulting from the intrusion of foreign material to the Product, such as water, oil or metallic particles.
6. Parts exceeding their standard lifetime specified in this document.
7. The machines are not assembled in accordance with the instructions or precautions noted in this specification.
8. When the machine does not match the Product assembled in the machine.
9. When the machine condition is not caused by Panasonic reasons.
10. Defects that Panasonic could not foresee at the time of delivery of the Product.

Cautions for Proper Use

■ Selection of a power supply

- Use a low noise power supply.
- The inherent noise resistance is sufficient for the noise superimposed on the power wires, however, the noise can be attenuated further by using the isolation transformer / insulated power supply.

■ Isolation of power supply systems

- Wiring to the units, I/O devices, and other power devices should have separate wiring systems.

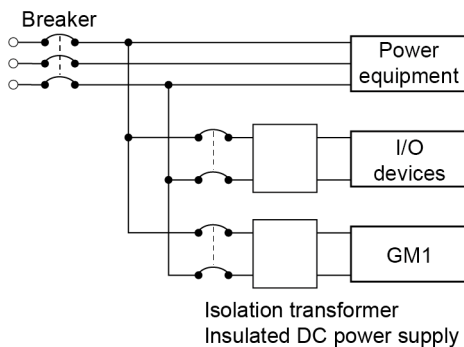

■ Power supply sequence

- Start the GM1 controller only after I/O devices and power devices are energized. In case of stopping the operation of the GM1 controller, have the I/O devices or power devices turned OFF after the GM1 controller has stopped operating.

■ Grounding

- The grounding connection should have a resistance of 100 Ω or less.
- The point of grounding should be as close to the GM1 controller as possible. The ground wire should be as short as possible.
- Sharing the ground with another device may have an adverse effect. Therefore, be sure that grounding is dedicated.

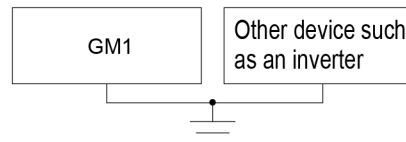
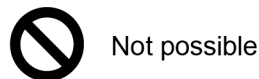
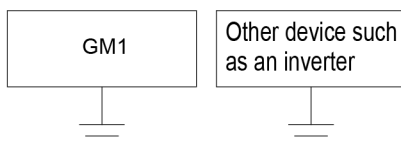

Conversely, depending on your environment, grounding may cause a problem. Do not ground the function earth when grounding a plus (+) terminal of the power.

Cautions for Proper Use

■ **Wiring**

- Turn OFF the power supply when carry out wiring or connecting the GM1 controller to expansion units.
- Noise resistance measures such as attaching a noise filter, a surge absorber or a ferrite core may be necessary in some cases, depending on the usage environment.

■ **Installation of an interlock circuit**

- When controlling conflicting operations such as the motor rotation in clockwise or counter-clockwise direction, provide an interlock circuit external to the GM1 controller.

■ **Installation of an emergency stop circuit**

- Provide an emergency stop circuit external to the GM1 controller to turn OFF the power supply of the output device.

■ **Installation environment**

Do not use it in the following environments.

- Direct sunlight
- Sudden temperature changes causing condensation.
- Inflammable or corrosive gas.
- Excessive airborne dust, metal particles or saline matter.
- Benzine, paint thinner, alcohol or other organic solvents or strong alkaline solutions such as ammonia or caustic soda.
- Direct vibration, shock or direct drop of water.
- Influence from power transmission lines, high voltage equipment, power cables, power equipment, radio transmitters, or any other equipment that would generate high switching surges. (100 mm or more)

■ **Handling instructions**

- Before touching the unit, always touch a grounded piece of metal in order to discharge static electricity.
- Always rid yourself of any static electricity before handling this product.
- Do not connect a unit other than our GM1 series to the side connector on the unit.
- Use copper wires with a temperature rating of 90°C or higher.

Revision History

The manual code is shown at the bottom of the cover page.

Date of issue	Manual code	Revision details
August 2024	WUME-GM1OP-01	<p>1st Edition</p> <ul style="list-style-type: none">• Integrated the following four manuals.<ul style="list-style-type: none">• User's Manual (Setup Edition) WUME-GM1ETCSU-04• User's Manual (Setup Edition) WUME-GM1RTXSU-05• User's Manual (Operation Edition) WUME-GM1ETCOP-08• User's Manual (Operation Edition) WUME-GM1RTXOP-09• Added description of serial communication units• Added description of CNC control (Import DXF File function)• Changed description of the velocity ramp type \sin^2 in Axis Extended Setting• Enable symbol set in Symbol Configuration• Added the source download function• Changed description of the instruction help function

(MEMO)

(MEMO)

Please contact

**Industrial Device Business Division,
Panasonic Industry Co., Ltd.**

7-1-1 Morofuku, Daito City, Osaka, 574-0044, Japan
industrial.panasonic.com/ac/e/

© Panasonic Industry Co., Ltd 2024

WUME-GM10P-01