

STATE-OF-THE-ART

LITHIUM BATTERIES

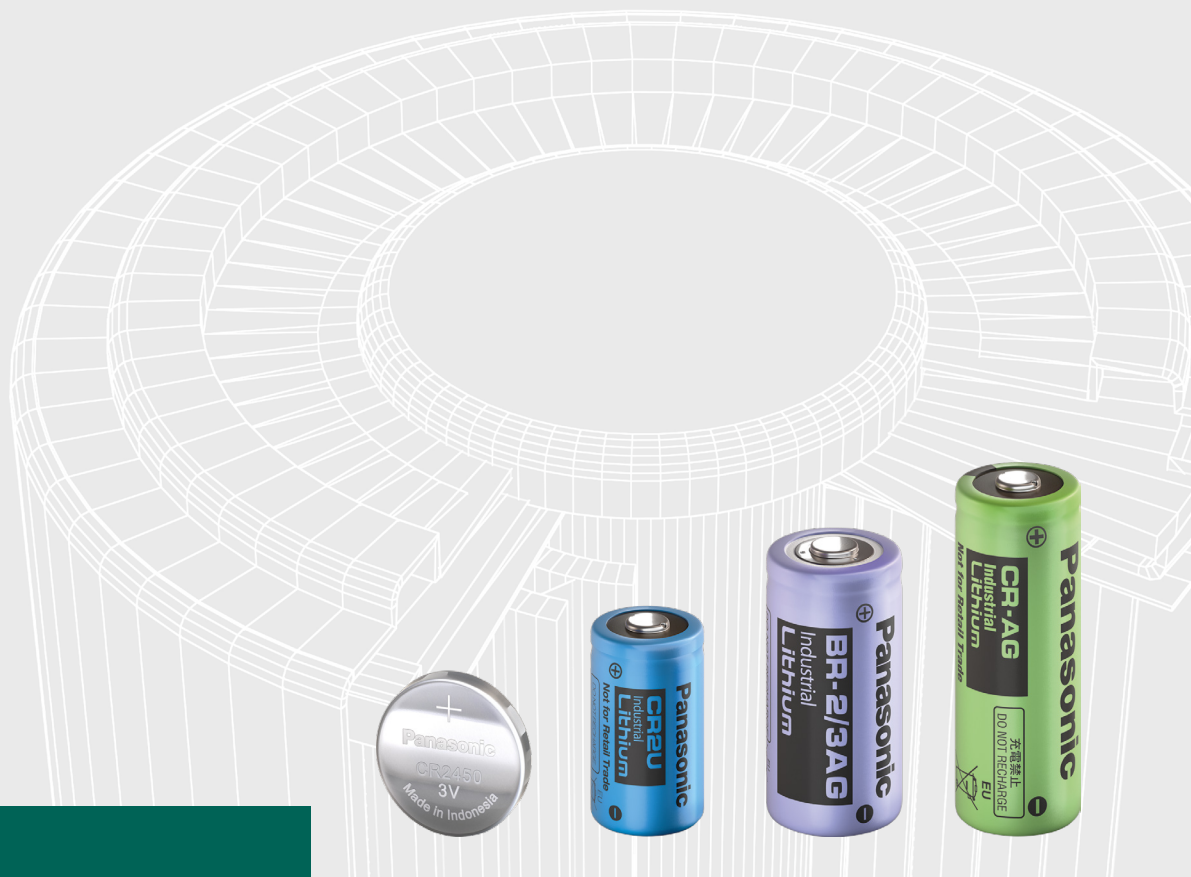

TECHNICAL HANDBOOK

INDUSTRIAL BATTERIES FOR PROFESSIONALS

FIND THE RIGHT CONTENT

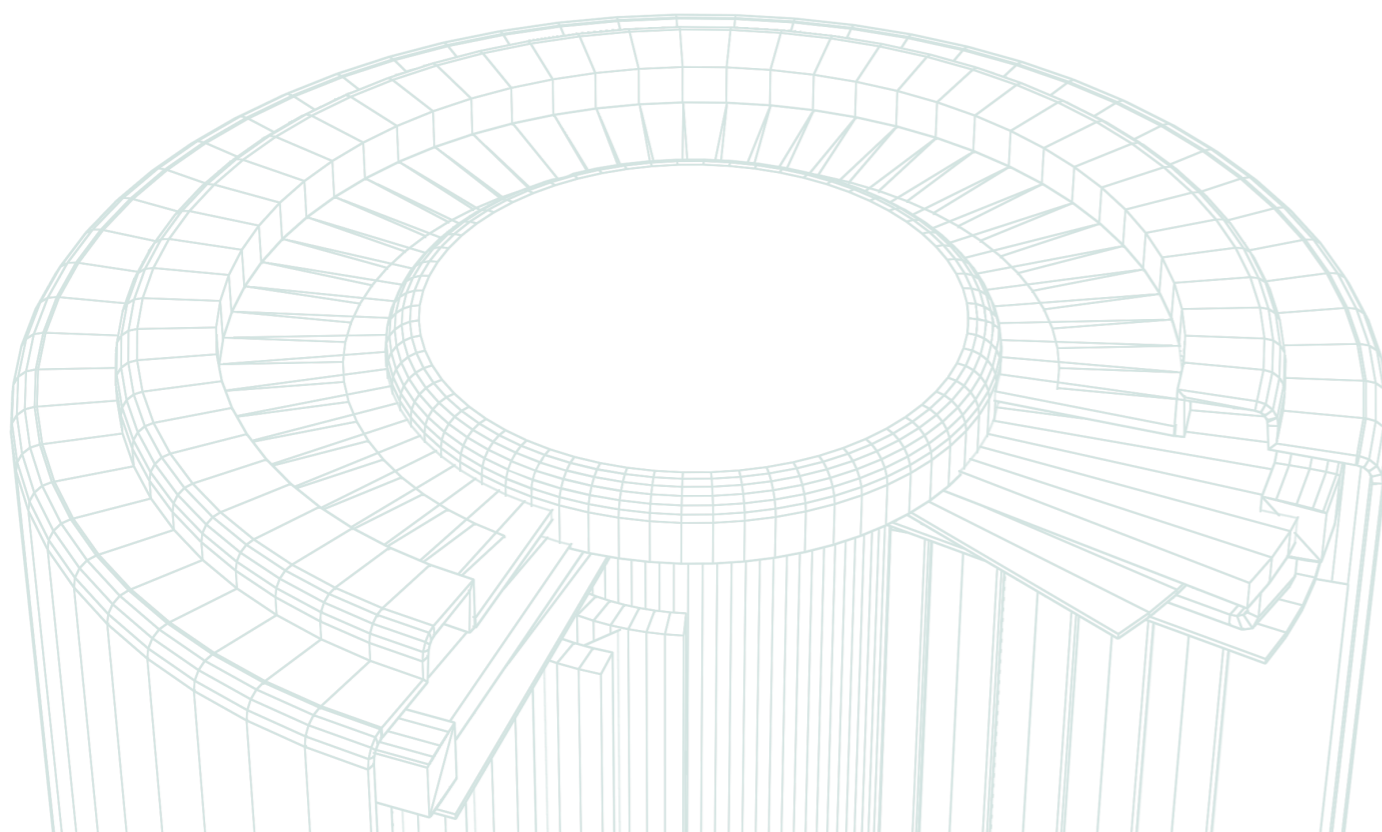

INDEX

CHAPTER	CONTENT	PAGE
1	About Panasonic	4
1.1	Panasonic - the world's largest battery manufacturer	5
1.2	Panasonic green impact: building a net-zero future together. Empowering energy solutions with secondary batteries	6
1.3	Information channels: Mediapool and YouTube	8
2	Lithium & micro batteries: Types & features	10
2.1	About our Lithium products	11
2.2	Safety warnings and precautions	12
2.3	Introduction	13
2.4	General features	15
2.5	Primary vs. secondary Lithium batteries	18
2.6	Applications	19
2.7	Selecting a battery/model number	20
2.8	Battery selection chart	22
2.9	General safety precautions for using, handling and designing	27
2.10	Design for memory back-up use	31
3	Primary Lithium batteries – non rechargeable	32
3.1	Poly-carbonmonofluoride Lithium batteries (BR series) – cylindrical type	33
3.2	Manganese dioxide Lithium batteries (CR series for consumer) – cylindrical type	37
3.3	CR Lithium cylindrical series for industrial	40
3.4	Poly-carbonmonofluoride Lithium batteries (BR series) – coin type	46
3.5	High operating temperature poly-carbonmonofluoride Lithium batteries (BR-A series) – coin type	51
3.6	Manganese dioxide Lithium batteries (CR series) – coin type	55
3.7	High temperature manganese dioxide Lithium batteries (CR-A/B series) – coin type	65
3.8	Poly-carbonmonofluoride Lithium batteries (BR series) – pin type	69
4	Secondary Lithium batteries – rechargeable coin & pin type batteries with remarkable characteristics	71
4.1	Vanadium rechargeable Lithium batteries (VL series) – coin type	72
4.2	Manganese rechargeable Lithium batteries (ML series) – coin type	77
4.3	Cobalt Titanium rechargeable Lithium batteries (CTL series) – coin type	81
4.4	Titanium rechargeable Lithium batteries (MT series) – coin type	84
4.5	Lithium-ion rechargeable batteries (CG Series) – pin type	88
4.6	Lithium battery terminals and soldering	93
5	Standards and regulations	100
5.1	Avoiding hazards	101
5.2	Preventing quality problems	102
6	Contact	106

ONE OF THE WORLD'S LARGEST BATTERY MANUFACTURERS

The Panasonic Energy Co., Ltd. is globally active in our consumer battery business that supports everyday convenience and comfort, as well as our B2B business such as industrial batteries and automotive batteries that support social infrastructure across a broad area.



17 CO₂-FREE FACTORIES*¹

Our goal is to produce our products with zero emissions by 2050. Already today, our batteries are manufactured emission-free in 17 factories. Find out more on page 6.

ABOUT PANASONIC

BATTERY
PRODUCTION
SINCE **1931**

17 FACTORIES*¹
ZERO-CO₂

ABOUT
19,000*²
EMPLOYEES

20
FACTORIES

Panasonic
ENERGY

0 NUMBER OF
SERIOUS
PRODUCT
ACCIDENTS*⁴

12
SALES OFFICES

SALES
5.8*³
BILLION

PATENTS
7,600

OPERATING PROFIT
562*³
MILLION



For nearly 100 years, Panasonic has contributed to enriching people's lifestyles and making society more convenient through the introduction of various industry-first technologies as a leading battery manufacturer. Our strengths are our technological capabilities in materials development, manufacturing, and intellectual property. These key strengths serve as an "Enabler" for our customers in market creation and solutions providing combined with our highly reliable brand record that we have cultivated over many years.

Going forward, we will focus on the 'automotive' and 'industrial and consumer' businesses, namely the 'green' and 'digital' fields, where we can make a significant contribution to solving environmental issues and leverage our strengths. In the automotive business, electric vehicles (EVs) are entering a period of fully-fledged dissemination on a global scale aiming to reduce environmental impact, as the global battery market is increasing significantly. In the industrial and consumer business, new demands are being generated due to the accelerating electrification of social infrastructure, such as increased data volume due to the expansion of the digital society and the effective use of renewable energy.

In these focused fields, we will maximize our contribution to society by reducing CO₂ emissions, establishing a safe and secure social infrastructure, and providing convenient and comfortable lifestyles through our cutting-edge technologies and diverse product lineup.

*¹ August 2024

*² Consolidated, as of April 1, 2024

³ FY 2023 refers to the year ending March 31, 2024

*⁴ Zero battery-attributed recalls of automotive Lithium-ion batteries

PANASONIC GREEN IMPACT: BUILDING A NET-ZERO FUTURE TOGETHER.

At Panasonic Holding, we commit to significantly reducing our CO₂ emissions, striving to achieve net-zero emissions by 2050. This forms the foundational pillar of the Panasonic GREEN IMPACT initiative. The second pillar revolves around empowering society to avoid emissions through the widespread deployment of our existing and upcoming technologies to customers globally. Together, we forge a path toward a sustainable future.

With 31 net-zero CO₂ factories already now and all of the approximately 250 Panasonic factories globally converted into net-zero factories by 2030, we take on the challenge of achieving net-zero CO₂ emissions across our entire value chain by 2050. But sustainability is not only the center of attention in our production:

Panasonic Holding provides products that are essential building blocks in the joint effort to respond to the needs of today's world. Join us in our obligation to maintain and nurture the ecology of this planet.

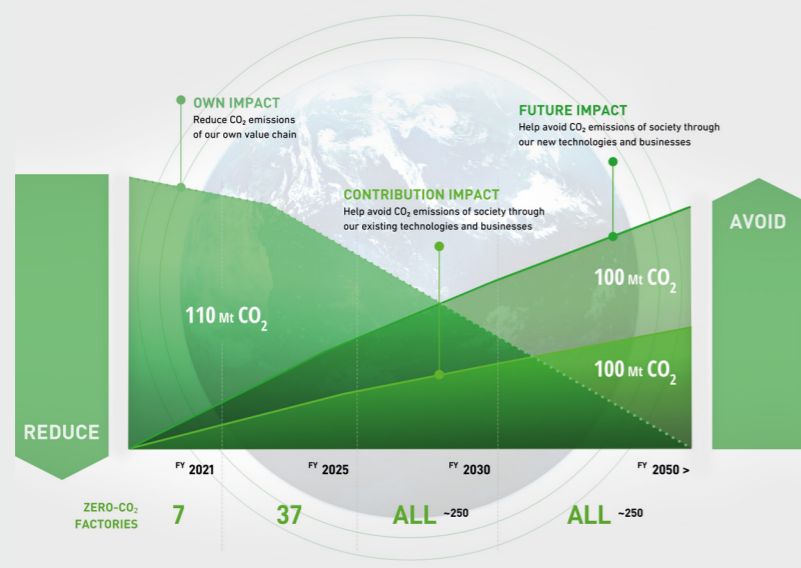

EMPOWERING ENERGY SOLUTIONS WITH SECONDARY BATTERIES

Harness the power of innovation with our reliable Nickel-Metal-Hydrate secondary batteries. Designed to store energy efficiently and sustainably, they play a pivotal role in powering our rapidly evolving world. From renewable energy storage like solar systems and wind turbines, our secondary batteries are the go-to choice for reliability and long-lasting performance of up to 10 years. Produced without Lead or Cadmium and in a net-zero factory in Wuxi (China), our Nickel-Metal-Hydrate batteries can be your sustainable energy storage solution.

If your application needs a high energy density battery, we are ready to guide you through our comprehensive lineup of Lithium-ion cells. Here, we work on three areas: strengthening our competitiveness, enhancing our supply chain, and expanding our production capacity.

OUR MISSION

Achieving a society in which the pursuit of happiness and a sustainable environment are harmonized free of conflict.

OUR VISION

Energy that changes the future.

OUR WILL

Doing what humankind requires.



Environmental management



Zero CO₂ factories



Global warming prevention



Resource recycling



Environmental communication



Environmental performance

INFORMATION CHANNELS: MEDIAPOL AND YOUTUBE

MEDIAPOL

A MEDIA LIBRARY, JUST AS USERS EXPECT IT.

Our online library offers a wide range of images, videos, datasheets, manuals, and catalogs, as well as whitepapers. All content is categorized, but can also be found through the search function. Each relevant search result in the preview can be downloaded through the shopping cart. Additionally, the URL of a media asset can be easily copied and shared.

Get a first idea of how to use the Mediapool, or simply download any file you need. Our Mediapool is accessible for free and without registration.

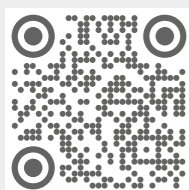

Watch introduction video

Get a first idea of how to use the Mediapool with our brief introduction video.

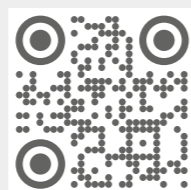

Use Mediapool directly

YOUTUBE CHANNEL

OUR BATTERIES VIDEO WORLD

On our Panasonic batteries YouTube channel you can discover videos about the inner structure of our different battery chemistries, a couple of application videos and films which explain why batteries sometimes help to save human lives and sharks' lives as well. Are you getting curious? Please follow the QR code to our Panasonic batteries YouTube channel.

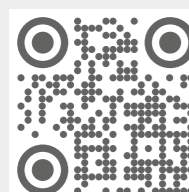

Discover more on our YouTube channel

FIND THE RIGHT
MEDIA ASSET



LITHIUM & MICRO BATTERIES

TYPES & FEATURES

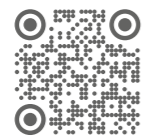

YOUR INFORMATION
Visit our product page and get detailed information about Lithium batteries.

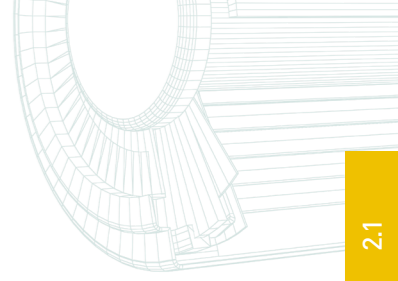

ABOUT OUR LITHIUM PRODUCTS

Ever since Panasonic became the first company in the world to develop and commence the mass production of Lithium batteries for consumer products in 1971, Panasonic has launched a series of lithium batteries in many shapes and sizes including cylindrical types, coin types and pin types. Panasonic has also successfully introduced coin type rechargeable Lithium batteries to the market for applications such as memory back-up or watches.

such products as electronic watches or applications as power supplies for IC memory back-up which require long-term reliability.

Panasonic has conducted repeated tests on the various safety and performance characteristics, plus the effects of environmental factors such as temperature. We have accumulated a wealth of corroborative data on the performance of our batteries which cannot be pinpointed by short-term accelerated tests. As a result, Panasonic batteries have won approval under the UL safety standards in the United States and wide recognition throughout the world for their high reliability and safety.

Today, Lithium batteries have a proven track record of opening up a host of new fields where conventional batteries cannot be used. Applications range from high-current discharge applications typified by 35 mm cameras to ultra-low current discharge applications in

<p>UP TO +125°C WIDE TEMPERATURE RANGE <small>(DEPENDING ON CELL MODEL)</small></p>	<p>6 DIFFERENT SUB CHEMIS-TRIES</p>	<p>ECO FRIENDLY NO TOXIC MATERIALS</p>	<p>4 FACTORIES TO SUPPORT GLOBAL DEMAND</p>
<p>TAYLOR-MADE PACKS & TERMINALS</p>	<p>LITHIUM</p>		<p>ISO 9001 QUALITY</p>
<p>IATF 16949-2016 AUTOMOTIVE</p>	<p>NO PASSIVATION</p>	<p>BATTERY SAFETY IEC 62133-1 IEC 60086-4</p>	<p>> 20 YEARS LONG LIFE <small>(DEPENDING ON USAGE CONDITIONS)</small></p>
<p>SINCE 1971 PRODUCTION</p>	<p>> 50 YEARS EXPERIENCE</p>	<p>NO TOXIC MATERIALS</p>	<p>ISO 14001 ENVIRONMENT</p>

SAFETY WARNINGS AND PRECAUTIONS

Please be sure to observe the following warnings. As batteries contains flammable substances such as lithium or other organic solvents, they may cause heating, rupture or ignition.

CYLINDRICAL TYPE LITHIUM BATTERIES

WARNING

- It may cause rupture or ignite.
 - Do not charge, short (an exception is to pass batteries through dipping solder) disassemble, deform or heat batteries. Do not throw batteries into fire.
 - Do not connect the ⊕ and ⊖ electrodes to each other with metal or wire. Do not carry or store batteries together with a metallic necklace, etc
 - Avoid inversed connection of ⊕ and ⊖ terminals to devices
 - Avoid mixed use of new and old batteries or batteries of other series.
 - Avoid direct soldering to batteries.

- When discarding batteries, insulate the ⊕ and ⊖ terminals of batteries with insulating tape, etc. (see fig. 1).
When disposed of improperly, lithium batteries may short, causing them to become hot, burst or ignite.
- Keep batteries out of reach of small children. Should a child swallow a battery, consult a physician immediately.

CAUTION

Keep batteries away from direct sunlight, high temperature, and high humidity.

COIN TYPE LITHIUM BATTERIES

WARNING

- Do not charge, short (an exception is to pass batteries through dipping solder) disassemble, deform or heat batteries. Do not throw batteries into fire.
- Keep batteries out of reach of small children. Should a child swallow a battery, consult a physician immediately.
- When discarding batteries, insulate the ⊕ and ⊖ terminals of batteries with insulating tape, etc. (see fig. 1). When disposed of improperly, lithium batteries may short, causing them to become hot, burst or ignite.

CAUTION

- Be sure to connect the ⊕ and ⊖ electrodes correctly.
- Avoid mixed use of batteries, i.e. new, used or different types.
- Avoid direct soldering to batteries.
- Keep batteries away from direct sunlight, high temperature, and high humidity.

COIN TYPE RECHARGEABLE LITHIUM BATTERIES

WARNING

- Do not short-circuit (an exception is to pass batteries through dipping solder), disassemble, deform or heat batteries. Do not throw batteries into fire.
- Do not charge rechargeable batteries with a higher voltage than specified.
- Keep batteries out of reach of small children. Should a child swallow a battery, consult a physician immediately.
- When discarding batteries, insulate the ⊕ and ⊖ terminals of batteries with insulating tape, etc. (see fig. 1). When disposed of improperly, lithium batteries may short, causing them to become hot, burst or ignite.

CAUTION

- Be sure to connect the ⊕ and ⊖ electrodes correctly.
- Avoid mixed use of batteries, i.e. new, used or different types.
- Avoid direct soldering to batteries.
- Keep batteries away from direct sunlight, high temperature, and high humidity.

FIG. 1 When disposing batteries (example of insulating)*1

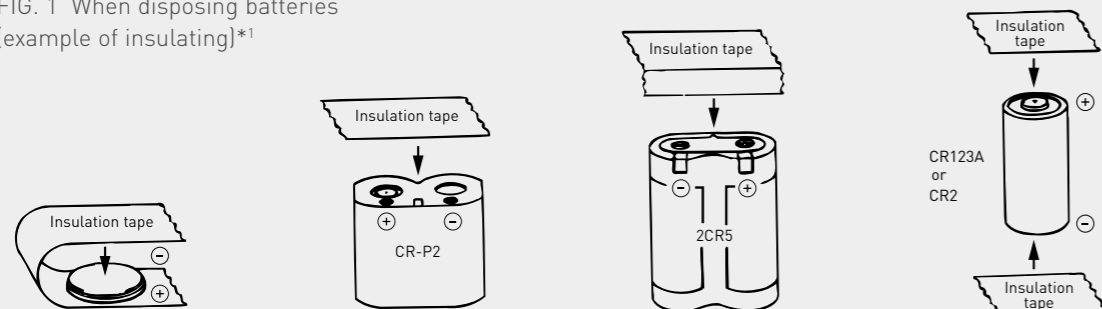

The data in this document are for descriptive purposes only and are not intended to make or imply any guarantee or warranty.
*1 Discharge circuits will be made by the contact of batteries, which may cause heating, rupture, or ignition of batteries.

INTRODUCTION

These days Lithium battery technologies are getting more and more important. Due to their high voltage, low self-discharge and proven reliability a broad range of applications can be powered. In particular the BR, CR and ER battery technologies are leading the industries. Please study the comparison overview below and find out why Panasonic is especially emphasizing on its famous BR and CR technology which is a proof for outstanding quality for years in the market.

PRIMARY VS. RECHARGEABLE LITHIUM BATTERIE CHEMISTRIES*1

CHEMISTRY		PANASONIC BR	PANASONIC CR	GENERAL ER	
MATERIAL	Cathode	CF	MnO ₂	SOCl ₂	
	Anode	LITHIUM METAL			
	Electrolyte	ORGANIC ELECTROLYTE			
PERFORMANCE	Nominal voltage	3V	3V	3.6V	
	Voltage during discharge (Initial)	LOW CURRENT	++	++	+
		HIGH CURRENT	+	++	-
	Voltage during discharge (End of capacity)	LOW CURRENT	++	++	++
		HIGH CURRENT	+	++	-
	Pulse performance at low temperature	INITIAL	+	++	-
		END OF LIFE	+	++	-
	Storage performance	++	+	- ^{*2}	
	Reliability	++	+	- ^{*2}	
	Safety	++	++	-	
ENVIRONMENT	Eco friendly	++	++	- ^{*3}	

++ Very good capability + Good capability - Not good capability

*1 Please contact Panasonic to get more detailed information about this technical comparison overview.
*2 Impedance increasing due to the passivation phenomena.
*3 Harmful substances included.

TYPES OF LITHIUM & MICRO BATTERIES

LITHIUM & MICRO BATTERIES

PRIMARY LITHIUM BATTERIES (NON-RECHARGE-ABLE)

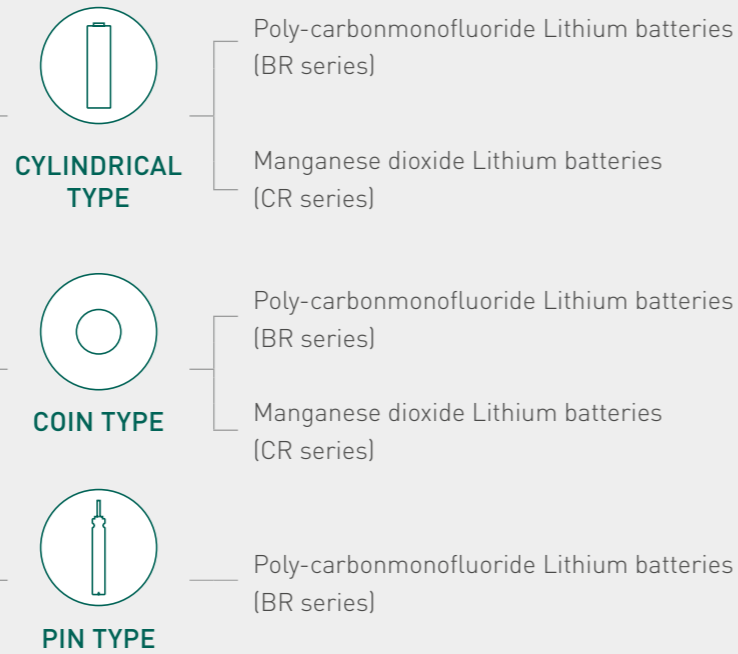

SECONDARY LITHIUM BATTERIES (RECHARGE-ABLE)

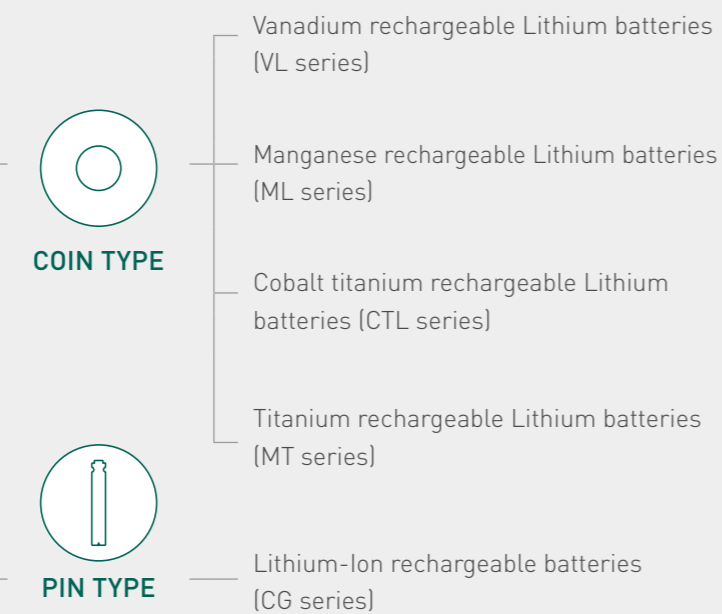

GENERAL FEATURES

HIGH VOLTAGE

The high energy density of lithium batteries and their high voltage of 3V (there are 1.5V and 3.8V lineups also) make them ideally suited for use in all kinds of products where the trend is to achieve increasing miniaturization. A single lithium battery can replace two, three or more conventional batteries.

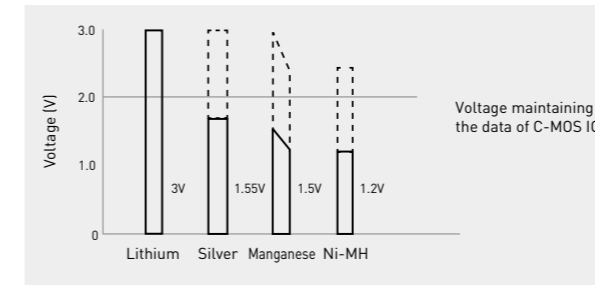

LONG-TERM DISCHARGE

Long-term discharge has been verified at all operating temperatures under low-load discharge conditions.

CR-2/3AZ

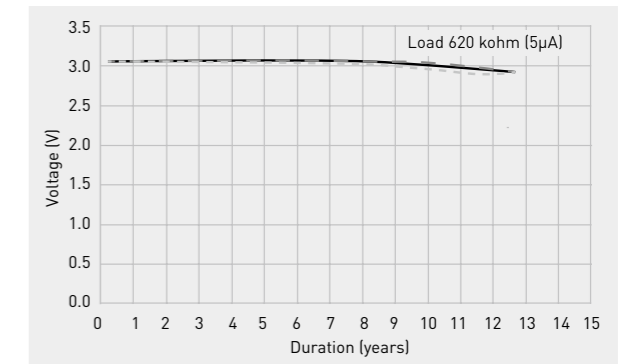

BR-2/3A

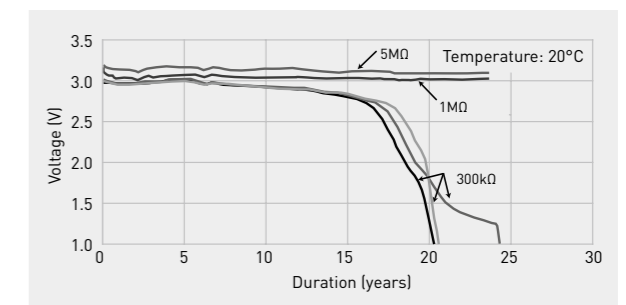

BR-2325

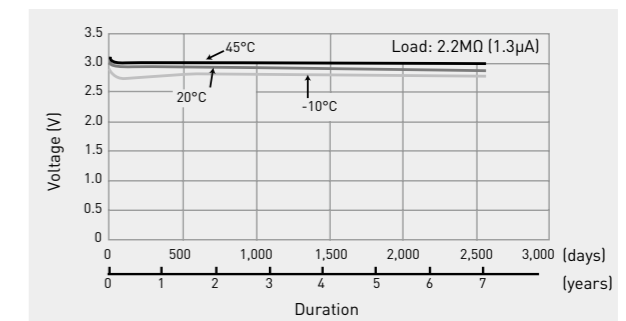

LOW SELF-DISCHARGE RATE AND SUPERIOR STORABILITY

Since the substance that is chemically very stable is used for plus terminal as an active material (BR series: Poly-Carbonmonofluoride, CR series: Manganese Dioxide), if preservation conditions are proper, 90% of capacity remains even after ten years storage.

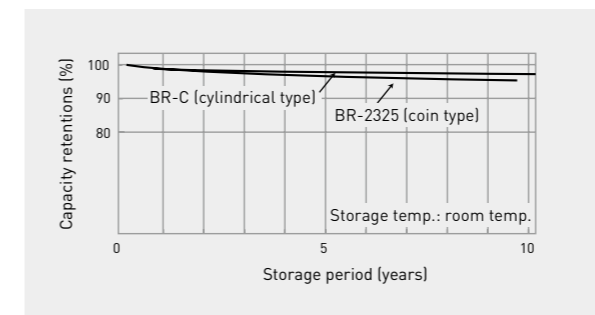

BR-2330A

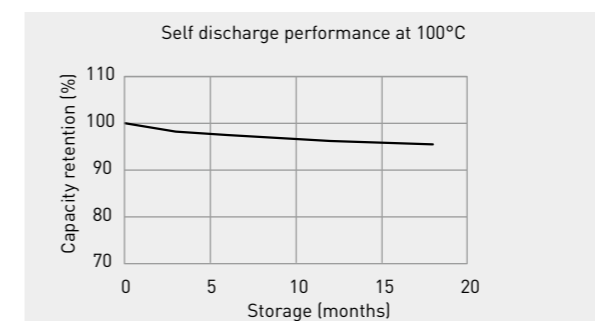

BR-C

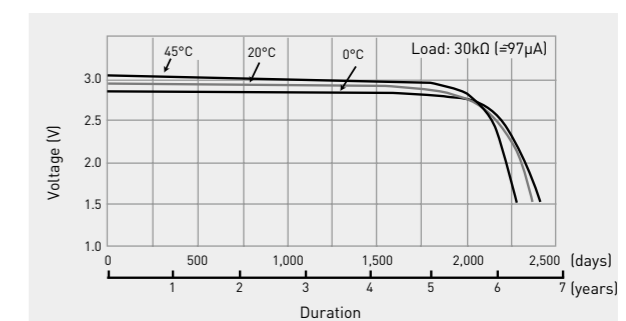

GENERAL FEATURES

OUTSTANDING ELECTROLYTE LEAKAGE RESISTANCE

Lithium batteries employ organic electrolytes with minimum creeping so they are vastly superior in terms of leakage resistance under environmental changes compared to other types of batteries that employ aqueous solution electrolytes. The batteries achieve stable characteristics under high temperature and humidity conditions (45°C/90% RH, 60°C/90% RH), and even under heat shock which constitutes the severest challenge for batteries.

WIDE OPERATING TEMPERATURE RANGE

Due to the use of organic electrolytes with a solidifying point that is much lower than the aqueous solution electrolytes used in other types of batteries, lithium batteries are capable of operation in a wide range of temperatures. Not only do the high operating temperature BR series cells use a special engineering plastic as the material for the gasket and separator instead of the conventional polyolefin resin but its operating temperature range has also been significantly increased by employing an electrolyte with a high boiling point.

SUPERIOR SAFETY

Lithium batteries feature stable substances for the active materials and a structural design that assures safety and, as such, their superior safety has been verified from the results of repeatedly subjecting them to a number of different safety tests. As a result, Panasonic's Lithium batteries have been approved under the safety standard (UL1642) of UL (Underwriters Laboratories Inc.).

BATTERY SURFACE TEMPERATURE WHEN SHORT-CIRCUITED

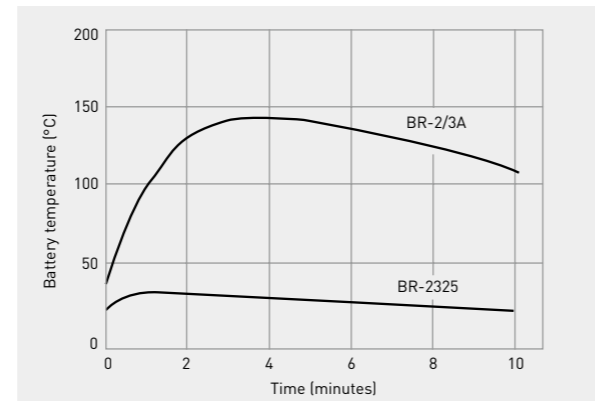

BR-2325
Operating voltage under high-resistance discharge

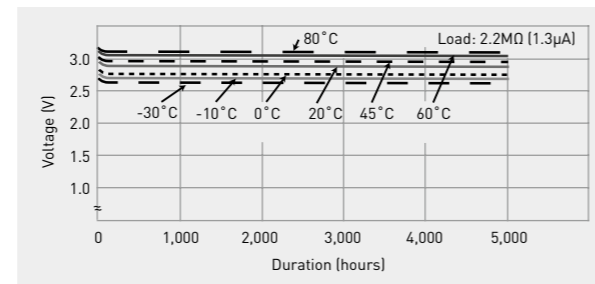

BR-2/3A
Current drain vs. operation voltage

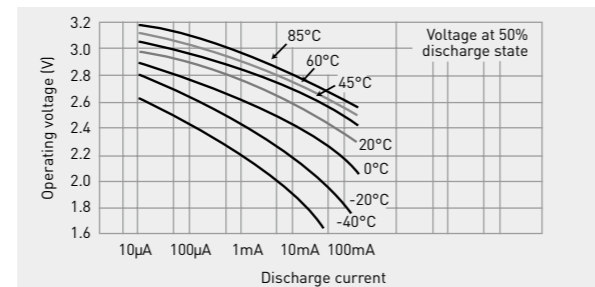

BR-2325
Charge resistance (10V consistent-voltage charge)

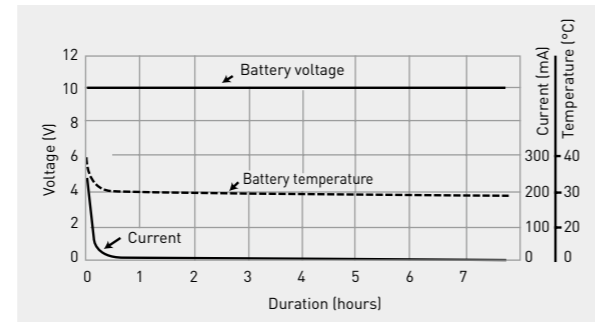

GENERAL FEATURES

LEAKAGE RESISTANCE TEST RESULTS

MODEL NUMBER	CONDITIONS STORAGE	60°C		45°C/90%		60°C/90%		Temp. cycle	Heat shock
		1 month	3 months	1 month	3 months	1 month	3 months	60 cycles	120 cycles
BR-2325		✓	✓	✓	✓	✓	✓	✓	✓
BR-2/3A		✓	✓	✓	✓	✓	✓	✓	✓

LEAKAGE RESISTANCE EVALUATION ITEMS

	TEST CONDITIONS	
HIGH TEMPERATURE STORAGE	60°C	
HIGH TEMPERATURE	45°C/90% RH	
HIGH HUMIDITY STORAGE	60°C/90% RH	
TEMPERATURE CYCLE		
HEAT SHOCK		

PRIMARY VS. SECONDARY LITHIUM BATTERIES

COIN TYPE RECHARGEABLE LITHIUM BATTERIES

Rechargeable lithium batteries come with excellent characteristics and high reliability.

- Long-term reliability
- High capacity
- Low self-discharge rate
- Resistance to continuous discharge
- Resistance to over discharge

COMPARISON TABLE OF LITHIUM BATTERY TYPES

ITEM	TYPE MODEL	PRIMARY BATTERY		SECONDARY BATTERY			
		BR	CR	VL	ML	MT	CG
MATERIAL	⊕ electrode	ICFn	MnO ₂	V ₂ O ₅	LixMnOy	LixOy	Co
	⊖ electrode	Li	Li	LiAl	LiAl	LixTiOy	Li
NOMINAL VOLTAGE (V)		3.0	3.0	3.0	3.0	1.5	3.8
OPERATING TEMPERATURE RANGE (°C)		Cylindrical: -40 to +85	Cylindrical: -40 to +70 -85				
		Coin: -30 to +85	Coin: -30 to +85				
		High operating temperature coin: -40 to +125	High operating temperature coin: -40 to +105	-20 to +60	-20 to +60	-10 to +60	0 to +60 (charging)
		Pin: -30 to +80	-125				-20 to +60 (discharging)
SELF-DISCHARGE (per year) under standard conditions	Cylindrical type	0.5%	1.0%	2.0%	2.0%	2.0%	1.0%
	Coin type	1.0%	1.0%				
AVERAGE DISCHARGE VOLTAGE (V)		-	-	2.85	2.5	1.2	3.7
CHARGE VOLTAGE (V)		-	-	3.25 to 3.55	2.8 to 3.2	1.6 to 2.6	4.3
CUT OFF VOLTAGE (V)		2.0	2.0	2.5	2.0	1.0	3.0
CHARGE-DISCHARGE CYCLES		-	-	1,000 charge/discharge partly (charge/discharge for 10% of discharge depth)	1,000 charge/discharge partly (charge/discharge for 10% of discharge depth)	500 charge/discharge down to 1V or discharge limit voltage (charge/discharge for 100% of discharge depth)	500 charge/discharge down to 3.0V (100% discharge depth)

COMPARISON BETWEEN BR AND CR

MODEL	BR vs. CR	
PERFORMANCE	Discharge capacity	BR = CR
	Voltage during discharging	BR < CR (Higher)
	Flatness of discharge voltage	(Flatter) BR > CR
	Load characteristics	BR < CR (Superior)
	Storage properties (self-discharge) < 60°C	(Less self-discharge) BR ≥ CR
> 60°C	(Less self-discharge & stable) BR > CR	

NOTES: In terms of their characteristics, the CR series provides a slightly higher voltage during discharge than the BR series. BR batteries, compared with CR batteries, show more stable characteristics with less discharge voltage variations. These characteristics should be taken into consideration when selecting a battery for each application.

APPLICATIONS

PRIMARY TYPE

INDUSTRY	APPLICATION	COIN TYPE				CYLINDRICAL TYPE			PIN TYPE
		BR series	BR-A series	CR series	CR-A/B series	BR series	CR series for consumer	CR series for industrial	BR series
AUTO-MOTIVE	ELECTRONIC TOLL COLLECTION (ETC)		○		○	⊙		⊙	
	EMERGENCY CALL (E-CALL)					○	○	⊙	
	REMOTE KEYLESS ENTRY (RKE)			⊙					
	TYRE PRESSURE MONITORING SYSTEM (TPMS)		⊙		⊙				
COMMUNICATION	ADVERTISING BEACON						⊙		
	IOT	○		⊙			⊙	⊙	
HOME APPLIANCE	PERSONAL DIGITAL ASSISTANT			⊙					
	DISTANCE METER						○		○
MARINE	SANITARY EQUIPMENT						⊙		
	EMERGENCY POSITION INDICATING RADIO BEACON			○		○	○	⊙	
MEDICAL	LIFE JACKET LIGHT			○		○	○	⊙	
	DIGITAL THERMOMETER	○		⊙	○				
METERING	SCALES			⊙					
	DISTANCE METER						○		○
	ELECTRICITY METER	⊙		○					
	HEAT COST ALLOCATOR		⊙		⊙	⊙			
SECURITY	WATER METER	⊙				⊙		⊙	
	DOOR LOCK SYSTEM			⊙			⊙		
	SMOKE DETECTOR					○		⊙	
OTHERS	WINDOW MONITORING SYSTEM			⊙		○	⊙		
	DISTANCE METER						○		○
	FISHING EQUIPMENT								⊙
	REAL TIME CLOCK (RTC)	⊙		○		⊙			
	TRACKING & RFID	○		⊙	○	○		○	
	VENDING MACHINE			⊙					
WATCH			⊙						

SECONDARY TYPE

INDUSTRY	APPLICATION	COIN TYPE			PIN TYPE
		VL series	ML series	MT series	CG series
AUTO-MOTIVE	REMOTE KEYLESS ENTRY (RKE)	⊙	○		○
COMMUNICATION	IOT	⊙	○		⊙
OTHERS	CALCULATOR	○	○		○
	REAL TIME CLOCK (RTC)	○	⊙		
	TRACKING & RFID	○	○		⊙
	VENDING MACHINE	○	○		
	WATCH			⊙	○

- ⊙ Recommended applications
- Potential applications

SELECTING A BATTERY/MODEL NUMBER

SELECTING A BATTERY

The steps for selecting the batteries for the power supplies of specific equipment are summarized below.

PREPARATION OF REQUIRED SPECIFICATIONS (DRAFT)

The required specifications (draft) are studied by checking the requirements for the batteries to be used as the power supplies of the specific equipment and their conditions against the battery selection standards. The technical requirements for battery selection are shown in the table below for reference purposes.

SELECTION OF A BATTERY

Select several candidate batteries by referring to the catalogs and data sheets of batteries which are currently manufactured and marketed. From this short list, select the battery which will best meet the ideal level of the requirements. In actual practice, however, the 'perfect' battery is seldom found by this method, instead, the basic procedure followed should be to examine the possibility of finding a compromise or partial compromise with the required specifications (draft) and then make a selection under the revised requirements from the batteries currently manufactured and marketed. Such a procedure enables batteries to be selected more economically. Questions and queries arising at this stage should be directed to our battery engineers. Sometimes, although it may not be shown in the catalogue, the appropriate battery has become available through recent development or improvement. As a rule, the required specifications are finalized at this stage.

REQUESTS FOR DEVELOPING OR IMPROVING BATTERIES

If the battery that meets the essential and specific requirements cannot be found through the selection process described above, a request for battery development or improvement should be made to our technical department. A request like this should be coordinated as early as possible to allow for a sufficient study period. While this period depends on the nature of the request and the difficulties involved, a lead time of at least 6 to 12 months is usually required.

MODEL NUMBER

HOW TO INTERPRET THE MODEL NUMBERS GENERALLY USED FOR COIN TYPE LITHIUM BATTERIES

The model numbers are normally indicated using two upper-case English letters and a figure consisting of three or more digits as shown in the example below. This numbering system is supported by the Japan International Standard Committee of Clocks and Watches and is also an established practice in Japan.

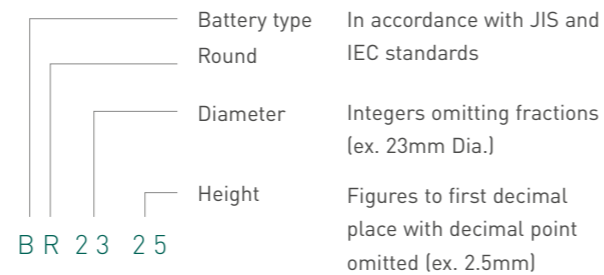

EXAMPLES

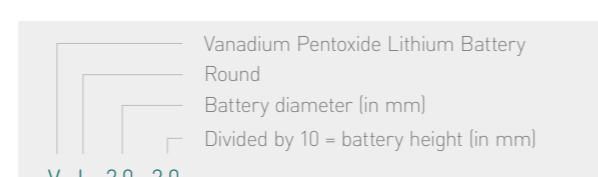
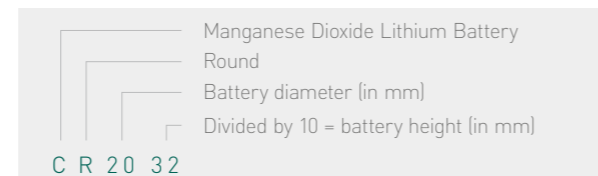
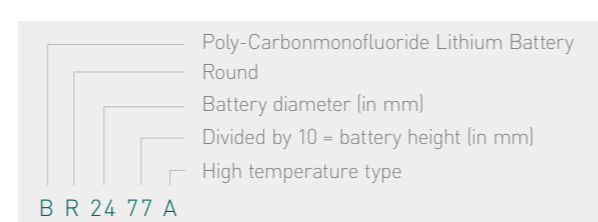
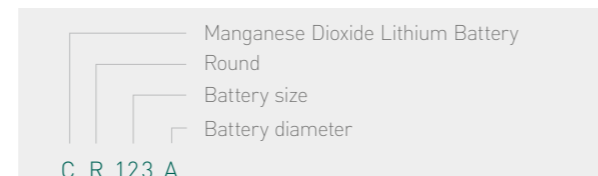
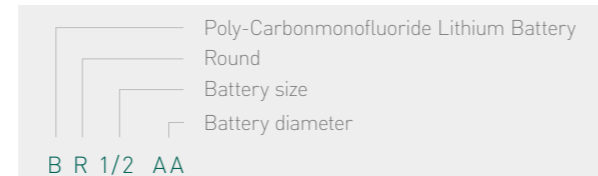

SELECTING A BATTERY/MODEL NUMBER

TECHNICAL CONDITIONS FOR SELECTING BATTERIES

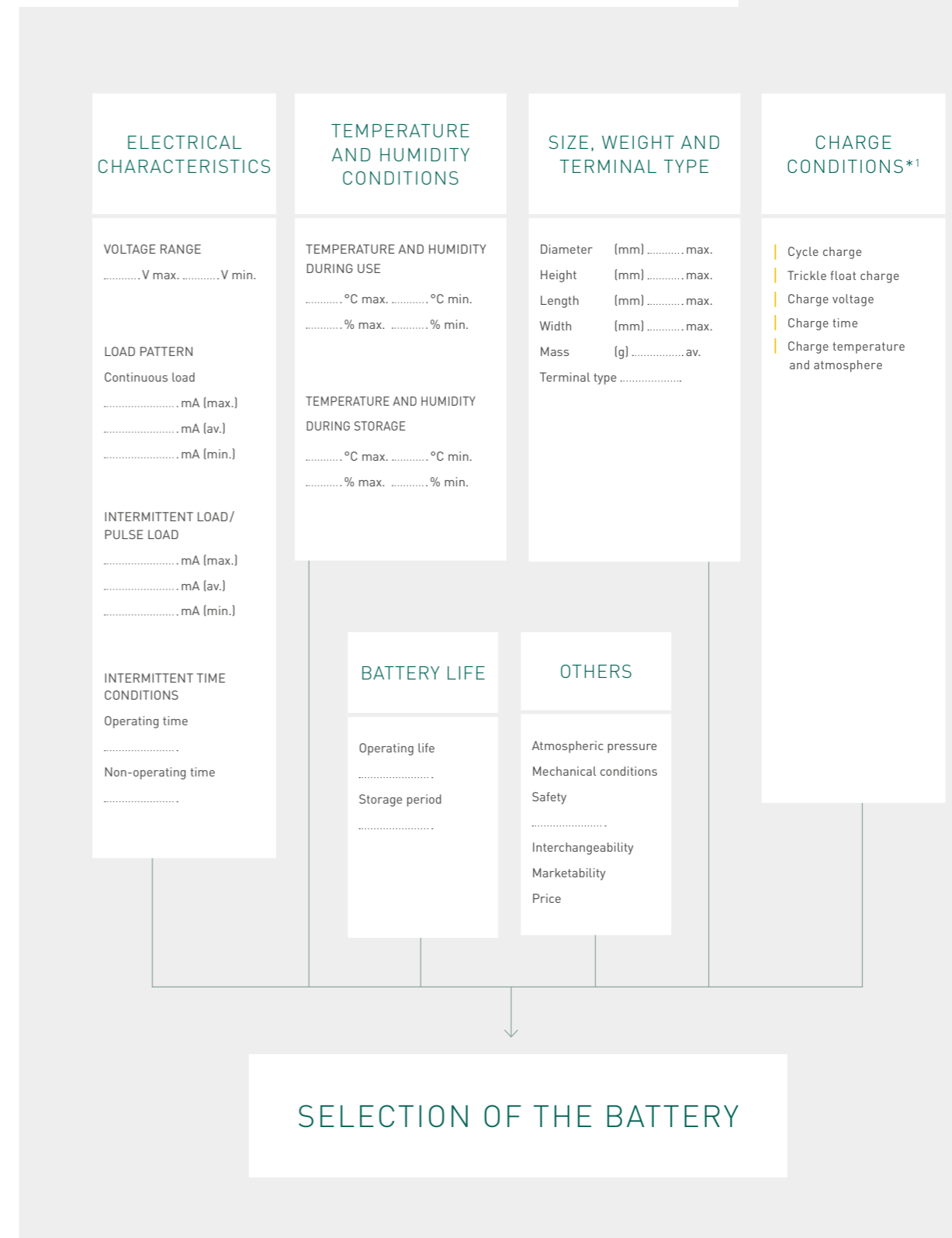

The data in this document are for descriptive purposes only and are not intended to make or imply any guarantee or warranty. *1 Only for rechargeable batterie

BATTERY SELECTION CHART

COIN TYPE PRIMARY LITHIUM BATTERIES (EXAMPLE)

DISCHARGE LIFE AS A FUNCTION OF OPERATING CURRENT

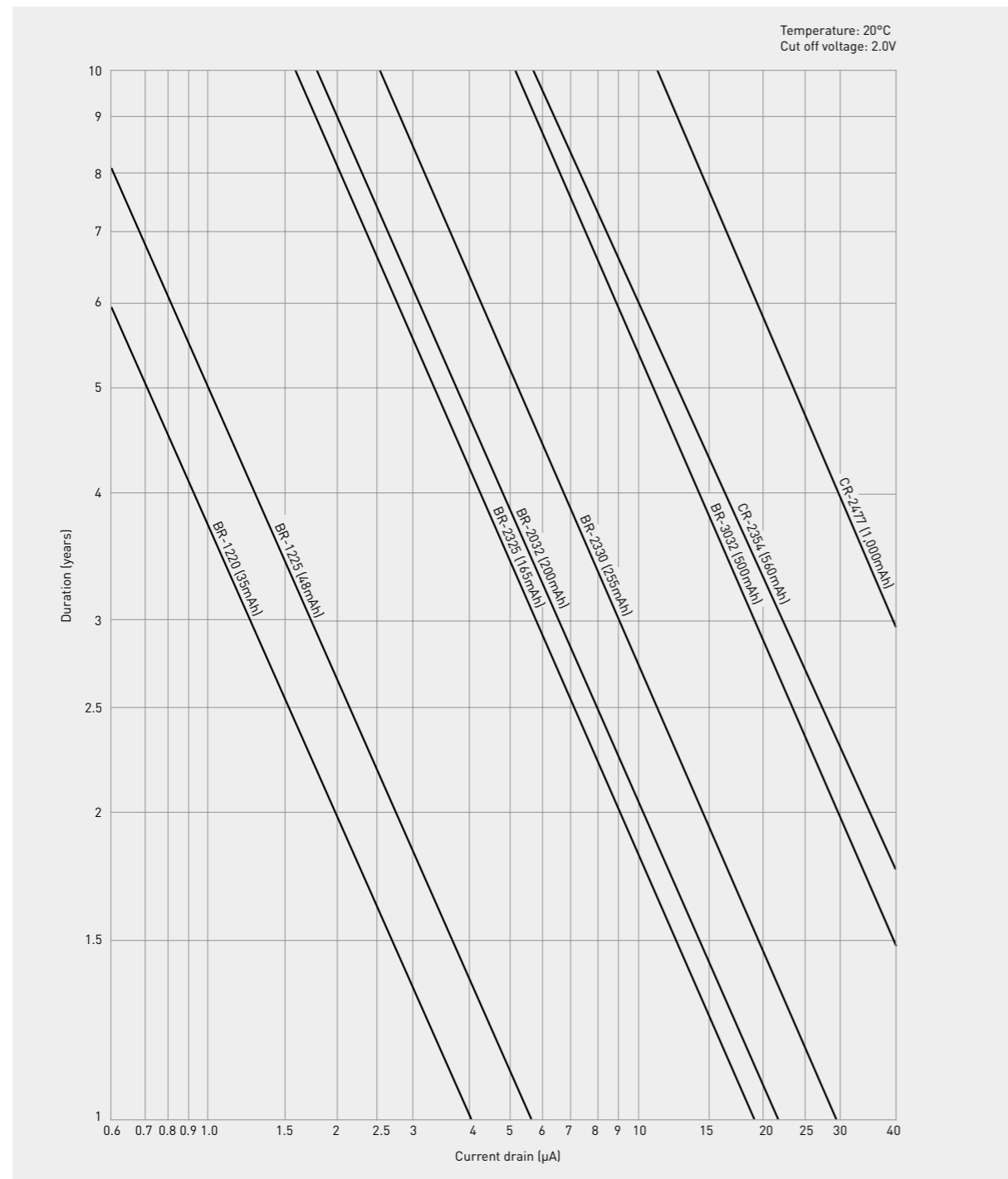

GENERAL FORMULA (ROUGH VALUE WITH 20°C, STANDARD LOAD)

CALCULATION Duration (years) = $\frac{\text{Nominal capacity (mAh)}}{\text{Current drain (mA)} \times 24 \text{ (hours)} \times 365 \text{ (days)}}$

BATTERY SELECTION CHART

SELF DISCHARGE

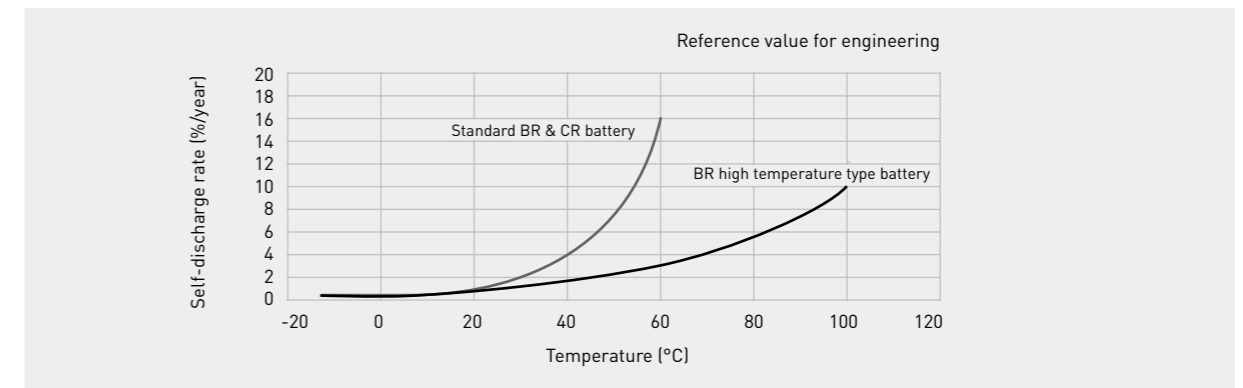

CYLINDRICAL TYPE PRIMARY LITHIUM BATTERIES (EXAMPLE)

DISCHARGE LIFE AS A FUNCTION OF OPERATING CURRENT

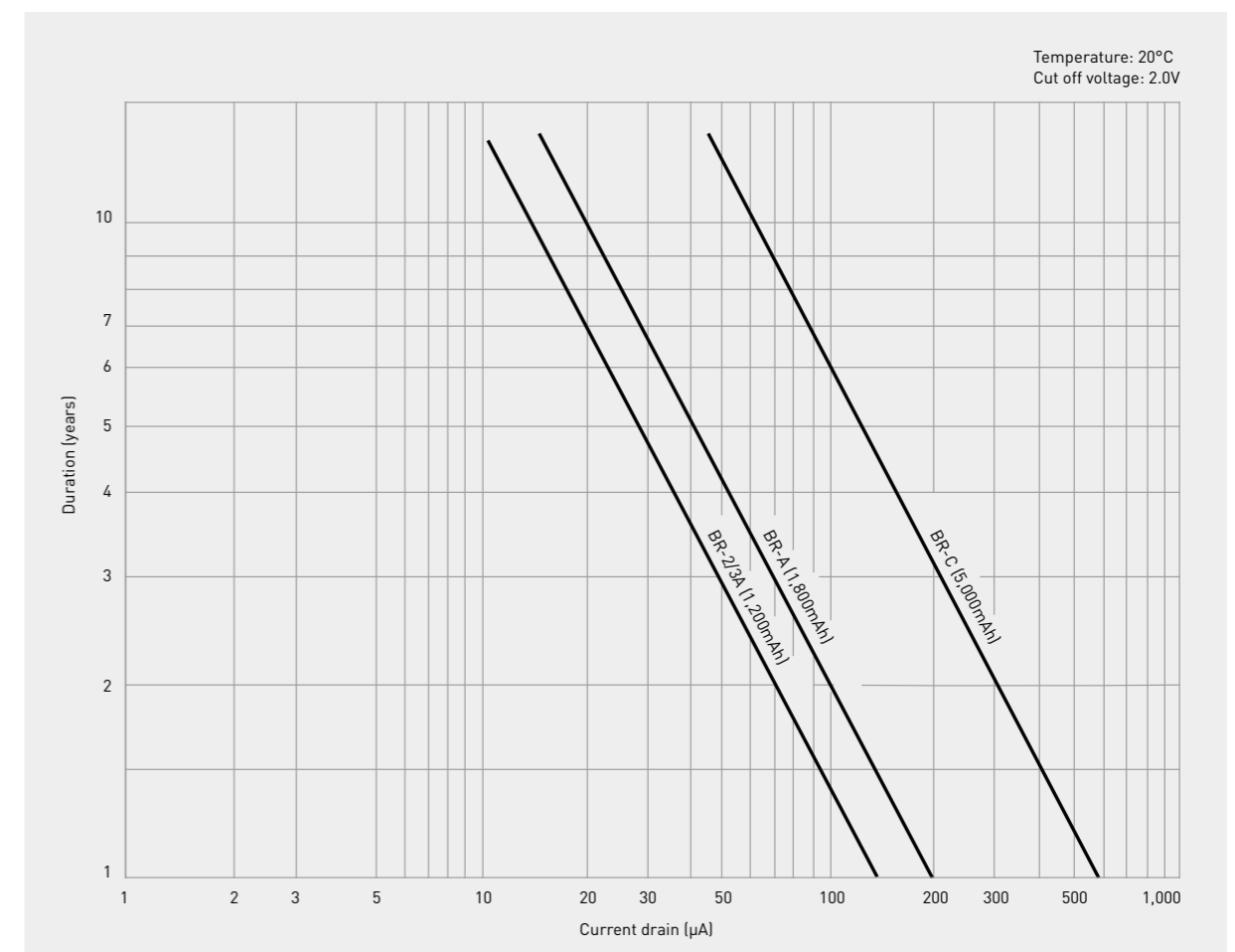

GENERAL FORMULA (ROUGH VALUE WITH 20°C, STANDARD LOAD)

CALCULATION Duration (years) = $\frac{\text{Nominal capacity (mAh)}}{\text{Current drain (mA)} \times 24 \text{ (hours)} \times 365 \text{ (days)}}$

BATTERY SELECTION CHART

SELF DISCHARGE

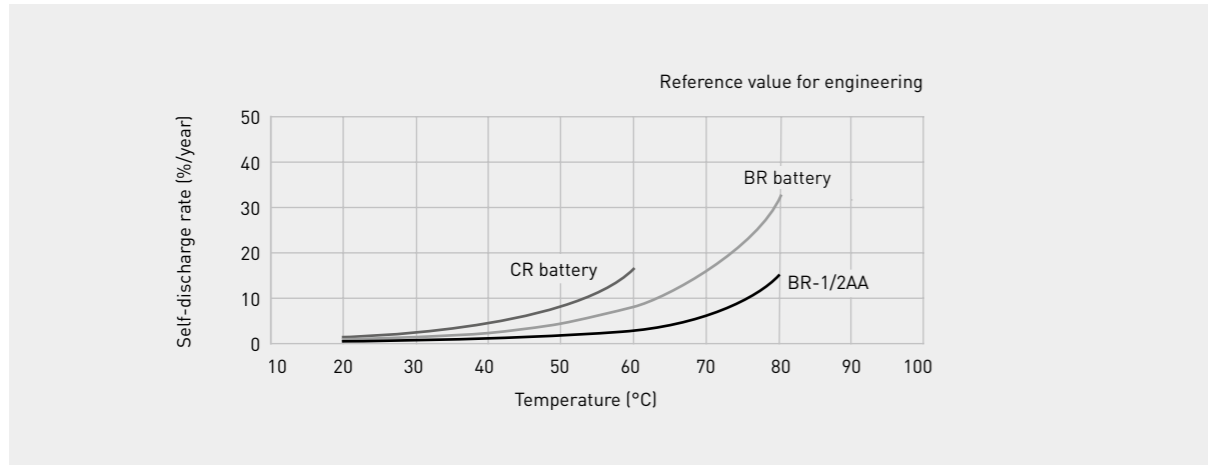

COIN TYPE SECONDARY LITHIUM BATTERIES (EXAMPLE)

DISCHARGE LIFE AS A FUNCTION OF OPERATING CURRENT

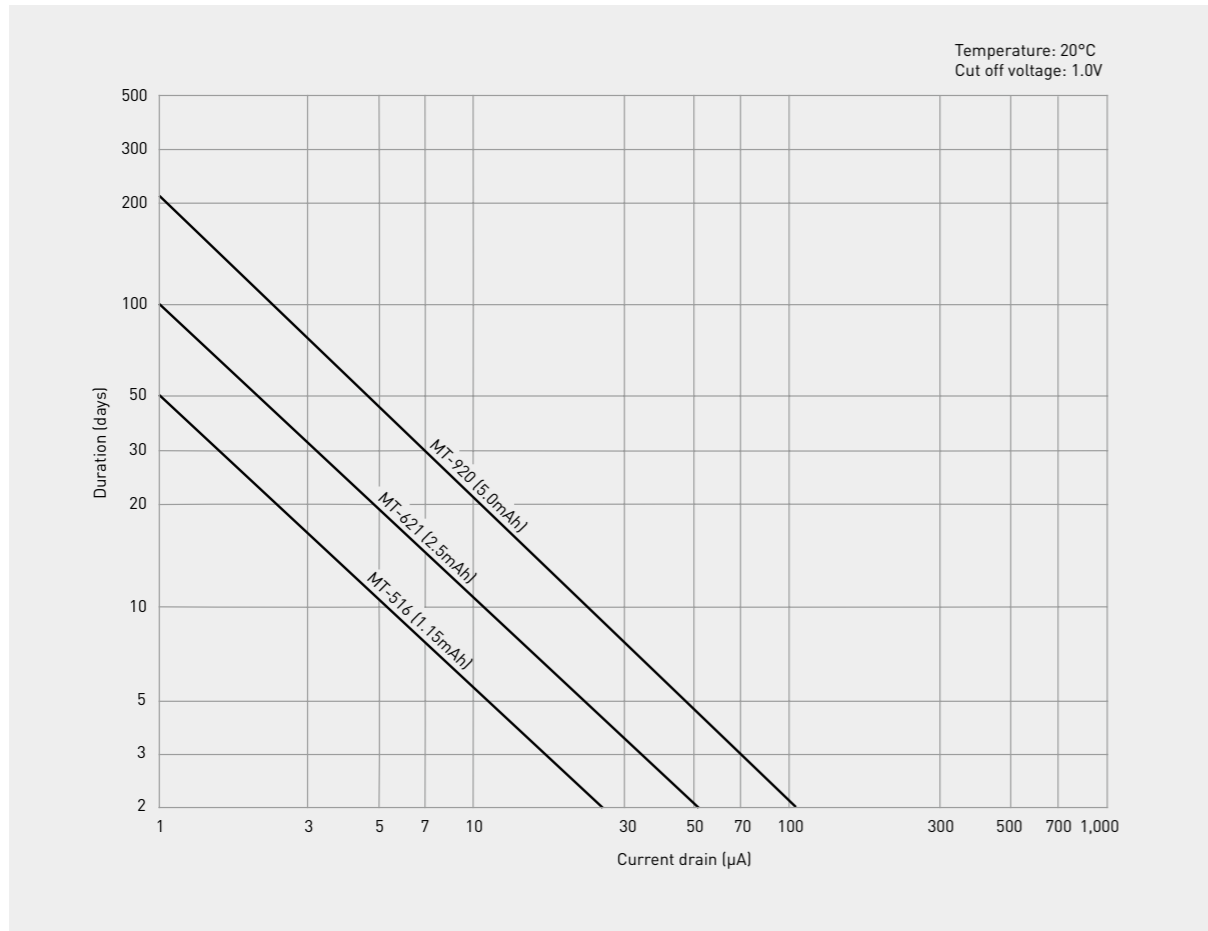

BATTERY SELECTION CHART

DISCHARGE LIFE AS A FUNCTION OF OPERATING CURRENT

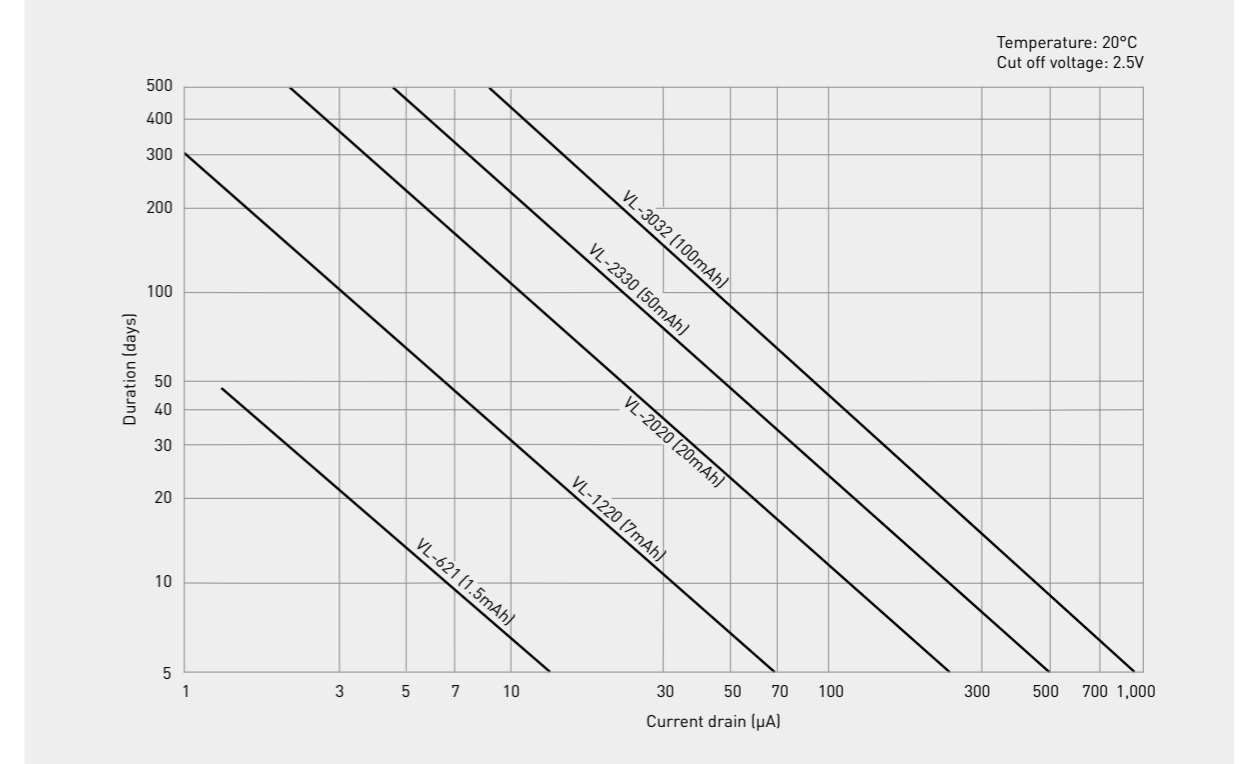

CYCLE LIFE

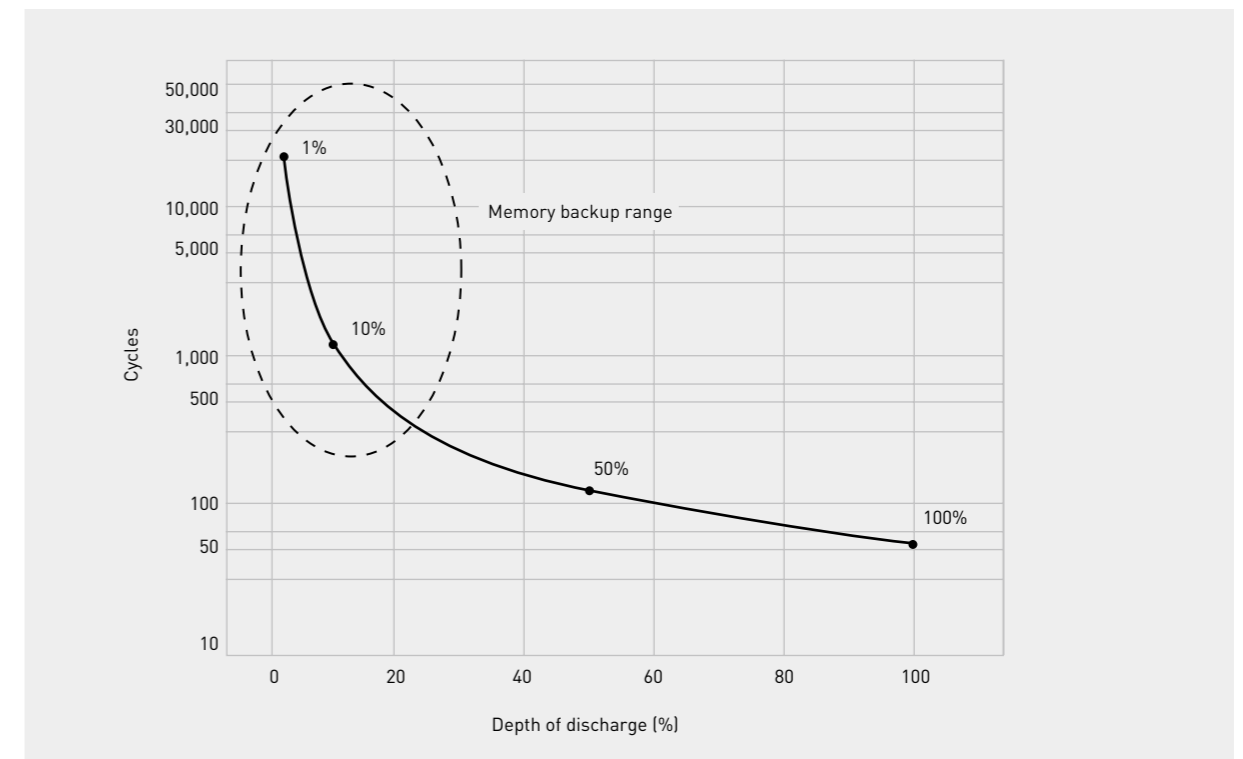

The number of cycles is defined with the batteries' remaining capacity ≤50%.

BATTERY SELECTION CHART

CHARGE RETENTION AND TEMPERATURE DEGRADATION DEPENDENCIES

VL/ML RESIDUAL CAPACITY AND RECOVERY

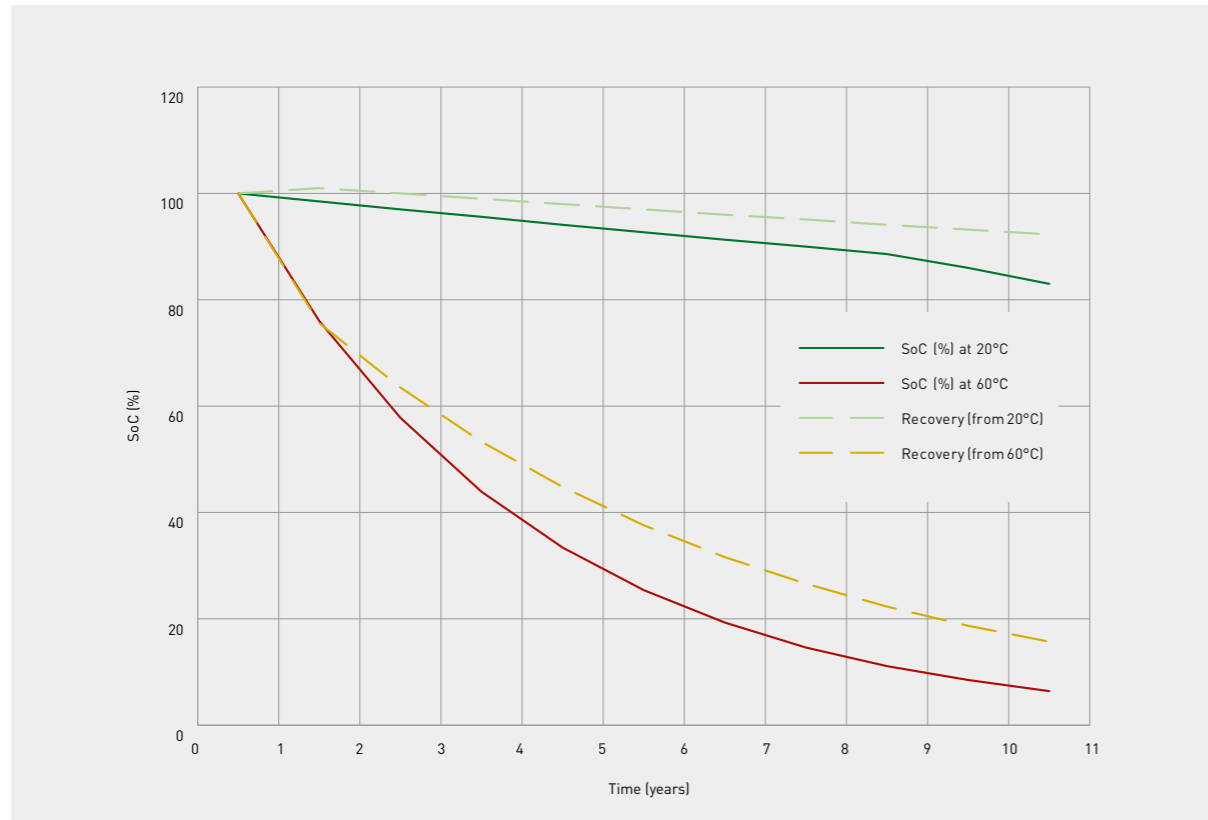

VL/ML CAPACITY DEGRADATION UNDER FLOAT

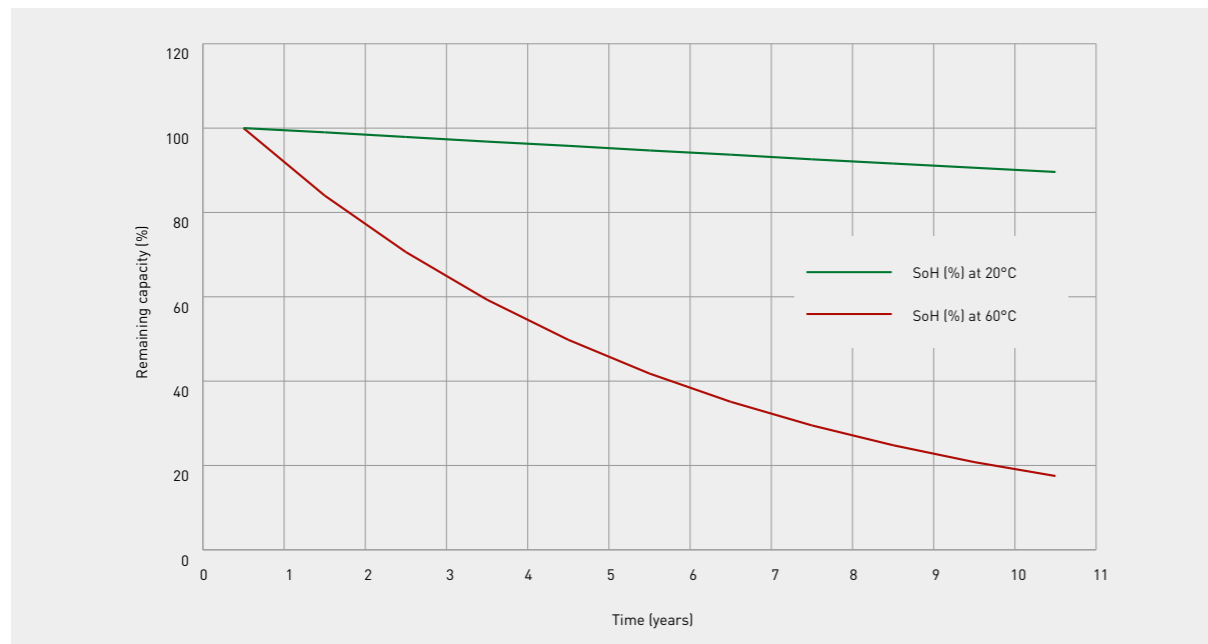

GENERAL SAFETY PRECAUTIONS FOR USING, HANDLING AND DESIGNING

APPLICABLE BOTH PRIMARY AND SECONDARY BATTERIES

CLASSIFICATION	ITEM	PRECAUTION
BATTERIES	VOLTAGE MEASUREMENT	To measure the battery voltage, use an instrument with an input resistance of 10MΩ or higher.
	INTERNAL RESISTANCE MEASUREMENT	To measure the internal resistance, use a 1,000Hz AC instrument.
	ELECTRICAL CHARACTERISTICS CHECK	Even minimal shorting causes the battery voltage to drop, requiring a period of time for the voltage to recover. Checking the voltage characteristics before the voltage has sufficiently recovered in such a situation may result in a misjudgment of battery voltage.
	CLEANING	Prior to installation in the equipment, wipe the batteries and equipment terminals clean using a dry cloth, etc.
	WASHING AND DRYING	Washing: Use of a conductive detergent causes batteries to discharge, the battery voltage to drop and the battery performance to deteriorate in other ways. Be sure to use a non-conductive detergent.
		Drying: The heat produced when the temperature of the battery units rises above 85°C deforms the gaskets and causes electrolyte leakage and a deterioration in performance. Be sure to dry batteries only for short periods of time at temperatures below 85°C.
	MOUNTING	Ensure that dust and other foreign substance will not cause shorting between the poles.
		When handling batteries, wear finger covers or gloves made of rubber, cotton, etc. to protect the batteries from dirt.
	UL	Strictly comply with the conditions outlined on the next page.
	USE OF MULTIPLE BATTERIES	Give sufficient consideration to safety in design when a multiple number of batteries are to be used. Consult with Panasonic concerning packs of multiple batteries.
	SIMULTANEOUS USE OF OTHER TYPES OF BATTERIES	When other types of batteries are also to be used in the some equipment, design the circuitry in such a way that the current (leakage current) from the other batteries will not flow to the lithium batteries. (This applies to primary batteries.)
	USE OF BATTERIES IN SERIES OR IN PARALLEL	This requires special circuitry: Please consult with Panasonic. Do not use lithium batteries together with different types of batteries in series or in parallel.
STORAGE	Recommended storage conditions: T: +5-35°C, RH: 45-85% (non-condensing) Maximum storage period: 10 years (7 years for CR cylindrical consumer cells)	
BATTERY LIFE	Prior to installation in the equipment, wipe the batteries and equipment terminals clean using a dry cloth, etc.	
BATTERY COMPARTMENTS IN EQUIPMENT	DESIGN	Ensure that the batteries can be replaced easily and that they will not fall out of position.
		Give consideration to the battery dimensions, tolerances, etc. Give consideration to the shape of ⊕ and ⊖ electrodes of the batteries and their tolerances to prevent installation in reverse.
BATTERY LAYOUT AND CONSTRUCTION AND MATERIALS OF COMPARTMENT	DESIGN	Clearly indicate on the battery compartment the type of batteries to be used and their correct installation direction (polarities).
		Limit the electrical circuits inside the battery compartment only to the circuits relating to the battery contacts.
BATTERY LAYOUT AND CONSTRUCTION AND MATERIALS OF COMPARTMENT	DESIGN	With the exception of the terminal areas, insulate the battery compartment from the electrical circuits.
		Take steps to minimize any damage to the equipment resulting from electrolyte leakage from the battery compartment.
BATTERY LAYOUT AND CONSTRUCTION AND MATERIALS OF COMPARTMENT	DESIGN	Batteries should be free from leakage of liquids, which can damage equipment and spoil the contact at terminals, making the operation of equipment unstable.
		Take steps to ensure the batteries are not located heat generating component in the equipment. Installing batteries near a heat source will heat up the batteries, causing thermal deformation of the gasket and resulting in electrolyte leakage and a deterioration in characteristics.
BATTERY LAYOUT AND CONSTRUCTION AND MATERIALS OF COMPARTMENT	DESIGN	Adopt a construction which allows the gases to be vented.
		Give consideration to the impact and the effect on the environment in selecting the materials to be used.

CLASSIFICATION	ITEM	PRECAUTION
CONTACTS AND CONNECTION TERMINALS	CONTACT POINT MATERIALS	Use nickel-plated iron or nickel-plated stainless steel for the contact points.
	CONTACT PRESSURE OF CONTACTS	In order to ensure stable contact, use the following levels of contact as a general guideline: 5N to 15N for cylindrical types 2N to 10N for coin types.
	SHAPE OF TERMINALS	Use of Y-shaped terminals (2-point contact) for both the ⊕ and ⊖ electrodes yield stable contact.
	CONNECTION TERMINALS	If lead wires and connection terminals such as tab terminals are required for the batteries, consult with Panasonic since we offer a range of external terminals (connectors, etc.).

NOTES

CIRCUIT DESIGN

1. Shorting causes the battery voltage to drop to about 0V before slowly recovering from the open state. It takes time for the initial voltage to be restored. Notice that measuring the open-circuit voltage immediately after shorting may lead to a misjudgment that the battery is abnormal. The figure on the right illustrates how voltage recovers after shorting.

2. Reverse current preventing diodes. Since lithium primary batteries are not rechargeable, use of a reverse current preventing diode and a protective resistor in series is required where there is the possibility of charging in the equipment circuit. Use a silicon diode or Schottky diode with a low reverse current as the reverse current preventing diode. To maintain the characteristics of a coin type lithium battery, the total charging amount of the battery during its total usage period must be kept within 3% of the nominal capacity of the battery.

BR-2/3A Voltage recovery after short-circuited (example)

Temperature: 20°C

Shorting time

- 3-5 seconds
- 10 seconds
- 20 seconds

Recovery time (hours)

Recovery time (seconds)

(A) 2-cell 6V usage

(B) Parallel usage

(C) UL conditions

PRIMARY BATTERIES

Since lithium primary batteries are not rechargeable, use a reverse current blocking diode and a protective resistor in series where there is the possibility of charging in the equipment circuit.

REVERSE CURRENT BLOCKING DIODE DIODE USED

Use a low leak current diode (this current varies with temperature).

SELECTION STANDARD

The total allowable charging amount of a battery during its total usage period must not be greater than 3% of the nominal capacity of the battery for a coin type battery or 1% for a cylindrical battery.

EXAMPLE

When a CR-2477 (1,000mAh) coin type battery is to be used for 5 years, a reverse current preventing diode with a reverse current of 0.7μA or less is required.

CALCULATION METHOD

$$1,000\text{mAh (CR-2477)} \times 3\% \text{ (coin type battery)} = \leq 30\text{mAh}$$

$$30\text{mAh} \div \text{usage period (5 years} \times 365 \text{ days} \times 24 \text{ hours)} = 0.7\mu\text{A}$$

USE OF PROTECTIVE RESISTOR IN SERIES: SELECTION AND INSTALLATION (UL STANDARD)

A resistor must be installed in series with the battery to limit the charge current which will flow to the battery in case of destruction in continuity of the reverse current preventing diode. The maximum allowable current is specified for each battery size in the table at the right, and the resistance value of the protective resistor is determined as:

$$R > V \div I$$

(where 'I' is the maximum allowable charge current specified by UL).

CONDITIONS FOR UL STANDARD
(Contact Panasonic for further details.)

1. USE OF PROTECTIVE RESISTOR IN SERIES

SELECTION

Select the protective resistor in such a way that the charge current which will flow to the battery when the diode is destroyed is less than the value given in the table on the next page.

INSTALLATION

To protect the battery from being charged in the event of the destruction of the diode, install a protective resistor in series with the battery.

2. BATTERY REPLACEMENT

REPLACEMENT BY QUALIFIED ENGINEER

These batteries are intended for use as a part of an electrical circuit in equipment and any battery with an asterisk '*' in the table on the next page should only be replaced by a qualified engineer.

REPLACEMENT BY USER

Those lithium batteries which are not accompanied by an asterisk '*' in the table on the next page and which include the use of up to four of them in series or in parallel may be replaced by users provided that the conditions specified by the UL Standard are met.

USE IN SERIES OR IN PARALLEL

In replacing up to four batteries, the batteries must all be replaced with new ones at the same time. Set the maximum allowable charge current to within the current permitted by the number of batteries in series or in parallel.

SECONDARY BATTERIES

USE OF MULTIPLE BATTERIES

Consult with Panasonic if two or more Vanadium rechargeable Lithium batteries (VL series) or Manganese rechargeable Lithium batteries (ML series) are to be used in series or in parallel.

CHARGING

Details on the charge voltage, charge current and charge circuit are given for each type of battery.

CONDITIONS OF UL APPROVAL

The maximum charge current must be restricted to 300mA when protective components have been subjected to short- or open-circuiting.

PRIMARY AND SECONDARY BATTERIES

UL APPROVAL AND MAXIMUM ALLOWABLE CHARGE CURRENT

SHAPE	MODEL NUMBER	UL APPROVAL	MAXIMUM ABNORMAL CHARGING CURRENT (mA)
CYLINDRICAL TYPE BR SERIES	BR-1/2AA	✓	5
	BR-2/3A	✓	10
	BR-2/3AG	✓	10
	BR-A*1	✓	15
	BR-AG*1	✓	15
CYLINDRICAL TYPE CR SERIES FOR CONSUMER	CR-2	✓	20
	CR-123A	✓	25
	2CR-5	✓	25
	CR-P2	✓	25
CYLINDRICAL TYPE CR SERIES FOR INDUSTRIAL	CR-2U, CR-2Z	✓	20
	CR-2/3AU, CR-2/3AZ	✓	25
	CR-AAK, CR-AAU	✓	25
	CR-AG, CR-AGZ	✓	25
	CR-LAZ, CR LAS	✓	25
COIN TYPE BR SERIES	BR-1220	✓	3
	BR-1225	✓	3
	BR-1632	✓	4
	BR-2032	✓	5
	BR-2325	✓	5
	BR-2330	✓	5
COIN TYPE BR-A SERIES	BR-3032	✓	5
	BR-1225A	✓	3
	BR-1632A	✓	4
	BR-2330A*1	✓	5
	BR-2450A*1	✓	5
COIN TYPE CR SERIES	BR-2477A*1	✓	5
	CR-1025	✓	2
	CR-1216	✓	3
	CR-1220	✓	3
	CR-1616	✓	4
	CR-1620	✓	4
	CR-1632	✓	4
	CR-2012	✓	10
	CR-2016	✓	10
	CR-2025	✓	10
	CR-2032	✓	10
	CR-2330	✓	10
	CR-2354	✓	10
	CR-2412	✓	10
	CR-2450	✓	30
CR-2477	✓	10	
CR-3032	✓	10	
COIN TYPE CR-A/B SERIES	CR-2032A	✓	10
	CR-2032B	✓	10
	CR-2050A	✓	10
	CR-2050B2	✓	10
PIN TYPE BR SERIES	CR-2450A	✓	30
	BR-425	✓	0.1
COIN TYPE VL SERIES	BR-435	✓	0.2
	VL-621*1	✓	300
	VL-1220	✓	300
	VL-2020	✓	300
	VL-2330	✓	300
COIN TYPE ML SERIES	VL-3032	✓	300
	ML-2020*1	✓	300
COIN TYPE MT SERIES	MT-516	✓	300
	MT-621	✓	300
	MT-920	✓	300
PIN TYPE CG SERIES	CG-320B	✓	38
	CG-420A	✓	72
	CG-425A	✓	99

✓ UL approval

DESIGN FOR MEMORY BACK-UP USE

SELECTING BATTERIES

When selecting batteries, give consideration to such factors as the current consumption of the equipment in which the batteries are to be used, the expected life of the batteries, and temperature in the operating environment. At low operating environment temperatures, the consumption current of the ICs drops but the discharge voltage of the batteries will also decrease. Also it is important to note that the capacity deterioration of batteries in long-term use becomes significant at high operating environment temperatures.

MEMORY BACK-UP CIRCUIT AND HOLDING VOLTAGE
The circuit typically used for memory back-up is shown in the figure on the right. The memory holding voltage is expressed as: $V_B - V_F - I_F \times R >$ memory holding voltage of IC.

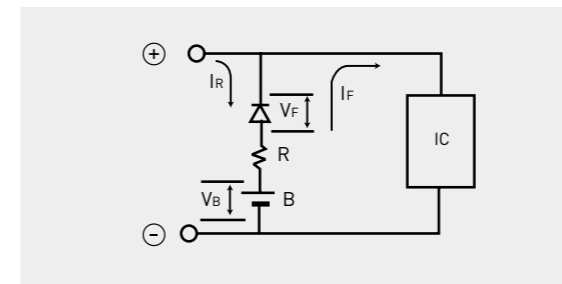

REVERSE CURRENT BLOCKING DIODE

Since lithium primary batteries are not rechargeable, use of a reverse current blocking diode and a protective resistor in series is required where there is the possibility of charging in the equipment circuit. Use a diode with a low leak current as the reverse current blocking diode. To maintain the characteristics of a coin type lithium battery, the total charging amount of the battery during its total usage period must be kept within 3% of the nominal capacity of the battery.

FOR EXAMPLE, assuming that a CR-2477 (1,000mAh) will be used in a memory back-up power supply for 5 years, charging by the leak current of the reverse current blocking diode should be no greater than 30mAh (= 3% of 1,000mAh), thus: $30\text{mAh} \div \text{usage period [5 years} \times 365 \text{ days} \times 24 \text{ hours}] = 0.7\mu\text{A}$. In other words, a leak current blocking diode whose reverse current is not greater than $0.7\mu\text{A}$ must be selected.

ALLOWABLE TOTAL CHARGING AMOUNT

- Within 3% for coin type batteries
- Within 1% for cylindrical type batteries

Note that the leak current of reverse current blocking diodes varies with temperature.

(A) 2-CELL 6V USAGE

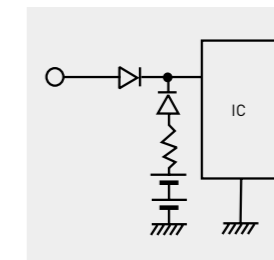

(B) PARALLEL USAGE

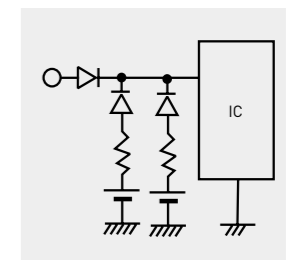

(C) UL CONDITIONS

(When a protective resistor has been inserted)

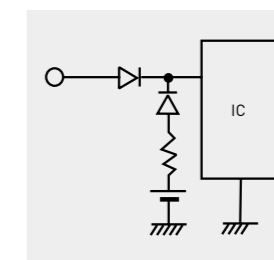

(D) UL CONDITIONS

(Protective diode)

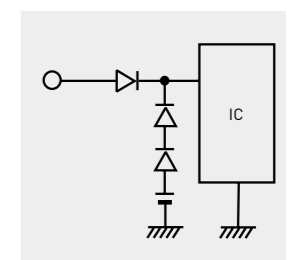

CHARGE TEST RESULTS ASSUMING DIODE LEAKAGE CURRENT BR-2/3A (CYLINDRICAL TYPE) CHARGE TEST

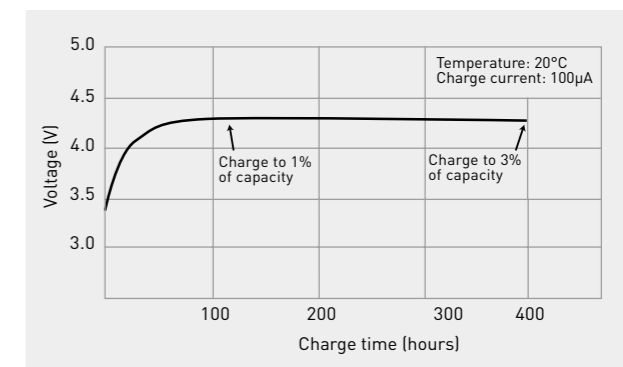

BR-2/3A (CYLINDRICAL TYPE) DISCHARGE TEST AFTER CHARGING

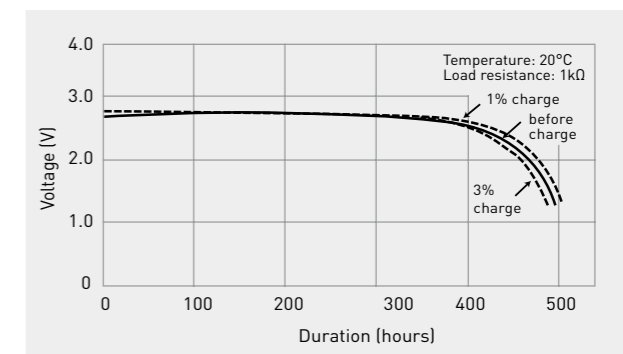

STATE-OF-THE-ART

PRIMARY LITHIUM BATTERIES

NON RECHARGEABLE

- | Low self-discharge
- | Decades of mass production experience
- | Superior designed battery ranges
- | Proven reliability



YOUR INFORMATION
 Visit our product page and get detailed information about Lithium batteries.

POLY-CARBONMONOFLUORIDE LITHIUM BATTERIES (BR SERIES) - CYLINDRICAL TYPE

Our Panasonic Poly-Carbonmonofluoride Lithium batteries (BR series) are ideal for applications such as meters or smoke detectors which demand either long-term power supply reliability or need to handle a wide temperature range.

FEATURES

- | Operating temperature range: between -40°C ~ +85°C
- | Self-discharge rate at 20°C is less than 0.5% per year
- | Superior long-term reliability
- | Over 40 years of experience in production

APPLICATIONS



MODEL NUMBER	Nominal voltage (V)	Nominal ² capacity (mAh)	Size	Diameter (mm)	Total height (mm)	Weight (g)	Discharging temperature (°C)
BR-1/2AA ³ *4	3	1,000	1/2 AA	14.5	25.5	8	-40 to +100
BR-2/3A ⁴	3	1,200	2/3 A 17355	17.0	33.5	13	-40 to +85
BR-2/3AG ⁴	3	1,450	2/3 A 17355	17.0	33.5	13	-40 to +85
BR-A ⁴	3	1,800	A	17.0	45.5	18	-40 to +85
BR-AG ⁴	3	2,200	A	17.0	45.5	18	-40 to +85
BR-C ⁴	3	5,000	C	26.0	50.5	41	-40 to +85

BATTERY INSIDE*1

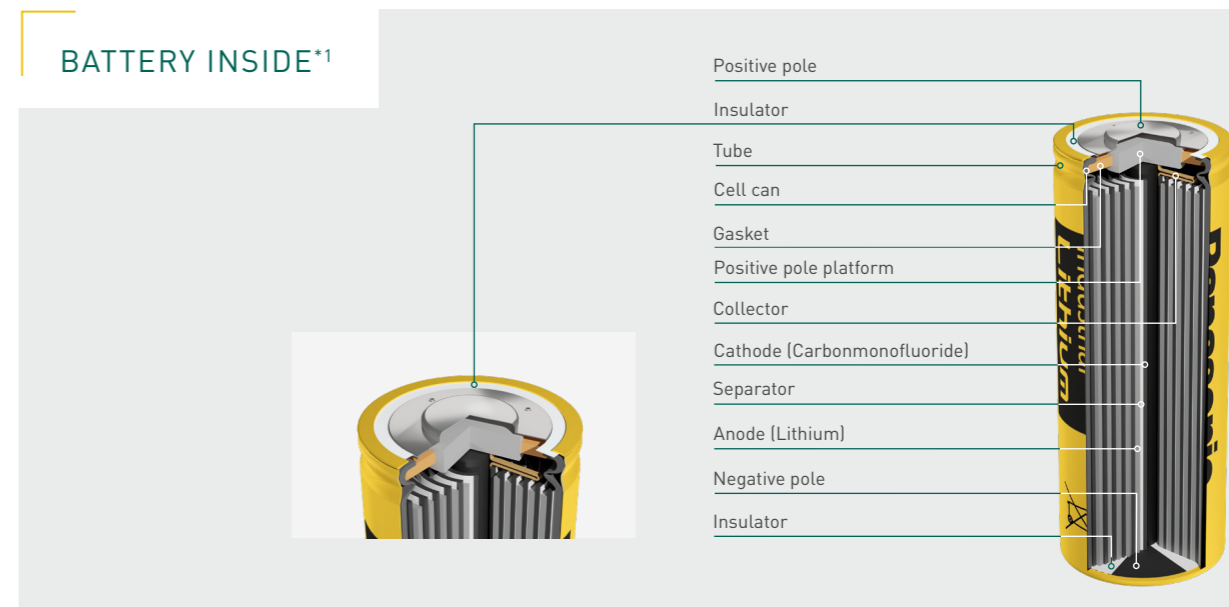

The data in this document are for descriptive purposes only and are not intended to make or imply any guarantee or warranty.
^{*1} Capacity based on standard drain and cut off voltage down to 2.0V at 20°C.
^{*2} Operating temperature range is from -40°C ~ +100°C.
^{*3} Cells are supplied with tabs or lead-wires only. For available configurations please consult the Panasonic homepage or your sales contact.
^{*4} The illustration shows only one example of Lithium battery structure.

BR-1/2AA

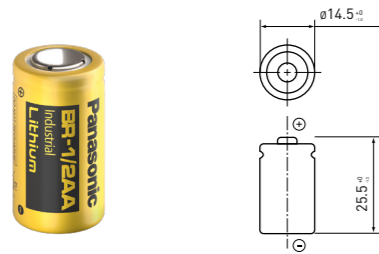

SPECIFICATIONS	BR-1/2AA
Nominal voltage (V)	3
Nominal capacity (mAh)	1,000
Diameter (mm)	14.5
Total height (mm)	25.5
Discharging temperature range (°C)	-40 to +100
Weight (g)	8.0

DISCHARGE TEMPERATURE CHARACTERISTICS

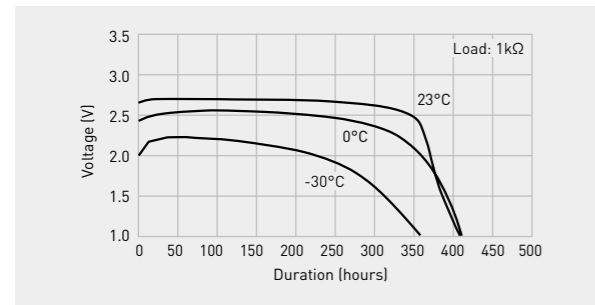

OPERATING VOLTAGE VS. DISCHARGE CURRENT*1

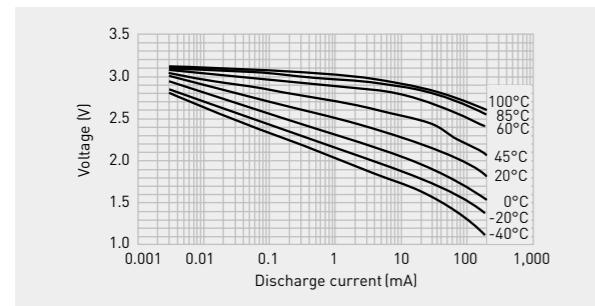

BR-2/3A

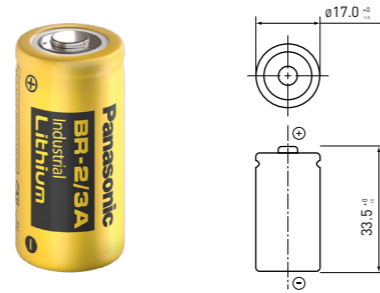

SPECIFICATIONS	BR-2/3A
Nominal voltage (V)	3
Nominal capacity (mAh)	1,200
Diameter (mm)	17.0
Total height (mm)	33.5
Discharging temperature range (°C)	-40 to +85
Weight (g)	13.0

DISCHARGE TEMPERATURE CHARACTERISTICS

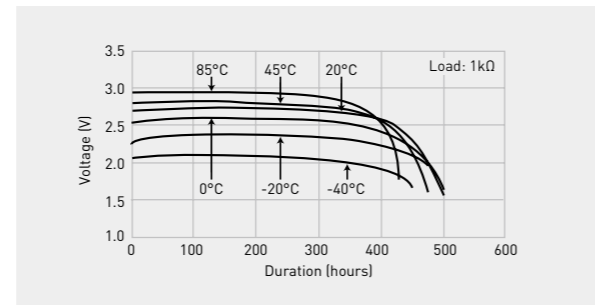

OPERATING VOLTAGE VS. DISCHARGE CURRENT*1

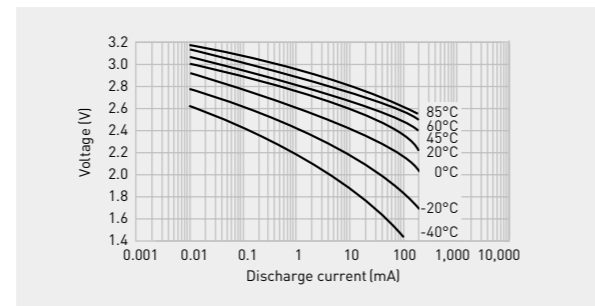

BR-2/3AG

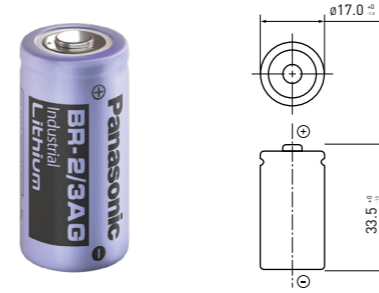

SPECIFICATIONS	BR-2/3AG
Nominal voltage (V)	3
Nominal capacity (mAh)	1,450
Diameter (mm)	17.0
Total height (mm)	33.5
Discharging temperature range (°C)	-40 to +85
Weight (g)	13.0

DISCHARGE TEMPERATURE CHARACTERISTICS

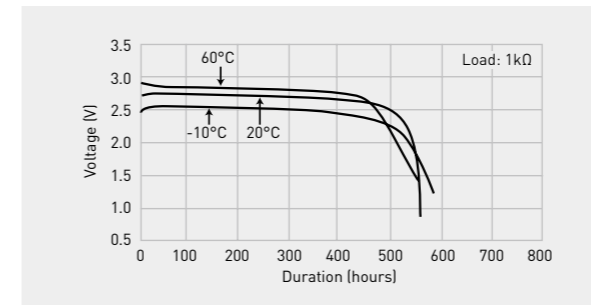

OPERATING VOLTAGE VS. DISCHARGE CURRENT*1

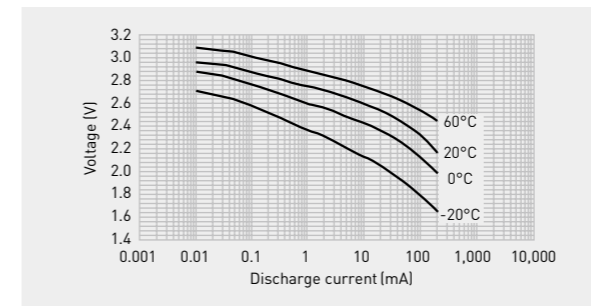

BR-A

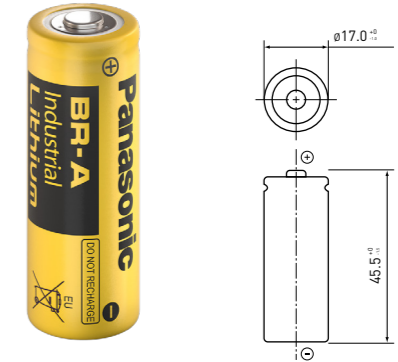

SPECIFICATIONS	BR-A
Nominal voltage (V)	3
Nominal capacity (mAh)	1,800
Diameter (mm)	17.0
Total height (mm)	45.5
Discharging temperature range (°C)	-40 to +85
Weight (g)	18.0

DISCHARGE TEMPERATURE CHARACTERISTICS

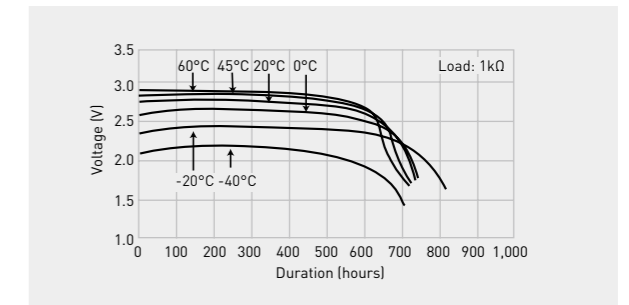

OPERATING VOLTAGE VS. DISCHARGE CURRENT*1

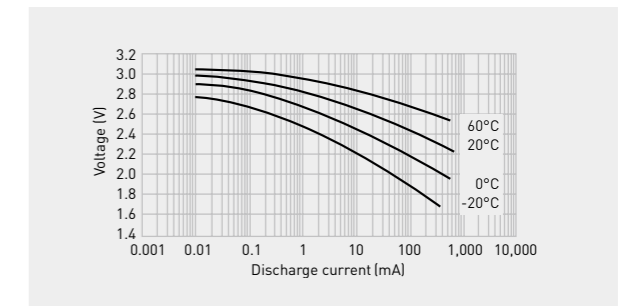

BR-AG

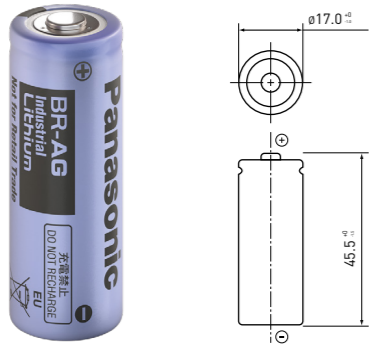

SPECIFICATIONS	BR-AG
Nominal voltage (V)	3
Nominal capacity (mAh)	2,200
Diameter (mm)	17.0
Total height (mm)	45.5
Discharging temperature range (°C)	-40 to +85
Weight (g)	18.0

DISCHARGE TEMPERATURE CHARACTERISTICS

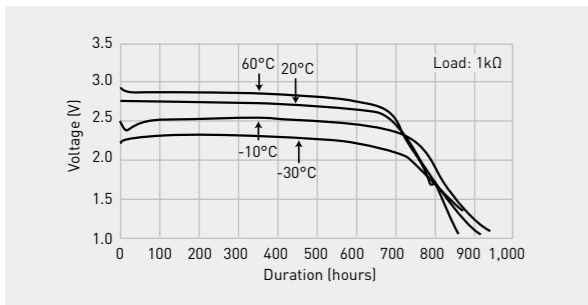

OPERATING VOLTAGE VS. DISCHARGE CURRENT*1

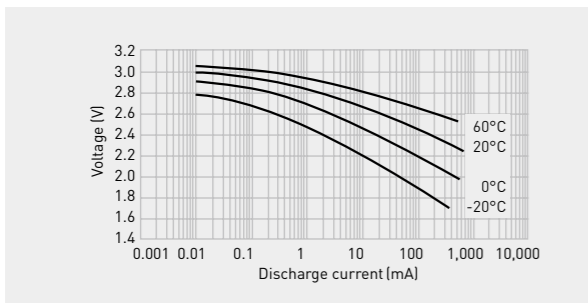

BR-C

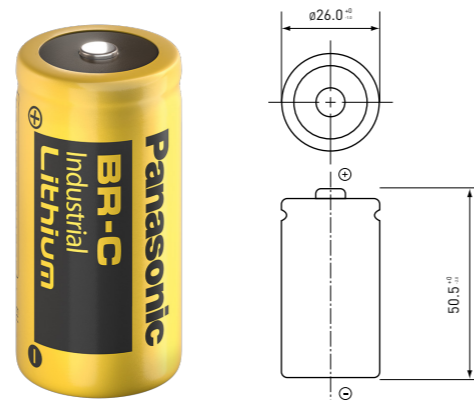

SPECIFICATIONS	BR-C
Nominal voltage (V)	3
Nominal capacity (mAh)	5,000
Diameter (mm)	26.0
Total height (mm)	50.5
Discharging temperature range (°C)	-40 to +85
Weight (g)	41.0

DISCHARGE TEMPERATURE CHARACTERISTICS

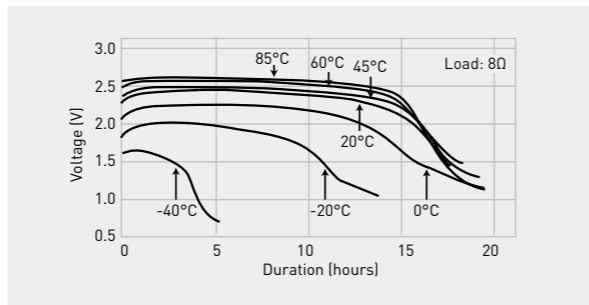

OPERATING VOLTAGE VS. DISCHARGE CURRENT*1

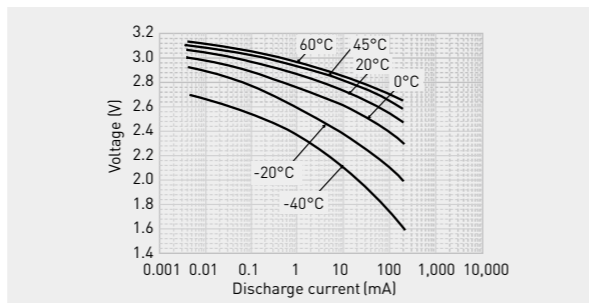

MANGANESE DIOXIDE LITHIUM BATTERIES (CR SERIES FOR CONSUMER) – CYLINDRICAL TYPE

Panasonic Lithium CR type cylindrical batteries come as either single cells or dual cell packs. All cylindrical type Manganese Dioxide (CR series) Lithium batteries feature a spiral structure. With their enlarged electrode surface areas, they permit a current as high as several amperes to be drawn. In addition these batteries are convenient for equipments which are considered to replace the battery at the field.

APPLICATIONS



FEATURES

- Operating temperature range: between -40°C ~ +70°C*1
- Good pulse discharge capability
- Stable operation voltage
- Self-discharge rate at 20°C is just 1% per year

MODEL NUMBER	Nominal voltage (V)	Nominal*1 capacity (mAh)	Size	Diameter (mm)	Total height (mm)	Weight (g)	Discharging temperature (°C)
CR-2*2	3	850	15270	15.6	27.0	11	-40 to +70
CR-123A*2	3	1,550	17345	17.0	34.5	16	-40 to +70
2CR-5*2	6	1,550	-	34.0 x 17.0	45.0	38	-40 to +70
CR-P2*2	6	1,550	-	35.0 x 19.5	36.0	37	-40 to +70

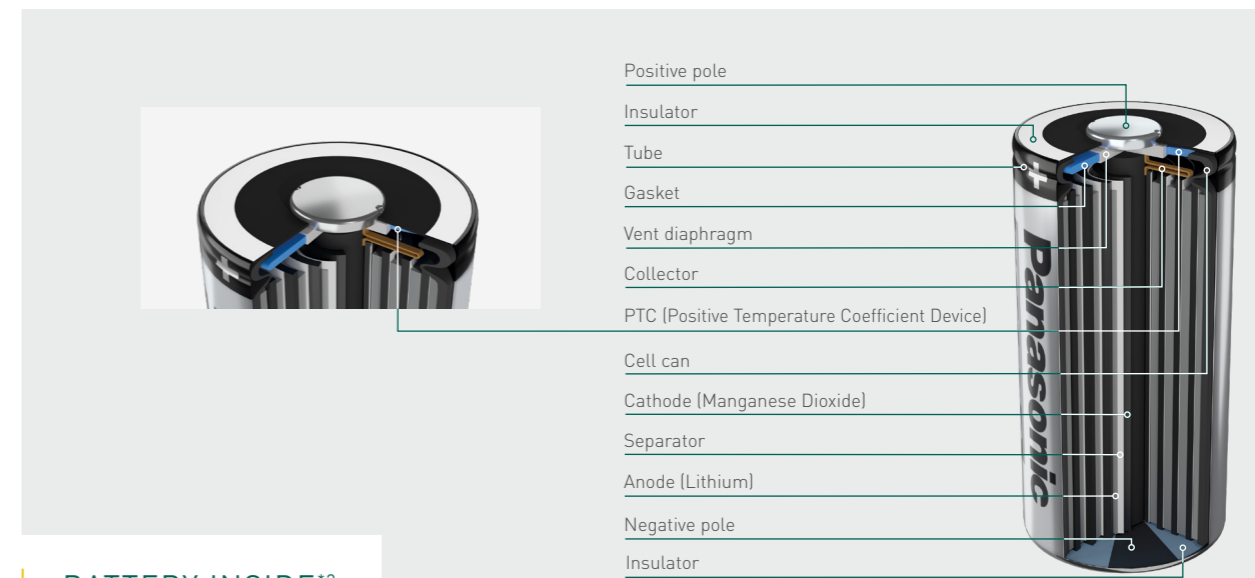

BATTERY INSIDE*3

The data in this document are for descriptive purposes only and are not intended to make or imply any guarantee or warranty.

*1 Capacity based on standard drain and cut off voltage down to 2.0V or 4.0V at 20°C.

*2 Please consult your Panasonic sales representative when anticipating usage in operation temperature is between -40°C to -20°C, or +60°C to 70°C.

*3 The illustration shows only one example of Lithium battery structure.

CR-2

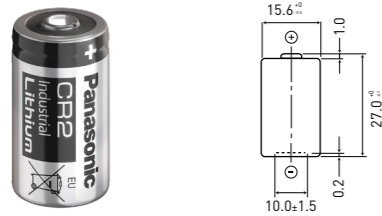

SPECIFICATIONS	CR-2
Nominal voltage (V)	3
Nominal capacity (mAh)	850
Diameter (mm)	15.6
Total height (mm)	27.0
Discharging temperature range (°C)	-40 to +70*1
Weight (g)	11.0

DISCHARGE TEMPERATURE CHARACTERISTICS

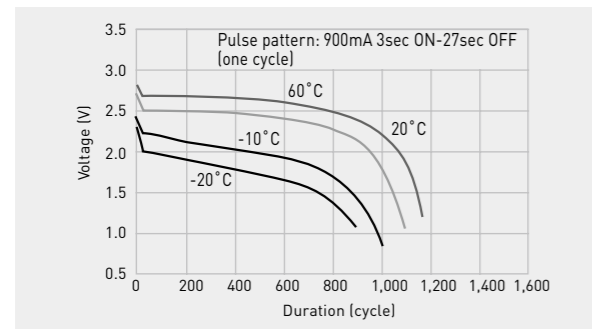

CR-123A

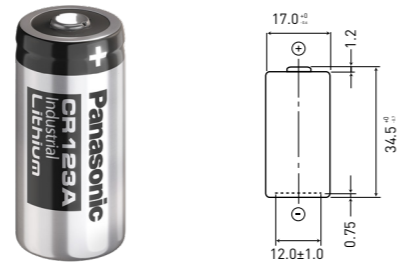

SPECIFICATIONS	CR-123A
Nominal voltage (V)	3
Nominal capacity (mAh)	1,550
Diameter (mm)	17.0
Total height (mm)	34.5
Discharging temperature range (°C)	-40 to +70*1
Weight (g)	16.0

DISCHARGE TEMPERATURE CHARACTERISTICS

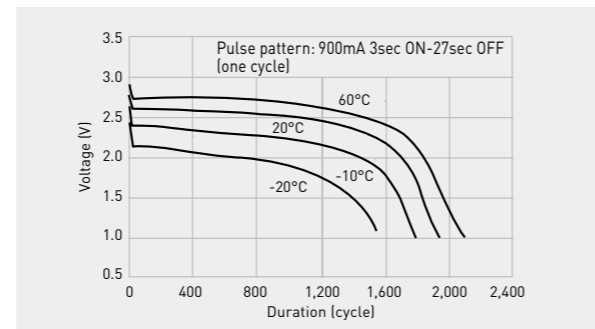

2CR-5

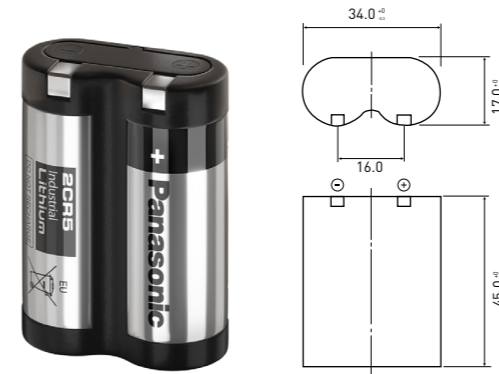

SPECIFICATIONS	2CR-5
Nominal voltage (V)	6
Nominal capacity (mAh)	1,550
Diameter (mm)	34.0 x 17.0
Total height (mm)	45.0
Discharging temperature range (°C)	-40 to +70*1
Weight (g)	38.0

DISCHARGE TEMPERATURE CHARACTERISTICS

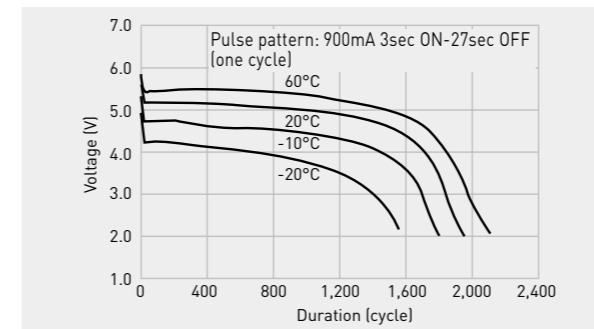

CR-P2

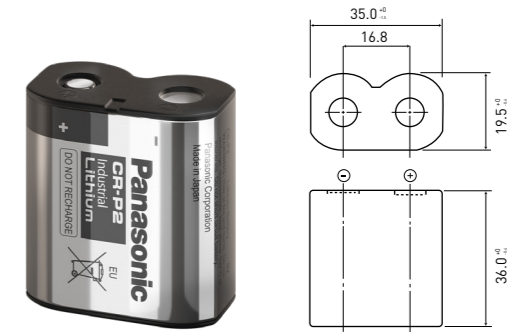

SPECIFICATIONS	CR-P2
Nominal voltage (V)	6
Nominal capacity (mAh)	1,550
Diameter (mm)	35.0 x 19.5
Total height (mm)	36.0
Discharging temperature range (°C)	-40 to +70*1
Weight (g)	37.0

DISCHARGE TEMPERATURE CHARACTERISTICS

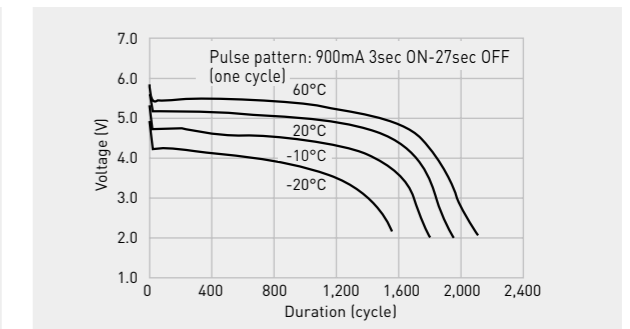

CR LITHIUM CYLINDRICAL SERIES FOR INDUSTRIAL

Ideal for industrial equipment, this series offers both excellent high-rate discharge performance and a service life of 15 years or more.

FEATURES

- Stable impedance throughout battery life
- Operating temperature range: between -40°C ~ +85°C^{*1}
- Superior high drain discharge performance
- Long-term reliability
- Self-discharge rate at 20°C is just 1% per year

APPLICATIONS

	Smart meter		Automotive
	Smoke detectors		Marine devices
	Security devices and systems		Medical equipment
	Irrigation sensor		Predictive maintenance
	Security devices and systems		

MODEL NUMBER	Nominal voltage (V)	Nominal ² capacity (mAh)	Size	Diameter (mm)	Total height (mm)	Weight (g)	Discharging temperature (°C)
CR-AAK	3	1,650	AA 14500	14.5	50.5	18	-40 to +85
CR-AAU	3	1,800	AA 14500	14.5	50.5	18	-40 to +85
CR-2Z	3	1,000	15270	15.6	27.0	11	-40 to +85
CR-2U	3	1,000	15270	15.6	27.0	11	-40 to +85
CR-2/3AU	3	1,600	2/3A 17335	17.0	33.5	16	-40 to +85
CR-2/3AZ	3	1,600	2/3A 17335	17.0	33.5	16	-40 to +85
CR-AG	3	2,400	A	17.0	45.5	22	-40 to +85
CR-AGZ	3	2,700	A	17.0	45.5	23	-40 to +85
CR-LAZ	3	3,000	A	17.0	50.5	26	-40 to +85
CR-LAS	3	3,500	A	17.5	50.0	28	-40 to +85

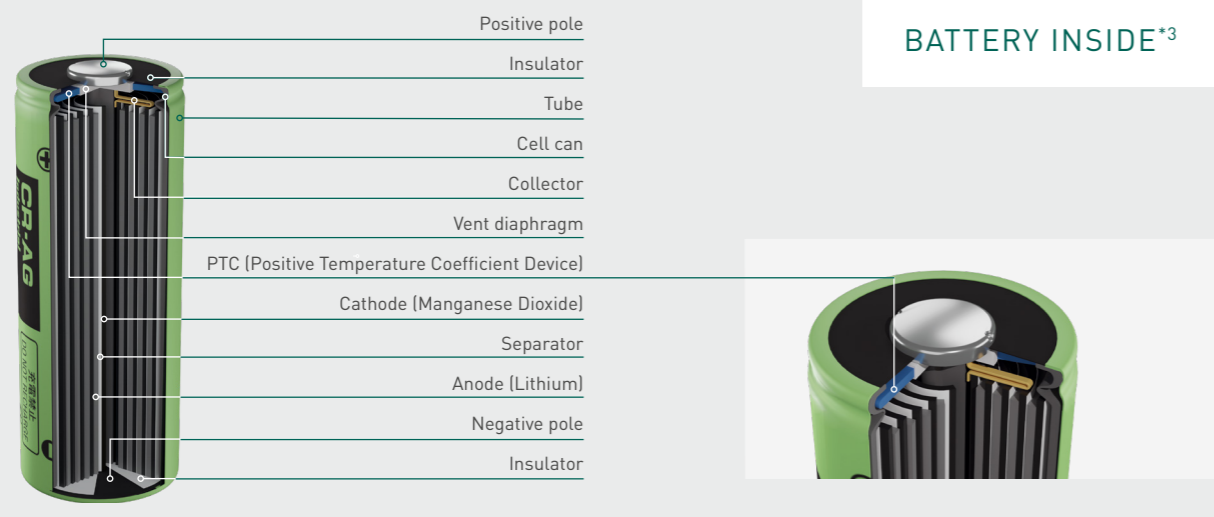

The data in this document are for descriptive purposes only and are not intended to make or imply any guarantee or warranty.
^{*1} Please contact Panasonic when anticipating usage in operation temperature 70°C or above.
^{*2} Capacity based on standard drain and cut off voltage down to 2.0V at 20°C.
^{*3} The illustration shows only one example of Lithium battery structure.

MANGANESE DIOXIDE LITHIUM BATTERIES (CR SERIES FOR INDUSTRIAL)

CR-AAK

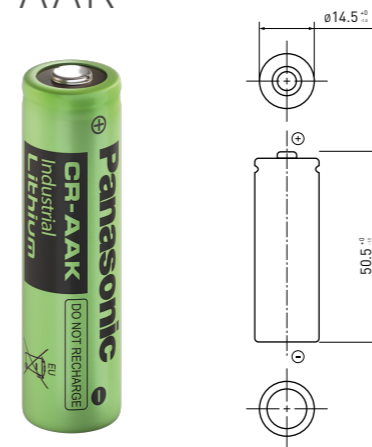

SPECIFICATIONS	CR-AAK
Nominal voltage (V)	3
Nominal capacity (mAh)	1,650
Diameter (mm)	14.5
Total height (mm)	50.5
Discharging temperature range (°C)	-40 to +85
Weight (g)	18.0

DISCHARGE CHARACTERISTICS

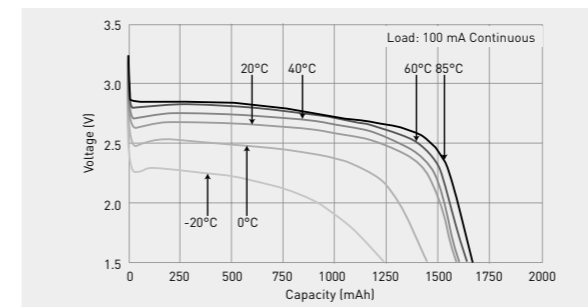

DISCHARGING CHARACTERISTICS BY TEMPERATURE

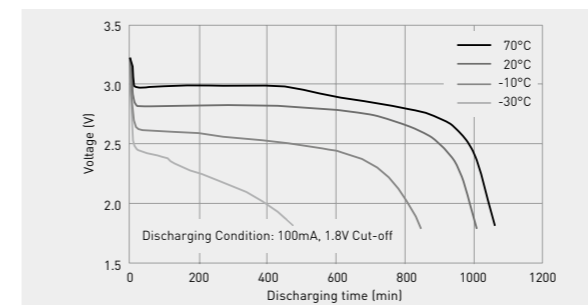

CONTINUOUS DISCHARGING CHARACTERISTICS

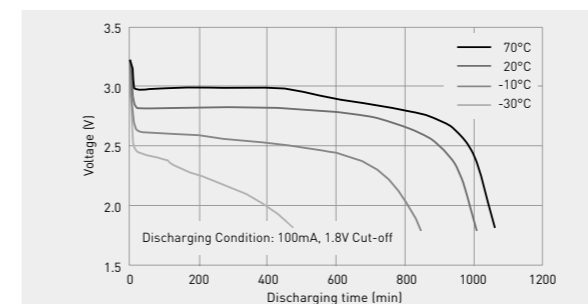

CR-AAU

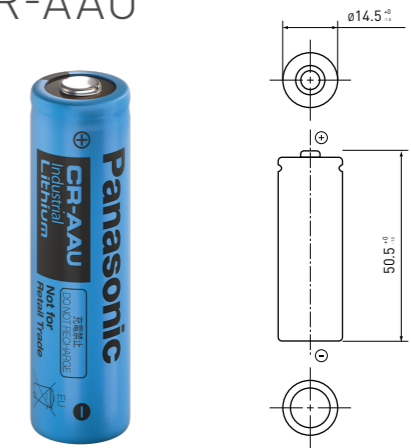

SPECIFICATIONS	CR-AAU
Nominal voltage (V)	3
Nominal capacity (mAh)	1,800
Diameter (mm)	14.5
Total height (mm)	50.5
Discharging temperature range (°C)	-40 to +85
Weight (g)	18.0

DISCHARGE CHARACTERISTICS

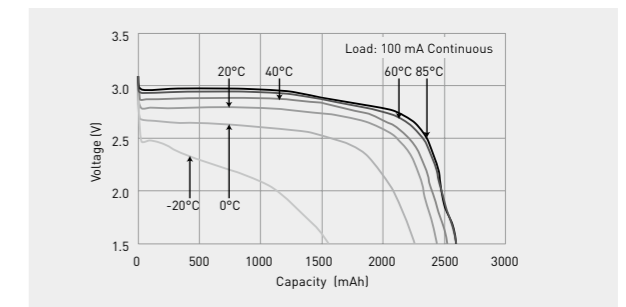

DISCHARGING CHARACTERISTICS BY TEMPERATURE

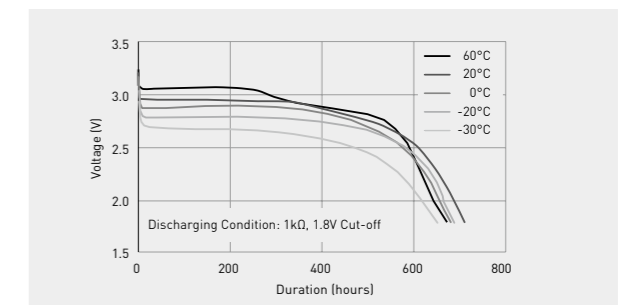

OPERATING VOLTAGE VS. DISCHARGE CURRENT^{*1}

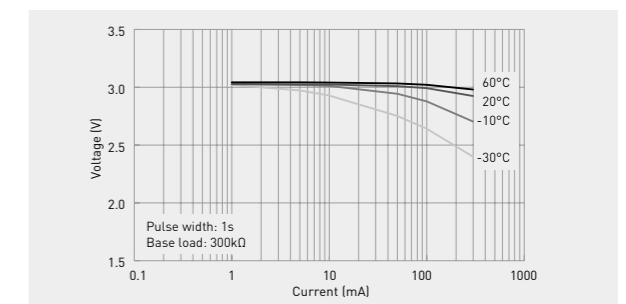

The data in this document are for descriptive purposes only and are not intended to make or imply any guarantee or warranty.

CR-2Z

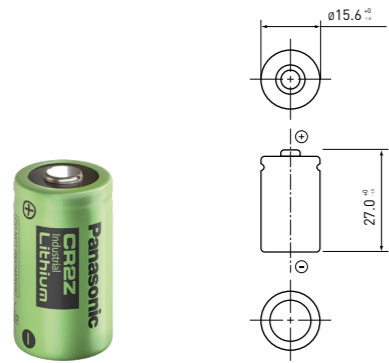

SPECIFICATIONS	CR-2Z
Nominal voltage (V)	3
Nominal capacity (mAh)	1,000
Diameter (mm)	15.6
Total height (mm)	27.0
Discharging temperature range (°C)	-40 to +75
Weight (g)	11.0

DISCHARGE CHARACTERISTICS

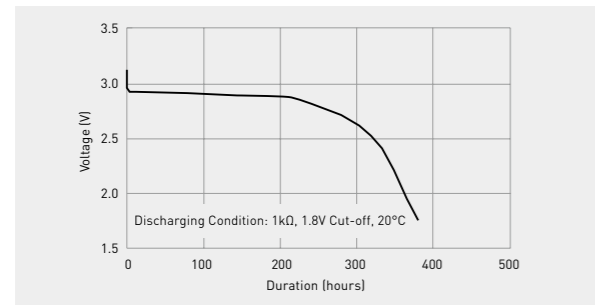

CR-2U

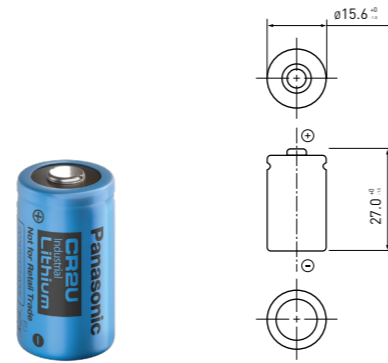

SPECIFICATIONS	CR-2U
Nominal voltage (V)	3
Nominal capacity (mAh)	1,000
Diameter (mm)	15.6
Total height (mm)	27.0
Discharging temperature range (°C)	-40 to +70
Weight (g)	11.0

DISCHARGE CHARACTERISTICS

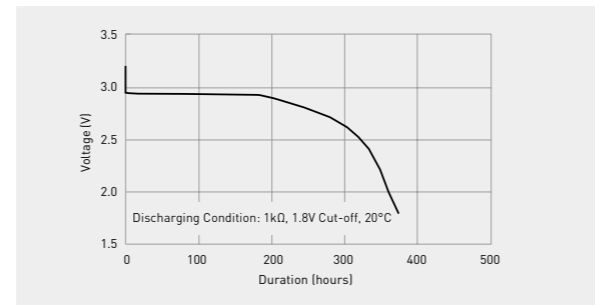

DISCHARGING CHARACTERISTICS BY TEMPERATURE

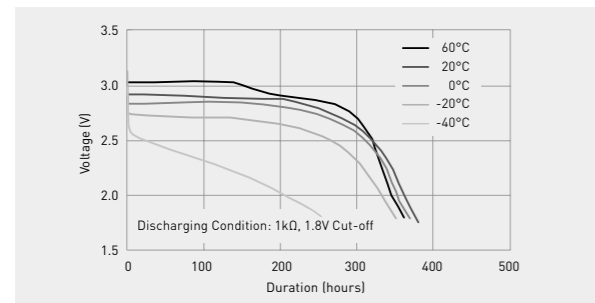

DISCHARGING CHARACTERISTICS BY TEMPERATURE

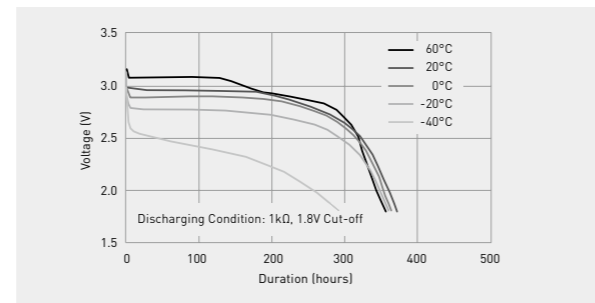

PULSE DISCHARGING CHARACTERISTICS*1

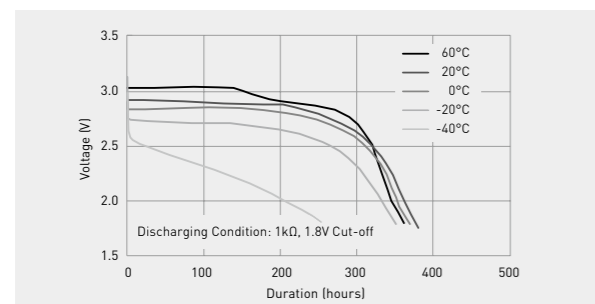

PULSE DISCHARGING CHARACTERISTICS*1

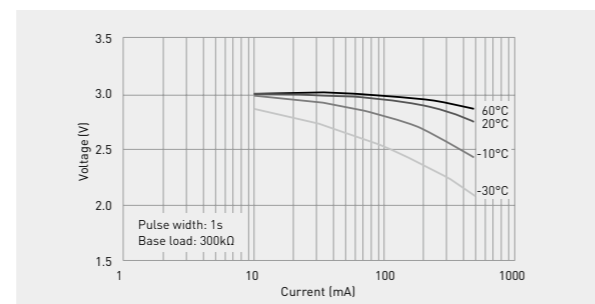

The data in this document are for descriptive purposes only and are not intended to make or imply any guarantee or warranty.

*1 at 50% depth-of-discharge (DoD).

CR-2/3AU

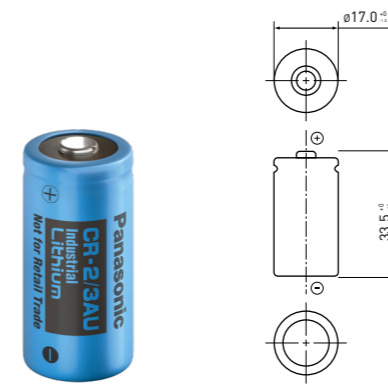

SPECIFICATIONS	CR-2/3AU
Nominal voltage (V)	3
Nominal capacity (mAh)	1,600
Diameter (mm)	17.0
Total height (mm)	33.5
Discharging temperature range (°C)	-40 to +85
Weight (g)	16.0

DISCHARGE CHARACTERISTICS

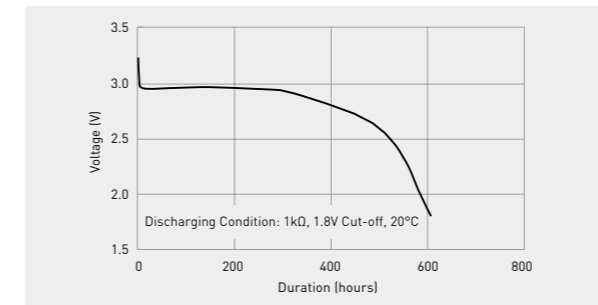

PULSE DISCHARGING CHARACTERISTICS

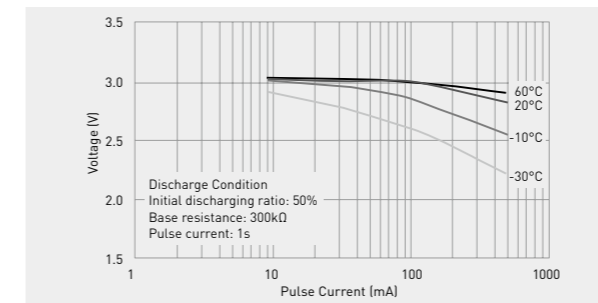

CR-2/3AZ

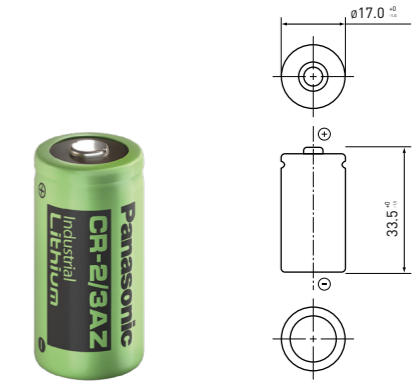

SPECIFICATIONS	CR-2/3AZ
Nominal voltage (V)	3
Nominal capacity (mAh)	1,600
Diameter (mm)	17.0
Total height (mm)	33.5
Discharging temperature range (°C)	-40 to +70
Weight (g)	16.0

DISCHARGE CHARACTERISTICS

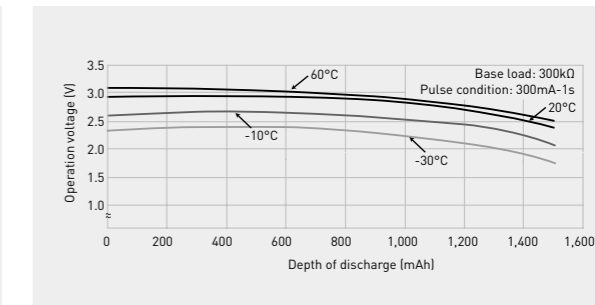

DISCHARGE TEMPERATURE CHARACTERISTICS

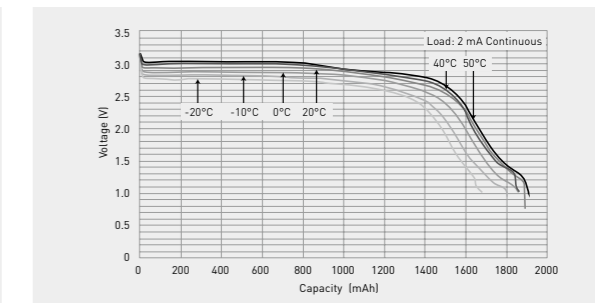

PULSE DISCHARGING CHARACTERISTICS

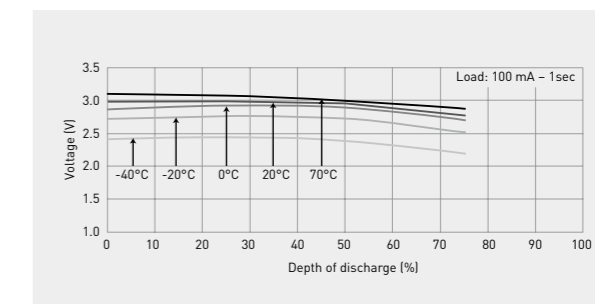

The data in this document are for descriptive purposes only and are not intended to make or imply any guarantee or warranty.

CR-AG

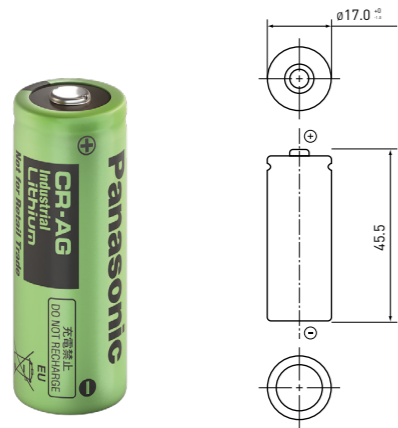

SPECIFICATIONS	CR-AG
Nominal voltage (V)	3
Nominal capacity (mAh)	2,400
Diameter (mm)	17.0
Total height (mm)	45.5
Discharging temperature range (°C)	-40 to +70
Weight (g)	24.0

DISCHARGE TEMPERATURE CHARACTERISTICS

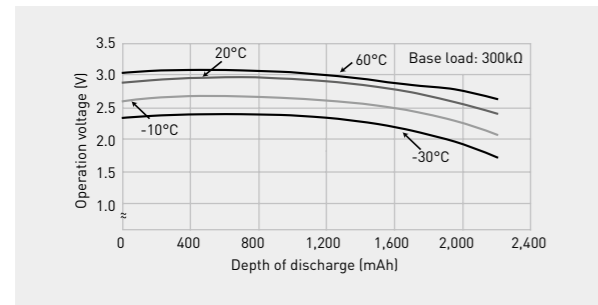

CR-AGZ

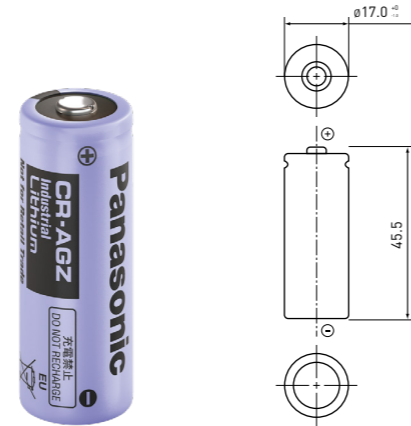

SPECIFICATIONS	CR-AGZ
Nominal voltage (V)	3
Nominal capacity (mAh)	2,700
Diameter (mm)	17.0
Total height (mm)	45.5
Discharging temperature range (°C)	-40 to +70
Weight (g)	23.0

DISCHARGE TEMPERATURE CHARACTERISTICS

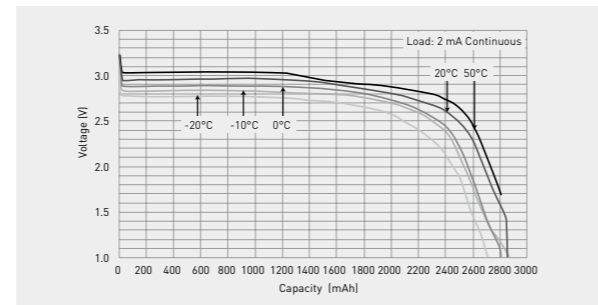

DISCHARGE TEMPERATURE CHARACTERISTICS

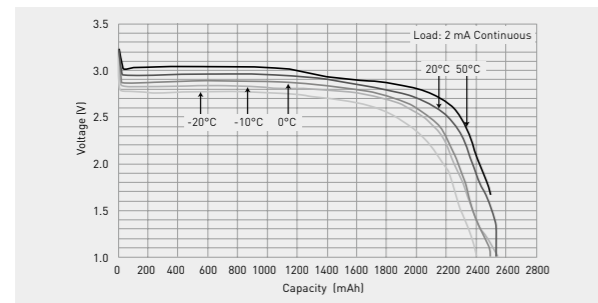

PULSE DISCHARGE CHARACTERISTICS

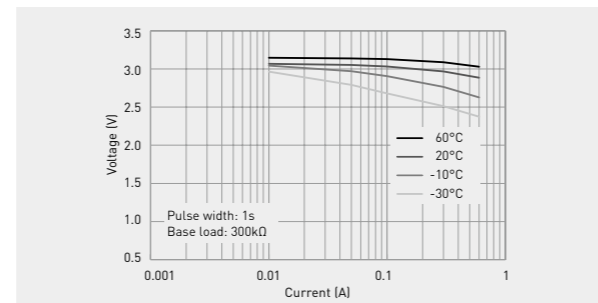

PULSE DISCHARGE CHARACTERISTICS

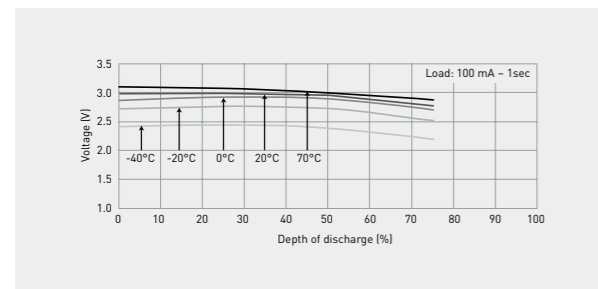

OPERATING VOLTAGE VS. DISCHARGE CURRENT*1

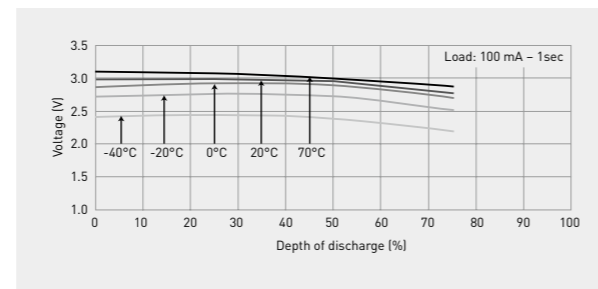

The data in this document are for descriptive purposes only and are not intended to make or imply any guarantee or warranty.
*1 at 50% depth-of-discharge (DoD).

CR-LAZ

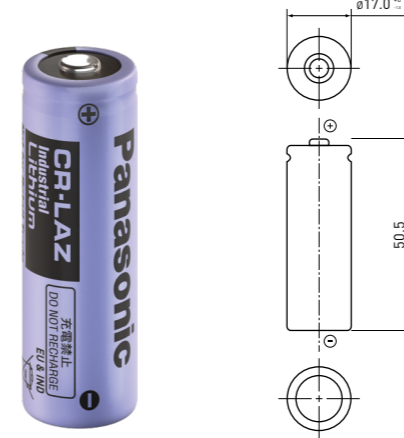

SPECIFICATIONS	CR-LAZ
Nominal voltage (V)	3
Nominal capacity (mAh)	3,000
Diameter (mm)	17.0
Total height (mm)	50.5
Discharging temperature range (°C)	-40 to +85
Weight (g)	26.0

DISCHARGE CHARACTERISTICS

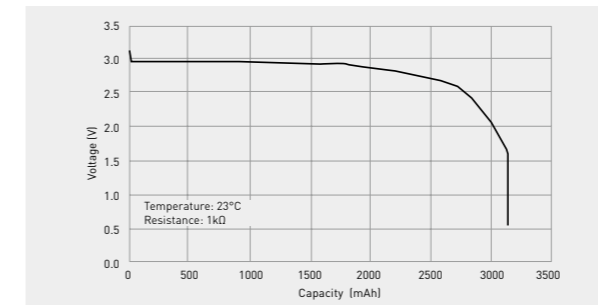

DISCHARGING CHARACTERISTICS BY TEMPERATURE

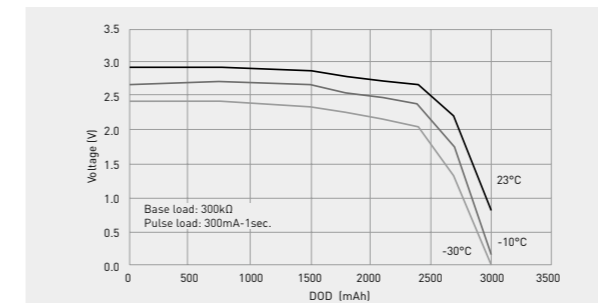

CR-LAS

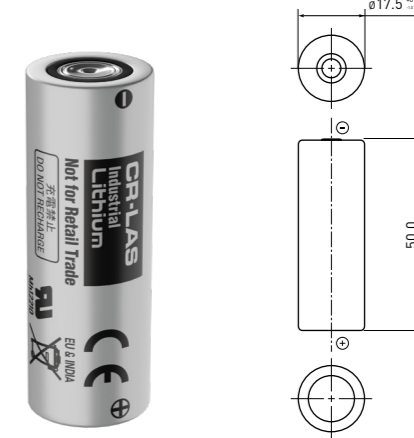

SPECIFICATIONS	CR-LAS
Nominal voltage (V)	3
Nominal capacity (mAh)	3,500
Diameter (mm)	17.5
Total height (mm)	50.0
Discharging temperature range (°C)	-40 to +85
Weight (g)	28.0

DISCHARGE CHARACTERISTICS

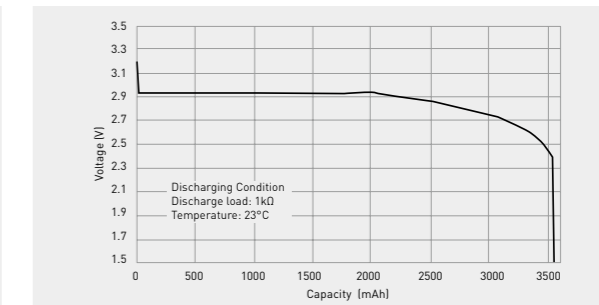

PULSE DISCHARGING CHARACTERISTICS

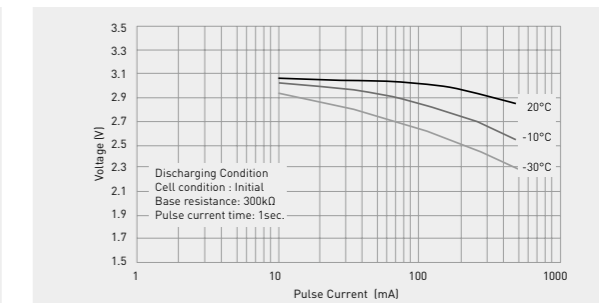

The data in this document are for descriptive purposes only and are not intended to make or imply any guarantee or warranty.

POLY-CARBONMONOFLUORIDE LITHIUM BATTERIES (BR SERIES) – COIN TYPE

(NON-RECHARGEABLE)

Panasonic Lithium BR coin type batteries feature high energy density, and were developed and commercialized using Panasonic's extensive experience in battery technology. They exhibit stable performance under high ambient temperatures.

FEATURES

- Self-discharge rate at 20°C is less than 1.0% per year
- Wide operating temperature range: between -30°C ~ +85°C
- Superior long-term reliability
- Over 44 years of experience in production

APPLICATIONS

- Tracking & RFID
- Real Time Clock (RTC)
- Memory back-up
- Meters, etc.

MODEL NUMBER	Nominal voltage [V]	Nominal ¹⁾ capacity [mAh]	Diameter [mm]	Total height [mm]	Weight [g]	Discharging temperature [°C]
BR-1220	3	35	12.5	2.0	0.7	-30 to +85
BR-1225	3	48	12.5	2.5	0.8	-30 to +85
BR-1632	3	120	16.0	3.2	1.5	-30 to +85
BR-2032	3	200	20.0	3.2	2.6	-30 to +85
BR-2325	3	165	23.0	2.5	3.0	-30 to +85
BR-2330	3	255	23.0	3.0	3.2	-30 to +85
BR-3032	3	500	30.0	3.2	5.7	-30 to +85

BATTERY INSIDE*2

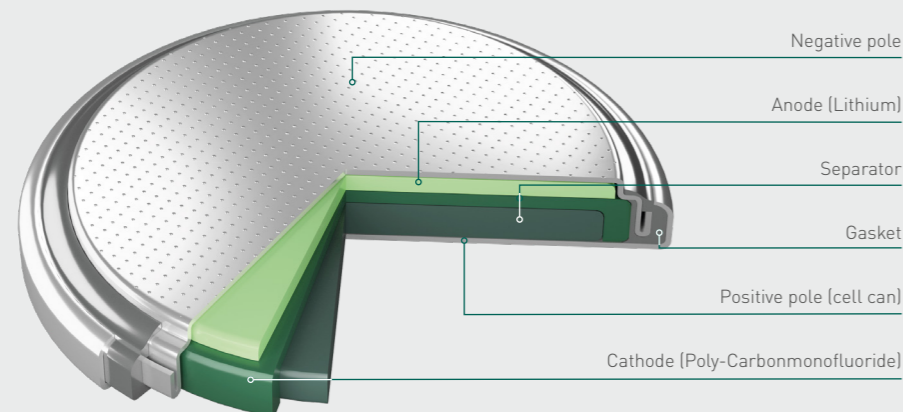

The data in this document are for descriptive purposes only and are not intended to make or imply any guarantee or warranty.

¹⁾ Based on standard drain and cut off voltage down to 2.0V at 20°C.

²⁾ The illustration shows only one example of Lithium battery structure.

BR-1220

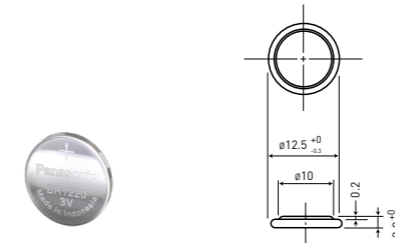

SPECIFICATIONS

	BR-1220
Nominal voltage [V]	3
Nominal capacity [mAh]	35
Diameter [mm]	12.5
Total height [mm]	2.0
Discharging temperature range [°C]	-30 to +85
Weight [g]	0.7

DISCHARGE TEMPERATURE CHARACTERISTICS

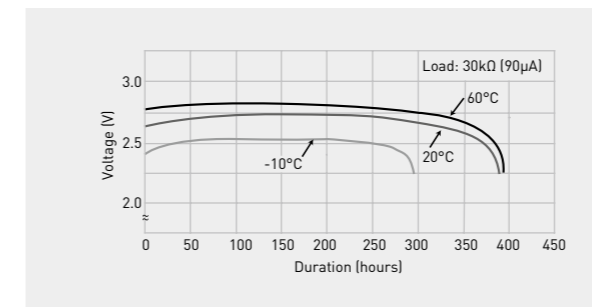

OPERATING VOLTAGE VS. DISCHARGE CURRENT*1

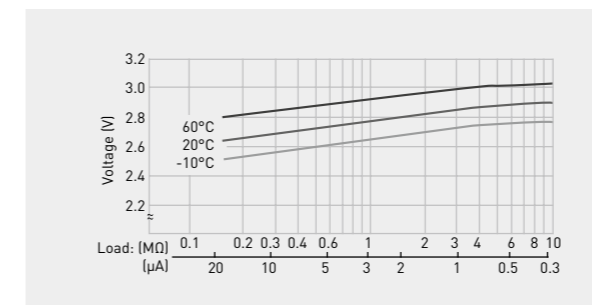

CAPACITY VS. LOAD RESISTANCE

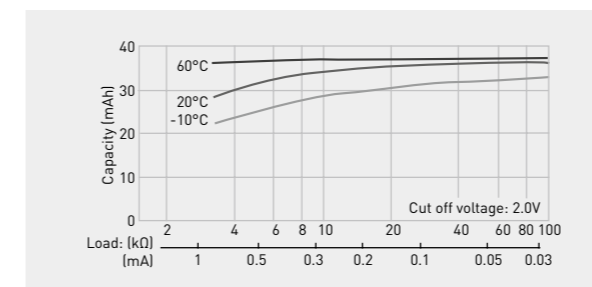

BR-1225

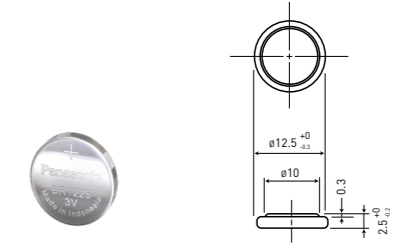

SPECIFICATIONS

	BR-1225
Nominal voltage [V]	3
Nominal capacity [mAh]	48
Diameter [mm]	12.5
Total height [mm]	2.5
Discharging temperature range [°C]	-30 to +85
Weight [g]	0.8

DISCHARGE TEMPERATURE CHARACTERISTICS

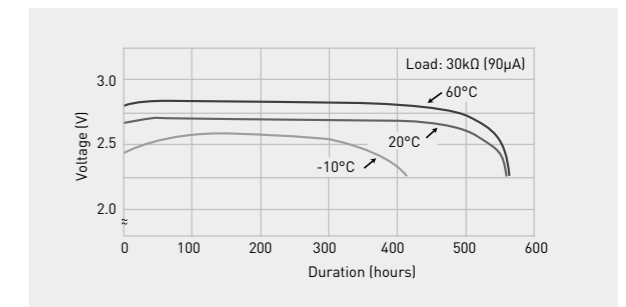

OPERATING VOLTAGE VS. DISCHARGE CURRENT*1

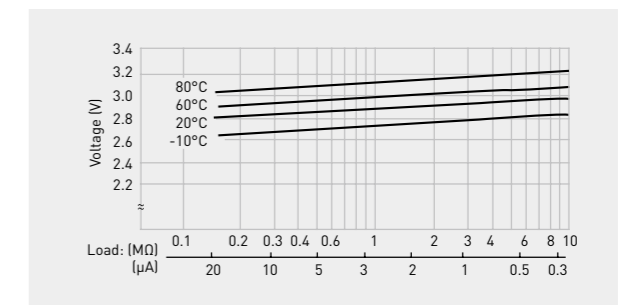

CAPACITY VS. LOAD RESISTANCE

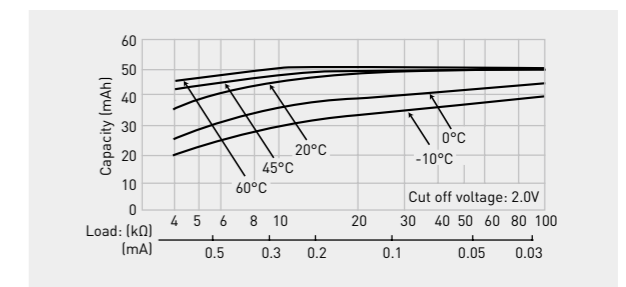

The data in this document are for descriptive purposes only and are not intended to make or imply any guarantee or warranty.

¹⁾ at 50% depth-of-discharge (DoD)

BR-1632

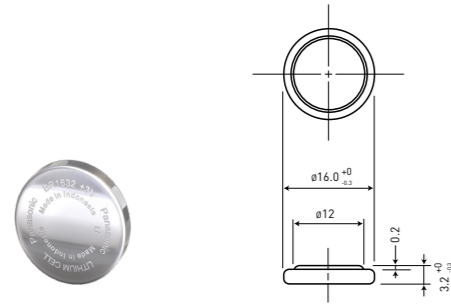

SPECIFICATIONS	BR-1632
Nominal voltage (V)	3
Nominal capacity (mAh)	120
Diameter (mm)	16.0
Total height (mm)	3.2
Discharging temperature range (°C)	-30 to +85
Weight (g)	1.5

DISCHARGE TEMPERATURE CHARACTERISTICS

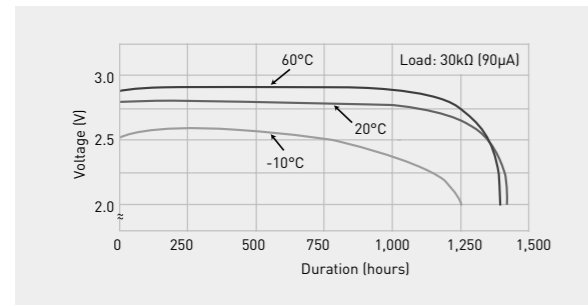

OPERATING VOLTAGE VS. DISCHARGE CURRENT**

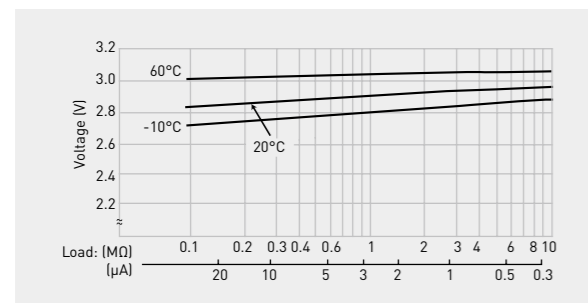

CAPACITY VS. LOAD RESISTANCE

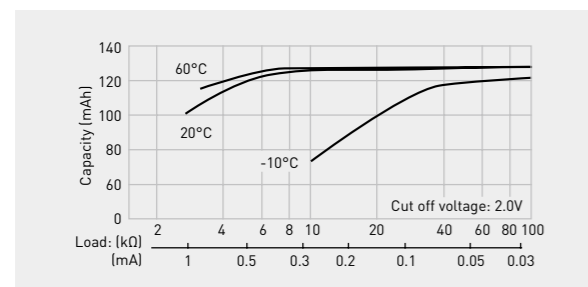

BR-2032

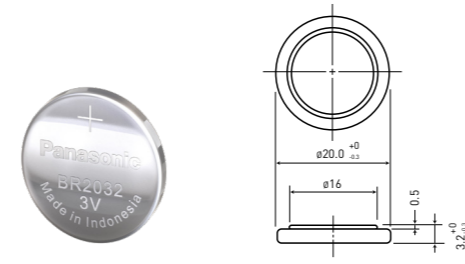

SPECIFICATIONS	BR-2032
Nominal voltage (V)	3
Nominal capacity (mAh)	200
Diameter (mm)	20.0
Total height (mm)	3.2
Discharging temperature range (°C)	-30 to +85
Weight (g)	2.6

DISCHARGE TEMPERATURE CHARACTERISTICS

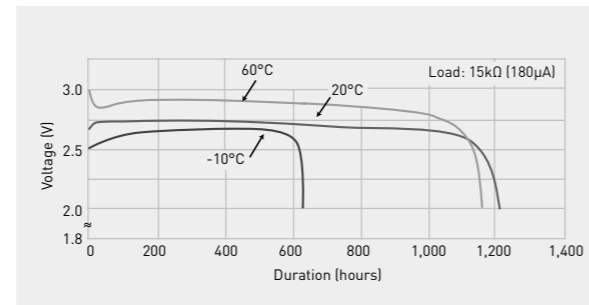

OPERATING VOLTAGE VS. DISCHARGE CURRENT**

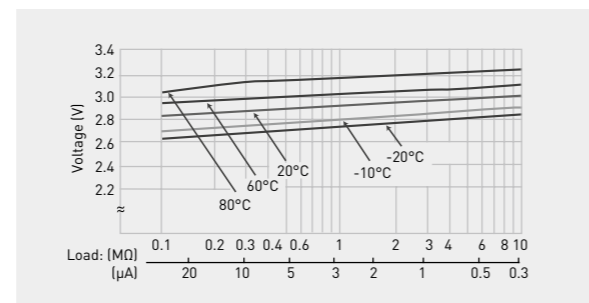

CAPACITY VS. LOAD RESISTANCE

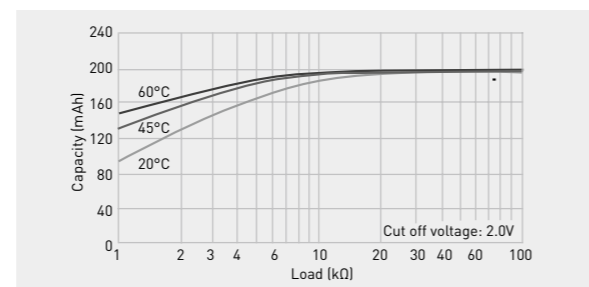

BR-2325

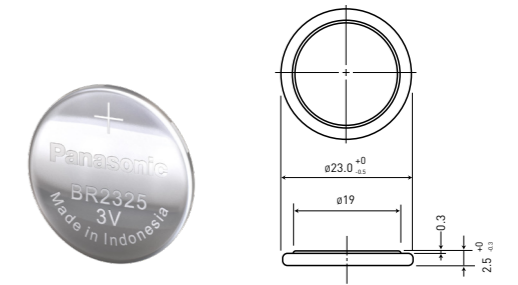

SPECIFICATIONS	BR-2325
Nominal voltage (V)	3
Nominal capacity (mAh)	165
Diameter (mm)	23.0
Total height (mm)	2.5
Discharging temperature range (°C)	-30 to +85
Weight (g)	3.0

DISCHARGE TEMPERATURE CHARACTERISTICS

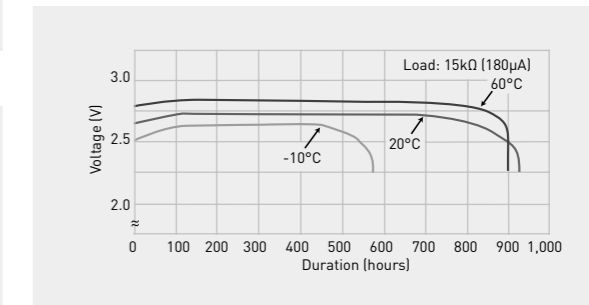

OPERATING VOLTAGE VS. DISCHARGE CURRENT**

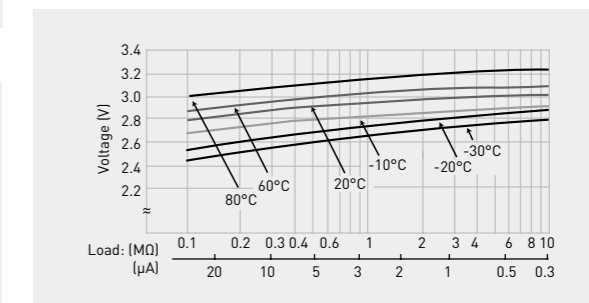

CAPACITY VS. LOAD RESISTANCE

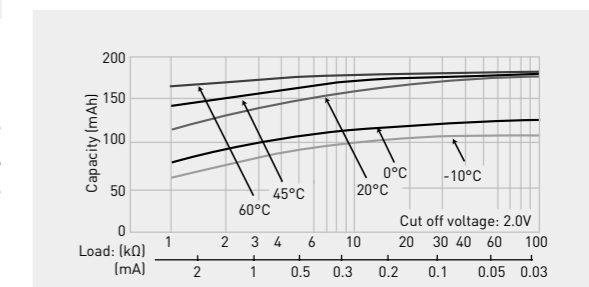

LITHIUM BATTERY HOLDERS FOR BR-2032

These battery holders are designed for sure and easy loading/removal of Panasonic coin type Lithium batteries in/from equipment enabling the batteries to fully exploit their capabilities as the back-up power supply in C-MOS RAM memory and microcomputer memory. All of the battery holders are designed to prevent inverted insertion of the battery.

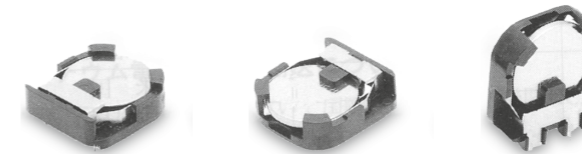

BCR20H4 BCR20H5 BCR20V4

BCR20H4 (3 terminals)

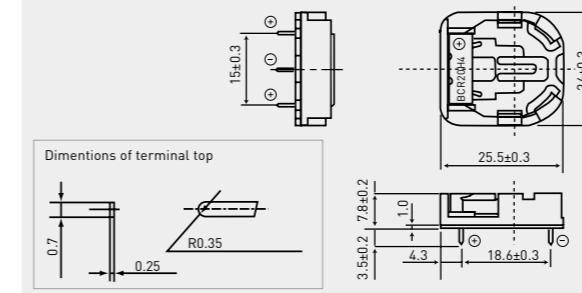

BCR20H5 (2 terminals)

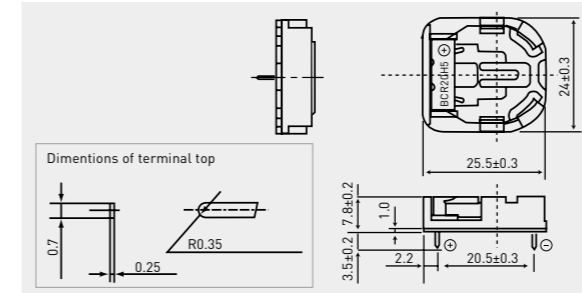

BCR20V4 (3 terminals)

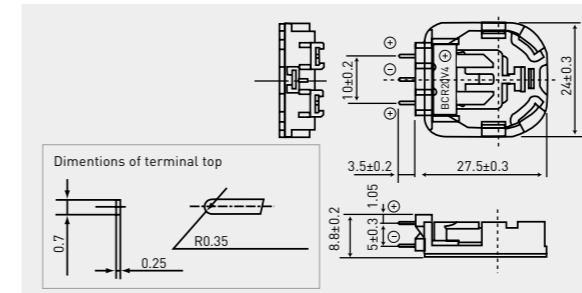

PRECAUTION FOR WASHING BATTERY HOLDERS

The battery holders can be adversely affected by some detergents use in the circuit board washing process and may result in cracks forming in the holder. Please test the holders in your washing process before use.

BR-2330

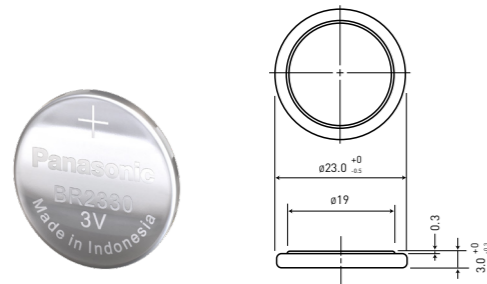

SPECIFICATIONS	BR-2330
Nominal voltage (V)	3
Nominal capacity (mAh)	255
Diameter (mm)	23.0
Total height (mm)	3.0
Discharging temperature range (°C)	-30 to +85
Weight (g)	3.2

DISCHARGE TEMPERATURE CHARACTERISTICS

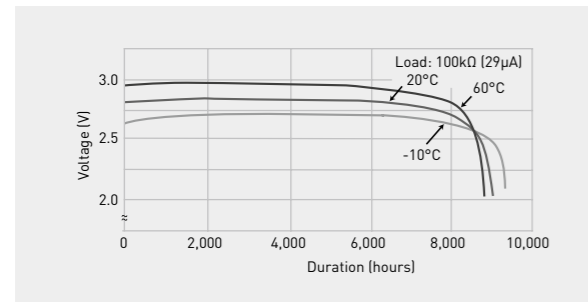

OPERATING VOLTAGE VS. DISCHARGE CURRENT^{*1}

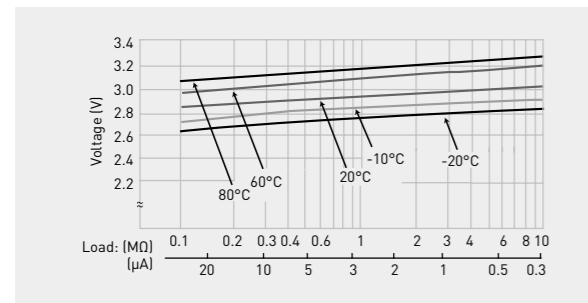

CAPACITY VS. LOAD RESISTANCE

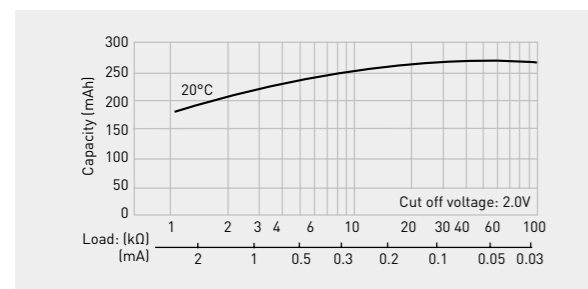

BR-3032

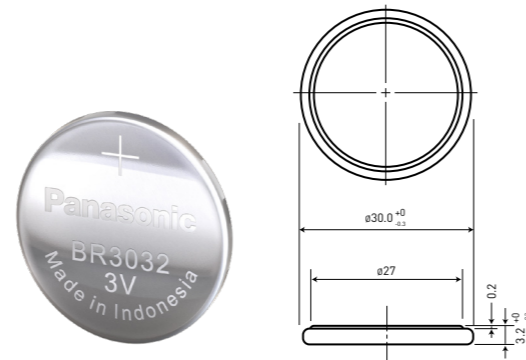

SPECIFICATIONS	BR-3032
Nominal voltage (V)	3
Nominal capacity (mAh)	500
Diameter (mm)	30.0
Total height (mm)	3.2
Discharging temperature range (°C)	-30 to +85
Weight (g)	5.7

DISCHARGE TEMPERATURE CHARACTERISTICS

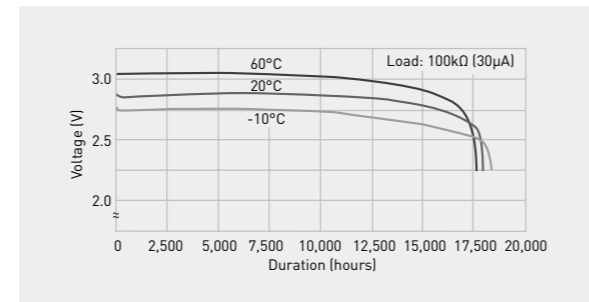

OPERATING VOLTAGE VS. DISCHARGE CURRENT^{*1}

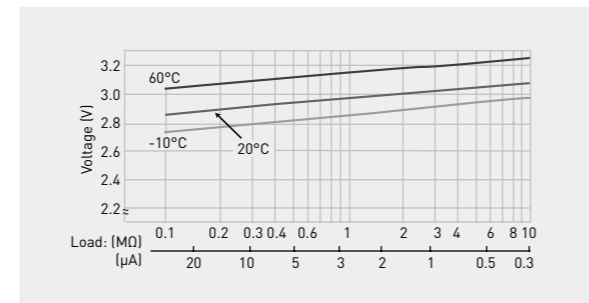

CAPACITY VS. LOAD RESISTANCE

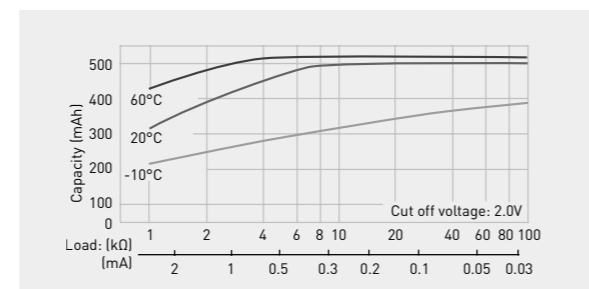

HIGH OPERATING TEMPERATURE POLY-CARBONMONOFLUORIDE LITHIUM BATTERIES (BR-A SERIES) – COIN TYPE (NON-RECHARGEABLE)

The high energy density and the special material for gasket and separator make this battery series the ideal power supply in high ambient temperature applications.

FEATURES

- Superior design for high temperature applications (-40°C ~ +125°C)
- Outstanding long-term reliability
- Over 24 years of experience in production
- Self-discharge rate at 20°C is less than 0.5% per year

APPLICATIONS

- Tire Pressure Monitoring Systems (TPMS)
- Electronic Toll Collection (ETC)
- Heat cost allocators, etc.

MODEL NUMBER	Nominal voltage (V)	Nominal ^{*1} capacity (mAh)	Diameter (mm)	Total height (mm)	Weight (g)	Discharging temperature (°C)
BR-1225A	3	48	12.5	2.5	0.8	-40 to +125
BR-1632A ^{*2}	3	120	16.0	3.2	1.5	-40 to +125
BR-2330A ^{*2}	3	255	23.0	3.0	3.2	-40 to +125
BR-2450A ^{*2}	3	550	24.5	5.9	4.9	-40 to +125
BR-2477A ^{*2}	3	1,000	24.5	7.7	7.9	-40 to +125

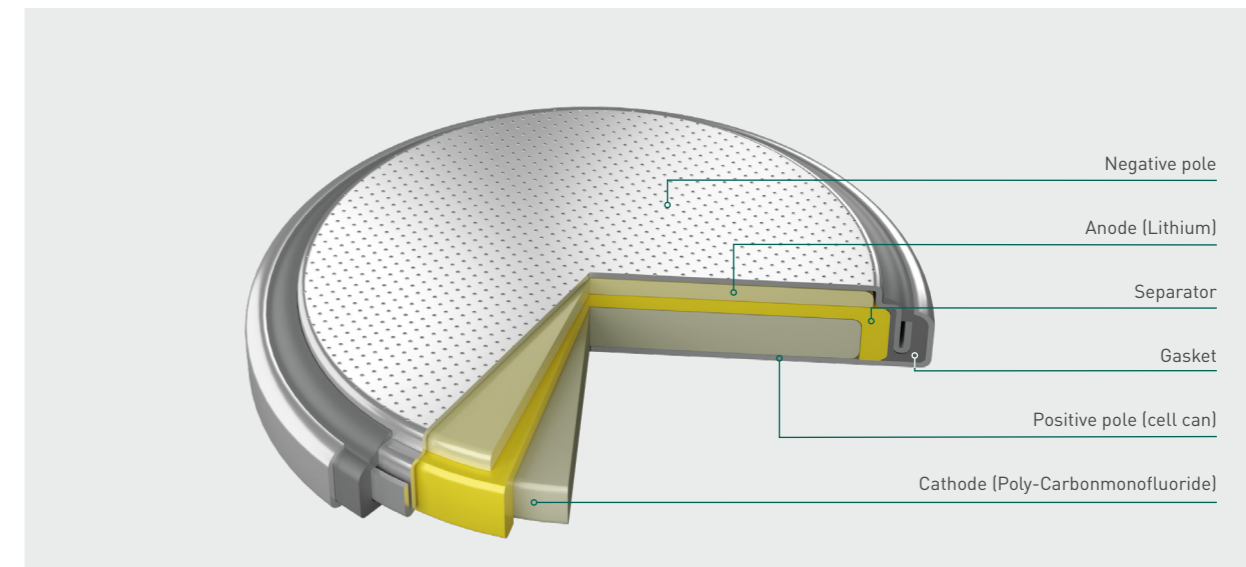

BATTERY INSIDE^{*3}

The data in this document are for descriptive purposes only and are not intended to make or imply any guarantee or warranty.

^{*1} Based on standard drain and cut off voltage down to 2.0V at 20°C.

^{*2} Cells are supplied with tabs or lead-wires only. For available configurations please consult the Panasonic homepage or your sales contact.

^{*3} The illustration shows only one example of lithium battery structure.

BR-1225A

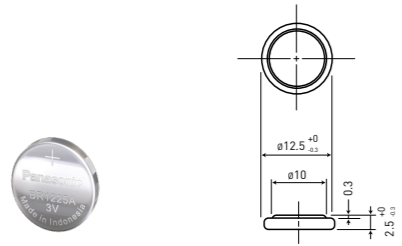

SPECIFICATIONS	BR-1225A
Nominal voltage (V)	3
Nominal capacity (mAh)	48
Diameter (mm)	12.5
Total height (mm)	2.5
Discharging temperature range (°C)	-40 to +125
Weight (g)	0.8

DISCHARGE TEMPERATURE CHARACTERISTICS

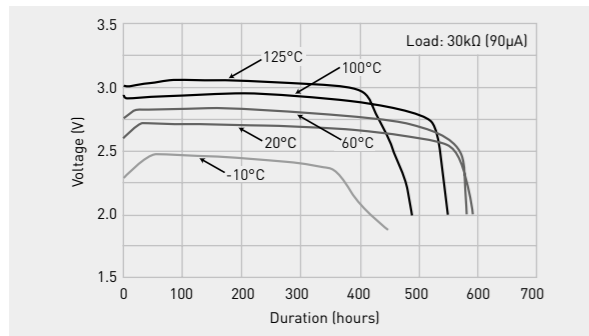

BR-1632A

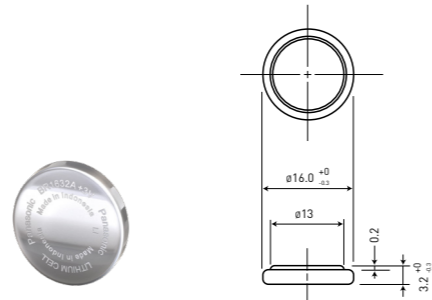

SPECIFICATIONS	BR-1632A
Nominal voltage (V)	3
Nominal capacity (mAh)	120
Diameter (mm)	16.0
Total height (mm)	3.2
Discharging temperature range (°C)	-40 to +125
Weight (g)	1.5

DISCHARGE TEMPERATURE CHARACTERISTICS

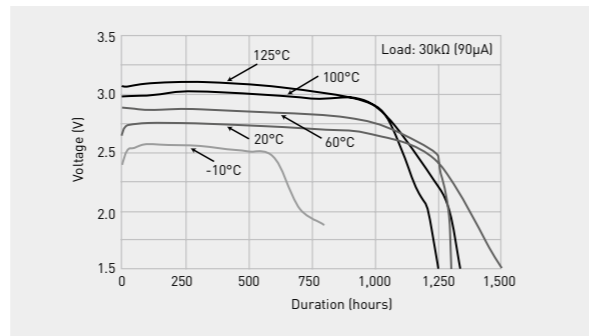

BR-2330A

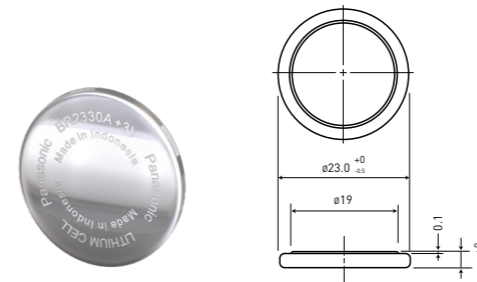

SPECIFICATIONS	BR-2330A
Nominal voltage (V)	3
Nominal capacity (mAh)	1,000
Diameter (mm)	15.6
Total height (mm)	27.0
Discharging temperature range (°C)	-40 to +75
Weight (g)	11.0

DISCHARGE TEMPERATURE CHARACTERISTICS

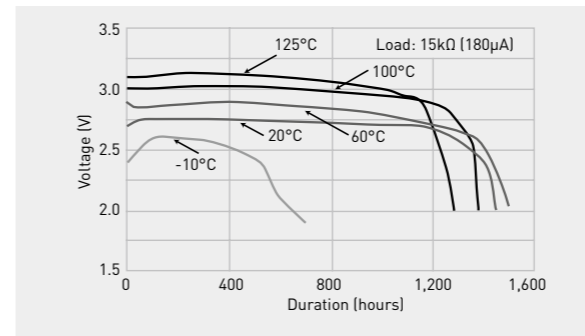

BR-2450A

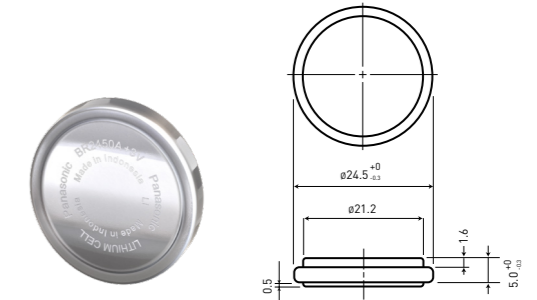

SPECIFICATIONS	BR-2450A
Nominal voltage (V)	3
Nominal capacity (mAh)	1,000
Diameter (mm)	15.6
Total height (mm)	27.0
Discharging temperature range (°C)	-40 to +70
Weight (g)	11.0

DISCHARGE TEMPERATURE CHARACTERISTICS

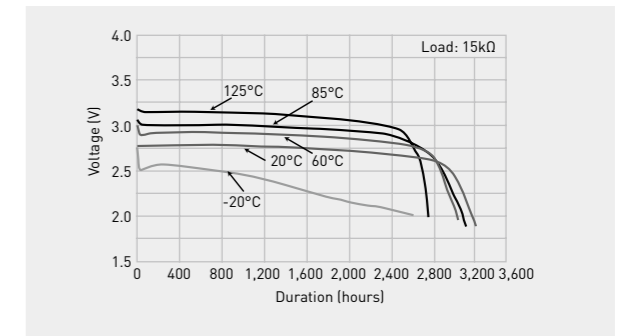

BR-2477A

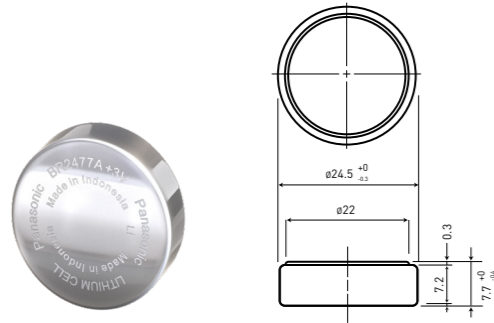

SPECIFICATIONS	BR-2477A
Nominal voltage (V)	3
Nominal capacity (mAh)	1,000
Diameter (mm)	44.5
Total height (mm)	7.7
Discharging temperature range (°C)	-40 to +125
Weight (g)	7.9

DISCHARGE TEMPERATURE CHARACTERISTICS

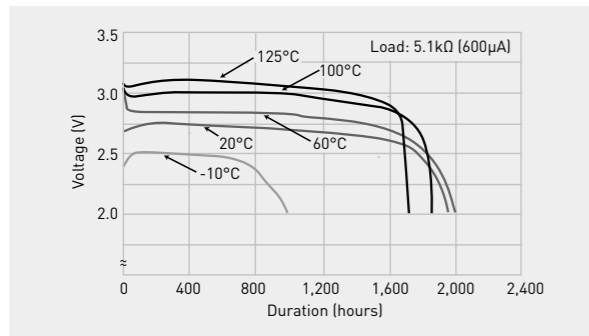

MANGANESE DIOXIDE LITHIUM BATTERIES (CR SERIES) – COIN TYPE

(NON-RECHARGEABLE)

These batteries have a proven track record of excellence in equipment requiring high currents. Additionally Panasonic has many years of manufacturing experience with this battery technology.

FEATURES

- Good pulse capability
- Stable voltage level during discharge
- Long-term reliability
- Self-discharge rate at 20°C is just 1.0% per year
- Temperature range: -30°C ~ +85°C¹

APPLICATIONS

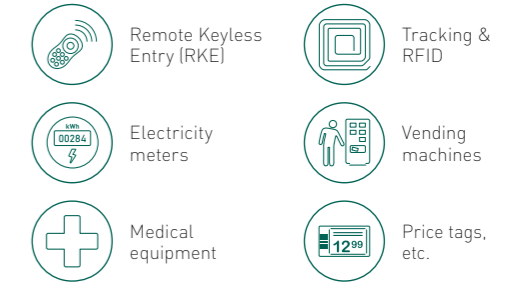

MODEL NUMBER	Nominal voltage (V)	Nominal ² capacity (mAh)	Diameter (mm)	Total height (mm)	Weight (g)	Discharging temperature (°C)
CR-1025	3	30	10.0	2.5	0.6	-30 to +85
CR-1216	3	25	12.5	1.6	0.7	-30 to +85
CR-1220	3	35	12.5	2.0	0.9	-30 to +85
CR-1616	3	55	16.0	1.6	1.0	-30 to +85
CR-1620	3	75	16.0	2.0	1.3	-30 to +85
CR-1632	3	140	16.0	3.2	1.9	-30 to +85
CR-2012	3	55	20.0	1.2	1.4	-30 to +85
CR-2016	3	90	20.0	1.6	1.6	-30 to +85
CR-2025	3	165	20.0	2.5	2.3	-30 to +85
CR-2032	3	225	20.0	3.2	2.8	-30 to +85
CR-2330	3	265	23.0	3.0	3.7	-30 to +85
CR-2354	3	560	23.0	5.4	5.7	-30 to +85
CR-2412	3	100	24.5	1.2	2.0	-30 to +85
CR-2450	3	620	24.5	5.0	6.2	-30 to +85
CR-2477	3	1,000	24.5	7.7	10.5	-30 to +85
CR-3032	3	500	30.0	3.2	6.9	-30 to +85

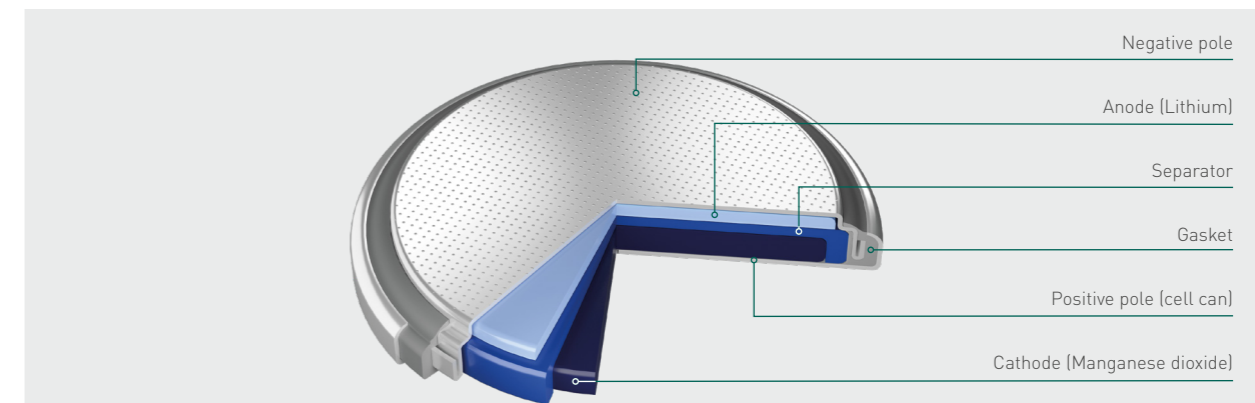

BATTERY INSIDE^{*3}

The data in this document are for descriptive purposes only and are not intended to make or imply any guarantee or warranty.

¹ Based on standard drain and cut off voltage down to 2.0V at 20°C.

² Please contact Panasonic when anticipating usage in operation temperature 70°C or above.

³ The illustration shows only one example of lithium battery structure.

CR-1025

CR-1216

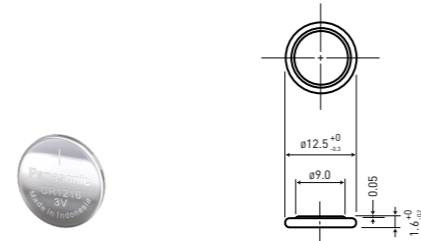
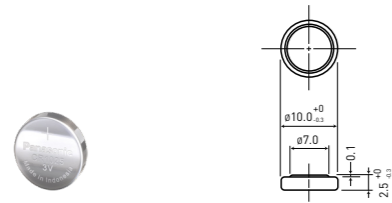

SPECIFICATIONS	CR-1025
Nominal voltage (V)	3
Nominal capacity (mAh)	30
Diameter (mm)	10.0
Total height (mm)	2.5
Discharging temperature range (°C)	-30 to +85
Weight (g)	0.6

SPECIFICATIONS	CR-1216
Nominal voltage (V)	3
Nominal capacity (mAh)	25
Diameter (mm)	12.5
Total height (mm)	1.6
Discharging temperature range (°C)	-30 to +85
Weight (g)	0.7

DISCHARGE TEMPERATURE CHARACTERISTICS

DISCHARGE TEMPERATURE CHARACTERISTICS

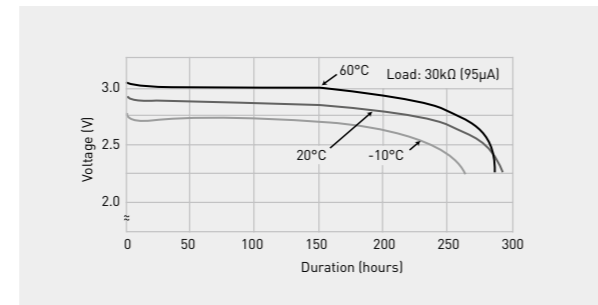
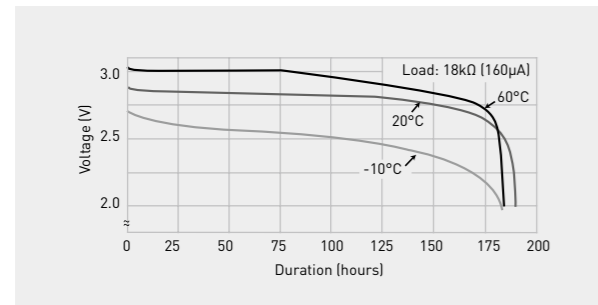

OPERATING VOLTAGE VS. DISCHARGE CURRENT**

OPERATING VOLTAGE VS. DISCHARGE CURRENT**

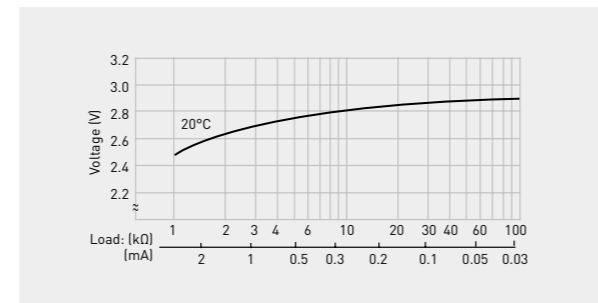
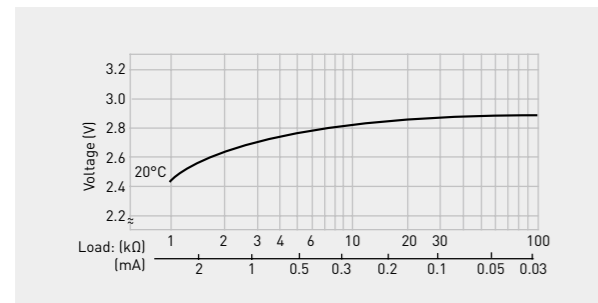

CAPACITY VS. LOAD RESISTANCE

CAPACITY VS. LOAD RESISTANCE

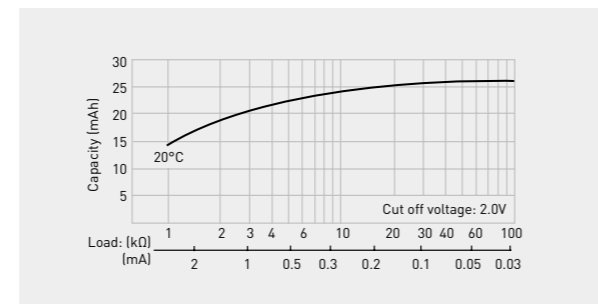
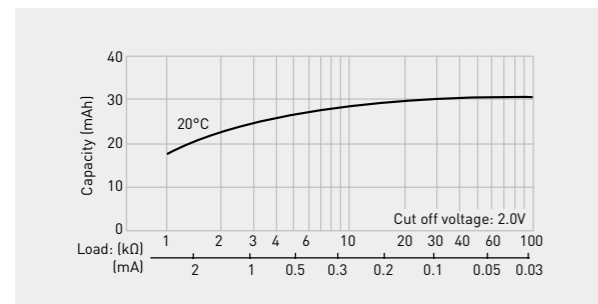

CR-1220

CR-1616

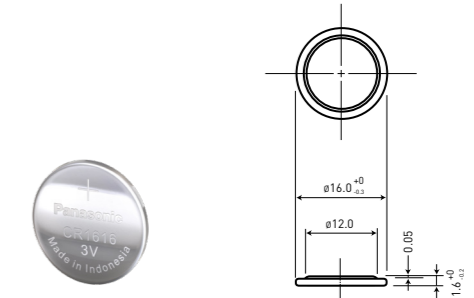
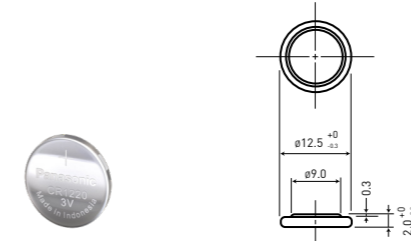

SPECIFICATIONS	CR-1220
Nominal voltage (V)	3
Nominal capacity (mAh)	35
Diameter (mm)	12.5
Total height (mm)	2.0
Discharging temperature range (°C)	-30 to +85
Weight (g)	0.9

SPECIFICATIONS	CR-1616
Nominal voltage (V)	3
Nominal capacity (mAh)	55
Diameter (mm)	16.0
Total height (mm)	1.6
Discharging temperature range (°C)	-30 to +85
Weight (g)	1.0

DISCHARGE TEMPERATURE CHARACTERISTICS

DISCHARGE TEMPERATURE CHARACTERISTICS

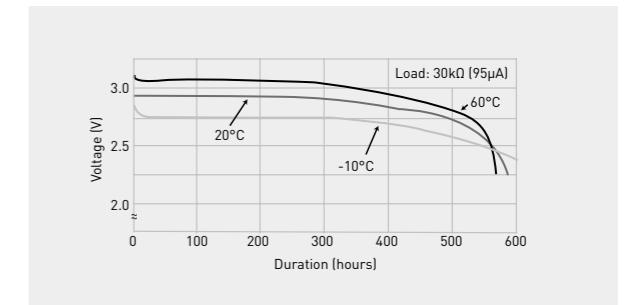
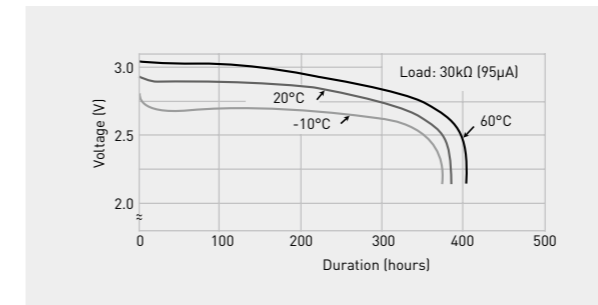

OPERATING VOLTAGE VS. DISCHARGE CURRENT**

OPERATING VOLTAGE VS. DISCHARGE CURRENT**

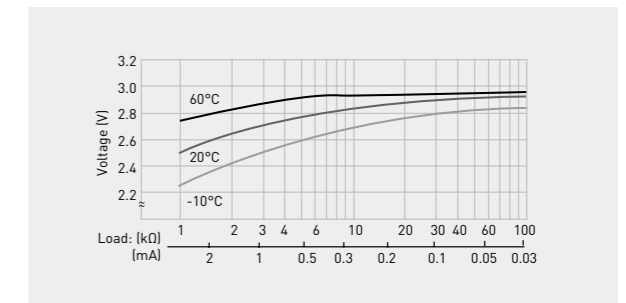
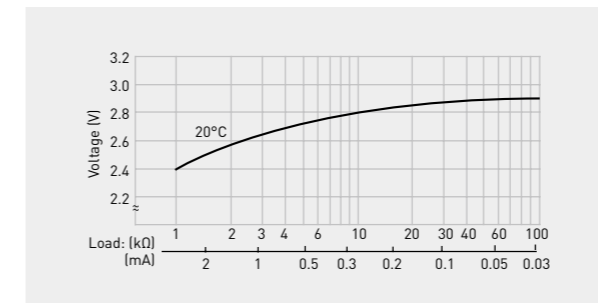

CAPACITY VS. LOAD RESISTANCE

CAPACITY VS. LOAD RESISTANCE

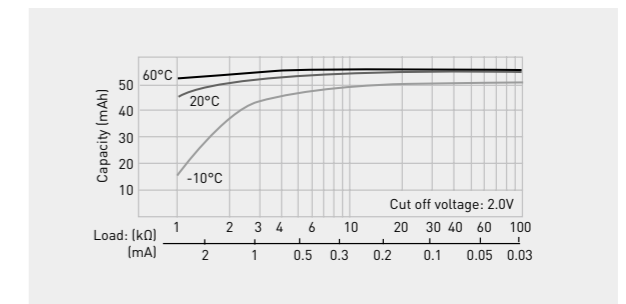
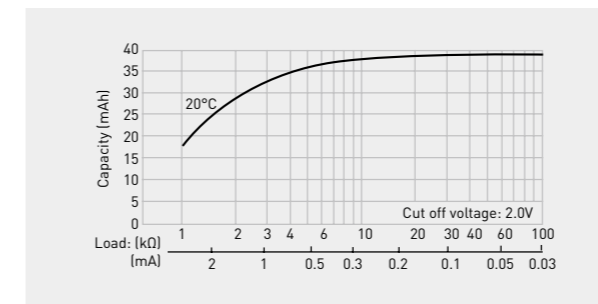

The data in this document are for descriptive purposes only and are not intended to make or imply any guarantee or warranty.
 ** at 50% depth-of-discharge (DoD)

The data in this document are for descriptive purposes only and are not intended to make or imply any guarantee or warranty.
 ** at 50% depth-of-discharge (DoD)

CR-1620

CR-1632

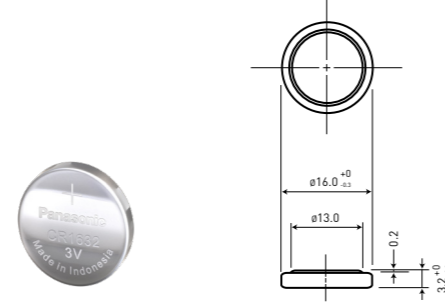
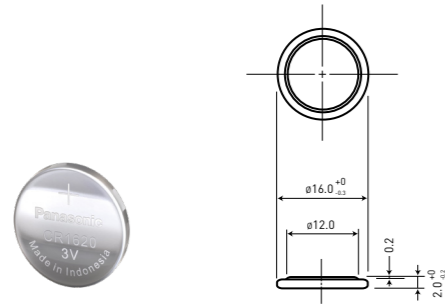

SPECIFICATIONS	CR-1620
Nominal voltage (V)	3
Nominal capacity (mAh)	75
Diameter (mm)	16.0
Total height (mm)	2.0
Discharging temperature range (°C)	-30 to +85
Weight (g)	1.3

SPECIFICATIONS	CR-1632
Nominal voltage (V)	3
Nominal capacity (mAh)	140
Diameter (mm)	16.0
Total height (mm)	3.2
Discharging temperature range (°C)	-30 to +85
Weight (g)	1.9

DISCHARGE TEMPERATURE CHARACTERISTICS

DISCHARGE TEMPERATURE CHARACTERISTICS

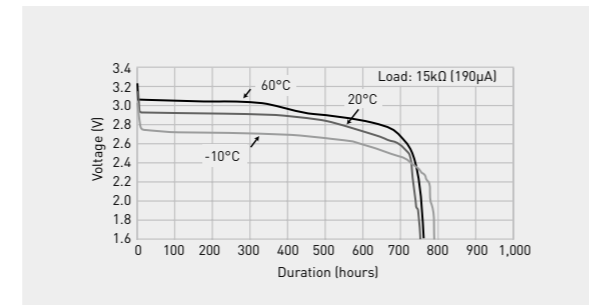
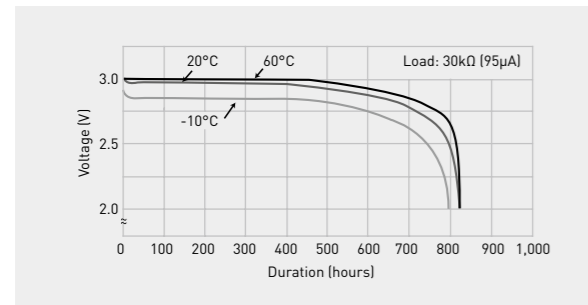

OPERATING VOLTAGE VS. DISCHARGE CURRENT**

OPERATING VOLTAGE VS. DISCHARGE CURRENT**

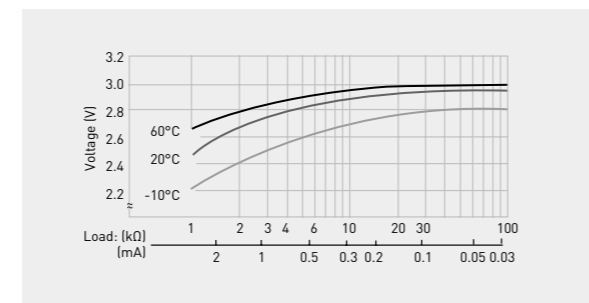
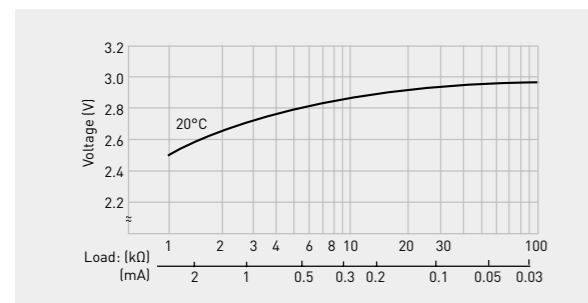

CAPACITY VS. LOAD RESISTANCE

CAPACITY VS. LOAD RESISTANCE

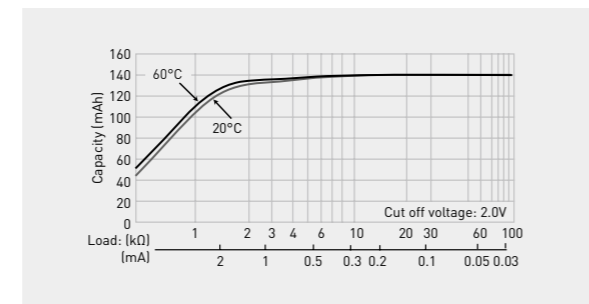
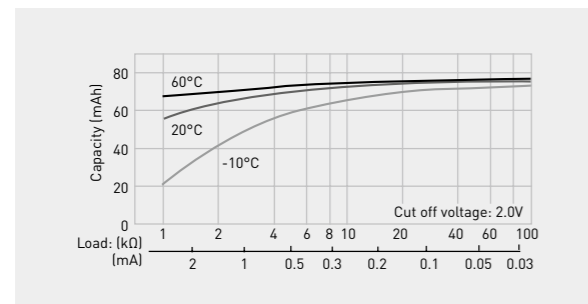

The data in this document are for descriptive purposes only and are not intended to make or imply any guarantee or warranty.
 ** at 50% depth-of-discharge (DoD)

CR-2012

CR-2016

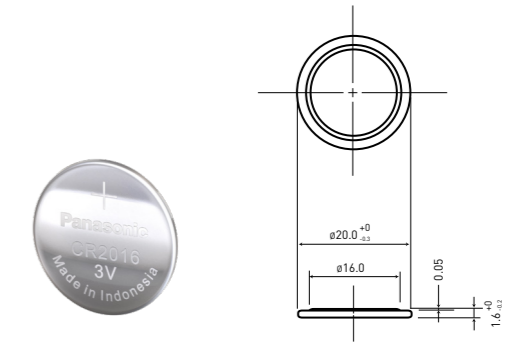
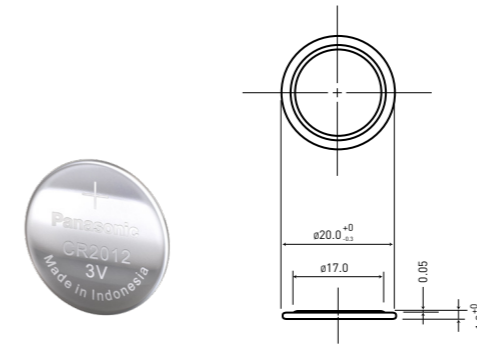

SPECIFICATIONS	CR-2012
Nominal voltage (V)	3
Nominal capacity (mAh)	55
Diameter (mm)	20.0
Total height (mm)	1.2
Discharging temperature range (°C)	-30 to +85
Weight (g)	1.4

SPECIFICATIONS	CR-2016
Nominal voltage (V)	3
Nominal capacity (mAh)	90
Diameter (mm)	20.0
Total height (mm)	1.6
Discharging temperature range (°C)	-30 to +85
Weight (g)	1.6

DISCHARGE TEMPERATURE CHARACTERISTICS

DISCHARGE TEMPERATURE CHARACTERISTICS

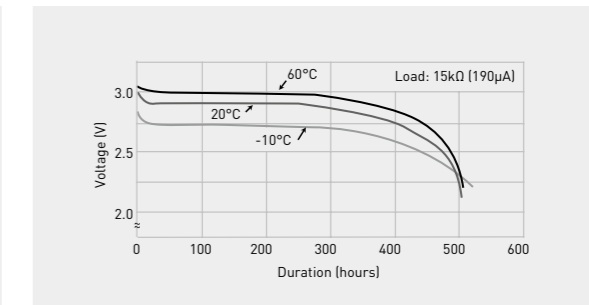
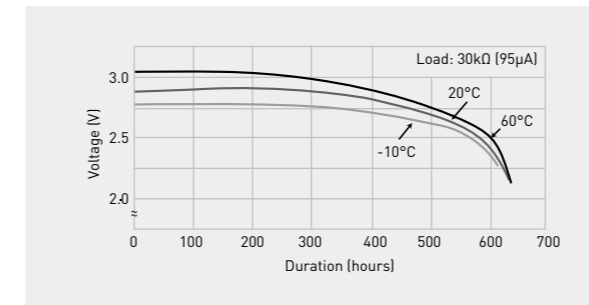

OPERATING VOLTAGE VS. DISCHARGE CURRENT**

OPERATING VOLTAGE VS. DISCHARGE CURRENT**

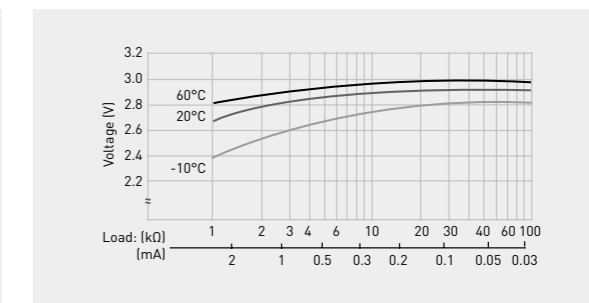
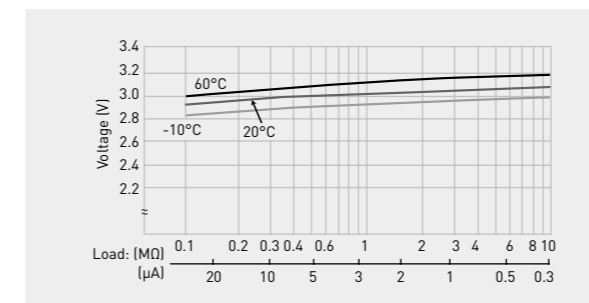

CAPACITY VS. LOAD RESISTANCE

CAPACITY VS. LOAD RESISTANCE

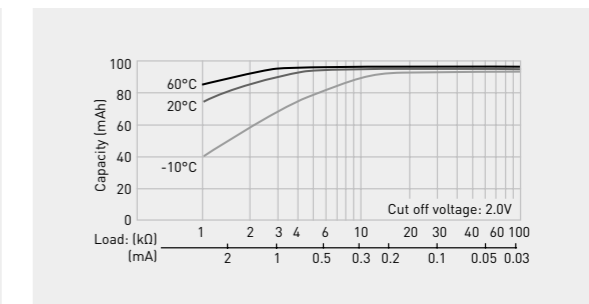
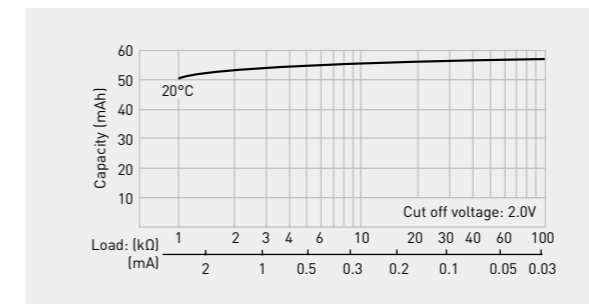

The data in this document are for descriptive purposes only and are not intended to make or imply any guarantee or warranty.
 ** at 50% depth-of-discharge (DoD)

CR-2025

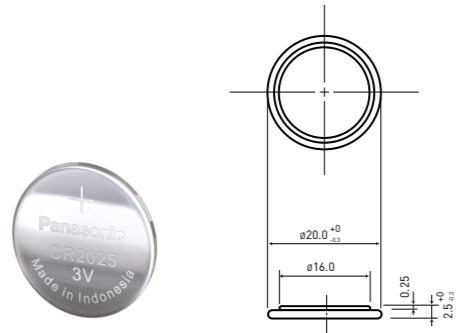

SPECIFICATIONS	CR-2025
Nominal voltage (V)	3
Nominal capacity (mAh)	165
Diameter (mm)	20.0
Total height (mm)	2.5
Discharging temperature range (°C)	-30 to +85
Weight (g)	2.3

DISCHARGE TEMPERATURE CHARACTERISTICS

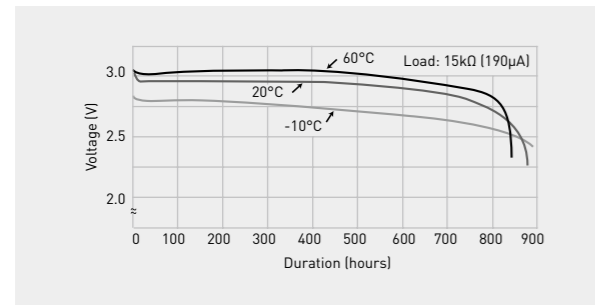

OPERATING VOLTAGE VS. DISCHARGE CURRENT**

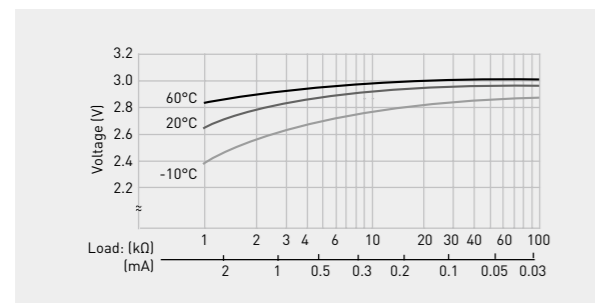

CAPACITY VS. LOAD RESISTANCE

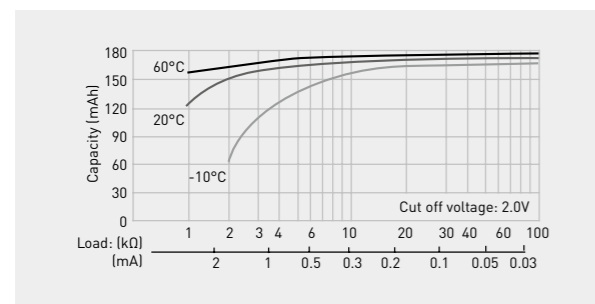

CR-2032

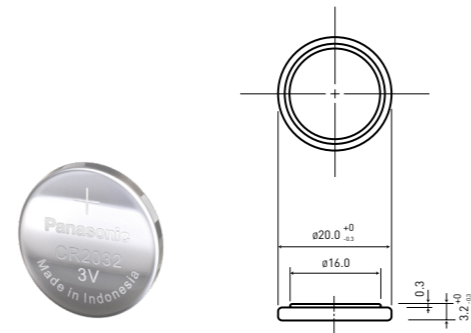

SPECIFICATIONS	CR-2032
Nominal voltage (V)	3
Nominal capacity (mAh)	225
Diameter (mm)	20.0
Total height (mm)	3.2
Discharging temperature range (°C)	-30 to +85
Weight (g)	2.8

DISCHARGE TEMPERATURE CHARACTERISTICS

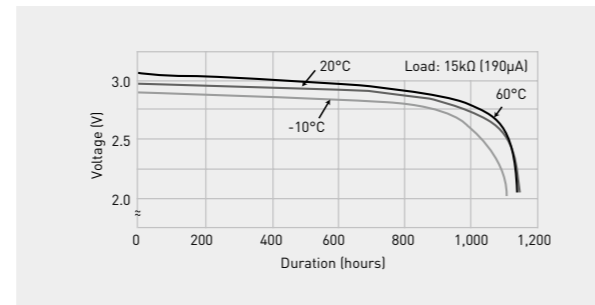

OPERATING VOLTAGE VS. DISCHARGE CURRENT**

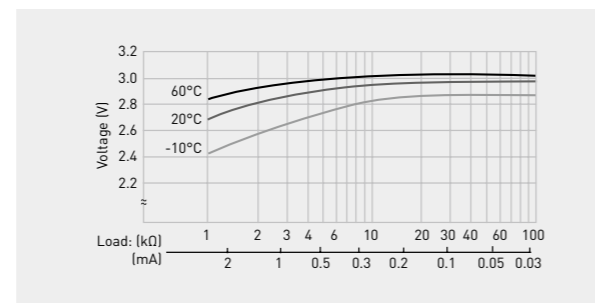

CAPACITY VS. LOAD RESISTANCE

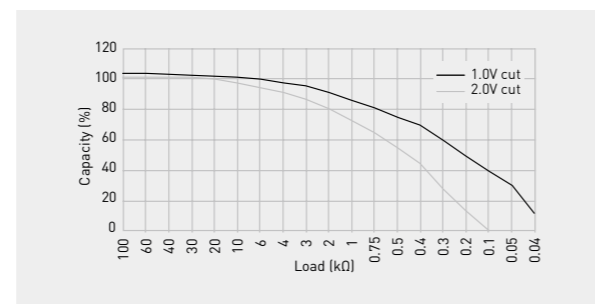

LITHIUM BATTERY HOLDERS FOR BR-2032

These battery holders are designed for sure and easy loading/removal of Panasonic coin type Lithium batteries in/from equipment enabling the batteries to fully exploit their capabilities as the back-up power supply in C-MOS RAM memory and microcomputer memory. All of the battery holders are designed to prevent inverted insertion of the battery.

PRECAUTION FOR WASHING BATTERY HOLDERS

The battery holders can be adversely affected by some detergents use in the circuit board washing process and may result in cracks forming in the holder. Please test the holders in your washing process before use.

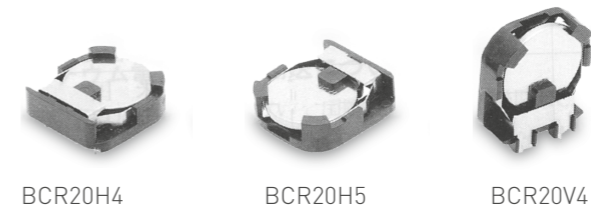

BCR20H4 (3 TERMINALS)

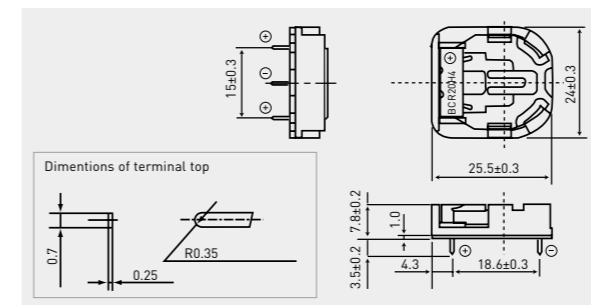

BCR20H5 (2 TERMINALS)

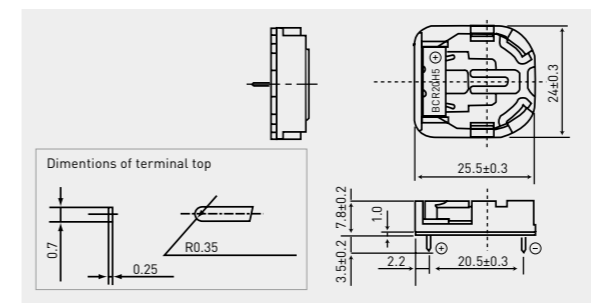

BCR20V4 (3 terminals)

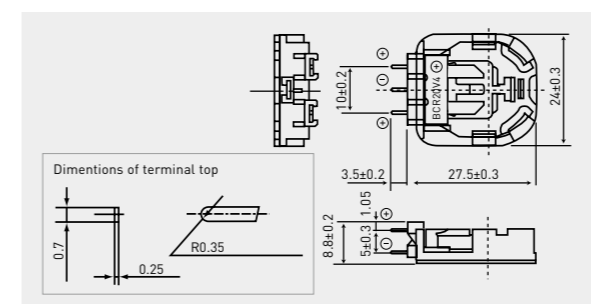

CR-2330

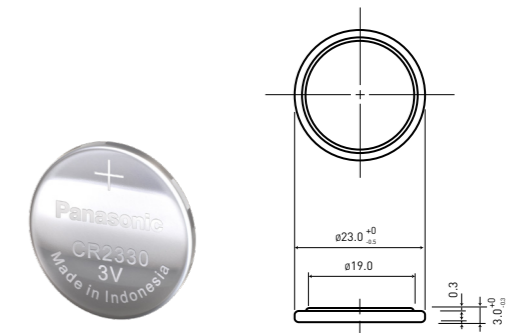

SPECIFICATIONS	CR-2330
Nominal voltage (V)	3
Nominal capacity (mAh)	265
Diameter (mm)	23.0
Total height (mm)	3.0
Discharging temperature range (°C)	-30 to +85
Weight (g)	3.7

DISCHARGE TEMPERATURE CHARACTERISTICS

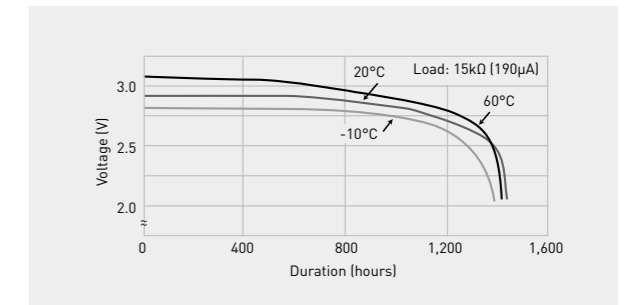

OPERATING VOLTAGE VS. DISCHARGE CURRENT**

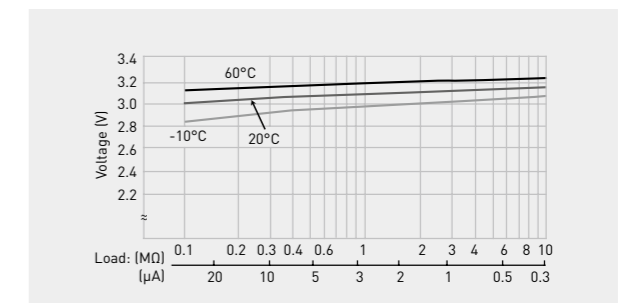

CAPACITY VS. LOAD RESISTANCE

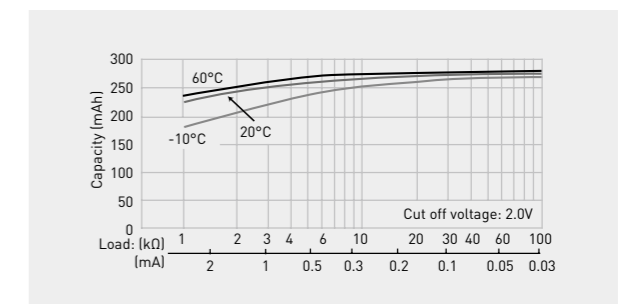

CR-2354

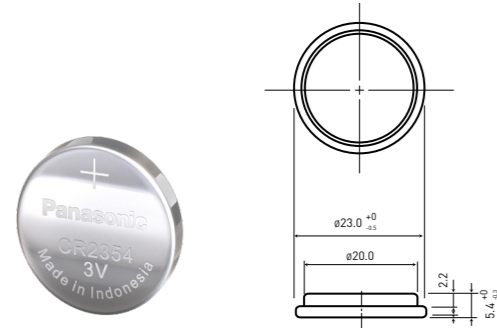

SPECIFICATIONS	CR-2354
Nominal voltage (V)	3
Nominal capacity (mAh)	560
Diameter (mm)	23.0
Total height (mm)	5.4
Discharging temperature range (°C)	-30 to +85
Weight (g)	5.7

DISCHARGE TEMPERATURE CHARACTERISTICS

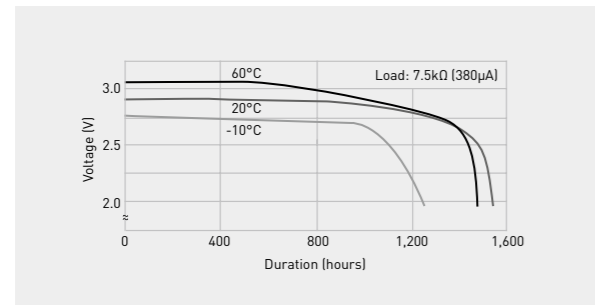

OPERATING VOLTAGE VS. DISCHARGE CURRENT**

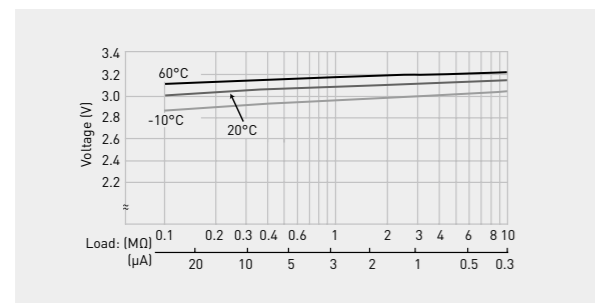

CAPACITY VS. LOAD RESISTANCE

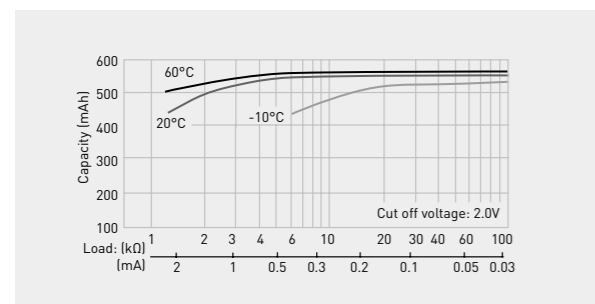

CR-2412

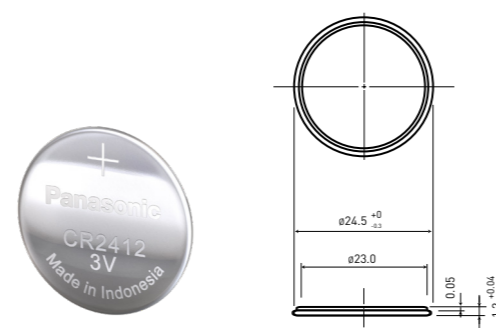

SPECIFICATIONS	CR-2412
Nominal voltage (V)	3
Nominal capacity (mAh)	100
Diameter (mm)	24.5
Total height (mm)	1.2
Discharging temperature range (°C)	-30 to +85
Weight (g)	2.0

DISCHARGE TEMPERATURE CHARACTERISTICS

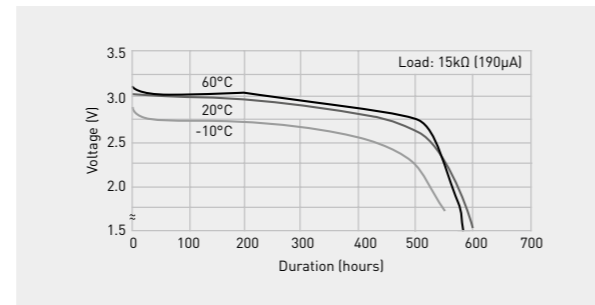

OPERATING VOLTAGE VS. DISCHARGE CURRENT**

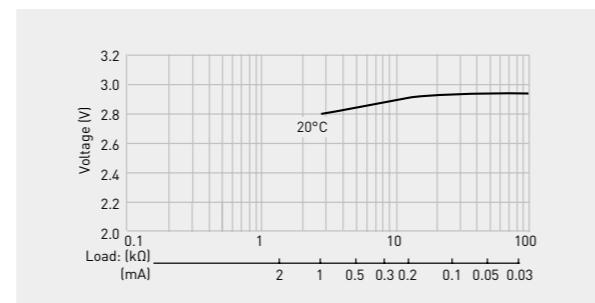

CAPACITY VS. LOAD RESISTANCE

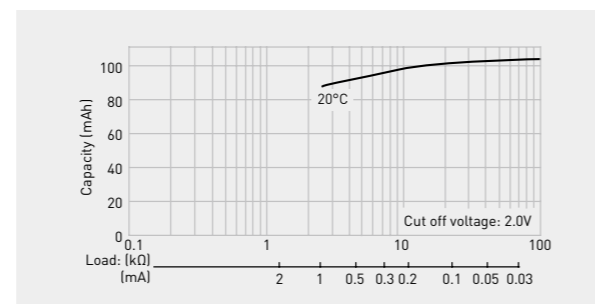

CR-2450

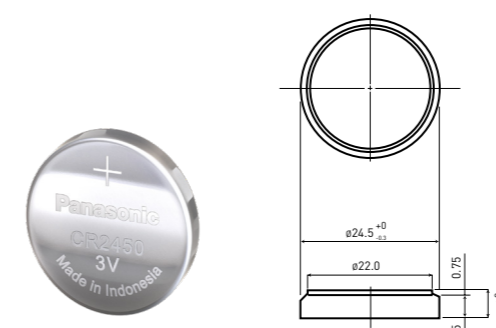

SPECIFICATIONS	CR-2450
Nominal voltage (V)	3
Nominal capacity (mAh)	620
Diameter (mm)	24.5
Total height (mm)	5.0
Discharging temperature range (°C)	-30 to +85
Weight (g)	6.2

DISCHARGE TEMPERATURE CHARACTERISTICS

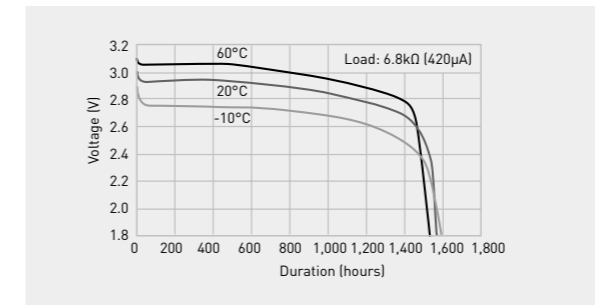

OPERATING VOLTAGE VS. DISCHARGE CURRENT**

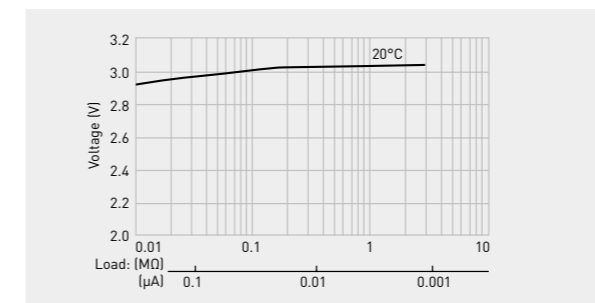

OPERATING VOLTAGE UNDER 30MA/50MS LOAD

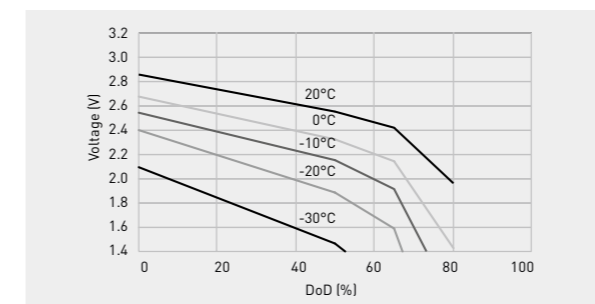

CR-2477

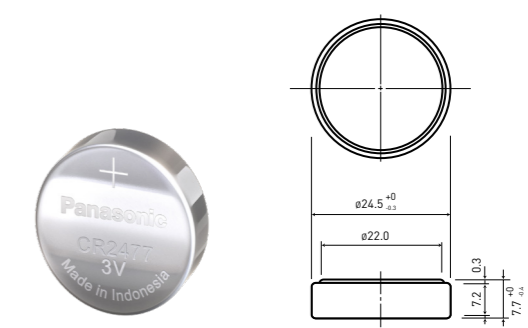

SPECIFICATIONS	CR-2477
Nominal voltage (V)	3
Nominal capacity (mAh)	1,000
Diameter (mm)	24.5
Total height (mm)	7.7
Discharging temperature range (°C)	-30 to +85
Weight (g)	10.5

DISCHARGE TEMPERATURE CHARACTERISTICS

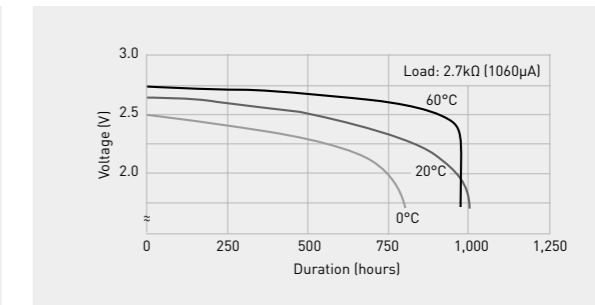

OPERATING VOLTAGE VS. DISCHARGE CURRENT**

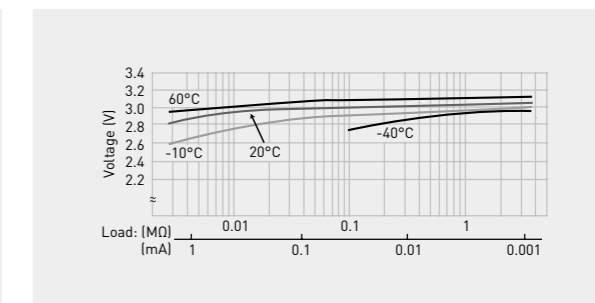

CAPACITY VS. LOAD RESISTANCE

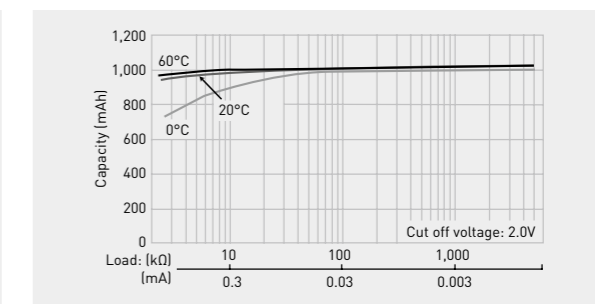

The data in this document are for descriptive purposes only and are not intended to make or imply any guarantee or warranty.

** at 50% depth-of-discharge (DoD)

The data in this document are for descriptive purposes only and are not intended to make or imply any guarantee or warranty.

** at 50% depth-of-discharge (DoD)

CR-3032

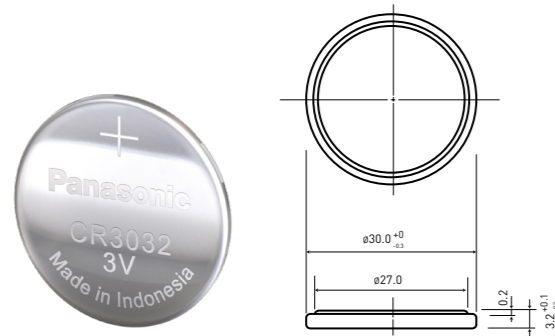

SPECIFICATIONS	CR-3032
Nominal voltage (V)	3
Nominal capacity (mAh)	500
Diameter (mm)	30.0
Total height (mm)	3.2
Discharging temperature range (°C)	-30 to +85
Weight (g)	6.9

DISCHARGE TEMPERATURE CHARACTERISTICS

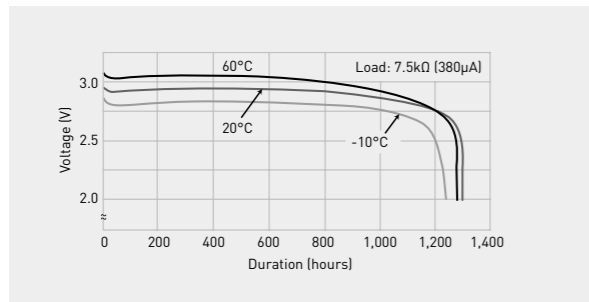

OPERATING VOLTAGE VS. DISCHARGE CURRENT^{*1}

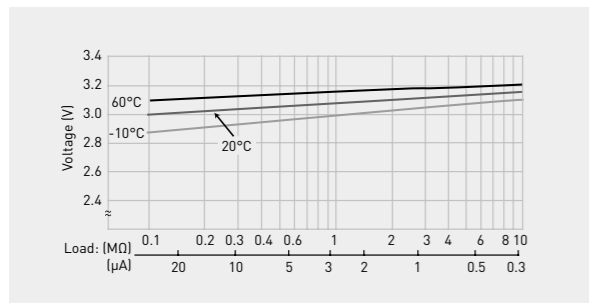

CAPACITY VS. LOAD RESISTANCE

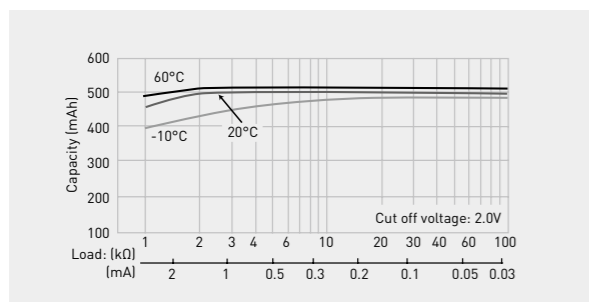

The data in this document are for descriptive purposes only and are not intended to make or imply any guarantee or warranty.
^{*1} at 50% depth-of-discharge (DoD)

HIGH TEMPERATURE MANGANESE DIOXIDE LITHIUM BATTERIES (CR-A/B SERIES) - COIN TYPE (NON-RECHARGEABLE)

Comprising key design elements of the BR-A high temperature series in combination with the benefits of the conventional CR coin series, these batteries offer the best of both worlds in a cost effective manner.

FEATURES

- Excellent durability in high temperatures (up to 125°C^{*1}) allows various usages automotive electrical components and outdoor devices to be used under severe environments
- Superior pulse discharge characteristics even at low temperatures and can be used in a wide operating temperature
- Excellent long-term reliability enables safe and long-term use

APPLICATIONS

- Tire Pressure Monitoring Systems (TPMS)
- Electric Toll Collection (ETC)

MODEL NUMBER ^{*1}	Nominal voltage (V)	Nominal ^{*2} capacity (mAh)	Diameter (mm)	Total height (mm)	Weight (g)	Discharging temperature (°C)
CR-2032A ^{*3}	3	210	20.0	3.2	3.0	-40 to +125
CR-2032B ^{*3}	3	210	20.0	3.2	3.0	-40 to +120
CR-2050A ^{*3}	3	345	20.0	5.0	4.1	-40 to +125
CR-2050B2 ^{*3}	3	345	20.0	5.0	4.1	-40 to +120
CR-2450B ^{*3}	3	560	24.5	5.0	6.2	-40 to +105

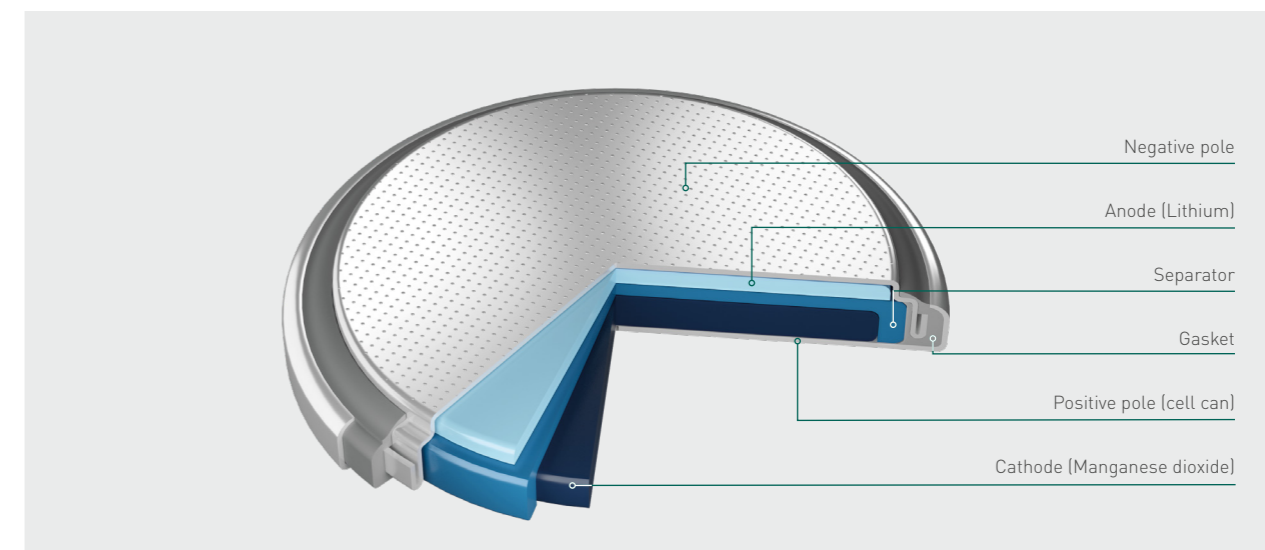

BATTERY INSIDE^{*3}

The data in this document are for descriptive purposes only and are not intended to make or imply any guarantee or warranty.

^{*1} Max. operating temperature +120°C for „B” and +125°C for „A” type models (dia 20mm), +105°C for CR-2450B.

^{*2} Based on standard drain and cut off voltage down to 2.0V at 20°C.

^{*3} Cells are supplied with tabs or lead-wires only. For available configurations please consult the Panasonic homepage or your sales contact.

^{*4} The illustration shows only one example of lithium battery structure.

CR-2032A

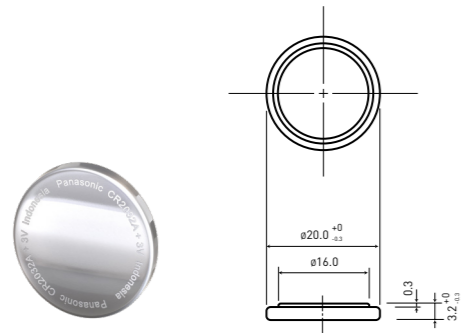

SPECIFICATIONS	CR-2032A
Nominal voltage (V)	3
Nominal capacity (mAh)	210
Diameter (mm)	20.0
Total height (mm)	3.2
Discharging temperature range (°C)	-40 to +125
Weight (g)	3.0

CONTINUOUS DISCHARGING CHARACTERISTICS

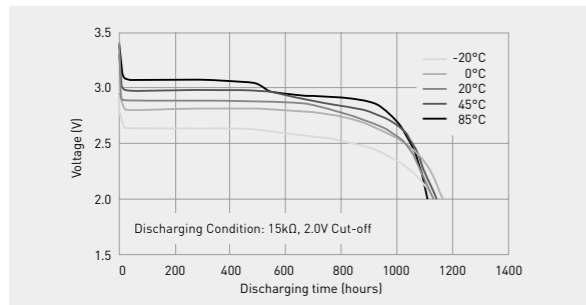

CAPACITY VS. LOAD RESISTANCE

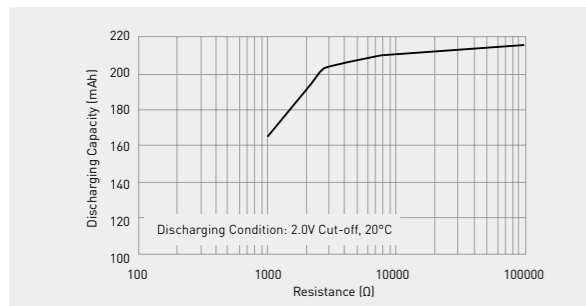

CR-2032B

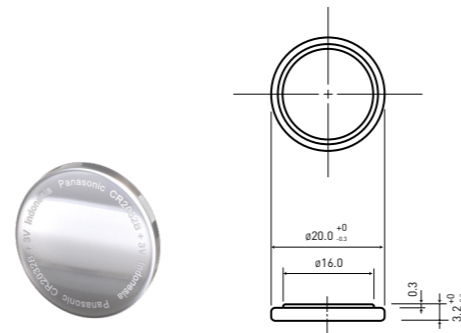

SPECIFICATIONS	CR-2032B
Nominal voltage (V)	3
Nominal capacity (mAh)	210
Diameter (mm)	20.0
Total height (mm)	3.2
Discharging temperature range (°C)	-40 to +120
Weight (g)	3.0

CONTINUOUS DISCHARGING CHARACTERISTICS

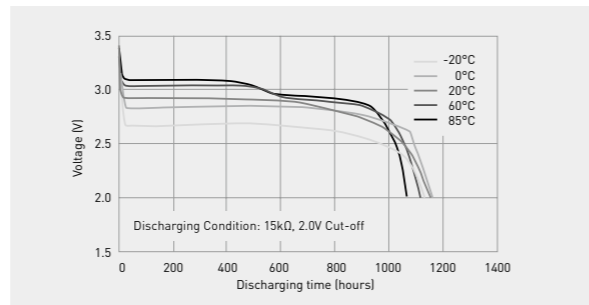

CAPACITY VS. LOAD RESISTANCE

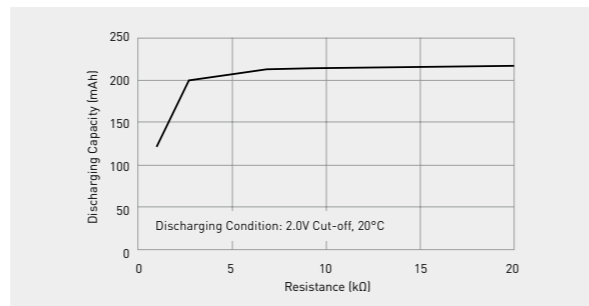

CR-2050A

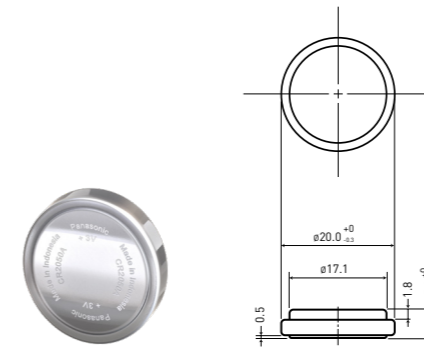

SPECIFICATIONS	CR-2050A
Nominal voltage (V)	3
Nominal capacity (mAh)	345
Diameter (mm)	20.0
Total height (mm)	5.0
Discharging temperature range (°C)	-40 to +125
Weight (g)	4.1

CONTINUOUS DISCHARGING CHARACTERISTICS

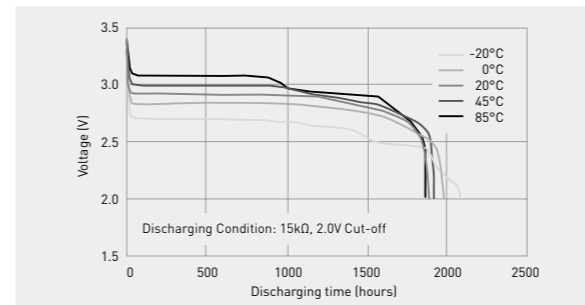

CAPACITY VS. LOAD RESISTANCE

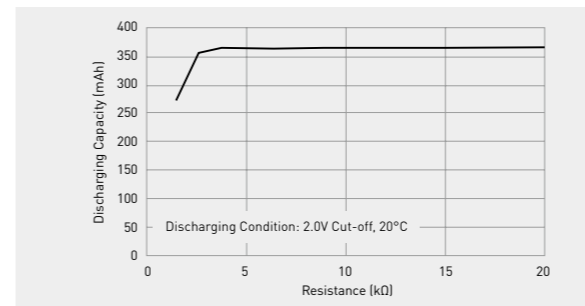

CR-2050B2

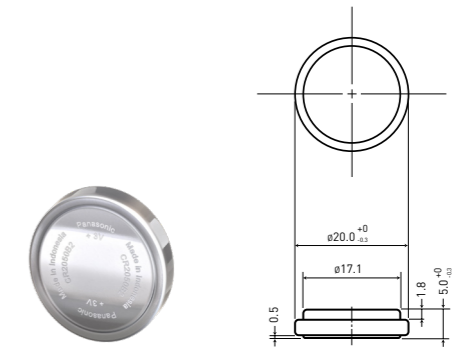

SPECIFICATIONS	CR-2050B2
Nominal voltage (V)	3
Nominal capacity (mAh)	345
Diameter (mm)	20.0
Total height (mm)	5.0
Discharging temperature range (°C)	-40 to +120
Weight (g)	4.1

CONTINUOUS DISCHARGING CHARACTERISTICS

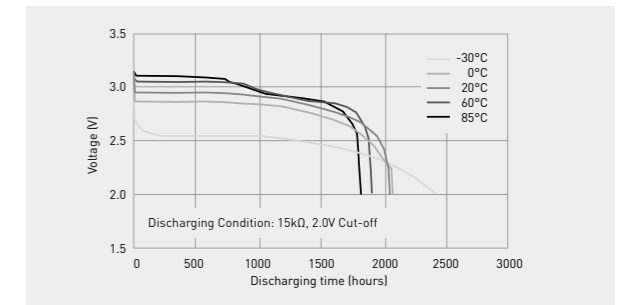

CAPACITY VS. LOAD RESISTANCE

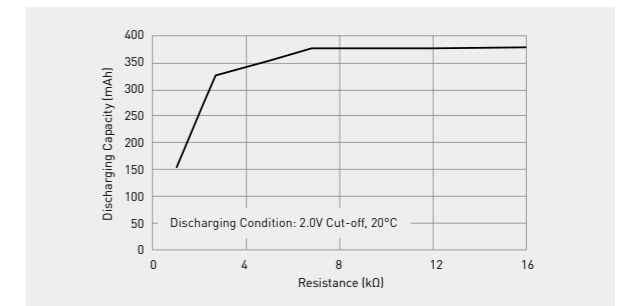

CR-2450B

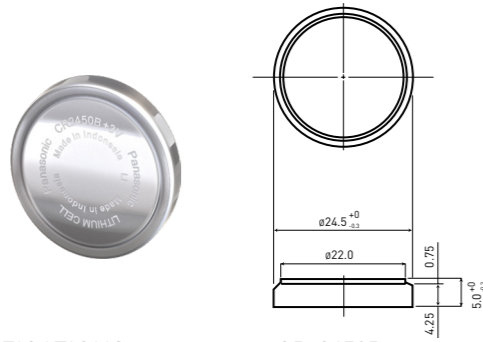

SPECIFICATIONS

CR-2450B	
Nominal voltage (V)	3
Nominal capacity (mAh)	560
Diameter (mm)	24.5
Total height (mm)	5.0
Discharging temperature range (°C)	-40 to +105
Weight (g)	6.2

DISCHARGING CHARACTERISTICS

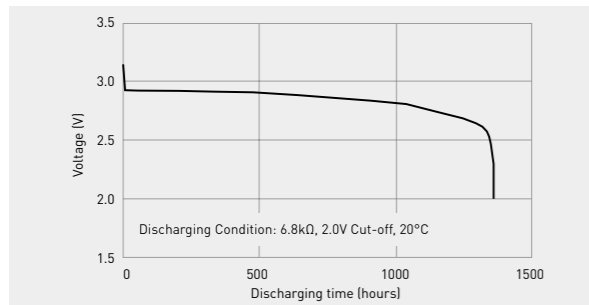

CAPACITY VS. LOAD RESISTANCE

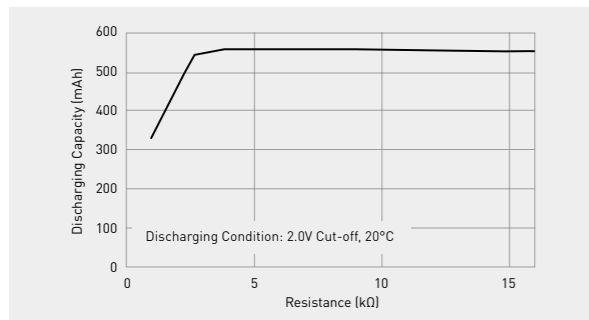

POLY-CARBONMONOFLUORIDE LITHIUM BATTERIES (BR SERIES) – PIN TYPE (NON-RECHARGEABLE)

Panasonic offers a unique pin shape and space-saving design to meet the requirements of small-scale applications.

FEATURES

- Superior design for high temperature applications -30°C ~ +80°C
- Outstanding long-term reliability
- Over 43 years of experience in production
- Self-discharge rate at 20°C is just 0.5% per year

APPLICATIONS

- LED-type night fishing floats
- Various illumination products
- Fishing pole tip lights
- Toys, etc.

MODEL NUMBER	Nominal voltage (V)	Nominal ¹ capacity (mAh)	Diameter (mm)	Total height (mm)	Weight (g)
BR-425	3	24	4.2	25.9	0.6
BR-435	3	50	4.2	35.9	0.9

BATTERY INSIDE*²

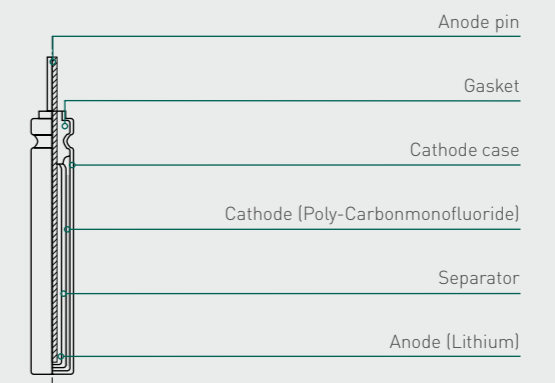

The data in this document are for descriptive purposes only and are not intended to make or imply any guarantee or warranty.

¹ Based on standard drain and cut off voltage down to 2.0V at 20°C.

² The illustration shows only one example of Lithium battery structure.

BR-425

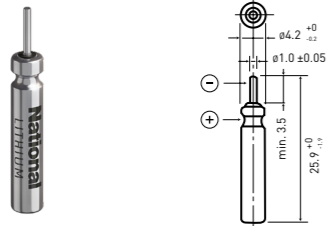

SPECIFICATIONS	BR-425
Nominal voltage (V)	3
Nominal capacity (mAh)	25
Diameter (mm)	4.2
Total height (mm)	25.9
Discharging temperature range (°C)	-30 to +80
Weight (g)	0.6

DISCHARGE TEMPERATURE CHARACTERISTICS

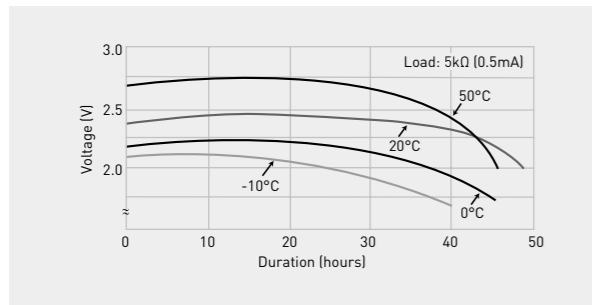

OPERATING VOLTAGE VS. DISCHARGE CURRENT**

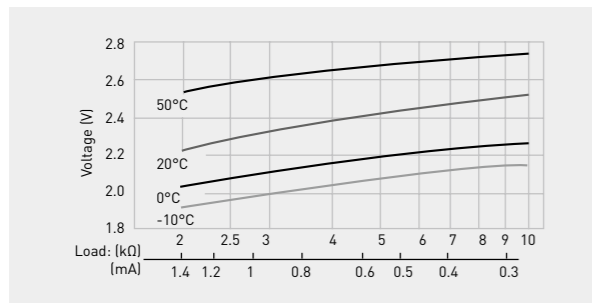

CAPACITY VS. LOAD RESISTANCE

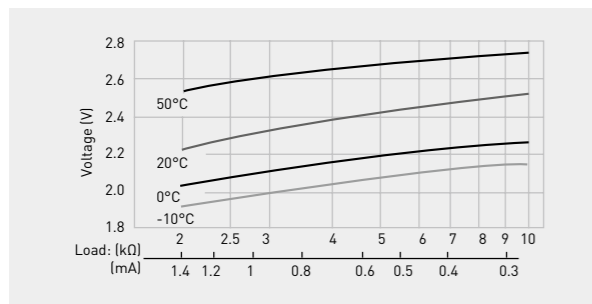

BR-435

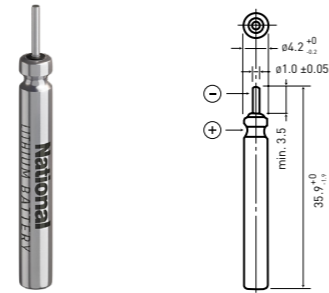

SPECIFICATIONS	BR-435
Nominal voltage (V)	3
Nominal capacity (mAh)	50
Diameter (mm)	4.2
Total height (mm)	35.9
Discharging temperature range (°C)	-30 to +80
Weight (g)	0.9

DISCHARGE TEMPERATURE CHARACTERISTICS

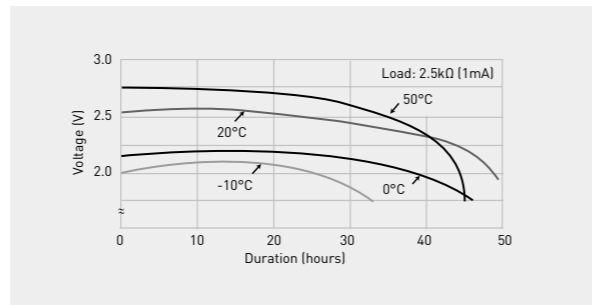

OPERATING VOLTAGE VS. DISCHARGE CURRENT**

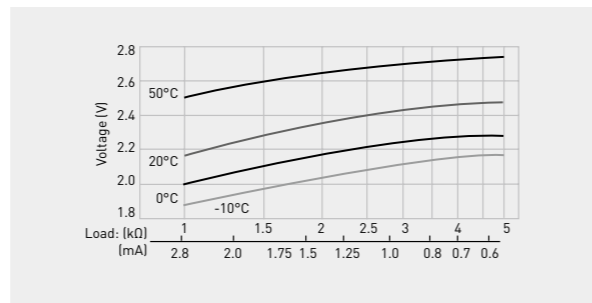

CAPACITY VS. LOAD RESISTANCE

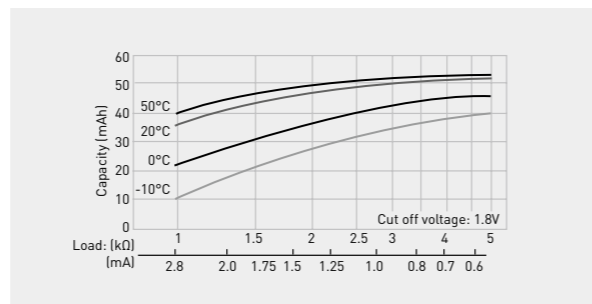

SECONDARY LITHIUM BATTERIES

RECHARGEABLE COIN & PIN TYPE BATTERIES WITH REMARKABLE CHARACTERISTICS

- Low self-discharge
- Decades of mass production experience
- Superior designed battery ranges
- Proven reliability

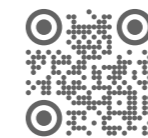

YOUR INFORMATION

Visit our product page and get detailed information about Lithium batteries.

VANADIUM RECHARGEABLE LITHIUM BATTERIES (VL SERIES) – COIN TYPE

(RECHARGEABLE)

These high quality lithium coin batteries feature vanadium oxide for the positive pole, lithium alloy for the negative pole and non-aqueous solvent for the electrolyte.

FEATURES

- Rechargeable Lithium technology
- Self-discharge rate at 20°C is only 2.0% per year for VL and ML battery types
- 1,000 charge-discharge cycles for VL and ML at 10% depth of discharge
- Superior long-term reliability
- Years of experience in production

APPLICATIONS

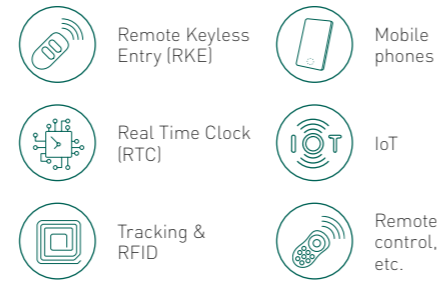

MODEL NUMBER	Nominal voltage [V]	Nominal ¹⁾ capacity [mAh]	Diameter (mm)	Total height (mm)	Weight (g)	Discharging temperature (°C)
VL-1220 ²⁾	3	7	12.5	2.0	0.8	-20 to +60
VL-2020 ²⁾	3	20	20.0	2.0	2.1	-20 to +60
VL-2330 ²⁾	3	50	23.0	3.0	3.5	-20 to +60
VL-3032 ²⁾	3	100	30.0	3.2	6.3	-20 to +60

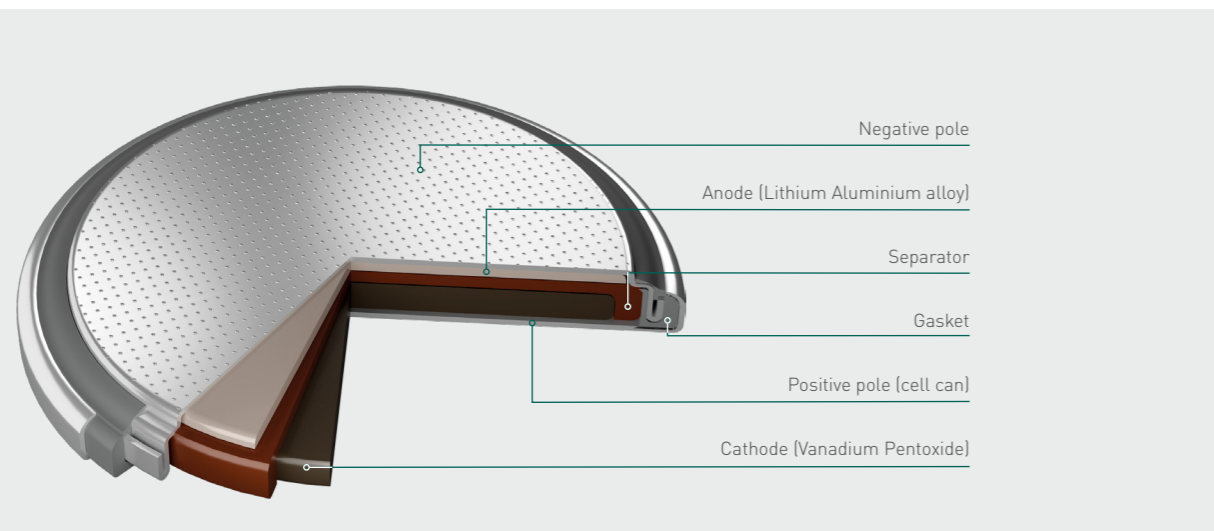

BATTERY INSIDE^{*3}

The data in this document are for descriptive purposes only and are not intended to make or imply any guarantee or warranty.

^{*1} Based on standard drain and cut off voltage down to 2.0V at 20°C. State-of-Charge ex-factory: ~70%

^{*2} Cells are supplied with tabs or lead-wires only. For available configurations please consult the Panasonic homepage or your sales contact.

^{*3} The illustration shows only one example of Lithium battery structure.

VANADIUM RECHARGEABLE LITHIUM BATTERIES (VL SERIES)

CHARGING

CHARGING CIRCUITS

The charging circuit is crucial in terms of ensuring that full justice will be done to the battery characteristics. Consider it carefully as the wrong charging circuit can cause trouble.

CHARGING / DISCHARGING CYCLE	Approx. 1,000 times at 10% discharge depth to nominal capacity
CHARGING SYSTEM ^{*1}	Constant-voltage charging. (Please strictly adhere to the specified charge voltage)
OPERATING TEMPERATURE	-20°C to +60°C

PRECAUTIONS REGARDING THE CHARGE VOLTAGE SETTING

Under no circumstances should constant current charging, which is used for Nickel-Cadmium batteries, be used. Ignoring this precaution will cause the battery voltage to rise to about 5V, resulting in a deterioration of performance.

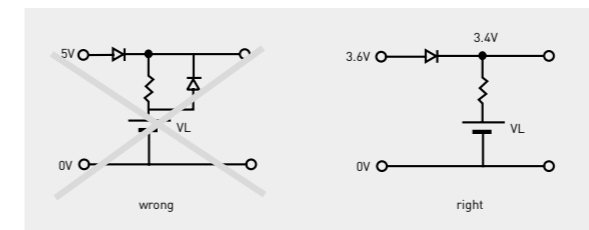

CHARGE VOLTAGE RANGE

If a fixed-charging method is applied, please adhere to the specified charging voltage. The guaranteed value over an operating temperature range from -20°C to +60°C is 3.4V ± 0.15V. (Actual value: 3.4V ± 0.20V)

- If the charging voltage exceeds the specifications, the internal resistance of the battery will rise and may cause battery deterioration. Also, with a charge voltage around 4V, corrosion of the ⊕ terminal (case) may occur, causing leakage.

- It is not possible for the battery capacity to recover completely when the charging voltage is below the specification.

RECOMMENDED CHARGING CIRCUITS

- basic conditions

Fixed-voltage charge

Charge voltage: 3.4V ± 0.15V

Charge current: For a battery voltage of 3V

VL-621	Approx. 0.2mA or below
VL-1220	Approx. 0.5mA or below
VL-2020	Approx. 1.5mA or below
VL-2330	Approx. 2.0mA or below
VL-3032	Approx. 4.0mA or below

(It is permissible for the current to increase beyond the above level when the battery voltage drops below 3V.)

MIXED USAGE OF BATTERIES

Do not use these batteries and lithium primary batteries or other rechargeable batteries together, and do not use new batteries and old batteries together even if they are of the same type.

INFLUENCE OF THE CHARGE VOLTAGE ON VL BATTERIES

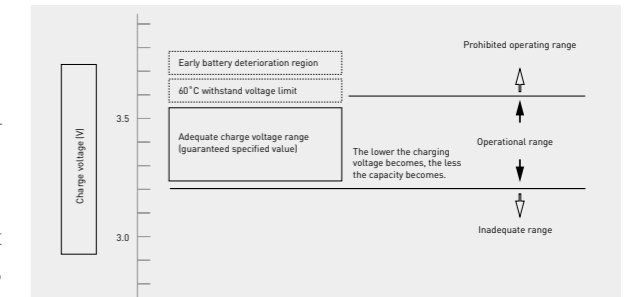

If the charge voltage goes beyond its adequate range, battery performance may deteriorate early. Be sure to observe the guaranteed charge voltage.

VL CYCLE LIFE

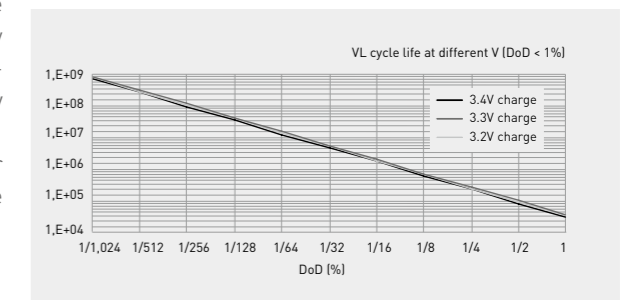
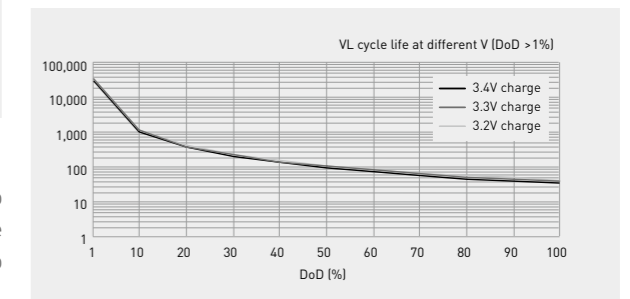

VL CHARGING

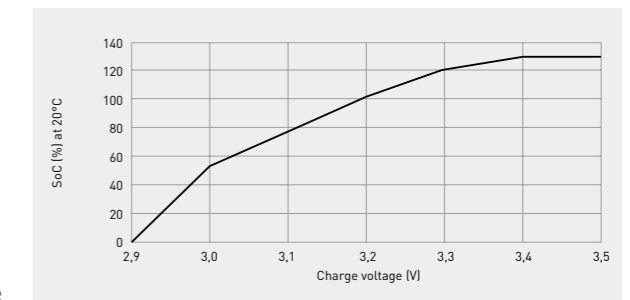

The data in this document are for descriptive purposes only and are not intended to make or imply any guarantee or warranty.

REFERENCE: EXAMPLES OF CHARGING CIRCUITS

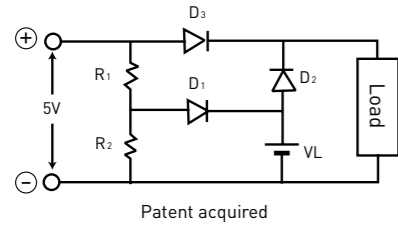

STANDARD CIRCUITS

D₂: select a diode of small inverse current (I_R=1μA below/5V)
 D₁, D₂: MA3X716 (Diode type code)
 D₃: MA3X704, MA2J728

	R ₁	R ₂	Charge current (max.)
VL-621	2.2kΩ	5.6kΩ	0.2mA
VL-1220	750Ω	1.8kΩ	0.5mA
VL-2020	200Ω	510Ω	1.5mA
VL-2330	150Ω	390Ω	2.0mA
VL-3032	68Ω	180Ω	4.0mA

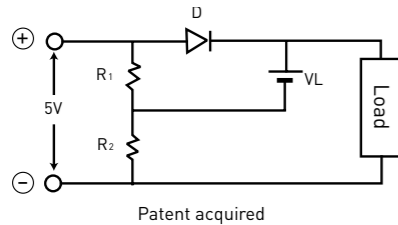

SIMPLE ECONOMICAL CIRCUITS

D: MA2J728 (Very small reverse current)

Load with 5V applied 1mA below
 D, Vf 0-0.30V

	R ₁	R ₂
VL-621	6.2kΩ	2.4kΩ
VL-1220	1.5kΩ	560Ω
VL-2020	470Ω	180Ω
VL-2330	390Ω	150Ω
VL-3032	180Ω	68Ω

Vf of D will be different from the value given above if a current in excess of 1mA flows to the load during operation. Compensation must be provided by the resistors in such cases.

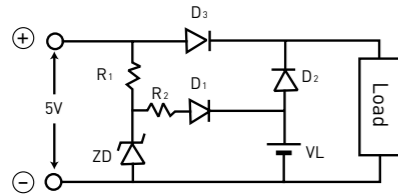

	ZD	D ₁	R ₁	
A	MAZ30360L	MA3X704	300Ω	Common to all types
B	MAZ30360H	MA2J728	270Ω	

Type	VL-3032	VL-2330	VL-2020	VL-1220	VL-621
R ₂ A	Not required			470Ω	1.5kΩ
R ₂ B	Not required			560Ω	1.6kΩ

D₂: select a diode of small inverse current (I_R=1μA below/5V)

FOR MINIMIZING CURRENT LEAKAGE DUE TO RESISTANCE, ETC., AS WHEN CHARGING BY ANOTHER BATTERY.

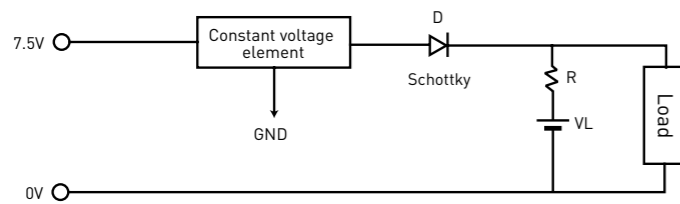

REG	D
3.7V	MA2J728

For details, refer to the constant voltage element specifications.

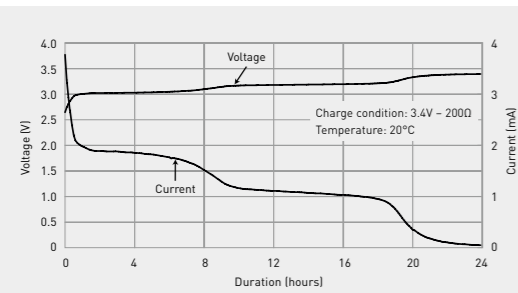

VL 2020 CHARGING CURVE

VL-1220

VL-2020

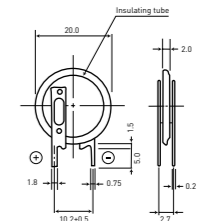
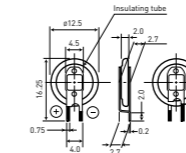

SPECIFICATIONS

	VL-1220
Nominal voltage (V)	3
Nominal capacity (mAh)	7.0
Diameter (mm)	12.5
Total height (mm)	2.0
Discharging temperature range (°C)	-20 to +60
Weight (g)	0.8

SPECIFICATIONS

	VL-2020
Nominal voltage (V)	3
Nominal capacity (mAh)	20.0
Diameter (mm)	20.0
Total height (mm)	2.0
Discharging temperature range (°C)	-20 to +60
Weight (g)	2.1

DISCHARGE TEMPERATURE CHARACTERISTICS

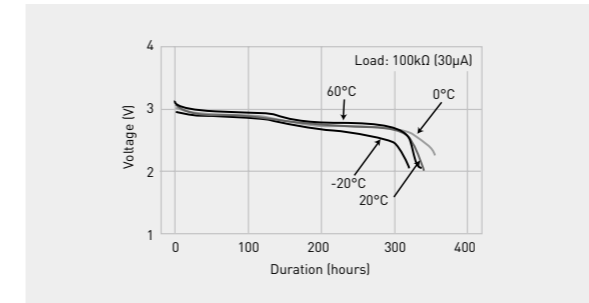

DISCHARGE TEMPERATURE CHARACTERISTICS

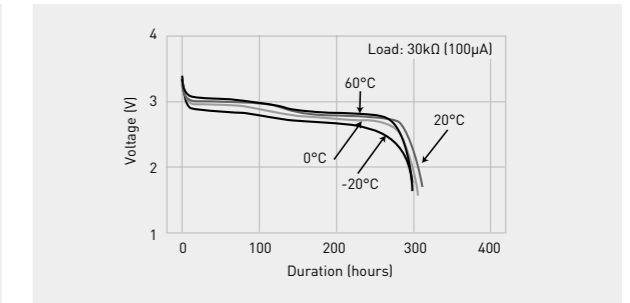

CONSUMPTION CURRENT VS. DURATION TIME

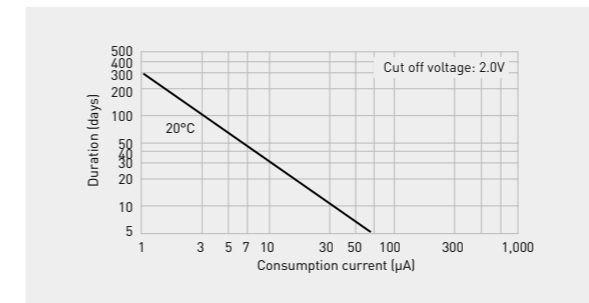

CONSUMPTION CURRENT VS. DURATION TIME

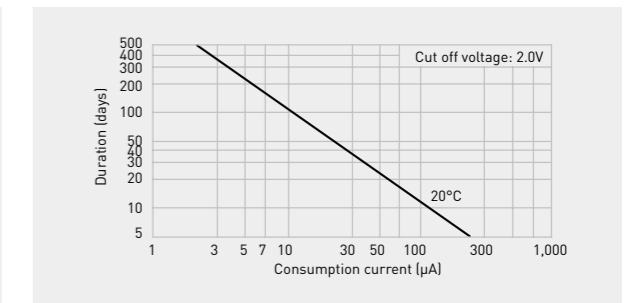

VL-2330

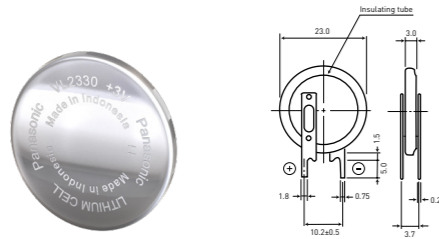

SPECIFICATIONS	VL-2330
Nominal voltage (V)	3
Nominal capacity (mAh)	50.0
Diameter (mm)	23.0
Total height (mm)	3.0
Discharging temperature range (°C)	-20 to +60
Weight (g)	3.5

DISCHARGE TEMPERATURE CHARACTERISTICS

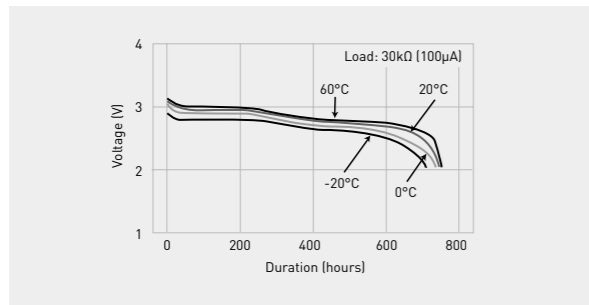

CONSUMPTION CURRENT VS. DURATION TIME

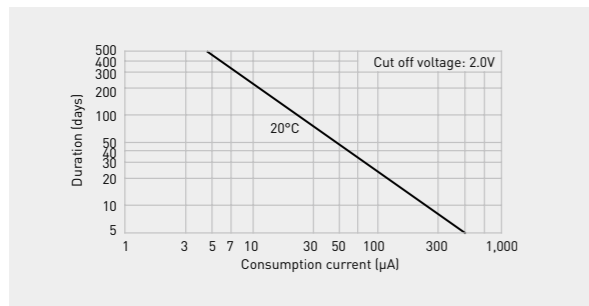

VL-3032

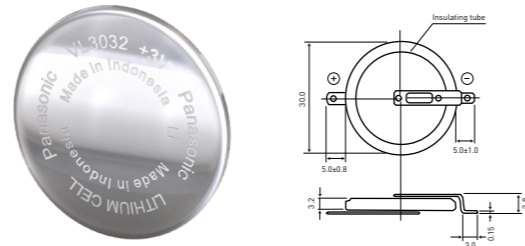

SPECIFICATIONS	VL-3032
Nominal voltage (V)	3
Nominal capacity (mAh)	100.0
Diameter (mm)	30.0
Total height (mm)	3.2
Discharging temperature range (°C)	-20 to +60
Weight (g)	6.3

DISCHARGE TEMPERATURE CHARACTERISTICS

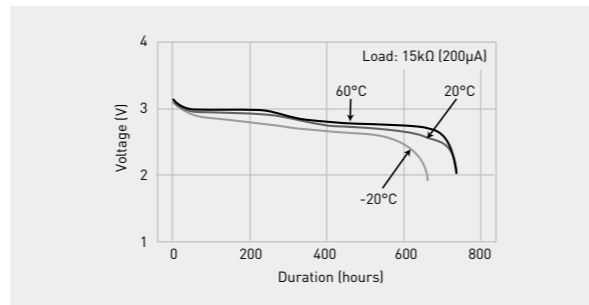

CONSUMPTION CURRENT VS. DURATION TIME

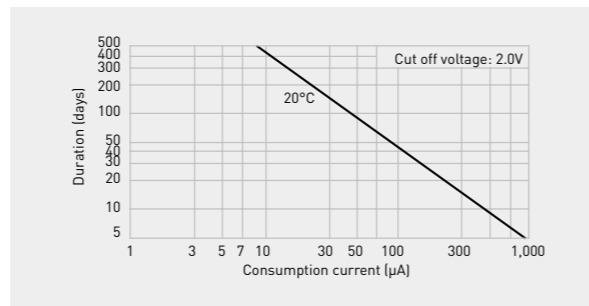

MANGANESE RECHARGEABLE LITHIUM BATTERIES (ML SERIES) – COIN TYPE

(RECHARGEABLE)

These super compact rechargeable lithium batteries feature a manganese compound oxide for the positive electrode, a lithium/aluminum alloy for the negative electrode and a special non-aqueous solvent for the electrolyte. They can easily be incorporated into circuits where 3V ICs are used to save space.

FEATURES

- Rechargeable Lithium technology
- Self discharge rate at 20°C is only 2.0% per year
- 1,000 charge-discharge cycles at 10% depth of discharge (DoD)
- Superior long-term reliability
- Over 23 years of experience in production

APPLICATIONS

- Real Time Clock (RTC)
- Tracking & RFID
- Memory back-up power supplies for mobile phones
- Pagers and other compact communications equipment, etc.

MODEL NUMBER	Nominal voltage (V)	Nominal*1 capacity (mAh)	Diameter (mm)	Total height (mm)	Weight (g)	Discharging temperature (°C)
ML-2020 	3	45	20.0	2.0	2.2	-20 to +60

The data in this document are for descriptive purposes only and are not intended to make or imply any guarantee or warranty.
 *1 Based on standard drain and cut off voltage down to 2.0V at 20°C. State-of-Charge ex-factory: ~70%

CHARGING

CHARGING CIRCUITS

The charging circuit is crucial in terms of ensuring that full justice will be done to the battery characteristics. Consider it carefully as the wrong charging circuit can cause trouble.

CHARGING / DISCHARGING CYCLE	Approx. 1,000 times at 10% discharge depth to nominal capacity
CHARGING SYSTEM*1	Constant-voltage charging. [Please strictly adhere to the specified charge voltage]
OPERATING TEMPERATURE	-20°C to +60°C

PRECAUTIONS REGARDING THE CHARGE VOLTAGE SETTING

Under no circumstances should constant current charging, which is used for Nickel-Cadmium batteries, be used. Ignoring this precaution will cause the battery voltage to rise to about 5V, resulting in a deterioration of performance.

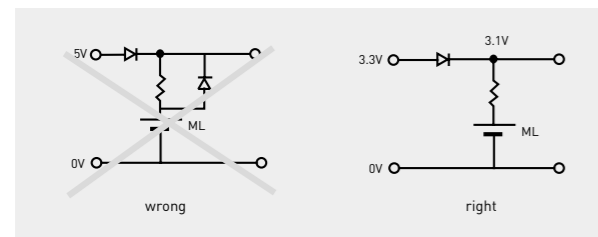

CHARGE VOLTAGE RANGE

If a fixed-charging method is applied, please adhere to the specified charging voltage. Guaranteed voltage is 2.8V to 3.2V at the temperature of -20°C to +60°C.

- If the charging voltage exceeds the specifications, the internal resistance of the battery will rise and may cause battery deterioration. Also, with a charge voltage around 4V, corrosion of the ⊕ terminal (case) may occur, causing leakage.
- It is not possible for the battery capacity to recover completely when the charging voltage is below the specification.

RECOMMENDED CHARGING CIRCUITS

- basic conditions

Fixed-voltage charge

Charge voltage: 2.8 to 3.2V (Standard voltage: 3.1V)
 Charge current: For a battery voltage of 2.5V
 ML-2020 Approx. 3.0mA or below

MIXED USAGE OF BATTERIES

Do not use these batteries and lithium primary batteries or other rechargeable batteries together, and do not use new batteries and old batteries together even if they are of the same type.

INFLUENCE OF THE CHARGE VOLTAGE ON ML BATTERIES

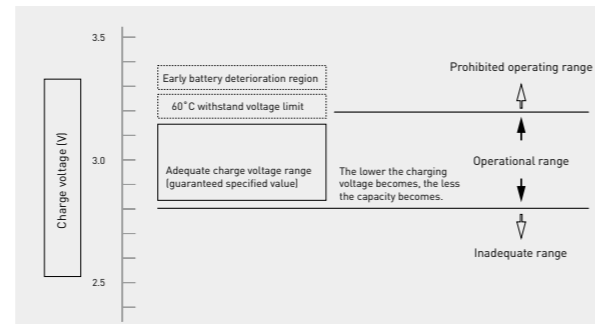

If the charge voltage goes beyond its adequate range, battery performance may deteriorate early. Be sure to observe the guaranteed charge voltage.

ML CYCLE LIFE

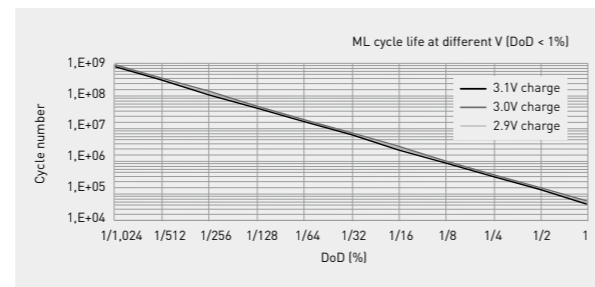
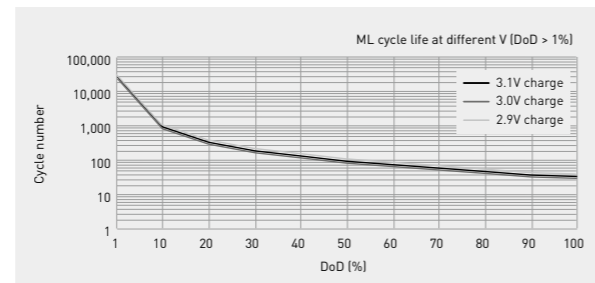

ML CHARGING

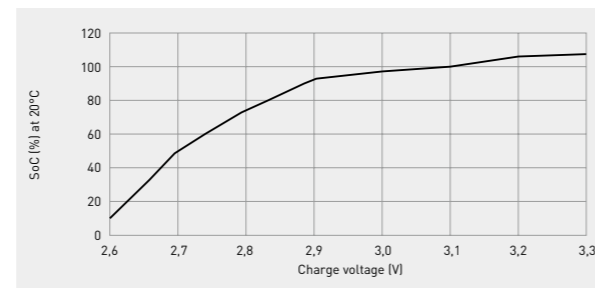

REFERENCE: EXAMPLES OF CHARGING CIRCUITS

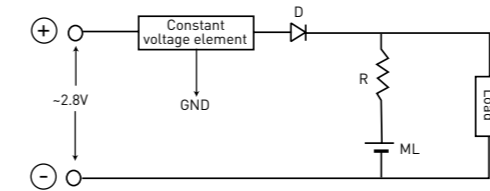

WHEN CHARGING USING ANOTHER BATTERY		
ML-2020 REG	D	R
3.2V	MA2J728	180Ω
3.1V	MA2J728	150Ω

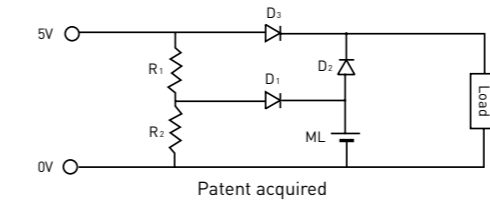

STANDARD CIRCUITS		
For D ₃ , select a diode of small inverse current (I _r =1μA/5V)		
D ₁ , D ₂ : MA3X716 [Diode type code]		
D ₃ : MA3X704, MA2J728		
ML-2020	R ₁	R ₂
	180Ω	330Ω

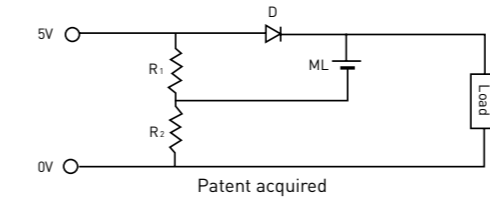

Simple economical circuits		
Load	100μA below	
D, Vf	0-0.2V	
	R ₁	R ₂
ML-2020	330Ω	180Ω

Vf of D will be different from the value given above if a current in excess of 10μA flows to the load during operation. Compensation must be provided by the resistors in such cases.

ML-2020

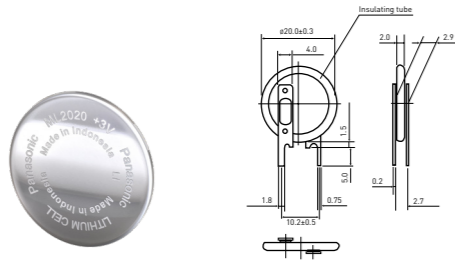

SPECIFICATIONS	ML-2020
Nominal voltage (V)	3
Nominal capacity (mAh)	45.0
Diameter (mm)	20.0
Total height (mm)	2.0
Discharging temperature range (°C)	-20 to +60
Weight (g)	2.2

DISCHARGE TEMPERATURE CHARACTERISTICS

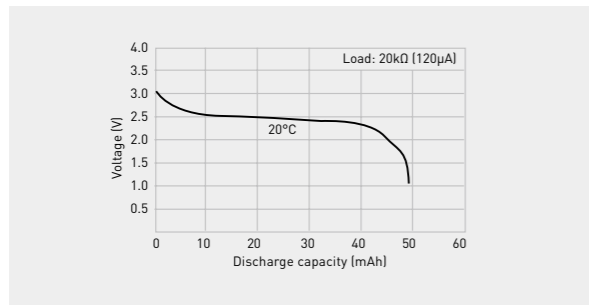

CHARGE VOLTAGE VS. DISCHARGE CAPACITY

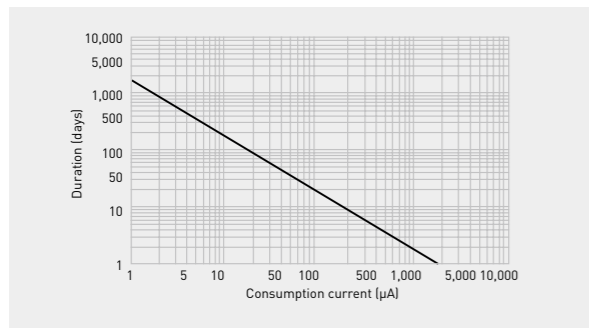

COBALT TITANIUM RECHARGEABLE LITHIUM BATTERIES (CTL SERIES) – COIN TYPE

(RECHARGEABLE)

These cobalt titanium rechargeable lithium batteries have excellent cycle characteristics. Compared to MT series, CTL series can keep higher voltage (2.3V). CTL series have long term reliability, that is why many solar watches use CTL series.

APPLICATIONS

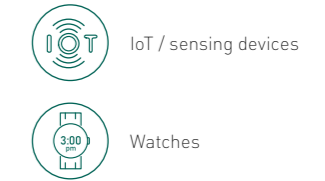

FEATURES

- Excellent charging and discharging cycle characteristics
- Can keep higher voltage (2.3 V) compared to MT series
- Long term reliability that many solar watches prove

MODEL NUMBER		Nominal voltage (V)	Nominal*1 capacity (mAh)	Diameter (mm)	Total height (mm)	Weight (g)	Discharging temperature (°C)
CTL-621F		2.3	3.6	6.8	2.1	0.25	-20 to +60
CTL-920F		2.3	7.7	9.5	2.0	0.45	-20 to +60
CTL-1616F		2.3	13	16	1.6	1.00	-20 to +60

CHARGING

CHARGING CIRCUITS

The charging circuit is crucial in terms of ensuring that full justice will be done to the battery characteristics. Consider it carefully as the wrong charging circuit can cause trouble. Maintain the base conditions as below. Otherwise, battery quality may be damaged.

- Base conditions: Constant Voltage Charging
 Charge voltage: 2.5V to 2.7V
 Charge current: (CTL621F) Max. 0.63mA (at 2.5V of battery voltage)
 (CTL920F) Max. 1.0mA (at 2.5V of battery voltage)
 (CTL1616F) Max. 2.0mA (at 2.5V of battery voltage)

If you have any questions, please contact Panasonic.

Examples

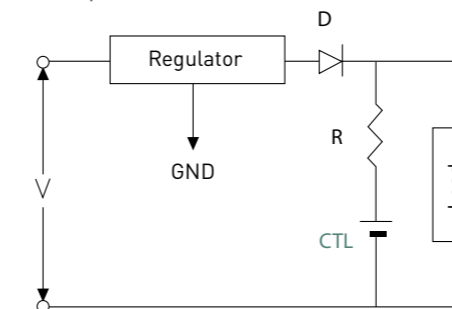

MODEL NUMBER	Regulator (V)	D (Diode)	R (Ω)
CTL-621F	2.7	RB751VM-40	160
	2.8	RB751VM-40	320
CTL-920F	2.7	RB751VM-40	100
	2.8	RB751VM-40	200
CTL-1616F	2.7	RB751VM-40	51
	2.8	RB751VM-40	100

The data in this document are for descriptive purposes only and are not intended to make or imply any guarantee or warranty.
 *1 Based on standard drain and cut off voltage down to 2.0V at 20°C. State-of-Charge ex-factory: ~70%

CTL-621F

CTL-920F

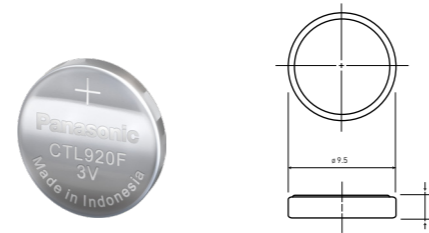
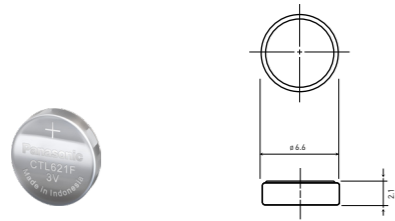

SPECIFICATIONS	CTL-621F
Nominal voltage (V)	2.3
Nominal capacity (mAh)	3.6
Diameter (mm)	6.8
Total height (mm)	1.2
Discharging temperature range (°C)	-20 to +60
Weight (g)	0.25

SPECIFICATIONS	CTL-920F
Nominal voltage (V)	2.3
Nominal capacity (mAh)	7.7
Diameter (mm)	9.5
Total height (mm)	2.0
Discharging temperature range (°C)	-20 to +60
Weight (g)	0.45

DISCHARGE CHARACTERISTICS

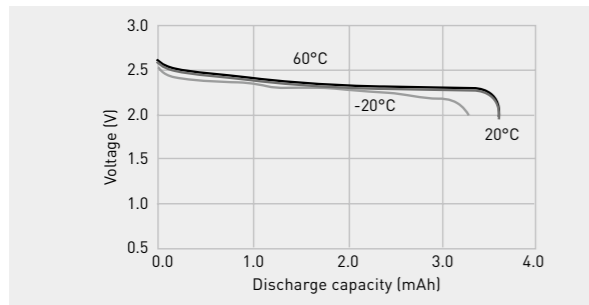

DISCHARGE CHARACTERISTICS

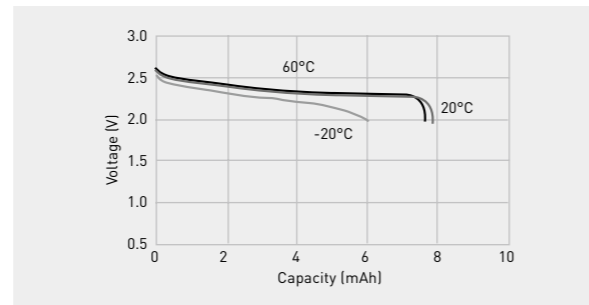

CYCLE LIFE CHARACTERISTICS

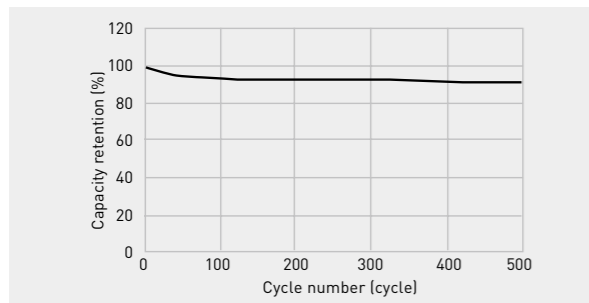

CYCLE LIFE CHARACTERISTICS

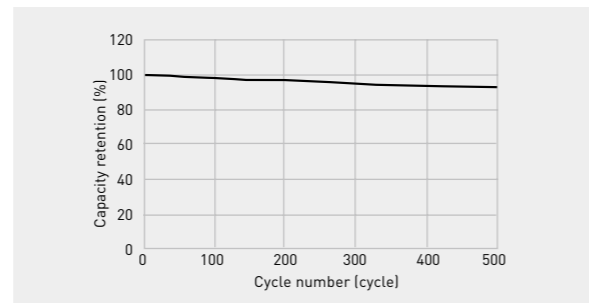

CONTINUOUS CHARGING CHARACTERISTICS (60°C)

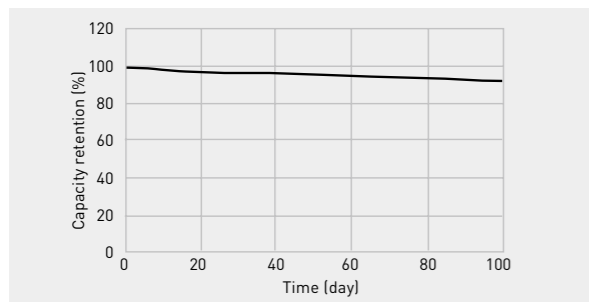

CONTINUOUS CHARGING CHARACTERISTICS (60°C)

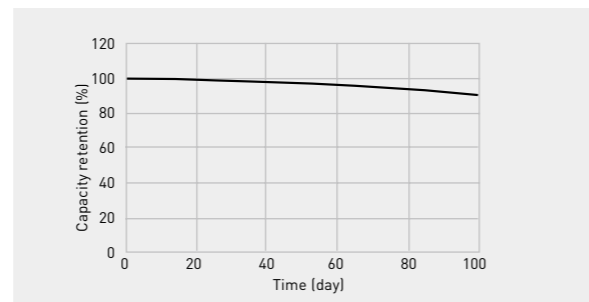

CTL-1616F



SPECIFICATIONS	CTL-1616F
Nominal voltage (V)	2.3
Nominal capacity (mAh)	13.0
Diameter (mm)	16.0
Total height (mm)	1.7
Discharging temperature range (°C)	-20 to +60
Weight (g)	1.0

DISCHARGE CHARACTERISTICS

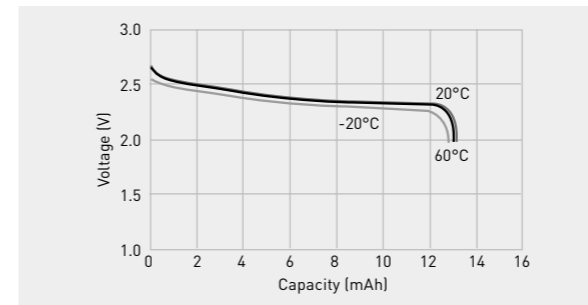

CYCLE LIFE CHARACTERISTICS

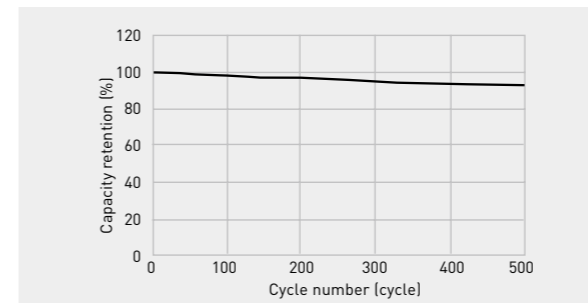

CONTINUOUS CHARGING CHARACTERISTICS (60°C)

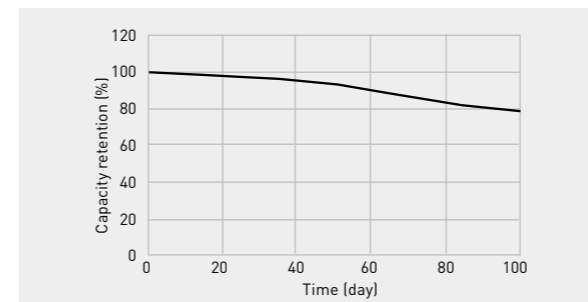

TITANIUM RECHARGEABLE LITHIUM BATTERIES (MT SERIES) – COIN TYPE

(RECHARGEABLE)

These coin type manganese titanium rechargeable lithium coin batteries use a lithium-manganese complex oxide for the positive pole and a special lithium-titanium complex oxide for the negative pole. They provide a capacity which is more than 10 times that of capacitors of the same size.

FEATURES

- Rechargeable lithium technology
- Superior long-term reliability
- Over 25 years of experience in production
- 500 charge-discharge cycles up to 1V or discharge limit voltage (at 100% depth of discharge (DoD))

APPLICATIONS



Main power supplies in compact products such as rechargeable watches



Memory back-up power supply for pagers, timers, etc.

MODEL NUMBER		Nominal voltage (V)	Nominal ^{*1} capacity (mAh)	Diameter (mm)	Total height (mm)	Weight (g)	Discharging temperature (°C)
MT-516		1.5	1.8	5.8	1.6	0.1	-10 to +60
MT-621		1.5	2.5	6.8	2.1	0.2	-10 to +60
MT-920		1.5	5	9.5	2.0	0.4	-10 to +60

TITANIUM RECHARGEABLE LITHIUM BATTERIES (MT SERIES)

CHARGING

CHARGING CIRCUITS

The charging circuit is crucial in terms of ensuring that full justice will be done to the battery characteristics. Consider it carefully as the wrong charging circuit can cause trouble.

CHARGING / DISCHARGING CYCLE	Approx. 500 times at 100% discharge depth to nominal capacity
CHARGING SYSTEM*1	Constant-voltage charging. (Please strictly adhere to the specified charge voltage)
OPERATING TEMPERATURE	-10°C to +60°C

PRECAUTIONS REGARDING THE CHARGE VOLTAGE SETTING

Under no circumstances should constant current charging, which is used for Nickel-Cadmium batteries, be used. Ignoring this precaution will cause the battery voltage to rise to about 5V, resulting in a deterioration of performance.

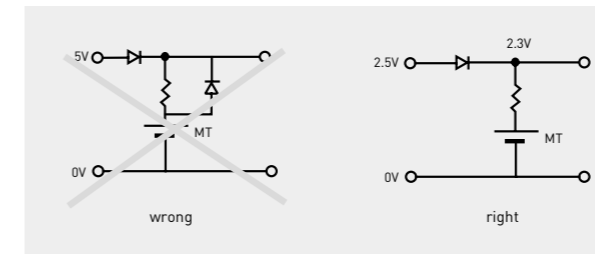

CHARGE VOLTAGE RANGE

If a fixed-charging method is applied, please adhere to the specified charging voltage. Guaranteed voltage is 1.8V to 2.6V at the temperature of -10°C to +60°C.

- If the charging voltage exceeds the specifications, the internal resistance of the battery will rise and may cause battery deterioration. Also, with a charge voltage around 3V, corrosion of the ⊕ terminal (case) may occur, causing leakage.
- It is not possible for the battery capacity to recover completely when the charging voltage is below the specification.

RECOMMENDED CHARGING CIRCUITS

- basic conditions

Fixed-voltage charge

Charge voltage: 1.8 to 2.6V [Standard voltage: 2.2V]

Charge current: For a battery voltage of 2.3V

MT-516 Approx. 0.36mA or below

MT-621 Approx. 0.33mA or below

MT-920 Approx. 1.0mA or below

MIXED USAGE OF BATTERIES

Do not use these batteries and lithium primary batteries or other rechargeable batteries together, and do not use new batteries and old batteries together even if they are of the same type.

INFLUENCE OF THE CHARGE VOLTAGE ON MT BATTERIES

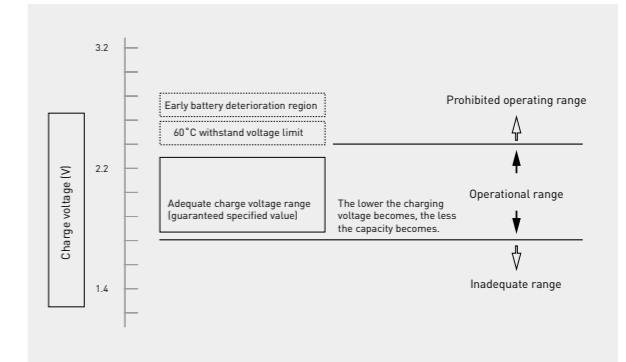

If the charge voltage goes beyond its adequate range, battery performance may deteriorate early. Be sure to observe the guaranteed charge voltage.

MT-516

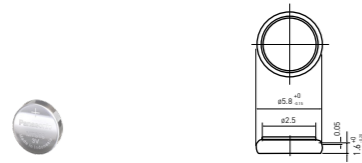

SPECIFICATIONS	MT-516
Nominal voltage (V)	1.5
Nominal capacity (mAh)	1.8
Diameter (mm)	5.8
Total height (mm)	1.6
Discharging temperature range (°C)	-10 to +60
Weight (g)	0.1

DISCHARGE CHARACTERISTICS

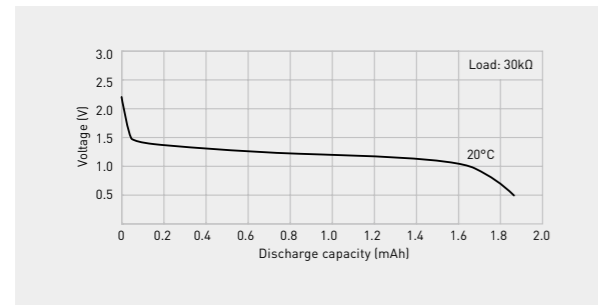

CONSUMPTION CURRENT VS. DURATION TIME

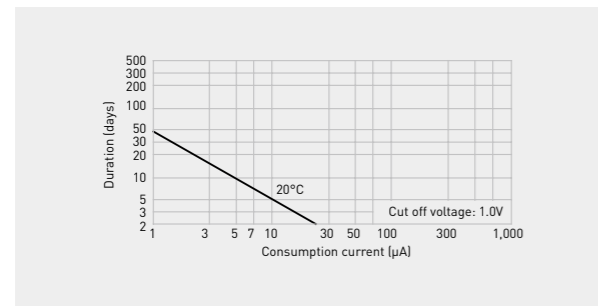

MT-621

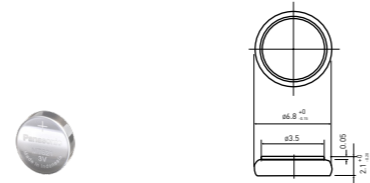

SPECIFICATIONS	MT-621
Nominal voltage (V)	1.5
Nominal capacity (mAh)	2.5
Diameter (mm)	6.8
Total height (mm)	2.1
Discharging temperature range (°C)	-10 to +60
Weight (g)	0.2

DISCHARGE CHARACTERISTICS

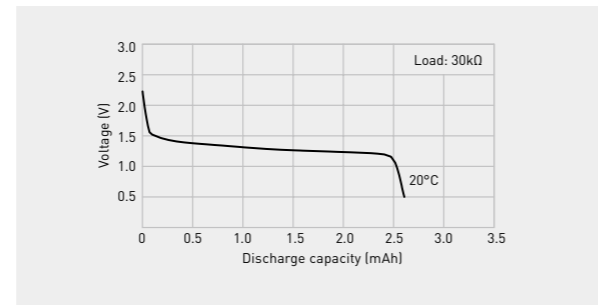

CONSUMPTION CURRENT VS. DURATION TIME

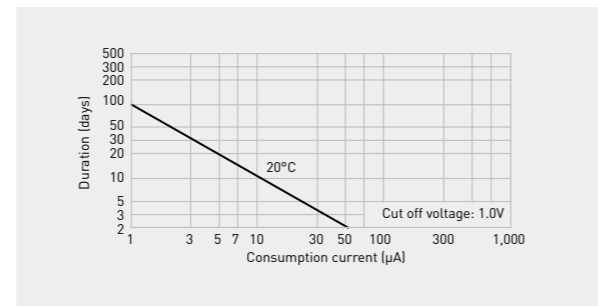

MT-920

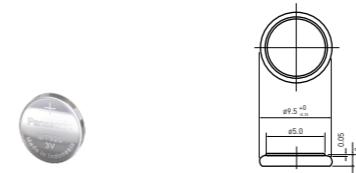

SPECIFICATIONS	MT-920
Nominal voltage (V)	1.5
Nominal capacity (mAh)	5.0
Diameter (mm)	9.5
Total height (mm)	2.0
Discharging temperature range (°C)	-10 to +60
Weight (g)	0.4

DISCHARGE CHARACTERISTICS

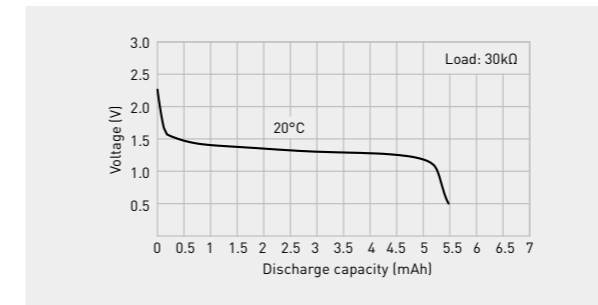

CONSUMPTION CURRENT VS. DURATION TIME

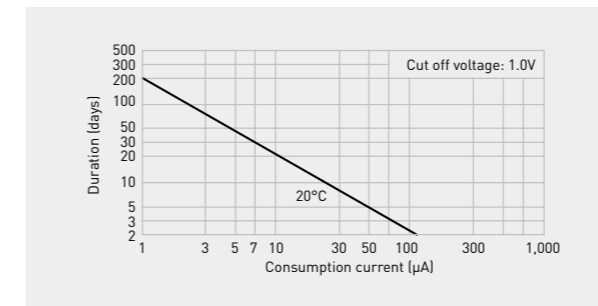

DISCHARGE TEMPERATURE CHARACTERISTICS

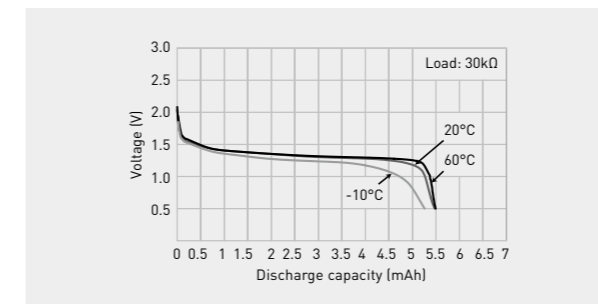

LITHIUM-ION RECHARGEABLE BATTERIES (CG-SERIES) - PIN TYPE

(RECHARGEABLE)

The industry's smallest-diameter cylindrical rechargeable battery has been developed using extremely fine components and materials compared to standard Lithium-ion batteries. Its outstanding technical design makes this battery ideal for wearable devices with heavy power demands. Panasonic intends to expand this new battery line-up successively to meet the requirements of next-generation mobile communication devices.

APPLICATIONS



FEATURES

- Extremely small diameter pin-shaped Lithium-ion battery which expands design options for micro devices
- Rechargeable battery that can be used repeatedly and has the output capability required for near field communications
- High-strength metal exterior provides excellent reliability and robustness

MODEL NUMBER	Technology	Nominal voltage (V)	Typical*1 capacity (mAh)	Diameter (mm)	Total height (mm)	Weight (g)
CG-320B*2	Co system	3.8	16	3.65	20	0.5
CG-420A*2	Co system	3.8	23	4.7	20	0.8
CG-420B*2	Co system	3.8	29	4.7	20	0.9
CG-425A*2	Co system	3.8	32	4.7	25	1.0

BATTERY INSIDE*3

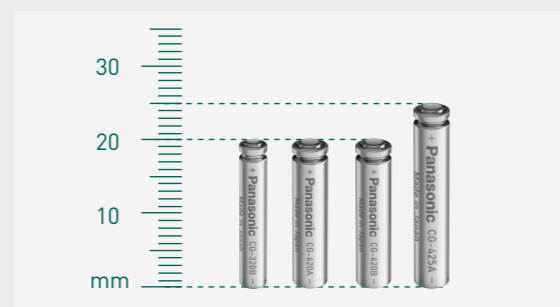
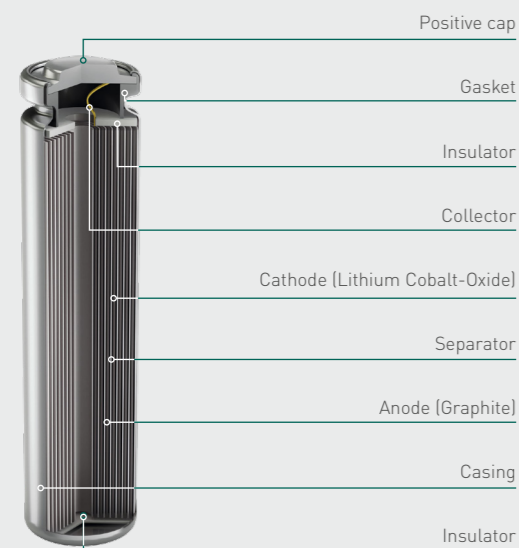

The data in this document are for descriptive purposes only and are not intended to make or imply any guarantee or warranty.
 *1 4.35V charge
 *2 This battery is supplied with tabs.
 *3 The illustration shows only one example of a Lithium-Ion Pin Type battery structure.

CG-320B

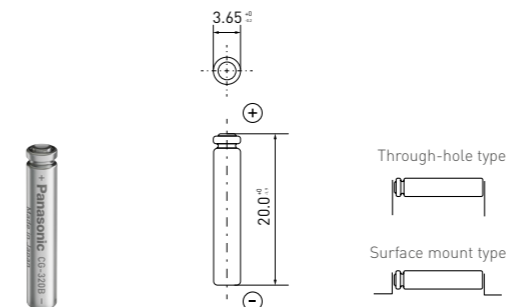

SPECIFICATIONS	CG-320B
Nominal voltage (V)	3.8
Nominal capacity (mAh)	16.0
Diameter (mm)	3.65
Total height (mm)	20.0
Discharging temperature range (°C)	-20 to +60
Charging temperature range (°C)	0 to +60
Weight (g)	0.5

CHARGE AND DISCHARGE CHARACTERISTICS

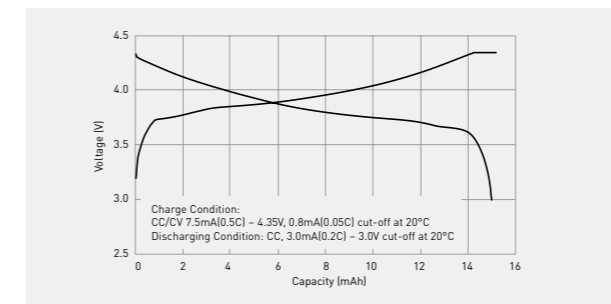

CYCLE LIFE CHARACTERISTICS

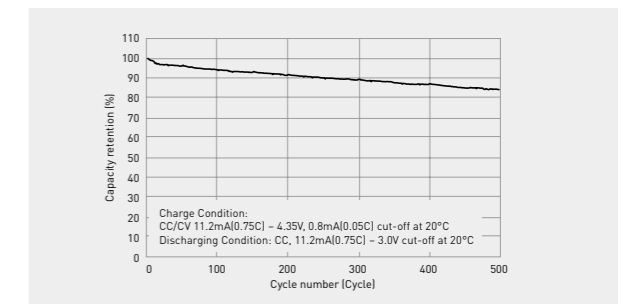

DISCHARGE CHARACTERISTICS BY TEMPERATURE

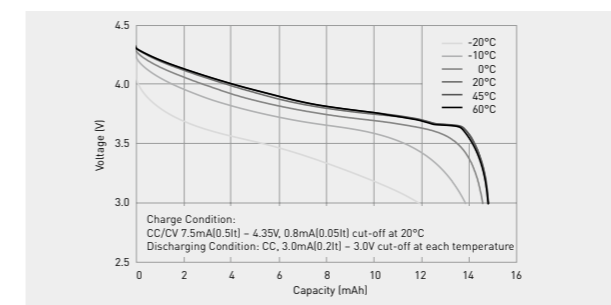

DISCHARGE CHARACTERISTICS BY RATE OF DISCHARGE

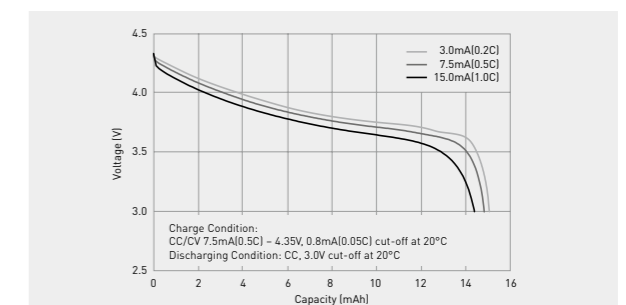

PULSE DISCHARGING CHARACTERISTICS

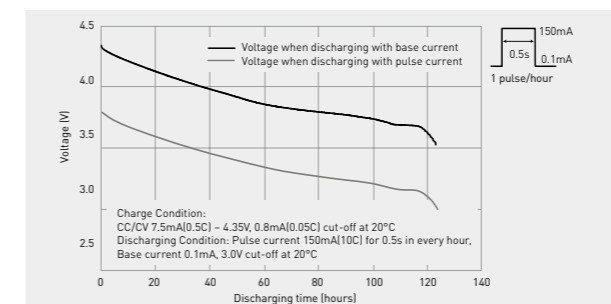

The data in this document are for descriptive purposes only and are not intended to make or imply any guarantee or warranty.

CG-420A

CG-420B

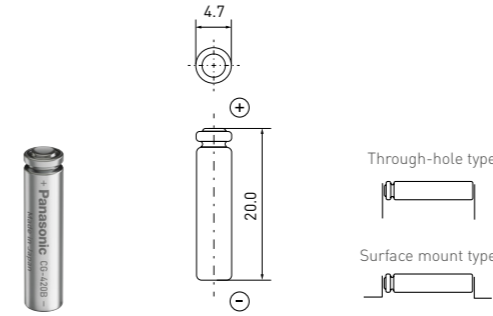
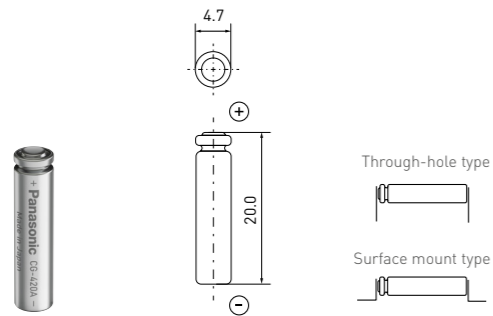

SPECIFICATIONS	CG-420A
Nominal voltage [V]	3.8
Nominal capacity [mAh]	23.0
Diameter [mm]	4.7
Total height [mm]	20.0
Discharging temperature range [°C]	-20 to +60
Charging temperature range [°C]	0 to +60
Weight [g]	0.8

SPECIFICATIONS	CG-420B
Nominal voltage [V]	3.8
Nominal capacity [mAh]	29.0
Diameter [mm]	4.7
Total height [mm]	20.0
Discharging temperature range [°C]	-20 to +60
Charging temperature range [°C]	0 to +60
Weight [g]	0.9

CHARGE AND DISCHARGE CHARACTERISTICS

CYCLE LIFE CHARACTERISTICS

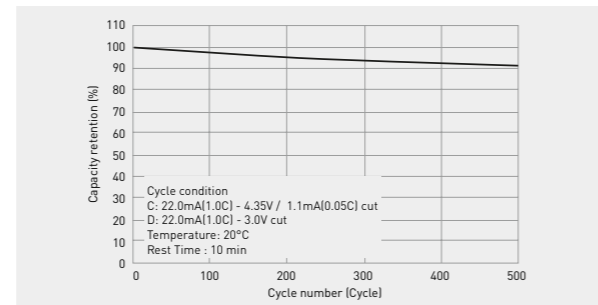
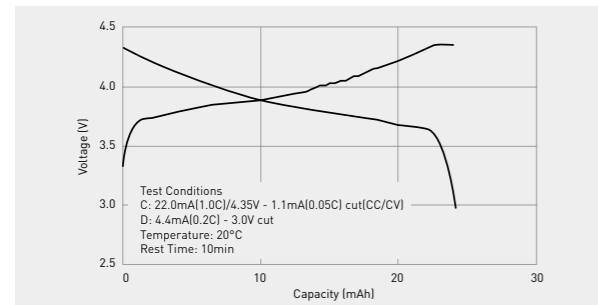

CHARGE AND DISCHARGE CHARACTERISTICS

CYCLE LIFE CHARACTERISTICS

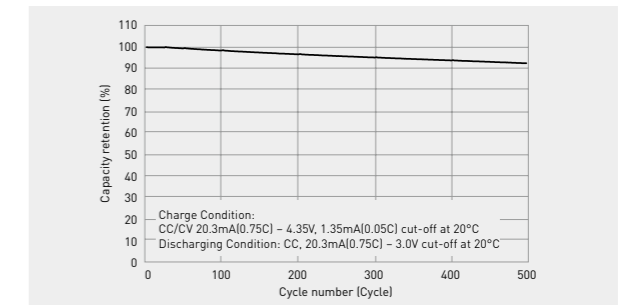
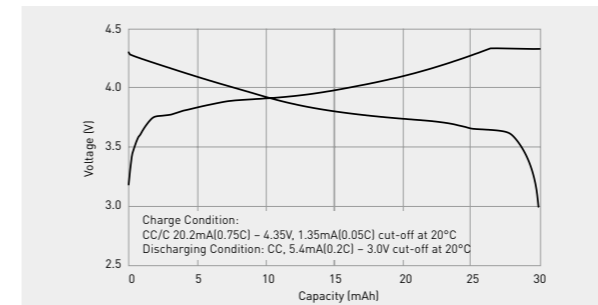

DISCHARGE CHARACTERISTICS BY TEMPERATURE

DISCHARGE CHARACTERISTICS BY RATE OF DISCHARGE

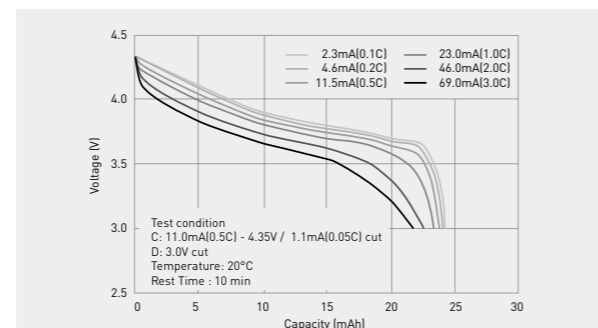
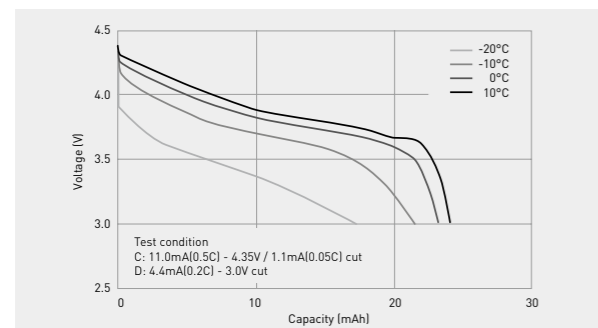

DISCHARGE CHARACTERISTICS BY TEMPERATURE

DISCHARGE CHARACTERISTICS BY RATE OF DISCHARGE

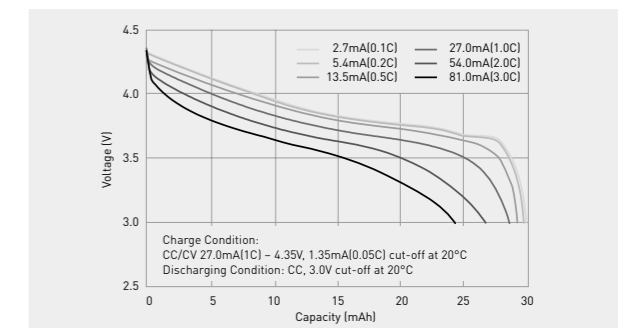
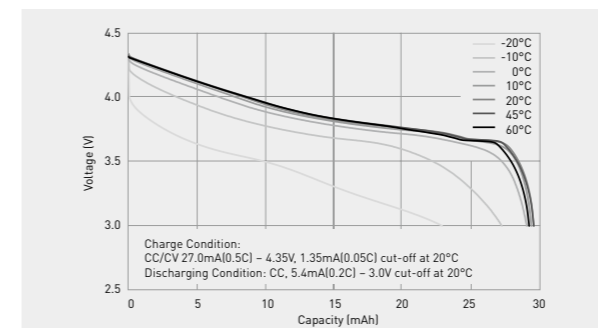

CG-425A

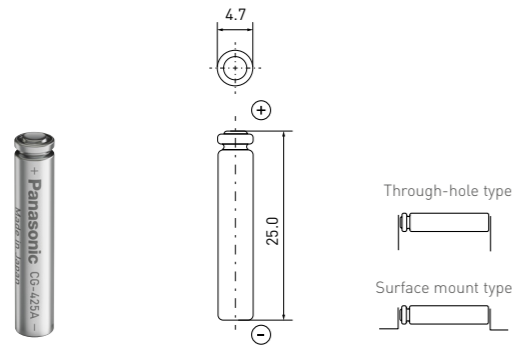

SPECIFICATIONS	CG-425A
Nominal voltage (V)	3.8
Nominal capacity (mAh)	32.0
Diameter (mm)	4.7
Total height (mm)	25.0
Discharging temperature range (°C)	-20 to +60
Charging temperature range (°C)	0 to +60
Weight (g)	1.0

CHARGE AND DISCHARGE CHARACTERISTICS

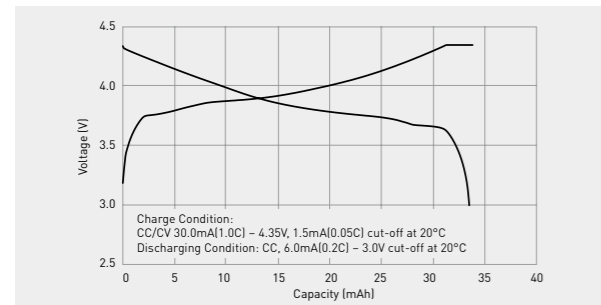

CYCLE LIFE CHARACTERISTICS

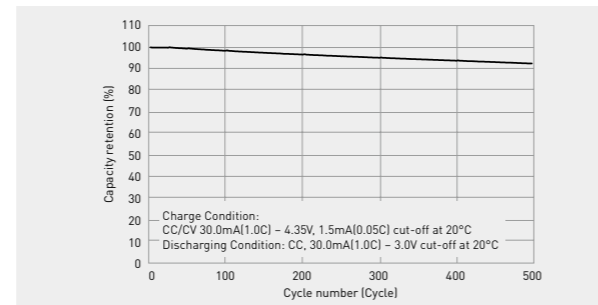

DISCHARGE CHARACTERISTICS BY TEMPERATURE

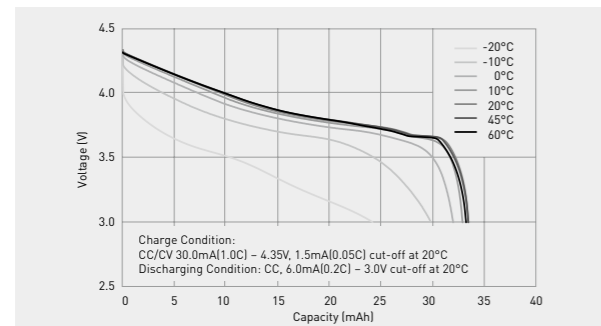

DISCHARGE CHARACTERISTICS BY RATE OF DISCHARGE

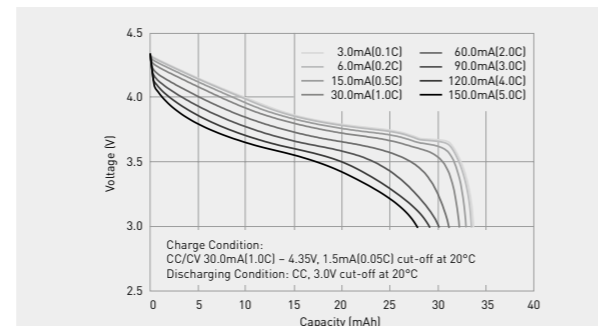

LITHIUM BATTERY TERMINALS AND SOLDERING

LONG-STANDING EXPERIENCE IN HIGH QUALITY WELDING AND SOLDERING METHODS

Due to Panasonic's long experience in quality welding and soldering methods, our customers can always expect the best terminal solution for their application. Our comprehensive line-up of different terminal types covers nearly every requirement – and custom-made solutions are possible as well.



MORE INFORMATION
on the following pages or visit our product page and get detailed information about Lithium batteries.

LITHIUM BATTERY TERMINALS AND SOLDERING

BATTERY TERMINALS

TERMINAL WELDING

For terminal welding on the battery, it is quite important to establish the best welding method and its best conditions in order to keep the strong weld strength without any damages on the battery performances. Panasonic mainly use the Laser welding method which is applicable to attach terminals on even quite small batteries that the spot welding hardly to do for. Therefore, our products can correspond exactly and flexibly to various applications. Also, we have established our own high reliable welding capability with a lot of amount of testing data to search the best weld condition for each various combinations of various battery sizes and terminal shapes, which can be provided for widespread equipments and devices.

SOLDERING ON PCB

On the edge of all terminal, tin plating is applied for increasing the reliability of soldering instead of the solder plate in order to consider influences on environments.

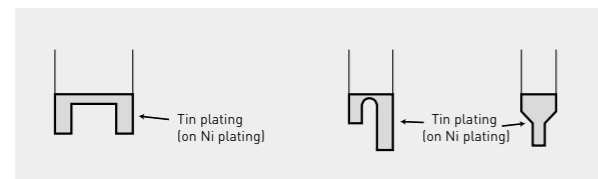

COMPLETE LINE-UP

Panasonic offers a full range of batteries with terminals for various PCB mounting. Since the terminals come in a variety types, please contact Panasonic for further details. On the other hand, we also provide battery holders for some limited sizes.

SOLDERING LITHIUM BATTERIES

USING A SOLDERING IRON

Do not allow the soldering iron to make direct contact with the bodies of the batteries. Proceed with the soldering quickly within 5 seconds while maintaining the iron tip temperature at about 350°C, and do not allow the temperature of the battery bodies to exceed 85°C (heat resistance BR type is 125°C).

AUTOMATIC DIP-SOLDERING BATH

Soldering with a dip-soldering bath can be used by condition but do not allow the temperature of the battery bodies exceed 85°C. It is important to note, depending on the temperature conditions inside the dipping device, that the battery body temperature may rise after dipping due to the residual heat retained. When a post-dipping temperature rise is observed, review the temperature conditions and consider a dipping time reduction or a way of forcibly cooling the batteries after dipping.

BASIC CONDITIONS

SOLDER DIPPING BATH TEMPERATURE	Not exceed 260°C
DIPPING DURATION	Within 5 sec.
NUMBER OF DIPPING	Within 2 times

CAUTIONS

Example where the terminals were soldered straight onto a coin type lithium battery, the terminals were connected to a PC board or other electronic components, and the heat generated by the soldering adversely affected the battery, resulting in a deterioration of the battery characteristics:

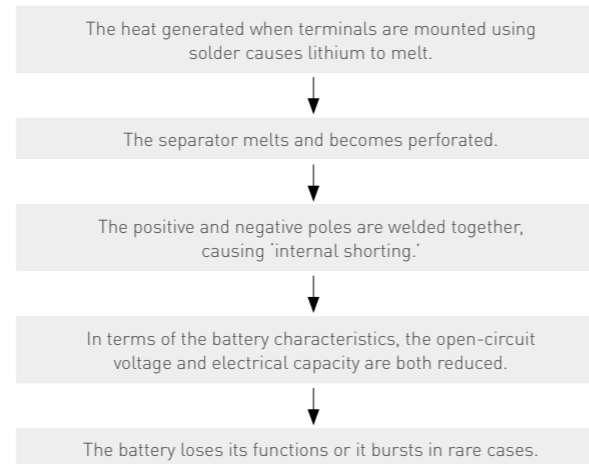

SOLDERING

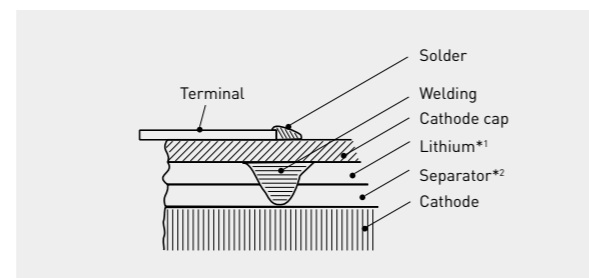

The data in this document are for descriptive purposes only and are not intended to make or imply any guarantee or warranty.

*1 Metal which melting point is about 180°C.

*2 Non woven cloth of polypropylene which melting point is about 165°C.

LITHIUM BATTERY TERMINALS AND SOLDERING

TERMINAL TYPES

Panasonic offers a broad range of different tabs for our Lithium batteries in order to meet all customer needs. In addition tailor-made solutions are possible as well.

F TYPE - 2 PINS

Surface mount
(wide distance)

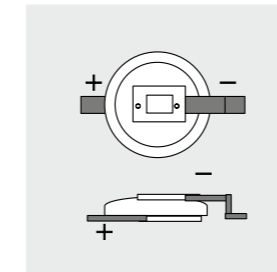

F TYPE - 2 PINS

Surface mount
(short distance)

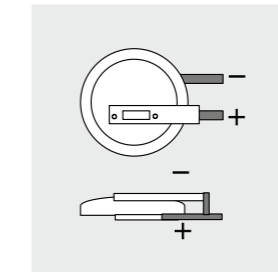

G TYPE - 3 PINS

Through hole horizontal
mount (wide distance)

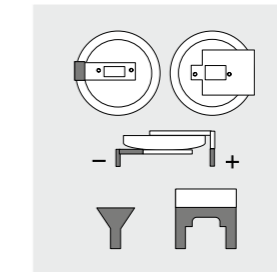

G TYPE - 3 PINS

Through hole horizontal
mount (normal distance)

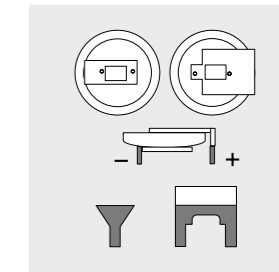

G TYPE - 3 PINS

Through hole horizontal
mount (short distance)

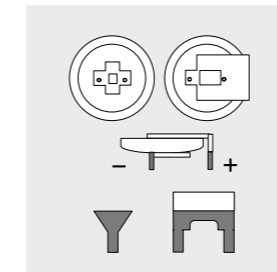

H TYPE - 2 PINS

Through hole horizontal
mount (wide distance)

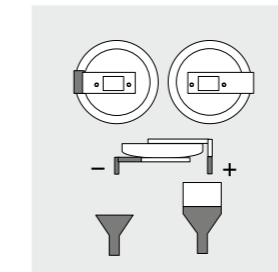

H TYPE - 2 PINS

Through hole horizontal
mount (normal distance)

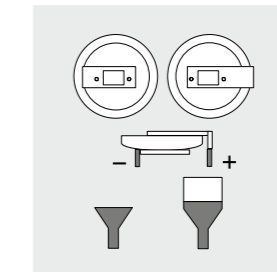

H TYPE - 2 PINS

Through hole horizontal
mount (short distance)

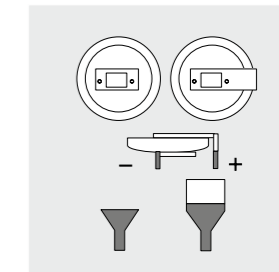

V TYPE - 3 PINS

Through hole vertical
mount

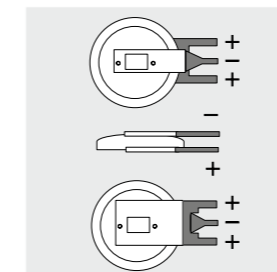

V TYPE - 2 PINS

Through hole vertical
mount

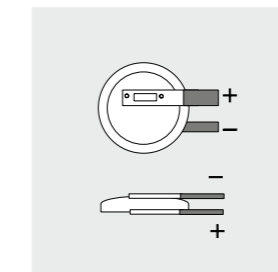

LEAD WIRE TYPE

Coin cell

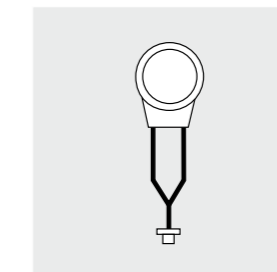

LEAD WIRE TYPE

Single cylindrical cell

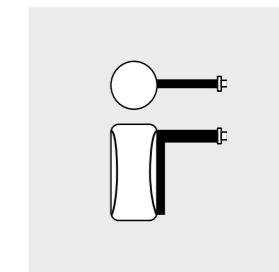

LEAD WIRE TYPE

2 to 6 cells of cylindrical
batteries in parallel or in series

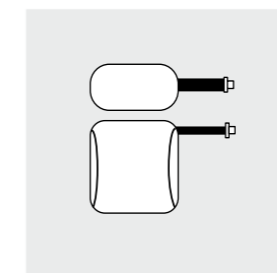

TAB TERMINAL

Cylindrical batteries for
through hole mounting

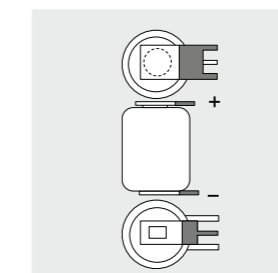

TAB TERMINAL

Cylindrical batteries for
lead wire attaching

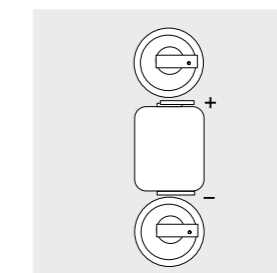

TAB TERMINAL

Cylindrical batteries for
hanging on PCB (hook type)

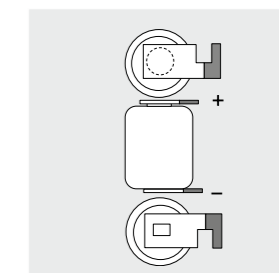

The data in this document are for descriptive purposes only and are not intended to make or imply any guarantee or warranty.

COIN-TYPE LITHIUM BATTERY TAB TERMINAL LINE-UP

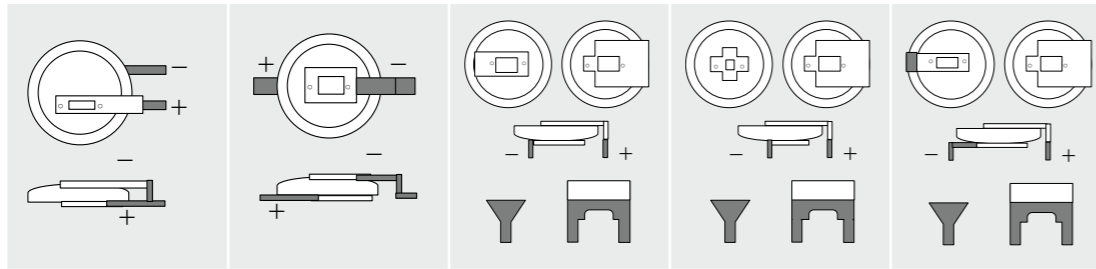

BATTERY F TYPE - 2 PINS Surface mount (short distance) F TYPE - 2 PINS Surface mount (wide distance) G TYPE - 3 PINS Through hole horizontal mount (normal distance) G TYPE - 3 PINS Through hole horizontal mount (short distance) G TYPE - 3 PINS Through hole horizontal mount (wide distance)

CR-1025	N/A	N/A	N/A	N/A	N/A
CR-1216	N/A	N/A	N/A	N/A	N/A
CR-1220	CR-1220/FCN	N/A	N/A	N/A	N/A
CR-1616	N/A	N/A	N/A	N/A	N/A
CR-1620	N/A	CR-1620/F9AN	N/A	N/A	N/A
CR-1632	N/A	CR-1632/F2N	CR-1632/G1AN	N/A	N/A
CR-2012	N/A	N/A	N/A	N/A	N/A
CR-2016	N/A	N/A	N/A	N/A	N/A
CR-2025	N/A	N/A	N/A	N/A	N/A
CR-2032	CR-2032/F4N	CR-2032/F2N	CR-2032/GUFN	N/A	N/A
CR-2330	N/A	CR-2330/F3N	N/A	CR-2330/GUFN	N/A
CR-2354	N/A	CR-2354/F2N	N/A	CR-2354/GUFN	N/A
CR-2412	N/A	N/A	N/A	N/A	N/A
CR-2450	N/A	N/A	N/A	CR-2450/G1AN	N/A
CR-2477	N/A	CR-2477/F2N	N/A	N/A	CR-2477/G1AN
CR-3032	N/A	CR-3032/F2N	N/A	N/A	N/A
CR-2032A	N/A	N/A	N/A	N/A	N/A
CR-2032B	CR-2032B/FCN	N/A	N/A	N/A	N/A
CR-2050A	N/A	N/A	N/A	N/A	N/A
CR-2050B2	CR-2050B2FAN	N/A	N/A	N/A	N/A
CR-2450B	CR-2450B/FAN	N/A	N/A	CR-2450A/GBN	N/A
BR-1220	BR-1220/FCN	N/A	N/A	N/A	N/A
BR-1225	BR-1225/F1AN	N/A	N/A	N/A	N/A
BR-1632	N/A	BR-1632/F2N	N/A	N/A	N/A
BR-2032	BR-2032/F4N	BR-2032/F2N	BR-2032/GUFN	N/A	N/A
BR-2325	N/A	N/A	BR-2325/HGN	N/A	N/A
BR-2330	N/A	BR-2330/F3N	N/A	BR-2330/GUFN	N/A
BR-3032	N/A	BR-3032/F2N	N/A	Please contact us.	N/A
BR-1225A	BR-1225A/FAN	N/A	N/A	N/A	N/A
BR-1632A	N/A	BR-1632A/FAN	BR-1632A/GBN	N/A	N/A
BR-2330A	N/A	BR-2330A/FAN	N/A	Please contact us.	N/A
BR-2450A	BR-2450A/FJN	N/A	N/A	BR-2450A/GBN	N/A
BR-2477A	N/A	BR-2477A/FBN	N/A	N/A	BR-2477A/GAN

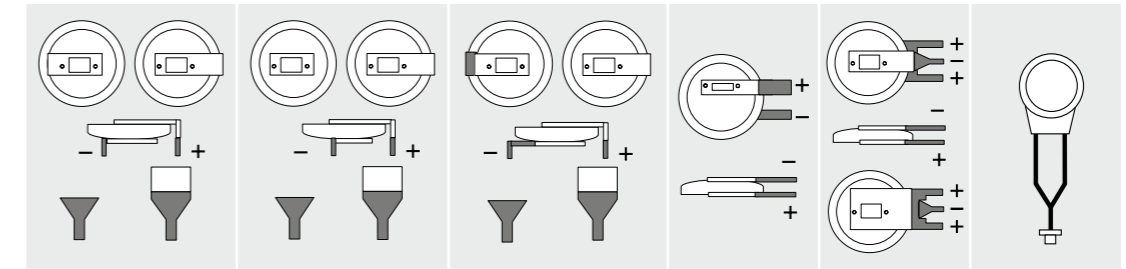

H TYPE - 2 PINS Through hole horizontal mount (normal distance) H TYPE - 2 PINS Through hole horizontal mount (short distance) H TYPE - 2 PINS Through hole horizontal mount (wide distance) V TYPE - 2 PINS Through hole vertical mount V TYPE - 3 PINS Through hole vertical mount LEAD WIRE TYPE Coin cell BATTERY

CR-1025/H9AN	N/A	N/A	Please contact us.	N/A	N/A	CR-1025
N/A	N/A	N/A	N/A	N/A	N/A	CR-1216
N/A	CR-1220/HFN	N/A	CR-1220/VCN	N/A	N/A	CR-1220
N/A	N/A	N/A	N/A	N/A	N/A	CR-1616
N/A	N/A	N/A	N/A	N/A	N/A	CR-1620
CR-1632/HFN	N/A	N/A	CR-1632/V1AN	N/A	Please contact us.	CR-1632
N/A	N/A	N/A	N/A	N/A	N/A	CR-2012
N/A	N/A	N/A	N/A	N/A	N/A	CR-2016
N/A	N/A	CR-2025/HFN	Please contact us.	N/A	N/A	CR-2025
N/A	N/A	CR-2032/HFN	CR-2032/VS1N	CR-2032/GVFN	N/A	CR-2032
N/A	N/A	N/A	N/A	CR-2330/GVFN	N/A	CR-2330
N/A	CR-2354/HFN	N/A	CR-2354/VCN	N/A	N/A	CR-2354
N/A	N/A	N/A	N/A	N/A	N/A	CR-2412
N/A	CR-2450/H1AN	N/A	CR-2450/VAN	CR-2450/G3N	N/A	CR-2450
N/A	CR-2477/HFN	N/A	CR-2477/VCN	CR-2477/GVFN	N/A	CR-2477
N/A	N/A	N/A	CR-3032/VCN	N/A	N/A	CR-3032
N/A	N/A	CR-2032A/HAN	N/A	N/A	N/A	CR-2032A
N/A	N/A	N/A	N/A	N/A	N/A	CR-2032B
CR-2050A/HCN	N/A	N/A	N/A	N/A	N/A	CR-2050A
N/A	N/A	CR-2050B2HCN	N/A	N/A	N/A	CR-2050B2
CR-2450B/HAN	N/A	N/A	N/A	N/A	N/A	CR-2450B
N/A	BR-1220/HFN	N/A	BR-1220/VCN	N/A	N/A	BR-1220
N/A	BR-1225/H1AN	N/A	BR-1225/VCN	N/A	N/A	BR-1225
BR-1632/HFN	N/A	N/A	BR-1632/V1AN	N/A	N/A	BR-1632
N/A	N/A	BR-2032/HFN	Please contact us.	BR-2032/GVFN	N/A	BR-2032
BR-2325/HCN	N/A	N/A	BR-2325/VCN	N/A	N/A	BR-2325
BR-2330/HFN	N/A	N/A	Please contact us.	BR-2330/GVFN	N/A	BR-2330
N/A	N/A	Please contact us.	BR-3032/VCN	N/A	N/A	BR-3032
N/A	BR-1225A/HBN	N/A	BR-1225A/VAN	N/A	N/A	BR-1225A
BR-1632A/HAN	N/A	N/A	BR-1632A/VAN	N/A	N/A	BR-1632A
BR-2330A/HDN	N/A	N/A	BR-2330A/VAN	BR-2330A/GDN	N/A	BR-2330A
N/A	BR-2450A/HAN	N/A	N/A	N/A	N/A	BR-2450A
N/A	BR-2477A/HBN	N/A	BR-2477A/VAN	N/A	N/A	BR-2477A

CYLINDRICAL-TYPE LITHIUM BATTERY TAB TERMINAL LINE-UP

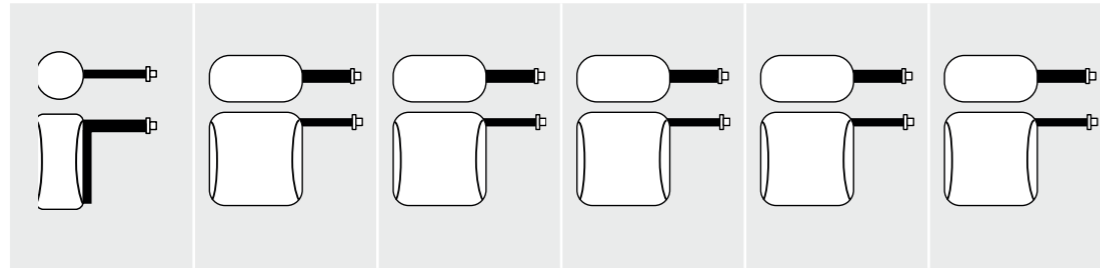

BATTERY	LEAD WIRE TYPE	LEAD WIRE TYPE	LEAD WIRE TYPE	LEAD WIRE TYPE	LEAD WIRE TYPE	LEAD WIRE TYPE
	1 cell	2 cells in parallel	3 cells in parallel	4 cells in parallel	5 cells in parallel with protection device	5 cells in parallel
CR-2	N/A	N/A	N/A	N/A	N/A	N/A
CR-123A	N/A	N/A	N/A	N/A	N/A	N/A
2CR-5	N/A	N/A	N/A	N/A	N/A	N/A
CR-P2	N/A	N/A	N/A	N/A	N/A	N/A
CR-AGZ	CR-AGZC22N	Please contact us.	Please contact us.	Please contact us.	Please contact us.	Please contact us.
CR-AG	CR-AGC22N	CR-AGDCF2TN	Please contact us.	Please contact us.	Please contact us.	Please contact us.
CR-2/3AZ	CR-2/3AZC22N	Please contact us.	Please contact us.	Please contact us.	Please contact us.	Please contact us.
CR-2Z	Please contact us.	Please contact us.	Please contact us.	N/A	N/A	N/A
CR-2U	Please contact us.	Please contact us.	Please contact us.	N/A	N/A	N/A
CR-AAU	CR-AAUC3N	Please contact us.	Please contact us.	Please contact us.	Please contact us.	Please contact us.
CR-AAK	N/A	N/A	N/A	N/A	N/A	N/A
CR-LAZ	N/A	N/A	N/A	N/A	N/A	N/A
CR-LAS	N/A	N/A	N/A	N/A	N/A	N/A
BR-1/2AA	BR-1/2AAC2P	N/A	N/A	N/A	N/A	N/A
BR-2/3A	N/A	N/A	N/A	N/A	N/A	N/A
BR-2/3AG	N/A	N/A	N/A	N/A	N/A	N/A
BR-A	N/A	N/A	N/A	N/A	N/A	N/A
BR-AG	N/A	N/A	N/A	N/A	N/A	N/A
BR-C	N/A	N/A	N/A	N/A	N/A	N/A

COIN TYPE RECHARGEABLE LITHIUM BATTERIES TAB TERMINAL LINE-UP

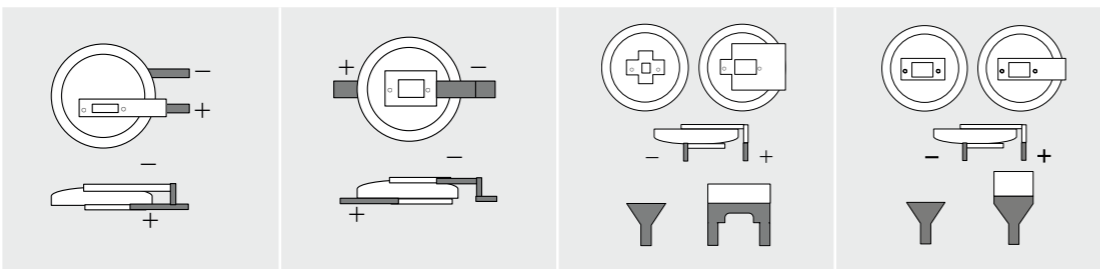

BATTERY	F TYPE - 2 PINS	F TYPE - 2 PINS	G TYPE - 3 PINS	H TYPE - 2 PINS
	Surface mount (short distance)	Surface mount (wide distance)	Through hole horizontal mount (short distance)	Through hole horizontal mount (short distance)
VL-1220	VL-1220/FCN	N/A	N/A	VL-1220/HFN
VL-2020	N/A	VL-2020/F1AN	N/A	N/A
VL-2330	N/A	VL-2330/F3N	N/A	VL-2330/HFN
VL-3032	N/A	VL-3032/F2N	VL-3032/GUFN	N/A
ML-2020	N/A	N/A	N/A	N/A
CTL-621F	N/A	N/A	N/A	N/A
CTL-920F	N/A	N/A	N/A	N/A
CTL-1616F	CTL-1616/FAN	N/A	N/A	N/A
MT-516F	N/A	N/A	N/A	N/A
MT-621	N/A	N/A	N/A	N/A
MT-920	N/A	N/A	N/A	N/A

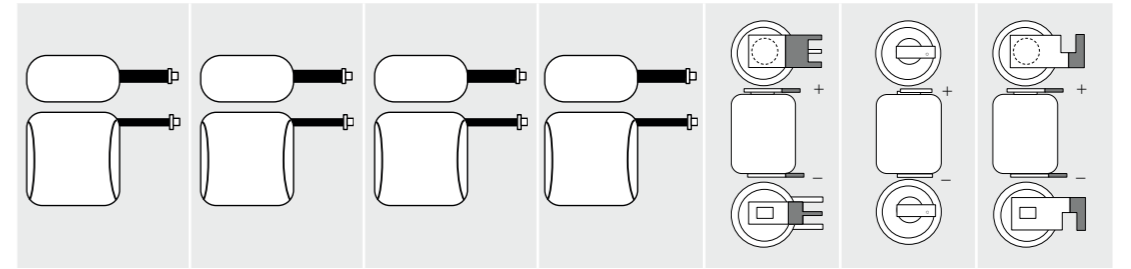

LEAD WIRE TYPE	LEAD WIRE TYPE	LEAD WIRE TYPE	LEAD WIRE TYPE	TAB TERMINAL	TAB TERMINAL	TAB TERMINAL	BATTERY
5 cells in parallel with protection device	6 cells in parallel	2 cells in series	3 cells in series	Cylindrical batteries for through hole mounting	Cylindrical batteries for lead wire attaching	Cylindrical batteries for hanging on PCB (hook type)	
N/A	N/A	N/A	N/A	N/A	N/A	N/A	CR-2
N/A	N/A	N/A	Please contact us.	N/A	N/A	N/A	CR-123A
N/A	N/A	N/A	N/A	N/A	N/A	N/A	2CR-5
N/A	N/A	N/A	N/A	N/A	N/A	N/A	CR-P2
Please contact us.	Please contact us.	Please contact us.	Please contact us.	CR-AGZE2N	N/A	N/A	CR-AGZ
Please contact us.	Please contact us.	Please contact us.	Please contact us.	CR-AGE2N	N/A	CR-AGDE27N	CR-AG
Please contact us.	Please contact us.	Please contact us.	Please contact us.	CR-2/3AZE2PN	N/A	CR-2/3AZE27N	CR-2/3AZ
N/A	N/A	Please contact us.	Please contact us.	CR-2ZLE2N	N/A	N/A	CR-2Z
N/A	N/A	Please contact us.	Please contact us.	N/A	N/A	N/A	CR-2U
Please contact us.	Please contact us.	Please contact us.	Please contact us.	CR-AAUE2N	N/A	N/A	CR-AAU
N/A	N/A	N/A	Please contact us.	N/A	N/A	N/A	CR-AAK
N/A	N/A	N/A	Please contact us.	CR-LAZ/E2N	N/A	N/A	CR-LAZ
N/A	N/A	N/A	Please contact us.	N/A	N/A	N/A	CR-LAS
N/A	N/A	N/A	N/A	BR-1/2AAE2PN	N/A	N/A	BR-1/2AA
N/A	N/A	N/A	N/A	BR-2/3AE2PN	N/A	N/A	BR-2/3A
N/A	N/A	N/A	N/A	BR-2/3AGE2PN	N/A	N/A	BR-2/3AG
N/A	N/A	N/A	N/A	BR-AE2SPE	N/A	N/A	BR-A
N/A	N/A	N/A	N/A	BR-AGE2PE	N/A	N/A	BR-AG
N/A	N/A	N/A	N/A	N/A	BR-CT2SP	N/A	BR-C

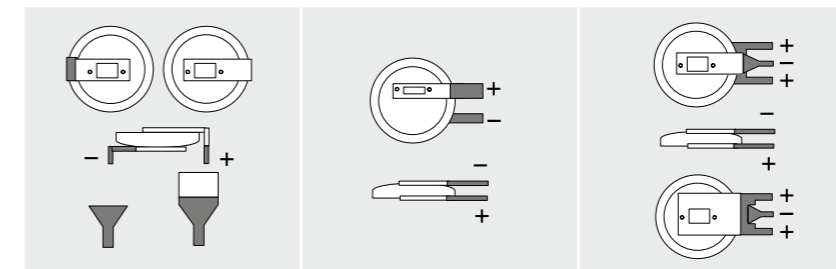

H TYPE - 2 PINS	V TYPE - 2 PINS	V TYPE - 3 PINS	BATTERY
Through hole horizontal mount (wide distance)	Through hole vertical mount	Through hole vertical mount	
N/A	VL-1220/VCN	N/A	VL-1220
VL-2020/HFN	VL-2020/VCN	N/A	VL-2020
N/A	VL-2330/VCN	VL-2330/G1CN	VL-2330
Please contact us.	VL-3032/VCN	N/A	VL-3032
ML-2020/H1BN	ML-2020/V1AN	ML-2020/G1AN	ML-2020
N/A	N/A	N/A	CTL-621F
N/A	N/A	N/A	CTL-920F
N/A	N/A	N/A	CTL-1616F
N/A	N/A	N/A	MT-516F
N/A	N/A	N/A	MT-621
N/A	N/A	N/A	MT-920

STANDARDS AND REGULATIONS

PRODUCT CERTIFICATIONS

UL APPROVED BATTERIES

All our Lithium batteries are in compliance with UL 1642 (primary and secondary lithium batteries) - file number MH 12210. These requirements cover lithium batteries intended for use in technician-replaceable or user-replaceable applications.

FACTORY CERTIFICATIONS

All our production sites are ISO 9001 und ISO 14001 certified. Moriguchi, Japan and Jakarta, Indonesia sites are additionally certified towards IATF 16949. Moriguchi, Japan is also certified according to OHSAS 18001.

APPLICABLE STANDARDS

IEC 60086-1

Standardization of primary batteries with respect to their electrochemical system, dimensions, nomenclature, terminal configurations, markings, test methods, typical performance, safety and environmental aspects.

APPLICABLE PRODUCTS IN THIS CATALOGUE:

BR-2/3A [BR17335], BR-2/3AG [BR17335], CR-2 [CR15H270], CR-123A [CR17345], 2CR-5 [2CR5], CR-P2 [CRP2], BR-1225 [BR1225], BR-2325 [BR2325], CR-1025 [CR1025], CR-1216 [CR1216], CR-1220 [CR1220], CR-1616 [CR-1616], CR-1620 [CR1620], CR-2012 [CR2012], CR-2016 [CR2016], CR-2025 [CR2025], CR-2032 [CR2032], CR-2330 [CR2330], CR-2354 [CR2354], CR-2450 [CR2450], CR-3032 [CR3032]

IEC 60086-2

Complements the general information and requirements of IEC 60086-1.

IEC 60086-3

Specifies dimensions, designation, methods of tests and requirements for primary batteries for watches.

APPLICABLE PRODUCTS IN THIS CATALOGUE:

BR-1225 [BR1225], BR-2325 [BR2325], CR-1025 [CR1025], CR-1216 [CR1216], CR-1220 [CR1220], CR-1616 [CR-1616], CR-1620 [CR1620], CR-2012 [CR2012], CR-2016 [CR2016], CR-2025 [CR2025], CR-2032 [CR2032], CR-2330 [CR2330], CR-2354 [CR2354], CR-2450 [CR2450]

IEC 60086-4

Requirements for primary lithium batteries to ensure their safe operation under intended use and reasonably foreseeable misuse.

Applicable products in this catalogue: BR, CR

Although not mandatory, Panasonic is progressing third party test certification aka CB-scheme according to this standard.

For several battery types in this catalogue, such a report is available on request.

IEC 62133-2

Requirements and tests for the safe operation of portable sealed secondary lithium cells and batteries containing non-acid electrolyte, under intended use and reasonably foreseeable misuse.

Applicable products in this catalogue: CG

LITHIUM BATTERY TRANSPORTATION

The transportation of lithium batteries is regulated by the International Air Transport Association (IATA), the International Civil Aviation Organization (ICAO) and Accord européen relatif au transport international des marchandises Dangereuses par Route (ADR).

All batteries are approved in accordance to UN Spezial Provision SP 188 Manual of Tests & Criteria Part III Subsection 38.3.

Transport test related to UN 38.3 reports are available on request.

TRANSPORT BY ROAD/RAIL

UN 3090 takes place under ADR/RID 2019

TRANSPORT BY SEA

UN 3090 takes place under IMDG Code 2019

TRANSPORT BY AIR

UN 3090 takes place under IATA DGR 2020 61st Edition

SECURITY EXPORT CONTROL

'Security export control' entails observing the legislation provided to maintain international peace and safety by preventing the proliferation of weapons of massive destructions (nuclear weapons, chemical warfare weapons, biological weapons and missiles) and the excessive buildup of conventional weapons. COCOM, the committee that imposed controls on exports to the Communist bloc, was disbanded on March 31, 1994. Later, as part of a new export control regime, Russia and Eastern European countries joined with the previously affiliated nations of COCOM (Japan, America and Europe) and established the Wassenaar Arrangement for dual-use goods & technologies related to conventional weapons. According to the Export Trade Control Order revised by the Japanese Ministry of Economy, Trade & Industry in May 2008, batteries listed in this catalogue are classified as 'batteries' not 'cells', and will therefore not be controlled by (7) in annex table 1 to the order. The above notwithstanding, these batteries may be subject to the regulations depending on their ultimate destination, application and other conditions. When a certificate of classification is required for exportation, etc. or if you have any queries, contact a Panasonic sales representative.

AVOIDING HAZARDS

CASE STUDY AND EXPLANATION

To store batteries, place each of the batteries in the sections provided on the designated tray in such a way that they will not make contact with one another.

IGNITION

2,000 new batteries were taken out from the 20-piece tray containers and thrown randomly into a cardboard box where they were stacked on top of one another. About 30 minutes later, smoke was seen emanating from the batteries followed by ignition several minutes after that.

CASE STUDY: Ignition of batteries stacked together

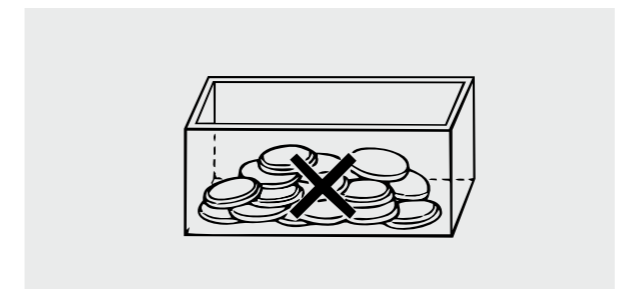

RUPTURE

This particular case involves batteries which were packed in trays and destined for OEMs. The batteries were packed in an intermediate package consisting of 10 trays with each tray containing 20 (or 40) batteries, and the trays were stacked on top of each other. The intermediate package (of the 10 trays) was opened at the distribution stage of our operations, and five of the trays were delivered to one customer. Since the trays were stored at an angle inside the box, the batteries fell out of their positions on the trays and became stacked up on the bottom inside the small box. As a result, some of the batteries burst.

CASE STUDY: Bursting of batteries stacked on top of one another

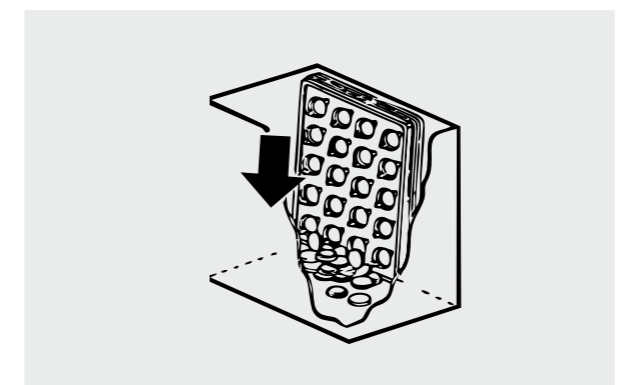

GENERATING HEAT

21 cylindrical type lithium batteries with tab terminals were placed in a 20-piece tray – one battery more than the capacity of the 20-piece tray. Two of the batteries were placed together with their poles reversed. As a result, the tab terminals came into contact with each other, causing external shorting, and the temperature of the two batteries rose dramatically, generating heat and causing the tubes to burst.

Since two batteries were placed in a space (indicated by the arrow) allocated to one battery, their terminals made contact with each other, and external shorting resulted.

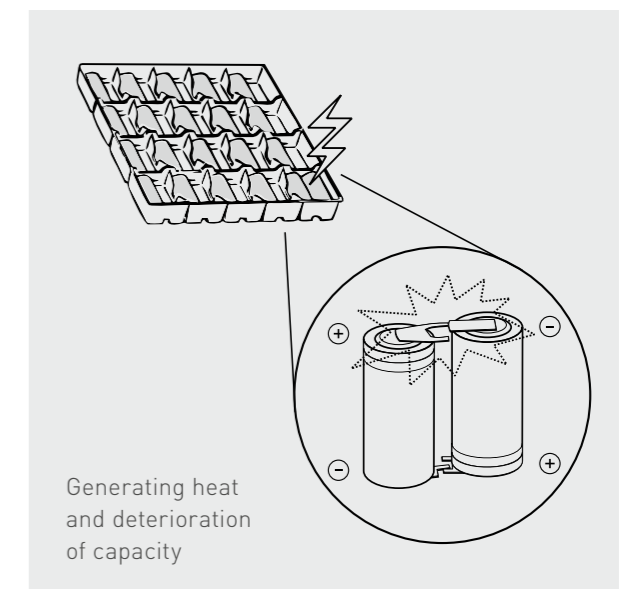

To store batteries, place each of the batteries in the sections provided on the designated tray in such a way that they will not make contact with one another.

PREVENTING QUALITY PROBLEMS

REDUCTION OF BATTERY VOLTAGE AND DETERIORATION OF CAPACITY

REDUCTION OF BATTERY VOLTAGE AND DETERIORATION OF CAPACITY THROUGH CONTACT WITH ANTISTATIC CONDUCTIVE MATERIALS

Incidents have been reported where terminal-mounted batteries for memory back-up or coin type lithium batteries have come into contact with anti-static conductive materials, thus forming external discharge circuits and leading to voltage drops or capacity deterioration.

In manufacturing plants using ICs, LSI and other semiconductor components, thoroughgoing antistatic measures are taken. Various protective materials are used to prevent static: most of them have special compounds of carbon, aluminum foil and other metals and are therefore conductive. These protective materials are used, for example, in the form of packaging bags, trays, mats, sheets, films, corrugated boards and resin cases.

FIG. 1 A terminal-mounted battery was inserted into a conductive mat. The battery charge was exhausted in several days.

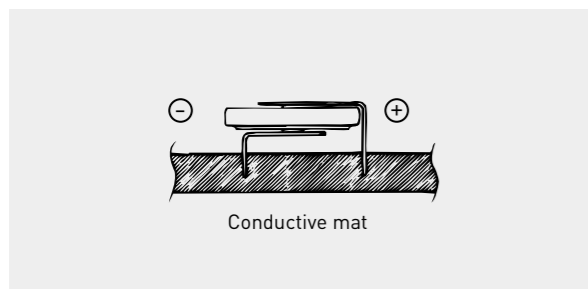
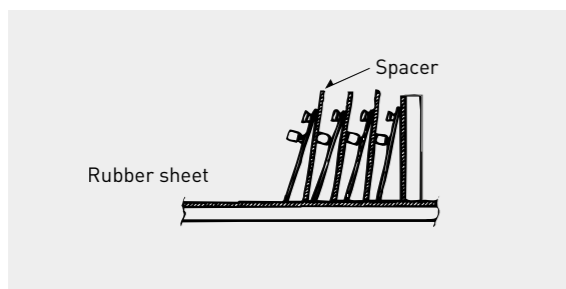

FIG. 2 Battery-mounted PC boards were inadvertently brought into contact with spacers and a conductive rubber sheet. The battery charge was exhausted.



A protective material may have a resistance ranging from 103 to 106Ω/cm, for instance. This means that if the ⊕ and ⊖ terminals of a battery come into contact with this material, a current ranging from several milliamperes to several microamperes will flow and the battery will discharge, causing voltage drop and capacity deterioration.

When batteries are to be used near protective materials, take every possible care to ensure that the ⊕ and ⊖ terminals of the batteries or PC boards, etc. on which batteries are mounted do not touch these protective materials directly.

FIG. 3 A battery-mounted PC board was inadvertently brought into contact with a conductive resin case. The battery charge was exhausted.

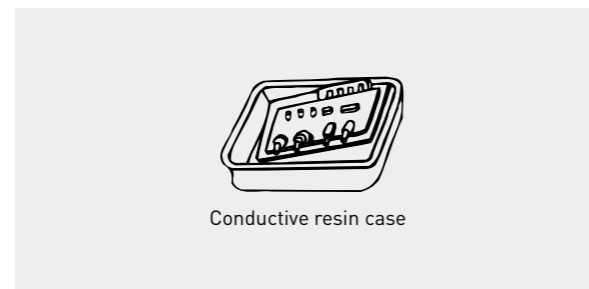
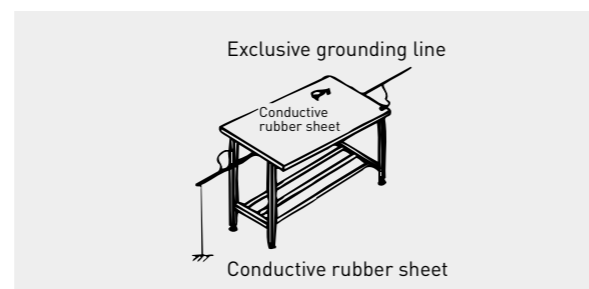

FIG. 4 A battery was placed directly on a rubber sheet spread over a worktable. The ⊕ and ⊖ terminals were in contact with the sheet and the battery charge was exhausted.



PREVENTING QUALITY PROBLEMS

REDUCTION OF BATTERY VOLTAGE AND DETERIORATION OF CAPACITY THROUGH CONTACT BETWEEN BATTERIES

Incidents have been reported where terminal-mounted batteries for memory back-up or coin type lithium batteries have come into contact each other, thus forming discharge circuits (shorted state) and leading to voltage drops or capacity deterioration. Observe the following precautions.

1. Remove the batteries from the tray one at a time. If the tray is turned upside down, the batteries will come into contact with each other, forming discharge circuits.
2. Do not place batteries randomly in a parts box or other container. Discharge circuits will be formed by multiple batteries coming into contact numbers of the batteries, causing the batteries to discharge and drain.

✓ RECOMMENDED PROCEDURES

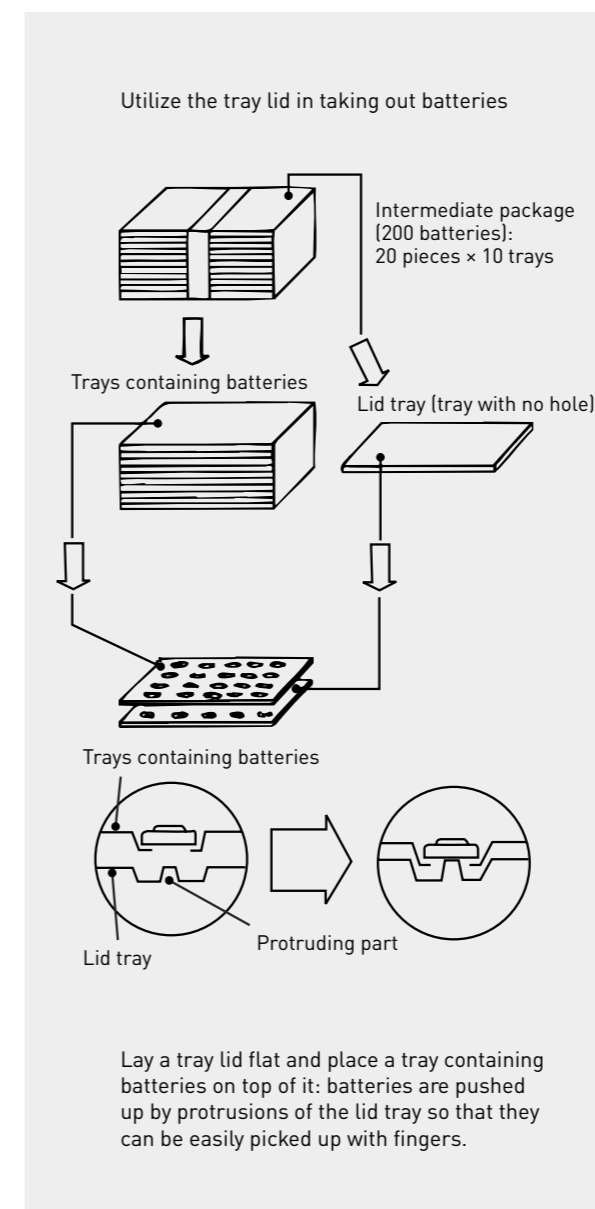

✗ PROHIBITED PROCEDURES

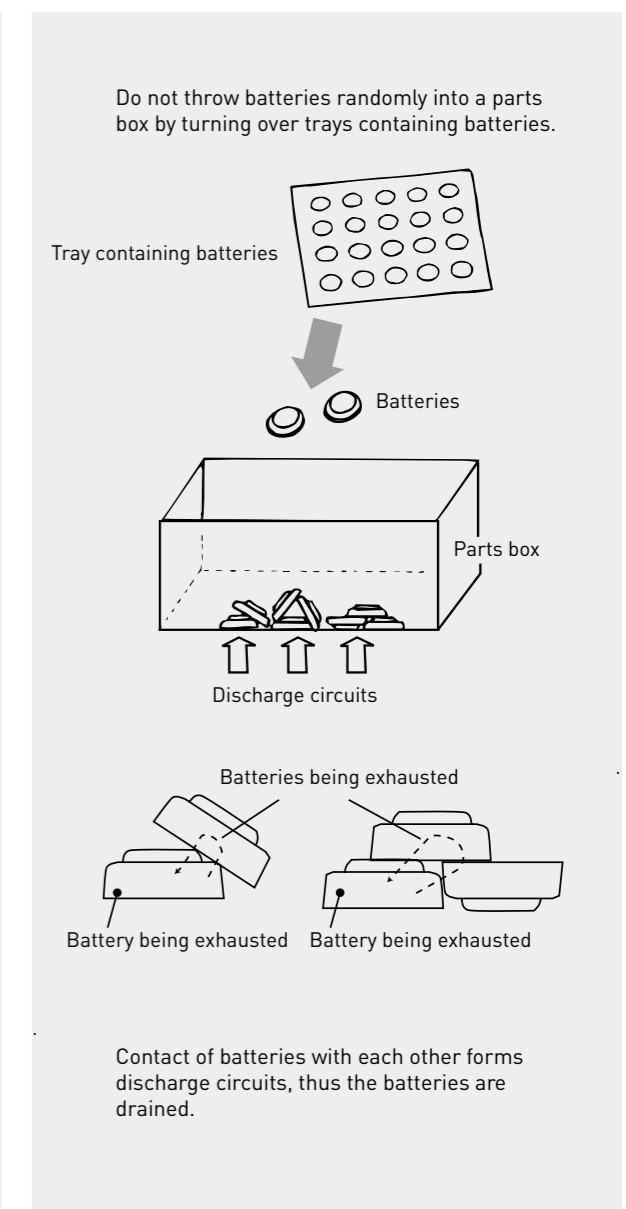

MEMORY ERASURE PROBLEMS

Coin type lithium batteries are often used as the power supplies for memory back-up in various equipment. However problems with the erasure of valuable data in the memory due to improper contact between the batteries and equipment have been reported.

1. When batteries are to be used continuously for a prolonged period.
 - | Select tab terminal-mounted batteries, and solder the tabs to the battery connection terminals of the equipment. (See fig. 1)
 - | When batteries need to be replaced, use a battery holder (see fig. 2) or battery with lead wire connectors (see fig. 3). Battery holders made by Panasonic (exclusively for the CR-2032 and BR-2032, see fig. 2) are available for use.
 - | When batteries need to be replaced, use a battery holder (see fig. 2) or battery with lead wire connectors (see fig. 3). Battery holders made by Panasonic (exclusively for the CR-2032 and BR-2032, see fig. 2) are available for use.

2. When batteries need to be replaced in the short term, select batteries with no terminals or lead wire connectors.
 - | Use of Y-shaped terminals (2-point contact) for both the anode and cathode as the shape of the connection terminals in the equipment helps to achieve a more stable contact. (See fig. 4)
 - | The contact pressure of the contacts should be no less than 2 to 10N (approx. 200 to 1,000gf). (See fig. 5)
 - | To prevent momentary contact failure of several milliseconds in the circuit, the use of a tantalum capacitor, etc. with a capacitance of several microfarads is effective. (See fig. 6)
 - | For the connection terminals of the equipment, use iron or stainless steel with nickel plating at the very least. Gold-plating is more suitable when the contact resistance must be reduced.

NOTE: Do not touch batteries with bare hands because perspiration (salt), body oil, etc. will increase the surface resistance which may lead to defective contact.

REFERENCE SAMPLES SEE FIG. 1-6

FIG. 1 Soldering

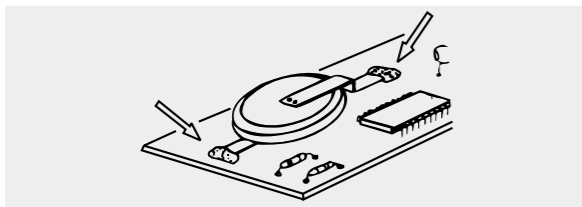

FIG. 4

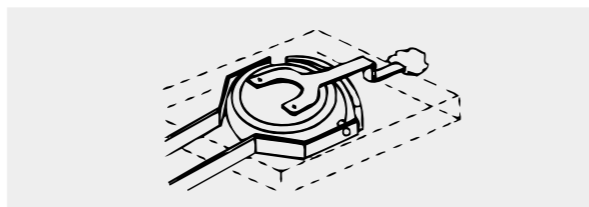

FIG. 2

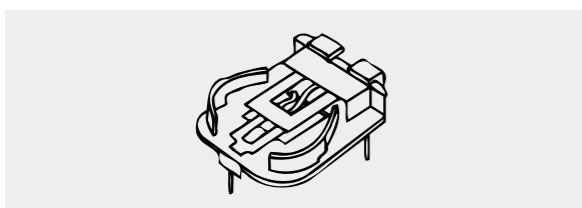

FIG. 5 Excessive load

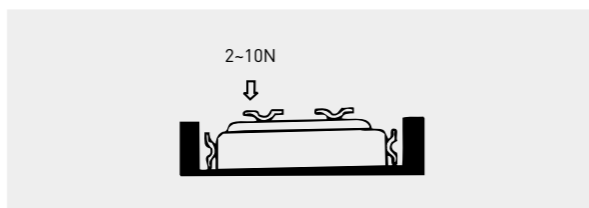

FIG. 3

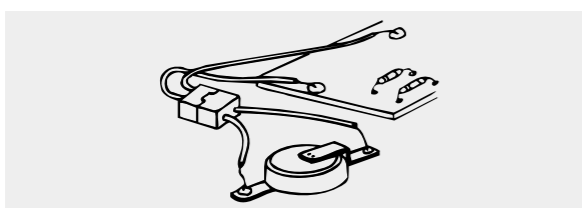
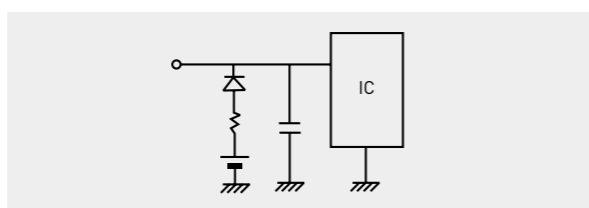

FIG. 6



FIND THE RIGHT CONTACT

Connect only with authorized distributors, enjoy their first-hand consulting and sales service guaranteeing you purchase genuine Panasonic products.

Search on our website for your local partner for authentic products before placing an order. To ensure the desired quality, we kindly ask you to refrain from purchasing Panasonic products from any unauthorized supplier.





YOUR LOCAL DISTRIBUTOR

Find your local distributor on our website directly with this link.

E-MAIL AND WEBSITE FOR ALL EUROPEAN COUNTRIES



 battery-solutions@eu.panasonic.com
 <https://industry.panasonic.eu>

UNITED KINGDOM / IRELAND
Panasonic Industry Europe GmbH
Maxis 2, Western Road
Bracknell Berkshire
RG12 1RT, England
Phone: +44 1344 85 32 60

GERMANY
(all other European countries)
Panasonic Industry Europe GmbH
Winsbergring 15
22525 Hamburg, Germany
Phone: +49 40 85 49 63 73

SPAIN / PORTUGAL
Panasonic Industry Europe GmbH
Sucursal en España
Parque Empresarial @ Sant Cugat,
Via Augusta 15-25
Edificio B2 Planta 4 Oficina 17
08174 Sant Cugat del Valles
Barcelona, Spain
Phone: +34 93 504 30 10

FRANCE
Panasonic Industry Europe GmbH
10, rue des petits ruisseaux
91370 Verrières-le-Buisson, France
Phone: +33 1 60 13 57 62

ITALY
Panasonic Industry Italia s.r.l.
Viale Fulvio Testi 280/6
20126 Milano, Italy
Phone: +39 2 678 81

Notice to Readers

It is the responsibility of each user to ensure that every battery application is adequately designed safe and compatible with all conditions encountered during use, and in conformance with existing standards and requirements. This literature contains information concerning cells and batteries manufactured by Panasonic Energy Co., Ltd. This information is descriptive only and is not intended to make or imply any representation, guarantee or warranty with respect to any cells and batteries. Cell and battery designs are subject to modification without notice.

Printed in Germany 2025. © Panasonic Energy Co., Ltd.