

PAN9520

Embedded Wi-Fi Module

Module Integration Guide

Rev. 1.1



Overview

The PAN9520 is a 2.4 GHz ISM band Wi-Fi embedded module based on Espressif ESP32-S2, which includes a wireless radio and a MCU for easy integration of Wi-Fi connectivity into various electronic devices.

Features

- Embedded 2.4 GHz Wi-Fi 802.11 b/g/n module
- Xtensa® single-core 32-bit LX7 microprocessor, up to 240 MHz
- Chip internal 128 kB ROM, 320 kB SRAM, and 16 kB low power SRAM
- Integrated QSPI Flash and PSRAM (a variety of memory densities are available)
- Ultra-Low Power (ULP) co-processor usable in deep sleep mode
- All security features required for WPA2 and WPA3 personal
- Espressif Integrated Development Framework (ESP-IDF) with a multitude of examples available for software development
- Supports 20 MHz and 40 MHz bandwidths in 2.4 GHz band with data rates up to 150 Mbps
- Simultaneous support for Infrastructure Station, SoftAP, and promiscuous modes
- 802.11mc Fine Time Measurement (FTM)

- 36x programmable GPIOs with a rich set of alternative functionalities:
 - 2x 12-bit SAR ADCs, up to 20 channels
 - 2x 8-bit DAC
 - 14x touch sensing IOs
 - 4x SPI (2x available for general purpose)
 - 1x I²S
 - 2x I²C
 - 2x UART
 - RMT (Tx/Rx)
 - LED PWM, up to 8 channels
 - 1x full-speed USB OTG
 - 1x DVP 8/16 camera interface (I²S resources used)
 - 1x LCD interface (SPI2 resources used)
 - 1x LCD interface (I²S resources used)

Characteristics

- Surface Mount Type (SMT): 24 mm x 13 mm x 3.1 mm
- Tx power: up to 19.5 dBm at IEEE 802.11b 1 Mbps
- Rx sensitivity: -97 dBm at IEEE 802.11b 1 Mbps
- Power supply: 3 V to 3.6 V
- Current consumption 260 mA Tx (average at 11b, 11 Mbps), 76 mA Rx (40 MHz channel), 310 mA Tx peak
- Deep sleep mode: <100 µA typical power consumption (RTC timer only and VDD_SPI disconnected)
- Wide temperature range from -40 °C to 85 °C

Block Diagram

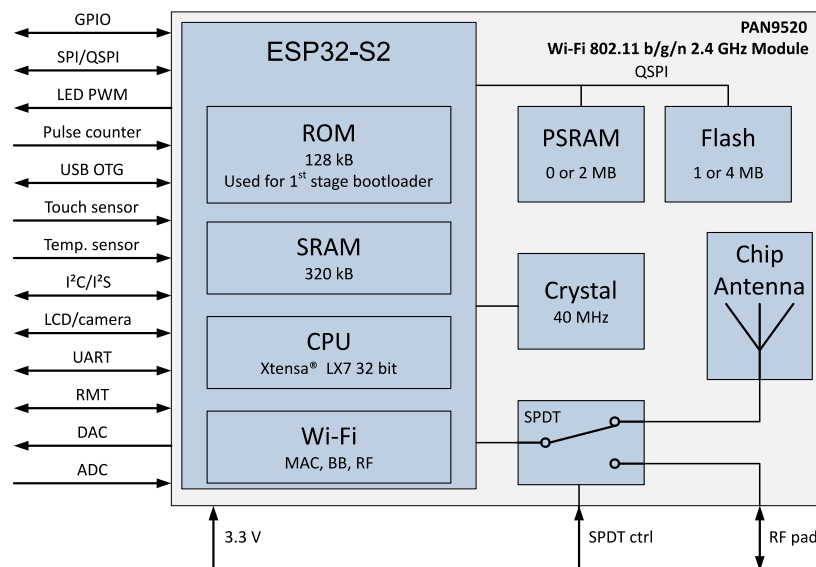

By purchase of any of the products described in this document the customer accepts the document's validity and declares their agreement and understanding of its contents and recommendations. Panasonic Industrial Devices Europe GmbH (Panasonic) reserves the right to make changes as required at any time without notification. Please consult the most recently issued Module Integration Guide before initiating or completing a design.

© Panasonic Industrial Devices Europe GmbH 2021.

This specification sheet is copyrighted. Reproduction of this document is permissible only if reproduction is without alteration and is accompanied by all associated warranties, conditions, limitations, and notices. Do not disclose it to a third party.

All rights reserved.

This Module Integration Guide does not lodge the claim to be complete and free of mistakes.

Engineering Samples (ES)

If Engineering Samples are delivered to the customer, these samples have the status "Engineering Samples". This means that the design of this product is not yet concluded. Engineering Samples may be partially or fully functional, and they may differ from the published Product Specification.

Engineering Samples are not qualified and they are not to be used for reliability testing or series production.

Disclaimer

The customer acknowledges that samples may deviate from the Module Integration Guide and may bear defects due to their status of development and the lack of qualification mentioned above.

Panasonic rejects any liability or product warranty for Engineering Samples. In particular, Panasonic disclaims liability for damages caused by:

- The use of the Engineering Sample other than for evaluation purposes, particularly the installation or integration in another product to be sold by the customer,
- Deviation or lapse in function of the Engineering Sample,
- Improper use of the Engineering Sample.

Panasonic Industrial Devices Europe GmbH disclaims any liability for consequential and incidental damages. In case of any queries regarding the Engineering Samples, please contact your local sales partner or the related product manager.

The information contained herein is presented only as guidance for Product use. No responsibility is assumed by Panasonic for any infringement of patents or any other intellectual property rights of third parties that may result from the use of Product. No license to any intellectual property right is granted by this document, whether express or implied, by estoppel or otherwise.

Description of hardware, software, and other information in this document is only intended to illustrate the functionality of the referred Panasonic product. It should not be construed as guaranteeing specific functionality of the product as described or suitable for a particular application.

Any provided (source) code shall not be used or incorporated into any products or systems whose manufacture, use or sale is prohibited under any applicable laws or regulations.

Any outlined or referenced (source) code within this document is provided on an "as is" basis without any right to technical support or updates and without warranty of any kind on a free of charge basis according to § 516 German Civil Law (BGB) including without limitation, any warranties or conditions of title, non infringement, merchantability, or fitness for a particular purpose. Customer acknowledges that (source) code may bear defects and errors.

The third-party tools mentioned in this document are offered by independent third-party providers who are solely responsible for these products. Panasonic has no responsibility whatsoever for the performance, product descriptions, specifications, referenced content, or any and all claims or representations of these third-party providers. Panasonic makes no warranty whatsoever, neither express nor implied, with respect to the goods, the referenced contents, or any and all claims or representations of the third-party providers. To the maximum extent allowable by Law Panasonic assumes no liability whatsoever including without limitation, indirect, consequential, special, or incidental damages or loss, including without limitation loss of profits, loss of opportunities, business interruption, and loss of data.

Table of Contents

- 1 About This Document.....6**
 - 1.1 Purpose and Audience6
 - 1.2 Revision History.....6
 - 1.3 Use of Symbols6
 - 1.4 Related Documents7

- 2 Overview.....8**

- 3 PAN9520 Module.....9**
 - 3.1 Block Diagram9
 - 3.2 Footprint10
 - 3.3 Placement.....11

- 4 Power Supply13**

- 5 RF Path14**
 - 5.1 External Antenna14
 - 5.2 RF Trace.....14

- 6 Regulatory and Certification Information16**
 - 6.1 Integration Measures for a Valid Approval.....16
 - 6.2 General Certification Information35
 - 6.3 Federal Communications Commission (FCC) for US35
 - 6.4 Innovation, Science, and Economic Development (ISED) for Canada38
 - 6.5 European Conformity According to RED (2014/53/EU)41

- 7 Restricted Use.....43**
 - 7.1 Life Support Policy.....43
 - 7.2 Restricted End Use.....43

- 8 Contact Details.....44**
 - 8.1 Contact Us.....44
 - 8.2 Product Information44

1 About This Document

1.1 Purpose and Audience

This Module Integration Guide is intended to support the easy integration of the PAN9520 into a product and to ensure the compliance with regulatory requirements.

This guide gives an overview about the hardware design requirements. It is intended for hardware design, application, and Original Equipment Manufacturers (OEM) engineers.



Please read this guide carefully to assure the compliance of your product to regulatory.

The product is referred to as “the PAN9520” or “the module” within this document.

1.2 Revision History

Revision	Date	Modifications/Remarks
1.0	2021-05-31	First version
1.1	2021-06-07	Formal and structure changes. Updated pictures: “Antenna Placement Recommendation”, “Footprint”. Updated chapter “Placement”. Corrected footnote (no. 4): added macros. Updated section “Modulation and Defining Power Limits for each available Channel”: corrected byte “mpwr_cbw20_chan1” into “mpwr_cbw20_chan14”. Updated chapter “Regulatory and Certification Information”.

1.3 Use of Symbols

Symbol	Description
	Note Indicates important information for the proper use of the product. Non-observance can lead to errors.
	Attention Indicates important notes that, if not observed, can put the product’s functionality at risk.
	Tip Indicates useful information designed to facilitate working with the module and software.
⇒ [chapter number] [chapter title]	Cross Reference Indicates cross references within the document. Example: Description of the symbols used in this document ⇒ 1.3 Use of Symbols .
✓	Requirement Indicates a requirement that must be met before the corresponding tasks can be completed.

Symbol	Description
➔	<p>Result</p> <p>Indicates the result of a task or the result of a series of tasks.</p>
This font	<p>GUI Text</p> <p>Indicates fixed terms and text of the graphical user interface.</p> <p>Example:</p> <p>Click Save.</p>
Menu > Menu item	<p>Path</p> <p>Indicates a path, e.g. to access a dialog.</p> <p>Example:</p> <p>In the menu, select File > Setup page.</p>
This font	<p>File Names, Messages, User Input</p> <p>Indicates file names or messages and information displayed on the screen or to be selected or entered by the user.</p> <p>Examples:</p> <p>pan1760.c contains the actual module initialization.</p> <p>The message Failed to save your data is displayed.</p> <p>Enter the value Product 123.</p>
Key	<p>Key</p> <p>Indicates a key on the keyboard, e.g. F10.</p>

1.4 Related Documents

For related documents please refer to the Panasonic website ⇒ [8.2 Product Information](#).

2 Overview

The PAN9520 is a 2.4 GHz 802.11 b/g/n embedded Wi-Fi module based on Espressif's ESP32-S2 that includes the powerful Xtensa 32-bit LX7 CPU. An integrated chip antenna and QSPI memory enable the module to be used in a variety of stand-alone or host-controlled applications. The integrated crystal ensures connection performance over full temperature range and lifetime. The integrated crystal ensures connection performance over full temperature range and lifetime. Although the PAN9520 is one of the smallest modules on the market, this offers a rich set of peripherals like full-speed USB OTG, SPI, UART, I²C, and many more¹.

The PAN9520 combines a high-performance CPU, high-sensitivity wireless radio, baseband (BB) processor, Medium Access Controller (MAC), encryption unit, ROM bootloader, chip-internal SRAM, and module-internal QSPI flash and PSRAM. Features as CCMP, TKIP, WAPI, WEP, BIP, and an AES² accelerator enable the usage of secure data connections.

Parallel support of access point and station mode allows easy setup of simultaneous Wi-Fi connections from the module to smart devices and home network routers.

With the Espressif Integrated Development Framework (ESP-IDF), software can be developed for a wide range of applications. At the same time, a huge number of software examples can be used as starting point for the development.



Please note that the ESP-IDF is provided by Espressif Systems. Always use the latest updates <https://github.com/espressif/esp-idf>.

For related documents please refer to ⇒ [8.2 Product Information](#).

¹ Compared to modules offering similar feature sets.

² Counter Mode with CBC-MAC Protocol (CCMP); Temporary Key Integrity Protocol (TKIP); WLAN Authentication and Privacy Infrastructure (WAPI); Wired Equivalent Privacy (WEP); Broadcast/Multitask Integrity Protocol (BIP); Advanced Encryption Standard (AES)

3 PAN9520 Module

3.1 Block Diagram

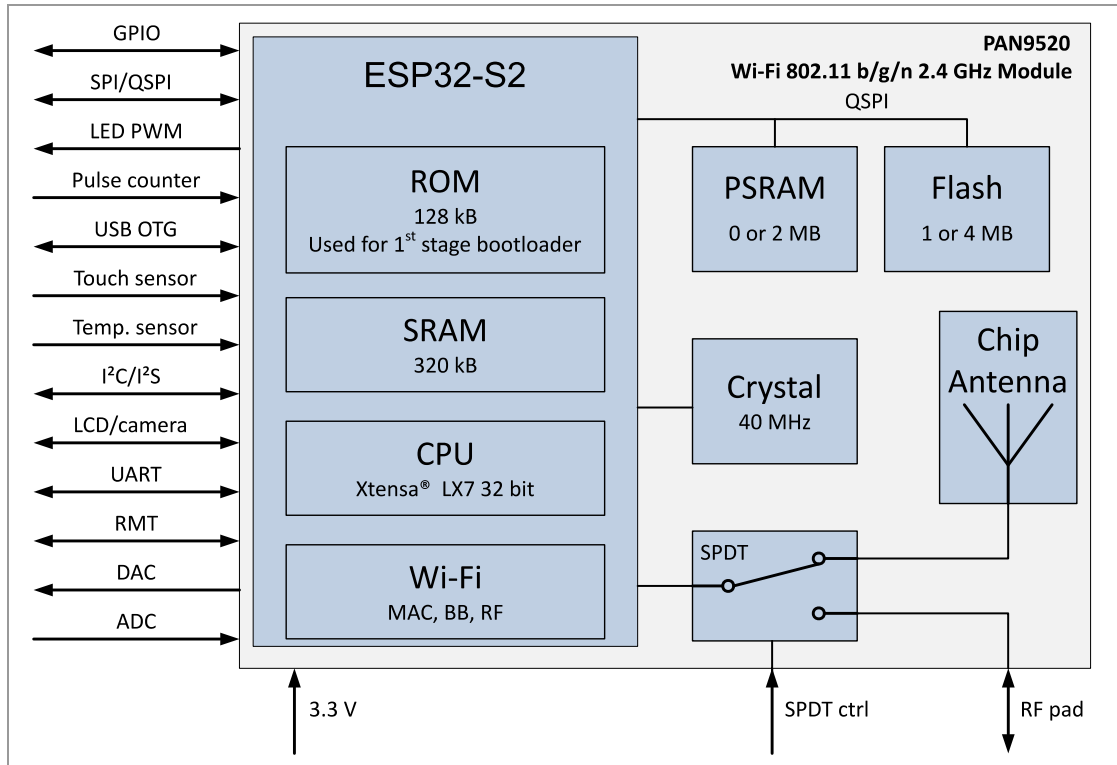

3.2 Footprint

 The outer dimensions have a tolerance of ± 0.35 mm.

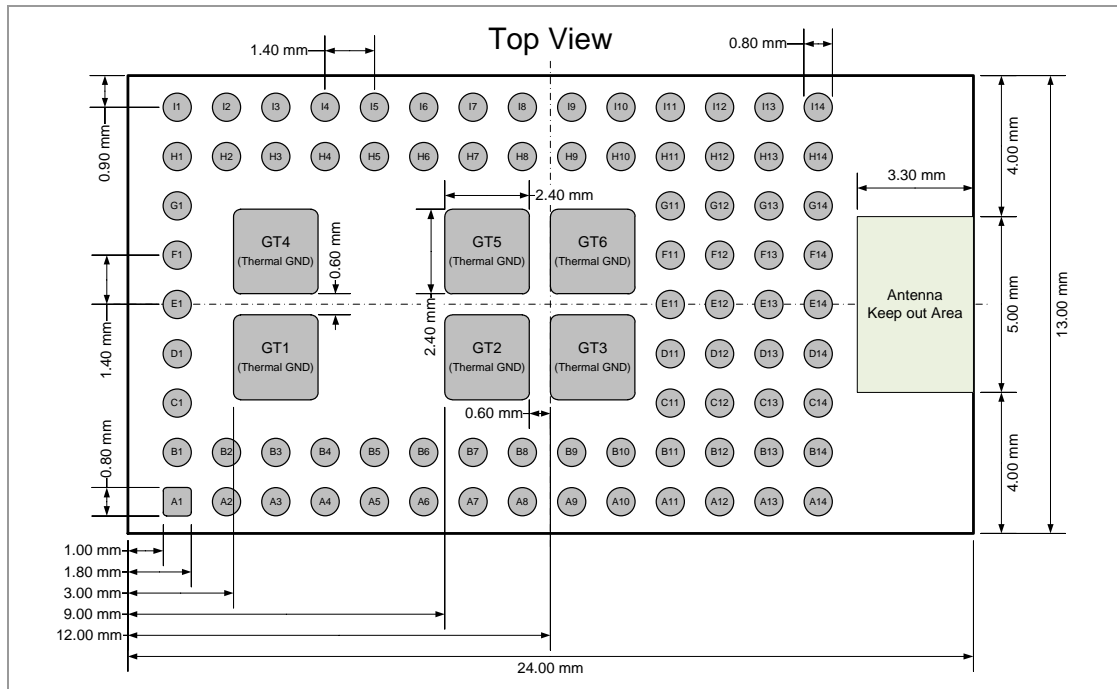

3.3 Placement



Antenna “Keep out Area”

Do not place any ground plane under the marked restricted antenna area in any layer! This would be affecting the performance of the chip antenna in a critical manner.



Impact of Placement on the Antenna Radiation Pattern

The placement of the module, surrounding material, and customer components has an impact on the radiation pattern of the antenna.



The recommendation for the ground plane is based on a FR4 4-Layer PCB.

The following requirements must be met:

- ✓ The supply voltage is free of AC ripple voltage (for example from a battery or a low noise regulator output). For noisy supply voltages, provide a decoupling circuit (for example a ferrite in series connection and a bypass capacitor to ground of at least 47 μ F directly at the module).
- ✓ Do not stress the module mechanically when installed.
- ✓ Keep this module away from heat. Heat is the major cause of decreasing the life time of these modules.
- ✓ Avoid assembly and use of the target equipment in conditions where the module temperature may exceed the maximum tolerance.
- ✓ Keep this module away from other high frequency circuits.
- ✓ Refer to the recommended pattern when designing a board.

The antenna requires a cutout area of 5 mm × 3.3 mm under the PAN9520 module. This “Keep out Area” shall be located in every layer under the module antenna. Note for example the “Keep out Area” in all four layers of the PAN9520 evaluation board.

It is recommended to verify the perfect position of the module in the target application before fixing the design.

Antenna Placement Recommendation



Use a ground plane in the area surrounding the module wherever possible.



All dimensions are in millimeters.

It is recommended to:

- Place the module in the center (horizontal) of mother PCB.
- Place the module at the edge (horizontal) of mother PCB with the antenna pointing towards the outside.
- Extend the “Keep out Area” towards the mother PCB’s edge, if needed.

Antenna Placement Recommendation (Top View)

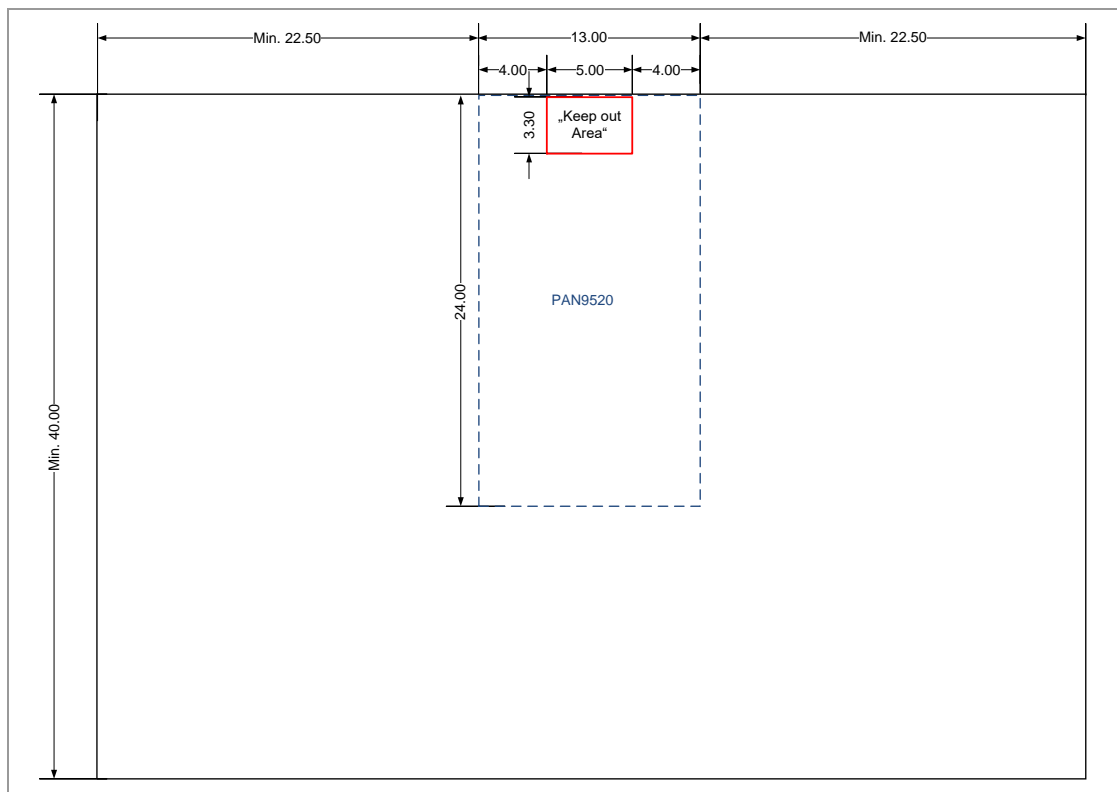

4 Power Supply

The following conditions must be met:

- ✓ The supply voltage is free of AC ripple voltage (for example from a battery or a low noise regulator output). On the PAN9520 ETU, 10 μ F decoupling capacitors on each supply terminal are used for this purpose. If there is much noise on the power delivery network, a filter network can be used instead.
- ✓ Decoupling capacitors/networks are placed close to the module to reduce inductive effects.
- ✓ The supply voltage is not exceedingly high or reversed. It should not carry noise and/or spikes.

Power Terminals

There are three power terminals on the PAN9520. All are connected to the same 3.3 V power net on the module.

Although the module could be powered via one terminal only, it is recommended to use all terminals for distributing the currents. This will lead to a smaller voltage drop and thus a better power integrity. Moreover, the supply's return currents will also be distributed, which reduces the galvanic coupling from the power net to signals and vice versa.

Power Terminals (red marked)

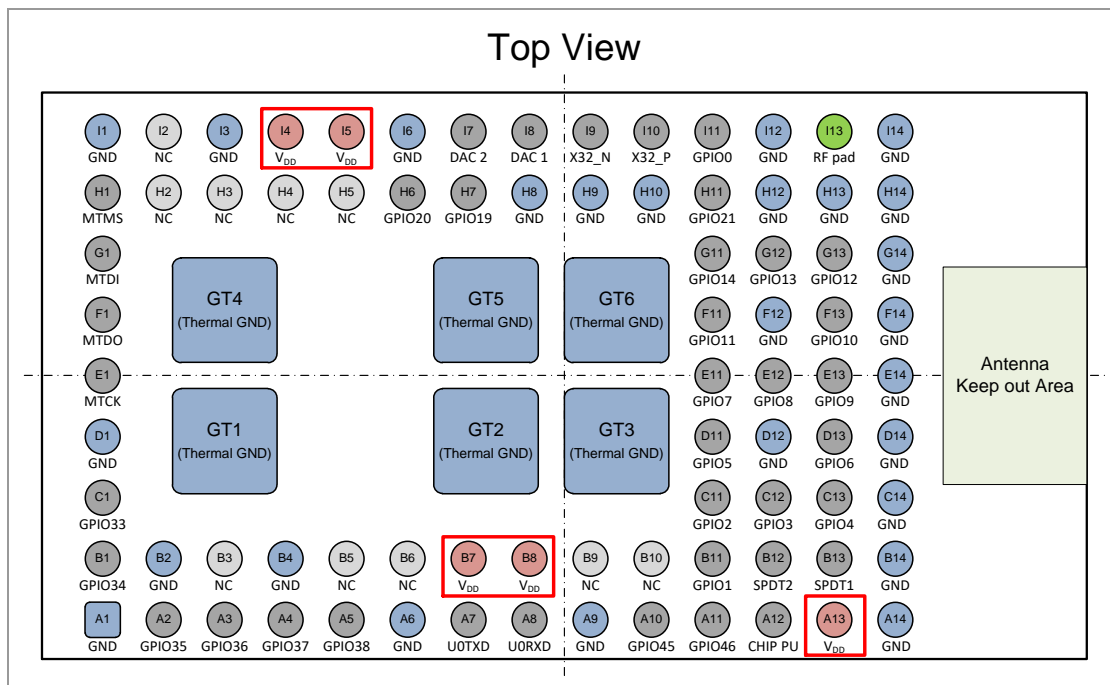

5 RF Path

5.1 External Antenna



Antenna Warning

The modular approval of the PAN9520 is only valid if the on-board antenna is used. Other antennas have not been certified. OEMs must test the compliance of the product by themselves, if other antennas are used in the end product.

The PAN9520 has a 50 Ω RF pin (SMD pad). Connect an external antenna directly or via a connector (e.g. U.FL) with RF trace to this RF pin. This RF trace shall be matched to 50 Ω ⇒ [5.2 RF Trace](#).

5.2 RF Trace

Ensure that the RF trace's impedance is close to 50 Ω . It is recommended to use a Coplanar Waveguide with Ground (CPWG) as RF trace. The impedance is related to the trace width, the distances of the trace to the ground layers and the material of the PCB.

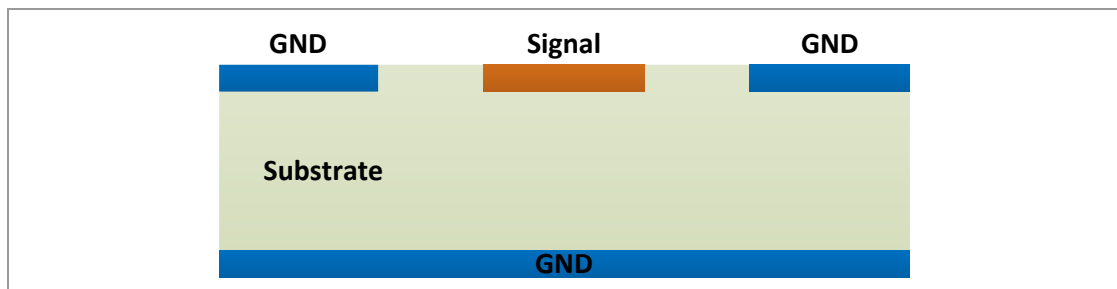

The following design recommendation must be met:

- ✓ The trace impedance is 50 Ω .
- ✓ The trace length is not exceeding 2 cm.
- ✓ The Via fence is around the trace.
- ✓ No other lines are crossed (power supply, interfaces, or clock traces)

Example RF Trace of the PAN9520 ETU

On the PAN9520 ETU (ENW49D01AZKF), the module's RF pad is connected to an U.F.L. connector. As an example, this RF trace is described in the following. The trace is shown in the figure below (red marked). It can be observed that it is surrounded by a via fence as recommended.

A critical point is the transition from the module to the mother PCB. Further simulations of the transition and the RF paths help to determine e.g. the positions of ground vias around the RF pad.

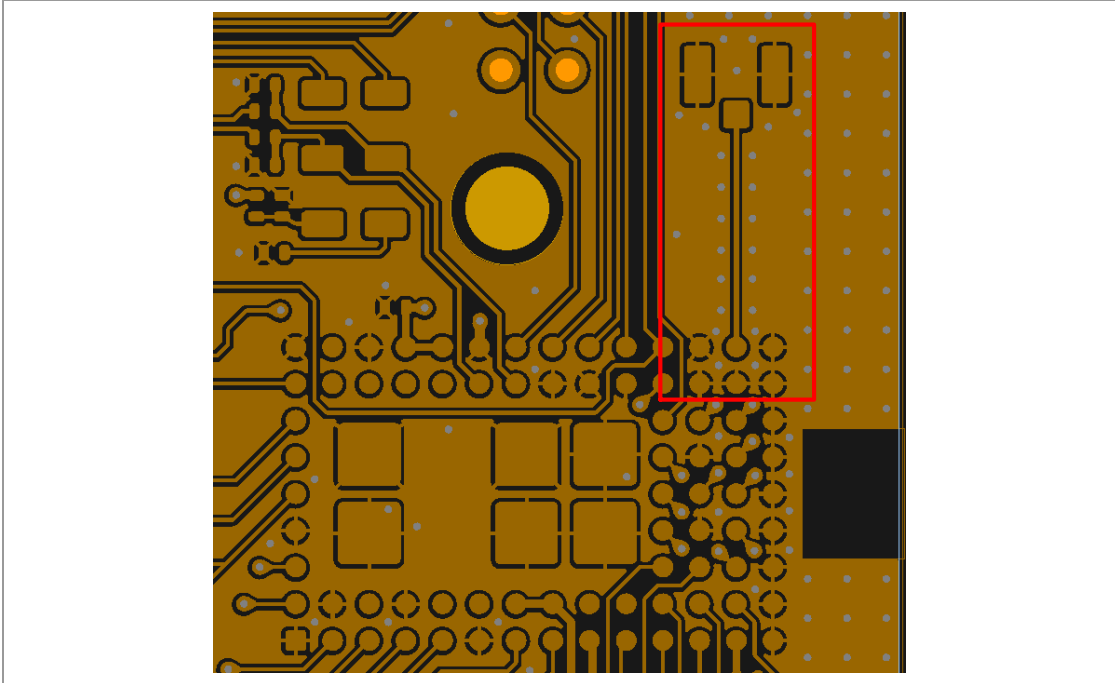

Dimensions of the used RF path:

- Trace width $W = 178 \mu\text{m}$
- Gap to GND $G = 156 \mu\text{m}$
- Copper thickness $TH = 35 \mu\text{m}$
- Height of substrate $H = 127 \mu\text{m}$
- Relative permittivity $\epsilon_r = 4.2$
- Loss tangent $\tan \delta = 0.021$

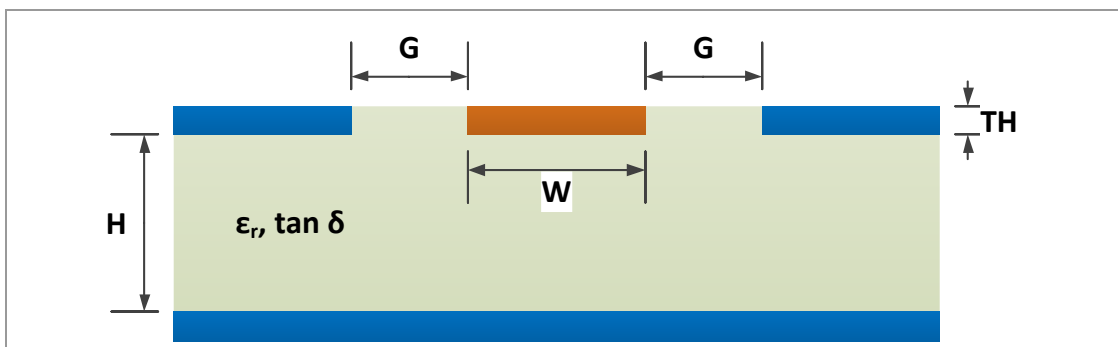

6 Regulatory and Certification Information

6.1 Integration Measures for a Valid Approval

The modular approval of the PAN9520 is only valid if the OEM satisfies several requirements. These affect mainly the output power and the limitation of the operating channel range.

This section describes how both can be controlled and what are the measures for a valid modular approval.



The PAN9520 is distributed without software and to OEMs only. The OEM is responsible for using a software that complies with the local regulations.

PAN9520 evaluation tools must be distributed to OEMs only.

6.1.1 Limiting the Channel Range and Setting the Country Code

The range of channels, on which the PAN9520 can operate, has to be limited according to the location of the module (or end product). The modular approval is only valid, if the OEM applies the needed limitations in the developed software.

This section describes how the required limitations can be implemented.



Depending on the region the PAN9520 is operating in, the range of channels must be limited accordingly. The OEM is responsible for implementing a software that fulfills this requirement.

Channels must be limited to following ranges:

- FCC (USA): Channels 1 to 11
- IC (Canada): Channels 1 to 11
- RED (EU): Channels 1 to 13



The country code and channel limitations must not be changeable in the end product/application.

6.1.1.1 Country Code Setting with ESP-IDF

The Espressif Integrated Development Framework (ESP-IDF) is the official software development kit (SDK) for the ESP32-S2 IC used on the PAN9520. This contains the function `esp_wifi_set_country` that can be used for setting the country code and limiting the channel range. The function returns an error code of type `esp_err_t`. A pointer to a variable of type `wifi_country_t` is needed as input. When the function is called, the settings of the linked input variable (`*country`) are stored to the module's flash memory.

```
esp_err_t esp_wifi_set_country(const wifi_country_t * country)
```

The linked variable (type `wifi_country_t`) is a structure that contains all needed settings, which are listed below.

For further details please refer to https://docs.espressif.com/projects/esp-idf/en/v4.2/esp32s2/api-reference/network/esp_wifi.html?highlight=esp_wifi_set_country#_CPPv420esp_wifi_set_countryPK14wifi_country_t.

Structure of Type “wifi_country_t”

Name	Type	Example Settings	Description
<code>cc</code> ³	<code>char array</code> (3 bytes)	<code>cc[0-2] = ['D', 'E', ' ']</code> <code>cc[0-2] = ['U', 'S', ' ']</code> <code>cc[0-2] = ['C', 'A', ' ']</code> <code>cc[0-2] = ['E', 'U', ' ']</code>	This array of three characters contains the two-digit country code (ISO/IEC3166-1) and an environmental setting (byte 3). Example codes are given for Germany (DE), USA (US), Canada (CA), and the European Union (EU).
<code>schan</code>	<code>uint8_t</code>	1	Index of first channel of the allowed range.
<code>nchan</code>	<code>uint8_t</code>	11	Number of channels in the allowed range. The index of the last channel in the range is <code>schan + nchan - 1</code>
<code>max_tx_power</code>	<code>int8_t</code>	56	Maximum Tx power in steps of 0.25 dBm (valid values 8 to 78 \pm 2 to 19.5 dBm)
<code>policy</code> ⁴	<code>wifi_country_policy_t</code>	<code>WIFI_COUNTRY_POLICY_MANUAL</code>	Setting, if the configured country code is always used, or if the module adapts to the AP configuration (if it is station). Details are given in the following.

³ Entries “0” and “1” contain the alpha-2 country code specified by ISO3166. For a list of codes please refer to <https://www.iso.org/obp/ui/#search/code/>. Please note that there are also reserved codes that do not represent a country but are valid as well. An example is “EU” for the European union.

⁴ The setting “policy” is of another custom datatype `wifi_country_policy_t`. Variables of this type are enumerations with two valid numbers. The numbers are represented by following macros: `WIFI_COUNTRY_POLICY_AUTO` and `WIFI_COUNTRY_POLICY_MANUAL`.

WIFI_COUNTRY_POLICY_AUTO

If the PAN9520 is configured as station, the used country code setting is adapted to the one of the access point (AP), to which the station is connected.



Please note that not only the country code itself is changed, but also the channel range.

After the station has been disconnected from the AP, the country code setting is reset to the configured one.

If the module is in station mode, not connected to an AP and performs a scan, this scans actively on channels $schan$ to $\min\{schan + nchan - 1, 11\}$ of the configured country code setting. The remaining channels $schan + nchan$ to 14 (or 12 to 14 if $schan + nchan \geq 12$) are scanned passively. This ensures that regulations are not violated, even if the configured country code does not match the location of the device.



Please note that hidden SSIDs on channels 12 to 14 can never be found, if `WIFI_COUNTRY_POLICY_AUTO` is used.

If the module is in station mode, connected to an AP and performs a scan, the module uses the country code settings of the AP. Hence, an active scan is performed on $schan$ to $(schan + nchan - 1)$ of the AP's country code settings and a passive scan is performed on the remaining channels.

If the module is set to station/AP coexistence mode, the configured country code settings are used if the device has not been connected to another AP. If the device is connected to another AP, the country code settings of the AP are used (also for the module's AP).

If the module is configured as AP, this setting has no effect and the configured country code settings are always used.

For further details please refer to <https://docs.espressif.com/projects/esp-idf/en/v4.2/esp32/api-guides/wifi.html#wi-fi-country-code>.

WIFI_COUNTRY_POLICY_MANUAL

If the setting `WIFI_COUNTRY_POLICY_MANUAL` is used, the configured country code settings are used in any case. Only channels in the valid range can be scanned actively.

For further details please refer to <https://docs.espressif.com/projects/esp-idf/en/v4.2/esp32/api-guides/wifi.html#wi-fi-country-code>.

Example 1 (US, Manual Policy)

If the module shall be e.g. only operated in the USA, the country code could be set accordingly and the policy setting can be set to `WIFI_COUNTRY_POLICY_MANUAL` for ensuring that the device cannot operate on prohibited channels in any case. A related application could be a product that operates as AP and is sold in the US. Related example C code is given below.

```
#include "exmpl_error_check.h"
#include "esp_wifi.h"

esp_err_t error_code;
wifi_country_t cc_us_manual = {'U', 'S', ' '}, 1, 11, 78, WIFI_COUNTRY_POLICY_MANUAL};
wifi_country_t* cc_us_manual_pt = &cc_us_manual;

error_code = wifi_set_country(cc_us_manual_pt);

check_error_code(error_code);
```

Example 2 (EU, Automatic Policy)

In this example, the country code is set to EU and channels “1” to “13” are enabled. The maximum output power is limited to 16 dBm (⇒ [6.1.2 Limiting the Output Power](#)) and the policy is set to `WIFI_COUNTRY_POLICY_AUTO`. This could be applicable for a product that acts as station and is sold in the EU. If the device is operated in a non-EU region, the country code will be adapted to the one of local APs. If the device is not connected to any AP, active scans will be only performed on channels “1” to “11”. Channels “12” to “14” are scanned passively.

```
#include "exmpl_error_check.h"
#include "esp_wifi.h"

esp_err_t error_code;
wifi_country_t cc_eu_auto = {'E', 'U', ' '}, 1, 13, 64, WIFI_COUNTRY_POLICY_AUTO};
wifi_country_t* cc_eu_auto_pt = &cc_eu_auto;

error_code = wifi_set_country(cc_eu_auto_pt);

check_error_code(error_code);
```



Further Readings

“Wi-Fi Country Code” general description: <https://docs.espressif.com/projects/esp-idf/en/v4.2/esp32/api-guides/wifi.html#wi-fi-country-code>

Function “esp_wifi_set_country”: https://docs.espressif.com/projects/esp-idf/en/v4.2/esp32/api-reference/network/esp_wifi.html# CPPv420esp_wifi_set_countryPK14wifi_country_t

Data type “wifi_country_t”: https://docs.espressif.com/projects/esp-idf/en/v4.2/esp32/api-reference/network/esp_wifi.html# CPPv414wifi_country_t

6.1.1.2 Country Code Setting with ESP32-S2 AT Firmware

Instead of developing an embedded software for the PAN9520, an AT firmware provided by Espressif can be used. This is based on the ESP-IDF and is available as source code or precompiled binary.

This section explains how the country code settings can be applied if the AT firmware is used.

There are two commands related to the country code setting. These are `AT+CWCOUNTRY?`, which will query the current country code information, and `AT+CWCOUNTRY`, which will set the country code configuration and store it into flash. The input parameters are similar to those, used in ESP-IDF (⇒ 6.1.1.1 Country Code Setting with ESP-IDF) and are only explained briefly in the following.

```
AT+ CWCOUNTRY=<country_policy>,<country_code>,<start_channel>,<total_channel_count>
Function: Sets the Wi-Fi country code information.
```

For further details, please refer to https://docs.espressif.com/projects/esp-at/en/release-v2.1.0.0_esp32s2/AT_Command_Set/Wi-Fi_AT_Commands.html#at-cwcountry-configures-the-wi-fi-country-code.

country_policy

0: Identical to `WIFI_COUNTRY_POLICY_AUTO` option in ESP-IDF

1: Identical to `WIFI_COUNTRY_POLICY_MANUAL` option in ESP-IDF

country_code

String of variable length (maximum 3) containing the country code. Please note that quotation marks must be used to identify the parameter as string. Similar to `cc[0-2]` in ESP-IDF.

start_channel

Index of first channel allowed to use. Identical to `schan` in ESP-IDF.

total_channel_count

Number of channels that can be used. The index of the last channel is `start_channel + total_channel_count - 1`. Identical to `nchan` in ESP-IDF.

Example (Canada, Manual Policy)

This example illustrates the configuration via AT commands. The country code has been chosen to be CA for Canada and the range of allowed channels are set to “1” to “11” accordingly. The device shall always use the configured country code settings, which causes the parameter `country_policy` to be one.

Related Serial Communication

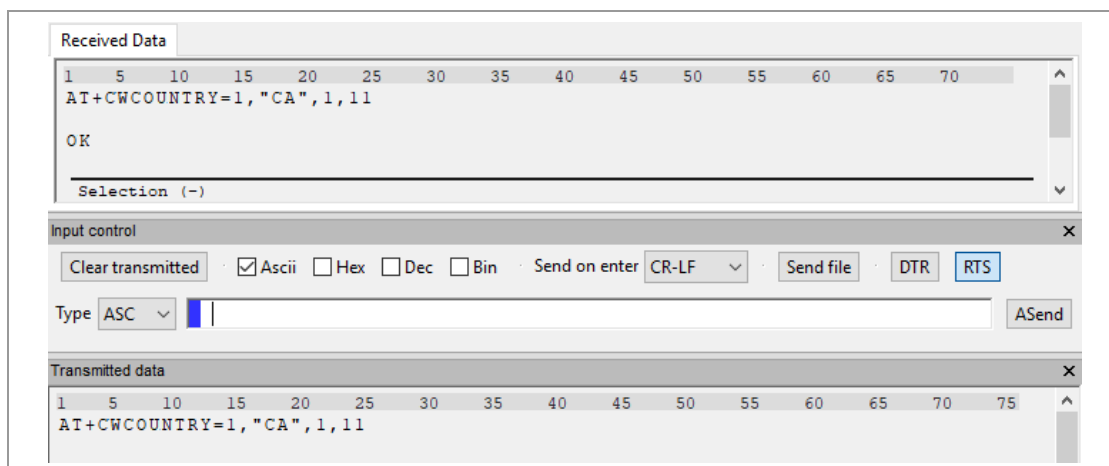

Further Readings

AT command description: https://docs.espressif.com/projects/esp-at/en/release-v2.1.0.0_esp32s2/AT_Command_Set/Wi-Fi_AT_Commands.html#at-cwcountry-configures-the-wi-fi-country-code

6.1.2 Limiting the Output Power



Please note that the power limits documented in this chapter must not be exceeded in the end product to keep the modular approval valid. Examples that fulfill this requirement are documented in the following sections.



Please note that it is not recommended to use functions like `esp_wifi_set_max_tx_power`, because the device could transmit with restricted output power settings before the function is called.

For a valid modular approval, the radiated power must not exceed certain limits. These are summarized as follows:

RED (Europe)

Standard	Affected Channels	Power Limit
802.11b	1 to 13	14 dBm
802.11g & 802.11n	1 to 13 (20 MHz) 3 to 11 (40 MHz)	16 dBm

FCC (USA) and IC (Canada)

Standard	Affected Channels	Power Limit
802.11b	1 to 11	18 dBm
802.11g & 802.11n	3 to 9 (20 MHz)	16 dBm
802.11g & 802.11n	1, 2, 10, and 11 (20 MHz)	13 dBm
802.11n	All 40 MHz channels	11 dBm

All limits have been determined using the module's integrated chip antenna. To limit the power, there are several options that are explained in this section. These are:

- Using a `phy_init_data` binary (stored into a correlated partition) to limit the power for each channel and modulation (ESP-IDF and AT firmware) ⇒ [6.1.2.1 Using “phy_init_data” Binary](#).
- Editing and using the `phy_init_data` implemented in the user application's source code (ESP-IDF) ⇒ [6.1.2.2 Editing “Phy Init Data” in the Source Code](#).

6.1.2.1 Using “phy_init_data” Binary

The physical (PHY) layer is controlled by a “phy init data” set. This can be defined in the application source code or it can be stored into a separate partition of the module's Flash memory.

This section explains

- how the data is composed,
- how it can be stored, and
- how the user application can be configured to use the data stored in the partition.

Binaries for applying settings that comply with the RED or FCC/IC regulations are provided by Panasonic. The data can be flashed and is used by the hardware if a related partition is reserved in the partition table and the setting

`CONFIG_ESP32_PHY_INIT_DATA_IN_PARTITION` in the project configurations is set to “y”.

“Phy Init Data” Structure

The data is composed of 128 bytes that configure the device's PHY layer. The data that is flashed into the corresponding partition contains 16 bytes more (8 bytes at the beginning and 8 bytes at the end). Byte positions stated in this section are relative to start of the stored data (binary data). Six power values can be stored and used for configuration. Power settings can be defined for different data rates (standards and modulations). Additionally, the maximum power can be configured for each channel.

The process for configuring/editing “phy init data” consists mainly of three steps:

1. Defining six power values,
2. Setting up the power levels for each available standard, and
3. Modulation and defining power limits for each available channel.

Example Process Configuring/Editing “phy init data”

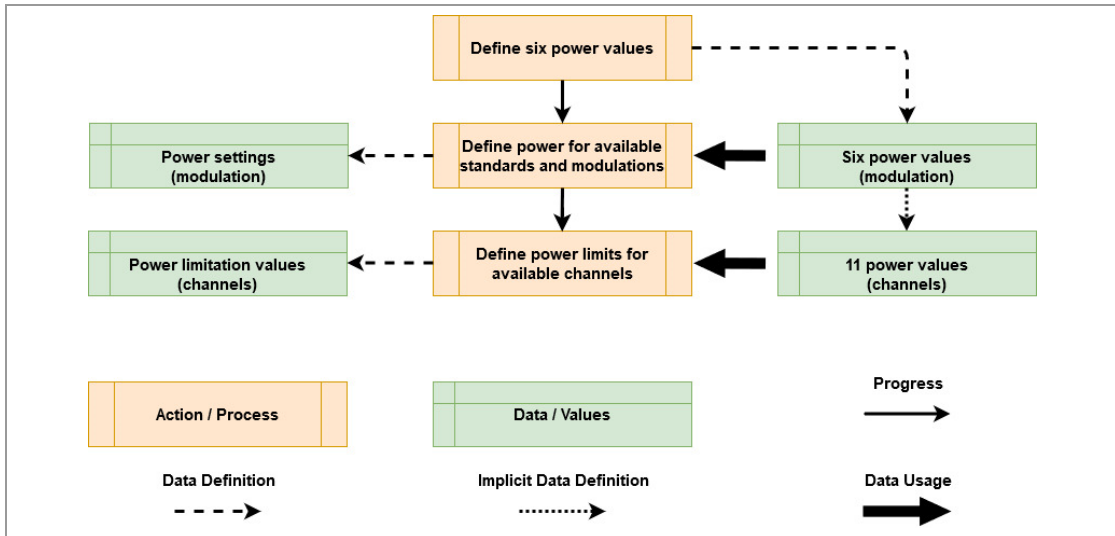

Defining six Power Values

Beginning with the first step of the example configuration process, six power values are defined. They are stored in bytes “52” to “57” (“0x34” to “0x39”) of the binary data and are called `txpwr_qdb_0` to `txpwr_qdb_5`. A value written to such a byte correlates to $4 \times [\text{power in dBm}]$.

Values of the recommended Binary Files (for RED and FCC/IC).

Name	Byte Position in Binary	Value		Resulting Power	
		RED	FCC/IC	RED	FCC/IC
<code>txpwr_qdb_0</code>	52 (0x34)	56 (0x38)	72 (0x48)	14 dBm	18 dBm
<code>txpwr_qdb_1</code>	53 (0x35)	64 (0x40)	64 (0x40)	16 dBm	16 dBm
<code>txpwr_qdb_2</code>	54 (0x36)	60 (0x3C)	60 (0x3C)	15 dBm	15 dBm
<code>txpwr_qdb_3</code>	55 (0x37)	56 (0x38)	56 (0x38)	14 dBm	14 dBm
<code>txpwr_qdb_4</code>	56 (0x38)	56 (0x38)	52 (0x34)	14 dBm	13 dBm
<code>txpwr_qdb_5</code>	57 (0x39)	52 (0x34)	48 (0x30)	13 dBm	12 dBm

Configuring the values `txpwr_qdb_0` to `txpwr_qdb_5` also defines 11 imaginary power levels. These are called TX Power Limit and depend on the defined values as follows.

Values of “TX Power Limit”

Name	Power (in dBm) depending on defined Values	Resulting Power	
		RED	FCC/IC
TX Power Limit 0	txpwr_qdb_0 / 4	14 dBm	18 dBm
TX Power Limit 1	txpwr_qdb_1 / 4	16 dBm	16 dBm
TX Power Limit 2	txpwr_qdb_2 / 4	15 dBm	15 dBm
TX Power Limit 3	txpwr_qdb_3 / 4	14 dBm	14 dBm
TX Power Limit 4	txpwr_qdb_4 / 4	14 dBm	13 dBm
TX Power Limit 5	txpwr_qdb_5 / 4	13 dBm	12 dBm
TX Power Limit 6	(txpwr_qdb_5 / 4) - 1	12 dBm	11 dBm
TX Power Limit 7	(txpwr_qdb_5 / 4) - 2	11 dBm	10 dBm
TX Power Limit 8	(txpwr_qdb_5 / 4) - 3	10 dBm	9 dBm
TX Power Limit 9	(txpwr_qdb_5 / 4) - 4	9 dBm	8 dBm
TX Power Limit 10	(txpwr_qdb_5 / 4) - 5	8 dBm	7 dBm

Setting up the Power Levels for each available Standard

The second configuration step defines power levels for each standard and modulation, whereas the modulation of standard b and standard g is defined by the related data rates. There are 11 bytes for applying the configuration with some configurations merged to one byte. Bytes `txpwr_index_0` to `txpwr_index_7` are stored at byte positions “58” to “65” and correspond to standard 802.11g and standard 802.11n. The power is defined by the index of the desired power value `txpwr_gdb`.

For configuring the power levels of standard 802.11b, there are two possibilities:

- Set byte `txpwr_index_11b_en` at byte position “66” to zero. This makes `txpwr_qdb_0` to be used for all 802.11b data rates.
- Set byte `txpwr_index_11b_en` to one. `txpwr_index_11b_0` and `txpwr_index_11b_1` define the maximum power levels.

Configurations that fulfill the requirements for a valid modular approval are given in the following table. The configuration requires the power values to be configured as described in

⇒ [6.1.2 Limiting the Output Power](#).

Configurations

Name	Byte Position in Binary	Affected Data Rate/MCS	txpwr_qdb Index		Resulting Power	
			RED	FCC/IC	RED	FCC/IC
txpwr_index_0	58 (0x3A)	11g: 6 Mbit/s & 9 Mbit/s 11n: MCS 0	0x01	0x01	16 dBm	16 dBm
txpwr_index_1	59 (0x3B)	11g: 12 Mbit/s 11n: MCS 1	0x01	0x01	16 dBm	16 dBm
txpwr_index_2	60 (0x3C)	11g: 18 Mbit/s 11n: MCS 2	0x01	0x01	16 dBm	16 dBm
txpwr_index_3	61 (0x3D)	11g: 24 Mbit/s 11n: MCS 3	0x01	0x01	16 dBm	16 dBm
txpwr_index_4	62 (0x3E)	11g: 36 Mbit/s 11n: MCS 4	0x01	0x01	16 dBm	16 dBm
txpwr_index_5	63 (0x3F)	11g: 48 Mbit/s 11n: MCS 5	0x02	0x02	15 dBm	15 dBm
txpwr_index_6	64 (0x40)	11g: 54 Mbit/s 11n: MCS 6	0x03	0x03	14 dBm	14 dBm
txpwr_index_7	65 (0x41)	11n: MCS 7	0x05	0x04	13 dBm	13 dBm
txpwr_index_11b_en ⁵	66 (0x42)	11b	0x00	0x00	14 dBm	18 dBm
txpwr_index_11b_0 ⁵	67 (0x43)	11b: 1 Mbit/s & 2 Mbit/s	0x00	0x00	N/A	N/A
txpwr_index_11b_1 ⁵	68 (0x44)	11b: 5.5 Mbit/s & 11 Mbit/s	0x00	0x00	N/A	N/A

Modulation and Defining Power Limits for each available Channel

The third configuration step defines power limits for each channel. If the power configured for a certain standard and modulation exceeds the limit of the current channel, the power is reduced to the one of the limit. The first byte (at position “69”) of this configuration (`fcc_enable`) determines if the limits are applied. If the byte’s value is “0”, settings made in bytes `mpwr_cbw20_chan1` to `mpwr_cbw40_chan11` are ignored. In contrast, they are applied, if `fcc_enable` is “2”.

Bytes `mpwr_cbw20_chan1` to `mpwr_cbw20_chan14` are stored at byte positions “70” to “83” and configure the power limits for the 20 MHz channels.

⁵ `txpwr_index_11b_en` determines, if `txpwr_qdb_0` is used for all 11b data rates (value = 0), or if configurations `txpwr_index_11b_0` and `txpwr_index_11b_1` are used (value = 1).

Each of these bytes is separated into two nibbles: bit[3:0] (low nibble) and bit[7:4] (high nibble). The low nibble configures the limit for standard 802.11g and standard 802.11n. The high nibble configures the limit for standard 802.11b. By selecting the index of the desired TX Power Limit for a nibble, the configuration is made.

The limits of the 40 MHz channels are configured by bytes mpwr_cbw40_chan3_4 to mpwr_cbw40_chan11. Because 40 MHz channels can be only used with the standard 802.11n, the bytes' nibbles do not correspond to standards. Instead, each nibble is used for one channel. Thus, each configuration byte contains the setting for two channels. The low nibble (bit[3:0]) configures the lower channel and the high nibble (bit[7:4]) configures the higher channel.

An example configuration that complies with the FCC/IC regulations is given in the table below (for RED channels limits are not needed). Unused channels have been configured with the lowest TX Power Limit value.



Because byte nibbles are used for configuration, the hexadecimal representation is quite convenient. Each nibble is represented by a digit in the range "0x0" to "0xA" ("0" to "10" in decimal system).

Configuration (complied with FCC/IC)

Name	Byte Position in Binary	Notes	TX Power Limit Index		Resulting Power
			RED	FCC/IC	
fcc_enable	69 (0x45)	0: Disable limits 1: N/A 2: Enable limits	0x00	0x02	Power limits are enabled
mpwr_cbw20_chan1	70 (0x46)	Bit[3:0]: 11g/n Bit[7:4]: 11b	N/A	0x04	11g/n: 13 dBm 11b: 18 dBm
mpwr_cbw20_chan2	71 (0x47)	Bit[3:0]: 11g/n Bit[7:4]: 11b	N/A	0x04	
mpwr_cbw20_chan3	72 (0x48)	Bit[3:0]: 11g/n Bit[7:4]: 11b	N/A	0x01	11g/n: 16 dBm 11b: 18 dBm
mpwr_cbw20_chan4	73 (0x49)	Bit[3:0]: 11g/n Bit[7:4]: 11b	N/A	0x01	
mpwr_cbw20_chan5	74 (0x4A)	Bit[3:0]: 11g/n Bit[7:4]: 11b	N/A	0x01	
mpwr_cbw20_chan6	75 (0x4B)	Bit[3:0]: 11g/n Bit[7:4]: 11b	N/A	0x01	
mpwr_cbw20_chan7	76 (0x4C)	Bit[3:0]: 11g/n Bit[7:4]: 11b	N/A	0x01	
mpwr_cbw20_chan8	77 (0x4D)	Bit[3:0]: 11g/n Bit[7:4]: 11b	N/A	0x01	

Name	Byte Position in Binary	Notes	TX Power Limit Index		Resulting Power
			RED	FCC/IC	
mpwr_cbw20_chan9	78 (0x4E)	Bit[3:0]: 11g/n Bit[7:4]: 11b	N/A	0x01	
mpwr_cbw20_chan10	79 (0x4F)	Bit[3:0]: 11g/n Bit[7:4]: 11b	N/A	0x04	11g/n: 13 dBm 11b: 18 dBm
mpwr_cbw20_chan11	80 (0x50)	Bit[3:0]: 11g/n Bit[7:4]: 11b	N/A	0x04	
mpwr_cbw20_chan12	81 (0x51)	Bit[3:0]: 11g/n Bit[7:4]: 11b	N/A	0xAA	11g/n: 7 dBm 11b: 7 dBm
mpwr_cbw20_chan13	82 (0x52)	Bit[3:0]: 11g/n Bit[7:4]: 11b	N/A	0xAA	
mpwr_cbw20_chan14	83 (0x53)	Bit[3:0]: 11g/n Bit[7:4]: 11b	N/A	0xAA	
mpwr_cbw40_chan3_4	84 (0x54)	Bit[3:0]: ch 3 Bit[7:4]: ch 4	N/A	0x66	Ch 3: 11 dBm Ch 4: 11 dBm
mpwr_cbw40_chan5_6	85 (0x55)	Bit[3:0]: ch 5 Bit[7:4]: ch 6	N/A	0x66	Ch5: 11 dBm Ch6: 11 dBm
mpwr_cbw40_chan7_8	86 (0x56)	Bit[3:0]: ch 7 Bit[7:4]: ch 8	N/A	0x66	Ch7: 11 dBm Ch8: 11 dBm
mpwr_cbw40_chan9_10	87 (0x57)	Bit[3:0]: ch 9 Bit[7:4]: ch 10	N/A	0xA6	Ch9: 16 dBm Ch10: 7 dBm
mpwr_cbw40_chan11	88 (0x58)	Bit[3:0]: ch 11 Bit[7:4]: N/A	N/A	0xAA	Ch11: 7 dBm

Editing Binary Files

It is recommended to use the binary files provided by Panasonic. The files can be edited as long as they do not exceed the limits given at the beginning in ⇒ [6.1.2 Country Code Setting with ESP32-S2 AT Firmware](#). Therefore, it is recommended to use an editor that can represent the binary data as hexadecimal values (e.g. “HxD”).

Enabling the Usage of a “Phy Init Data” Binary

Per default the PAN9520 will use the “phy init data” defined by the source code. If a binary file shall be used, a setting must be applied in the project configuration before the project is compiled.

1. Enter the command `idf.py menuconfig` in the ESP-IDF command line tool to open the menu.

2. Click **Component config > PHY** to apply the setting.

```

ESP-IDF PowerShell
(Top) → Component config → PHY
Espressif IoT Development Framework Configuration
[*] Use a partition to store PHY init data --->
(20) Max WiFi TX power (dBm)

[Space/Enter] Toggle/enter  [ESC] Leave menu          [S] Save
[O] Load                [?] Symbol info          [/] Jump to symbol
[F] Toggle show-help mode [C] Toggle show-name mode [A] Toggle show-all mode
[Q] Quit (prompts for save) [D] Save minimal config (advanced)
  
```

- Now the PAN9520 use the “phy init data” binary.
- The default partition table will include a corresponding partition at address “0x8000”, to which the binary must be flashed.

For further details please refer to <https://docs.espressif.com/projects/esp-idf/en/v4.2/esp32s2/api-reference/kconfig.html?highlight=support%20multiple%20phy#config-esp32-phy-init-data-in-partition>.

Using a Binary with Multiple “Phy Init Data” Sets

It is also possible to create a binary that contains “phy init data” sets for several regions. The binary data is then selected depending on the used country code.

For further details please refer to <https://docs.espressif.com/projects/esp-idf/en/v4.2/esp32s2/api-reference/kconfig.html?highlight=support%20multiple%20phy#config-esp32-support-multiple-phy-init-data-bin>.



Further Readings

“Phy init data” documentation: https://www.espressif.com/sites/default/files/documentation/esp32_phy_init_bin_parameter_configuration_guide_en.pdf

PHY project configuration: <https://docs.espressif.com/projects/esp-idf/en/v4.2/esp32s2/api-reference/kconfig.html?highlight=support%20multiple%20phy#phy>

6.1.2.2 Editing “Phy Init Data” in the Source Code

Per default, the “phy init data” set defined in the source code is used by the PAN9520. Therefore, adapting this data is also an option to comply with the regulations. The data can be found in [ESP-IDF] > components > esp_wifi > esp32s2 > include > phy_init_data.h.

The structure `phy_init_data` of type `phy_init_data_t` contains the configuration bytes. These are the same as described in ⇒ 6.1.2.1 Using “`phy_init_data`” Binary, but the eight start bytes and end bytes are missing. Therefore, the byte enumeration is decreased by eight. The code examples for RED (EU) and FCC/IC (USA and Canada) are described below.

“Phy Init Data” for RED

```
/**
 * @brief Structure containing default recommended PHY initialization parameters.
 */
static const esp_phy_init_data_t phy_init_data= {
3,
    0,
    0x04,
    0x05,
    0x04,
    0x05,
    0x05,
    0x04,
    0x06,
    0x06,
    0x06,
    0x05,
    0x06,
    0x00,
    0x00,
    0x00,
    0x00,
    0x05,
    0x09,
    0x06,
    0x05,
    0x03,
    0x06,
    0x05,
    0x00,
    0x00,
    0x00,
    0x00,
    0x00,
    0x00,
```

```

0x00,
0x00,
0x00,
0xf4,
0xf8,
0xf8,
0xf0,
0xf0,
0xf0,
0xe0,
0xe0,
0xe0,
0x18,
0x18,
0x18,

/* Start of Power Value Definitions */
56, // byte 44 (byte 52 in binary)
56, // byte 45 (byte 53 in binary)
56, // byte 46 (byte 54 in binary)
56, // byte 47 (byte 55 in binary)
56, // byte 48 (byte 56 in binary)
52, // byte 49 (byte 57 in binary)

/* Start of Power Settings (Modulation) */
0, // byte 50 (byte 58 in binary)
0, // byte 51 (byte 59 in binary)
0, // byte 52 (byte 60 in binary)
0, // byte 53 (byte 61 in binary)
0, // byte 54 (byte 62 in binary)
0, // byte 55 (byte 63 in binary)
0, // byte 56 (byte 64 in binary)
5, // byte 57 (byte 65 in binary)
0, // byte 58 (byte 66 in binary)
0, // byte 59 (byte 67 in binary)
0, // byte 60 (byte 68 in binary)

/* Start of Power Limit Settings (Channels) */
0, // byte 61 (byte 69 in binary)
0, // byte 62 (byte 70 in binary)
0, // byte 63 (byte 71 in binary)
0, // byte 64 (byte 72 in binary)
0, // byte 65 (byte 73 in binary)
0, // byte 66 (byte 74 in binary)
0, // byte 67 (byte 75 in binary)
0, // byte 68 (byte 76 in binary)

```



```
static const esp_phy_init_data_t phy_init_data= { {
    3,
    0,
    0x04,
    0x05,
    0x04,
    0x05,
    0x05,
    0x04,
    0x06,
    0x06,
    0x06,
    0x05,
    0x06,
    0x00,
    0x00,
    0x00,
    0x00,
    0x05,
    0x09,
    0x06,
    0x05,
    0x03,
    0x06,
    0x05,
    0x00,
    0x00,
    0x00,
    0x00,
    0x00,
    0x00,
    0x00,
    0x00,
    0x00,
    0x00,
    0xf4,
    0xf8,
    0xf8,
    0xf0,
    0xf0,
    0xf0,
    0xe0,
    0xe0,
    0xe0,
    0x18,
    0x18,
    0x18,
```



```

/* Start of Power Value Definitions */
    72, // byte 44 (byte 52 in binary)
    64, // byte 45 (byte 53 in binary)
    60, // byte 46 (byte 54 in binary)
    56, // byte 47 (byte 55 in binary)
    52, // byte 48 (byte 56 in binary)
    48, // byte 49 (byte 57 in binary)

/* Start of Power Settings (Modulation) */
    1, // byte 50 (byte 58 in binary)
    1, // byte 51 (byte 59 in binary)
    1, // byte 52 (byte 60 in binary)
    1, // byte 53 (byte 61 in binary)
    1, // byte 54 (byte 62 in binary)
    2, // byte 55 (byte 63 in binary)
    3, // byte 56 (byte 64 in binary)
    4, // byte 57 (byte 65 in binary)
    0, // byte 58 (byte 66 in binary)
    0, // byte 59 (byte 67 in binary)
    0, // byte 60 (byte 68 in binary)

/* Start of Power Limit Settings (Channels) */
    2, // byte 61 (byte 69 in binary)
    0x04, // byte 62 (byte 70 in binary)
    0x04, // byte 63 (byte 71 in binary)
    0x01, // byte 64 (byte 72 in binary)
    0x01, // byte 65 (byte 73 in binary)
    0x01, // byte 66 (byte 74 in binary)
    0x01, // byte 67 (byte 75 in binary)
    0x01, // byte 68 (byte 76 in binary)
    0x01, // byte 69 (byte 77 in binary)
    0x01, // byte 70 (byte 78 in binary)
    0x04, // byte 71 (byte 79 in binary)
    0x04, // byte 72 (byte 80 in binary)
    0xAA, // byte 73 (byte 81 in binary)
    0xAA, // byte 74 (byte 82 in binary)
    0xAA, // byte 75 (byte 83 in binary)
    0x66, // byte 76 (byte 84 in binary)
    0x66, // byte 77 (byte 85 in binary)
    0x66, // byte 78 (byte 86 in binary)
    0xA6, // byte 79 (byte 87 in binary)
    0xAA, // byte 80 (byte 88 in binary)
    0,
    0,
    0,
    0,

```

6.2 General Certification Information



For further certification requests for other radio software please contact Panasonic ⇒ [8 Contact Details](#).

6.3 Federal Communications Commission (FCC) for US

6.3.1 FCC Statement

The following FCC statement has to be printed in the OEM end product user information:



This device complies with part 15 of the FCC Rules. Operation is subject to the condition that this device does not cause harmful interference.

The device meets the requirements for modular transmitter approval as detailed in FCC public Notice DA00-1407. The transmitter operation is subject to the following two conditions:

1. This device may not cause harmful interference, and
2. This device must accept any interference received, including interference that may cause undesired operation.

6.3.2 Caution

The following FCC caution has to be printed in the OEM end product user information:



The FCC requires the user to be notified that any changes or modifications made to this device that are not expressly approved by Panasonic Industrial Devices Europe GmbH may void the user's authority to operate the equipment.



This equipment has been tested and found to comply with the limits for a Class B digital device, pursuant to Part 15 of the FCC Rules.

These limits are designed to provide reasonable protection against harmful interference in a residential installation. This equipment generates uses and can radiate radio frequency energy and, if not installed and used in accordance with the instructions, may cause harmful interference to radio communications.

However, there is no guarantee that interference will not occur in a particular installation. If this equipment does cause harmful interference to radio or television reception (which can be determined by turning the equipment off and on) the user is encouraged to try to correct the interference by one or more of the following measures:

- Reorient or relocate the receiving antenna,
- Increase the separation between the equipment and receiver,
- Connect the equipment into an outlet on a circuit different from that to which the receiver is connected,
- Consult the dealer or an experienced radio/TV technician for help.

6.3.3 Label Requirements

The following labelling requirements have to be implemented on the OEM end product:



The OEM must ensure that FCC labelling requirements are met. This includes a clearly visible label on the outside of the OEM enclosure specifying the appropriate Panasonic FCC identifier for this product as well as the FCC notice above.

The FCC identifier is **FCC ID: T7V9520**

This FCC identifier is valid for the PAN9520.
The end product must in any case be labelled on the exterior with:

"Contains FCC ID: T7V9520"

6.3.4 Antenna Warning

The following antenna has to be followed by the OEM:

This antenna warning refers to the device with the model number PAN9520.

The device is tested with a integrated antenna listed below. When integrated into the OEM's product, these fixed antennas require installation preventing end users from replacing them with non-approved antennas. Any antenna not in the following table must be tested to comply with FCC Section 15.203 for unique antenna connectors and with Section 15.247 for emissions.

6.3.5 Approved Antenna List

Item	Part Number	Manufacturer	Frequency Band	Type	Max. Gain (dBi)
1	ANT016008LCS2442MA1	TDK	2.4 GHz	Chip Antenna	1.6

6.3.6 RF Exposure



The end customer has to assure that the device has a distance of more than 20 cm from the human body under all circumstances.

If the end customer application intends to use the PAN9520 in a distance smaller 20 cm from the human body, SAR evaluation has to be repeated by the OEM.

The end customer equipment must meet the actual Safety/Health requirements according to FCC.



To comply with FCC RF Exposure requirements, the OEM must ensure that only antennas from the Approved Antenna List are installed ⇒ [6.3.5 Approved Antenna List](#).

The preceding statement must be included as a “CAUTION” statement in manuals for products operating with the approved antennas to alert users on FCC RF Exposure compliance.

Any notification to the end user of installation or removal instructions about the integrated radio module is not allowed.

The radiated output power of the PAN9520 with a mounted ceramic antenna (**FCC ID: T7V9520**) is below the FCC radio frequency exposure limits. Nevertheless, the PAN9520 shall be used in such a manner that the potential for human contact during normal operation is minimized.

End users may not be provided with the module installation instructions. OEM integrators and end users must be provided with transmitter operating conditions for satisfying RF exposure compliance.

6.4 Innovation, Science, and Economic Development (ISED) for Canada

The following IC rules have to be followed by end product OEM's:

English

The PAN9520 is licensed to meet the regulatory requirements of ISED.

License ID: **IC: 216Q-9520**
HVIN: **ENW49D01A1KF**
ENW49D02A1KF

Manufacturers of mobile, fixed or portable devices incorporating this module are advised to clarify any regulatory questions and ensure compliance for SAR and/or RF exposure limits. Users can obtain Canadian information on RF exposure and compliance from www.ic.gc.ca.

This device has been designed to operate with the antennas listed in Approved Antenna List, having a maximum gain of 1.6 dBi. Antennas not included in this list or having a gain greater than 1.6 dBi are strictly prohibited for use with this device. The required antenna impedance is 50 ohms. The antenna used for this transmitter must not be co-located or operating in conjunction with any other antenna or transmitter without the need of re-assessment of conformity by ISED.



The end customer has to assure that the device has a distance of more than 20 cm from the human body under all circumstances.

If the end customer application intends to use the PAN9520 in a distance smaller 20 cm from the human body, SAR evaluation has to be repeated by the OEM.

The end customer equipment must meet the actual Safety/Health requirements according to ISED.

French

PAN9520 est garanti conforme aux dispositions réglementaires d'Industry Canada (ISED).

License: **IC: 216Q-9520**

HVIN: **ENW49D01A1KF**

ENW49D02A1KF

Il est recommandé aux fabricants d'appareils fixes, mobiles ou portables de consulter la réglementation en vigueur et de vérifier la conformité de leurs produits relativement aux limites d'exposition aux rayonnements radiofréquence ainsi qu'au débit d'absorption spécifique maximum autorisé.

Des informations pour les utilisateurs sur la réglementation Canadienne concernant l'exposition aux rayonnements RF sont disponibles sur le site www.ic.gc.ca.

Ce produit a été développé pour fonctionner spécifiquement avec les antennes listées dans le tableau Approved Antenna List, présentant un gain maximum de 1.6 dBi. Des antennes autres que celles listées ici, ou présentant un gain supérieur à 1.6 dBi ne doivent en aucune circonstance être utilisées en combinaison avec ce produit. L'impédance des antennes compatibles est 50 Ohm. L'antenne utilisée avec ce produit ne doit ni être située à proximité d'une autre antenne ou d'un autre émetteur, ni être utilisée conjointement avec une autre antenne ou un autre émetteur.



Le client final doit s'assurer que l'appareil se trouve en toutes circonstances à une distance de plus de 20 cm du corps humain.

Si le client final envisage une application nécessitant d'utiliser le PAN9520 à une distance inférieure à 20 cm du corps humain, alors le FEO doit répéter l'évaluation DAS.

L'équipement du client final doit répondre aux exigences actuelles de sécurité et de santé selon l'ISED.

6.4.1 IC Notice

The following IC notice has to be printed in English and French in the OEM end product user information:

English



The device PAN9520, including the integrated antenna mentioned in ⇒ [6.3.5 Approved Antenna List](#), complies with Canada RSS-GEN Rules. The device meets the requirements for modular transmitter approval as detailed in RSS-Gen.

Operation is subject to the following two conditions:

1. This device may not cause harmful interference, and
2. This device must accept any interference received, including interference that may cause undesired operation.

French



Le présent appareil PAN9520, les antennes y compris ⇒ [6.3.5 Approved Antenna List](#) est conforme aux CNR-Gen d'Industrie Canada applicables aux appareils radio exempts de licence.

L'exploitation est autorisée aux deux conditions suivantes:

1. L'appareil ne doit pas produire de brouillage, et
2. L'utilisateur de l'appareil doit accepter tout brouillage radioélectrique subi, même si le brouillage est susceptible d'en compromettre le fonctionnement.

6.4.2 Labeling Requirements

The following IC labelling requirements have to be followed by end product OEM's:

English



Labeling Requirements

The OEM must ensure that IC labelling requirements are met. This includes a clearly visible label on the outside of the OEM enclosure specifying the appropriate Panasonic IC identifier for this product as well as the IC Notice above.

The IC identifier is: **IC: 216Q-9520**

This IC identifier is valid for the PAN9520 module. In any case, the end product must be labelled on the exterior with:

"Contains IC: 216Q-9520"

French



Obligations d'étiquetage

Les fabricants d'équipements d'origine (FEO) – en anglais Original Equipment Manufacturer (OEM) – doivent s'assurer que les obligations d'étiquetage IC du produit final sont remplies. Ces obligations incluent une étiquette clairement visible à l'extérieur de l'emballage externe, comportant l'identifiant IC du module Panasonic inclus, ainsi que la notification ci-dessus.

L' identifiant IC est: **IC: 216Q-9520**

Cet identifiant est valide pour module PAN9520. Dans tous les cas les produits finaux doivent indiquer sur leur emballage externe la mention suivante:

"Contient IC: 216Q-9520"

6.5 European Conformity According to RED (2014/53/EU)



All modules described in this Module Integration Guide comply with the standards according to the following LVD (2014/35/EU), EMC-D (2014/30/EU) together with RED (2014/53/EU) articles.

Standards

- The end product OEM has to re-assess the conformity of the end product to EU regulations, but can use the PAN9520 RED pre-assessment to shorten this procedure.
- The RED EU Type Examination Certificate No. **T818887N-01** issued by the Notified Body 0682 can be used for the OEM end product conformance assessment. If a Notified Body has been contracted for the end product conformity assessment, it should be noted that this EU Type Examination Certificate should be used for conformance assessment.

As a result of the OEM end product conformity assessment procedure described in 2014/53/EU Directive and other applicable EU directives, the end customer equipment should be labelled as follows:



The requirements for CE marking are described in regulation (EU) No. 765/2008 Annex II.



The end customer has to assure that the device has a distance of more than 5 cm from the human body under all circumstances.

If the end customer application intends to use the PAN9520 in a distance smaller 5 cm from the human body, SAR evaluation has to be repeated by the OEM.

The end customer equipment must meet the actual Safety/Health requirements according to RED.

PAN9520 and its model versions in the specified reference design can be used in all countries of the European Economic Area (Member States of the EU, European Free Trade Association States [Iceland, Liechtenstein, Norway]), Monaco, San Marino, Andorra, and Turkey.

7 Restricted Use

7.1 Life Support Policy

This Panasonic Industrial Devices Europe GmbH product is not designed for use in life support appliances, devices, or systems where malfunction can reasonably be expected to result in a significant personal injury to the user, or as a critical component in any life support device or system whose failure to perform can be reasonably expected to cause the failure of the life support device or system, or to affect its safety or effectiveness.

Panasonic customers using or selling these products for use in such applications do so at their own risk and agree to fully indemnify Panasonic Industrial Devices Europe GmbH for any damages resulting.

7.2 Restricted End Use

This Panasonic Industrial Devices Europe GmbH product is not designed for any restricted activity that supports the development, production, handling usage, maintenance, storage, inventory or proliferation of any weapons or military use.

Transfer, export, re-export, usage or reselling of this product to any destination, end-user or any end-use prohibited by the European Union, United States or any other applicable law is strictly prohibited.

8 Contact Details

8.1 Contact Us

Please contact your local Panasonic Sales office for details on additional product options and services:

For Panasonic Sales assistance in the **EU**, visit

<https://eu.industrial.panasonic.com/about-us/contact-us>

Email: wireless@eu.panasonic.com

For Panasonic Sales assistance in **North America**, visit the Panasonic website “Sales & Support” to find assistance near you at

<https://na.industrial.panasonic.com/distributors>

Please visit the **Panasonic Wireless Technical Forum** to submit a question at

<https://forum.na.industrial.panasonic.com>

8.2 Product Information

Please refer to the Panasonic Wireless Connectivity website for further information on our products and related documents:

For complete Panasonic product details in the **EU**, visit

<http://pideu.panasonic.de/products/wireless-modules.html>

For complete Panasonic product details in **North America**, visit

<http://www.panasonic.com/rfmodules>