

SSRs Technical Information

SSR Description and Circuit Configurations

Phototriac coupler

Load	Isolation type	Zero-crossing function	Model	Circuit configuration	I/O wave form (for resistive load)
AC	Phototriac	Yes	APT		
		No	APT		

SSR

Load	Isolation type	Zero-crossing function	Model	Circuit configuration	I/O wave form (for resistive load)
AC	Phototransistor	Yes	AQ1 (2A)		
		Yes	AQ-G AQ1 (3A, 10A)		
	AQ-J AQ-A				
	AQ-H				
	No		AQ-G (AQ1)* AQ-J)* AQ-A		
		AQ-H			

* AQ1, AQ-J and AQ-A random types are available by special order.

SSR (continued)

Load	Isolation type	Zero-crossing function	Model	Circuit configuration	I/O wave form (for resistive load)
DC	Phototransistor	—	AQ1		
DC logic output	Phototransistor	—	—		
		—	—		

Principle of Operation

SSR Switching Characteristics

1. SSR for AC Loads

(1) Zero-crossing SSR

The zero-crossing SSR uses a phototransistor or phototriac coupler to isolate the input from the output (see the circuit configuration on the previous page). When the input signal is activated, the internal zero-crossing detector circuit triggers the triac to turn on as the AC load voltage crosses zero.

The load current is maintained by the triac's latching effect after the input signal is deactivated, until the triac is turned off when the load voltage crosses zero. The following describes voltage and current wave forms for different types of loads:

• Resistive loads

Since resistive loads cause no phase shift between the voltage and current, the triac turns on when the AC load voltage crosses zero after the input signal is activated. The SSR turns off when the AC load voltage crosses zero and the load current is turned off after the input signal is subsequently deactivated.

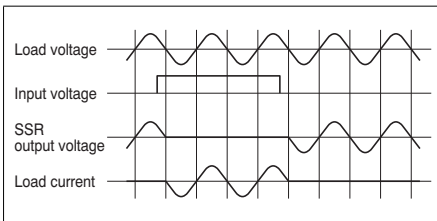

• Inductive loads

The SSR turns on when the load voltage crosses zero after the input signal is activated. It turns off when the load current subsequently crosses zero after the input signal is deactivated. A phase difference between the voltage and current may supply a transient spike to the SSR when it is turned off. While the snubber circuit absorbs this spike, an excessively large spike may result in a dv/dt error in the SSR's internal triac.

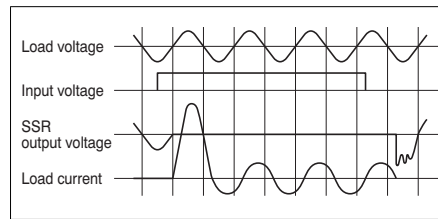

(2) Random type SSR

Random type SSR uses a phototriac coupler to isolate the input from the output. When the input signal is activated, the output immediately turns on, since there is no zero-crossing detector circuit. The load current is maintained by the triac's latching effect after the input signal is deactivated, until the AC load voltage crosses zero.

• Resistive loads

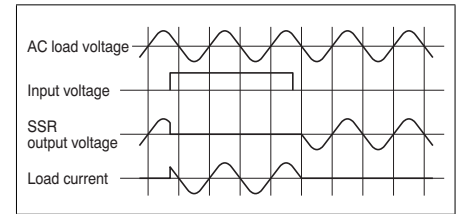

2. SSR for DC Loads

The SSR for DC loads uses a phototransistor coupler to isolate the input from the output. The output immediately responds to the input, since the phototransistor coupler directly turns the output transistor ON or OFF.

Terminology of Phototriac Coupler/AQ-H

	Term	Symbol	Description
Input side	LED forward current	I_F	Current that flows between the input terminals when the input diode is forward biased.
	LED reverse voltage	V_R	Reverse breakdown voltage between the input terminals.
	Peak forward current	I_{FP}	Maximum instantaneous value of the forward current.
	LED dropout voltage	V_F	Dropout voltage between the input terminals due to forward current.
Output side	Repetitive peak OFF-state voltage	V_{DRM}	Maximum voltage with repeatability that can be applied continuously between the output terminals.
	ON-state RMS current	$I_{T(RSM)}$	Effective current value, based on designated conditions, that can flow continuously between output terminals.
	Non-repetitive surge current	I_{TSM}	Maximum current, without repeatability, that is based on designated conditions. Normally this is expressed as the wave height value of one power frequency current sinusoidal cycle.
	Peak ON-state voltage	V_{TM}	Effective value of the voltage drop when a regulated load current flows between the output terminals when device is on.
	Peak OFF-state current	I_{DRM}	Current that flows to output when a regulated load voltage is applied between the output terminals when device is off.
Electrical Characteristics	Trigger LED current	I_{FT}	Current flow when LED current is augmented and output is on, when regulated power supply voltage and load has been connected between the output terminals.
	Holding current	I_H	Load current to maintain on state after output terminals have been turned on based on designated conditions.
	Critical rate of rise of OFF-state voltage	dv/dt	Output terminals do not go to the on state from the off state based on designated conditions.
	Zero-cross voltage	V_{ZC}	In the zero-cross method, when input is turned on, the maximum voltage value when the output terminals turn on.
	Turn on time	T_{on}	Delay time until the output switches on after a designated LED current is made to flow through the input terminals.
	I/O capacitance	C_{iso}	Capacitance between the input and output terminals.
	I/O isolation resistance	R_{iso}	Resistance between terminals (input and output) when a specified voltage is applied between the input and output terminals.

Terminology of SSR

	Term	Description
Input side	Control voltage	Input voltage necessary for normal SSR operation under the specified temperature conditions.
	Activation voltage	Threshold at which the output turns on as the control voltage is gradually increased with the specified voltage applied to the loaded output.
	Recovery voltage	Threshold at which the output turns off as the control voltage is gradually decreased with the specified voltage applied to the loaded output.
	Input impedance	Resistance of the current limiting resistor used in the SSR input side.
	Input line voltage	Input voltage at which an input module SSR operates normally.
	Input current	Input current at which an input module SSR operates normally.
Load side	Max. load current	Maximum continuous current allowable across the SSR output terminals under the specified heat dissipation and ambient temperature conditions. AC current is specified in RMS units.
	Load voltage	Output supply voltage range in which the SSR operates normally. AC voltage is specified in RMS units.
	Logic supply voltage/current	Supply voltage/current range in which an input module SSR operates normally.
	Non-repetitive surge current	Maximum non-repetitive load current allowable under the specified heat dissipation and ambient temperature conditions. In general, it is given by the peak value of a single cycle of sinusoidal commercial AC current.
	“OFF-state” leakage current	Current that flows in the SSR output circuit when the specified supply voltage is applied to the output with no control voltage applied to the input.
	“ON-state” voltage drop	Output voltage drop caused by a specified load current supplied to the SSR output which is turned on by a specified input control voltage. AC voltage is specified in RMS units.
	Min. load current	Minimum load current at and above which the SSR operates normally under the specified temperature conditions. AC load current is specified in RMS units.
	Output stage breakdown voltage	Maximum voltage that can be applied across the output and ground of an input module SSR.
	Max. load current	Maximum current allowable for the output circuit of an input module SSR.
	Repetitive peak voltage, max.	Maximum repetitive voltage which can be continuously applied across the SSR output terminals. In general, a voltage of more than 400 V AC is used for 100 V AC applications, and more than 600 V AC for 200-250 V AC applications, to absorb supply voltage variations or on/off surges.
Critical turn-off voltage rise ratio	SSRs may turn on if a turn-off voltage with a steep rising edge is applied. This phenomenon is called “dv/dt turn on.” Critical turn-off voltage rise ratio refers to the maximum turn-off voltage rise ratio at and below which the SSR remains turned off.	
Electrical Characteristics	Operate time, max.	Time until the SSR output turns on after the specified control voltage is applied to the input.
	Release time, max.	Time until the SSR output turns off after the specified control voltage is removed from the input.
	Insulation resistance	Resistance measured with a specified voltage applied across the input and output, or across the input or output and frame ground.
	Breakdown voltage	Maximum voltage below which no dielectric breakdown occurs when applied for 1 minute across the same test points as those used for insulation resistance testing.
	Vibration resistance	Functional: The device sustains no damage and meets the specifications if it is exposed to vibration with its magnitude not exceeding this threshold during transit or installation. Destructive: Closed contacts of a relay remain closed for the specified time period if it is exposed to vibration with its magnitude not exceeding this threshold during operation.
	Shock resistance	Functional: The device sustains no damage and meets the specifications if it is exposed to physical impact with its magnitude not exceeding this threshold during transit or installation. Destructive: Closed contacts of a relay remain closed for the specified time period if it is exposed to physical impact with its magnitude not exceeding this threshold during operation.
	Ambient temperature	Ambient temperature range over which the SSR operates normally under the specified heat dissipation and load current conditions.
	Storage temperature	Ambient temperature range over which an SSR can be safely stored for extended periods without sustaining damage or performance degradation.

Cautions For Use of Phototriac Coupler/AQ-H

SAFETY WARNINGS

- Do not use the product under conditions that exceed the range of its specifications. It may cause overheating, smoke, or fire.
- Do not touch the recharging unit while the power is on. There is a danger of

electrical shock. Be sure to turn off the power when performing mounting, maintenance, or repair operations on the relay (including connecting parts such as the terminal board and socket).

- Check the connection diagrams in the catalog and be sure to connect the terminals correctly. Erroneous connections could lead to unexpected operating errors, overheating, or fire.

Cautions for Use

1. Applying stress that exceeds the absolute maximum rating

If the voltage and current value for any of the terminals exceeds the absolute maximum rating, internal elements will deteriorate because of the excessive voltage and current. In extreme cases, wiring may melt, or silicon P/N junctions may be destroyed.

As a result, the design should ensure that the absolute maximum ratings will never be exceeded, even momentarily.

2. Derating

Derating is absolutely imperative for reliable design and is an essential factor in determining product life. Therefore, be sure to apply derate the maximum rated values when designing a system. Since it is important to derate in accordance with the type of relay, conditions for use, and environment, please be sure to conduct tests using actual equipment. Also, if there is a possibility that, due to a quality problem, this product might have a great effect on human life or property, do take product liability into consideration by being sure to take even extra leeway against the maximum rated value and implement safety measures such as the construction of redundant circuits.

3. The phototriac coupler is designed solely to drive a triac. As a condition, the triac must be powered beforehand.

4. The internal IC could be damaged if a short forms between the I/O terminals while the phototriac coupler and AQ-H SSR are powered.

5. Output spike voltages

1) The figure below shows an ordinary triac drive circuit. Please add a snubber circuit or varistor, as noise/surge on the load side could damage the unit or cause malfunctions.

<Phototriac coupler SOP4, DIP4>

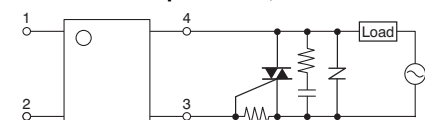

<Phototriac coupler DIP6>

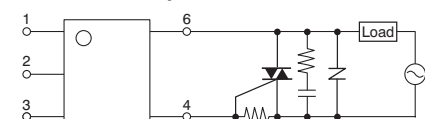

<AQ-H>

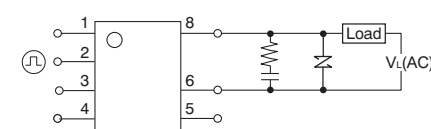

Note: Connection of an external resistor, etc., to terminal No. 5 (gate) is not necessary.

2) Clamp diode can limit spike voltages at the load side. However, long wires may cause spike voltages due to inductance. It is recommended to keep wires as short as possible to minimize inductance.

3) Output terminals may become conductive when a sudden voltage rise is applied, although the input power is not applied. This may occur even if voltage rise between terminals is less than the repetitive peak OFF-state voltage.

Therefore, please perform sufficient tests with actual conditions.

4) When controlling loads using zero-cross voltage types in which the voltage and current phases differ, since the triac sometimes does not turn on regardless of the input state, please conduct sufficient tests using actual equipment.

6. Recommended input current value

$I_F = 20 \text{ mA}$

7. Important Notes for Mounting

1) Temperature rise in the lead portion is highly dependent on package size. If multiple different packages are mounted on the same board, please check your board beforehand in an actual product, ensuring that the temperature conditions of the phototriac coupler fall within the parameters listed.

2) If the mounting conditions exceed the conditions recommended above, strength of the resin used will decrease and inconsistencies of the thermal expansion coefficients in the component materials will increase greatly. This can cause package cracking and breakage of the bonding wires. Please contact us for consultation.

8. Cleaning

The phototriac coupler and AQ-H SSR are formed an optical path by coupling a light-emitting diode (LED) and photodiode via transparent silicon resin. For this reason, unlike other directory element molded resin products (e.g.,

MOS transistors and bipolar transistors), avoid ultrasonic cleaning if at all possible. We recommend cleaning with an organic solvent. If you cannot avoid using ultrasonic cleaning, please ensure that the following conditions are met, and check beforehand for defects.

- Frequency: 27 to 29 kHz
- Ultrasonic output: No greater than 0.25 W/cm²
- Cleaning time: No longer than 30 s
- Cleanser used: Asahiklin AK-225
- Other: Submerge in solvent in order to prevent the PCB and elements from being contacted directly by the ultrasonic vibrations.

Note: Applies to unit area ultrasonic output for ultrasonic baths.

9. Transportation and storage

1) Extreme vibration during transport will warp the lead or damage the relay. Handle the outer and inner boxes with care.

2) Storage under extreme conditions will cause soldering degradation, external appearance defects, and deterioration of the performance. The following storage conditions are recommended:

- Temperature: 0 to 45°C 32 to 113°F
- Humidity: Less than 70% R.H.
- Atmosphere: No harmful gases such as sulfurous acid gas, minimal dust.

3) Storage of SOP type

Phototriac couplers implemented in SO packages (SOP 4-pin type) are sensitive to moisture and come in sealed moisture-proof packages. Observe the following cautions on storage.

- After the moisture-proof package is unsealed, use the devices as soon as possible (use within 1 month \leq 45°C 113°F/70% R.H.).
- If the devices are to be left in storage after the moisture-proof package has been unsealed, keep them in another moisture-proof bag containing silica gel and use within 3 months.

10. Soldering

1) When soldering PC board terminals, keep soldering time to within 10 s at 260°C 500°F.

2) When soldering surface-mount terminals or SO package, the following conditions are recommended.

(1) IR (Infrared reflow) soldering method

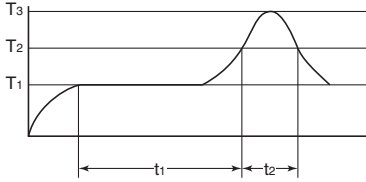

T₁ = 150 to 180°C 302 to 356°F
 T₂ = 230°C 448°F
 T₃ = 250°C 482°F or less
 t₁ = 60 to 120 s or less
 t₂ = 30 s or less

(2) Soldering iron method

Tip temperature: 350 to 400°C 662 to 752°F

Wattage: 30 to 60 W

Soldering time: within 3 s

(3) Others

Check mounting conditions before using other soldering methods (DWS, VPS, hot-air, hot plate, laser, pulse heater, etc.)

- The temperature profile indicates the temperature of the soldered terminal on the surface of the PC board. The ambient temperature may increase excessively. Check the temperature under mounting conditions.

- When using lead-free solder we recommend one with an alloy composition of Sn3.0Ag0.5Cu. Please consult us regarding details such as soldering conditions.

11. The following shows the packaging format

1) Tape and reel (Phototriac coupler)

mm inch

Type	Tape dimensions	Dimensions of paper tape reel
SO package 4-pin type	<p>(1) When picked from 1/2-pin side: Part No. APT○○○○SX (Shown above) (2) When picked from 3/4-pin side: Part No. APT○○○○SZ</p>	
DIP 4-pin type	<p>(1) When picked from 1/2-pin side: Part No. APT○○○○AX (2) When picked from 3/4-pin side: Part No. APT○○○○AZ</p>	
DIP 6-pin type	<p>(1) When picked from 1/2/3-pin side: Part No. APT○○○○AX (2) When picked from 4/5/6-pin side: Part No. APT○○○○AZ</p>	

Type	Tape dimensions	Dimensions of paper tape reel
DIP 4-pin wide terminal type	<p>(1) When picked from 1/4-pin side: Part No. APT○○○○WAY (2) When picked from 2/3-pin side: Part No. APT○○○○WAW</p>	
DIP 6-pin wide terminal type	<p>(1) When picked from 1/6-pin side: Part No. APT○○○○WAY (2) When picked from 3/4-pin side: Part No. APT○○○○WAW</p>	

2) Tape and reel (AQ-H)

Type	Tape dimensions	Dimensions of paper tape reel
8-pin SMD type	<p>(1) When picked from 1/2/3/4-pin side: Part No. AQH○○○○AX (Shown above) (2) When picked from 5/6/8-pin side: Part No. AQH○○○○AZ</p>	

3) Tube

(1) Devices are packaged in a tube as pin No. 1 is on the stopper B side. Observe correct orientation when mounting them on PC boards.

(SOP type)

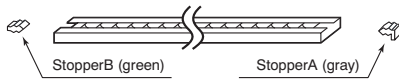

(DIP type)

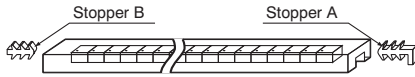

13. Applying stress that exceeds the absolute maximum rating

If the voltage and current value for any of the terminals exceeds the absolute maximum rating, internal elements will deteriorate because of the excessive voltage and current. In extreme cases, wiring may melt, or silicon P/N junctions may be destroyed.

As a result, the design should ensure that the absolute maximum ratings will never be exceeded, even momentarily.

Cautions for Use of SSR

SAFETY WARNINGS

- Do not use the product under conditions that exceed the range of its specifications. It may cause overheating, smoke, or fire.

- Do not touch the recharging unit while the power is on. There is a danger of electrical shock. Be sure to turn off the power when performing mounting, maintenance, or repair operations on the relay (including connecting parts such as the terminal board and socket).

- Check the connection diagrams in the catalog and be sure to connect the terminals correctly. Erroneous connections could lead to unexpected operating errors, overheating, or fire.

Cautions for Use

1. Regarding output noise surge protection

(1) AC Output Type

A high noise surge voltage applied to the SSR load circuit can cause malfunction or permanent damage to the device. If such a high surge is anticipated, use a varistor across the SSR output.

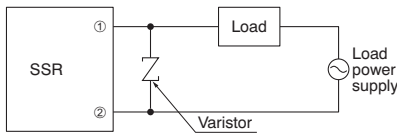

Note: AQ-F solid-state relay output terminals are numbered (8) and (12).

(2) DC Output Type

When the SSR is loaded with an inductive load, such as a solenoid contactor, motor, or solenoid valve, use a counter-EMF suppression diode across the load.

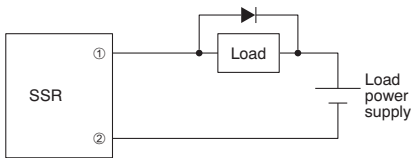

2. When used for the load less than rated

An SSR may malfunction if it is used below the specified load. In such an event, use a dummy resistor in parallel with the load.

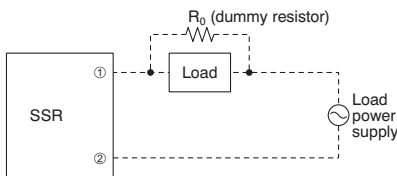

3. Noise and surge protection at the input side

A high noise surge voltage applied to the SSR input circuit can cause malfunction or permanent damage to the device. If such a high surge is anticipated, use C or R noise absorber in the input circuit.

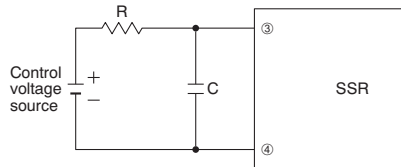

4. When the input terminals are connected with reverse polarity

Type	If the polarity of the input control voltage is reversed
AQ1, AQ-J, AQ-A, AQ-J	Reversing the polarity will not cause damage to the device, due to the presence of a protection diode, but the device will not operate.
AQ-H, AQ-G	Reversing the polarity may cause permanent damage to the device. Take special care to avoid polarity reversal or use a protection diode in the input circuit.

5. In the case of operating voltage containing ripple

If the SSR control voltage contains ripple, the peak of the ripple should not exceed the maximum rated control voltage, and the bottom of the ripple should exceed the minimum rated control voltage.

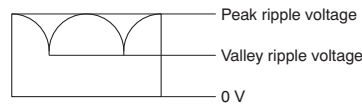

6. Cleaning solvents compatibility

Dip cleaning with an organic solvent is recommended for removal of solder flux, dust, etc. If ultrasonic cleaning must be used, the severity of factors such as frequency, out power and cleaning solvent selected may cause loose wires and other troubles.

Please make sure these conditions before use.

7. Transportation and storage

1) Extreme vibration during transport will warp the lead or damage the relay.

Handle the outer and inner boxes with care.

2) Storage under extreme conditions will cause soldering degradation, external appearance defects, and deterioration of the characteristics. The following storage conditions are recommended:

- Temperature: 0 to 45°C 32 to 113°F
- Humidity: Less than 70% R.H.
- Atmosphere: No harmful gasses such as sulfurous acid gas, minimal dust.

8. Others

(1) If an SSR is used in close proximity to another SSR or heat-generating device, its ambient temperature may exceed the allowable level. Carefully plan SSR layout and ventilation.

(2) Soldering to SSR terminals should be completed within 5 seconds at 260°C.

(3) Terminal connections should be made by referring to the associated wiring diagram.

(4) For higher reliability, check device quality under actual operating conditions.

Load Specifications

Type	Load current
AQ-G All models	20 mA
AQ-1 AC output type DC output type	50 mA 5 mA
AQ-J All models	50 mA
AQ-A All models	100 mA

Snubber Circuit

1. Reduce dv/dt

An SSR used with an inductive load can accidentally fire due to a high load voltage rise rate (dv/dt), even though the load voltage is below the allowable level (inductive load firing).

Our SSRs contain a snubber circuit designed to reduce dv/dt (except AQ-H).

2) R selection

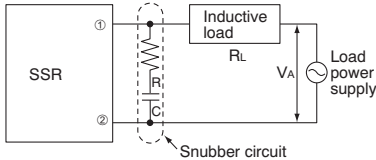

If there is no resistance R (the resistance R controls the discharge current from condenser C), at turn-on of the SSR, there will be a sharp rise in dv/dt and the high peak value discharge current will begin to flow. This may cause damage to the internal elements of the SSR.

2. Selecting the snubber constants

1) C selection

The charging coefficient tau for C of the SSR circuit is shown in formula ①

$$\tau = (R_L + R) \times C \text{ -----①}$$

By setting formula ① so that it is below dv/dt value you have:

$$C = 0.632V_A / ((dv/dt) \times (R_L + R)) \text{ -----②}$$

Therefore, it is always necessary to insert a resistance R. In normal applications, for the 100 V line, have R = 10 to 100 Ω and for the 200 V line, have R = 20 to 100 Ω. (The allowable discharge current at turn-on will differ depending on the internal elements of the SSR.) The power loss from R, written as P, caused by the discharge current and charging current from C, is shown in formula ③ below. For the 100 V line, use a power of 1/2 W, and for the 200 V line, use a power above 2 W.

$$P = \frac{C \times V_A^2 \times f}{2} \text{ -----③}$$

f = Power supply frequency

By setting C = 0.1 to 0.2 μF, dv/dt can be controlled to between nV/μs and n+V/μs or lower. For the condenser, use either an MP condenser metallized polyester film. For the 100 V line, use a voltage between 250 and 400 V, and for the 200 V line, use a voltage between 400 and 600 V.

Also, at turn-off of the SSR, a ringing circuit is formed with the capacitor C and the circuit inductance L, and a spike voltage is generated at both terminals of the SSR. The resistance R serves as a control resistance to prevent this ringing. Moreover, a good non-inductive resistance for R is required. Carbon film resistors or metal film resistors are often used. For general applications, the recommended values are C = 0.1 μF and R = 20 to 100 Ω. There are cases of resonance in the inductive load, so the appropriate care must be taken when making your selections.

Thermal Design

SSRs used in high-reliability equipment require careful thermal design. In particular, junction temperature control has a significant effect on device function and life time. The rated load current for board-mounting SSRs is defined as the maximum current allowable at an ambient temperature of 40°C (30°C) and under natural cooling. If the ambient temperature exceeds the SSRs derating temperature point (20°C to 40°C, depending on SSR), load current derating in accordance with the load current vs temperature diagram becomes necessary. If adjacent devices act as heat sources, the SSR should be located more than 10 mm away from those devices. SSRs with a 5 A rating or more must be used with the dedicated heat sinks listed in Table 1 or equivalents. To ensure

adequate thermal conduction, apply thermal conductive compound (Toshiba silicone YG6111, TSK5303 or alternate) to the SSR's mounting surface. For

information on external heat sinks for our SSRs and their mounting method, refer to "Data and Cautions for Use for respective relay".

Table 1. Dedicated on-board heat sinks

Load current	Type	Heat sink
to 10 A	AQ10A2-ZT4/32V DC	AQ-HS-5A
10 A	AQ-J (10A)	AQP-HS-J10A AQP-HS-J10A (for AQ-J) AQP-HS-SJ10A (for AQ-J)* AQP-HS-SJ20A*
15 A	AQ-A (15A), AQ-J (15A)	AQP-HS-J10A AQP-HS-J10A (for AQ-J) AQP-HS-SJ10A (for AQ-J)* AQP-HS-SJ20A*
20 A	AQ-J (25A)	AQP-HS-J10A AQP-HS-SJ10A (for AQ-J)* AQP-HS-SJ20A*
25 to 40 A	AQ-A (25A)	AQP-HS-30/40A
25 A	AQ-J (25A)	AQP-HS-J25A
40 A	AQ-A (40A)	AQP-HS-J25A

*It is possible to mounting on the DIN rail.

Protection Circuit

High-reliability SSR circuits require an adequate protection circuit, as well as careful study of the characteristics and maximum ratings of the device.

1. Over-Voltage Protection

The SSR load power supply requires adequate protection against over-voltage errors from various causes. The methods of over-voltage protection include the following:

(1) Use devices with a guaranteed reverse surge withstand voltage (controlled avalanche devices, etc.)

(2) Suppress transient spikes

Use a switching device in the secondary circuit of a transformer or use a switch with a slow opening speed.

(3) Use a surge absorption circuit

Use a CR surge absorber or varistor across the load power supply or SSR. Special care must be taken so power on/off surges or external surges do not exceed the device's rated load voltage. If a surge voltage exceeding the device's rated voltage is anticipated, use a surge absorption device and circuit (e.g. a ZNR from Panasonic Electronic Devices Co., Ltd.).

Cautions for Use of SSR

Choosing the Rated Voltage of the ZNR

- (1) Peak supply voltage
- (2) Supply voltage variation
- (3) Degradation of ZNR characteristic (1 mA±10%)

- (4) Tolerance of rated voltage (10%)
- For application to 100 V AC lines, choose a ZNR with the following rated voltage:
 $(1) \times (2) \times (3) \times (4) = (100 \times 2) \times 1.1 \times 1.1 \times 1.1 = 188 \text{ (V)}$

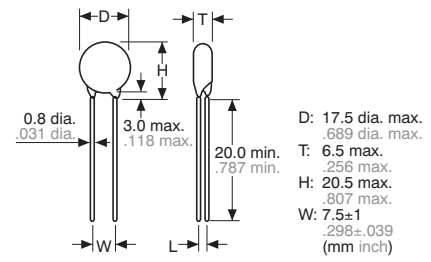

Example of ZNR (Panasonic Electronic Components)

Types	Varistor voltage V1mA (V)	Max. allowable circuit voltage		Max. control voltage V50A (V)	Max. average pulse electric power (W)	Withstanding energy		Withstanding surge current		Electrostatic capacitance (Reference) @1KHz (pF)
		ACrms (V)	DC (V)			(10/1000μs) (J)	(2ms) (J)	1time (A)	(8/20μs) 2time (A)	
ERZV14D201	200 (185 to 225)	130	170	340	0.6	70	50	6,000	5,000	770
ERZV14D221	220 (198 to 242)	140	180	360	0.6	78	55	6,000	5,000	740
ERZV14D241	240 (216 to 264)	150	200	395	0.6	84	60	6,000	5,000	700
ERZV14D271	270 (247 to 303)	175	225	455	0.6	99	70	6,000	5,000	640
ERZV14D361	360 (324 to 396)	230	300	595	0.6	130	90	6,000	4,500	540
ERZV14D391	390 (351 to 429)	250	320	650	0.6	140	100	6,000	4,500	500
ERZV14D431	430 (387 to 473)	275	350	710	0.6	155	110	6,000	4,500	450
ERZV14D471	470 (423 to 517)	300	385	775	0.6	175	125	6,000	4,500	400
ERZV14D621	620 (558 to 682)	385	505	1,025	0.6	190	136	6,000	4,500	330
ERZV14D681	680 (612 to 748)	420	560	1,120	0.6	190	136	5,000	4,500	320

2. Over-Current Protection

An SSR circuit operated without over-current protection may result in damage to the device. Design the circuit so the device's rated junction temperature is not exceeded for a continuous overload current.

(e.g. Surge current into a motor or light bulb)

The surge-on current rating applies to over-current errors which occur less than several tens of times during the service life of a semiconductor device. A protection coordination device is required for this rating.

Methods of over-current protection include the following:

- (1) Suppressing over-currents
Use a current limiting reactor in series with the load power supply.
- (2) Use a current shut-off device
Use a current limiting fuse or circuit breaker in series with the load power supply.

Example of executing fuse selection of over-current protection cooperation

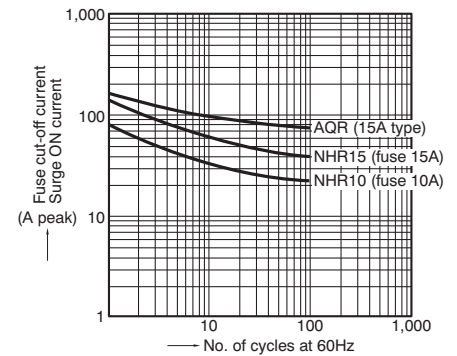

Load Type Description

1. Heaters (Resistive Load)

The SSR is best suited to resistive loads. Noise levels can be drastically lowered with zero-crossing switching.

2. Lamps

Tungsten or halogen lamps draw a high inrush current when turned on (approximately 7 to 8 times the steady-state current for zero-crossing SSRs; approximately 9 to 12 times, in the worst case, for random type SSRs). Choose an SSR so the peak of the inrush current does not exceed 50% of the SSR surge-on current.

3. Solenoids

AC-driven solenoid contactors or solenoid valves also draw inrush current when they are activated. Choose an SSR such that the peak of the inrush current does not exceed 50% of the SSR surge-on current. For small solenoid valves and AC relays in particular, a leakage current may cause the load to malfunction after the SSR turns off. In such an event, use a dummy resistor in parallel with the load.

- Using an SSR below the Specified Load

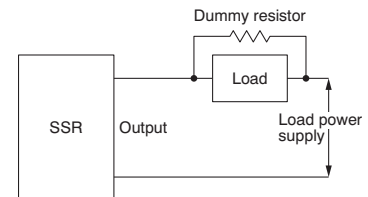

4. Motors

When starting, an electric motor draws a symmetrical AC starting current some 5 to 10 times the steady-state load current, superimposed on a DC current. The starting time during which this high starting current is sustained depends on the capacities of the load and load power supply. Measure the starting current and time under the motor's actual operating conditions and choose an SSR so the peak of the starting current does not exceed 50% of the SSR surge-on current. When the motor load is deactivated, a voltage exceeding the load supply voltage is applied to the SSR due to counter-EMF. This voltage is approximately 1.3 times the load supply voltage for induction motors, and approximately 2 times that for synchronous motors.

• Reversible Motor Control

When the direction of motor rotation is reversed, the transient current and time required for the reversal far exceed those required for simple starting. The reversing current and time should also be measured under actual operating conditions.

For a capacitor-starting, single-phase induction motor, a capacitive discharge current appears during the reversal process. Be sure to use a current limiting resistor or reactor in series with the SSR. Also, the SSR should have a high marginal voltage rating, since a voltage twice as high as the load supply voltage develops across the SSR in the reversal process. (For reversible control on a 100 V AC line, use SSRs with a 200 V rating; for use on a 200 V AC line, contact your nearest our representative for further information.)

For reversible motor control, carefully design the driver circuit so the forward and reverse SSRs do not turn on at the same time.

Transistor-driven reversible motor control circuit

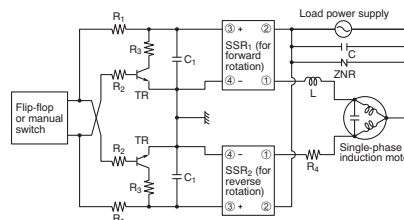

5. Capacitive Load

A capacitive load (switching regulator, etc.) draws an inrush current to charge the load capacitor when the SSR turns on. Choose an SSR so the peak of the inrush current does not exceed 50% of the SSR surge-on current. A timing error of up to one cycle can occur when a switch used in series with the SSR is opened or closed. If this is a problem, use an inductor (200 to 500 μ H) in series to the SSR to suppress dv/dt error.

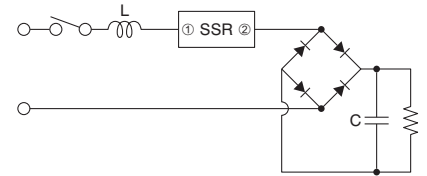

6. Other Electronic Equipment

In general, electronic equipment uses line filters in the primary supply circuit. The capacitors used in the line filters may cause the SSR to malfunction due to dv/dt turn on when the equipment is turned on or off. In such an event, use an inductor (200 to 500 μ H) in series with the SSR to suppress dv/dt turn on.

Load Inrush Current Wave and Time

(1) Incandescent Lamp Load

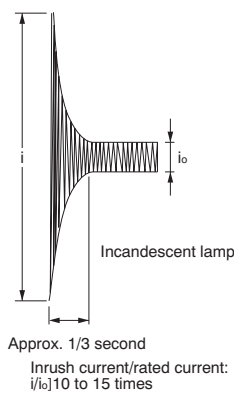

(2) Mercury Lamp Load i/i_o 3 times

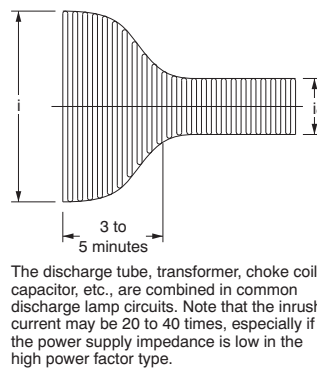

(3) Fluorescent Lamp Load i/i_o 5 to 10 times

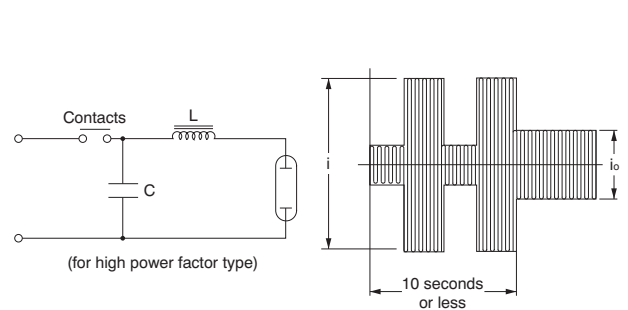

(4) Motor Load i/i_o 5 to 10 times

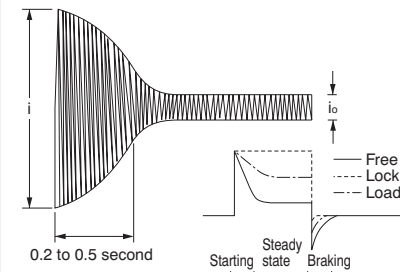

- Conditions become more harsh if plugging or inching is performed since state transitions are repeated.
- When using a relay to control a DC motor and brake, the on time inrush current, steady-state current and off time brake current differ depending on whether the load to the motor is free or locked. In particular, with non-polarized relays, when using from B contact of from contact for the DC motor brake, mechanical life might be affected by the brake current. Therefore, please verify current at the actual load.

(5) Solenoid Load i/i_o 10 to 20 times

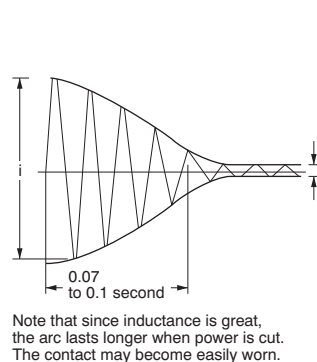

(6) Electromagnetic Contact Load i/i_o 3 to 10 times

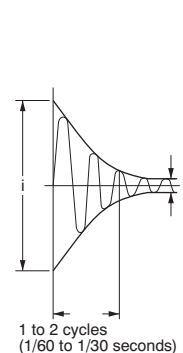

(7) Capacitive Load i/i_o 20 to 40 times

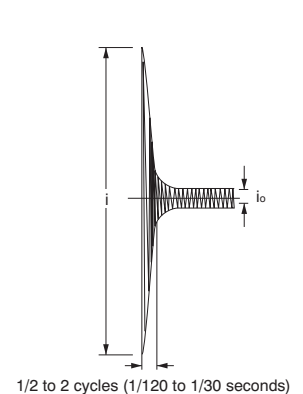

Cautions for Use of SSR

SSR Driving Circuits

1. Relay Driver

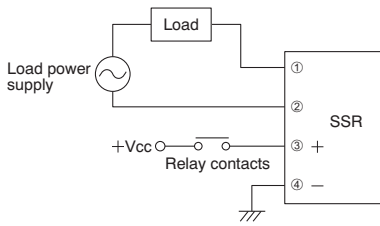

2. NPN Transistor Driver

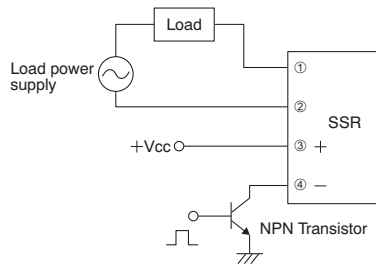

3. PNP Transistor Driver

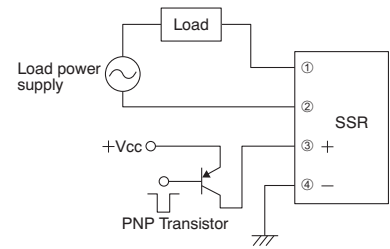

4. TTL/DTL/IC Driver

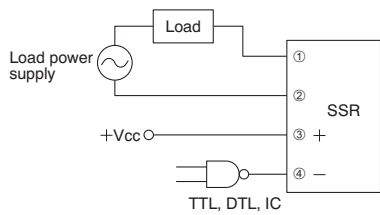

5. C-MOS/IC Driver

(1) SSR fires when IC output is HIGH:

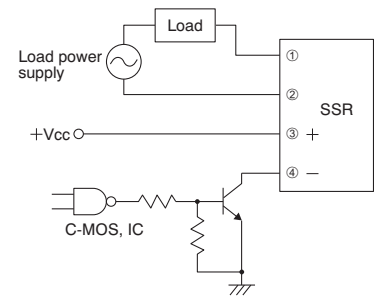

(2) SSR fires when IC output is LOW:

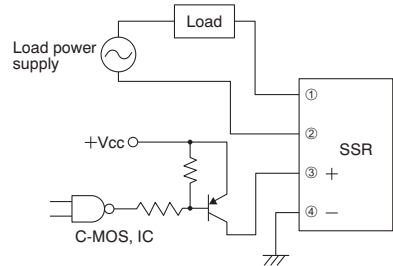

6. Self Sustaining Circuit Using SSR

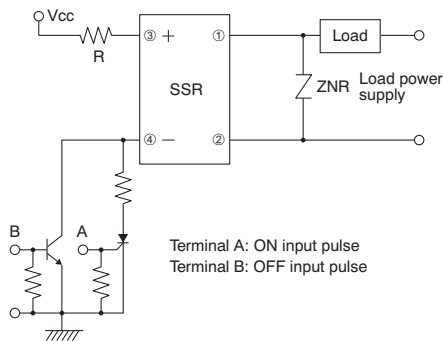

7. Driving with a Shared Supply

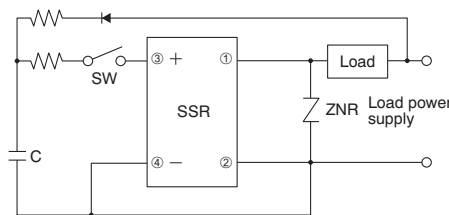

8. SSRs Used in Series

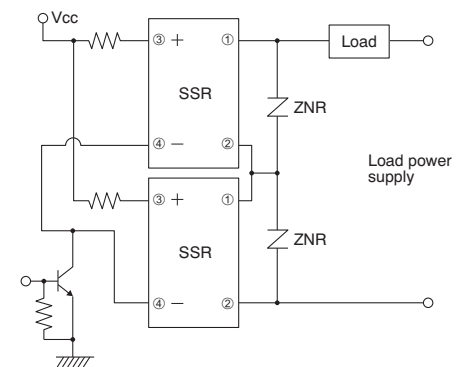

Phototriac Coupler, AQ-H Solid State Relay Driving Circuits

1. NPN Transistor Driver

1) Phototriac Coupler

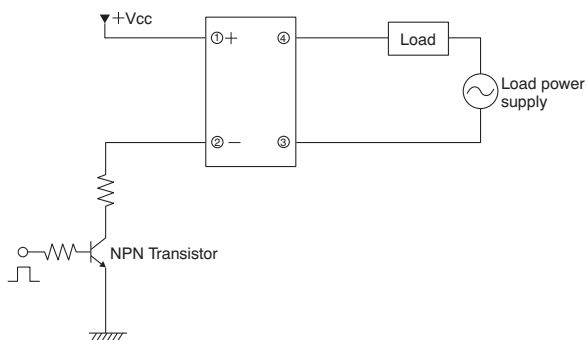

2) AQ-H Solid State Relay

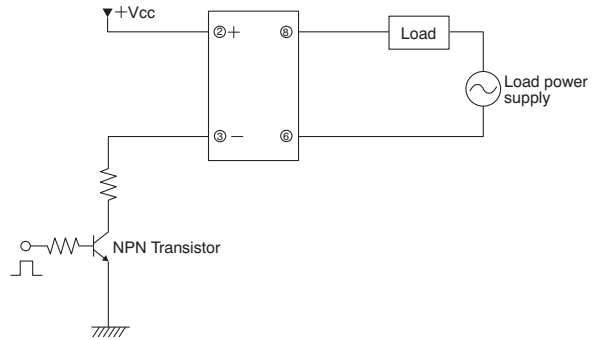

* Phototriac coupler and AQ-H is current driving type.

Phototriac Coupler/AQ-H Application Examples

Typical Applications

1. Temperature control for heater control

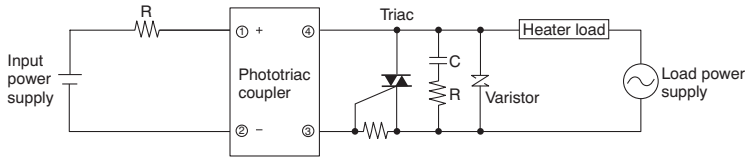

2. Airflow control for fan motors

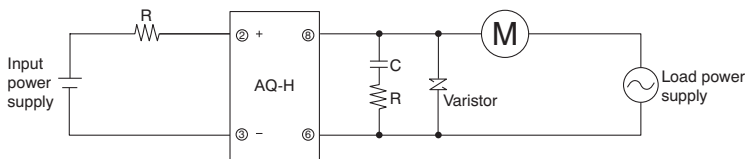

SSR Application Examples

Typical Applications

1. Light Bulb

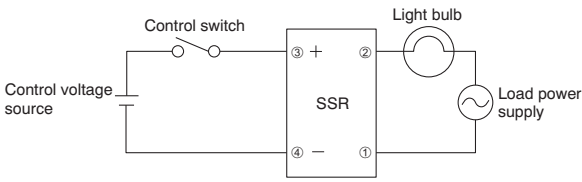

2. Electric Furnace Temperature Control

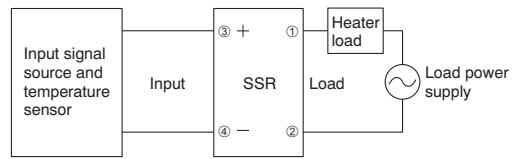

* KT Temperature Controller is available.

3. Single-Phase Induction Motor Control

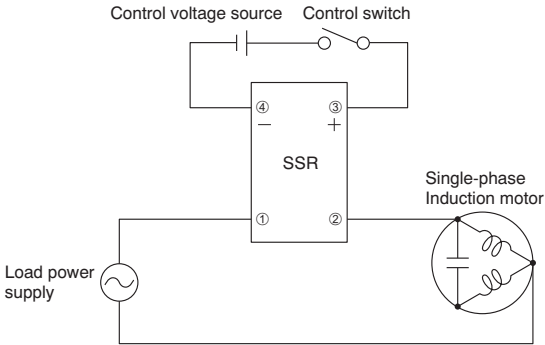

4. Reversible Control for a Single-Phase Induction Motor

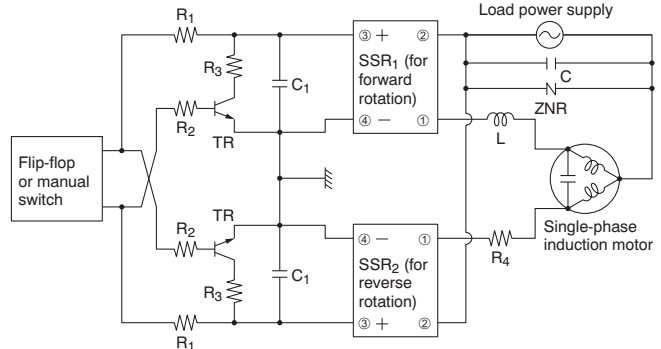

5. Three-Phase Induction Motor Control

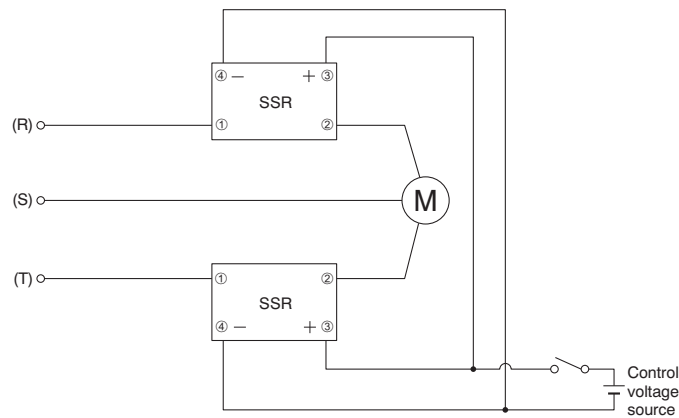

6. Reversible Control for a 3-Phase Induction Motor

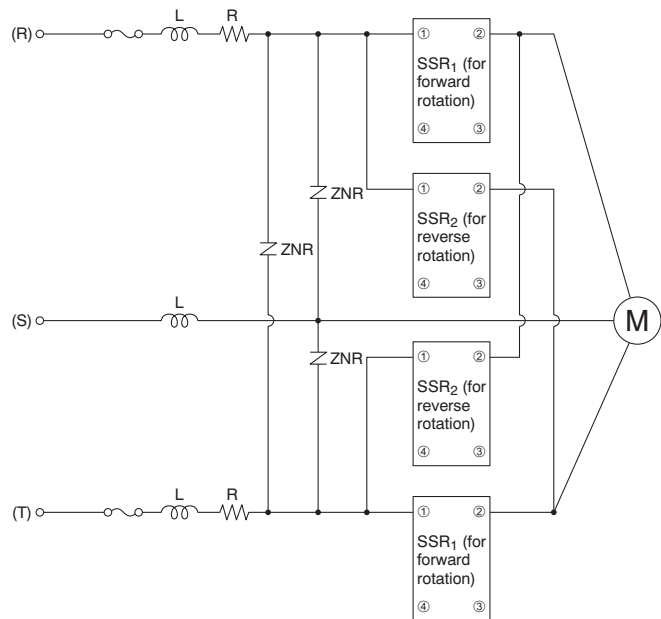

Note: Take special care in the design to ensure that both the forward and reverse SSRs do not turn on at the same time.

Recommended Temperature Controllers

<KT4H Temperature Controller>

Our temperature controller is recommended for use with our Solid State Relays.

Features

- Data can be collected using the RS485 communications interface via a PLC.
- Improved visibility using a negative type LCD and backlight.
- Depth-wise length (chassis dimension) is 56 mm 2.205 inch.

Substitute part numbers

Power supply	Control output	Part No.
100 to 240 V AC	Relay contact	AKT4H112100

*For detailed product information about temperature controllers, please refer to our website:
<http://industrial.panasonic.com/ac/e/>



SSR Load Recommendation Chart

Please use this chart when selecting the SSR load. The values presented are for ambient temperatures of 40°C 104°F (30°C 86°F) and lower. When selected, please measure the load current waveform and use within the range of each surge current characteristic.

Load voltage	Product	Max. load current	Type of load						Remarks
			Heater	Solenoid bulb	Single-phase motor	Triple-phase motor	Lamp	Transformer	
110 V AC	AQG (1A type)	1A	0.8A	0.5A	7W	—	0.5A	50W	
	AQG (2A type)	2A	1.6A	1A	15W	—	1A	100W	
	AQ1 (3A type)	3A	2.4A	1.5A	60W	—	1.5A	150W	
	AQ1 (10A type) AQJ (10A type)	10A	8A	5A	200W	—	5A	500W	Heat sink AQP-HS-SJ10A (AQJ type) Heat sink AQP-HS-J10A, AQP-HS-SJ20A Heat sink AQ-HS-5A (AQ1 type)
	AQA (15A type) AQJ (15A type)	15A	12A	7.5A	300W	—	7.5A	750W	Heat sink AQP-HS-J10A, AQP-HS-SJ20A Heat sink AQP-HS-J10A (AQ-J type)
	AQA (25A type) AQJ (25A type)	25A	20A	12.5A	500W	—	12.5A	1.25kW	Heat sink AQP-HS-30/40A (AQ-A type) Heat sink AQP-HS-J25A (AQ-J type)
	AQA (40A type)	40A	32A	20A	750W	—	20A	2kW	Heat sink AQP-HS-J25A (AQ-A type)
220 V AC	AQG (1A type)	1A	0.8A	0.5A	15W	50W	0.5A	100W	
	AQG (2A type)	2A	1.6A	1A	35W	100W	1A	200W	
	AQ1 (3A type)	3A	2.4A	1.5A	100W	300W	1.5A	300W	
	AQ1 (10A type) AQJ (10A type)	10A	8A	5A	400W	1kW	5A	1kW	Heat sink AQP-HS-SJ10A (AQJ type) Heat sink AQP-HS-J10A, AQP-HS-SJ20A Heat sink AQ-HS-5A (AQ1 type)
	AQA (15A type) AQJ (15A type)	15A	12A	7.5A	600W	1.5kW	7.5A	1.5kW	Heat sink AQP-HS-J10A, AQP-HS-SJ20A Heat sink AQP-HS-J10A (AQ-J type)
	AQA (25A type) AQJ (25A type)	25A	20A	12.5A	1kW	2.5kW	12.5A	2.5kW	Heat sink AQP-HS-30/40A (AQ-A type) Heat sink AQP-HS-J25A (AQ-J type)
	AQA (40A type)	40A	32A	20A	1.5kW	3.7kW	20A	4kW	Heat sink AQP-HS-J25A (AQ-A type)
48 V DC	AQ1 (2A type)	2A	1.6A	1.0A	—	—	1.0A	—	
100 V DC	AQ1 (1A type)	1A	0.8A	0.5A	—	—	0.5A	—	