

SOLID STATE RELAYS

AN OVERVIEW

Compact types
from
0.05A to 40A



Solid state relay

MOSFET output

TRIAC output

PhotoMOS Relays

SSR

The number of electronic devices used by consumers on a daily basis continues to be on the rise, and the demand for reliable, long-lasting component parts has increased accordingly. Whether it be as central switching elements for household devices or as components for industrial application areas Panasonic's solid state relays (SSRs) are designed to meet the most rigorous customer requirements.

Panasonic has played an instrumental role in the development of modern relays. Thanks to our research and production centers in Japan and Germany, we now offer a versatile product line that provides solutions for practically any application. As an ISO 9001-certified supplier, we not only deliver the quality you've come to expect from Panasonic, we also offer the support that only global players can provide.

For more and more applications, modern solid state relays are now a viable alternative to the classic electromechanical relays. Compared to conventional relays, semiconductor-based switching elements offer two essential advantages: superb reliability and a nearly unlimited lifespan. The various solid-state relay types all work according to the same principle: In the input circuit, an LED energizes an optoelectronic device via optical beam (-> insulation method), which in turn activates a power semiconductor on the output. At Panasonic, we differentiate between two solid state relay categories: the PhotoMOS type, with a MOSFET on the output, and the SSR type, with a TRIAC as a power semiconductor.

Ready to run – it's up to you to say when!

With most SSRs, you can choose between two types of switching behaviors:

Zero-cross

The zero-cross output does not become conductive until the load voltage crosses zero. As a result, the voltage on the component and on the load stays low during the switching cycle. The inrush current – and thus the impact on the component and on the load – as well as the electromagnetic noise are thereby reduced to a minimum.

Random

The random output becomes conductive immediately upon application of the LED input current. Thus, in addition to serving as a simple switch, it also lets you drive the load via phase control.

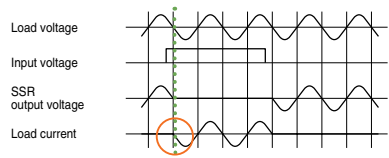

Fig. 1: Zero-cross switching behavior

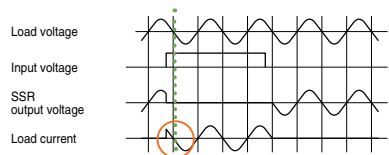

Fig. 2: Random switching behavior

APT1- Phototriac coupler

Ideal for TRIAC driver

FEATURES

- Reduced zero-cross voltage (max. 15V)
- Several housing types available (including wide terminal type with 10.16mm pitch between I/O)
- High I/O isolation voltage (between input and output; for SOP type: 3750V; for DIP type: 5000V)
- Handles both 100 and 200V AC loads
- Zero-cross type and random type available

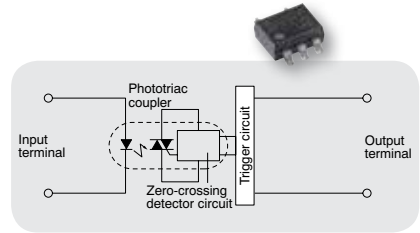

AQ-H

Compact DIP type: 0.3A to 1.2A

FEATURES

- Compact SSR, ideal for AC load control
- Supports 0.3A, 0.6A, 0.9A, and 1.2A RMS on-state current
- Handles both 100 and 200V AC loads
- High I/O isolation voltage: 5000V AC (between input and output)
- Zero-cross type and random type available
- No derating up to +40°C
- No heat sink required

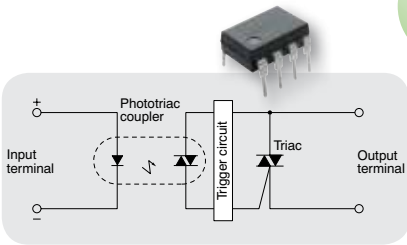

AQ-G / AQ-10

Compact SIL type: 1A to 10A

FEATURES

- Slim vertical types
- 1A to 10A load types available
- High I/O isolation voltage: 3000V AC
- VDE (EN60950-1)-compliant types (with reinforced insulation) available
- Integrated snubber circuit
- Zero-cross type and random type available

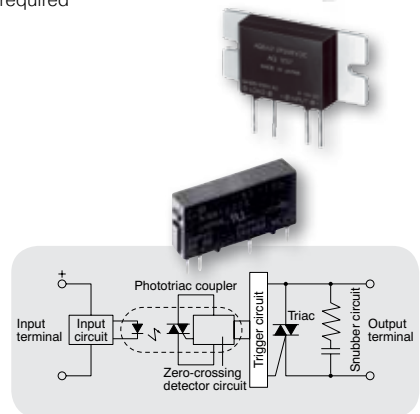

AQ-J

Compact high-capacity plug-in SSR: 10A to 25A

FEATURES

- Compact dimensions: W28 x L38 x H30mm
- Simple installation:
 - Screw mount or DIN rail mount
 - Easy I/O connection with tab terminals
- Built-in varistor
- Integrated snubber circuit
- Heat sink combined type easy to mount on DIN rail
- Output arrangement 1a and 2x 1a available in the heat sink combined type
- Zero-cross type and random type available
- High I/O isolation voltage: 3000V AC

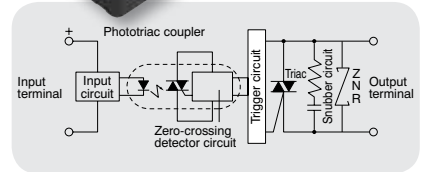

NEW



AQ-A / AQ-AD

Compact high-capacity screw terminal type: 15A to 40A

FEATURES

- AC or DC switching
- Compact dimensions: W40 x L58 x H25.5mm
- Terminal cover on output side
- Wide input range (4 to 32V DC)
- Mounting pitch: 47.5mm (1.870in)
- Operation status LED
- Reinforced insulation (breakdown voltage: $4000V_{RMS}$ between input and output)
- Built-in varistor (AC), Built-in Diode (DC)
- Integrated snubber circuit (AC)
- Zero-cross type and random type available (AC)

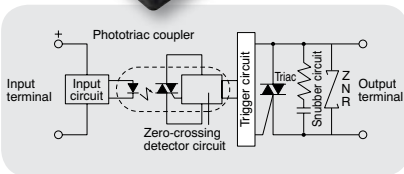

Solid State Relays: Selected Models

	Model ¹⁾	Housing	Load voltage (AC) ²⁾	Continuous load current	Function
	APT1211S	SOP4	250V	0.05A	Zero-cross
	APT1221S	SOP4	250V	0.05A	Random
	APT1211(A)	DIP4	250V	0.1A	Zero-cross
	APT1221(A)	DIP4	250V	0.1A	Random
	APT1212(A)	DIP6	250V	0.1A	Zero-cross
	APT1222(A)	DIP6	250V	0.1A	Random
	AQH0213(A)	DIP8	250V	0.3A	Zero-cross
	AQH0223(A)	DIP8	250V	0.3A	Random
	AQH3213(A)	DIP8	250V	1.2A	Zero-cross
	AQH3223(A)	DIP8	250V	1.2A	Random
	AQG12112	SIL4	250V	1A	Zero-cross
	AQG22112	SIL4	250V	2A	Zero-cross
	AQG12212	SIL4	250V	1A	Random
	AQG22212	SIL4	250V	2A	Zero-cross
	AQ3A2ZT432	SIL4	250V	3A	Zero-cross
	AQ10A2ZT432	SIL4	250V	10A*	Zero-cross
	AQJ416V	Hockey Puck	250V	25A*	Zero-cross
	AQJ116V	Hockey Puck	250V	15A*	Zero-cross
	AQA211VL	Hockey Puck	250V	15A*	Zero-cross
	AQA411V	Hockey Puck	250V	25A*	Zero-cross
	AQA611V	Hockey Puck	250V	40A*	Zero-cross
	AQAD551DL	Hockey Puck	100VDC	30A*	-
	AQAD171DL	Hockey Puck	600VDC	10A*	-

1) A = SMD model
 2) Effective value
 * with heat sink fins

Applications

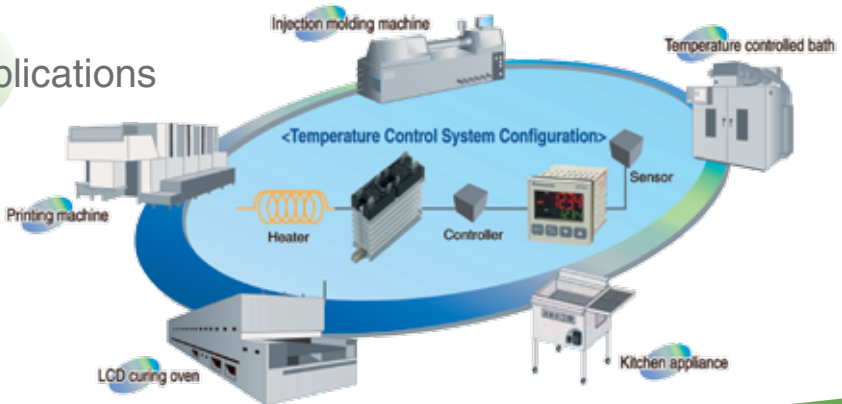

North America

Europe

Asia Pacific

China

Japan

Panasonic Electric Works

Please contact our Global Sales Companies in:

Europe

▶ Headquarters	Panasonic Electric Works Europe AG	Rudolf-Diesel-Ring 2, 83607 Holzkirchen, Tel. +49 (0) 8024 648-0, Fax +49 (0) 8024 648-111, www.panasonic-electric-works.com
▶ Austria	Panasonic Electric Works Austria GmbH	Josef Madersperger Str. 2, 2362 Biedermannsdorf, Tel. +43 (0) 2236-26846, Fax +43 (0) 2236-46133 www.panasonic-electric-works.at
	Panasonic Industrial Devices Materials Europe GmbH	Ennsstadenstraße 30, 4470 Enns, Tel. +43 (0) 7223 883, Fax +43 (0) 7223 88333, www.panasonic-electronic-materials.com
▶ Benelux	Panasonic Electric Works Sales Western Europe B.V.	De Rijn 4, (Postbus 211), 5684 PJ Best, (5680 AE Best), Netherlands, Tel. +31 (0) 499 372727, Fax +31 (0) 499 372185, www.panasonic-electric-works.nl
▶ Czech Republic	Panasonic Electric Works Europe AG	Administrative centre PLATINIUM, Veverň 3163/111, 616 00 Brno, Tel. +420 541 217 001, Fax +420 541 217 101, www.panasonic-electric-works.cz
▶ France	Panasonic Electric Works Sales Western Europe B.V.	Succursale française, 10, rue des petits ruisseaux, 91370 Verrières Le Buison, Tel. +33 (0) 1 6013 5757, Fax +33 (0) 1 6013 5758, www.panasonic-electric-works.fr
▶ Germany	Panasonic Electric Works Europe AG	Rudolf-Diesel-Ring 2, 83607 Holzkirchen, Tel. +49 (0) 8024 648-0, Fax +49 (0) 8024 648-111, www.panasonic-electric-works.de
▶ Hungary	Panasonic Electric Works Europe AG	Magyarországi Közvetlen Kereskedelmi Képviselet, 1117 Budapest, Neumann János u. 1., Tel. +36 1 999 89 26 www.panasonic-electric-works.hu
▶ Ireland	Panasonic Electric Works UK Ltd.	Irish Branch Office, Dublin, Tel. +353 (0) 14600969, Fax +353 (0) 14601131, www.panasonic-electric-works.co.uk
▶ Italy	Panasonic Electric Works Italia srl	Via del Commercio 3-5 (Z.I. Ferlina), 37012 Bussolengo (VR), Tel. +39 0456752711, Fax +39 0456700444, www.panasonic-electric-works.it
▶ Nordic Countries	Panasonic Electric Works Europe AG Panasonic Eco Solutions Nordic AB	Filial Nordic, Knarrarvägsgatan 15, 164 40 Kista, Sweden, Tel. +46 859476680, Fax +46 859476690, www.panasonic-electric-works.se
▶ Poland	Panasonic Electric Works Polska sp. z o.o.	Jungmansgatan 12, 21119 Malmö, Tel. +46 40 697 7000, Fax +46 40 697 7099, www.panasonic-fire-security.com
▶ Spain	Panasonic Electric Works España S.A.	ul. Woloska 9A, 02-583 Warszawa, Tel. +48 22 338-11-33, Fax +48 22 338-12-00, www.panasonic-electric-works.pl
▶ Switzerland	Panasonic Electric Works Schweiz AG	Barajas Park, San Severo 20, 28042 Madrid, Tel. +34 913293875, Fax +34 913292976, www.panasonic-electric-works.es
▶ United Kingdom	Panasonic Electric Works UK Ltd.	Grundstrasse 8, 6343 Rotkreuz, Tel. +41 (0) 41 7997050, Fax +41 (0) 41 7997055, www.panasonic-electric-works.ch
		Sunrise Parkway, Linford Wood, Milton Keynes, MK14 6LF, Tel. +44 (0) 1908 231555, Fax +44 (0) 1908 231599, www.panasonic-electric-works.co.uk

North & South America

▶ USA	Panasonic Industrial Devices Sales Company of America	629 Central Avenue, New Providence, N.J. 07974, Tel. 1-908-464-3550, Fax 1-908-464-8513, www.pewa.panasonic.com
--------------	--	---

Asia Pacific/China/Japan

▶ China	Panasonic Electric Works Sales (China) Co. Ltd.	Level 2, Tower W3, The Towers Oriental Plaza, No. 2, East Chang An Ave., Dong Cheng District, Beijing 100738, Tel. +86-10-5925-5988, Fax +86-10-5925-5973
▶ Hong Kong	Panasonic Industrial Devices Automation Controls Sales (Hong Kong) Co., Ltd.	RM1205-9, 12/F, Tower 2, The Gateway, 25 Canton Road, Tsimshatsui, Kowloon, Hong Kong, Tel. +852-2956-3118, Fax +852-2956-0398
▶ Japan	Panasonic Corporation	1048 Kadoma, Kadoma-shi, Osaka 571-8686, Japan, Tel. +81-6-6908-1050, Fax +81-6-6908-5781, www.panasonic.net
▶ Singapore	Panasonic Industrial Devices Automation Controls Sales Asia Pacific	300 Beach Road, #16-01 The Concourse, Singapore 199555, Tel. +65-6390-3811, Fax +65-6390-3810