

**Panasonic**  
INDUSTRY

PhotoMOS<sup>®</sup>

Phototriac Coupler  
Solid State Relays

Catalogue  
2020





## INDEX

---

◆ PhotoMOS® Types and typical applications .....	2
◆ PhotoMOS® Part No.System .....	4
◆ PhotoMOS® Selector Chart .....	5
◆ Photovoltaic MOSFET Drivers Selector Chart .....	40
◆ Phototriac Coupler Selector Chart .....	41
◆ Solid State Relays Selector Chart .....	43
◆ Dimensions .....	50

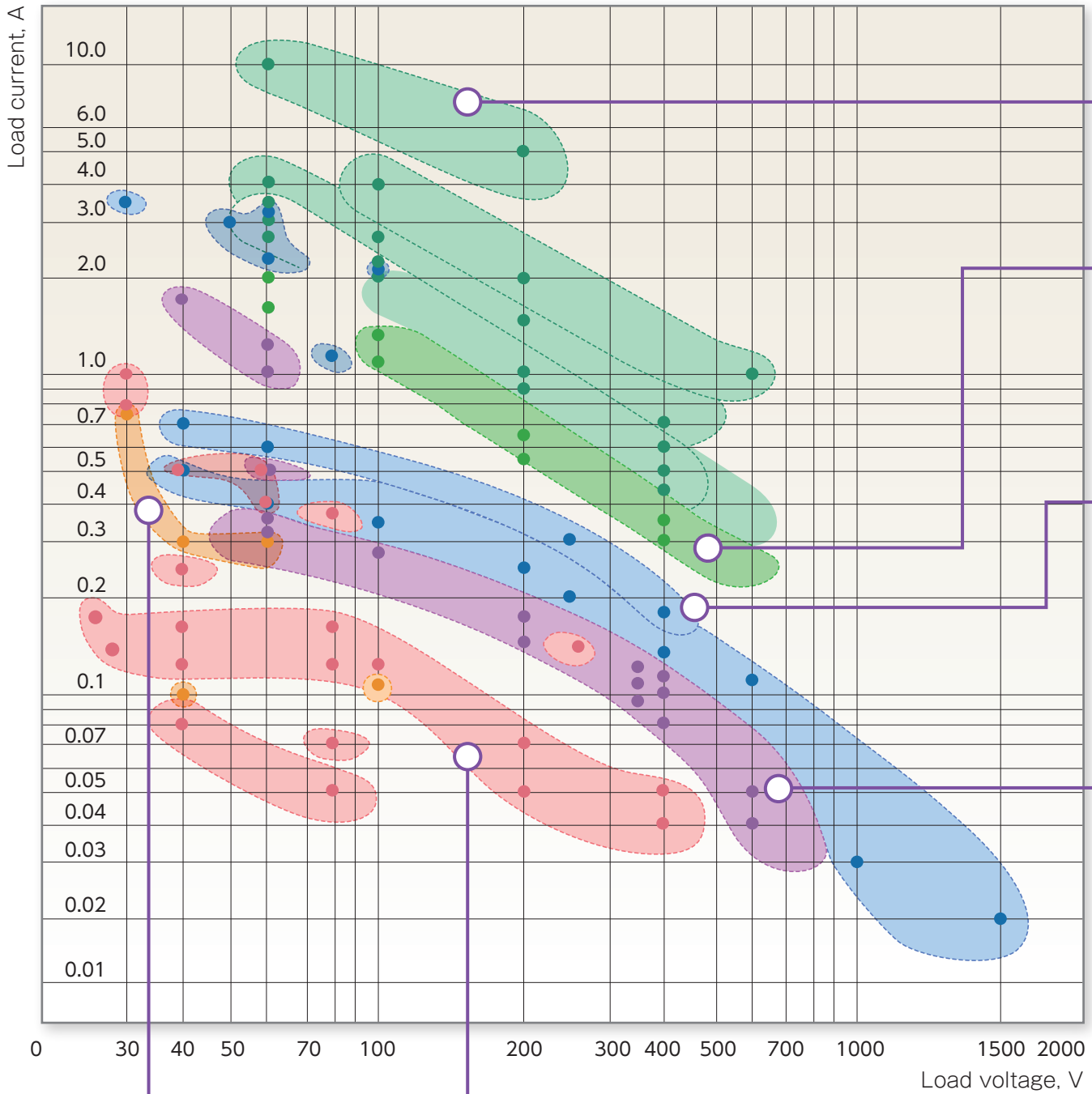

**\*About automotive applications**

If you are considering to use PhotoMOS® for automotive applications, please contact your local Panasonic Corporation technical representative.

# PhotoMOS® support various core industries

**Slim & Power**

**Flat & Power**

Power High Capacity type

Power DC only type

Power AC/DC dual use type

PD type

- Energy management
- Photovoltaic power generation
- Storage battery

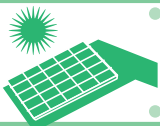

- Robots
- Machine tools
- Industrial machines



**Low on-resistance**

**Low on-resistance & Economical**

HF DC only type

HF AC/DC dual use type

HE type

- Office equipment
- Industrial machines
- Measuring instruments



**General use**

**Economical & General**

**High sensitivity**

GU type

GE type

HS type

- Game machines
- Security systems
- Data communications



**Low on-resistance & Low output capacitance**

RF type

- Data communications
- Measuring instruments
- Medical equipment

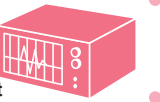

**Low current consumption & Guaranteed performance at high temperature**

CC type

- Probe cards
- Measuring instruments



- PD: Power DIP
- HF: High Functioned
- HE: High functioned and Economical
- RF: Radio Frequency
- GU: General Use
- GE: General use and Economical
- HS: High Sensitivity
- CC: Capacitor Coupled

Panasonic Corporation Electromechanical Control Business Division  
[industrial.panasonic.com/ac/e/](http://industrial.panasonic.com/ac/e/)

-3-

© Panasonic Corporation 2019

ASCTB312E 201905

## Channel configuration

- S** : 4 channels (16-pin)
- V** : 1 channels (6-pin)
- W** : 2 channels (8-pin)
- Y** : 1 channels (4-pin)
- Z** : 1 channels (SIL4-pin)

## Output configuration

- 1** : 1 Form A (DC)
- 2** : 1 Form A (AC/DC)
- 4** : 1 Form B (AC/DC)
- 6** : 1 Form A & 1 Form B (AC/DC)
- 2** : 2 Form B (AC/DC)

A = Normally open B = Normally closed

## Type

- 0** : HF type Low on-resistance Power type Slim and power
- 1** : GU type Wide variation GE type General use and Economical
- 2** : RF type Low on-resistance and low output capacitance
- 3** : HS type High sensitivity
- 5** : HE type Low on-resistance & Economical
- 6 9** : Power High Capacity type Slim and power
- 7** : PD type Flat and power
- C** : CC type Capacitor coupled isolation type NEW

## Load voltage

- 0** : 350V
- 1** : to 40V
- 2** : 50V to 60V
- 3** : 250V
- 4** : 400V
- 5** : 80V to 100V
- 6** : 600V
- 7** : 200V
- 8** : 1500V
- 9** : 1000V

**AQ Y 2 2 1 F E H L V Y**

## Driving method

- Nil** : Current-sensitive
- D** : Power type voltage-sensitive
- F** : Small size type voltage-sensitive (Recommend input voltage: 5V)

## Feature

- Nil** : Standard
- E** : Economical
- G** : High capacity
- N** : Low C × R
- R** : Low C × R

## I/O isolation voltage

- Nil** : Basic insulation (200V, 500V, 1500V, 2500V, 3000V)
- H** : Reinforced insulation (5000V)

## Current limit function

- Nil** : Non
- K** : With short circuit protection (latching)
- KL** : With short circuit protection (non-latching)
- L** : With current limiting

## Package

- Nil** : DIP (through hole terminal)
- A** : DIP (surface mount terminal)
- M** : SON
- S** : SOP
- T** : VSSOP
- V** : SSOP
- P** : TSON NEW

## Packing style

- Nil** : Tube
- X** : Tape and reel (DIP/SOP)
- Z** : Tape and reel (DIP/SOP)
- Y** : Tape and reel (SSOP/SON/VSSOP)
- W** : Tape and reel (SSOP/SON/VSSOP)

Valid only for combinations of products listed in the catalog (see "TYPES" in this catalog). Please inquire regarding combinations with products not listed in this catalog.

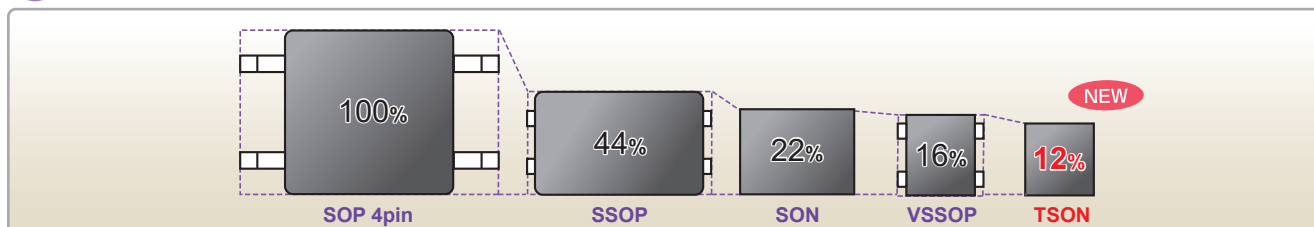

## ! Package size



# PhotoMOS<sup>®</sup> Selector Chart

**GU** General use & wide variation

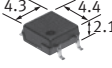
**GU** **GE** **CC** **RF** **HE** **HF** **HS** **PD** **Power**

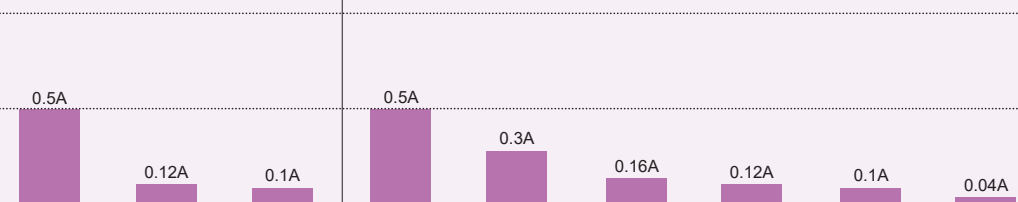
Product name		GU SOP										
Contact configuration		1 Form A					1 Form A					
Number of terminals		4pin					6pin					
Appearance configuration *Standoff height included												
Features		Miniature SOP4-pin type of 60V/350V/400V load voltage					Miniature SOP6-pin type of 60 to 600V load voltage					
Part No.		<b>AQY212S</b>	<b>AQY210S</b>	<b>AQY214S</b>	<b>AQV212S</b>	<b>AQV215S</b>	<b>AQV217S</b>	<b>AQV210S</b>	<b>AQV214S</b>	<b>AQV216S</b>		
Output	Load voltage	AC/DC					AC/DC					
		Peak AC	60V	350V	400V	60V	100V	200V	350V	400V	600V	
		DC	60V	350V	400V	60V	100V	200V	350V	400V	600V	
	Continuous load current	1A										
	Peak load current		1.5A	0.3A	0.24A	1.5A	0.9A	0.48A	0.3A	0.3A	0.12A	
	Power dissipation		300mW			450mW						
	On resistance	Typ.	0.83Ω	17Ω	25Ω	0.83Ω	2.3Ω	11Ω	23Ω	30Ω	70Ω	
		Max.	2.5 Ω	25Ω	35Ω	2.5 Ω	4.0Ω	15Ω	35Ω	50Ω	120Ω	
	Output capacitance (Typ.)		80pF	45pF		80pF	110pF	70pF	45pF			
	Off state leakage current (Max.)		1μA			1μA						
Input	LED forward current	50mA					50mA					
	LED reverse voltage	5V					5V					
	Peak forward current	1A					1A					
	Power dissipation	75mW					75mW					
	LED operate current	Typ.	0.9 mA					0.7 mA				
		Max.	3 mA					3 mA				
	LED turn off current	Min.	0.4 mA					0.4 mA				
		Typ.	0.85mA					0.65mA				
LED dropout voltage	Typ.	1.25V (1.14V at I <sub>F</sub> = 5mA)					1.25V (1.14V at I <sub>F</sub> = 5mA)					
	Max.	1.5V					1.5V					
Turn on time	Typ.	0.65ms	0.23ms	0.21ms	0.65ms	0.60ms	0.25ms	0.25ms	0.28ms			
	Max.	2 ms	0.5 ms	0.5 ms	2 ms	2 ms	1 ms	0.5 ms	0.5 ms			
Turn off time	Typ.	0.08ms	0.04ms		0.08ms	0.06ms	0.05ms		0.04ms			
	Max.	0.2 ms	0.2 ms		0.2 ms	0.2 ms	0.2 ms		0.2 ms			
Total power dissipation		350mW					500mW					
I/O isolation voltage		1,500Vrms					1,500Vrms					
I/O capacitance	Typ.	—					0.8pF					
	Max.	1.5pF					1.5pF					
Initial I/O isolation resistance (Min.)		1,000MΩ					1,000MΩ					
Safety standards		UL/C-UL, BSI					UL/C-UL					
Mass (weight) (approx.)		0.084g					0.125g					

# PhotoMOS® Selector Chart

**GU** General use & wide variation

**GU** **GE** **CC** **RF** **HE** **HF** **HS** **PD** **Power**

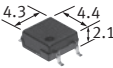
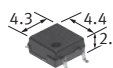
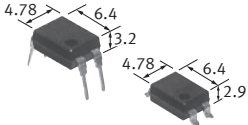
Product name		GU SOP High Capacity				GU SOP High Capacity Voltage-sensitive	GU High Capacity	
Contact configuration		1 Form A				1 Form A	1 Form A	
Number of terminals		4pin				4pin	4pin	
Appearance configuration *Standoff height included  mm								
Features		Miniature SOP4-pin type with high capacity up to 1.6A				Space-saving SOP4-pin high capacity type with built-in input register	4-pin high capacity of 1.1A, I/O isolation voltage of 5,000V	
Part No.		<b>AQY211G2S</b>	<b>AQY212G2S</b>	<b>AQY212GS</b>	<b>AQY217GS</b> <span style="color:red">NEW</span>	<b>AQY212FG2S</b>	<b>AQY212GH</b>	
Output	Load voltage	AC/DC				AC/DC	AC/DC	
		Peak AC	40V	60V	200V	60V	60V	
		DC	40V	60V	200V	60V	60V	
	Continuous load current	1.5A	1.6A	1.25A	1A	0.4A	1.25A	1.1A
	Peak load current	4.0A	3.0A	3.0A	1.2A	3.0A	3.0A	
	Power dissipation	400mW				400mW	500mW	
	On resistance	Typ.	0.1 Ω	0.2Ω	0.34Ω	1.8Ω	0.2Ω	0.34Ω
		Max.	0.15Ω	0.5Ω	0.7 Ω	2.5Ω	0.5Ω	0.7 Ω
	Output capacitance (Typ.)	180pF	150pF	220pF	85pF	150pF	220pF	
	Off state leakage current (Max.)	1μA				1μA	1μA	
Input	LED forward current	50mA				Input voltage: 6V	50mA	
	LED reverse voltage	5V				Input reverse voltage: 5V	5V	
	Peak forward current	1A				—	1A	
	Power dissipation	75mW				65mW	75mW	
	LED operate current	Typ.	0.9mA	1.1mA	0.75mA	Operate voltage: 1.4V	1.1mA	
		Max.	3 mA	3 mA	3 mA	Operate voltage: 4 V	3 mA	
	LED turn off current	Min.	0.2mA	0.3mA	0.2 mA	Turn off voltage: 0.8V	0.3mA	
		Typ.	0.8mA	1 mA	0.7 mA	Turn off voltage: 1.4V	1 mA	
	LED dropout voltage	Typ.	1.32V (1.14V at IF = 5mA)				Input current: 8.5mA	1.32V (1.14V at IF = 5mA)
		Max.	1.5V				(VIN = 5V)	1.5V
Turn on time	Typ.	1 ms	1.3ms	1.2 ms	0.7ms	1.3ms		
	Max.	3 ms	5 ms	5 ms	5 ms	5 ms		
Turn off time	Typ.	0.12ms	0.1ms	0.03ms	0.1ms	0.1ms		
	Max.	0.5 ms	0.5ms	0.2 ms	0.5ms	0.5ms		
Total power dissipation	450mW				450mW	550mW		
I/O isolation voltage	1,500Vrms				500Vrms	5,000Vrms		
I/O capacitance	Typ.	0.8pF				0.8pF	0.8pF	
	Max.	1.5pF				1.5pF	1.5pF	
Initial I/O isolation resistance (Min.)	1,000MΩ				1,000MΩ	1,000MΩ		
Safety standards	UL/C-UL, VDE			UL/C-UL	UL/C-UL, VDE	UL/C-UL, VDE		
Mass (weight) (approx.)	0.084g				0.084g	0.19g		



**GU** General use & wide variation

**GU** **GE** **CC** **RF** **HE** **HF** **HS** **PD** Power

Product name		GU							
Contact configuration		1 Form A							
Number of terminals		6pin							
Appearance configuration <small>*Standoff height included</small>									
Features		6-pin type for switching low-level analog signal							
Part No.		<b>AQV212</b>	<b>AQV215</b>	<b>AQV217</b>	<b>AQV210</b>	<b>AQV214</b>	<b>AQV216</b>	<b>AQV214H</b>	
Output	Load voltage	AC/DC							
		Peak AC	60V	100V	200V	350V	400V	600V	400V
	DC	60V	100V	200V	350V	400V	600V	400V	
	Continuous load current <small>*6-pin type: in case of A connection</small>	1A	0.55A	0.32A	0.18A	0.13A	0.12A	0.05A	0.12A
	Peak load current	1.5A	0.96A	0.54A	0.4A	0.3A	0.15A	0.3A	
	Power dissipation	500mW							
	On resistance <small>*6-pin type: in case of A connection</small>	Typ.	0.83Ω	2.3Ω	11Ω	23Ω	30Ω	70Ω	30Ω
		Max.	2.5 Ω	4 Ω	15Ω	35Ω	50Ω	120Ω	50Ω
	Output capacitance (Typ.)	80pF	110pF	70pF	45pF				
	Off state leakage current (Max.)	1μA							
Input	LED forward current	50mA							
	LED reverse voltage	5V							
	Peak forward current	1A							
	Power dissipation	75mW							
	LED operate current	Typ.	1 mA						1.3mA
		Max.	3 mA						3 mA
	LED turn off current	Min.	0.4 mA						0.4mA
		Typ.	0.79mA						1.2mA
LED dropout voltage	Typ.	1.25V (1.14V at I <sub>F</sub> = 5mA)							
	Max.	1.5V							
Turn on time	Typ.	0.65ms	0.60ms	0.25ms	0.25ms	0.21ms	0.28ms	0.6 ms	
	Max.	2 ms	2 ms	1 ms	0.5 ms	0.5 ms	0.5 ms	0.8 ms	
Turn off time	Typ.	0.08ms	0.06ms	0.05ms	0.05ms	0.05ms	0.04ms	0.05ms	
	Max.	0.2 ms	0.2 ms	0.2 ms	0.2 ms	0.2 ms	0.2 ms	0.2 ms	
Total power dissipation	550mW								
I/O isolation voltage	1,500Vrms						5,000Vrms		
I/O capacitance	Typ.	0.8pF							
	Max.	1.5pF							
Initial I/O isolation resistance (Min.)	1,000MΩ								
Safety standards	UL/C-UL						UL/C-UL, BSI		
Mass (weight) (approx.)	0.453g								

# PhotoMOS® Selector Chart

**GU** General use & wide variation

**GU** **GE** **CC** **RF** **HE** **HF** **HS** **PD** **Power**

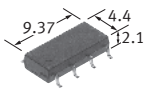
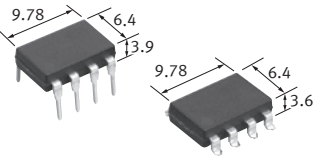
Product name		GU SOP			GU						
Contact configuration		2 Form A			2 Form A						
Number of terminals		8pin			8pin						
Appearance configuration <small>*Standoff height included</small>											
Features		Miniature SOP8-pin type of 60V/350V/400V load voltage			Compact DIP8-pin type of 60V to 600V load voltage						
Part No.		<b>AQW212S</b>	<b>AQW210S</b>	<b>AQW214S</b>	<b>AQW212</b>	<b>AQW215</b>	<b>AQW217</b>	<b>AQW210</b>	<b>AQW214</b>	<b>AQW216</b>	
Output	Load voltage	AC/DC			AC/DC						
		Peak AC	60V	350V	400V	60V	100V	200V	350V	400V	600V
	DC	60V	350V	400V	60V	100V	200V	350V	400V	600V	
	Continuous load current	1A									
		0.5A	0.4A	0.1A	0.08A	0.5A	0.3A	0.16A	0.12A	0.1A	0.04A
	Peak load current	1.5A	0.3A	0.24A	1.5A	0.9A	0.48A	0.36A	0.3A	0.12A	
	Power dissipation	600mW			800mW						
	On resistance	Typ.	0.83Ω	16Ω	30Ω	0.83Ω	2.3Ω	11Ω	23Ω	30Ω	70Ω
		Max.	2.5 Ω	35Ω	50Ω	2.5 Ω	4 Ω	15Ω	35Ω	50Ω	120Ω
	Output capacitance (Typ.)	80pF	45pF		80pF	110pF	70pF	45pF			
Off state leakage current (Max.)	1μA			1μA							
Input	LED forward current	50mA			50mA						
	LED reverse voltage	5V			5V						
	Peak forward current	1A			1A						
	Power dissipation	75mW			75mW						
	LED operate current	Typ.	0.9mA			0.9mA					
		Max.	3 mA			3 mA					
	LED turn off current	Min.	0.4mA			0.4mA					
		Typ.	0.8mA			0.8mA					
LED dropout voltage	Typ.	1.25V (1.14V at I <sub>F</sub> = 5mA)			1.25V (1.14V at I <sub>F</sub> = 5mA)						
	Max.	1.5V			1.5V						
Turn on time	Typ.	0.65ms	0.23ms	0.21ms	0.65ms	0.60ms	0.25ms	0.25ms	0.31ms	0.28ms	
	Max.	2 ms	0.5 ms	0.5 ms	2 ms	2 ms	1.0 ms	0.5 ms	0.5 ms	0.5 ms	
Turn off time	Typ.	0.08ms	0.04ms		0.08ms	0.06ms	0.05ms			0.04ms	
	Max.	0.2 ms	0.2 ms		0.2 ms	0.2 ms	0.2 ms			0.2 ms	
Total power dissipation	650mW			850mW							
I/O isolation voltage	1,500Vrms			1,500Vrms							
I/O capacitance	Typ.	0.8pF			0.8pF						
	Max.	1.5pF			1.5pF						
Initial I/O isolation resistance (Min.)	1,000MΩ			1,000MΩ							
Safety standards	UL/C-UL, BSI			UL/C-UL							
Mass (weight) (approx.)	0.195g			0.5g							

**GU** General use & wide variation

**GU** **GE** **CC** **RF** **HE** **HF** **HS** **PD** **Power**

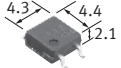
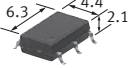
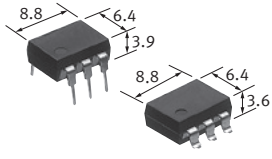
Product name		GU SOP			GU		
Contact configuration		1 Form B			1 Form B		
Number of terminals		4pin			6pin		
Appearance configuration <small>*Standoff height included</small>							
mm							
Features		Normally closed SOP4-pin type of 60V/350V/400V load voltage			Normally closed SOP6-pin type of 400V load voltage		
Part No.		<b>AQY412S</b>	<b>AQY410S</b>	<b>AQY414S</b>	<b>AQV414S</b>	<b>AQV414</b>	
Output	Load voltage	AC/DC					
		Peak AC	60V	350V	400V	400V	400V
	DC	60V	350V	400V	400V	400V	
	Continuous load current <small>*6-pin type: in case of A connection</small>	1A					
		0.5A	0.5A	0.12A	0.1A	0.1A	0.12A
	Peak load current	1.5A	0.3A	0.24A	0.3A	0.3A	
	Power dissipation	300mW			450mW	500mW	
	On resistance <small>*6-pin type: in case of A connection</small>	Typ.	1Ω	18Ω	26Ω	26Ω	26Ω
		Max.	2.5Ω	25Ω	35Ω	50Ω	50Ω
	Output capacitance (Typ.)	500pF					
Off state leakage current (Max.)	1μA						
Input	LED forward current	50mA					
	LED reverse voltage	5V					
	Peak forward current	1A					
	Power dissipation	75mW					
	LED operate current	Typ.	0.9 mA			0.6 mA	1 mA
		Max.	3 mA			3 mA	3 mA
	LED turn off current	Min.	0.4 mA			0.4 mA	0.4 mA
		Typ.	0.85mA			0.55mA	0.95mA
LED dropout voltage	Typ.	1.25V (1.14V at I <sub>F</sub> = 5mA)			1.25V (1.14V at I <sub>F</sub> = 5mA)	1.25V (1.14V at I <sub>F</sub> = 5mA)	
	Max.	1.5V			1.5V	1.5V	
Turn on time	Typ.	0.9 ms	0.52ms	0.47ms	0.47ms	0.47ms	
	Max.	3 ms	1 ms	1 ms	1 ms	1 ms	
Turn off time	Typ.	0.21ms	0.23ms	0.28ms	0.28ms	0.28ms	
	Max.	1 ms	1 ms	1 ms	1 ms	1 ms	
Total power dissipation	350mW			500mW	550mW		
I/O isolation voltage	1,500Vrms						
I/O capacitance	Typ.	0.8pF			0.8pF	0.8pF	
	Max.	1.5pF			1.5pF	1.5pF	
Initial I/O isolation resistance (Min.)	1,000MΩ						
Safety standards	UL/C-UL, VDE	UL/C-UL, BSI			UL/C-UL	UL/C-UL	
Mass (weight) (approx.)	0.084g			0.125g	0.453g		

# PhotoMOS® Selector Chart

**GU**

General use & wide variation

**GU**

GE

CC

RF

HE

HF

HS

PD

Power

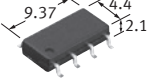
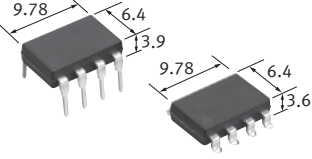
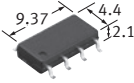
Product name		GU SOP	GU	GU SOP		
Contact configuration		2 Form B	2 Form B	1 Form A & 1 Form B		
Number of terminals		8pin	8pin	8pin		
Appearance configuration <small>*Standoff height included</small>						
Features		Normally closed SOP8-pin type of 400V load voltage	Normally closed DIP8-pin type of 400V load voltage	Both N.O. and N.C. contacts incorporated in a small SOP8-pin package		
Part No.		<b>AQW414S</b>	<b>AQW414</b>	<b>AQW612S</b>	<b>AQW610S</b>	
Output	Load voltage	AC/DC	AC/DC	AC/DC		
		Peak AC	400V	400V	60V	350V
		DC	400V	400V	60V	350V
	Continuous load current	1A				
		0.5A				
	Peak load current	0.08A	0.1A	0.45A	0.1A	
	Power dissipation	600mW	800mW	600mW		
	On resistance	Typ.	26Ω	26Ω	1 Ω	18Ω
		Max.	50Ω	50Ω	2.5Ω	25Ω
	Output capacitance (Typ.)	100pF	100pF	80pF (N.O.), 500pF (N.C.)		
Off state leakage current (Max.)	1μA	1μA	1μA			
Input	LED forward current	50mA	50mA	50mA		
	LED reverse voltage	5V	5V	5V		
	Peak forward current	1A	1A	1A		
	Power dissipation	75mW	75mW	75mW		
	LED operate current	Typ.	0.9mA	0.7 mA	0.9mA	
		Max.	3 mA	3 mA	3 mA	
	LED turn off current	Min.	0.4mA	0.4 mA	0.4mA	
		Typ.	0.8mA	0.64mA	0.8mA	
LED dropout voltage	Typ.	1.25V (1.14V at I <sub>F</sub> = 5mA)	1.25V (1.14V at I <sub>F</sub> = 5mA)	1.25V (1.14V at I <sub>F</sub> = 5mA)		
	Max.	1.5V	1.5V	1.5V		
Turn on time	Typ.	0.43ms	0.46ms	0.65ms (N.O.), 0.9ms (N.C.)	0.28ms (N.O.), 0.52ms (N.C.)	
	Max.	1 ms	1 ms	3ms	1ms	
Turn off time	Typ.	0.3 ms	0.40ms	0.08ms (N.O.), 0.2ms (N.C.)	0.04ms (N.O.), 0.23ms (N.C.)	
	Max.	1 ms	1 ms	1ms	1ms	
Total power dissipation	650mW	850mW	650mW			
I/O isolation voltage	1,500Vrms	1,500Vrms	1,500Vrms			
I/O capacitance	Typ.	0.8pF	0.8pF	0.8pF		
	Max.	1.5pF	1.5pF	1.5pF		
Initial I/O isolation resistance (Min.)	1,000MΩ	1,000MΩ	1,000MΩ			
Safety standards	UL/C-UL, BSI	UL/C-UL	UL/C-UL, VDE	UL/C-UL, BSI		
Mass (weight) (approx.)	0.195g	0.5g	0.195g			

**GU** General use & wide variation

**GU** **GE** **CC** **RF** **HE** **HF** **HS** **PD** **Power**

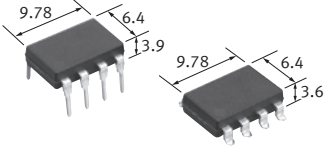
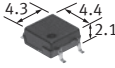
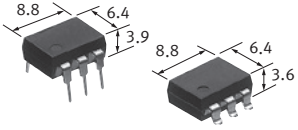
Product name		GU	GU SOP Short Circuit Protection (Latch type)	GU Short Circuit Protection (Non-latch type)	
Contact configuration		1 Form A & 1 Form B	1 Form A	1 Form A	
Number of terminals		8pin	4pin	6pin	
Appearance configuration <small>*Standoff height included</small>					
Features		Both N.O. and N.C. contacts incorporated in a DIP8-pin package	Small SOP4-pin type with short circuit protecting (Latch type)	Short circuit protection (Non-latch type) only for DC load	
Part No.		<b>AQW614</b>	<b>AQY210KS</b>	<b>AQV112KL</b>	
Output	Load voltage	AC/DC	AC/DC	DC	
		Peak AC	400V	350V	—
		DC	400V	350V	60V
	Continuous load current <small>*6-pin type: in case of A connection</small>	1A			
		0.5A			0.5A
	Peak load current	0.3A	0.2A (Cut off current [Typ.])	—	
	Power dissipation	800mW	400mW	500mW	
	On resistance <small>*6-pin type: in case of A connection</small>	Typ.	27Ω	23.5Ω	0.55Ω
		Max.	50Ω	35 Ω	2 Ω
	Output capacitance (Typ.)	45pF (N.O.) , 100pF (N.C.)		42pF	300pF
Off state leakage current (Max.)	1μA		1μA	1μA	
Input	LED forward current	50mA	50mA	50mA	
	LED reverse voltage	5V	5V	5V	
	Peak forward current	1A	1A	1A	
	Power dissipation	75mW	75mW	75mW	
	LED operate current	Typ.	0.9mA	1.1mA	0.8mA
		Max.	3 mA	3 mA	10 mA
	LED turn off current	Min.	0.4mA	0.3mA	0.3mA
		Typ.	0.8mA	1 mA	0.7mA
LED dropout voltage	Typ.	1.25V (1.14V at I <sub>F</sub> = 5mA)	1.13V (1.32V at I <sub>F</sub> = 50mA)	1.17V (1.35V at I <sub>F</sub> = 50mA)	
	Max.	1.5V	1.5V	1.5V	
Turn on time	Typ.	0.28ms (N.O.) , 0.43ms (N.C.)	0.7 ms	2.0ms	
	Max.	1ms	2.0 ms	5.0ms	
Turn off time	Typ.	0.04ms (N.O.) , 0.3ms (N.C.)	0.07ms	0.1ms	
	Max.	1ms	1 ms	1 ms	
Total power dissipation	850mW		450mW	550mW	
I/O isolation voltage	1,500Vrms		1,500Vrms	1,500Vrms	
I/O capacitance	Typ.	0.8pF	0.8pF	0.8pF	
	Max.	1.5pF	1.5pF	1.5pF	
Initial I/O isolation resistance (Min.)	1,000MΩ		1,000MΩ	1,000MΩ	
Safety standards	UL/C-UL		UL/C-UL, BSI	UL/C-UL, VDE	
Mass (weight) (approx.)	0.5g		0.084g	0.453g	

# PhotoMOS® Selector Chart

**GU** General use & wide variation

**GU** GE CC RF HE HF HS PD Power

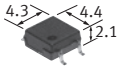
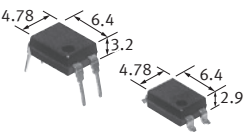
Product name		GU SOP Current Limiting	GU Current Limiting	
Contact configuration		1 Form A	1 Form A	
Number of terminals		4pin	4pin	
Appearance configuration *Standoff height included  mm				
Features		Miniature SOP4-pin type with current limiting	DIP4-pin type with current limiting and reinforced insulation	
Part No.		<b>AQY210LS</b>	<b>AQY210HL</b>	
Output	Load voltage	AC/DC	AC/DC	
		Peak AC	350V	350V
		DC	350V	350V
	Continuous load current	1A		
		0.5A		
	Peak load current	0.12A	0.12A	
	Peak load current	0.18A (Output Limit Current [Typ.])	0.18A (Output Limit Current [Typ.])	
	Power dissipation	400mW	500mW	
	On resistance	Typ.	20Ω	20Ω
		Max.	25Ω	25Ω
	Output capacitance (Typ.)	45pF	45pF	
	Off state leakage current (Max.)	1μA	1μA	
	Input	LED forward current	50mA	50mA
LED reverse voltage		5V	5V	
Peak forward current		1A	1A	
Power dissipation		75mW	75mW	
LED operate current		Typ.	1.2mA	1.2mA
		Max.	3 mA	3 mA
LED turn off current		Min.	0.4mA	0.4mA
		Typ.	1.1mA	1.1mA
LED dropout voltage	Typ.	1.25V (1.14V at I <sub>F</sub> = 5mA)	1.25V (1.14V at I <sub>F</sub> = 5mA)	
	Max.	1.5V	1.5V	
Turn on time	Typ.	0.5 ms	0.5 ms	
	Max.	2 ms	2 ms	
Turn off time	Typ.	0.08ms	0.08ms	
	Max.	1 ms	1 ms	
Total power dissipation	450mW	550mW		
I/O isolation voltage	1,500Vrms	5,000Vrms		
I/O capacitance	Typ.	0.8pF	0.8pF	
	Max.	1.5pF	1.5pF	
Initial I/O isolation resistance (Min.)	1,000MΩ	1,000MΩ		
Safety standards	UL/C-UL, BSI			
Mass (weight) (approx.)	0.084g	0.19g		

**GE** General use and Economical

GU **GE** CC RF HE HF HS PD Power

Product name		GE					
Contact configuration		1 Form A					
Number of terminals		4pin					
Appearance configuration <small>*Standoff height included</small>							
Features		DIP4-pin type with reinforced insulation					
Part No.		AQY211EH	AQY212EH	AQY210EH	AQY214EH	AQY216EH	
Output	Load voltage	AC/DC					
		Peak AC	30V	60V	350V	400V	600V
		DC	30V	60V	350V	400V	600V
	Continuous load current	1A	1A	0.55A	0.13A	0.12A	0.05A
		0.5A					
	Peak load current	3A	1.5A	0.4A	0.3A	0.15A	
	Power dissipation	500mW					
	On resistance	Typ.	0.25Ω	0.85Ω	18Ω	26Ω	52Ω
		Max.	0.5 Ω	2.5 Ω	25Ω	35Ω	120Ω
	Output capacitance (Typ.)		240pF	80pF	45pF		35pF
Off state leakage current (Max.)		1μA					
Input	LED forward current	50mA					
	LED reverse voltage	5V					
	Peak forward current	1A					
	Power dissipation	75mW					
	LED operate current	Typ.	1.2mA				
		Max.	3 mA				
	LED turn off current	Min.	0.4mA				
		Typ.	1.1mA				
LED dropout voltage	Typ.	1.25V (1.14V at I <sub>f</sub> = 5mA)					
	Max.	1.5V					
Turn on time	Typ.	1.5ms	1 ms	0.5ms			
	Max.	5 ms	4 ms	2 ms			
Turn off time	Typ.	0.1ms	0.05ms	0.08ms		0.04ms	
	Max.	1 ms	1 ms	1 ms		1 ms	
Total power dissipation		550mW					
I/O isolation voltage		5,000Vrms					
I/O capacitance	Typ.	0.8pF					
	Max.	1.5pF					
Initial I/O isolation resistance (Min.)		1,000MΩ					
Safety standards		UL/C-UL	UL/C-UL, BSI				
Mass (weight) (approx.)		0.19g					

# PhotoMOS® Selector Chart

GE

General use and Economical

GU

GE

CC

RF

HE

HF

HS

PD

Power

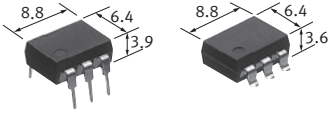
Product name		GE		
Contact configuration		1 Form A		
Number of terminals		6pin		
Appearance configuration <small>*Standoff height included</small>				
mm				
Features		DIP6-pin type, reinforced insulation available		
Part No.		AQV210EH	AQV214EH	
Output	Load voltage	AC/DC		
		Peak AC	350V	400V
		DC	350V	400V
	Continuous load current <small>*6-pin type: in case of A connection</small>	1A		
		0.5A		
	Peak load current	0.13A	0.12A	
	Power dissipation	500mW		
	On resistance <small>*6-pin type: in case of A connection</small>	Typ.	23Ω	30Ω
		Max.	35Ω	50Ω
	Output capacitance (Typ.)	45pF		
Off state leakage current (Max.)	1μA			
Input	LED forward current	50mA		
	LED reverse voltage	5V		
	Peak forward current	1A		
	Power dissipation	75mW		
	LED operate current	Typ.	1.6mA	
		Max.	3 mA	
	LED turn off current	Min.	0.4mA	
		Typ.	1.5mA	
LED dropout voltage	Typ.	1.25V (1.14V at I <sub>F</sub> = 5mA)		
	Max.	1.5V		
Turn on time	Typ.	0.7 ms		
	Max.	2 ms		
Turn off time	Typ.	0.05ms		
	Max.	1 ms		
Total power dissipation	550mW			
I/O isolation voltage	5,000Vrms			
I/O capacitance	Typ.	0.8pF		
	Max.	1.5pF		
Initial I/O isolation resistance (Min.)	1,000MΩ			
Safety standards	UL/C-UL, BSI			
Mass (weight) (approx.)	0.453g			



**GE** General use and Economical

GU **GE** CC RF HE HF HS PD Power

Product name		GE				
Contact configuration		2 Form A				
Number of terminals		8pin				
Appearance configuration <small>*Standoff height included</small>						
Features		DIP8-pin type with reinforced insulation				
Part No.		AQW212EH	AQW210EH	AQW214EH	AQW216EH	
Output	Load voltage	AC/DC				
		Peak AC	60V	350V	400V	600V
		DC	60V	350V	400V	600V
	Continuous load current	1A				
		0.5A	0.5A	0.12A	0.1A	0.04A
	Peak load current	1.5A	0.36A	0.3A	0.12A	
	Power dissipation	800mW				
	On resistance	Typ.	0.83Ω	18Ω	26Ω	52Ω
		Max.	2.5 Ω	25Ω	35Ω	120Ω
	Output capacitance (Typ.)	80pF	45pF		35pF	
Off state leakage current (Max.)	1μA					
Input	LED forward current	50mA				
	LED reverse voltage	5V				
	Peak forward current	1A				
	Power dissipation	75mW				
	LED operate current	Typ.	1.2mA			
		Max.	3 mA			
	LED turn off current	Min.	0.4mA			
		Typ.	1.1mA			
LED dropout voltage	Typ.	1.25V (1.14V at I <sub>F</sub> = 5mA)				
	Max.	1.5V				
Turn on time	Typ.	1.0ms	0.5ms			
	Max.	4.0ms	2 ms			
Turn off time	Typ.	0.08ms			0.04ms	
	Max.	1 ms			1 ms	
Total power dissipation	850mW					
I/O isolation voltage	5,000Vrms					
I/O capacitance	Typ.	0.8pF				
	Max.	1.5pF				
Initial I/O isolation resistance (Min.)	1,000MΩ					
Safety standards	UL/C-UL, BSI					
Mass (weight) (approx.)	0.4g					

# PhotoMOS® Selector Chart

**GE** General use and Economical

GU **GE** CC RF HE HF HS PD Power

Product name		GE						
Contact configuration		1 Form B			1 Form B			
Number of terminals		4pin			6pin			
Appearance configuration <small>*Standoff height included</small>								
Features		Normally closed type with reinforced insulation			Normally closed type with reinforced insulation			
Part No.		<b>AQY412EH</b>	<b>AQY410EH</b>	<b>AQY414EH</b>	<b>AQV412EH</b>	<b>AQV410EH</b>	<b>AQV414EH</b>	
Output	Load voltage	AC/DC			AC/DC			
		Peak AC	60V	350V	400V	60V	350V	400V
	DC	60V	350V	400V	60V	350V	400V	
	Continuous load current <small>*6-pin type: in case of A connection</small>	1A						
		0.5A	0.55A	0.13A	0.12A	0.55A	0.13A	0.12A
	Peak load current	1.5A	0.4A	0.3A	1.5A	0.4A	0.3A	
	Power dissipation	500mW			500mW			
	On resistance	Typ.	1 Ω	18Ω	26Ω	1 Ω	18Ω	25.2Ω
		Max.	2.5Ω	25Ω	35Ω	2.5Ω	35Ω	50 Ω
	Output capacitance (Typ.)		500pF	110pF	100pF	500pF	110pF	100pF
Off state leakage current (Max.)		10μA			10μA			
Input	LED forward current	50mA			50mA			
	LED reverse voltage	5V			5V			
	Peak forward current	1A			1A			
	Power dissipation	75mW			75mW			
	LED operate current	Typ.	1.4mA			1.9mA		
		Max.	3 mA			3 mA		
	LED turn off current	Min.	0.4mA			0.4mA		
		Typ.	1.3mA			1.8mA		
LED dropout voltage	Typ.	1.25V (1.14V at I <sub>F</sub> = 5mA)			1.25V (1.14V at I <sub>F</sub> = 5mA)			
	Max.	1.5V			1.5V			
Turn on time	Typ.	3 ms	1 ms	0.8ms	3ms	1.5ms	1.3ms	
	Max.	10 ms	3 ms	3 ms	8ms	3 ms	3 ms	
Turn off time	Typ.	0.2ms	0.3ms	0.2ms	0.3ms			
	Max.	1 ms	1 ms	1 ms	1.5ms			
Total power dissipation		550mW			550mW			
I/O isolation voltage		5,000Vrms			5,000Vrms			
I/O capacitance	Typ.	0.8pF			0.8pF			
	Max.	1.5pF			1.5pF			
Initial I/O isolation resistance (Min.)		1,000MΩ			1,000MΩ			
Safety standards		UL/C-UL, VDE	UL/C-UL, BSI		UL/C-UL, VDE	UL/C-UL, BSI		
Mass (weight) (approx.)		0.19g			0.453g			

**GE** General use and Economical

GU **GE** CC RF HE HF HS PD Power

Product name		GE				
Contact configuration		2 Form B		1 Form A & 1 Form B		
Number of terminals		8pin		8pin		
Appearance configuration <small>*Standoff height included</small>						
Features		Normally closed type with reinforced insulation		Both N.O. and N.C. contacts incorporated in a compact DIP8-pin Reinforced insulation		
Part No.		<b>AQW414EH</b>	<b>AQW612EH</b>	<b>AQW610EH</b>	<b>AQW614EH</b>	
Output	Load voltage	AC/DC		AC/DC		
		Peak AC	400V	60V	350V	400V
		DC	400V	60V	350V	400V
	Continuous load current	1A				
		0.5A		0.5A		
			0.1A		0.12A	0.1A
	Peak load current	0.3A		1.5A	0.36A	0.3A
	Power dissipation	800mW		800mW		
	On resistance	Typ.	26Ω	1 Ω	18Ω	26Ω
		Max.	35Ω	2.5Ω	25Ω	35Ω
Output capacitance (Typ.)	100pF		80pF (N.O.) , 500pF (N.C.)	45pF (N.O.) , 100pF (N.C.)		
Off state leakage current (Max.)	10μA		1μA (N.O.) , 10μA (N.C.)			
Input	LED forward current	50mA		50mA		
	LED reverse voltage	5V		5V		
	Peak forward current	1A		1A		
	Power dissipation	75mW		75mW		
	LED operate current	Typ.	1.3mA	1.4mA		
		Max.	3 mA	3 mA		
	LED turn off current	Min.	0.4mA	0.4mA		
Typ.		1.2mA	1.3mA			
LED dropout voltage	Typ.	1.25V (1.14V at I <sub>F</sub> = 5mA)	1.25V (1.14V at I <sub>F</sub> = 5mA)			
	Max.	1.5V	1.5V			
Turn on time	Typ.	0.8ms	1ms (N.O.) , 3ms (N.C.)	0.5ms (N.O.) , 1ms (N.C.)	0.5ms (N.O.) , 0.8ms (N.C.)	
	Max.	3 ms	4ms (N.O.) , 10ms (N.C.)	3ms	3ms	
Turn off time	Typ.	0.2ms	0.05ms (N.O.) , 0.2ms (N.C.)	0.08ms (N.O.) , 0.3ms (N.C.)	0.08ms (N.O.) , 0.2ms (N.C.)	
	Max.	1 ms	1ms	1ms	1ms	
Total power dissipation	850mW		850mW			
I/O isolation voltage	5,000Vrms		5,000Vrms			
I/O capacitance	Typ.	0.8pF	0.8pF			
	Max.	1.5pF	1.5pF			
Initial I/O isolation resistance (Min.)	1,000MΩ		1,000MΩ			
Safety standards	UL/C-UL, BSI		UL/C-UL, VDE	UL/C-UL, BSI		
Mass (weight) (approx.)	0.4g		0.4g			

# PhotoMOS® Selector Chart

**CC** Capacitor Coupled isolation

GU GE **CC** RF HE HF HS PD Power

Product name		CC TSON C × R				
Contact configuration		1 Form A				
Number of terminals		4pin				
Appearance configuration <small>*Standoff height included</small>						
mm						
Features		Super miniature TSON package, Capacitor Coupled isolation type				
Part No.		AQY2C1R6P	AQY2C1R2P			
Output	Load voltage	Peak AC	AC/DC	30V	40V	
		DC		30V	40V	
	Continuous load current	1A				
		0.5A		0.75A		0.3A
	Peak load current			1.5A		0.75A
	Power dissipation			250mW		
	On resistance	Typ.		0.2Ω (VIN = 5V)		0.8Ω (VIN = 5V)
		Max.		0.4Ω (VIN = 5V)		1.5Ω (VIN = 5V)
	Output capacitance (Typ.)			40pF		14.5pF
	Off state leakage current (Max.)			10nA		
Input	Input voltage		5.5V			
	Input reverse voltage		0.2V			
	Power dissipation		1.2mW			
	Operate voltage	Typ.		1.7V		1.8V
		Max.		2.5V		2.5V
	Turn off voltag	Min.		0.5V		0.5V
Typ.			1.5V		1.4V	
Input current	Typ.		0.09mA (VIN = 5V)			
	Max.		0.2 mA (VIN = 5V)			
Turn on time	Typ.		0.12ms (VIN = 5V)		0.06ms (VIN = 5V)	
	Max.		0.5 ms (VIN = 5V)		0.5 ms (VIN = 5V)	
Turn off time	Typ.		0.1 ms (VIN = 5V)		0.06ms (VIN = 5V)	
	Max.		0.5 ms (VIN = 5V)		0.5 ms (VIN = 5V)	
Total power dissipation			250mW			
I/O isolation voltage			200Vrms			
I/O capacitance	Typ.		1.2pF			
	Max.		3 pF			
Initial I/O isolation resistance (Min.)			—			
Safety standards			—			
Mass (weight) (approx.)			0.007g			

**CC** Capacitor Coupled isolation

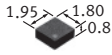

GU GE **CC** RF HE HF HS PD Power

Product name		CC TSON C × R			
Contact configuration		1 Form A			
Number of terminals		4pin			
Appearance configuration <small>*Standoff height included</small>					
Features		Super miniature TSON package, Capacitor Coupled isolation type			
Part No.		<b>NEW</b> AQY2C2R2P	<b>NEW</b> AQY2C1R3P	<b>NEW</b> AQY2C5R3P	
Output	Load voltage	Peak AC	AC/DC		
		DC	60V	40V	100V
	Continuous load current	1A			
		0.5A			
			0.3A	0.1A	0.12A
	Peak load current	0.9A	0.3A	0.3A	
	Power dissipation	250mW			
	On resistance	Typ.	0.9Ω (VIN = 5V)	10.5Ω (VIN = 5V)	9Ω (VIN = 5V)
		Max.	1.5Ω (VIN = 5V)	15 Ω (VIN = 5V)	14Ω (VIN = 5V)
	Output capacitance (Typ.)	27pF			
Off state leakage current (Max.)	10nA				
Input	Input voltage	5.5V			
	Input reverse voltage	0.2V			
	Power dissipation	1.2mW			
	Operate voltage	Typ.	1.7V	2.2V	2.0V
		Max.	2.5V	2.5V	2.5V
	Turn off voltag	Min.	0.5V	0.5V	0.5V
		Typ.	1.4V	1.5V	1.5V
Input current	Typ.	0.09mA (VIN = 5V)			
	Max.	0.2 ms (VIN = 5V)			
Turn on time	Typ.	0.08ms (VIN = 5V)	0.01ms (VIN = 5V)	0.03ms (VIN = 5V)	
	Max.	0.5 ms (VIN = 5V)	0.1 ms (VIN = 5V)	0.2 ms (VIN = 5V)	
Turn off time	Typ.	0.1 ms (VIN = 5V)	0.02ms (VIN = 5V)	0.04ms (VIN = 5V)	
	Max.	0.5 ms (VIN = 5V)	0.2 ms (VIN = 5V)	0.5 ms (VIN = 5V)	
Total power dissipation	250mW				
I/O isolation voltage	200Vrms				
I/O capacitance	Typ.	1.2pF			
	Max.	3 pF			
Initial I/O isolation resistance (Min.)	—				
Safety standards	—				
Mass (weight) (approx.)	0.007g				

# PhotoMOS® Selector Chart

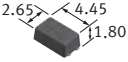

**RF** Low on-resistance & low output capacitance

GU GE CC **RF** HE HF HS PD Power

Product name		RF SSOP C × R3	RF VSSOP C × R3	
Contact configuration		1 Form A	1 Form A	
Number of terminals		4pin	4pin	
Appearance configuration *Standoff height included  mm				
Features		C×R3 type, SSOP package, 20 V load voltage	C×R3 type, VSSOP package, 20 V load voltage	
Part No.		<b>AQY221N5V</b>	<b>AQY221N5T</b>	
Output	Load voltage	AC/DC	AC/DC	
		Peak AC	20V	
		DC	20V	
	Continuous load current	1A		
		0.5A		
	Peak load current	0.18A	0.18A	
	Power dissipation	250mW	250mW	
	On resistance	Typ.	2.8Ω	2.8Ω
		Max.	4.5Ω	4.5Ω
	Output capacitance (Typ.)	1.1pF	1.1pF	
Off state leakage current (Max.)	10nA	10nA		
Input	LED forward current	50mA	50mA	
	LED reverse voltage	5V	5V	
	Peak forward current	1A	1A	
	Power dissipation	75mW	75mW	
	LED operate current	Typ.	0.8mA	0.7mA
		Max.	3 mA	3 mA
	LED turn off current	Min.	0.2mA	0.2mA
		Typ.	0.7mA	0.6mA
LED dropout voltage	Typ.	1.35V (1.14V at I <sub>F</sub> = 5mA)	1.14V (1.35V at I <sub>F</sub> = 50mA)	
	Max.	1.5V	1.5V	
Turn on time	Typ.	0.02ms	0.02ms	
	Max.	0.2 ms	0.2 ms	
Turn off time	Typ.	0.01ms	0.01ms	
	Max.	0.2 ms	0.2 ms	
Total power dissipation	300mW	300mW		
I/O isolation voltage	1,500Vrms	200Vrms		
I/O capacitance	Typ.	0.8pF	0.4pF	
	Max.	1.5pF	1.5pF	
Initial I/O isolation resistance (Min.)	1,000MΩ	—		
Safety standards	—	—		
Mass (weight) (approx.)	0.064g	0.026g		

**RF** Low on-resistance & low output capacitance



GU GE CC **RF** HE HF HS PD Power

Product name		RF VSSOP C × R5	RF VSSOP C × R10			
Contact configuration		1 Form A	1 Form A			
Number of terminals		4pin	4pin			
Appearance configuration *Standoff height included  mm						
Features		4.6 mm <sup>2</sup> mounting area C×R 10: 30 V/40 V load voltage C×R 5: 25 V load voltage				
Part No.		<b>AQY221N3T</b>	<b>AQY221R6T</b>	<b>AQY221R2T</b>	<b>AQY221N2T</b>	
Output	Load voltage	AC/DC		AC/DC		
		Peak AC	25V	30V	40V	
		DC	25V	30V	40V	
	Continuous load current	1A			0.8A	
		0.5A	0.15A		0.25A	0.12A
	Peak load current	—	1.5A	0.75A	—	
	Power dissipation	250mW	250mW			
	On resistance	Typ.	5.5Ω	0.18Ω	0.8 Ω	9.5Ω
		Max.	7.5Ω	0.35Ω	1.25Ω	12.5Ω
	Output capacitance (Typ.)		1.1pF	37.5pF	14pF	1.1pF
Off state leakage current (Max.)		10nA	10nA			
Input	LED forward current	50mA	50mA			
	LED reverse voltage	5V	5V			
	Peak forward current	1A	1A			
	Power dissipation	75mW	75mW			
	LED operate current	Typ.	0.7mA	0.5mA	0.5mA	0.7mA
		Max.	3 mA	3 mA	3 mA	3 mA
	LED turn off current	Min.	0.2mA	0.1mA	0.1mA	0.2mA
		Typ.	0.6mA	0.4mA	0.4mA	0.6mA
LED dropout voltage	Typ.	1.14V	1.14V			
	Max.	1.5 V	1.5 V			
Turn on time	Typ.	0.01ms	0.1 ms	0.1 ms	0.01ms	
	Max.	0.2 ms	0.5 ms	0.5 ms	0.2 ms	
Turn off time	Typ.	0.03ms	0.06ms	0.06ms	0.03ms	
	Max.	0.2 ms	0.2 ms	0.2 ms	0.2 ms	
Total power dissipation		300mW	300mW			
I/O isolation voltage		200Vrms	200Vrms			
I/O capacitance	Typ.	0.4pF	0.4pF			
	Max.	1.5pF	1.5pF			
Initial I/O isolation resistance (Min.)		—	—			
Safety standards		—	—			
Mass (weight) (approx.)		0.026g	0.026g			

# PhotoMOS® Selector Chart

**RF** Low on-resistance & low output capacitance

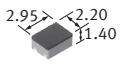
GU GE CC **RF** HE HF HS PD Power

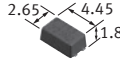
Product name		RF SON C × R5	RF SON C × R10		RF SSOP C × R5	
Contact configuration		1 Form A	1 Form A		1 Form A	
Number of terminals		4pin	4pin		4pin	
Appearance configuration *Standoff height included  mm						
Features		Micro-miniature SON package C×R10: 40V load voltage C×R5: 25V load voltage			Miniature SSOP C×R10: 30 V/40 V load voltage C×R5: 25 V load voltage	
Part No.		<b>AQY221N3M</b>	<b>AQY221R2M</b>	<b>AQY221N2M</b>	<b>AQY221N3V</b>	
Output	Load voltage	AC/DC	AC/DC		AC/DC	
		Peak AC	25V	40V	40V	25V
		DC	25V	40V	40V	25V
	Continuous load current	1A				
		0.5A				
	Peak load current	0.15A	0.25A	0.12A	0.15A	
	Power dissipation	—	0.75A	—	0.4A	
	On resistance	250mW	250mW		250mW	
	Output capacitance (Typ.)	Typ.	5.5Ω	0.8 Ω	9.5Ω	5.5Ω
		Max.	7.5Ω	1.25Ω	12.5Ω	7.5Ω
Off state leakage current (Max.)	1.1pF	14pF	1.1pF	1pF		
LED forward current	10nA	10nA		10nA		
Input	LED forward current	50mA	50mA		50mA	
	LED reverse voltage	5V	5V		5V	
	Peak forward current	1A	1A		1A	
	Power dissipation	75mW	75mW		75mW	
	LED operate current	Typ.	1 mA	0.8mA	1 mA	1 mA
		Max.	3 mA	3 mA	3 mA	3 mA
	LED turn off current	Min.	0.2mA	0.1mA	0.2mA	0.2mA
		Typ.	0.9mA	0.7mA	0.9mA	0.9mA
LED dropout voltage	Typ.	1.35V (1.14V at I <sub>F</sub> = 5mA)	1.35V (1.14V at I <sub>F</sub> = 5mA)		1.35V (1.14V at I <sub>F</sub> = 5mA)	
	Max.	1.5V	1.5V		1.5V	
Turn on time	Typ.	0.02ms	0.2 ms	0.02ms	0.02ms	
	Max.	0.2 ms	0.5 ms	0.2 ms	0.2 ms	
Turn off time	Typ.	0.02ms	0.04ms	0.02ms	0.02ms	
	Max.	0.2 ms	0.2 ms	0.2 ms	0.2 ms	
Total power dissipation	300mW	300mW		300mW		
I/O isolation voltage	200Vrms	200Vrms		1,500Vrms		
I/O capacitance	Typ.	0.8pF	0.8pF		0.8pF	
	Max.	1.5pF	1.5pF		1.5pF	
Initial I/O isolation resistance (Min.)	—	—		1,000MΩ		
Safety standards	—	—		—		
Mass (weight) (approx.)	0.024g	0.024g		0.064g		



**RF** Low on-resistance & low output capacitance

GU GE CC **RF** HE HF HS PD Power

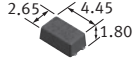
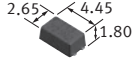
Product name		RF SSOP C × R10				RF SSOP C × R10 Voltage-sensitive		
Contact configuration		1 Form A				1 Form A		
Number of terminals		4pin				4pin		
Appearance configuration *Standoff height included  mm								
Features		Miniature SSOP C×R10: 30 V/40 V load voltage C×R5: 25 V load voltage				Space-saving SSOP 1 Form A type with built-in resistor 40V load voltage		
Part No.		<b>AQY221R2V</b>	<b>AQY221R4V</b>	<b>AQY221N2V</b>	<b>AQY221R6V</b>	<b>AQY221FR2V</b>	<b>AQY221FN2V</b>	
Output	Load voltage	AC/DC						
		Peak AC	40V	40V	40V	30V	40V	40V
		DC	40V	40V	40V	30V	40V	40V
	Continuous load current	1A					1A	
		0.5A	0.25A	0.5A	0.12A	1.5A	0.25A	0.12A
	Peak load current	0.75A	1A	0.3A	1.5A	0.75A	0.2A	
	Power dissipation	250mW				250mW		
	On resistance	Typ.	0.75Ω	0.55Ω	9.5Ω	0.18Ω	0.75Ω	9.5Ω
		Max.	1.25Ω	1 Ω	12.5Ω	0.35Ω	1.25Ω	12.5Ω
	Output capacitance (Typ.)		12.5pF	24pF	1pF	37.5pF	12.5pF	1pF
Off state leakage current (Max.)		10nA				10nA		
Input	LED forward current	50mA				Input voltage: 6V		
	LED reverse voltage	5V				Input reverse voltage: 5V		
	Peak forward current	1A				—		
	Power dissipation	75mW				65mW		
	LED operate current	Typ.	0.9mA		1 mA	0.7mA	Operate voltage: 1.3V	
		Max.	3 mA		3 mA	3 mA	Operate voltage: 4 V	
	LED turn off current	Min.	0.1mA		0.2mA	0.1mA	Turn off voltage: 0.8V	
		Typ.	0.8mA		0.9mA	0.6mA	Turn off voltage: 1.3V	
LED dropout voltage	Typ.	1.35V (1.14V at I <sub>F</sub> = 5mA)				Input current (Typ.) : 8.5mA (V <sub>IN</sub> = 5V)		
	Max.	1.5V						
Turn on time	Typ.	0.1ms	0.25ms	0.02ms	0.2 ms	0.05ms	0.01ms	
	Max.	0.5ms	0.75ms	0.5 ms	0.5 ms	0.5 ms	0.5 ms	
Turn off time	Typ.	0.08ms		0.02ms	0.07ms	0.06ms	0.03ms	
	Max.	0.2 ms		0.2 ms	0.2 ms	0.2 ms	0.2 ms	
Total power dissipation		300mW				300mW		
I/O isolation voltage		1,500Vrms				500Vrms		
I/O capacitance	Typ.	0.8pF				0.8pF		
	Max.	1.5pF				1.5pF		
Initial I/O isolation resistance (Min.)		1,000MΩ				1,000MΩ		
Safety standards		—				—		
Mass (weight) (approx.)		0.064g				0.064g		

# PhotoMOS® Selector Chart

**RF** Low on-resistance & low output capacitance

GU GE CC **RF** HE HF HS PD Power

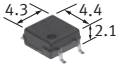
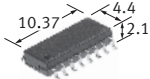
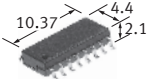
Product name		RF SOP C × R10		RF SOP C × R10		RF SOP C×R10 Voltage-sensitive		
Contact configuration		1 Form A		4 Form A		4 Form A		
Number of terminals		4pin		16pin		16pin		
Appearance configuration *Standoff height included  mm								
Features		Miniature SOP4-pin C×R10 40V load voltage		Space-saving low C×R type 4 channels in a SOP16-pin package		Space-saving 4-channel type Built-in input resistor		
Part No.		<b>AQY221R2S</b>	<b>AQY221N2S</b>	<b>AQS221R2S</b>	<b>AQS221N2S</b>	<b>AQS221FR2S</b>	<b>AQS221FN2S</b>	
Output	Load voltage	AC/DC		AC/DC		AC/DC		
		Peak AC	40V	40V	40V	40V	40V	40V
		DC	40V	40V	40V	40V	40V	40V
	Continuous load current	1A						
		0.5A	0.25A	0.12A	0.16A	0.06A	0.16A	0.06A
	Peak load current	0.75A	0.3A	0.2A	0.12A	0.2A	0.12A	
	Power dissipation	300mW		600mW		600mW		
	On resistance	Typ.	0.8 Ω	9.5Ω	0.8 Ω	9.5Ω	0.75Ω	9.5Ω
		Max.	1.25Ω	12.5Ω	1.25Ω	12.5Ω	1.25Ω	12.5Ω
	Output capacitance (Typ.)	13pF	1pF	13pF	1pF	12.5pF	1pF	
Off state leakage current (Max.)	10nA		10nA		10nA			
Input	LED forward current	50mA		50mA		Input voltage: 6V		
	LED reverse voltage	5V		5V		Input reverse voltage: 5V		
	Peak forward current	1A		1A		—		
	Power dissipation	75mW		75mW		260mW (65mW per channel)		
	LED operate current	Typ.	0.5mA	0.9 mA	0.5mA	0.9 mA	Operate voltage: 1.3V	
		Max.	3 mA	3 mA	3 mA	3 mA	Operate voltage: 4V	
	LED turn off current	Min.	0.1mA	0.2 mA	0.1mA	0.1 mA	Turn off voltage: 0.8V	
		Typ.	0.4mA	0.85mA	0.4mA	0.85mA	Turn off voltage: 1.3V	
LED dropout voltage	Typ.	1.25V (1.14V at IF = 5mA)		1.25V (1.14V at IF = 5mA)		Input current (Typ.) : 8.5mA (VIN = 5V)		
	Max.	1.5V		1.5V				
Turn on time	Typ.	0.1 ms	0.03ms	0.15ms	0.03vms	0.07ms	0.02ms	
	Max.	0.5 ms	0.5 ms	0.5 ms	0.2 ms	0.5 ms	0.5 ms	
Turn off time	Typ.	0.06ms	0.03ms	0.06ms	0.03ms	0.07ms	0.02ms	
	Max.	0.2 ms	0.2 ms	0.2 ms	0.2 ms	0.2 ms	0.2 ms	
Total power dissipation	350mW		650mW		650mW			
I/O isolation voltage	500Vrms	1,500Vrms	500Vrms	500Vrms	500Vrms			
I/O capacitance	Typ.	0.8pF		0.8pF		0.8pF		
	Max.	1.5pF		1.5pF		1.5pF		
Initial I/O isolation resistance (Min.)	1,000MΩ		1,000MΩ		1,000MΩ			
Safety standards	—		—		—			
Mass (weight) (approx.)	0.084g		0.195g		0.195g			

**RF** Low on-resistance & low output capacitance

GU GE CC **RF** HE HF HS PD Power

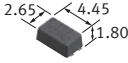
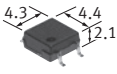
Product name		RF VSSOP C × R		RF SSOP C × R			RF SOP C × R			
Contact configuration		1 Form A		1 Form A			1 Form A			
Number of terminals		4pin		4pin			4pin			
Appearance configuration *Standoff height included  mm										
Features		C×R type VSSOP package 60V and 100 V load voltage		C×R type SSOP package 60 V, 80 V and 100 V load voltage			Miniature SOP4-pin type Low C R 60V/80V load voltage			
Part No.		<b>AQY222R2T</b>	<b>AQY225R3T</b>	<b>AQY222R2V</b>	<b>AQY225R2V</b>	<b>AQY225R3V</b>	<b>AQY222R1S</b>	<b>AQY225R1S</b>	<b>AQY225R2S</b>	
Output	Load voltage	AC/DC		AC/DC			AC/DC			
		Peak AC	60V	100V	60V	80V	100V	60V	80V	80V
		DC	60V	100V	60V	80V	100V	60V	80V	80V
	Continuous load current	1A								
		0.5A	0.4A	0.12A	0.4A	0.12A	0.12A	0.5A	0.35A	0.15A
	Peak load current	1.2A	0.3A	1.2A	0.3A	0.3A	1A	0.7A	0.45A	
	Power dissipation	250mW		250mW			300mW			
	On resistance	Typ.	0.8 Ω	8.8Ω	0.8 Ω	10.5Ω	8.8Ω	0.8Ω	0.8Ω	10.5Ω
		Max.	1.25Ω	14 Ω	1.25Ω	15 Ω	14 Ω	1.2Ω	1.2Ω	15 Ω
	Output capacitance (Typ.)	27pF		27pF			24.5pF			
Off state leakage current (Max.)	10nA		10nA			10nA				
Input	LED forward current	50mA		50mA			50mA			
	LED reverse voltage	5V		5V			5V			
	Peak forward current	1A		1A			1A			
	Power dissipation	75mW		75mW			75mW			
	LED operate current	Typ.	0.4 mA		0.5 mA			0.5 mA		
		Max.	3 mA		3 mA			3 mA		
	LED turn off current	Min.	0.1 mA		0.1 mA			0.1 mA		
		Typ.	0.35mA		0.45mA			0.45mA		
LED dropout voltage	Typ.	1.14V (1.35V at I <sub>F</sub> = 50mA)		1.32V (1.14V at I <sub>F</sub> = 5mA)			1.32V (1.14V at I <sub>F</sub> = 5mA)			
	Max.	1.5V		1.5V			1.5V			
Turn on time	Typ.	0.12ms	0.04ms	0.15ms	0.05ms		0.15ms	0.25ms	0.05ms	
	Max.	0.5 ms	0.5 ms	0.5 ms	0.5 ms		0.5 ms	0.75ms	0.5 ms	
Turn off time	Typ.	0.08ms	0.05ms	0.08ms	0.05ms		0.06ms	0.08ms	0.05ms	
	Max.	0.2 ms	0.2 ms	0.2 ms	0.2 ms		0.2 ms	0.2 ms	0.2 ms	
Total power dissipation	300mW		300mW			350mW				
I/O isolation voltage	200Vrms		1,500Vrms			1,500Vrms				
I/O capacitance	Typ.	0.8pF		0.8pF			0.8pF			
	Max.	1.5pF		1.5pF			1.5pF			
Initial I/O isolation resistance (Min.)	—		1,000MΩ			1,000MΩ				
Safety standards	—		—			—	UL/C-UL	—		
Mass (weight) (approx.)	0.026g		0.064g			0.084g				

# PhotoMOS® Selector Chart

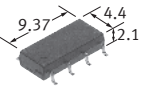
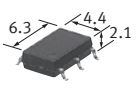
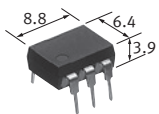
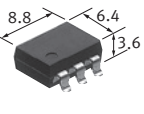
Product name		RF SOP C × R	RF SOP Low on-resistance		RF Low on-resistance		
Contact configuration		2 Form A	1 Form A		1 Form A		
Number of terminals		8pin	6pin		6pin		
Appearance configuration <small>*Standoff height included</small>							
Features		Miniature SOP8-pin type Low C×R High load voltage of 250V	Miniature SOP6-pin type Low on-resistance 200V/400V load voltage		DIP6-pin type featuring low on-resistance 200V/400V load voltage		
Part No.		<b>AQW223R2S</b>	<b>AQV227NS</b>	<b>AQV224NS</b>	<b>AQV227N</b>	<b>AQV224N</b>	
Output	Load voltage	AC/DC	AC/DC		AC/DC		
		Peak AC	250V	200V	400V	200V	400V
		DC	250V	200V	400V	200V	400V
	Continuous load current <small>*6-pin type: in case of A connection</small>	1A					
		0.5A	0.14A	0.05A	0.04A	0.07A	0.05A
	Peak load current	0.42A	0.15A	0.12A	0.21A	0.15A	
	Power dissipation	600mW	450mW		360mW		
	On resistance <small>*6-pin type: in case of A connection</small>	Typ.	11Ω	30Ω	70Ω	30Ω	70Ω
		Max.	15Ω	50Ω	100Ω	50Ω	100Ω
	Output capacitance (Typ.)	33pF	10pF		10pF		
Off state leakage current (Max.)	10nA	10nA		10nA			
Input	LED forward current	50mA	50mA		50mA		
	LED reverse voltage	5V	5V		5V		
	Peak forward current	1A	1A		1A		
	Power dissipation	75mW	75mW		75mW		
	LED operate current	Typ.	0.5 mA	0.7 mA	0.9 mA	0.9 mA	
		Max.	3 mA	3 mA	3 mA	3 mA	
	LED turn off current	Min.	0.1 mA	0.4 mA	0.4 mA	0.4 mA	
		Typ.	0.45mA	0.65mA	0.85mA	0.85mA	
LED dropout voltage	Typ.	1.32V (1.14V at I <sub>F</sub> = 5mA)	1.25V (1.14V at I <sub>F</sub> = 5mA)		1.25V (1.14V at I <sub>F</sub> = 5mA)		
	Max.	1.5V	1.5V		1.5V		
Turn on time	Typ.	0.15ms	0.12ms	0.1ms	0.2 ms		
	Max.	0.5 ms	0.5 ms	0.5ms	0.5 ms		
Turn off time	Typ.	0.05ms	0.05ms		0.08ms		
	Max.	0.2 ms	0.2 ms		0.2 ms		
Total power dissipation	650mW	500mW		410mW			
I/O isolation voltage	1,500Vrms	1,500Vrms		1,500Vrms			
I/O capacitance	Typ.	0.8pF	0.8pF		0.8pF		
	Max.	1.5pF	1.5pF		1.5pF		
Initial I/O isolation resistance (Min.)	1,000MΩ	1,000MΩ		1,000MΩ			
Safety standards	—	UL/C-UL		UL/C-UL			
Mass (weight) (approx.)	0.195g	0.125g		0.453g			

**RF** Low on-resistance & low output capacitance

GU GE CC **RF** HE HF HS PD Power

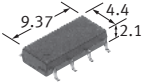
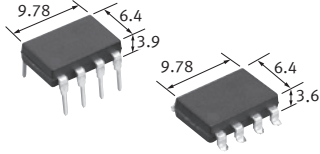
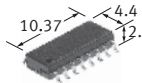
Product name		RF SOP Low on-resistance	RF Low on-resistance		RF SOP C × R
Contact configuration		2 Form A	2 Form A		4 Form A
Number of terminals		8pin	8pin		16pin
Appearance configuration *Standoff height included  mm					
Features		Miniature SOP8-pin type Low on-resistance 200V load voltage	DIP8-pin type featuring low on-resistance 200V/400V load voltage		Space-saving SOP16-pin type Low on-resistance 80V load voltage
Part No.		<b>AQW227NS</b>	<b>AQW227N</b>	<b>AQW224N</b>	<b>AQS225R2S</b>
電源		AC/DC	AC/DC		AC/DC
Load voltage	Peak AC	200V	200V	400V	80V
	DC	200V	200V	400V	80V
Continuous load current	1A				
	0.5A				
Peak load current		0.04A	0.05A	0.04A	0.07A
Power dissipation		600mW	800mW		600mW
On resistance	Typ.	30Ω	30Ω	70 Ω	10.5Ω
	Max.	50Ω	50Ω	100Ω	15 Ω
Output capacitance (Typ.)		10pF	10pF		4.5pF
Off state leakage current (Max.)		10nA	10nA		10nA
Input	LED forward current		50mA	50mA	50mA
	LED reverse voltage		5V	5V	5V
	Peak forward current		1A	1A	1A
	Power dissipation		75mW	75mW	75mW
	LED operate current	Typ.	0.7 mA	0.9mA	0.9 mA
		Max.	3 mA	3 mA	3 mA
	LED turn off current	Min.	0.4 mA	0.4mA	0.3 mA
		Typ.	0.65mA	0.8mA	0.85mA
LED dropout voltage	Typ.	1.25V (1.14V at I <sub>F</sub> = 5mA)	1.25V (1.14V at I <sub>F</sub> = 5mA)		1.25V (1.14V at I <sub>F</sub> = 5mA)
	Max.	1.5V	1.5V		1.5V
Turn on time	Typ.	0.25ms	0.2 ms	0.04ms	
	Max.	0.5 ms	0.5 ms	0.3 ms	
Turn off time	Typ.	0.08ms	0.08ms	0.07ms	
	Max.	0.2 ms	0.2 ms	0.2 ms	
Total power dissipation		650mW	850mW		650mW
I/O isolation voltage		1,500Vrms	1,500Vrms		1,500Vrms
I/O capacitance	Typ.	0.8pF	0.8pF		0.8pF
	Max.	1.5pF	1.5pF		1.5pF
Initial I/O isolation resistance (Min.)		1,000MΩ	1,000MΩ		1,000MΩ
Safety standards		UL/C-UL	UL/C-UL		—
Mass (weight) (approx.)		0.195g	0.5g		0.195g

# PhotoMOS® Selector Chart

**HE**

Low on-resistance & Economical

GU GE CC RF **HE** HF HS PD Power

Product name		HE												
Contact configuration		1 Form A												
Number of terminals		6pin												
Appearance configuration <small>*Standoff height included</small>														
Features		DIP6-pin type with low on-resistance and reinforced insulation												
Part No.		AQV251	AQV252	AQV255	AQV257	AQV253	AQV254	AQV259	AQV258	AQV253H	AQV254H	AQV256H		
Output	Load voltage	AC/DC												
		Peak AC	40V	60V	100V	200V	250V	400V	1,000V	1,500V	250V	400V	600V	
	DC	40V	60V	100V	200V	250V	400V	1,000V	1,500V	250V	400V	600V		
	Continuous load current <small>*6-pin type: in case of A connection</small>	1A												
		0.5A	0.5A	0.4A	0.35A	0.25A	0.2A	0.15A	0.03A	0.02A	0.2A	0.15A	0.13A	
	Peak load current	1.8A	1.5A	1.0A	0.75A	0.6A	0.5A	0.09A	0.06A	0.6A	0.5A	0.4A		
	Power dissipation	360mW												
	On resistance	Typ.	0.6Ω	0.74Ω	1.8Ω	2.6Ω	5.5Ω	12.4Ω	85Ω	345Ω	5.5Ω	12.4Ω	20Ω	
		Max. <small>*6-pin type: in case of A connection</small>	1 Ω	1.4Ω	2.5Ω	4 Ω	8 Ω	16 Ω	200Ω	500Ω	8 Ω	16 Ω	30Ω	
	Output capacitance (Typ.)	350pF			170pF			80pF		170pF		70pF		
Off state leakage current (Max.)	1μA						10μA		1μA					
Input	LED forward current	50mA												
	LED reverse voltage	5V												
	Peak forward current	1A												
	Power dissipation	75mW												
	LED operate current	Typ.	0.9mA								1.4mA			
		Max.	3 mA								3 mA			
	LED turn off current	Min.	0.4mA								0.4mA			
		Typ.	0.8mA								1.3mA			
LED dropout voltage	Typ.	1.25V (1.14V at I <sub>F</sub> = 5mA)												
	Max.	1.5V												
Turn on time	Typ.	1.7ms	1.4ms	0.9 ms	1.5ms	0.8ms		0.6 ms	0.35ms	2.4 ms	1.8 ms	1.2 ms		
	Max.	3 ms	3 ms	2 ms	3 ms	2 ms		1 ms	1 ms	4 ms	3 ms	3 ms		
Turn off time	Typ.	0.07ms		0.09ms	0.1ms	0.06ms	0.05ms	0.04ms	0.04ms	0.06ms	0.05ms	0.06ms		
	Max.	0.2 ms		0.2 ms	0.2ms	0.2 ms	0.2 ms	0.2 ms	0.2 ms	0.2 ms	0.2 ms	0.2 ms		
Total power dissipation	410mW													
I/O isolation voltage	1,500Vrms								5,000Vrms					
I/O capacitance	Typ.	1.3pF												
	Max.	3 pF												
Initial I/O isolation resistance (Min.)	1,000MΩ													
Safety standards	UL/C-UL							UL/C-UL, VDE	UL/C-UL, BSI		UL/C-UL, VDE			
Mass (weight) (approx.)	0.453g													

**HE** Low on-resistance & Economical

GU GE CC RF **HE** HF HS PD Power

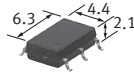
Product name		HE SOP High Capacity				
Contact configuration		1 Form A (6 pins)				
Number of terminals		6pin				
Appearance configuration <small>*Standoff height included</small>						
Features		Miniature SOP6-pin type with high capacity of 3A load current				
Part No.		AQV252G2S	AQV252G3S	AQV255GS	AQV255G3S	
Output	Load voltage	Peak AC	AC/DC			
		DC	50V	60V	80V	100V
	Continuous load current <small>*6-pin type: in case of A connection</small>	3A	3A	3.3A	1.25A	2.2A
		2A				
	1A					
	Peak load current	6A	10A	3A	6.6A	
	Power dissipation	450mW				
	On resistance <small>*6-pin type: in case of A connection</small>	Typ.	0.04Ω	0.033Ω	0.09Ω	0.07Ω
		Max.	0.07Ω	0.06 Ω	0.15Ω	0.12Ω
	Output capacitance (Typ.)	360pF		510pF	300pF	430pF
Off state leakage current (Max.)	1μA					
Input	LED forward current	50mA				
	LED reverse voltage	5V				
	Peak forward current	1A				
	Power dissipation	75mW				
	LED operate current	Typ.	0.6mA	0.5mA	0.5mA	0.5mA
		Max.	3 mA	3 mA	3 mA	3 mA
	LED turn off current	Min.	0.2mA	0.2mA	0.2mA	0.2mA
		Typ.	0.5mA	0.4mA	0.4mA	0.4mA
LED dropout voltage	Typ.	1.32V (1.14V at I <sub>F</sub> = 5mA)				
	Max.	1.5V				
Turn on time	Typ.	1.5 ms	1.8 ms	1.3ms	1.8 ms	
	Max.	5.0 ms	5 ms	5.0ms	5 ms	
Turn off time	Typ.	0.08ms	0.15ms	0.1ms	0.15ms	
	Max.	0.5 ms	0.5 ms	0.5ms	0.5 ms	
Total power dissipation	500mW					
I/O isolation voltage	1,500Vrms					
I/O capacitance	Typ.	0.8pF				
	Max.	1.5pF				
Initial I/O isolation resistance (Min.)	1,000MΩ					
Safety standards	UL/C-UL, VDE	UL/C-UL	UL/C-UL, VDE	UL/C-UL		
Mass (weight) (approx.)	0.125g					

# PhotoMOS® Selector Chart

**HE**

Low on-resistance & Economical

GU GE CC RF **HE** HF HS PD Power

Product name		HE High Capacity				
Contact configuration		1 Form A				
Number of terminals		6pin				
Appearance configuration <small>*Standoff height included</small>						
Features		Capable of 2A to 3A high-frequency load				
Part No.		AQV251G	AQV252G	AQV252G3	AQV255G3	
Output	Load voltage	Peak AC	AC/DC			
		DC	30V	60V	60V	100V
	Continuous load current <small>*6-pin type: in case of A connection</small>	3A	3.5A	2.5A	3.5A	2.4A
		2A				
		1A				
	Peak load current	6.0A	6.0A	10A	7.0A	
	Power dissipation	600mW				
	On resistance <small>*6-pin type: in case of A connection</small>	Typ.	0.035Ω	0.08Ω	0.033Ω	0.07Ω
		Max.	0.08 Ω	0.12Ω	0.06 Ω	0.12Ω
	Output capacitance (Typ.)	330pF		240pF	510pF	430pF
Off state leakage current (Max.)	1μA					
Input	LED forward current	50mA				
	LED reverse voltage	5V				
	Peak forward current	1A				
	Power dissipation	75mW				
	LED operate current	Typ.	0.55mA	0.5mA	0.5mA	0.5mA
		Max.	3 mA	3 mA	3 mA	3 mA
	LED turn off current	Min.	0.2mA			
		Typ.	0.45mA		0.4mA	
LED dropout voltage	Typ.	1.32V (1.14V at I <sub>F</sub> = 5mA)				
	Max.	1.5V				
Turn on time	Typ.	1.1ms		1.8ms		
	Max.	5ms				
Turn off time	Typ.	0.1ms	0.25ms	0.15ms	0.15ms	
	Max.	0.5ms	0.5 ms	0.5 ms	0.5 ms	
Total power dissipation	650mW					
I/O isolation voltage	1,500Vrms					
I/O capacitance	Typ.	0.8pF				
	Max.	1.5pF				
Initial I/O isolation resistance (Min.)	1,000MΩ					
Safety standards	UL/C-UL, VDE		UL/C-UL	UL/C-UL, VDE		
Mass (weight) (approx.)	0.453g					



**HE** Low on-resistance & Economical

GU GE CC RF **HE** HF HS PD Power

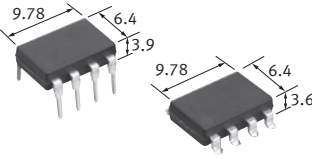
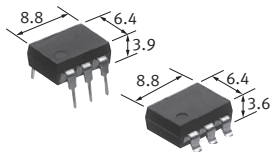
Product name		HE				
Contact configuration		2 Form A		1 Form B		
Number of terminals		8pin		6pin		
Appearance configuration <small>*Standoff height included</small>						
Features		DIP8-pin type featuring low on-resistance with 400V load voltage		Normally closed DIP6-pin type Low on-resistance with 250V/400V load voltage		
Part No.		<b>AQW254</b>	<b>AQV453</b>	<b>AQV454</b>	<b>AQV454H</b>	
Output	Load voltage	AC/DC	AC/DC			
		Peak AC	400V	250V	400V	400V
			DC	400V	250V	400V
	Continuous load current <small>*6-pin type: in case of A connection</small>	1A				
		0.5A				
	Peak load current	0.36A	0.6A	0.5A		
	Power dissipation	800mW	360mW			
	On resistance <small>*6-pin type: in case of A connection</small>	Typ.	10.2Ω	5.5Ω	11Ω	
		Max.	16 Ω	8 Ω	16Ω	
	Output capacitance (Typ.)	170pF	350pF	170pF		
Off state leakage current (Max.)	1μA	1μA		10μA		
Input	LED forward current	50mA	50mA			
	LED reverse voltage	5V	5V			
	Peak forward current	1A	1A			
	Power dissipation	75mW	75mW			
	LED operate current	Typ.	0.9mA	1 mA	0.9mA	1.4mA
		Max.	3 mA	3 mA	3 mA	3 mA
	LED turn off current	Min.	0.4mA	0.4mA	0.4mA	0.4mA
		Typ.	0.8mA	0.9mA	0.8mA	1.3mA
LED dropout voltage	Typ.	1.25V (1.14V at I <sub>F</sub> = 5mA)	1.25V (1.14V at I <sub>F</sub> = 5mA)			
	Max.	1.5V	1.5V			
Turn on time	Typ.	0.8 ms	1.52ms	1.2 ms	1.8 ms	
	Max.	2 ms	3 ms	2 ms	3 ms	
Turn off time	Typ.	0.04ms	0.4 ms	0.36ms	0.4 ms	
	Max.	0.2 ms	1 ms	1 ms	1 ms	
Total power dissipation	850mW	410mW				
I/O isolation voltage	1,500Vrms	1,500Vrms		5,000Vrms		
I/O capacitance	Typ.	0.8pF	1.3pF			
	Max.	1.5pF	3 pF			
Initial I/O isolation resistance (Min.)	1,000MΩ	1,000MΩ				
Safety standards	UL/C-UL	UL/C-UL		UL/C-UL, BSI		
Mass (weight) (approx.)	0.5g	0.453g				

# PhotoMOS® Selector Chart

**HE** Low on-resistance & Economical

GU GE CC RF **HE** HF HS PD Power

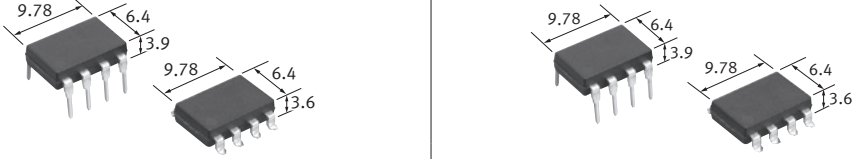
Product name		HE		
Contact configuration		2 Form B	1 Form A & 1 Form B	
Number of terminals		8pin	8pin	
Appearance configuration <small>*Standoff height included</small>				
Features		Normally closed (2 Form B) DIP6-pin type Low on-resistance with 400V load voltage	Both 1 Form A and 1 Form B contacts incorporated in a compact DIP8-pin with low on-resistance	
Part No.		<b>AQW454</b>	<b>AQW654</b>	
Output	Load voltage	AC/DC	AC/DC	
		Peak AC	400V	400V
		DC	400V	400V
	Continuous load current	1A		
		0.5A		
	Peak load current	0.12A	0.12A	
	Power dissipation	0.36A	0.36A	
	On resistance	Typ.	800mW	800mW
		Max.	11Ω	11Ω
	Output capacitance (Typ.)	16Ω	170pF	170pF
Off state leakage current (Max.)	170pF	1μA	1μA	
Input	LED forward current	50mA	50mA	
	LED reverse voltage	5V	5V	
	Peak forward current	1A	1A	
	Power dissipation	75mW	75mW	
	LED operate current	Typ.	0.9mA	0.9mA
		Max.	3 mA	3 mA
	LED turn off current	Min.	0.4mA	0.4mA
		Typ.	0.8mA	0.8mA
LED dropout voltage	Typ.	1.25V (1.14V at I <sub>F</sub> = 5mA)	1.25V (1.14V at I <sub>F</sub> = 5mA)	
	Max.	1.5V	1.5V	
Turn on time	Typ.	1.2 ms	0.8ms (N.O.) , 1.2ms (N.C.)	
	Max.	2 ms	2ms	
Turn off time	Typ.	0.36ms	0.04ms (N.O.) , 0.36ms (N.C.)	
	Max.	1 ms	1ms	
Total power dissipation	850mW	850mW		
I/O isolation voltage	1,500Vrms	1,500Vrms		
I/O capacitance	Typ.	0.8pF	0.8pF	
	Max.	1.5pF	1.5pF	
Initial I/O isolation resistance (Min.)	1,000MΩ	1,000MΩ		
Safety standards	UL/C-UL	UL/C-UL		
Mass (weight) (approx.)	0.5g	0.5g		

**HF** Low on-resistance

GU GE CC RF HE **HF** HS PD Power

Product name		HF								
Contact configuration		1 Form A								
Number of terminals		6pin								
Appearance configuration <small>*Standoff height included</small>										
Features		DIP6-pin type with wide variation Low on-resistance								
Part No.		AQV101	AQV102	AQV103	AQV104	AQV201	AQV202	AQV203	AQV204	
Output	Load voltage	DC				AC/DC				
		Peak AC	—				40V	60V	250V	400V
		DC	40V	60V	250V	400V	40V	60V	250V	400V
	Continuous load current <small>*6-pin type: in case of A connection</small>	1A								
		0.5A								
	Peak load current	1.8A	1.5A	0.6A	0.5A	1.8A	1.5A	0.6A	0.5A	
	Power dissipation	360mW				360mW				
	On resistance <small>*6-pin type: in case of A connection</small>	Typ.	0.3Ω	0.37Ω	2.7Ω	6.3Ω	0.6Ω	0.74Ω	5.5Ω	12.4Ω
		Max.	0.5Ω	0.7 Ω	4 Ω	8 Ω	1 Ω	1.4 Ω	8 Ω	16 Ω
	Output capacitance (Typ.)		600pF		300pF		350pF		170pF	
Off state leakage current (Max.)		1μA								
Input	LED forward current	50mA								
	LED reverse voltage	10V								
	Peak forward current	1A								
	Power dissipation	150mW								
	LED operate current	Typ.	2.3mA				2.4mA			
		Max.	5 mA				5 mA			
	LED turn off current	Min.	0.8mA							
		Typ.	2.2mA							
LED dropout voltage	Typ.	2.3V								
	Max.	3 V								
Turn on time	Typ.	0.23ms	0.22ms	0.13ms	0.09ms	0.38ms	0.41ms	0.21ms	0.18ms	
	Max.	1 ms	1 ms	1 ms	1 ms	1 ms	1 ms	1 ms	1 ms	
Turn off time	Typ.	0.07ms			0.08ms			0.07ms		
	Max.	1 ms			1 ms			1 ms		
Total power dissipation		410mW								
I/O isolation voltage		1,500Vrms								
I/O capacitance	Typ.	1.3pF								
	Max.	3 pF								
Initial I/O isolation resistance (Min.)		1,000MΩ								
Safety standards		UL/C-UL								
Mass (weight) (approx.)		0.453g								

# PhotoMOS® Selector Chart

**HS** High sensitivity

GU GE CC RF HE HF **HS** PD Power

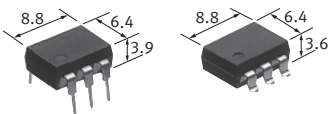
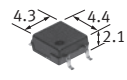
Product name		HS		HS SOP				
Contact configuration		1 Form A		1 Form A				
Number of terminals		6pin		4pin				
Appearance configuration <small>*Standoff height included</small>								
Features		DIP6-pin type featuring high sensitivity		Recommended LED forward current 2 mA, High Sensitivity (Low current-consumption) Miniature SOP4-pin Type				
Part No.		<b>AQV234</b>		<b>AQY232S</b>	<b>AQY230S</b>	<b>AQY234S</b>		
Output	Load voltage	AC/DC		AC/DC				
		Peak AC	400V	60V	350V	400V		
	DC	400V	60V	350V	400V			
	Continuous load current <small>*6-pin type: in case of A connection</small>	1A						
		0.5A			0.5A			
	Peak load current	0.3A		1.5A	0.3A	0.24A		
	Power dissipation	500mW		300mW				
	On resistance <small>*6-pin type: in case of A connection</small>	Typ.	30Ω		0.85Ω	19Ω	27Ω	
		Max.	50Ω		2.5 Ω	25Ω	35Ω	
	Output capacitance (Typ.)	45pF		80pF	32pF	35pF		
Off state leakage current (Max.)	1μA		1μA					
Input	LED forward current	50mA		50mA				
	LED reverse voltage	5V		5V				
	Peak forward current	1A		1A				
	Power dissipation	75mW		75mW				
	LED operate current	Typ.	0.31mA		0.35mA			
		Max.	0.5 mA		0.5 mA			
	LED turn off current	Min.	0.1 mA		0.1 mA			
		Typ.	0.29mA		0.3 mA			
LED dropout voltage	Typ.	1.25V (1.1V at I <sub>F</sub> = 2mA)		1.25V (1.1V at I <sub>F</sub> = 2mA)				
	Max.	1.5V		1.5V				
Turn on time	Typ.	0.89ms		1.5 ms	1.2 ms	0.8 ms		
	Max.	2 ms		5 ms	5 ms	5 ms		
Turn off time	Typ.	0.22ms		0.15ms	0.1 ms	0.1 ms		
	Max.	1 ms		2 ms	2 ms	2 ms		
Total power dissipation	550mW		350mW					
I/O isolation voltage	1,500Vrms		1,500Vrms					
I/O capacitance	Typ.	0.8pF		0.8pF				
	Max.	1.5pF		1.5pF				
Initial I/O isolation resistance (Min.)	1,000MΩ		1,000MΩ					
Safety standards	UL/C-UL		UL/C-UL, VDE					
Mass (weight) (approx.)	0.453g		0.084g					

**PD** Flat & power

GU GE CC RF HE HF HS **PD** Power

Product name		PD				
Contact configuration		1 Form A				
Number of terminals		4pin				
Appearance configuration <small>*Standoff height included</small>						
Features		Flat Power-DIP4-pin type with high capacity up to 2A load current				
Part No.		AQY272	AQY275	AQY277	AQY274	
Output	Load voltage	AC/DC				
		Peak AC	60V	100V	200V	400V
		DC	60V	100V	200V	400V
	Continuous load current	2A	2A	1.3A	0.65A	0.35A
		1A				
		0.5A				
	Peak load current	6A	4A	2A	1A	
	Power dissipation	700mW				
	On resistance	Typ.	0.11Ω	0.23Ω	0.7Ω	2.1Ω
		Max.	0.18Ω	0.34Ω	1.1Ω	3.2Ω
Output capacitance (Typ.)	1,400pF		600pF			
Off state leakage current (Max.)	10μA					
Input	LED forward current	50mA				
	LED reverse voltage	5V				
	Peak forward current	1A				
	Power dissipation	75mW				
	LED operate current	Typ.	1 mA			
		Max.	3 mA			
	LED turn off current	Min.	0.4mA			
		Typ.	0.9mA			
LED dropout voltage	Typ.	1.25V (1.16V at I <sub>F</sub> = 10mA)				
	Max.	1.5V				
Turn on time	Typ.	2.46ms	2.4 ms	1.12ms	1.65ms	
	Max.	5 ms	5 ms	5 ms	5 ms	
Turn off time	Typ.	0.22ms	0.21ms	0.1 ms	0.08ms	
	Max.	3 ms	3 ms	3 ms	3 ms	
Total power dissipation	750mW					
I/O isolation voltage	2,500Vrms					
I/O capacitance	Typ.	0.8pF				
	Max.	1.5pF				
Initial I/O isolation resistance (Min.)	1,000MΩ					
Safety standards	UL/C-UL, VDE					
Mass (weight) (approx.)	0.62g					

# PhotoMOS® Selector Chart

**Power** Slim & power

GU GE CC RF HE HF HS PD **Power**

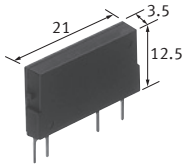
Product name		Power								
Contact configuration		1 Form A								
Number of terminals		4pin								
Appearance configuration <small>*Standoff height included</small>										
Features		Slim type with high capacity up to 4A DC load type also available								
Part No.		AQZ102	AQZ105	AQZ107	AQZ104	AQZ202	AQZ205	AQZ207	AQZ204	
Output	Load voltage	DC				AC/DC				
		Peak AC	—				60V	100V	200V	400V
		DC	60V	100V	200V	400V	60V	100V	200V	400V
	Continuous load current	3A	4A	2.6A	1.3A	0.7A	3A	2A	1A	0.5A
		1A								
	Peak load current	9.0A	6.0A	3.0A	1.5A	9.0A	6.0A	3.0A	1.5A	
	Power dissipation	1.35W				1.6W				
	On resistance	Typ.	0.05Ω	0.081Ω	0.34Ω	1.06Ω	0.11Ω	0.23Ω	0.7Ω	2.1Ω
		Max.	0.09Ω	0.17 Ω	0.55Ω	1.6 Ω	0.18Ω	0.34Ω	1.1Ω	3.2Ω
	Output capacitance (Typ.)		1,700pF		900pF		1,400pF		600pF	
Off state leakage current (Max.)		10μA								
Input	LED forward current	50mA								
	LED reverse voltage	5V								
	Peak forward current	1A								
	Power dissipation	75mW								
	LED operate current	Typ.	1mA							
		Max.	3mA							
	LED turn off current	Min.	0.4mA							
		Typ.	0.9mA							
LED dropout voltage	Typ.	1.25V (1.16V at I <sub>F</sub> = 10mA)								
	Max.	1.5V								
Turn on time	Typ.	1.66ms	1.89ms	0.83ms	1.01ms	2.46ms	2.4ms	1.12ms	1.65ms	
	Max.	5 ms	5 ms	5 ms	5 ms	5 ms	5 ms	5 ms	5 ms	
Turn off time	Typ.	0.15ms	0.19ms	0.08ms	0.08ms	0.22ms	0.21ms	0.10ms	0.08ms	
	Max.	3 ms	3 ms	3 ms	3 ms	3 ms	3 ms	3 ms	3 ms	
Total power dissipation		1.35W				1.6W				
I/O isolation voltage		2,500Vrms								
I/O capacitance	Typ.	0.8pF								
	Max.	1.5pF								
Initial I/O isolation resistance (Min.)		1,000MΩ								
Safety standards		UL/C-UL, VDE								
Mass (weight) (approx.)		1.65g								

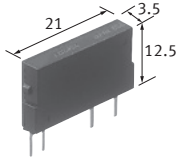
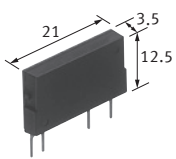
Product name		Power	Power Voltage-sensitive				
Contact configuration		1 Form B	1 Form A				
Number of terminals		4pin	4pin				
Appearance configuration *Standoff height included  mm							
Features		Normally closed type in a slim SIL package Load voltage 400V	Slim and high capacity up to 3.6A Voltage-driven type				
Part No.		<b>AQZ404</b>	<b>AQZ102D</b>	<b>AQZ105D</b>	<b>AQZ107D</b>	<b>AQZ104D</b>	
Output	Load voltage	AC/DC	DC				
		Peak AC	400V	—			
		DC	400V	60V	100V	200V	400V
	Continuous load current	3A	0.5A	3.6A	2.3A	1.1A	0.6A
		1A					
	Peak load current	1.5A	9A	6A	3A	1.5A	
	Power dissipation	1.6W	1.35W				
	On resistance	Typ.	2.8Ω	0.033Ω	0.09Ω	0.33Ω	1.23Ω
		Max.	4.0Ω	0.09 Ω	0.17Ω	0.55Ω	1.6 Ω
	Output capacitance (Typ.)	2,000pF	1,700pF		900pF		
Off state leakage current (Max.)	10μA	10μA					
Input	LED forward current	50mA	Input voltage: 30V				
	LED reverse voltage	5V	Input reverse voltage: 5V				
	Peak forward current	1A	—				
	Power dissipation	75mW	300mW				
	LED operate current	Typ.	1mA	Operate voltage: 1.4V			
		Max.	3mA	Operate voltage: 4 V			
	LED turn off current	Min.	0.4mA	Turn off voltage: 0.8V			
		Typ.	0.9mA	Turn off voltage: 1.3V			
LED dropout voltage	Typ.	1.25V (1.16V at I <sub>F</sub> = 10mA)	Input current (Typ.): 6.5mA				
	Max.	1.5V					
Turn on time	Typ.	3.9ms	3.3ms	2.2ms	1.5ms	1.2ms	
	Max.	7.5ms	10 ms	10 ms	10 ms	10 ms	
Turn off time	Typ.	0.8ms	0.2ms		0.1ms		
	Max.	3 ms	3 ms		3 ms		
Total power dissipation	1.6W	1.35W					
I/O isolation voltage	2,500Vrms	2,500Vrms					
I/O capacitance	Typ.	0.8pF	0.8pF				
	Max.	1.5pF	1.5pF				
Initial I/O isolation resistance (Min.)	1,000MΩ	1,000MΩ					
Safety standards	UL/C-UL, VDE	UL/C-UL, VDE					
Mass (weight) (approx.)	1.65g	1.65g					

# PhotoMOS® Selector Chart

**Power** Slim & power

GU GE CC RF HE HF HS PD **Power**

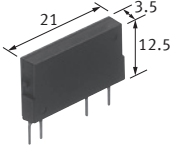
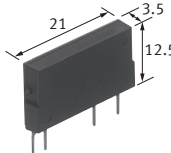
Product name		Power Voltage-sensitive				Power High Capacity				
Contact configuration		1 Form A				1 Form A				
Number of terminals		4pin				4pin				
Appearance configuration *Standoff height included  mm										
Features		Slim and high capacity up to 3.6A Voltage-driven type				High capacity up to 6A in a slim SIL package				
Part No.		<b>AQZ202D</b>	<b>AQZ205D</b>	<b>AQZ207D</b>	<b>AQZ204D</b>	<b>NEW</b> <b>AQZ202G</b>	<b>AQZ205G</b>	<b>AQZ207G</b>	<b>NEW</b> <b>AQZ206G2</b>	
Output	Load voltage	AC/DC				AC/DC				
		Peak AC	60V	100V	200V	400V	60V	100V	200V	600V
		DC	60V	100V	200V	400V	60V	100V	200V	600V
	Continuous load current	6A	2.7A	1.8A	0.9A	0.45A	6A	4A	2A	1A
	Peak load current		9A	6A	3A	1.5A	12A	8A	6A	3A
	Power dissipation		1.6W				1.6W			
	On resistance	Typ.	0.066Ω	0.18Ω	0.64Ω	2.4Ω	0.015Ω	0.035Ω	0.18Ω	0.52Ω
		Max.	0.18 Ω	0.34Ω	1.1 Ω	3.2Ω	0.03 Ω	0.06 Ω	0.35Ω	0.8 Ω
	Output capacitance (Typ.)		1,400pF		600pF		1,600pF	1,240pF	700pF	3,000pF
	Off state leakage current (Max.)		10μA				10μA			
Input	LED forward current	Input voltage: 30V				50mA				
	LED reverse voltage	Input reverse voltage: 5V				5V				
	Peak forward current	—				1A				
	Power dissipation	300mW				75mW				
	LED operate current	Typ.	Operate voltage: 1.4V				1mA			
		Max.	Operate voltage: 4 V				3mA			
	LED turn off current	Min.	Turn off voltage: 0.8V				0.2mA			
		Typ.	Turn off voltage: 1.3V				0.9mA			
LED dropout voltage	Typ.	Input current (Typ.): 6.5mA				1.25V (1.16V at I <sub>F</sub> = 10mA)				
	Max.					1.5V				
Turn on time	Typ.	5.8ms	4.2ms	2.7ms	2.3ms	3.8ms	5.0ms	2.5ms	3.0ms	
	Max.	10 ms	10 ms	10 ms	10 ms	10 ms	10 ms	10 ms	10 ms	
Turn off time	Typ.	0.2ms		0.1ms		0.2ms	0.3ms	0.2ms	0.2ms	
	Max.	3 ms		3 ms		3 ms	3 ms	3 ms	3 ms	
Total power dissipation		1.6W				1.6W				
I/O isolation voltage		2,500Vrms				2,500Vrms				
I/O capacitance	Typ.	0.8pF				0.8pF				
	Max.	1.5pF				1.5pF				
Initial I/O isolation resistance (Min.)		1,000MΩ				1,000MΩ				
Safety standards		UL/C-UL, VDE				UL/C-UL, VDE				
Mass (weight) (approx.)		1.65g				1.65g				



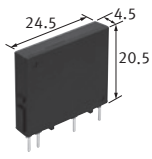

Power Slim & power

GU GE CC RF HE HF HS PD Power

Product name		Power DC High Capacity		
Contact configuration		1 Form A		
Number of terminals		6pin		
Appearance configuration <small>*Standoff height included</small>				
Features		Max. high capacity 10A in a slim SIL package		
Part No.		AQZ192	AQZ197	
Output	Load voltage	Peak AC	DC	
		DC	DC	
	Continuous load current	6A	10A	5A
		1A		
		0.5A		
	Peak load current	30A	15A	
	Power dissipation	2W		
	On resistance	Typ.	0.008Ω	0.031Ω
		Max.	0.015Ω	0.05 Ω
	Output capacitance (Typ.)	2,100pF	2,600pF	
Off state leakage current (Max.)	10μA			
Input	LED forward current	50mA		
	LED reverse voltage	5V		
	Peak forward current	1A		
	Power dissipation	75mW		
	LED operate current	Typ.	0.7mA	
		Max.	3 mA	
	LED turn off current	Min.	0.2mA	
		Typ.	0.5mA	
LED dropout voltage	Typ.	1.35V (1.17V at I <sub>F</sub> = 10mA)		
	Max.	1.5V		
Turn on time	Typ.	1 ms	0.7 ms	
	Max.	3 ms	3 ms	
Turn off time	Typ.	0.11ms	0.05ms	
	Max.	1 ms	1 ms	
Total power dissipation	2W			
I/O isolation voltage	3,000Vrms			
I/O capacitance	Typ.	1.3pF		
	Max.	3pF		
Initial I/O isolation resistance (Min.)	1,000MΩ			
Safety standards	UL/C-UL, VDE			
Mass (weight) (approx.)	4.3g			

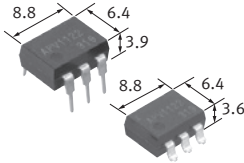
# Photovoltaic MOSFET Drivers Selector Chart

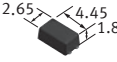
Product name		Photovoltaic MOSFET drivers								
Number of terminals		DIP 6pin		SOP 4pin		SSOP 4pin				
Appearance configuration *Standoff height included										
mm										
Features		Photovoltaic MOSFET drivers of wide variation								
Part No.		APV1122		APV1121S		APV2121S		APV2111V		
Output	Open voltage	Min.	6 V				5 V			
		Typ.	8.7V				8.2V			
	Short current	Min.	5μA				3μA			
		Typ.	14μA				8μA			
Input	LED forward current		50mA							
	LED reverse voltage		5V							
	Peak forward current		1A							
	Power dissipation		75mA							
	LED operate current	Typ.	0.6mA				0.85mA			
		Max.	3 mA							
	LED turn off current	Min.	0.2mA							
		Typ.	0.5mA				0.75mA			
LED dropout voltage	Typ.	1.15V								
	Max.	1.5 V								
Turn on time		Typ.	0.4ms				0.8ms			
Turn off time		Typ.	0.1ms							
I/O capacitance	Typ.	0.8pF								
	Max.	1.5pF								
Initial I/O isolation resistance (Min.)		1,000MΩ								
I/O isolation voltage		5,000Vrms		2,500Vrms		2,500Vrms		1,500Vrms		
Safety standards		UL/C-UL, VDE						UL/C-UL		
Mass (weight) (approx.)		0.45g		0.08g		0.06g				

# Phototriac Coupler Selector Chart

Product name	APT Phototriac Coupler								
Type	Zero-cross	Random	Zero-cross	Random	Zero-cross	Random	Zero-cross	Random	
Number of terminals	SOP 4pin		DIP 4pin		DIP 6pin		DIP 6pin wide		
Type	0.05A		0.1A						
Appearance configuration *Standoff height included  mm									
Features	Phototriac coupler ideal for triac driver with wide variation								
Part No.	APT1211S	APT1221S	APT1211	APT1221	APT1212	APT1222	APT1212W	APT1222W	
Output	Repetitive peak OFF-state voltage	600V							
	ON-state RMS current	0.05A		0.1A					
	Non-repetitive surge current	0.6A		1.2A					
	Peak ON-state voltage	Max. 2.5V							
	Peak OFF-state current	Max. 1μA							
	LED forward current	50mA							
Input	LED reverse voltage	6V							
	Peak forward current	1A							
	LED dropout voltage (IF=20mA)	Max. 1.3V							
	Trigger LED current	Max. 10mA							
Zero-cross voltage	Max. 50V	—	Max. 50V	—	Max. 50V	—	Max. 50V	—	
Turn on time	Max. 0.1ms								
I/O isolation voltage	3,750Vrms		5,000Vrms						
I/O isolation resistance	Min. 50GΩ								
Safety standards	UL/C-UL, VDE*								
Mass (weight) (approx.)	0.08g		0.19g		0.45g		0.45g		

\*Normal part number is taken UL/C-UL standards. About VDE standard, please contact our sales office.

# Phototriac Coupler Selector Chart

Product name	APT Phototriac Coupler			
Type	Zero-cross (Low zero-cross type)			
Number of terminals	SOP 4pin	DIP 4pin	DIP 6pin	DIP 6pin wide
Type	0.05A	0.1A		
<b>Appearance configuration</b> *Standoff height included  mm				
Features	Phototriac coupler ideal for triac driver with wide variation			
Part No.	APT1231S	APT1231	APT1232	APT1232W
Output Input	Repetitive peak OFF-state voltage	600V		
	ON-state RMS current	0.05A	0.1A	
	Non-repetitive surge current	0.6A	1.2A	
	Peak ON-state voltage	Max. 2.0V		
	Peak OFF-state current	Max. 1μA		
	LED forward current	50mA		
LED reverse voltage	6V			
Peak forward current	1A			
LED dropout voltage (IF=20mA)	Max. 1.3V			
Trigger LED current	Max. 10mA			
Zero-cross voltage	Max. 15V			
Turn on time	Max. 0.1ms			
I/O isolation voltage	3,750Vrms	5,000Vrms		
I/O isolation resistance	Min. 50GΩ			
Safety standards	UL/C-UL, VDE*			
Mass (weight) (approx.)	0.08g	0.19g	0.45g	0.45g

\*Normal part number is taken UL/C-UL standards. About VDE standard, please contact our sales office.

# Solid State Relays Selector Chart

Product name	AQ-H Relays								
Type	Phototriac								
Number of terminals	DIP 8pin								
Type	0.3A	0.6A	0.9A					1.2A	
Appearance configuration *Standoff height included  mm									
Features	Compact DIP type SSR Ideal for AC load control								
Part No.	AQH0213	AQH0223	AQH1213	AQH1223	AQH2213	AQH2223	AQH3213	AQH3223	
Output	Repetitive peak OFF-state voltage	600V							
	ON-state RMS current	0.3A	0.6A	0.9A					1.2A
	Non-repetitive surge current	3A	6A	9A					12A
	Peak ON-state voltage	Max. 2.5V							
	Peak OFF-state current	Max. 100µA							
	Trigger LED current	Max. 10mA							
Input	LED forward current	50mA							
	LED reverse voltage	6V							
	Peak forward current	1A							
	LED dropout voltage (I <sub>F</sub> =20mA)	Max. 1.3V							
Zero-cross voltage	Max. 50V	—	Max. 50V	—	Max. 50V	—	Max. 50V	—	
Turn on time	Max. 0.1ms								
I/O isolation voltage	5,000Vrms								
I/O capacitance, Typ.	2.1pF								
I/O isolation resistance	Min. 50GΩ								
Safety standards	UL/C-UL, VDE								
Mass (weight) (approx.)	0.56g								

# Solid State Relays Selector Chart

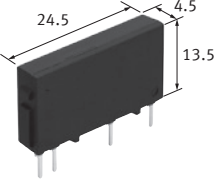
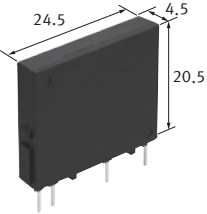
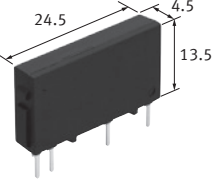
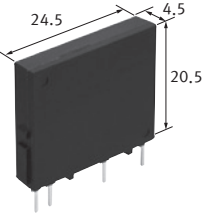
Product name		AQ-G Relays											
Type		Zero-cross						Random					
Number of terminals		4pin											
Type		1A			2A			1A			2A		
Appearance configuration *Standoff height included	mm												
		Slim type SSR for 1A and 2A control											
Part No.		AQG12105	AQG12112	AQG12124	AQG22105	AQG22112	AQG22124	AQG12205	AQG12212	AQG12224	AQG22205	AQG22212	AQG22224
Load side	Load voltage	AC 75 to 264V DC —											
	Max. load current	1A			2A			1A			2A		
	Off state leakage current, max.	1.5mA (applied 200V)											
	Non-repetitive surge current	8A			30A			8A			30A		
	Control voltage	4 to 6V	9.6 to 14.4V	19.2 to 28.8V	4 to 6V	9.6 to 14.4V	19.2 to 28.8V	4 to 6V	9.6 to 14.4V	19.2 to 28.8V	4 to 6V	9.6 to 14.4V	19.2 to 28.8V
Input side	Input impedance, approx.	0.3kΩ	0.8kΩ	1.6kΩ	0.3kΩ	0.8kΩ	1.6kΩ	0.3kΩ	0.8kΩ	1.6kΩ	0.3kΩ	0.8kΩ	1.6kΩ
	Pick-up voltage, max.	4V	9.6V	19.2V	4V	9.6V	19.2V	4V	9.6V	19.2V	4V	9.6V	19.2V
	Drop-out voltage, min.	1V											
Operate time, max.		1/2 cycle of voltage sine wave + 1ms						1ms					
Release time, max.		1/2 cycle of voltage sine wave + 1ms											
Breakdown voltage		3,000Vrms											
Snubber circuit integrated		•											
LED operation indicator		—											
Safety standards		UL/C-UL, VDE											
Mass (weight) (approx.)		2.7g			4.3g			2.7g			4.3g		

Product name		AQ1 Relays	
Type		Zero-cross*	
Number of terminals		4pin	
Type		3A	10A
Appearance configuration *Standoff height included			
mm			
Features		High capacity up to 10A PCB terminal type SSR	
Part No.		AQ1298	AQH1398
Load side	Load voltage	AC 75 to 250V	
		DC —	
	Max. load current	3A	(Heat sink/Panel heat) 10A
		20A	
		15A	
	10A		
	8A		
	5A		
	3A		
	2A		
	1A		
	Off state leakage current, max.	5mA	
	Non-repetitive surge current	80A	100A
Input side	Control voltage	4 to 32V DC	
	Input impedance, approx.	—	
	Pick-up voltage, max.	4 V	
	Drop-out voltage, min.	1.0V	
Operate time, max.	1/2 cycle of voltage sine wave + 1ms		
Release time, max.	1/2 cycle of voltage sine wave + 1ms		
Breakdown voltage	4,000 Vrms (between input and output) 2,500Vrms (between input, output and case)		
Snubber circuit integrated	•		
LED operation indicator	—		
Safety standards	UL/C-UL, VDE		
Mass (weight) (approx.)	19g	26g	

\*Random type is also available by custom order.

# Solid State Relays Selector Chart

Product name		AQ8 Relays											
Type		Zero-cross						Random					
Number of terminals		4pin											
Type		2A			3A			2A			3A		
Appearance configuration *Standoff height included	mm												
		SIL type SSR with 9mm thickness controls up to 3A											
Part No.	Input terminal distance: 5.08mm	AQ80139	AQ80133	AQ80134	AQ80159	AQ80153	AQ80154	AQ80239	AQ80233	AQ80234	AQ80259	AQ80253	AQ80254
	Input terminal distance: 7.62mm	AQ81139	AQ81133	AQ81134	AQ81159	AQ81153	AQ81154	AQ81239	AQ81233	AQ81234	AQ81259	AQ81253	AQ81254
Load side	Load voltage	AC 75 to 250V DC —											
	Max. load current	2A			3A			2A			3A		
	Off state leakage current, max.	5mA											
	Non-repetitive surge current	30A			80A			30A			80A		
Input side	Control voltage	4 to 6V	9.6 to 14.4V	21.6 to 26.4V	4 to 6V	9.6 to 14.4V	21.6 to 26.4V	4 to 6V	9.6 to 14.4V	21.6 to 26.4V	4 to 6V	9.6 to 14.4V	21.6 to 26.4V
	Input impedance, approx.	0.18kΩ	0.55kΩ	1.4kΩ	0.18kΩ	0.55kΩ	1.4kΩ	0.3kΩ	0.8kΩ	1.8kΩ	0.3kΩ	0.8kΩ	1.8kΩ
	Pick-up voltage, max.	4 V	9.6V	21.6V	4 V	9.6V	21.6V	4 V	9.6V	21.6V	4 V	9.6V	21.6V
	Drop-out voltage, min.	0.5V	1.2V	2.4V	0.5V	1.2V	2.4V	0.5V	1.2V	2.4V	0.5V	1.2V	2.4V
Operate time, max.	1/2 cycle of voltage sine wave + 1ms						1ms						
Release time, max.	1/2 cycle of voltage sine wave + 1ms												
Breakdown voltage	3,000Vrms												
Snubber circuit integrated	•												
LED operation indicator	—												
Safety standards	UL, CSA, TÜV*												
Mass (weight) (approx.)	6.8g			9.8g			6.8g			9.8g			

\*Normal part number is taken UL, CSA standards. About TÜV standard, please contact our sales office.

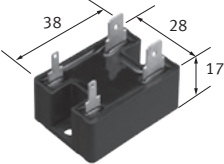

Product name		AQ-J Relays								
Type		Zero-cross <sup>*1</sup>								
Number of terminals		4								
Type		10A		15A				25A		
Appearance configuration <small>*Standoff height included</small>								Input terminal: #110 type Output terminal: #250 type		
mm										
Features		Load current 10 to 25A Small Tab Terminal SSR								
Part No.		AQJ112V	AQJ119V	AQJ116V	AQJ212V	AQJ219V	AQJ216V	AQJ412V	AQJ419V	AQJ416V
Load side	Load voltage	AC	75 to 264V							
		DC	—							
	Max. load current	40A						*4 (Heat sink) 25A		
		25A								
		20A								
15A		*2 (Heat sink/Panel heat) 10A		*3 (Heat sink/Panel heat) 15A						
10A										
5A										
2A										
1A										
Off state leakage current, max.	5mA									
Non-repetitive surge current	100A			150A			250A			
Input side	Control voltage	4 to 6V	10 to 18V	18 to 28V	4 to 6V	10 to 18V	18 to 28V	4 to 6V	10 to 18V	18 to 28V
	Input impedance, approx.	0.26kΩ	0.8kΩ	1.6kΩ	0.26kΩ	0.8kΩ	1.6kΩ	0.26kΩ	0.8kΩ	1.6kΩ
	Pick-up voltage, max.	4V	10V	18V	4V	10V	18V	4V	10V	18V
	Drop-out voltage, min.	1V								
Operate time, max.	1/2 cycle of voltage sine wave + 1ms									
Release time, max.	1/2 cycle of voltage sine wave + 1ms									
Breakdown voltage	3,000Vrms between input and output 2,500Vrms between input, output and case									
Snubber circuit integrated	•									
LED operation indicator	—									
Safety standards	UL/C-UL, TÜV									
Mass (weight) (approx.)	30g									

<sup>\*1</sup> Random type is available by custom order. <sup>\*2</sup> When mounting a standard heat sink (AQP-HS-J10A) or when mounting on 100 × 100 × t1.6 (mm) iron plate  
<sup>\*3</sup> When mounting a standard heat sink (AQP-HS-J10A) or when mounting on 200 × 200 × t2 (mm) iron plate <sup>\*4</sup> When mounting a standard heat sink (AQP-HS-J25A)

# Solid State Relays Selector Chart

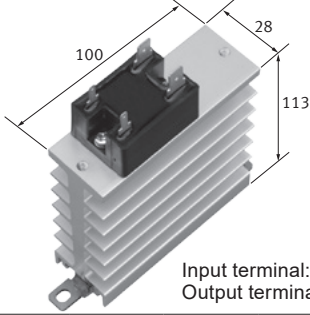
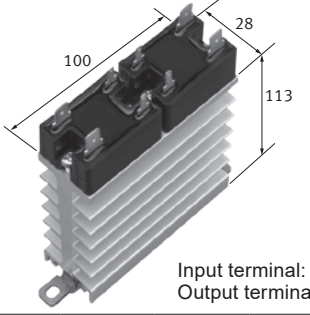
Product name		AQ-J Relays											
Type		Zero-cross*											
Number of terminals		4						4×2					
Type		10A (Output arrangement: 1a)			20A (Output arrangement: 1a)			10A (Output arrangement: 1a × 2)			15A (Output arrangement: 1a × 2)		
Appearance configuration *Standoff height included  mm													
Features		Load current 10 to 25A Small Tab Terminal SSR											
Part No.		AQJ112VY	AQJ119VY	AQJ116VY	AQJ412VY	AQJ419VY	AQJ416VY	AQJ112VW	AQJ119VW	AQJ116VW	AQJ412VW	AQJ419VW	AQJ416VW
Load side	Load voltage	AC 75 to 264V DC —											
	Max. load current	10A			20A			10A			15A		
	Off state leakage current, max.	5mA											
	Non-repetitive surge current	100A			250A			100A			250A		
	Control voltage	4 to 6V	10 to 18V	18 to 28V	4 to 6V	10 to 18V	18 to 28V	4 to 6V	10 to 18V	18 to 28V	4 to 6V	10 to 18V	18 to 28V
Input side	Input impedance, approx.	0.26kΩ	0.8kΩ	1.6kΩ	0.26kΩ	0.8kΩ	1.6kΩ	0.26kΩ	0.8kΩ	1.6kΩ	0.26kΩ	0.8kΩ	1.6kΩ
	Pick-up voltage, max.	4V	10V	18V	4V	10V	18V	4V	10V	18V	4V	10V	18V
	Drop-out voltage, min.	1V											
	Operate time, max.	1/2 cycle of voltage sine wave + 1ms											
Release time, max.	1/2 cycle of voltage sine wave + 1ms												
Breakdown voltage	3,000Vrms between input and output 2,500Vrms between input, output and case												
Snubber circuit integrated	•												
LED operation indicator	—												
Safety standards	—												
Mass (weight) (approx.)	250g						280g						

\*Random type is available by custom order.

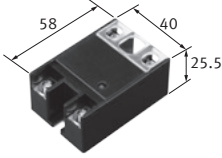
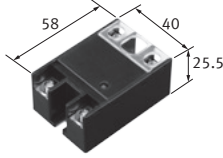
Product name		AQ-A Relays (AC output type)			AQ-A Relays (DC output type)	
Type		Zero-cross <sup>*1</sup>			—	
Number of terminals		4				
Type		15A	25A	40A	30A	10A
Appearance configuration <small>*Standoff height included</small>						
mm						
Features		Load current 15 to 40A Small Screw Terminal SSR				
Part No.		AQA211VL	AQA411VL	AQA611VL	AQA551DL	AQA171DL
Load side	Load voltage	AC 75 to 250V			DC —	
		DC —			100V	600V
	Max. load current	*2 (Heat sink) 15A	*3 (Heat sink) 25A	*4 (Heat sink) 40A	*5 (Heat sink) 30A	*6 (Heat sink) 10A
	Off state leakage current, max.	10mA			100µA	
	Non-repetitive surge current	150A	250A	400A	—	
	Peak load current	—	—	—	90A (100ms)	20A (100ms)
	Control voltage	4 to 32V				
Input side	Input impedance, approx.	—				
	Pick-up voltage, max.	4V				
	Drop-out voltage, min.	1V				
	Operate time, max.	1/2 cycle of voltage sine wave + 1ms			10ms	5ms
Release time, max.	1/2 cycle of voltage sine wave + 1ms			3ms	1ms	
Breakdown voltage	4,000 Vrms between input and output/2,500Vrms between input, output and case					
Snubber circuit integrated	•			—		
Reverse connection prevention diode	—			•		
LED operation indicator	•					
Safety standards	UL/C-UL, VDE			UL/C-UL, VDE		
Mass (weight) (approx.)	70g					

\*1 Random type is available by custom order. \*2 When mounting a standard heat sink (AQP-HS-J10A or AQP-HS-SJ20A) \*3 When mounting a standard heat sink (AQP-HS-30/40A) \*4 When mounting a standard heat sink (AQP-HS-J25A) \*5 When mounting a standard heat sink (AQP-HS-J25A) \*6 When mounting a standard heat sink (AQP-HS-SJ20A)

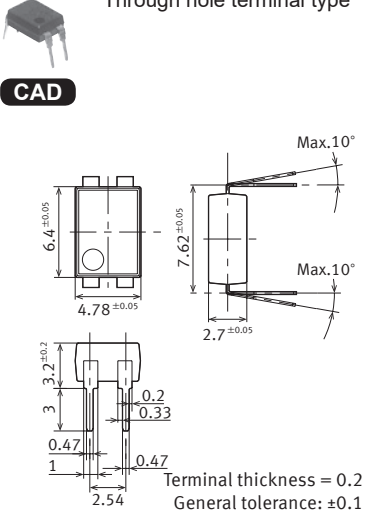
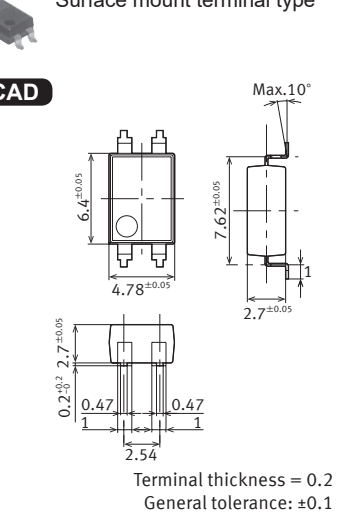
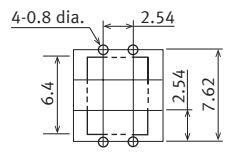
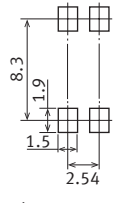
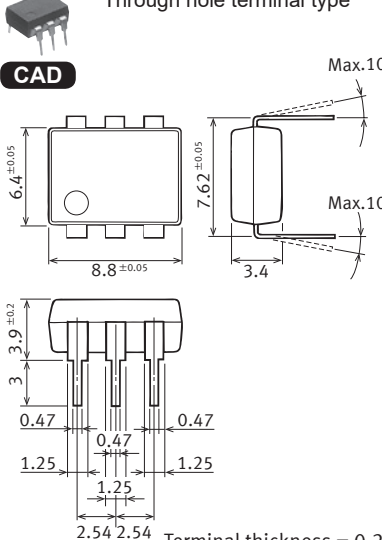
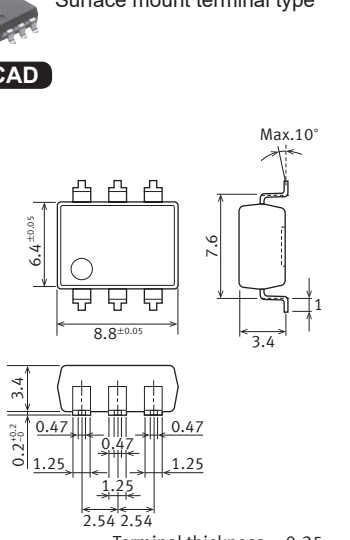
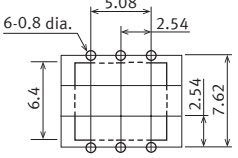
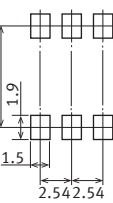
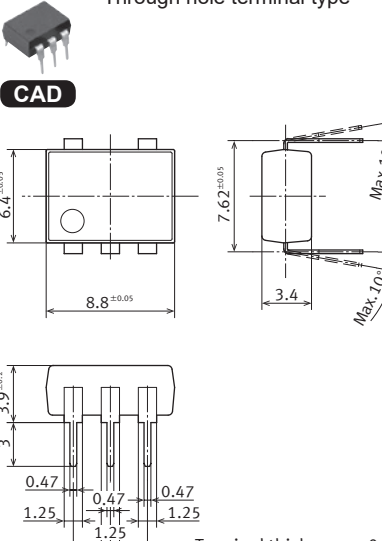
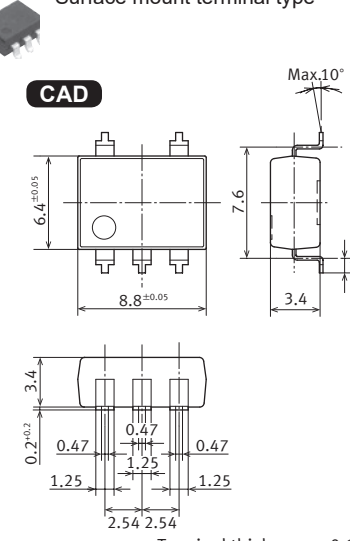
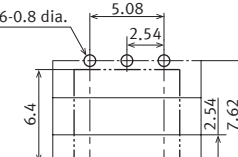
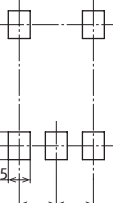

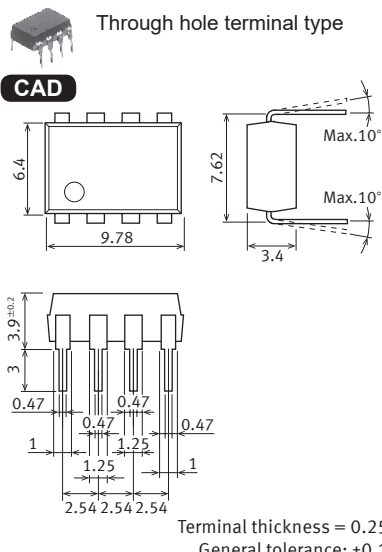
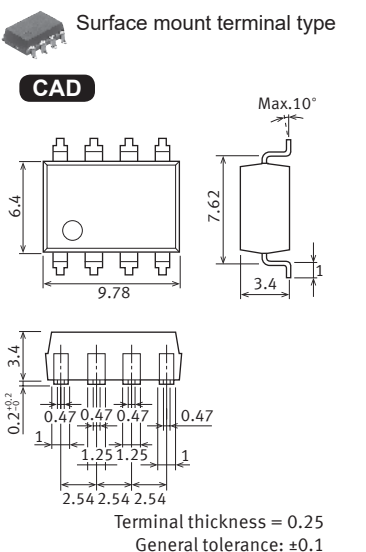
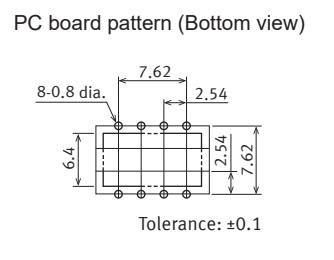
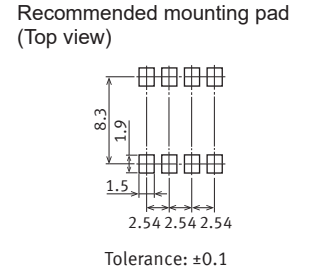
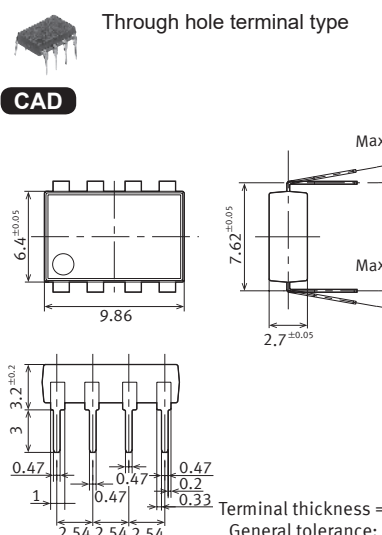
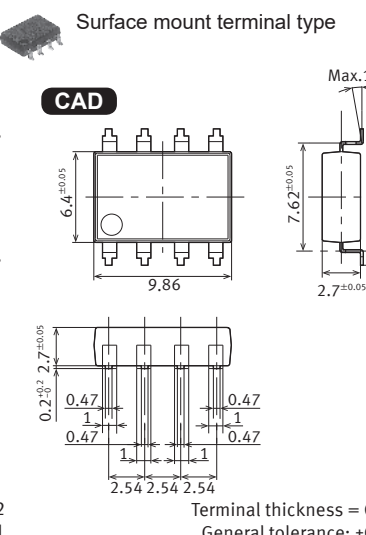
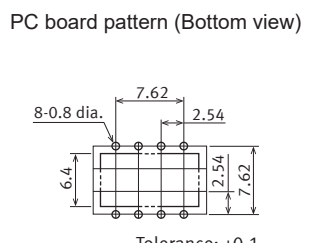
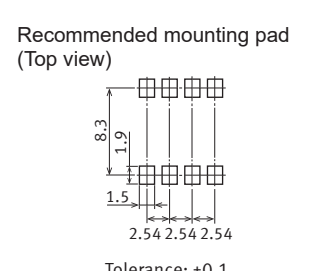
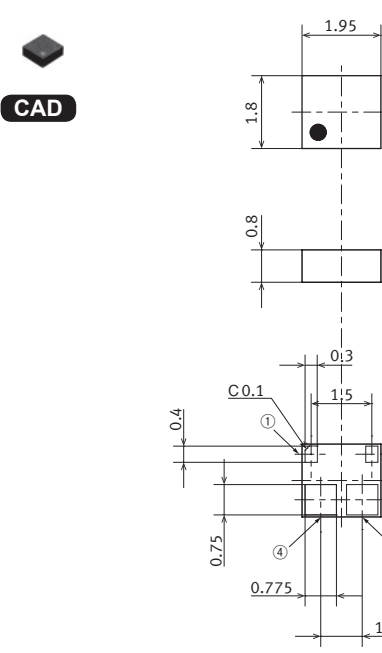
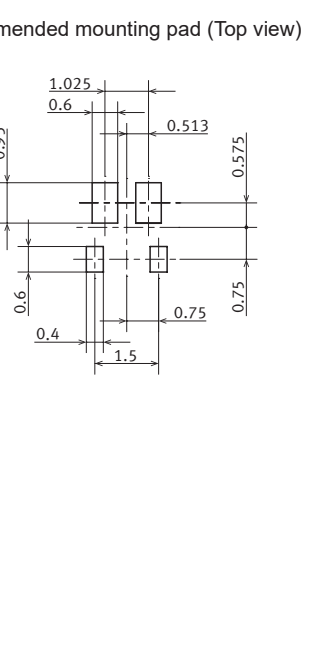

Type	Dimensions (mm)		
<p>AQY21 (DIP) AQY41 (DIP) Series</p>	<p>Through hole terminal type</p>  <p>Terminal thickness = 0.2 General tolerance: ±0.1</p>	<p>Surface mount terminal type</p>  <p>Terminal thickness = 0.2 General tolerance: ±0.1</p>	<p>PC board pattern (Bottom view)</p>  <p>Tolerance: ±0.1</p> <p>Recommended mounting pad (Top view)</p>  <p>Tolerance: ±0.1</p>
<p>AQV10 (DIP) AQV11 (DIP) AQV20 (DIP) AQV21 (DIP) AQV22 (DIP) AQV23 (DIP) AQV25 (DIP) AQV41 (DIP) AQV45 (DIP) Series</p>	<p>Through hole terminal type</p>  <p>Terminal thickness = 0.25 General tolerance: ±0.1</p>	<p>Surface mount terminal type</p>  <p>Terminal thickness = 0.25 General tolerance: ±0.1</p>	<p>PC board pattern (Bottom view)</p>  <p>Tolerance: ±0.1</p> <p>Recommended mounting pad (Top view)</p>  <p>Tolerance: ±0.1</p>
<p>AQV1122 (DIP)</p>	<p>Through hole terminal type</p>  <p>Terminal thickness = 0.25 General tolerance: ±0.1</p>	<p>Surface mount terminal type</p>  <p>Terminal thickness = 0.25 General tolerance: ±0.1</p>	<p>PC board pattern (Bottom view)</p>  <p>Tolerance: ±0.1</p> <p>Recommended mounting pad (Top view)</p>  <p>Tolerance: ±0.1</p>

**CAD** The CAD data of the products with a "CAD" mark can be downloaded from our Website.







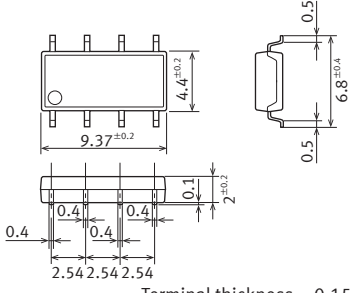
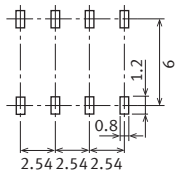

Type	Dimensions (mm)		
<p>AQW21 (DIP) AQW22 (DIP) AQW25 (DIP) AQW41 (DIP) AQW45 (DIP) AQW61 (DIP) AQW65 (DIP) Series</p>	<p>Through hole terminal type</p>  <p>CAD</p> <p>Terminal thickness = 0.25 General tolerance: ±0.1</p>	<p>Surface mount terminal type</p>  <p>CAD</p> <p>Terminal thickness = 0.25 General tolerance: ±0.1</p>	<p>PC board pattern (Bottom view)</p>  <p>Tolerance: ±0.1</p> <p>Recommended mounting pad (Top view)</p>  <p>Tolerance: ±0.1</p>
<p>AQW21*EH (DIP) AQW21*HL (DIP) AQW41*EH (DIP) AQW61*EH (DIP) Series</p>	<p>Through hole terminal type</p>  <p>CAD</p> <p>Terminal thickness = 0.2 General tolerance: ±0.1</p>	<p>Surface mount terminal type</p>  <p>CAD</p> <p>Terminal thickness = 0.2 General tolerance: ±0.1</p>	<p>PC board pattern (Bottom view)</p>  <p>Tolerance: ±0.1</p> <p>Recommended mounting pad (Top view)</p>  <p>Tolerance: ±0.1</p>
<p>AQY2C (TSON) Series</p>	 <p>CAD</p> <p>General tolerance: ±0.2</p>		<p>Recommended mounting pad (Top view)</p> 

\*Stand for one digit.

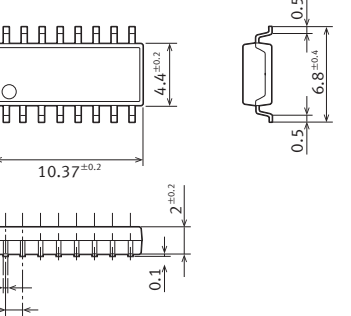
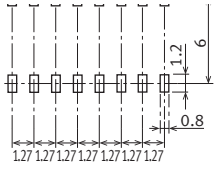

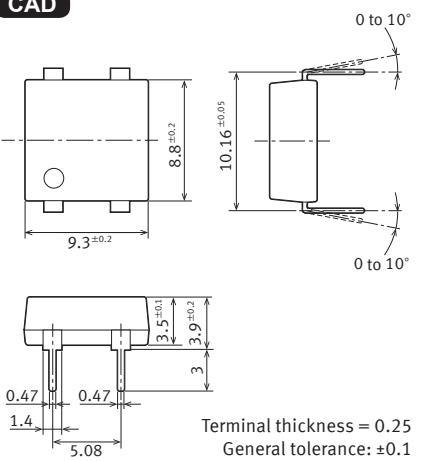
**CAD** The CAD data of the products with a "CAD" mark can be downloaded from our Website.

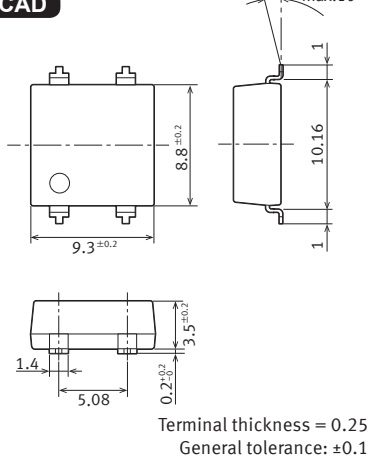
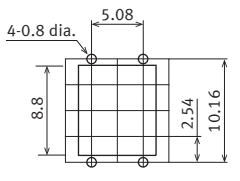
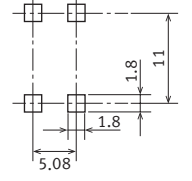
Type	Dimensions (mm)		
<p><b>AQY22 (VSSOP) Series</b></p>		<p>① Input: DC+ ② Input: DC- ③ Output: AC/DC ④ Output: AC/DC</p> <p>General tolerance: <math>\pm 0.1</math></p>	<p>Recommended mounting pad (Top view)</p> <p>Tolerance: <math>\pm 0.1</math></p>
<p><b>AQY22 (SON) Series</b></p>		<p>① Input: DC+ ② Input: DC- ③ Output: AC/DC ④ Output: AC/DC</p> <p>General tolerance: <math>\pm 0.2</math></p>	<p>Recommended mounting pad (Top view)</p> <p>Tolerance: <math>\pm 0.1</math></p>
<p><b>APV21 (SSOP) AQY22 (SSOP) Series</b></p>		<p>Terminal thickness = 0.15 General tolerance: <math>\pm 0.1</math></p>	<p>Recommended mounting pad (Top view)</p> <p>Tolerance: <math>\pm 0.1</math></p>
<p><b>APV11 (SOP) APV21 (SOP) AQY21 (SOP) AQY22 (SOP) AQY23 (SOP) AQY41 (SOP) Series</b></p>		<p>Terminal thickness = 0.15 General tolerance: <math>\pm 0.1</math></p>	<p>Recommended mounting pad (Top view)</p> <p>Tolerance: <math>\pm 0.1</math></p>
<p><b>AQV21 (SOP) AQV22 (SOP) AQV25 (SOP) AQV41 (SOP) Series</b></p>		<p>Terminal thickness = 0.15 General tolerance: <math>\pm 0.1</math></p>	<p>Recommended mounting pad (Top view)</p> <p>Tolerance: <math>\pm 0.1</math></p>

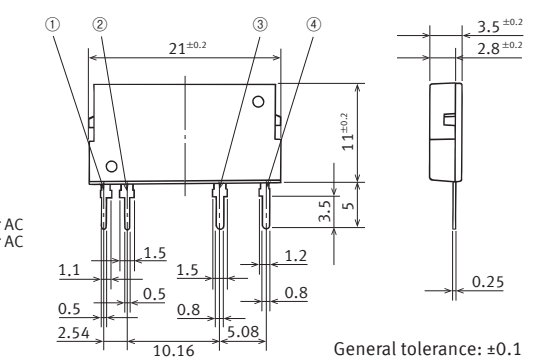
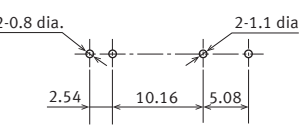
**CAD** The CAD data of the products with a "CAD" mark can be downloaded from our Website.

Type	Dimensions (mm)		
<p>AQW21 (SOP) AQW22 (SOP) AQW41 (SOP) AQW61 (SOP) Series</p>	 <p><b>CAD</b></p>	 <p>Terminal thickness = 0.15 General tolerance: ±0.1</p>	<p>Recommended mounting pad (Top view)</p>  <p>Tolerance: ±0.1</p>
<p>AQS22 (SOP) Series</p>	 <p><b>CAD</b></p>	 <p>Terminal thickness = 0.15 General tolerance: ±0.1</p>	<p>Recommended mounting pad (Top view)</p>  <p>Tolerance: ±0.1</p>
<p>AQY27 (Power-DIP) Series</p>	<p>Through hole terminal type</p>  <p><b>CAD</b></p>  <p>Terminal thickness = 0.25 General tolerance: ±0.1</p>	<p>Surface mount terminal type</p>  <p><b>CAD</b></p>  <p>Terminal thickness = 0.25 General tolerance: ±0.1</p>	<p>PC board pattern (Bottom view)</p>  <p>Tolerance: ±0.1</p> <p>Recommended mounting pad (Top view)</p>  <p>Tolerance: ±0.1</p>
<p>AQZ10 (SIL) AQZ20 (SIL) AQZ40 (SIL) Series</p>	 <p><b>CAD</b></p>	 <p>General tolerance: ±0.1</p>	<p>PC board pattern (Bottom view)</p>  <p>Tolerance: ±0.1</p>

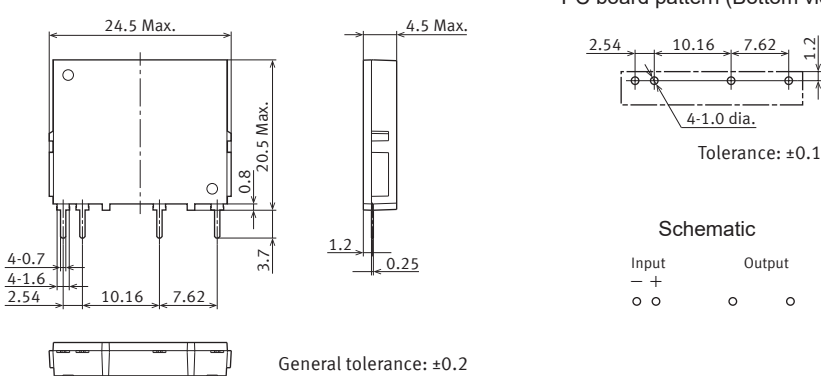

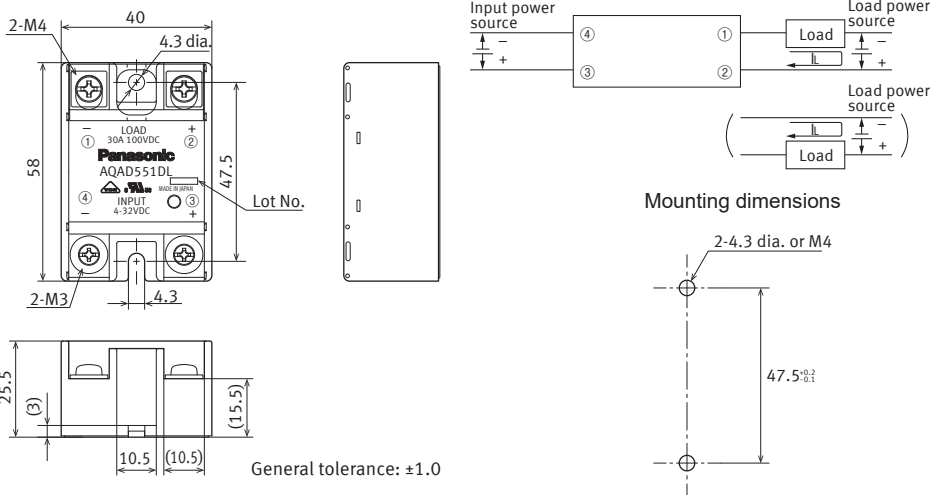
**CAD** The CAD data of the products with a "CAD" mark can be downloaded from our Website.

Type	Dimensions (mm)	
<p><b>AQY19 (SIL) Series</b></p>  <p><b>CAD</b></p>	 <p>PC board pattern (Bottom view)</p> <p>Tolerance: ±0.1</p> <p>Schematic</p> <p>Input: - +      Output: o o</p> <p>General tolerance: ±0.2</p>	
<p><b>AQAD Series</b></p>  <p><b>CAD</b></p>	 <p>Schematic</p> <p>Input power source: 4, 3      Load power source: 1, 2</p> <p>Mounting dimensions</p> <p>2-4.3 dia. or M4</p> <p>47.5</p> <p>General tolerance: ±1.0</p>	

**CAD** The CAD data of the products with a "CAD" mark can be downloaded from our Website.



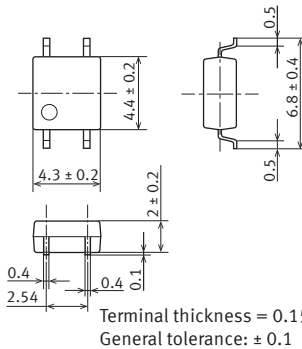
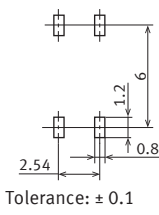

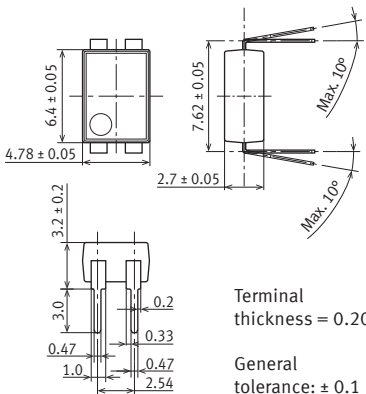
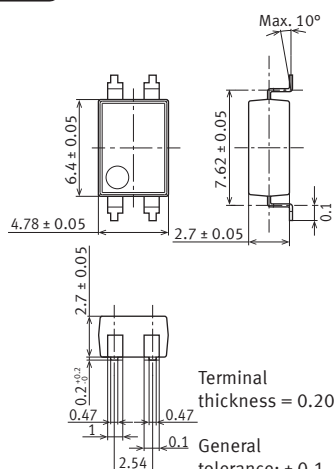
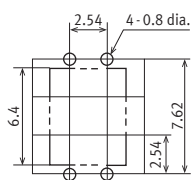
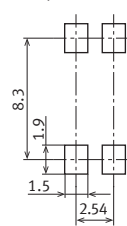

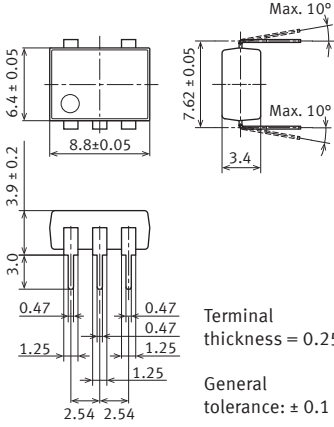

# Phototriac Coupler Dimensions

Type	Dimensions (mm)		
<p>  <b>CAD</b>            APT1211S (SOP)            APT1221S (SOP)            APT1231S (SOP)            Series         </p>	<p style="text-align: right;">Recommended mounting pad (TOP VIEW)</p>  		
<p>  <b>CAD</b>            APT1211 (A)            (DIP4)            APT1221 (A)            (DIP4)            APT1231 (A)            (DIP4)            Series         </p>	<p>Through hole terminal type</p>  <p>Terminal thickness = 0.20 General tolerance: ± 0.1</p>	<p>Surface mount terminal type</p>  <p>Terminal thickness = 0.20 General tolerance: ± 0.1</p>	<p>PC board pattern (Bottom view)</p>  <p>Tolerance: ± 0.1</p> <p>Recommended mounting pad (Top view)</p>  <p>Tolerance: ± 0.1</p>

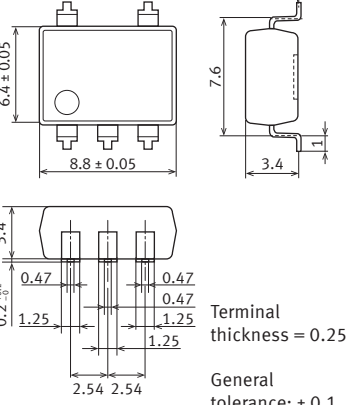
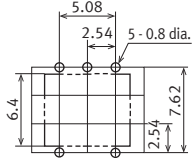
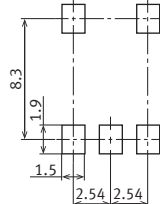
**CAD** The CAD data of the products with a "CAD" mark can be downloaded from our Website.

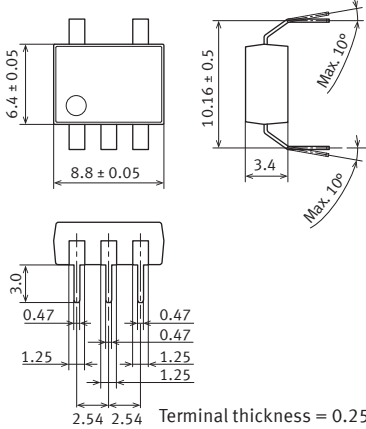
# Phototriac Coupler Dimensions

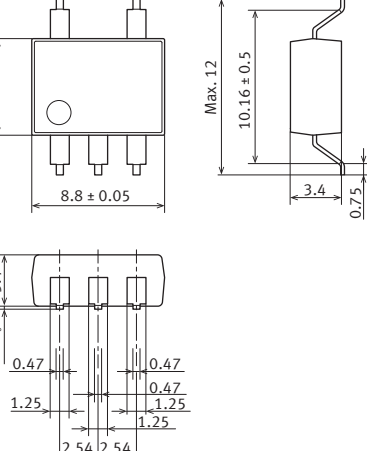
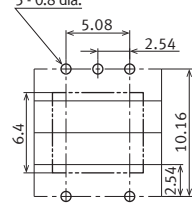
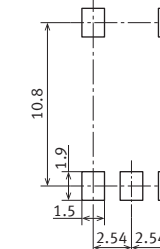
Type	Dimensions (mm)		
<p>APT1212 (A) (DIP6) APT1222 (A) (DIP6) APT1232 (A) (DIP6) Series</p>	<p>Through hole terminal type</p>  <p><b>CAD</b></p>  <p>Terminal thickness = 0.25 General tolerance: ± 0.1</p>	<p>Surface mount terminal type</p>  <p><b>CAD</b></p>  <p>Terminal thickness = 0.25 General tolerance: ± 0.1</p>	<p>PC board pattern (Bottom view)</p>  <p>Tolerance: ± 0.1</p> <p>Recommended mounting pad (Top view)</p>  <p>Tolerance: ± 0.1</p>
<p>APT1212W (A) (DIP6WIDE) APT1222W (A) (DIP6WIDE) APT1232W (A) (DIP6WIDE) Series</p>	<p>Through hole terminal type</p>  <p><b>CAD</b></p>  <p>Terminal thickness = 0.25 General tolerance: ± 0.1</p>	<p>Surface mount terminal type</p>  <p><b>CAD</b></p>  <p>Terminal thickness = 0.25 General tolerance: ± 0.1</p>	<p>PC board pattern (Bottom view)</p>  <p>Tolerance: ± 0.1</p> <p>Recommended mounting pad (Top view)</p>  <p>Tolerance: ± 0.1</p>

**CAD** The CAD data of the products with a "CAD" mark can be downloaded from our Website.



North America

Europe

Asia Pacific

China

Japan

## Panasonic Electric Works

Please contact our Global Sales Companies in:

Europe		
▶ <b>Headquarters</b>	<b>Panasonic Electric Works Europe AG</b>	Caroline-Herschel-Strasse 100, 85521 Ottobrunn, Tel. +49 89 45354-1000, Fax +49 89 45354-1550, <a href="http://www.panasonic-electric-works.com">www.panasonic-electric-works.com</a>
▶ <b>Austria</b>	<b>Panasonic Industry Austria GmbH</b>	Josef Madersperger Str. 2, 2362 Biedermannsdorf, Tel. +43 (0) 2236-26846, Fax +43 (0) 2236-46133 <a href="http://www.panasonic-electric-works.at">www.panasonic-electric-works.at</a>
	<b>Panasonic Industrial Devices Materials Europe GmbH</b>	Ennschafenstrasse 30, 4470 Enns, Tel. +43 (0) 7223 883, Fax +43 (0) 7223 88333, <a href="http://www.panasonic-electronic-materials.com">www.panasonic-electronic-materials.com</a>
▶ <b>Benelux</b>	<b>Panasonic Electric Works Sales Western Europe B.V.</b>	De Rijn 4, 5684 PJ Best, Netherlands, Tel. +31 (0) 499 372727, <a href="http://www.panasonic-electric-works.nl">www.panasonic-electric-works.nl</a>
▶ <b>Czech Republic</b>	<b>Panasonic Electric Works Europe AG,</b> organizační složka	Administrative centre PLATINIUM, Veverí 3163/111, 616 00 Brno, Tel. +420 541 217 001, Fax +420 541 217 101, <a href="http://www.panasonic-electric-works.cz">www.panasonic-electric-works.cz</a>
▶ <b>France</b>	<b>Panasonic Electric Works Sales Western Europe B.V.</b>	Succursale française, 10, rue des petits ruisseaux, 91370 Verrières Le Buisson, Tél. +33 (0) 1 6013 5757, Fax +33 (0) 1 6013 5758, <a href="http://www.panasonic-electric-works.fr">www.panasonic-electric-works.fr</a>
▶ <b>Germany</b>	<b>Panasonic Electric Works Europe AG</b>	Caroline-Herschel-Strasse 100, 85521 Ottobrunn, Tel. +49 89 45354-1000, Fax +49 89 45354-2111, <a href="http://www.panasonic-electric-works.de">www.panasonic-electric-works.de</a>
▶ <b>Hungary</b>	<b>Panasonic Electric Works Europe AG</b>	Magyarországi Fióktelepe, 1117 Budapest, Alíz utca 4, Tel. +43 (0) 2236 26846 -25, Fax +43 (0) 2236 46133 <a href="http://www.panasonic-electric-works.hu">www.panasonic-electric-works.hu</a>
▶ <b>Ireland</b>	<b>Panasonic Electric Works UK Ltd.</b>	Irish Branch Office, Dublin, Tel. +353 (0) 14600969, Fax +353 (0) 14601131, <a href="http://www.panasonic-electric-works.co.uk">www.panasonic-electric-works.co.uk</a>
▶ <b>Italy</b>	<b>Panasonic Industry Italia srl</b>	Via del Commercio 3-5 (Z.I. Ferlina), 37012 Bussolengo (VR), Tel. +39 0456752711, Fax +39 0456700444, <a href="http://www.panasonic-electric-works.it">www.panasonic-electric-works.it</a>
▶ <b>Nordic Countries</b>	<b>Panasonic Electric Works Europe AG</b>	Filial Nordic, Knarrarnäsgatan 15, 164 40 Kista, Sweden, Tel. +46 859476680, Fax +46 859476690, <a href="http://www.panasonic-electric-works.se">www.panasonic-electric-works.se</a>
	<b>Panasonic Fire &amp; Security Europe AB</b>	Jungmansgatan 12, 21119 Malmö, Tel. +46 40 697 7000, Fax +46 40 697 7099, <a href="http://www.panasonic-fire-security.com">www.panasonic-fire-security.com</a>
▶ <b>Poland</b>	<b>Panasonic Industry Poland sp. z o.o.</b>	Ul. Dowborczyków 25, 90-019 Łódź, Polska, Tel. +48 42 2309633, <a href="http://www.panasonic-electric-works.pl">www.panasonic-electric-works.pl</a>
▶ <b>Spain</b>	<b>Panasonic Industry Iberia S.A.</b>	Barajas Park, San Severo 20, 28042 Madrid, Tel. +34 913293875, Fax +34 913292976, <a href="http://www.panasonic-electric-works.es">www.panasonic-electric-works.es</a>
▶ <b>Switzerland</b>	<b>Panasonic Industry Switzerland AG</b>	Grundstrasse 8, 6343 Rotkreuz, Tel. +41 (0) 41 7997050, Fax +41 (0) 41 7997055, <a href="http://www.panasonic-electric-works.ch">www.panasonic-electric-works.ch</a>
▶ <b>United Kingdom</b>	<b>Panasonic Electric Works UK Ltd.</b>	Sunrise Parkway, Linford Wood, Milton Keynes, MK14 6LF, Tel. +44 (0) 1908 231555, Fax +44 (0) 1908 231599, <a href="http://www.panasonic-electric-works.co.uk">www.panasonic-electric-works.co.uk</a>
North & South America		
▶ <b>USA</b>	<b>Panasonic Industrial Devices Sales Company of America</b>	Two Riverfront Plaza, 7th Floor, Newark, NJ 07102-5490, Tel. 1-8003-442-112, <a href="http://www.pewa.panasonic.com">www.pewa.panasonic.com</a>
Asia Pacific / China / Japan		
▶ <b>China</b>	<b>Panasonic Electric Works Sales (China) Co. Ltd.</b>	Tower C 3rd Floor, Office Park, NO.5 Jinghua South Street, Chaoyang District, Beijing 100020, Tel. +86-10-5925-5988, Fax +86-10-5925-5980
▶ <b>Hong Kong</b>	<b>Panasonic Industrial Devices Sales (HK) Co., Ltd.</b>	Suite 301, 3/F, Chinachem Golden Plaza, 77 Mody Road, TST East, Kowloon, Hong Kong, Tel. +852-2529-3956, Fax +852-2528-6991
▶ <b>Japan</b>	<b>Panasonic Corporation</b>	1006, Oaza Kadoma, Kadoma-shi, Osaka 571-8501, Japan, Tel. +81-6-6908-1121, <a href="http://www.panasonic.net">www.panasonic.net</a>
▶ <b>Singapore</b>	<b>Panasonic Industrial Devices Automation Controls Sales Asia Pacific</b>	No.3 Bedok South Road, Singapore 469269, Tel. +65-6299-9181, Fax +65-6390-3953